

EXPLODED DRAWING A

Model No. SFTL81213.2 R1114A

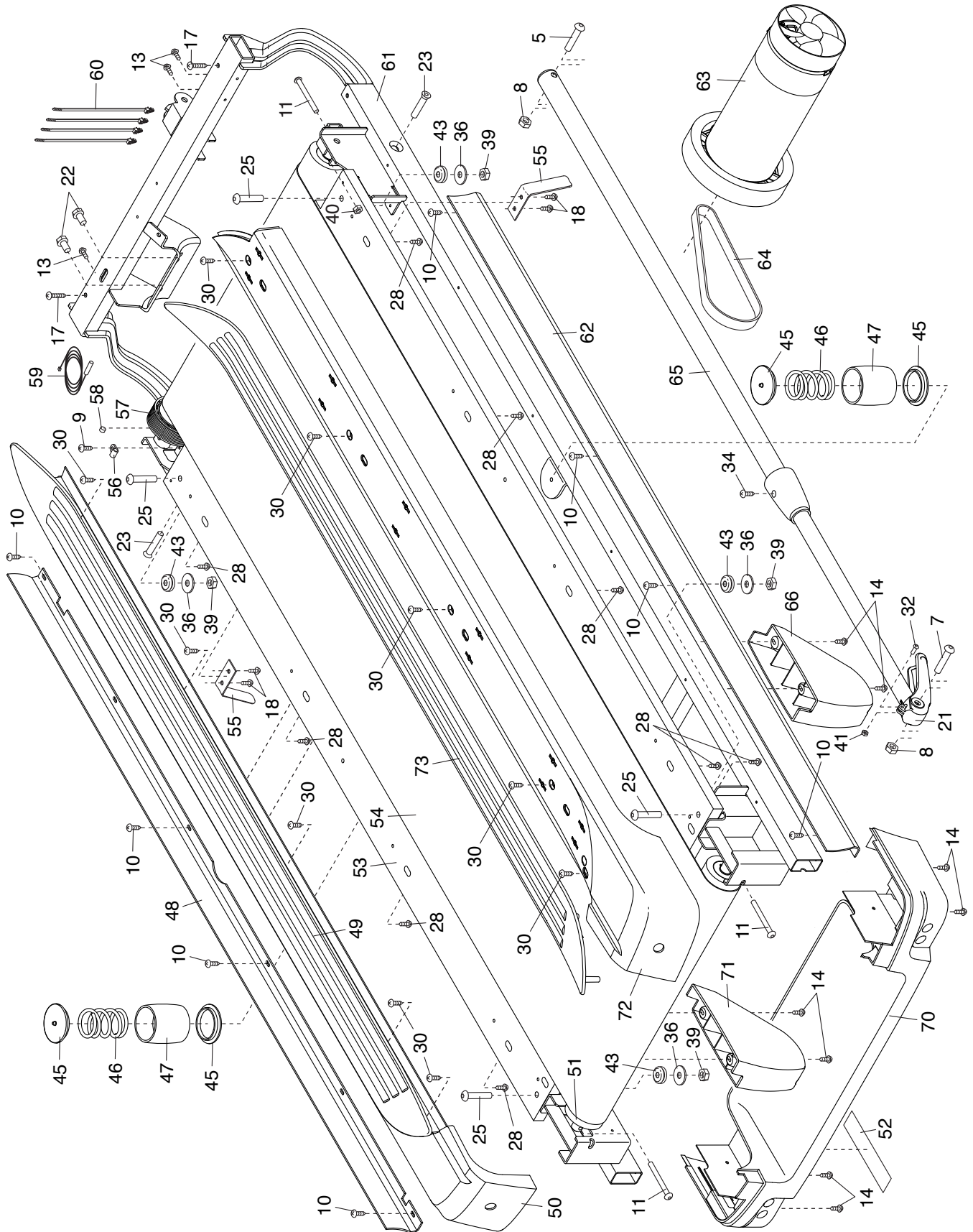

EXPLODED DRAWING B

Model No. SFTL81213.2 R1114A

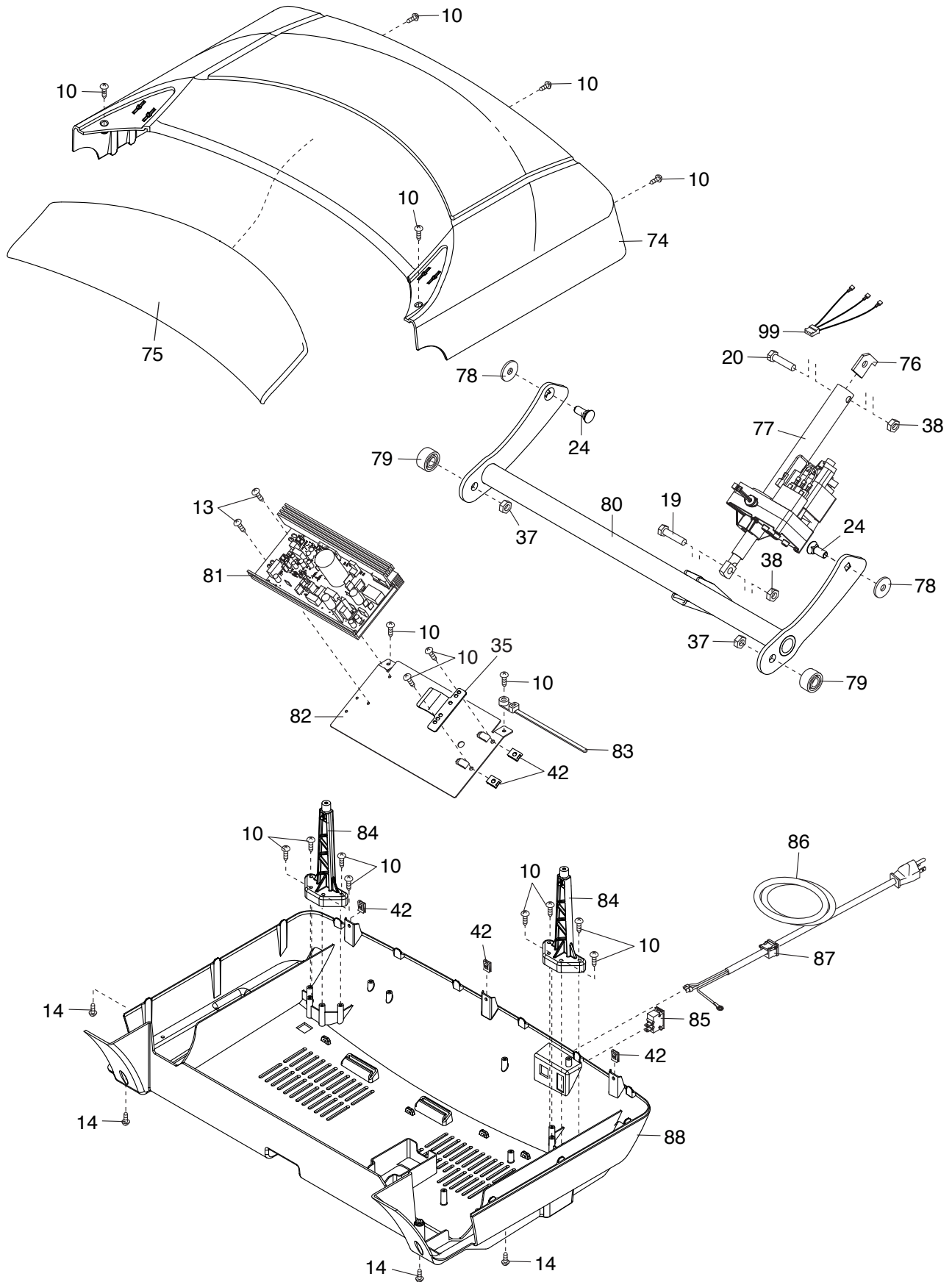

EXPLODED DRAWING C

Model No. SFTL81213.2 R1114A

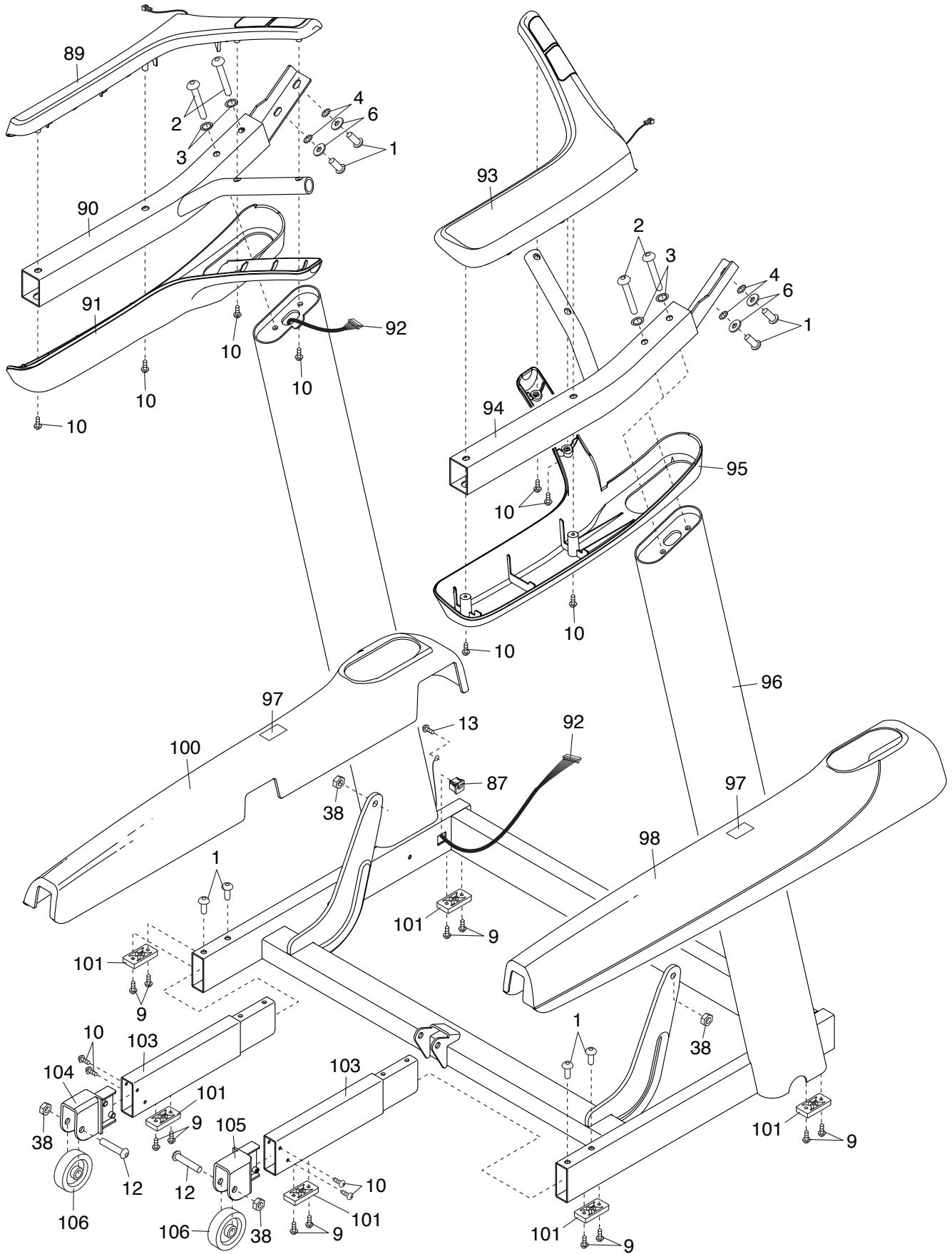

EXPLODED DRAWING D

Model No. SFTL81213.2 R1114A

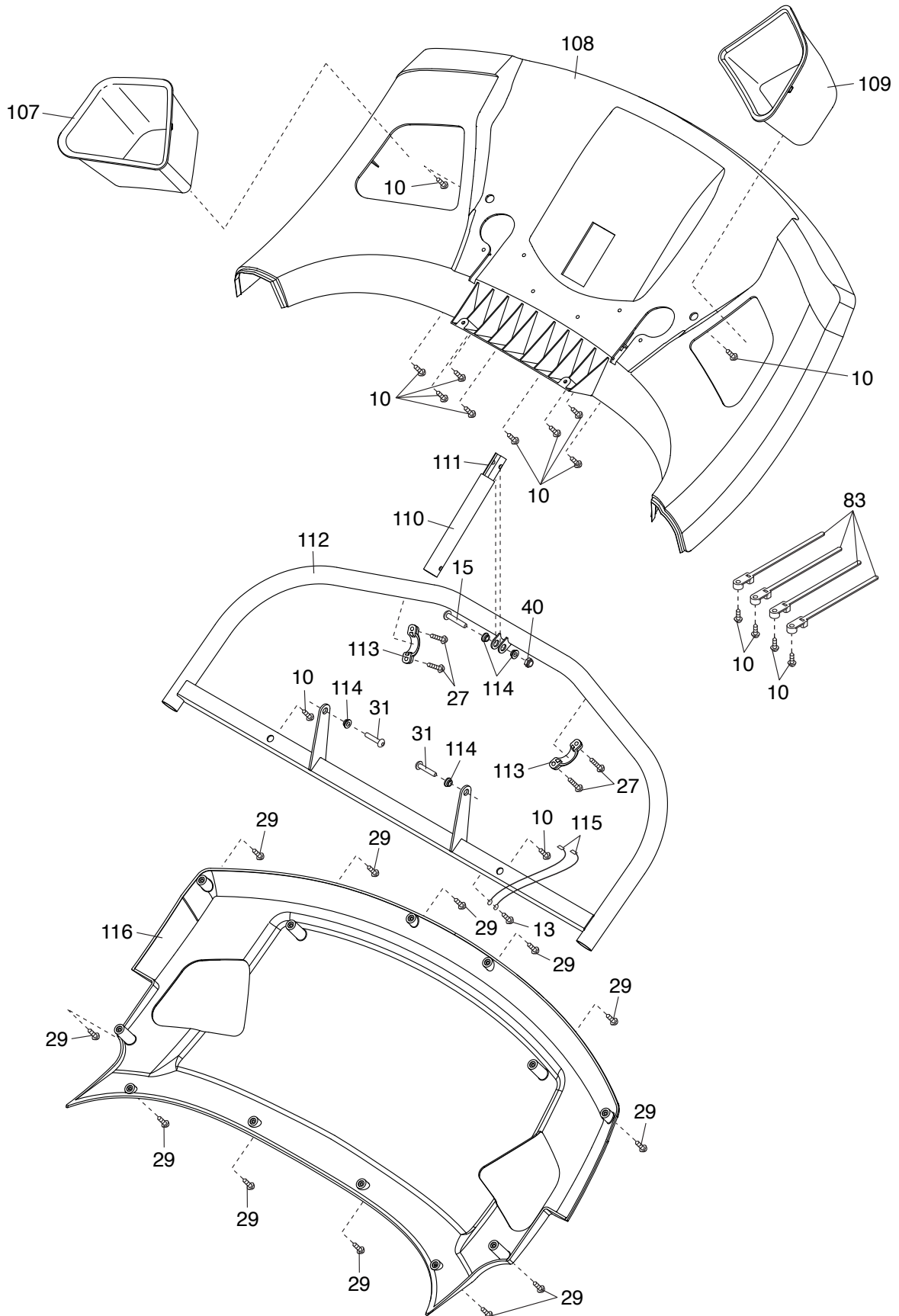

EXPLODED DRAWING E

Model No. SFTL81213.2 R1114A

