

SCHÉMA DÉTAILLÉ A

R0409A



SCHÉMA DÉTAILLÉ B

R0409A

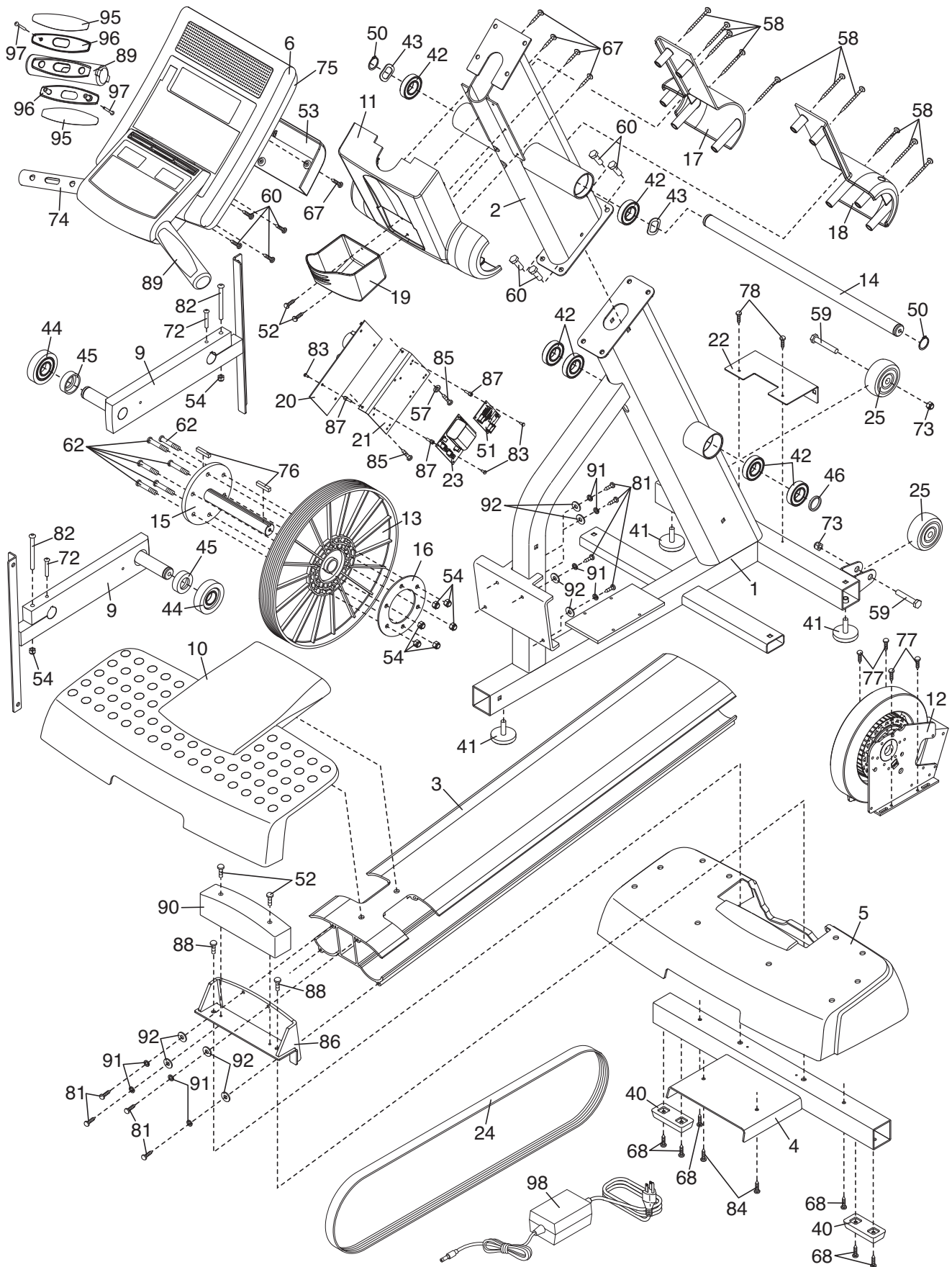

SCHÉMA DÉTAILLÉ C

R0409A

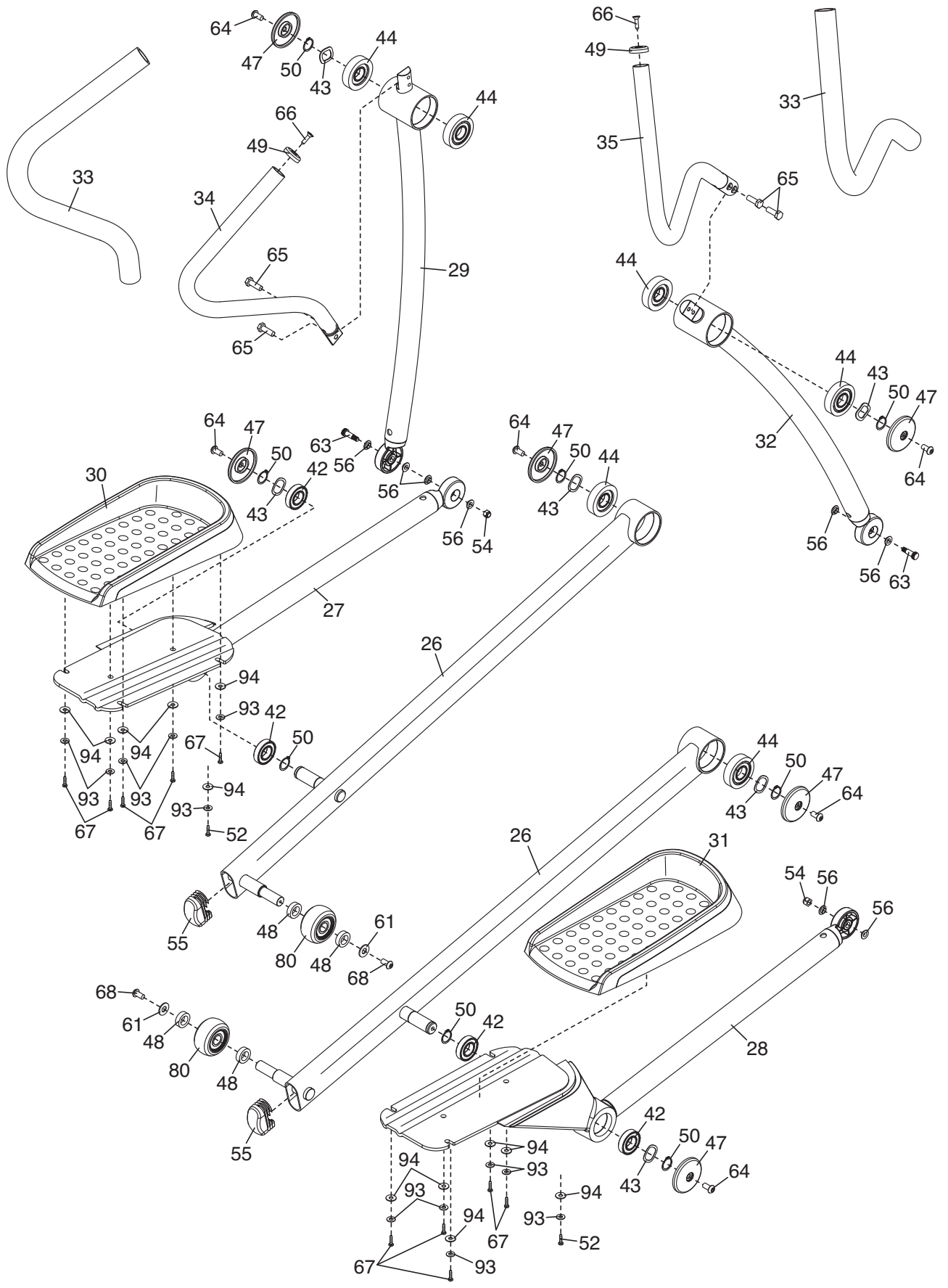