

EXPLODED DRAWING A

Model No. VMEL81914.0 R0415A

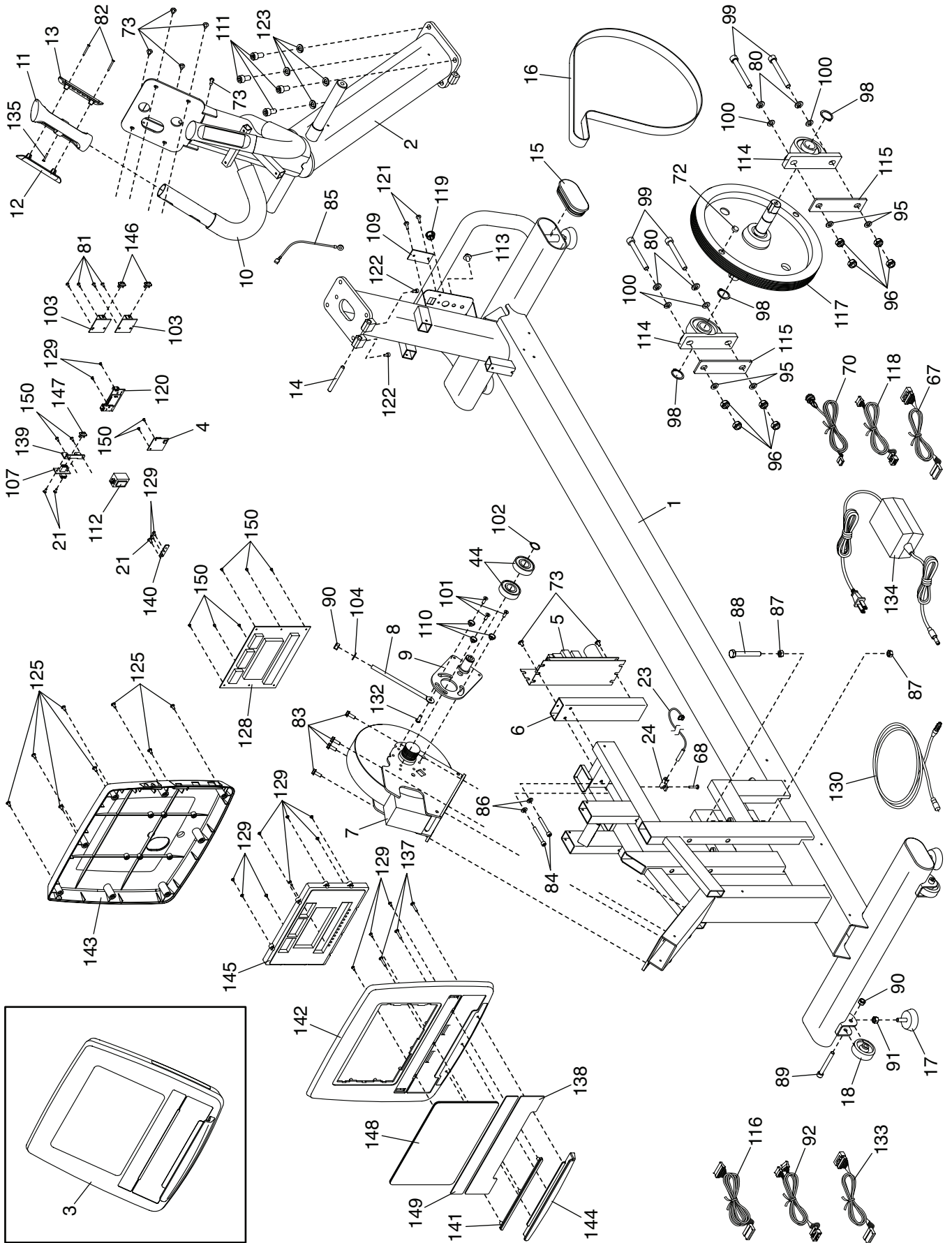

EXPLODED DRAWING B

Model No. VMEL81914.0 R0415A

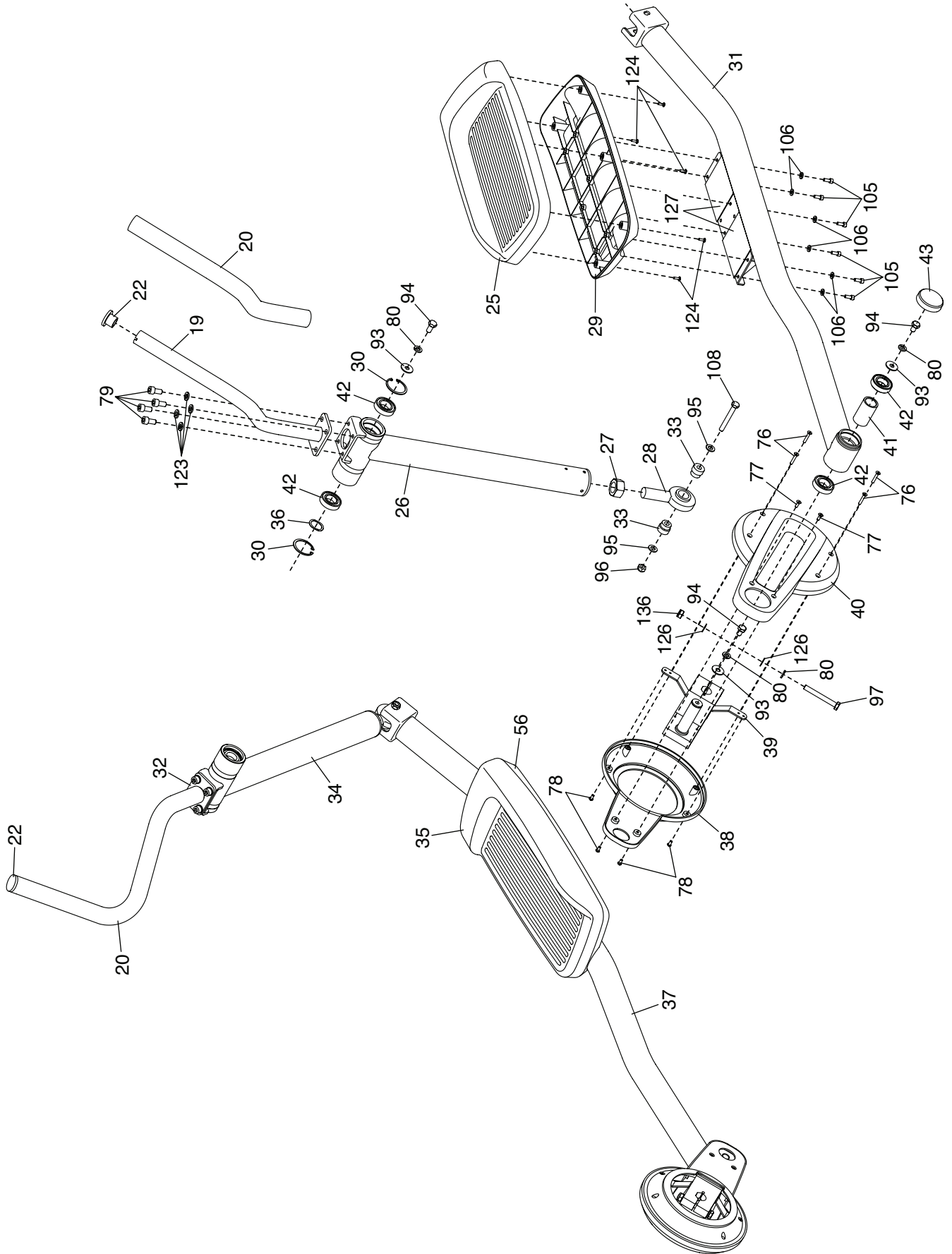

EXPLODED DRAWING C

Model No. VMEL81914.0 R0415A

