

EXPLODED DRAWING A

Model No. VMTL39811.0 R0112A

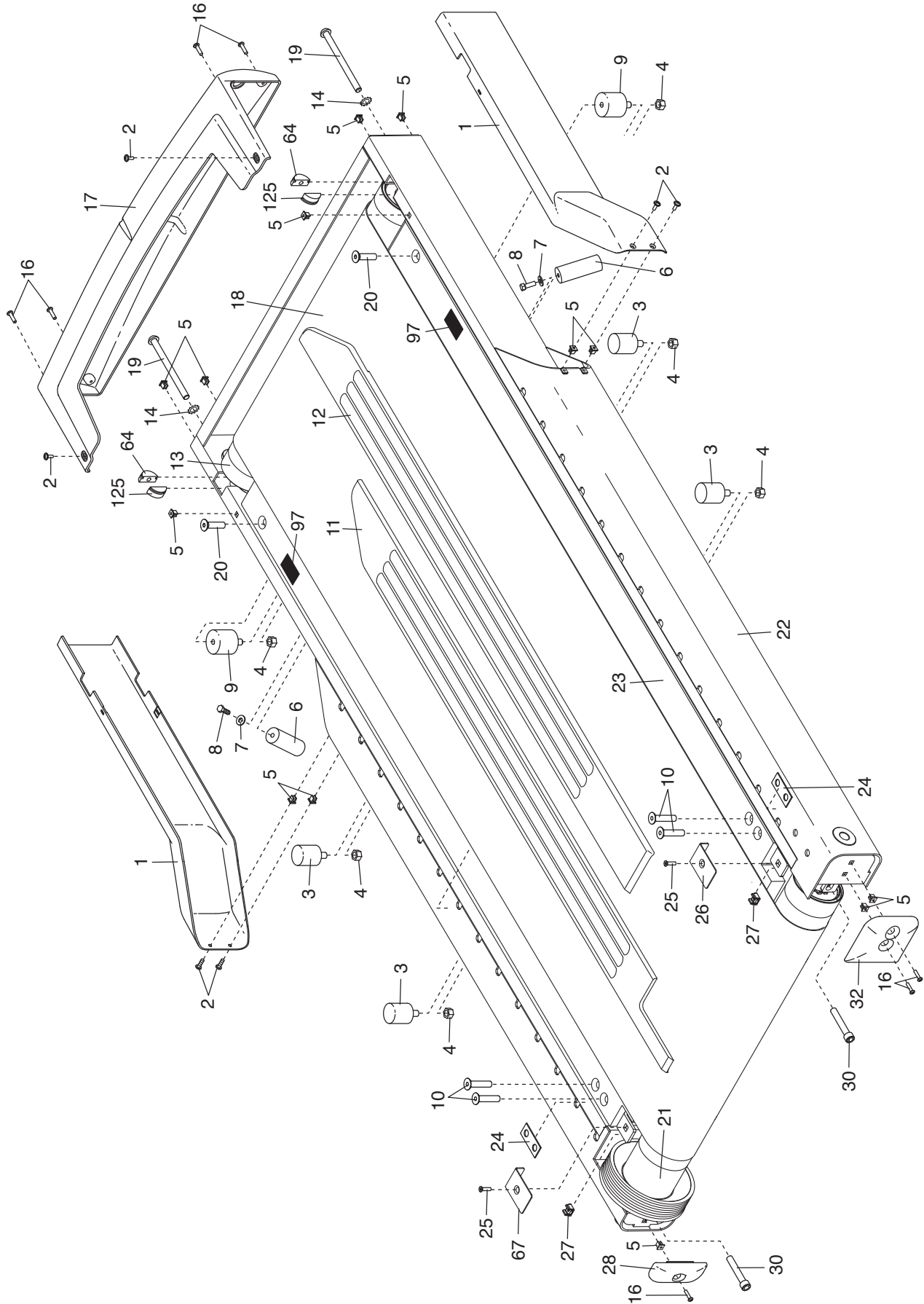

EXPLODED DRAWING B

Model No. VMTL39811.0 R0112A

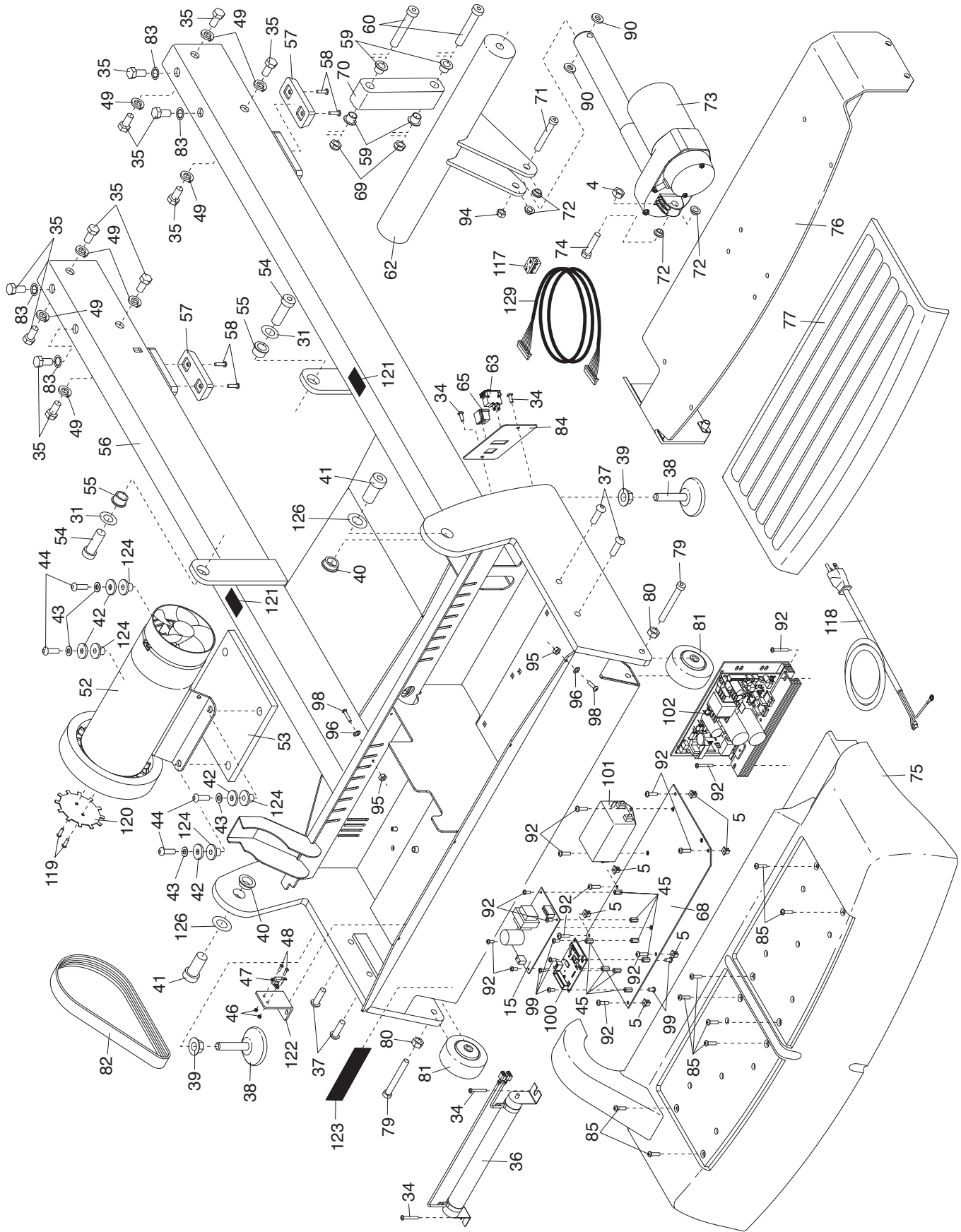

EXPLODED DRAWING C

Model No. VMTL39811.0 R0112A

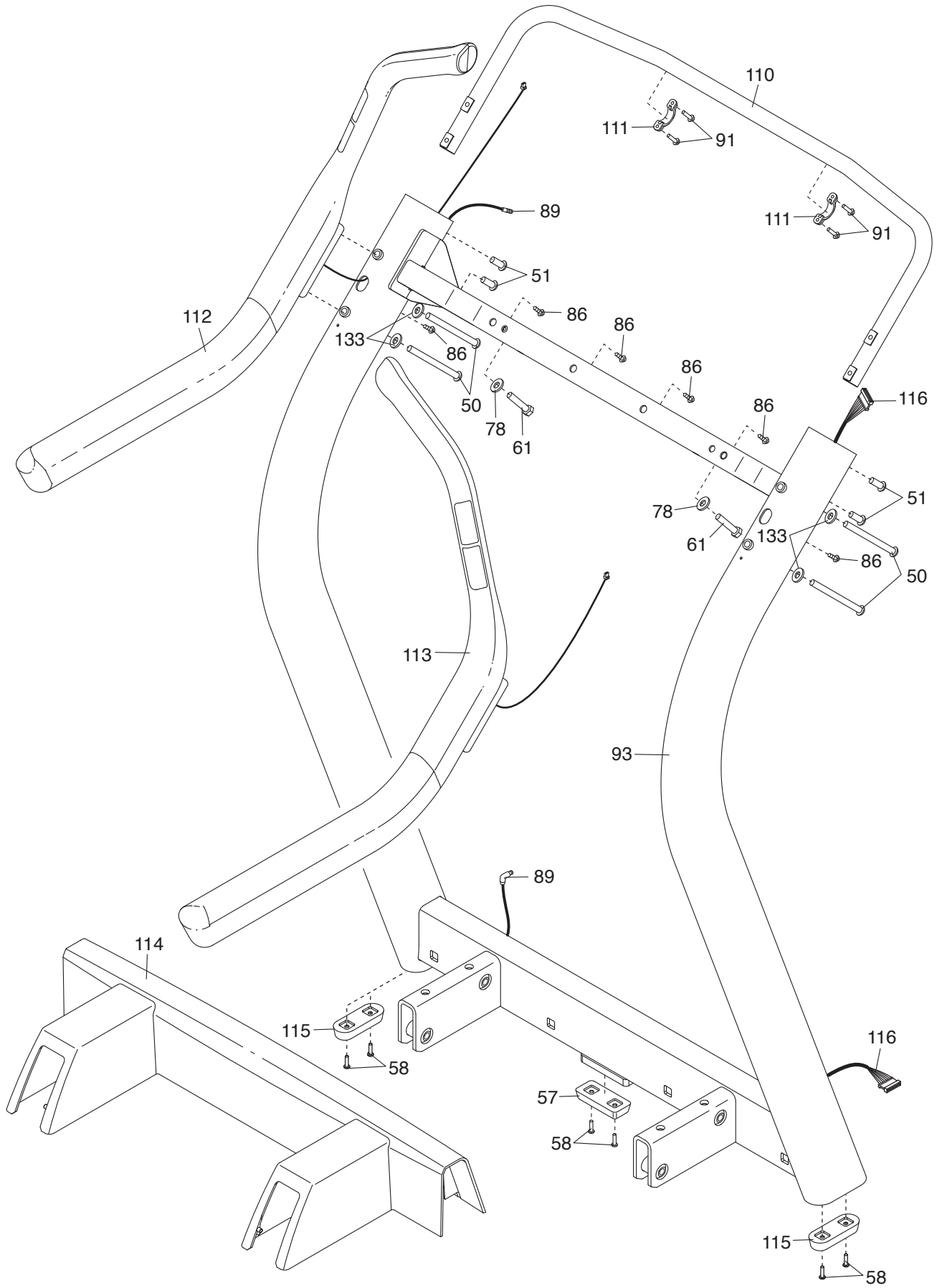

EXPLODED DRAWING D

Model No. VMTL39811.0 R0112A

