

# EXPLODED DRAWING SEARS MODEL NO. 831.15791.3; KMART MODEL NO. WEBE1137.3

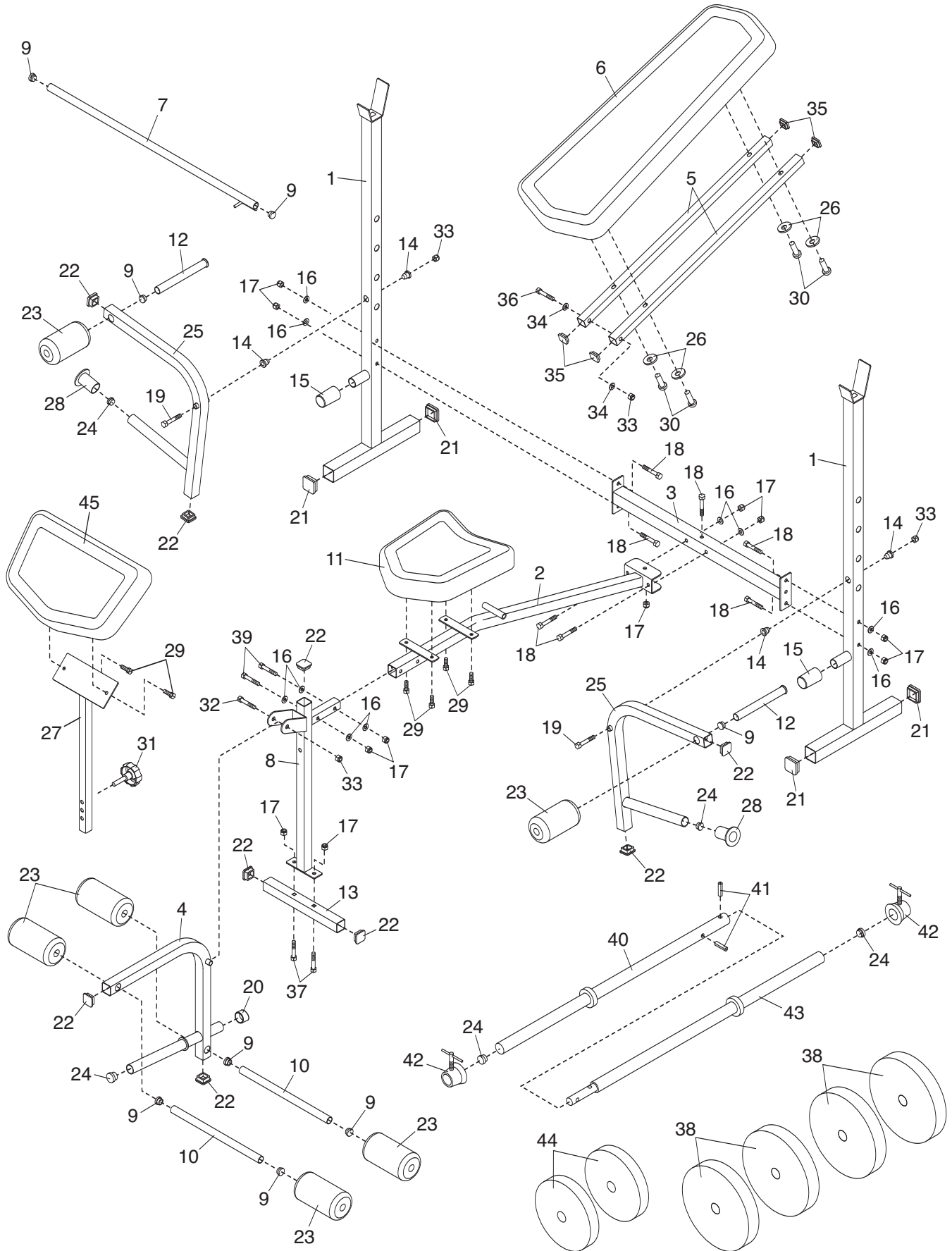

R1107A