

EXPLODED DRAWING SEARS MODEL NO. 831.15791.2; KMART MODEL NO. WEBE1137.2

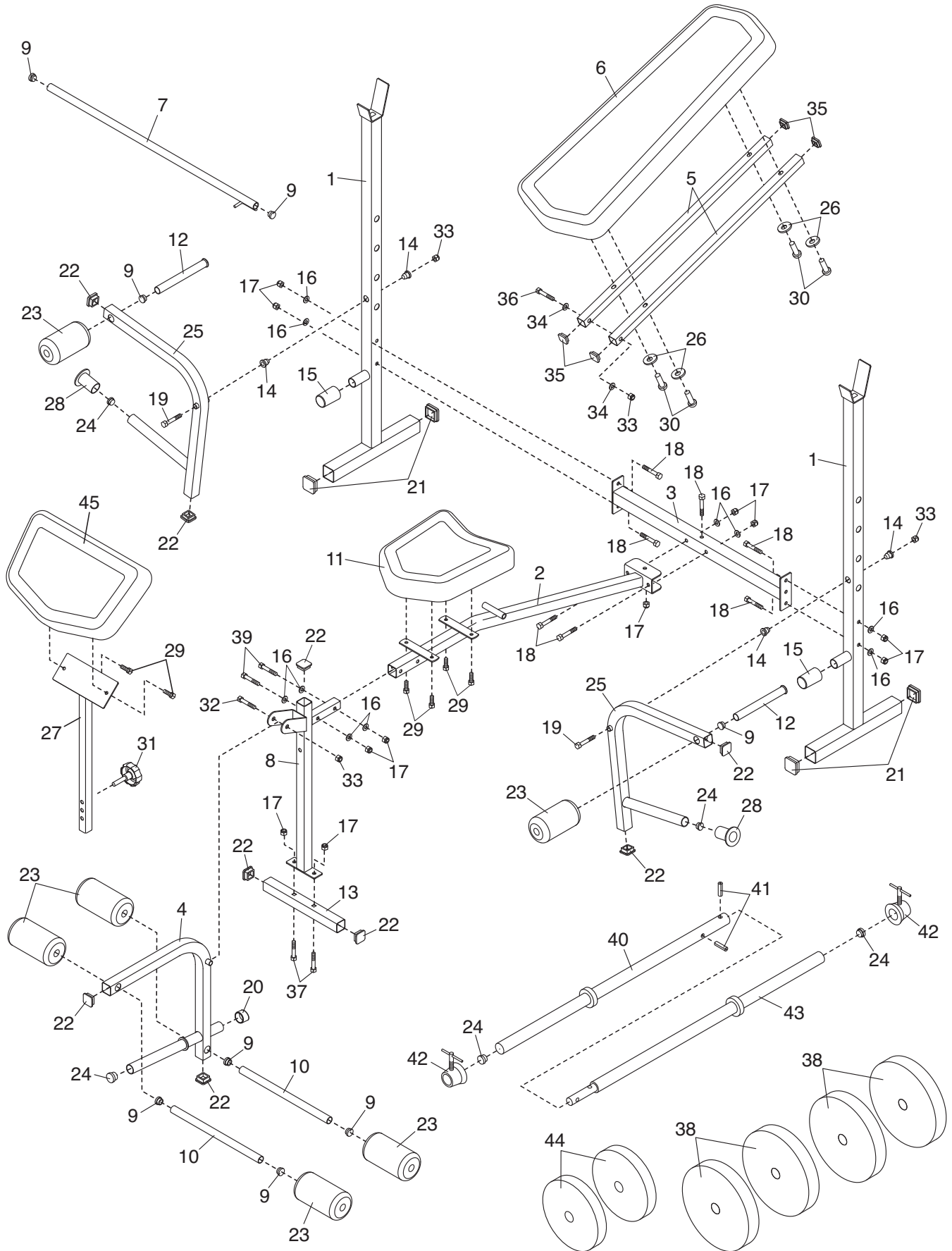

R1007A