

EXPLODED DRAWING A—Model No. WEEVSY2026.0

R0706A

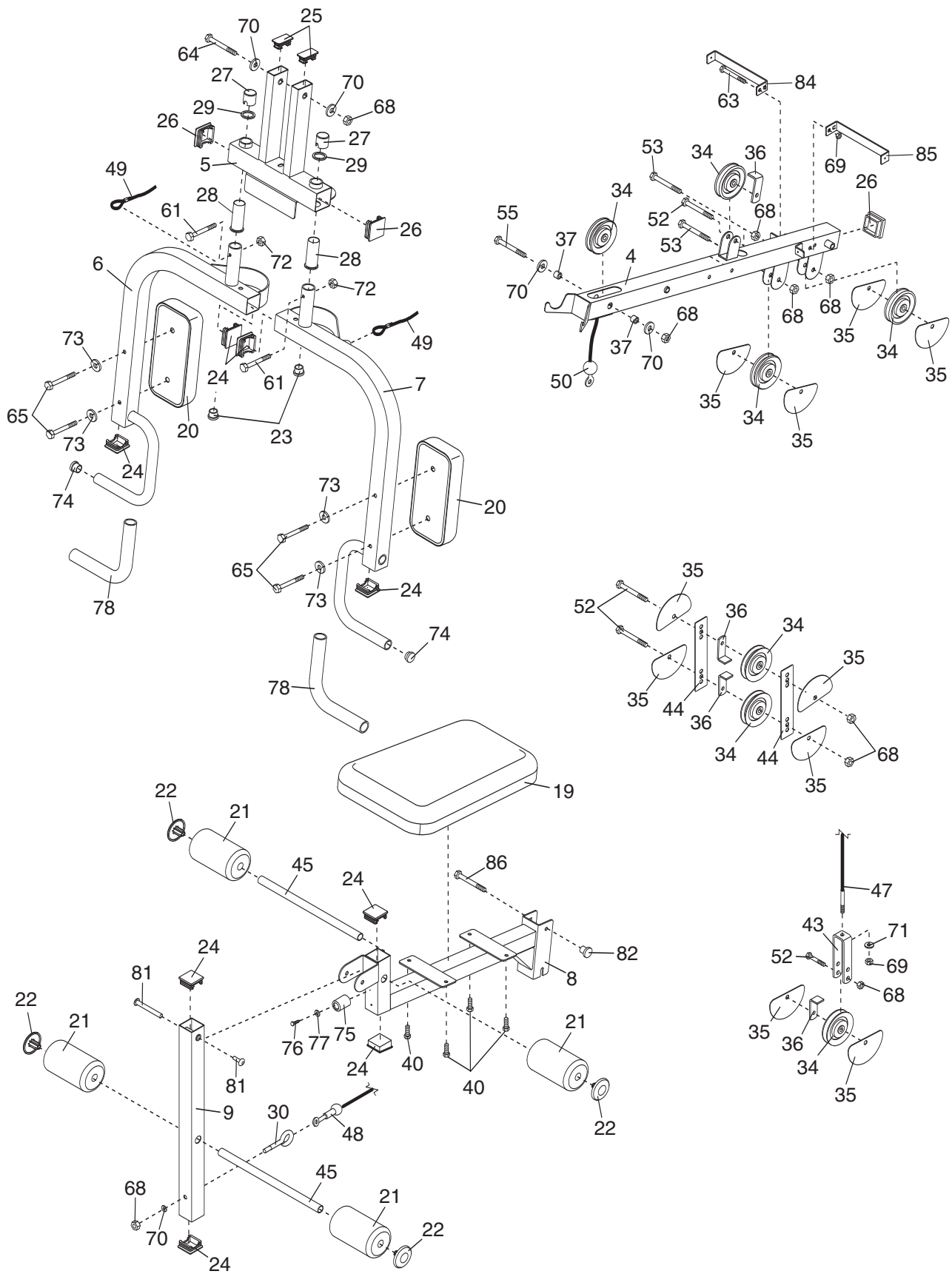

EXPLODED DRAWING B—Model No. WEEVSY2026.0

R0706A

