

EXPLODED DRAWING A

Model No. WLTL19616.0 R0617A

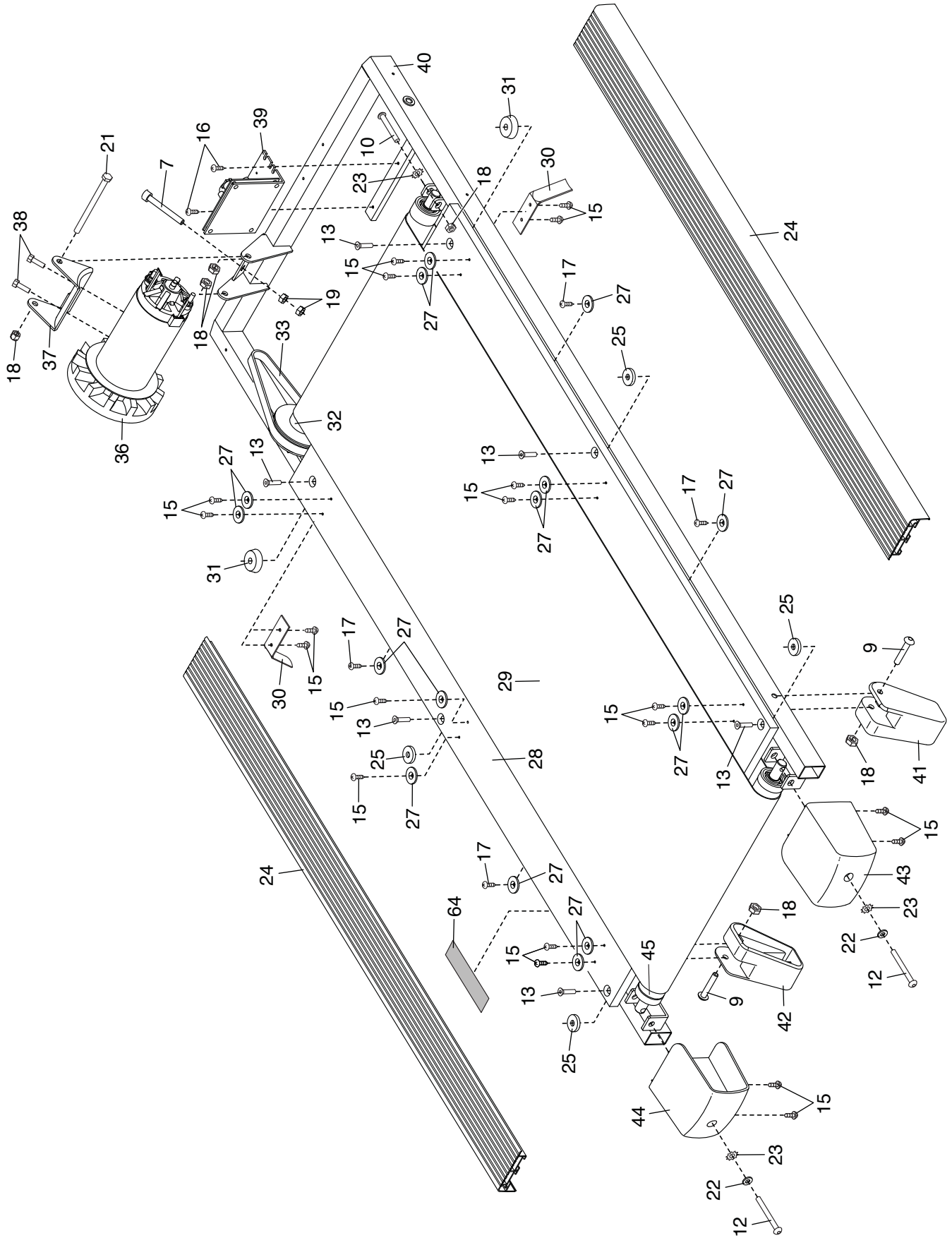

EXPLODED DRAWING B

Model No. WLTL19616.0 R0617A

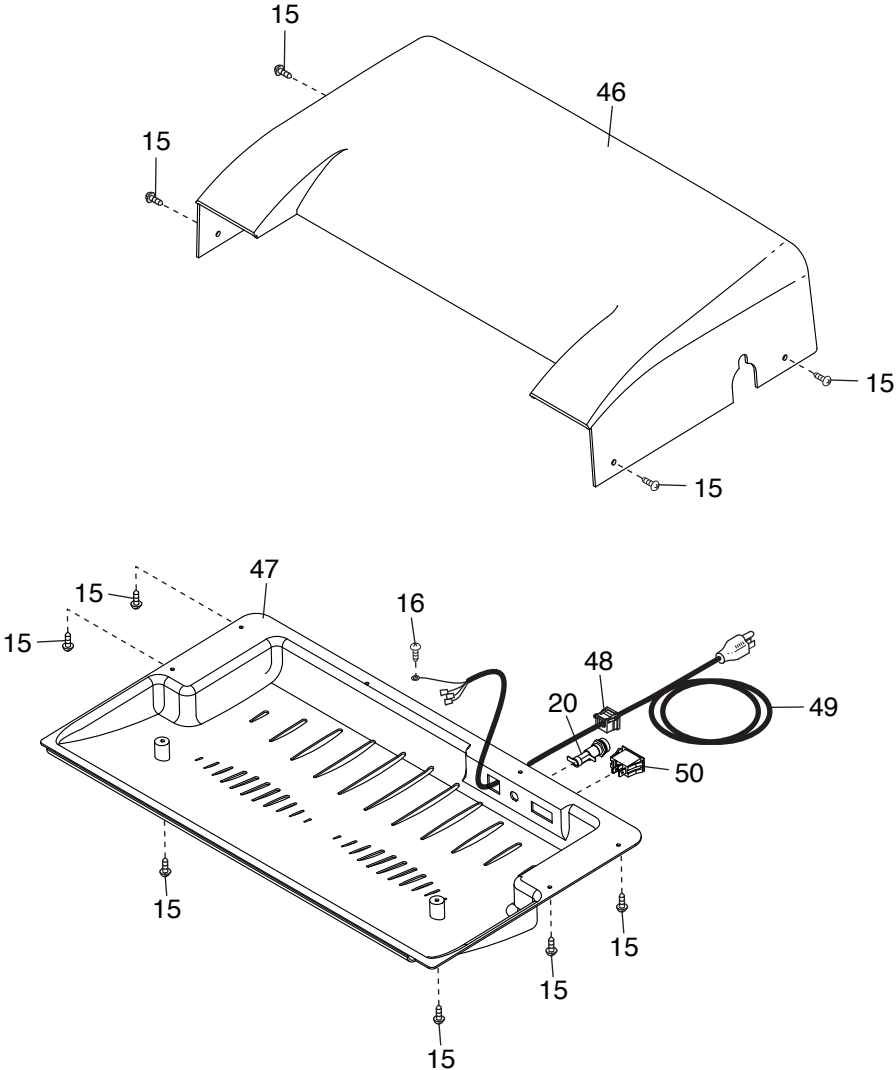

EXPLODED DRAWING C

Model No. WLT19616.0 R0617A

