

EXPLODED DRAWING A—Model No. WLTL29310.0

R0610A

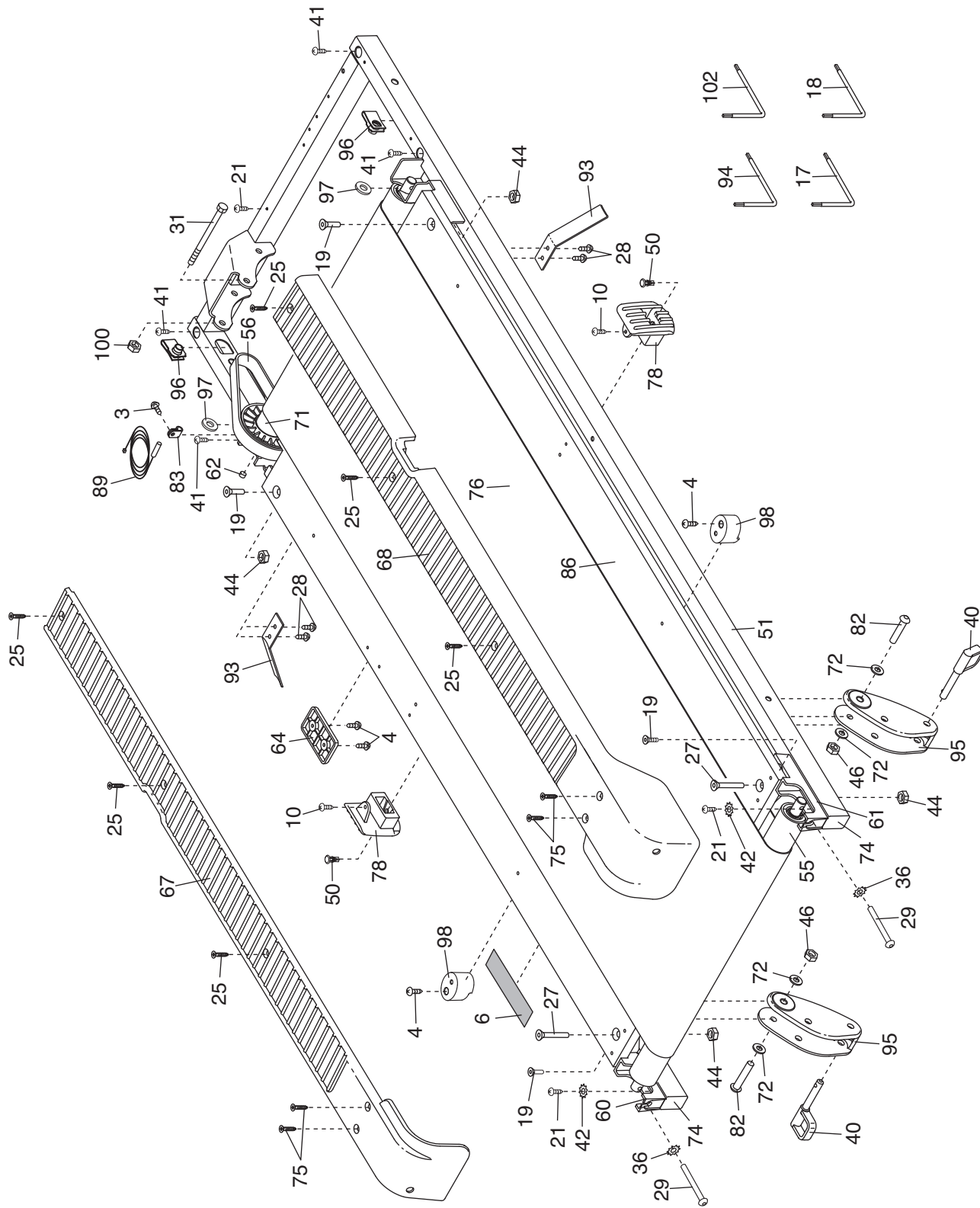

EXPLODED DRAWING B—Model No. WLTL29310.0

R0610A

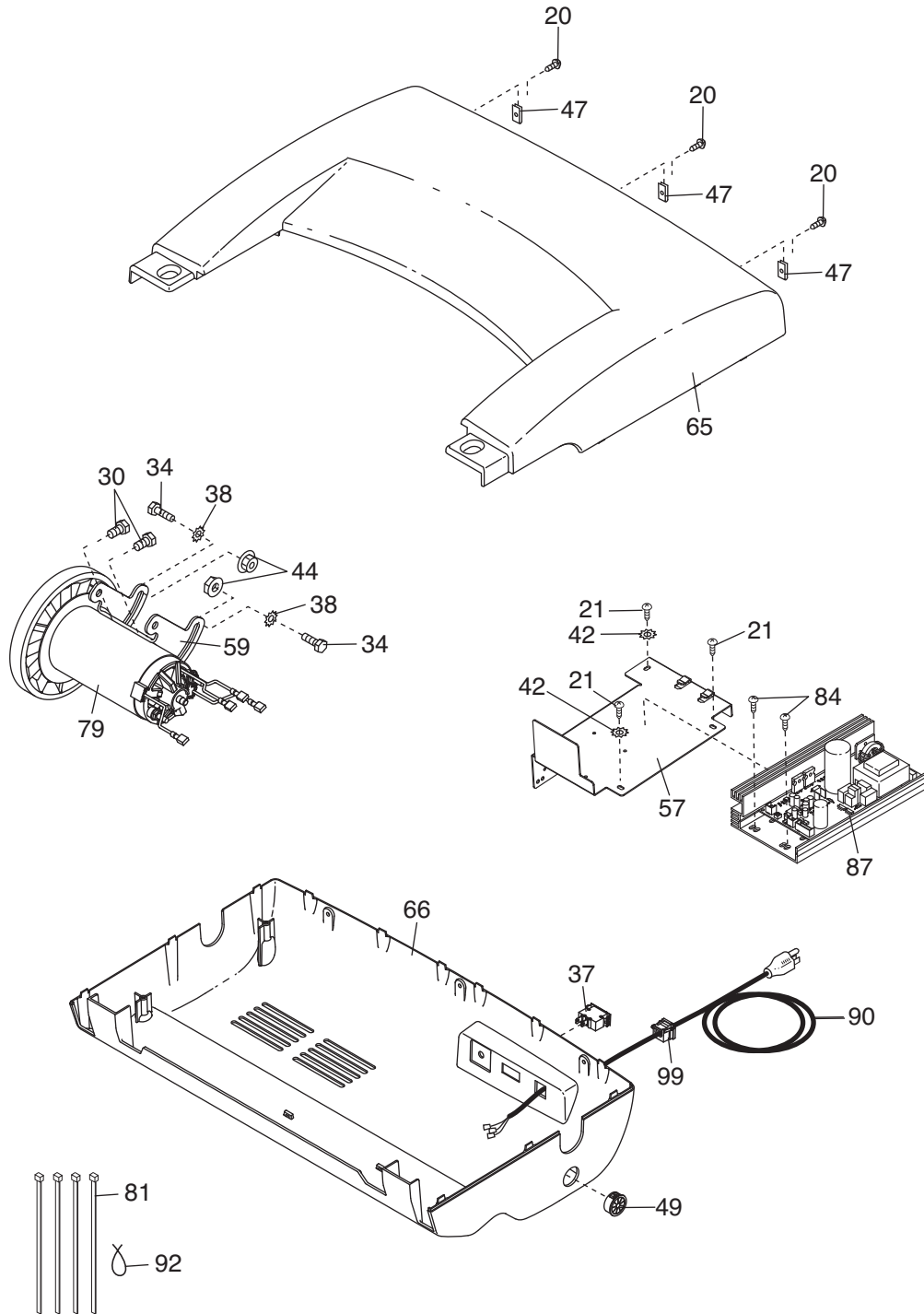

EXPLODED DRAWING C—Model No. WLTL29310.0

R0610A

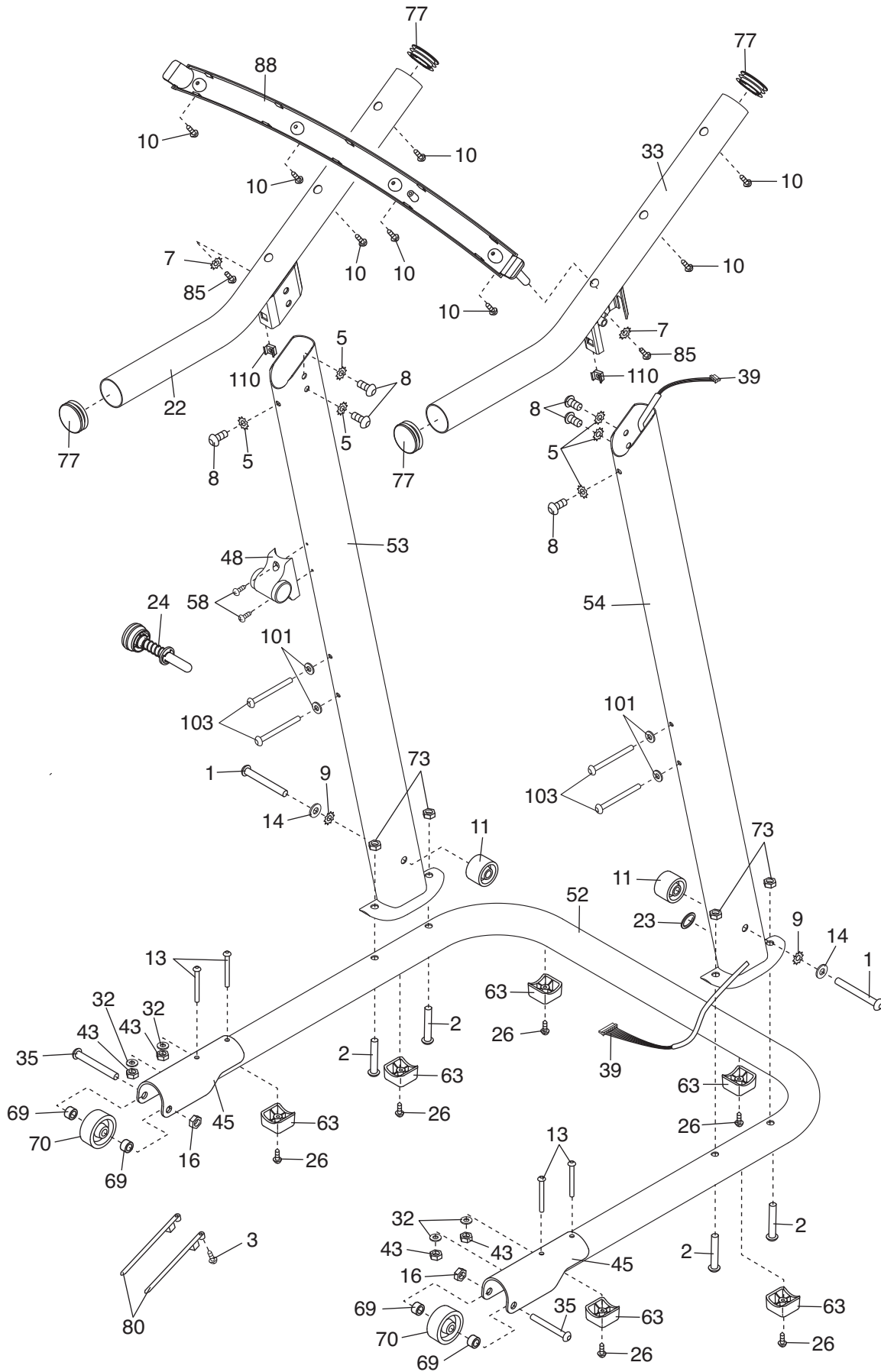

EXPLODED DRAWING D—Model No. WLTL29310.0

R0610A

