

EXPLODED DRAWING A

Model No. WLTL29609.15 R0317A

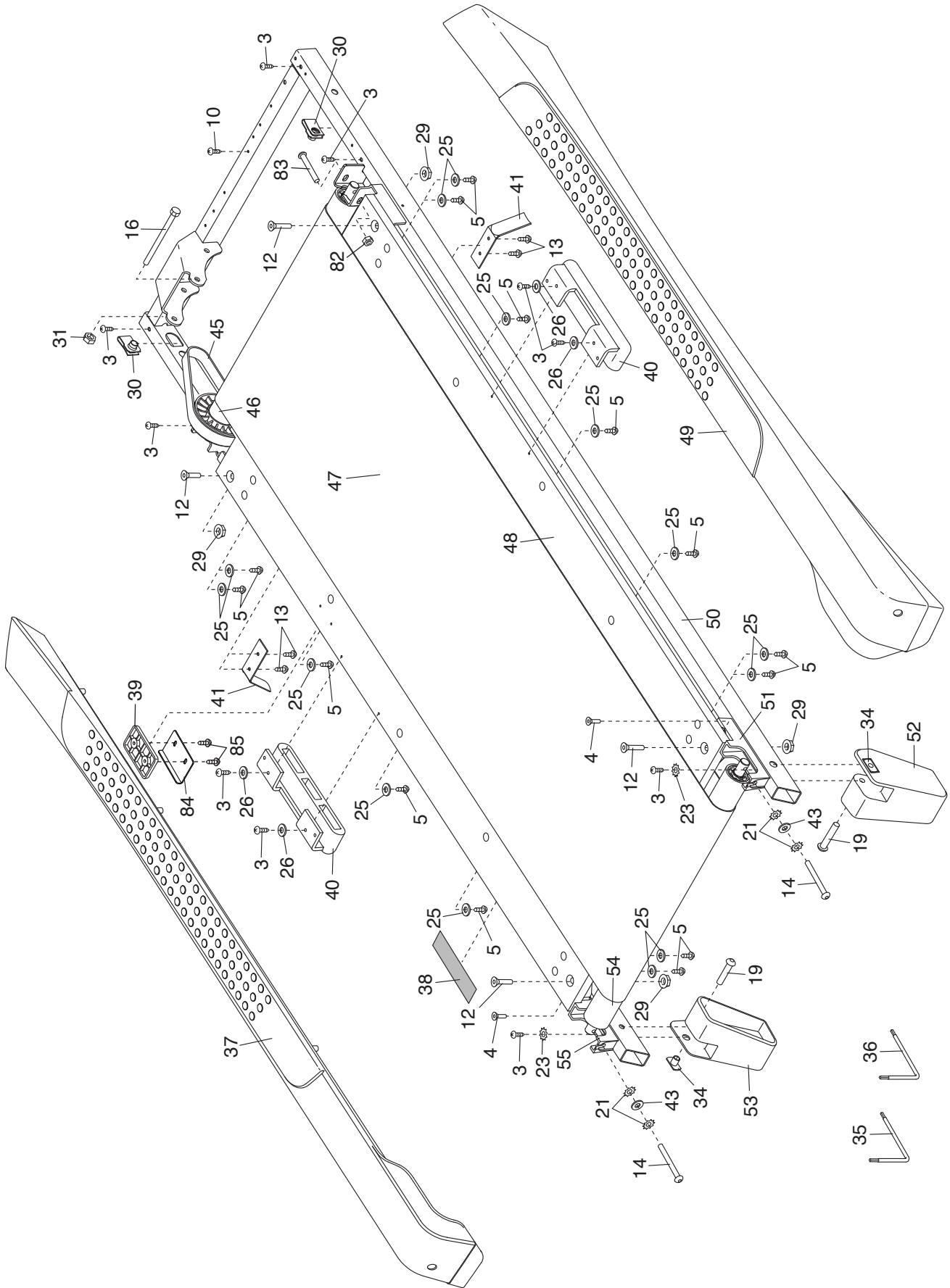

EXPLODED DRAWING B

Model No. WLTL29609.15 R0317A

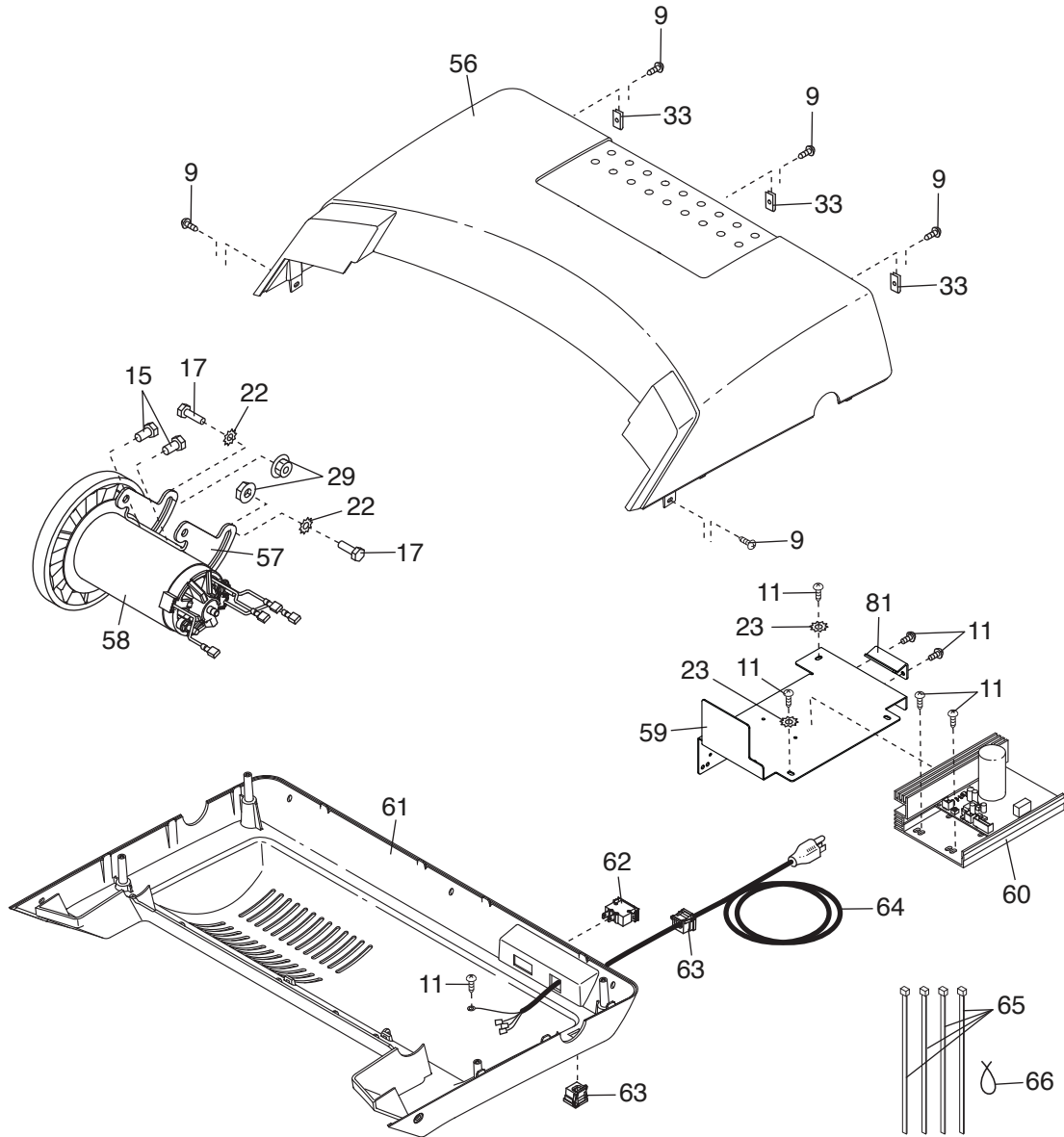

EXPLODED DRAWING C

Model No. WLTL29609.15 R0317A

