

EXPLODED DRAWING A

Model No. WLTL29609.18 R0617A

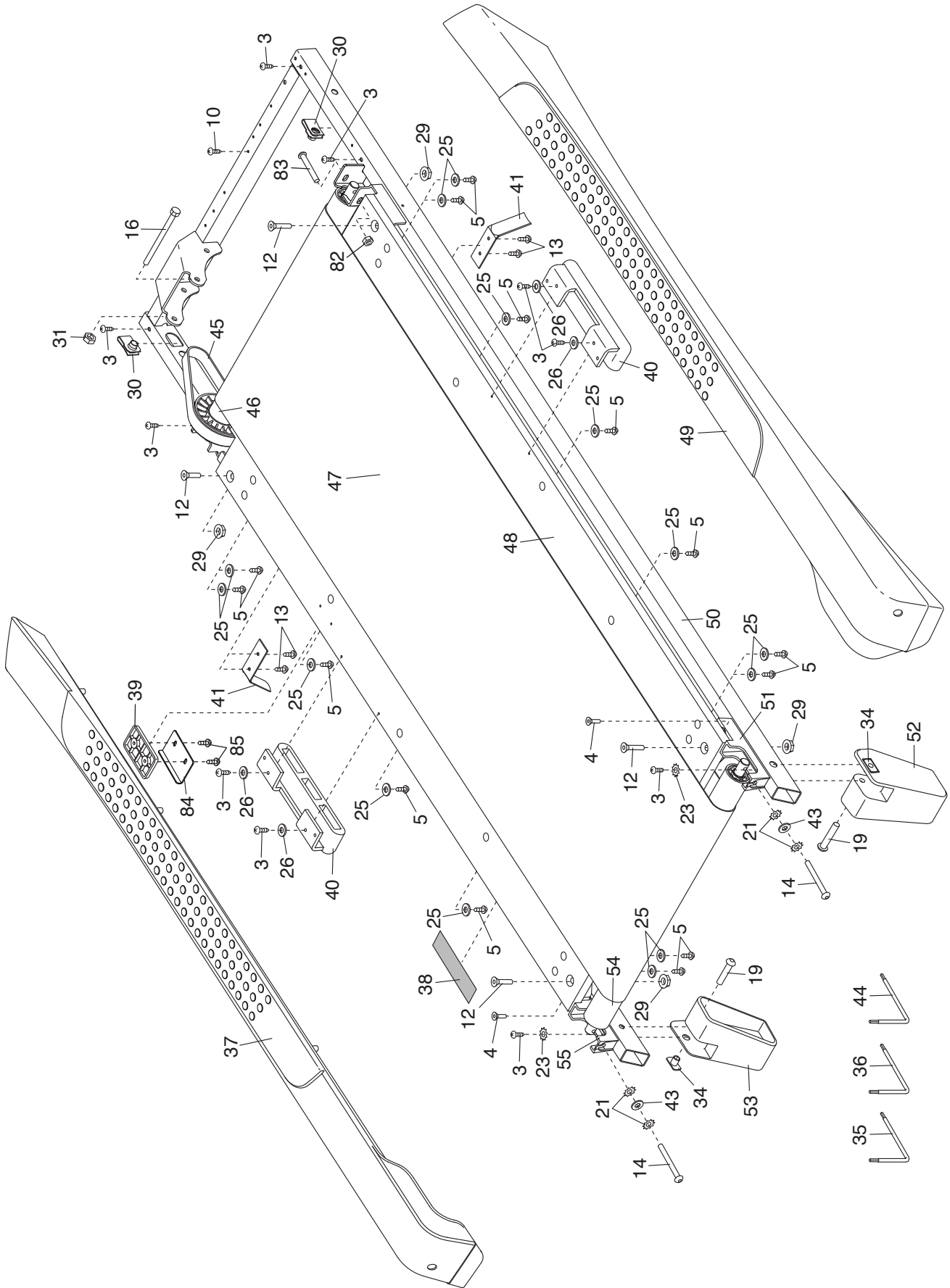

EXPLODED DRAWING B

Model No. WLTL29609.18 R0617A

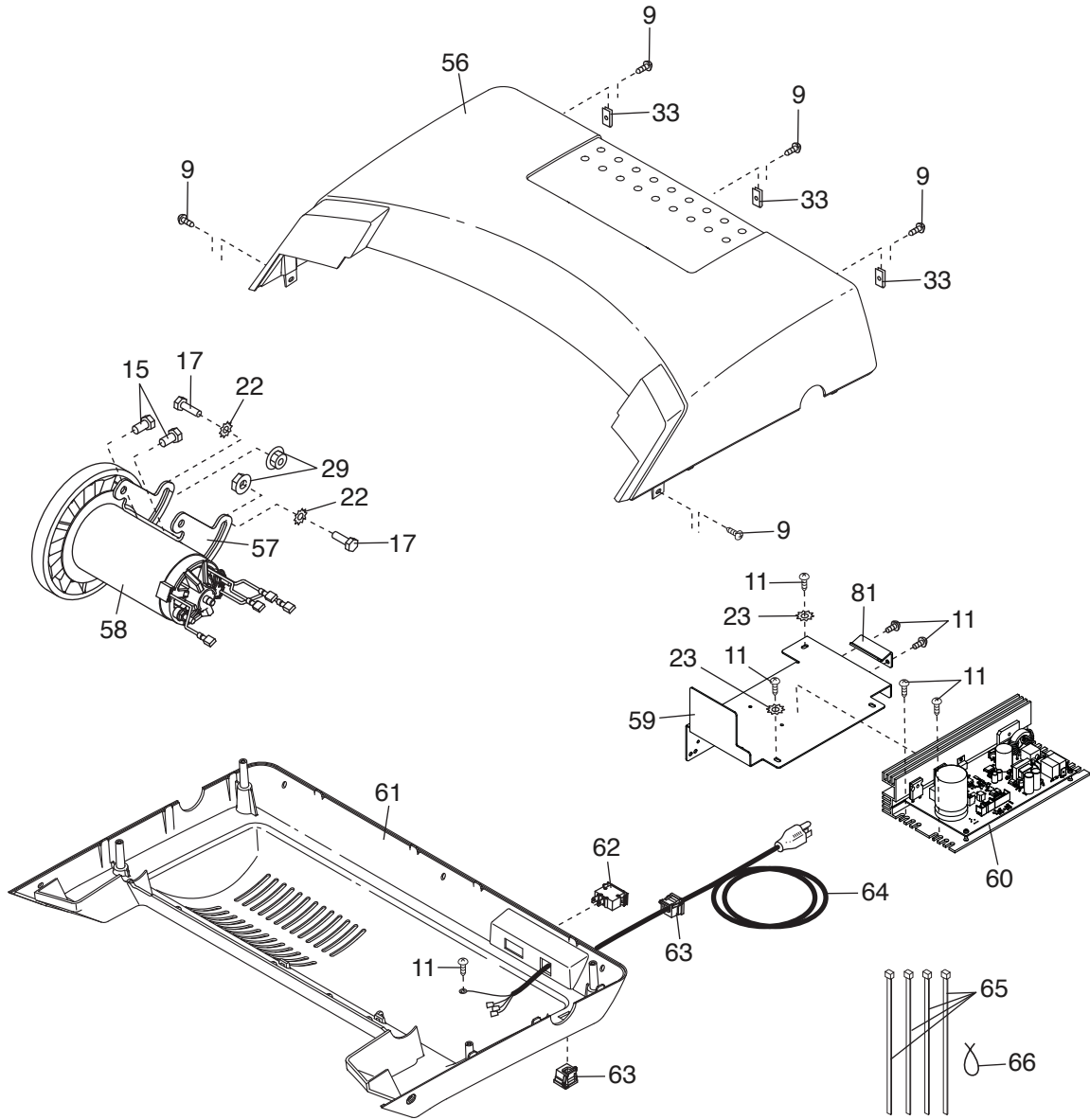

EXPLODED DRAWING C

Model No. WLTL29609.18 R0617A

