

EXPLODED DRAWING A

Model No. WLTL29615.10 R0218A

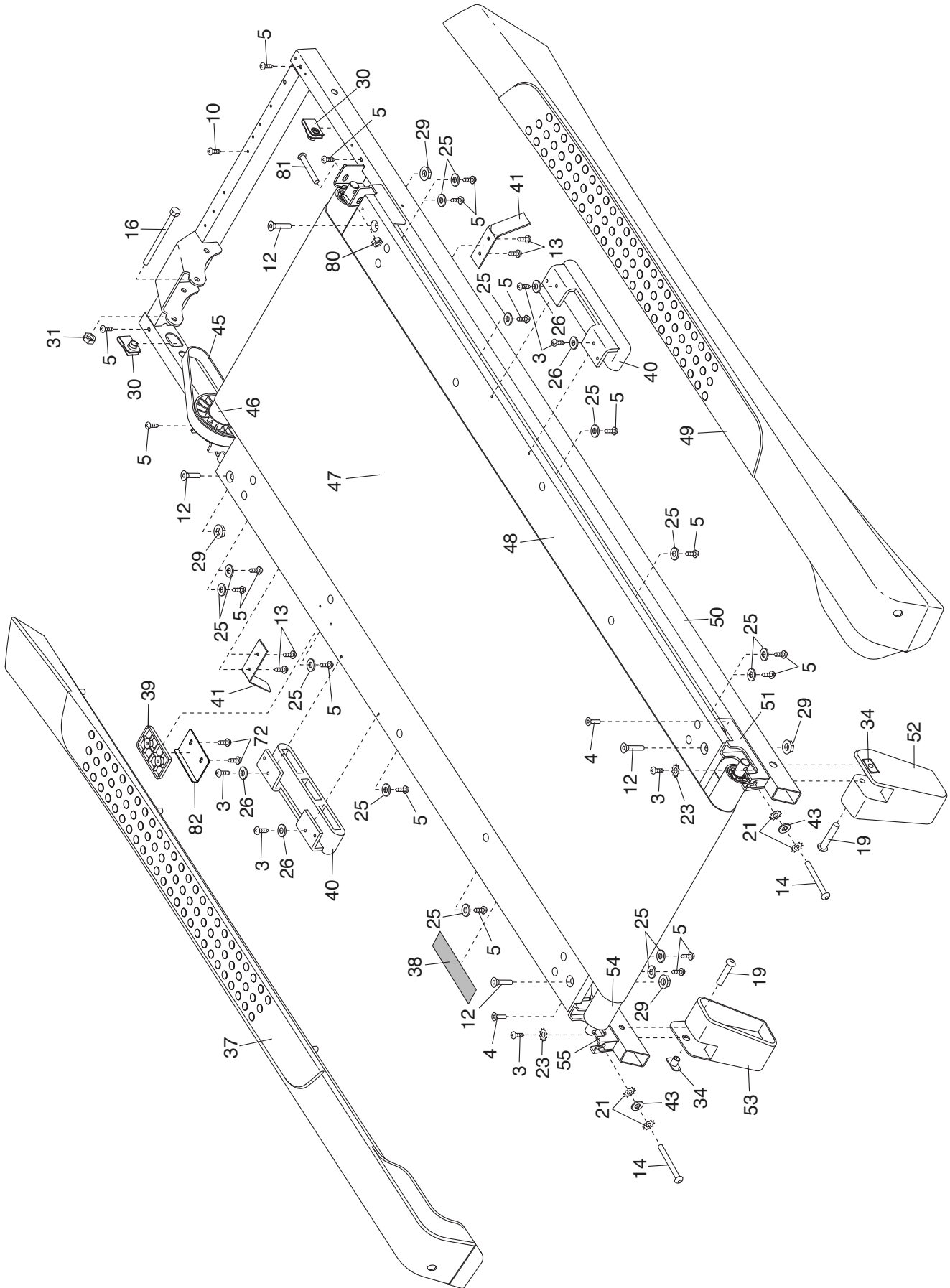

EXPLODED DRAWING B

Model No. WLTL29615.10 R0218A

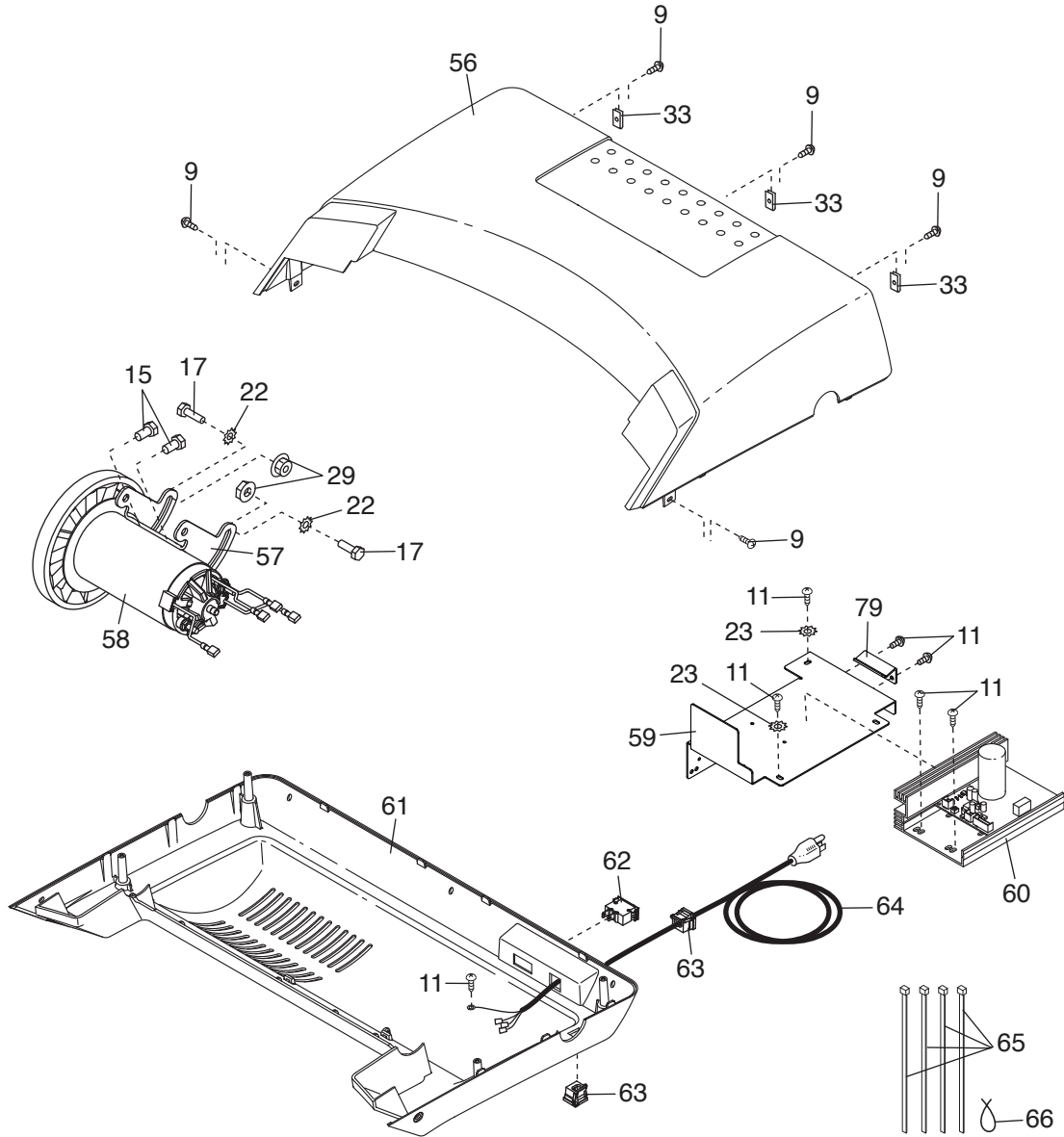

EXPLODED DRAWING C

Model No. WLTL29615.10 R0218A

