

# EXPLODED DRAWING A—Model No. NTEL07808.0

R1009A

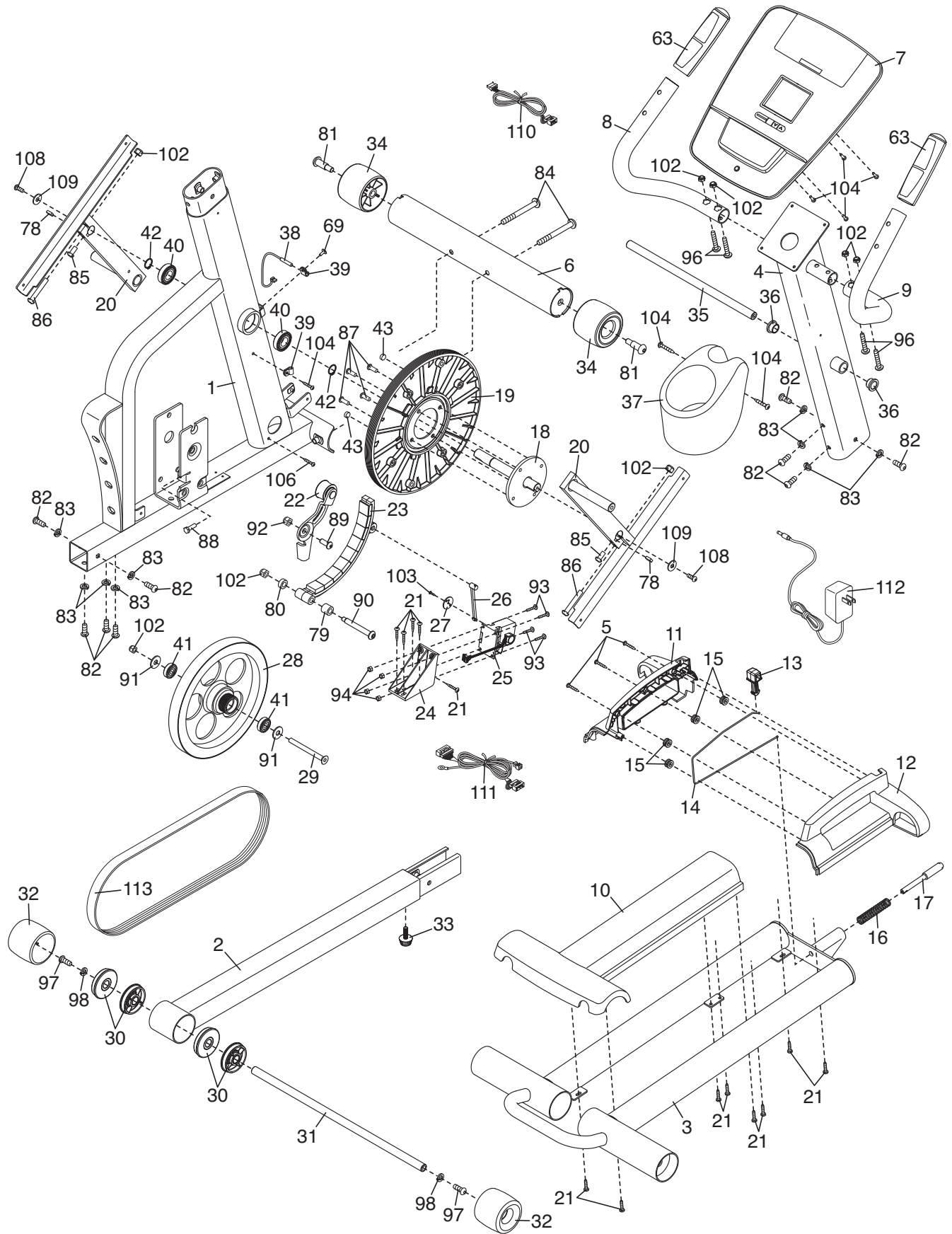

# EXPLODED DRAWING B—Model No. NTEL07808.0

R1009A

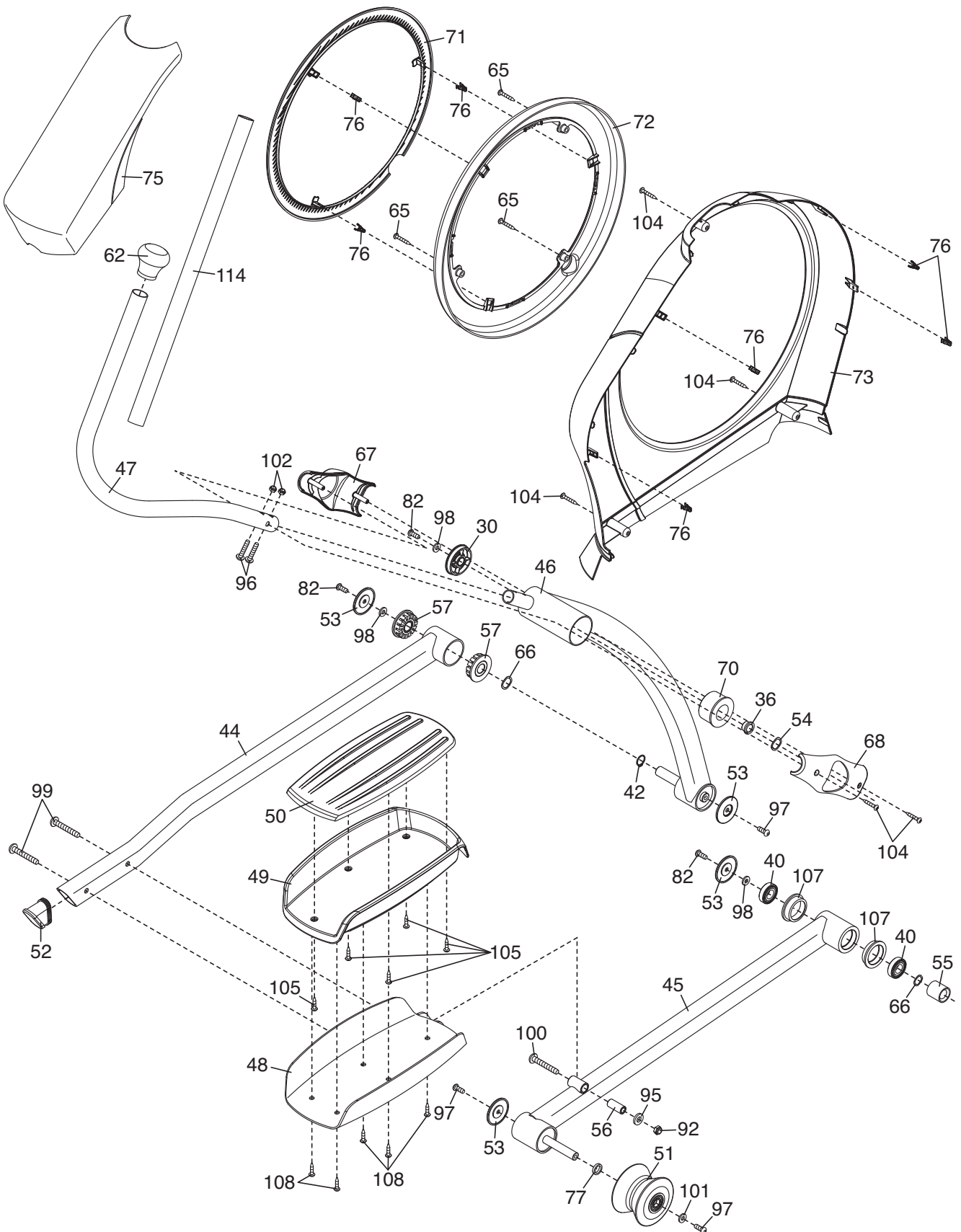

# EXPLODED DRAWING C—Model No. NTEL07808.0

R1009A

