

# IMAGE<sup>®</sup> 10.6<sup>®</sup>

## SEARS

Model No. 831.297562

Serial No. \_\_\_\_\_

The serial number can be found in the location shown below. Write the serial number in the space above.

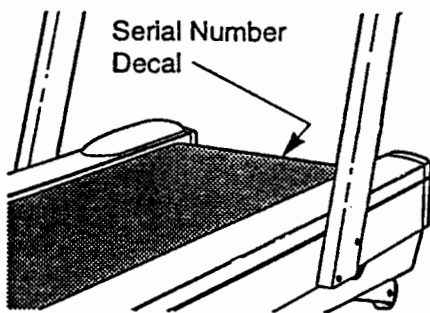

EXERCISE  
EQUIPMENT

QUESTIONS

HELPLINE!

1-800-736-6879

### CAUTION

Read all precautions and instructions in this manual before using this equipment. Keep this manual for future reference.

## OWNER'S MANUAL

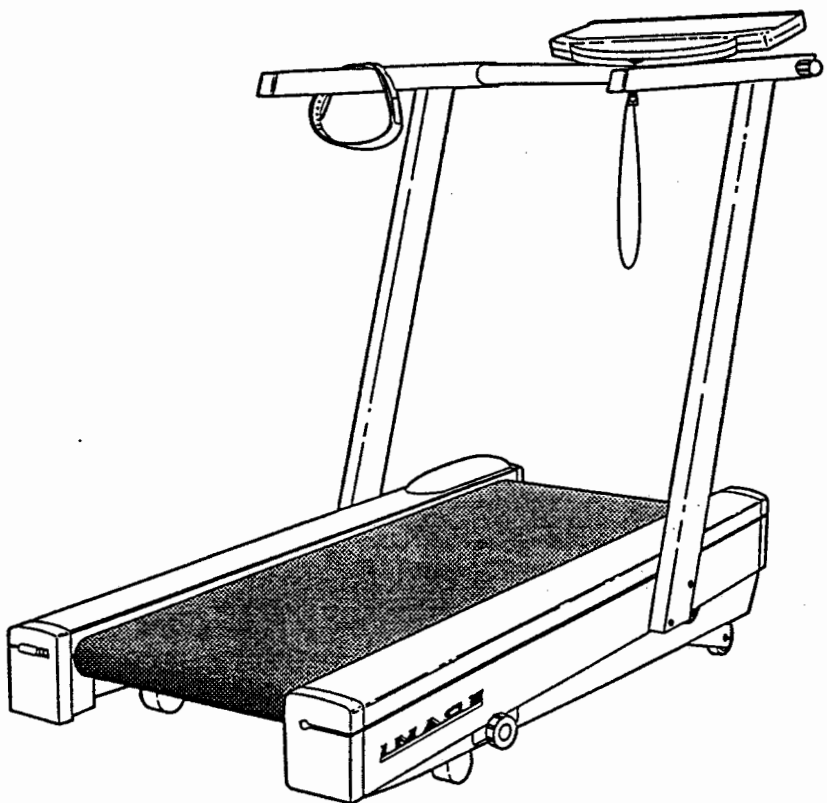

**IMPORTANT:** This treadmill features a state-of-the-art cordless pulse sensor. Please read this manual carefully before using the pulse sensor. If you have questions about the pulse sensor, please see pages 7, 8, and 13 before calling our toll-free HELPLINE.

SEARS, ROEBUCK AND CO., HOFFMAN ESTATES, IL 60179 USA

# TABLE OF CONTENTS

FULL ONE YEAR WARRANTY .....	2
IMPORTANT PRECAUTIONS .....	3
BEFORE YOU BEGIN .....	4
ASSEMBLY .....	5
HOW TO USE THE PULSE SENSOR .....	7
OPERATION AND ADJUSTMENT .....	9
MANUAL MODE OPERATION .....	11
HOW TO CONTROL THE SPEED .....	11
HOW TO CONTROL THE INCLINE .....	11
HOW TO USE THE FAT CALORIE MONITOR .....	12
PROGRAM MODE OPERATION .....	12
HOW TO USE A PRESET WORKOUT PROGRAM .....	12
HOW TO USE THE PULSE MODE .....	13
HOW TO USE THE FAT BURN AND FAT BURN PLUS PROGRAMS .....	15
HOW TO USE THE FITNESS TEST PROGRAM .....	15
HOW TO CREATE CUSTOM WORKOUT PROGRAMS .....	16
HOW TO USE A CUSTOM WORKOUT PROGRAM .....	17
TROUBLE-SHOOTING AND STORAGE .....	20
CONDITIONING GUIDELINES .....	22
ORDERING REPLACEMENT PARTS .....	Back Cover

Note: There is an EXPLODED DRAWING and PART LIST attached to the center of this manual. Save the EXPLODED DRAWING and PART LIST for future reference.

## FULL ONE YEAR WARRANTY

For one (1) year from the date of purchase, if failure occurs due to defect in material or workmanship in this SEARS TREADMILL EXERCISER, contact the nearest SEARS Service Center throughout the United States and SEARS will repair or replace the TREADMILL EXERCISER, free of charge.

This warranty does not apply when the TREADMILL EXERCISER is used commercially or for rental purposes.

This warranty gives you specific legal rights, and you may also have other rights which vary from state to state.

SEARS, ROEBUCK AND CO., DEPT. 817WA, HOFFMAN ESTATES, IL 60179

**▲ WARNING:** Before beginning this or any exercise program, consult your physician. This is especially important for persons over the age of 35 or persons with pre-existing health problems. Read all instructions before using. SEARS assumes no responsibility for personal injury or property damage sustained by or through the use of this product.

# IMPORTANT PRECAUTIONS

**⚠ WARNING:** To reduce the risk of burns, fire, electric shock or injury to persons, read the following important precautions and information before operating the treadmill.

1. It is the responsibility of the owner to ensure that all users of this treadmill are adequately informed of all warnings and precautions.
2. Use the treadmill only as described in this manual.
3. Place the treadmill on a level surface, with at least 8 feet of clearance behind it. To protect the floor or carpet from damage, place a mat under the treadmill.
4. Do not place the treadmill near water, outdoors, or on a surface that blocks any air openings.
5. Do not operate the treadmill where aerosol products are used or where oxygen is being administered.
6. Keep small children and pets away from the treadmill at all times.
7. The treadmill should be used only by persons weighing 250 pounds or less.
8. Never allow more than one person on the treadmill at a time.
9. When connecting the power cord (see HOW TO PLUG IN THE POWER CORD on page 9), plug the power cord into a surge protector (not included) and plug the surge protector into a grounded circuit capable of carrying 15 or more amps. No other appliance should be on the same circuit.
10. Use only a UL-listed surge protector, rated at 15 amps, with a 14-gauge cord of five feet or less in length. Do not use an extension cord.
11. Keep the power cord and the surge protector away from heated surfaces.
12. Never move the walking belt while the power is turned off. Do not operate the treadmill if the power cord or plug is damaged, or if the treadmill is not working properly. (See **BEFORE YOU BEGIN** on page 4 if the treadmill is not working properly.)
13. Wear appropriate clothing when using the treadmill; do not wear loose clothing that could become caught in the treadmill. Athletic support clothes are recommended for both men and women. *Always wear athletic shoes; never use the treadmill with bare feet, wearing only stockings or in sandals.*
14. Never start the treadmill while you are standing on the walking belt. Always hold the handrail while exercising on the treadmill.
15. The treadmill is capable of high speeds. Adjust the speed in small increments to avoid sudden jumps in speed.
16. To reduce the possibility of the treadmill overheating, do not operate the treadmill continuously for longer than 1 hour.
17. The pulse sensor is not a medical device. Various factors, including the user's movement while exercising, may affect the accuracy of heart rate readings. The sensor is intended only as an exercise aid in determining heart rate trends in general.
18. Never leave the treadmill unattended while it is running. Always remove the key and move the on/off switch to the "off" position when the treadmill is not in use. (See the drawing on page 4 for the location of the on/off switch.)
19. Inspect and tighten all parts of the treadmill every three months.
20. Never insert any object into any opening.
21. Always unplug the power cord before performing the maintenance and adjustment procedures described in this manual. Servicing other than the procedures in this manual should be performed by an authorized service representative only.

**SAVE THESE INSTRUCTIONS**

# BEFORE YOU BEGIN

Thank you for selecting the IMAGE® 10.6 treadmill. The sophisticated IMAGE 10.6 treadmill blends state-of-the-art technology with innovative design to let you enjoy a motivating and effective form of exercise in the convenience and privacy of your home.

For your benefit, read this manual carefully before using the treadmill. If you have additional questions, please call our toll-free HELPLINE at 1-800-736-6879, Monday through Saturday, 7 a.m. until 7 p.m. Central

Time (excluding holidays). To help us assist you, please note the product model number and serial number before calling. The model number of the treadmill is 831.297562. The serial number can be found on a decal attached to the treadmill (see the front cover of this manual for the location of the decal).

Before reading further, please review the drawing below and familiarize yourself with the parts that are labeled.

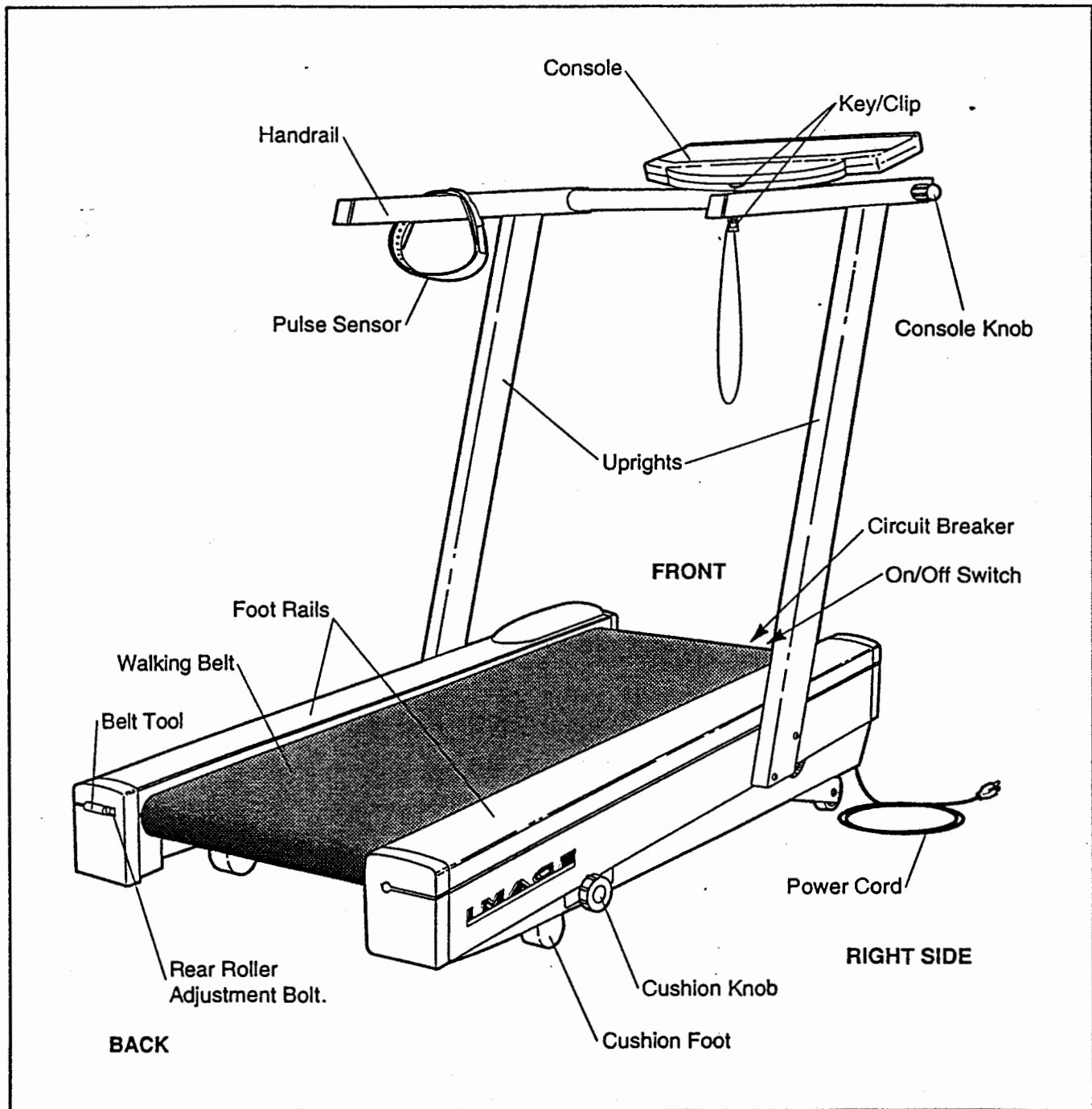

# ASSEMBLY

**Assembly requires two people.** Set the treadmill in a cleared area and remove all packing materials. Do not dispose of the packing materials until the treadmill is fully assembled.

Assembly can be completed using the included 7/32" allen wrench .

1. Find the Right Upright (15), which contains the Upright Wire Harness (12) (see the inset drawing). Hold an Upright Spacer (25) inside the lower end of the Right Upright. Insert a 3/8" x 3 1/2" Bolt (27), with one of the four Upright Washers (26), into the lower hole in the Right Upright, and through the Upright Spacer. Slide a Star Washer (49) onto the Bolt. Finger tighten the Bolt into the indicated hole in the Frame (50).

Insert a 3/8" x 3 1/2" Bolt (27), with an Upright Washer (26), through the other hole in the lower end of the Right Upright (15). Finger tighten the Bolt into the Frame (50).

Attach the Left Upright (not shown) in the same manner.

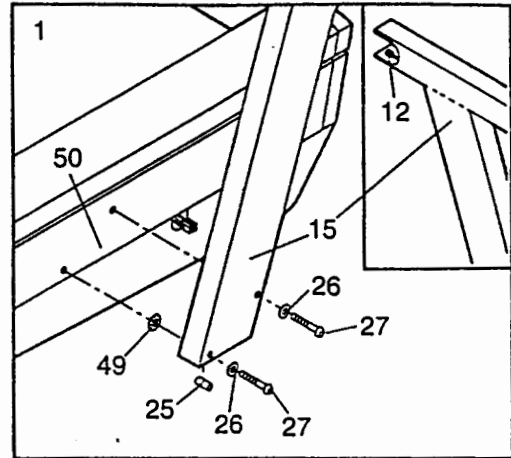

2. Hold the right end of the Console Crossbar (6) near the Right Upright (15). Connect the Console Wire Harness (10) to the Upright Wire Harness (12). The small latch on the Console Wire Harness should snap onto the Upright Wire Harness (see the inset drawing). If the Wire Harnesses do not fit together easily, turn them; do not force the Wire Harnesses together.

Slide the ends of the 6" Cable Looms (30) against the ends of the Wire Harnesses (10, 12). Insert the Cable Looms into the Right Upright (15). Be careful not to damage the Wire Harnesses.

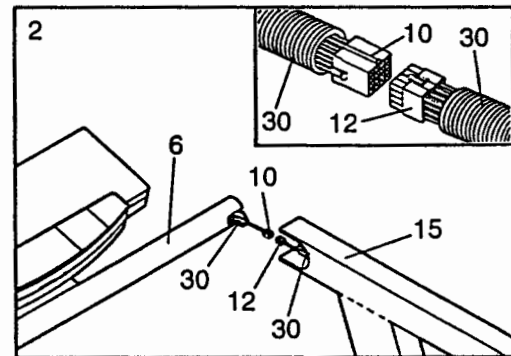

3. Slide the ends of the Console Crossbar (6) into the Right and Left Uprights (15, 2) as shown. Insert a Console Knob (3) into each Upright, and thread the Console Knobs into the ends of the Console Crossbar. Rotate the Console (9) to the desired angle, and tighten the Console Knobs.

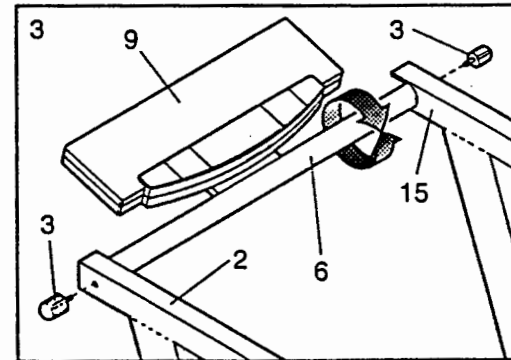

4. Tap an Upright Endcap (4) into each of the Uprights (15, 2).

See assembly step 1. Using the Included 7/32" allen wrench, tighten the four 3/8" x 3 1/2" Bolts (27).

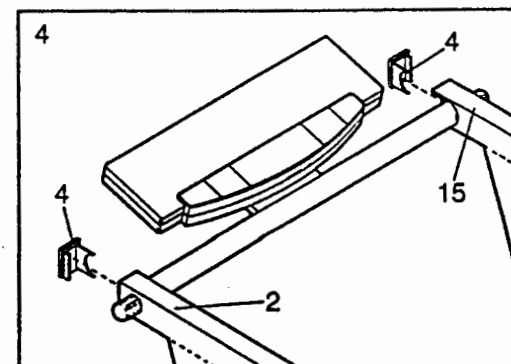

5. Plug the lower end of the Upright Wire Harness (12) into the 20" Wire Harness (45). The small latch on the Upright Wire Harness should snap onto the 20" Wire Harness (see the upper inset drawing). If the Wire Harnesses do not fit together easily, turn them; do not force the Wire Harnesses together.

Slide the ends of the 12" Cable Looms (36) against the ends of the Wire Harnesses (12, 45) (see the lower inset drawing). Be careful not to damage the Wire Harnesses.

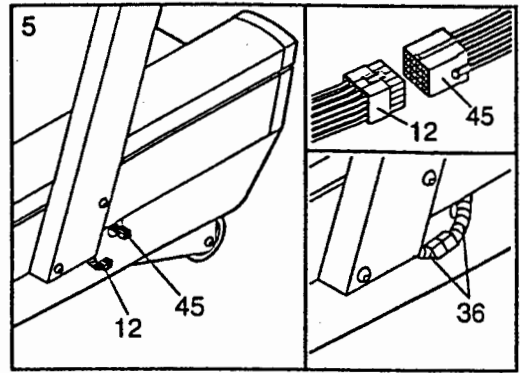

6. Press the Belt Tool (86) into the opening in the Left Rear Endcap (82). The use of the Belt Tool is explained on page 21.

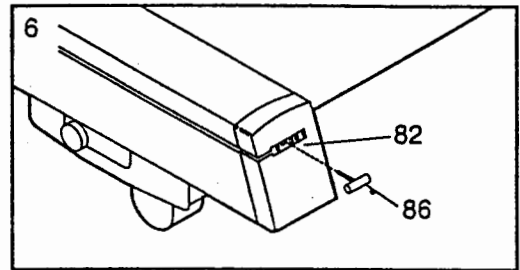

7. Attach the Pulse Sensor (14) to one of the Headbands (93 or 107). Make sure that the sensor window is pressed through the indicated hole in the Headband.

The use of the pulse sensor is explained on pages 7 and 8.

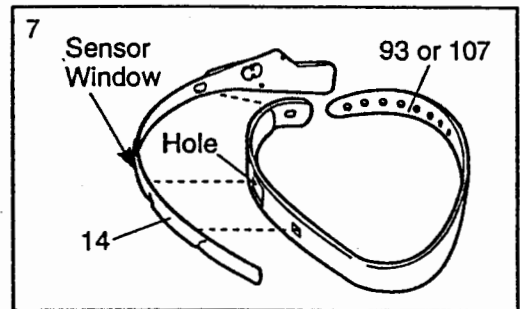

Make sure that all parts are tightened before you use the treadmill. The use of all remaining parts will be explained in other sections of this manual. **Note:** To protect the floor or carpet from damage, place a mat under the treadmill.

# HOW TO USE THE PULSE SENSOR

The treadmill features a state-of-the-art cordless pulse sensor, specially designed for greater accuracy, comfort, and durability. **Please read the following instructions before using the pulse sensor.**

## HOW TO INSTALL BATTERIES

The pulse sensor requires two "AAA" batteries. Alkaline batteries are recommended. To install batteries, first slide off the battery cover as shown below.

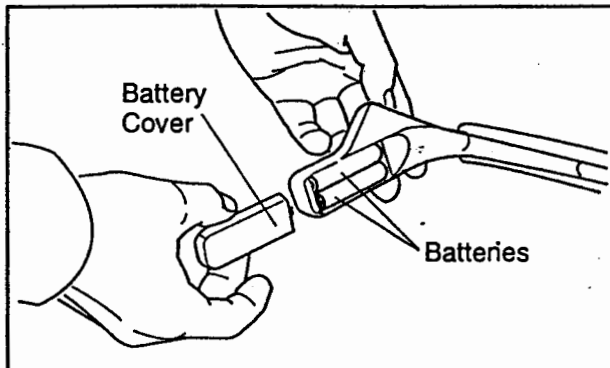

Note the markings inside the battery compartment showing which direction batteries must be turned. Insert two "AAA" batteries into the battery compartment. Replace the battery cover.

## HOW TO ADJUST THE HEADBAND

For the pulse sensor to function properly, the headband must fit snugly around your head, without being uncomfortable. To adjust the headband, insert the adjustment

tab through the appropriate hole in the headband. Note: Each time you exercise, the headband may expand slightly during the first few minutes

of use. It may be necessary to readjust the headband periodically.

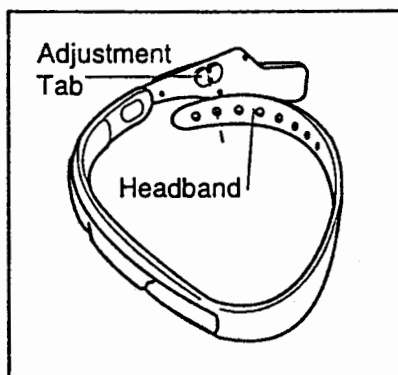

## HOW TO PUT ON THE PULSE SENSOR

Rub your forehead briefly to stimulate circulation. Put on the headband as shown at the top of this page. Make sure that the sensor window is centered on your

forehead, and that there is no hair between the sensor window and your forehead.

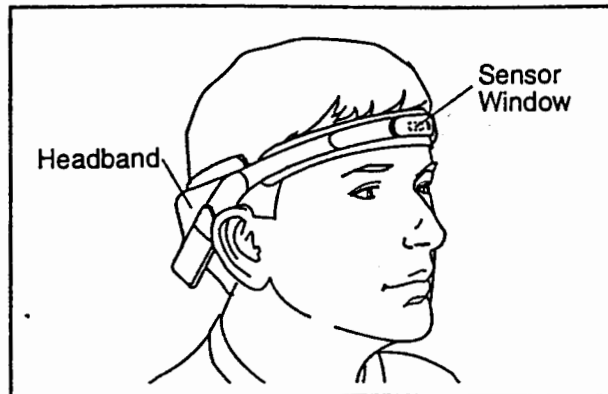

## PROPER ORIENTATION OF THE PULSE SENSOR

The transmitter on the pulse sensor is angled downward, as shown below. For the pulse sensor to function properly, the transmitter must be pointed within 30° of the center of the console (the shaded area in the drawing). If you turn your head too far away from the console, the signal from the pulse sensor will not be received.

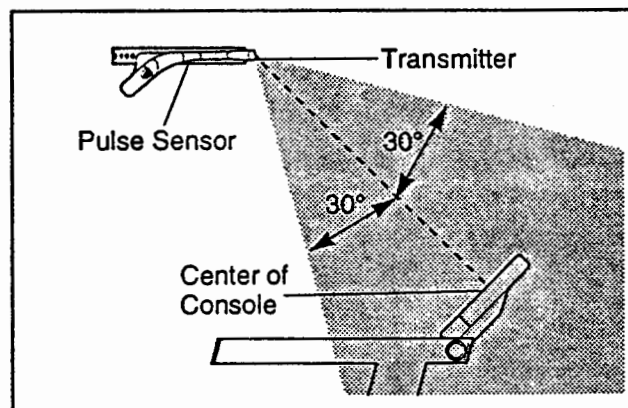

## GUIDELINES FOR OBTAINING ACCURATE PULSE READINGS

The instructions on page 11 explain how the pulse sensor is used with the console (see HOW TO USE THE PULSE DISPLAY). For the best results, remember the following important guidelines:

1. Before putting on the headband, rub your forehead for a moment to stimulate circulation.
2. Make sure that the headband fits snugly around your head, without being uncomfortable. If the headband is too loose or too tight, your pulse may not be detected.

3. The headband must be worn with the sensor window centered on your forehead (see HOW TO PUT ON THE PULSE SENSOR on page 7). The small button next to the sensor window must be depressed. Make sure that there is no hair in front of the pulse sensor or between the sensor window and your forehead. Make-up applied to the forehead may also interfere with pulse readings.

Note: If the pulse sensor does not detect your pulse when the sensor window is centered on your forehead, try positioning the sensor window above your right or left eyebrow. Depending on the shape of your forehead, your pulse may be detected more easily from a slightly different position.

4. Avoid turning your head more than 30° away from the console, or the console may not pick up the signal from the pulse sensor.
5. The sensor window should be cleaned weekly when the treadmill is used regularly. Moisten a cotton swab with water, and carefully wipe the sensor window.
6. Because your pulse constantly changes, the pulse sensor will sample and average your pulse every few seconds. When you first put on the pulse sensor, it may take up to ten seconds before an accurate pulse is shown.
7. If the pulse sensor does not function properly, check the batteries (see HOW TO INSTALL BATTERIES on page 7).

#### HOW TO SOLVE COMMON PULSE PROBLEMS

1. If you are wearing the pulse sensor and the **NO PULSE DETECTED** indicator lights:

See guidelines 2, 3, 4, 5, 6, and 7 on page 7 and this page.

2. If the pulse shown in the **PULSE** display seems excessively high or low:

See guideline 6 on this page.

3. If error code **"E5"** appears in the **PULSE** display:

See guidelines 2, 3, 4, 5, 6, and 7 on page 7 and this page.

4. If the letters **"PLS"** appear in the **PULSE** display:

See guidelines 2, 3, 4, 5, 6, and 7 on page 7 and this page.

#### HOW TO CLEAN THE PULSE SENSOR AND HEADBAND

To clean the pulse sensor, first remove the headband. Wipe the pulse sensor clean with a damp cloth. **Never immerse the pulse sensor in water.** To clean the headband, hand wash it in mild detergent, gently wring it out, and allow it to air dry.

# OPERATION AND ADJUSTMENT

## THE PERFORMANT LUBE™ WALKING BELT

Your treadmill features a walking belt coated with PERFORMANT LUBE™, a high-performance lubricant.

**IMPORTANT:** Never apply silicone spray or other substances to the walking belt or the walking platform. They will deteriorate the walking belt and cause excessive wear.

## HOW TO PLUG IN THE POWER CORD

**⚠ DANGER:** Improper connection of the equipment-grounding conductor can result in an increased risk of electric shock. Check with a qualified electrician or serviceman if you are in doubt as to whether the product is properly grounded. Do not modify the plug provided with the product—if it will not fit the outlet, have a proper outlet installed by a qualified electrician.

Your treadmill, like any other type of sophisticated electronic equipment, can be seriously damaged by sudden voltage changes in your home's power. Voltage surges, spikes, and noise interference can result from weather conditions or from other appliances being turned on or off. To decrease the possibility of your treadmill being damaged, always use a surge protector (not included) with your treadmill.

Surge protectors are sold at most hardware stores and department stores. Use only a UL-listed surge protector, rated at 15 amps, with a 14-gauge cord of five feet or less in length. This product must be grounded. If it should malfunction or break down, grounding provides a path of least resistance for electric current to reduce the

risk of electric shock. This product is equipped with a cord having an equipment-grounding conductor and a grounding plug. Plug the power cord into a surge protector, and plug the surge protector into an appropriate outlet that is properly installed and grounded in accordance with all local codes and ordinances.

This product is for use on a nominal 120-volt circuit, and has a grounding plug that looks like the plug illustrated in drawing 1 below. A temporary adapter that looks like the adapter illustrated in drawing 2 may be used to connect the surge protector to a 2-pole receptacle as shown in drawing 2 if a properly grounded outlet is not available.

The temporary adapter should be used only until a properly grounded outlet (drawing 1) can be installed by a qualified electrician.

The green-colored rigid ear, lug, or the like extending from the adapter must be connected to a permanent ground such as a properly grounded outlet box cover. Whenever the adapter is used it must be held in place by a metal screw. Some 2-pole receptacle outlet box covers are not grounded. Contact a qualified electrician to determine if the outlet box cover is grounded before using an adapter.

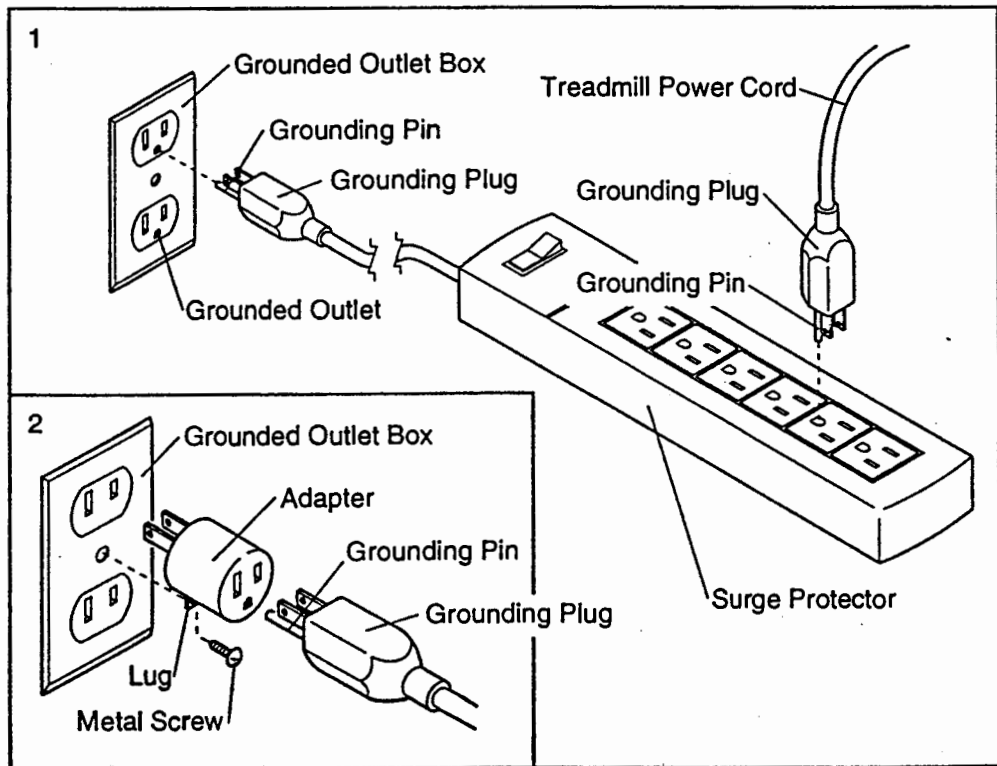

## DIAGRAM OF THE CONSOLE

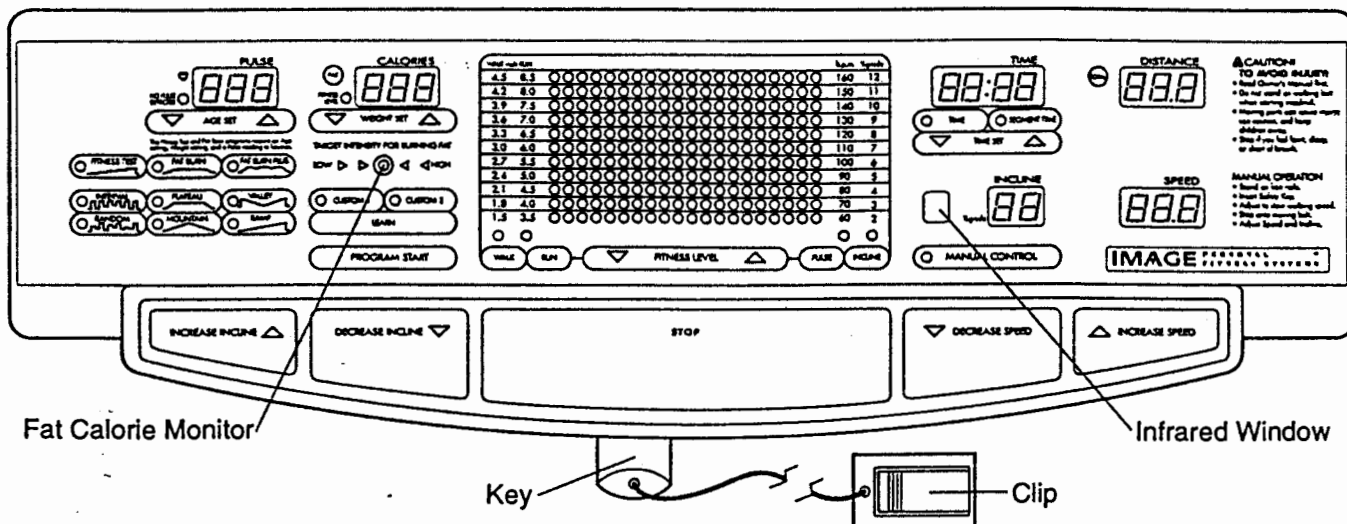

## THE FEATURES OF THE CONSOLE

The treadmill console offers an impressive array of features to make your workouts more effective and enjoyable. In the manual mode, the speed and incline of the treadmill can be changed with a touch of a button. As you exercise, six displays will provide continuous exercise feedback. If your goal is to burn fat, the built-in Fat Calorie Monitor will show you when your exercise intensity is too low, too high, or perfect for burning fat. In the program mode, the console offers six preset workout programs and two special fat burning programs, each designed to guide you through a different type of workout. In addition, there is a unique FITNESS TEST program that measures your relative fitness level. You can even create your own workout programs, and save them in the console's memory.

Carefully read these instructions before operating the console. Note: If there is a thin sheet of clear plastic on the face of the console, peel it off.

### HOW TO TURN ON THE POWER

If the key is in the console, remove it. Make sure that the on/off switch located near the power cord is in the "on" position.

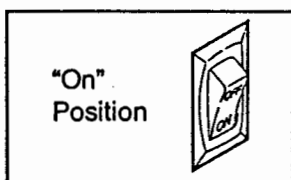

Plug in the power cord (see HOW TO PLUG IN THE POWER CORD on page 9). All displays and indicators will flash three times. Note: If the key is in the console when the power cord is plugged in, the letters "PO" will flash in the SPEED display. If this occurs, remove the key.

Stand on the foot rails of the treadmill. Find the clip attached to the key, and slide the clip onto the waistband of your clothing. Always stand on the foot rails

when turning on the power or starting the walking belt. Always wear the clip while exercising.

Insert the key into the console. The NO PULSE DETECTED indicator, the MANUAL CONTROL indicator, the TIME indicator, and the six displays will light. The PULSE display will flash the letters "AGE" three times, and the CALORIES display will flash the letters "LbS" (pounds) three times.

### HOW TO ENTER YOUR AGE AND WEIGHT

For some of the console's features to function properly, your age and weight must be entered into the console. If you have not entered your age and weight, follow the instructions below.

Press one of the AGE SET buttons. The letters "AGE" will flash in the PULSE display. Press the AGE SET buttons again to enter your age. The first time one of the buttons is pressed, the current age setting will be shown. The age setting will then change by 1 year each time one of the buttons is pressed. If one of the buttons is held down, the age setting will change in increments of 5 years.

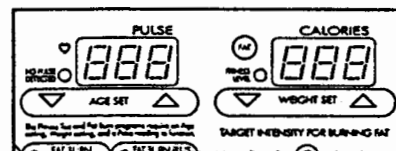

After you have entered your age, press the WEIGHT SET buttons to enter your weight. The first time one of the buttons is pressed, the current weight setting will be shown in the CALORIES display. The weight setting will then change by 1 pound each time one of the buttons is pressed. If one of the buttons is held down, the weight setting will change in increments of 5 pounds.

Once you have entered your age and weight, they will be saved in the console's memory, even if the power cord is unplugged.

**CAUTIONS TO AVOID INJURY**  
 • Read Owner's Manual first.  
 • Do not stand on walking belt when starting treadmill.  
 • Moving parts can cause injury.  
 • Do not touch the treadmill while it is running.  
 • Do not touch the treadmill when it is stopped.

**MANUAL OPERATION**  
 • Stand on foot rails.  
 • Insert Safety Key.  
 • Adjust to slow walking speed.  
 • Stop exercise moving belt.  
 • Adjust Speed and Incline.

# MANUAL MODE OPERATION

## HOW TO CONTROL THE SPEED

When the power is turned on, the console will be in the manual mode. For your safety, the walking belt will be stationary.

The speed range of the treadmill is 0.5 to 10 miles per hour. The speed is controlled with the INCREASE

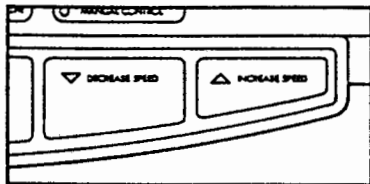

SPEED and DECREASE SPEED buttons. Each time one of the buttons is pressed, the speed will change by 0.1 mph. The buttons can be held down to change the speed rapidly.

**WARNING:** After the SPEED buttons are pressed, it will take a moment for the walking belt to reach the selected speed setting. Adjust the speed in small increments until you are familiar with the treadmill.

Press the INCREASE SPEED button until the walking belt is moving at slow speed. Hold the handrails and step carefully onto the walking belt. Change the speed of the walking belt as desired by pressing the INCREASE SPEED and DECREASE SPEED buttons. To stop the walking belt, press the STOP button.

## HOW TO CONTROL THE INCLINE

The incline range of the treadmill is 1% to 12%. The incline is controlled with the INCREASE INCLINE and

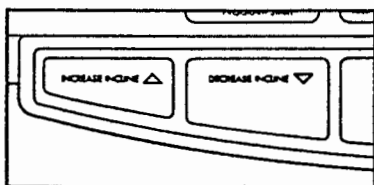

DECREASE INCLINE buttons. Each time one of the buttons is pressed, the incline will change by 0.5%. The buttons can be held down to change the incline rapidly.

Note: After the INCLINE buttons are pressed, it will take a few seconds for the treadmill to reach the selected incline setting. Because the INCLINE display has two digits, the display will show 10% when the incline is set at either 10% or 10.5%, and 11% when the incline is set at either 11% or 11.5%.

## HOW TO USE THE PULSE DISPLAY

Put on the pulse sensor (see HOW TO USE THE PULSE SENSOR on page 7). After a few seconds, the

heart-shaped indicator beside the PULSE display will flash each time your heart beats, the NO PULSE DETECTED indicator will darken, and your pulse will be shown. Note: Because your pulse constantly changes, the pulse sensor will sample and average your pulse every few seconds. *It may take up to ten seconds before an accurate pulse is shown.* If your pulse is not shown, see GUIDELINES FOR OBTAINING ACCURATE PULSE READINGS on page 7.

## HOW TO USE THE CALORIES DISPLAY

For the CALORIES display to be accurate, your age and weight must be entered into the console. If you have not entered your age and weight, see HOW TO ENTER YOUR AGE AND WEIGHT on page 10. The CALORIES display will show the approximate number of calories you have burned.

To find the number of fat calories you have burned (see BURNING FAT on page 22), press the FAT button beside the CALORIES display. The approximate number of fat calories you have burned will be shown for three seconds.



## HOW TO USE THE TIME DISPLAY

The TIME display will show how long the walking belt has been moving.

If desired, a time goal can be set. First, stop the walking belt. Press the TIME SET buttons to set the length of time that you plan

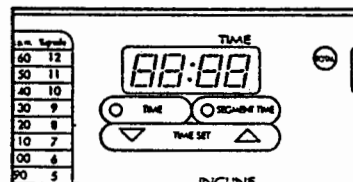

to exercise. Each time one of the buttons is pressed, the time goal will change by 10 seconds. If one of the buttons is held down, the time goal will change in increments of 1 minute. As you exercise, the time will be counted down. When no time remains, the walking belt will slow to a stop. Note: The purpose of the SEGMENT TIME button will be explained later. If the FITNESS TEST program is selected, the TIME display will be reset to zero. The display will be reset again when the program is completed.

## HOW TO USE THE DISTANCE DISPLAY

The DISTANCE display will show the distance that you have walked or run, in miles. Note: If the FITNESS TEST program is selected, the DISTANCE display will be reset to zero. The display will be reset again when the program is completed.

The console also keeps track of the total number of miles accumulated since the treadmill was purchased. To find this number, press the TOTAL button beside the DISTANCE display. The total number of miles will be shown for three seconds. Note: When the total exceeds 999 miles, the DISTANCE display will be reset to zero.

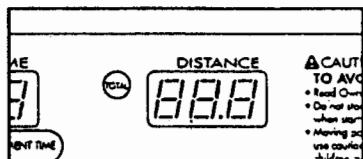

## HOW TO USE THE FAT CALORIE MONITOR

If you want to burn fat, the built-in Fat Calorie Monitor is designed to help you reach your goal. As you exercise, your body can burn either *fat calories* or *carbohydrate calories*, depending on the intensity of your exercise (see BURNING FAT on page 22). The Fat Calorie Monitor will show you when your exercise intensity is too low, too high, or perfect for burning fat.

For the Fat Calorie Monitor to be accurate, your age and weight must be entered into the console. If you have not entered your age and weight, see HOW TO ENTER YOUR AGE AND WEIGHT on page 10. In addition, the pulse sensor must be worn (see HOW TO USE THE PULSE DISPLAY on page 11).

As you exercise, one of the five indicators above the CUSTOM 1 and CUSTOM 2 buttons will light.

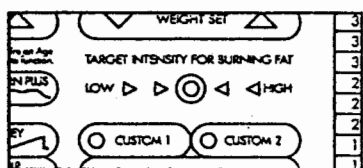

The two red indicators on the left indicate that your intensity is too low for burning fat effectively. The two red indicators on the right indicate that your intensity is too high for burning fat effectively. When your intensity is perfect for burning fat, the green indicator in the center will light. Adjust the speed or incline of the treadmill so that the green indicator remains lit. *Note: After adjusting the speed or incline, wait for about one minute before adjusting the speed or incline again. This will allow time for your pulse to respond to the new speed or incline setting.*

## PROGRAM MODE OPERATION

When the console is in the program mode, you can choose any of six preset workout programs, each designed to guide you through a different type of workout. If your goal is to burn fat, two additional programs are included just for you—the FAT BURN and FAT BURN PLUS programs. Or, you can select the unique FITNESS TEST program, and measure your relative fitness level. You can even create your own custom workout programs, and save them in the console's memory.

### HOW TO USE A PRESET WORKOUT PROGRAM

1. Select one of the preset level workout programs

Press the INTERVAL, PLATEAU, VALLEY, RANDOM, MOUNTAIN, or RAMP button.

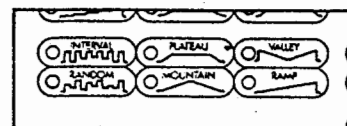

The indicator on the button you press will light. Note: If the walking belt is moving, it will slow to a stop.

2. Select one of the modes (WALK, RUN, INCLINE, WALK/INCLINE, or RUN/INCLINE)

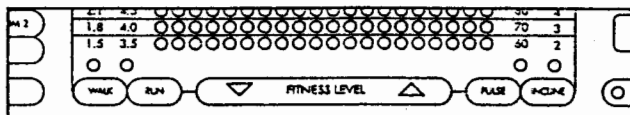

When a preset workout program is selected, the WALK and INCLINE indicators will light. When both the WALK and INCLINE modes are selected, the console will automatically control *both the speed and incline* of the treadmill during the program, and the speed range will be 1.5 to 4.5 mph. If you want the speed range to be 3.5 to 8.5 mph, press the RUN button. The WALK indicator will darken, and the RUN indicator will light.

If you want the console to automatically control *only the speed* of the treadmill during the program, press the INCLINE button. The INCLINE indicator will darken. (The incline can then be controlled manually during the program with the INCREASE INCLINE and DECREASE INCLINE buttons).

If you want the console to automatically control *only the incline* of the treadmill during the program, press the WALK, RUN, and INCLINE buttons until only the INCLINE indicator is lighted. (The speed can then be controlled manually during the program with the INCREASE SPEED and DECREASE SPEED buttons).

*Note: To select the PULSE mode, see HOW TO USE THE PULSE MODE on page 13.*

### 3. The program settings

Each program is divided into twenty equal time periods, called segments. One speed setting and/or one incline setting (depending on which mode[s] you selected) are programmed for each segment. The speed and/or incline settings of the program you have selected are shown in the columns of indicators in the center of the console. The setting(s) of the first segment are shown in the far left column, and the setting(s) of the twentieth segment are shown in the far right column.

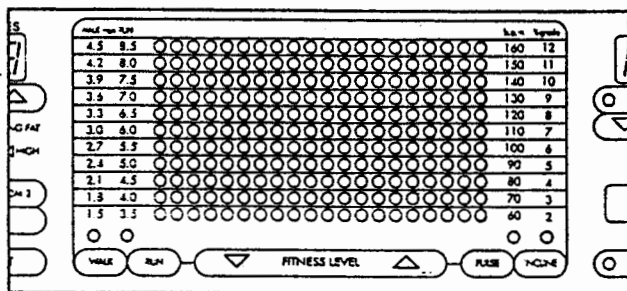

If you selected the WALK or RUN mode, red indicators will show the speed setting of each segment. If you selected the INCLINE mode, green indicators will show the incline setting of each segment. If you selected the WALK and INCLINE modes or the RUN and INCLINE modes, both red and green indicators will be lit.

### 4. Adjust the difficulty level of the program

If desired, the difficulty level of the program can be adjusted with the FITNESS LEVEL buttons (see the drawing above). Each time the FITNESS LEVEL increase button is pressed, the speed and/or incline settings of all segments will increase. Each time the FITNESS LEVEL decrease button is pressed, the speed and/or incline settings of all segments will decrease. Note: The difficulty level of the program can be increased only until the highest indicator in any of the columns is lit, and decreased only until the lowest indicator in any of the columns is lit.

### 5. Set the program time

The program is set to last for 20 minutes, as shown in the TIME display. The length of time can be changed, if desired, with the TIME SET buttons. Each time one of the buttons is pressed, the length of time will change by 20 seconds. If one of the buttons is held down, the length of time will change in increments of 1 minute. The program can be set to last for a minimum of 5 minutes, up to a maximum of 80 minutes. (If the SEGMENT TIME but-

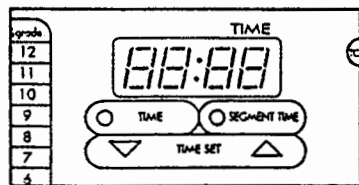

ton is pressed, the TIME display will show how many seconds *each of the twenty segments* will last.)

### 6. Start the program

Stand on the foot rails of the treadmill and press the PROGRAM START button. The first column of indicators will begin to flash, and the treadmill will automatically adjust to the speed and/or incline setting(s) of the first segment. Carefully step onto the walking belt and begin exercising. Note: If you selected the INCLINE mode, the walking belt will begin to move at 1.0 mph. The speed can then be controlled during the program with the INCREASE SPEED and DECREASE SPEED buttons. If you selected the WALK or RUN mode, the incline can be controlled with the INCREASE INCLINE and DECREASE INCLINE buttons.

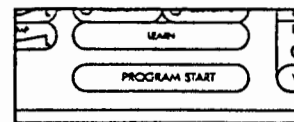

The time remaining in the program will be shown in the TIME display. (If the SEGMENT TIME button is pressed, the number of seconds remaining in the first segment will be shown). During the last three seconds of the first segment, the TIME display will flash three times. When the first segment is completed, the second column of indicators will begin to flash, and the treadmill will automatically adjust to the speed and/or incline setting(s) of the second segment. The program will continue until the twentieth column is flashing and no time remains. The walking belt will then slow to a stop.

Note: During the program, the difficulty level of the program can be adjusted with the FITNESS LEVEL buttons. The length of time that the program will last can be changed with the TIME SET buttons. The program can be stopped at any time with the STOP button. The console will then be in the same state as if the program had been completed.

### HOW TO USE THE PULSE MODE

**WARNING:** If you have heart problems, or if you are over 60 years of age and have been inactive, *do not use the PULSE mode.* If you are taking medication regularly, consult your physician to find whether the medication will affect your exercise heart rate before using the PULSE mode.

### 1. Select the PLATEAU program

Press the PLATEAU button. The indicator on the button will light. Note: If the walking belt is moving, it will slow to a stop.

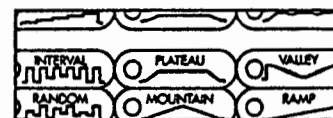

## 2. Select the PULSE mode

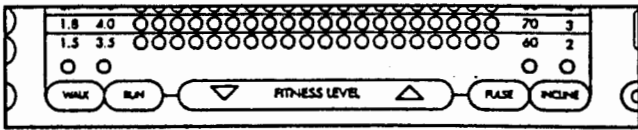

Press the PULSE button. The PULSE indicator will light, and the WALK, RUN and INCLINE indicators will darken.

When the PULSE mode is selected, the letters "AGE" will flash in the PULSE display, and the letters "Lbs" will flash in the CALORIES display.

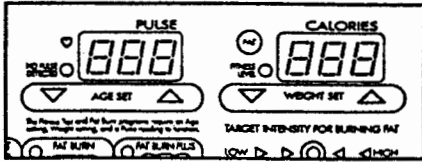

If you have not entered your age and weight into the console, see HOW TO ENTER YOUR AGE AND WEIGHT on page 10. If you have already entered your age and weight, simply press one of the AGE SET buttons, and then press one of the WEIGHT SET buttons.

## 3. Put on the pulse sensor

See HOW TO USE THE PULSE DISPLAY on page 11.

## 4. The program settings

Each program is divided into twenty equal time periods, called segments. One pulse setting is programmed for each segment. The pulse settings of the program you have selected are shown in the columns of indicators in the center of the console. Red indicators will show the pulse setting of each segment.

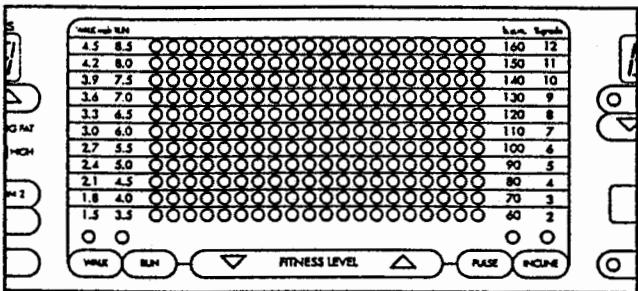

## 5. Adjust the difficulty level of the program

If desired, the difficulty level of the program can be adjusted with the FITNESS LEVEL buttons (see the drawing above). Each time the FITNESS LEVEL increase button is pressed, the pulse settings of all segments will increase. Each time the FITNESS LEVEL decrease button is pressed, the pulse settings of all segments will decrease. Note: The difficulty level of the program can be increased only until the highest indicator in one of the columns is lit, and decreased

only until the lowest indicator in one of the columns is lit. In addition, there may be a limit to how far the difficulty level can be adjusted depending on your age.

**WARNING:** Do not increase the pulse settings more than 30 beats per minute.

## 6. Set the program time

The program is set to last for 20 minutes, as shown in the TIME display. The program can be set to last for different length

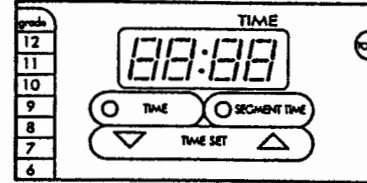

of time, if desired, with the TIME SET buttons. Each time one of the buttons is pressed, the length of time will change by 20 seconds. If one of the buttons is held down, the length of time will change in increments of 1 minute. The program can be set to last for a minimum of 20 minutes, up to a maximum of 80 minutes. (If the SEGMENT TIME button is pressed, the TIME display will show how many seconds each of the twenty segments will last.)

## 7. Start the program

Stand on the foot rails of the treadmill and press the PROGRAM START button. The first column of indicators will

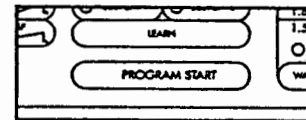

begin to flash. When the walking belt begins to move, carefully step onto the walking belt and begin exercising. The console will automatically change the speed and/or incline of the treadmill at any time to keep your pulse near the setting of the first segment. The SPEED or INCLINE display will flash three times to warn you each time the speed or incline is about to change.

The time remaining in the program will be shown in the TIME display. (If the SEGMENT TIME button is pressed, the number of seconds remaining in the current segment will be shown). During the last three seconds of the first segment, the TIME display will flash three times. When the first segment is completed, the second column of indicators will begin to flash. The console will then change the speed and/or incline of the treadmill at any time to keep your pulse near the setting of the second segment. The program will continue until the twentieth column is flashing, and no time remains. The walking belt will then slow to a stop.

Note: During the program, the difficulty level of the program can be adjusted with the FITNESS LEVEL buttons. The speed of the treadmill can be changed with the INCREASE SPEED and DECREASE SPEED buttons. The incline of the treadmill can be changed

with the INCREASE INCLINE and DECREASE INCLINE buttons. However, if you increase the speed, the incline will automatically decrease; if you decrease the speed, the incline will automatically increase. The console will always attempt to keep your pulse near the setting of the current segment. If your pulse is not detected for one minute, the speed of the treadmill will automatically decrease by half. If your pulse is not detected for a second minute, the speed will decrease by half again. If your pulse is not detected for three minutes, the walking belt will slow to a stop. The program can be stopped at any time with the STOP button. The console will then be in the same state as if the program had been completed.

## HOW TO USE THE FAT BURN AND FAT BURN PLUS PROGRAMS

### 1. Select the FAT BURN or FAT BURN PLUS program

Press the FAT BURN or FAT BURN PLUS button. The indicator on the button you press will light. Note: If the walking belt is moving, it will slow to a stop.

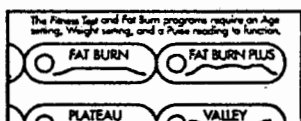

When the FAT BURN or FAT BURN PLUS button is pressed, the

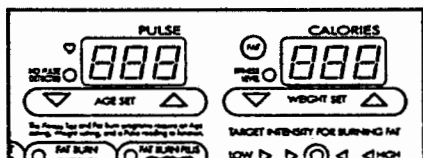

letters "AGE" will flash in the PULSE display, and the letters "LbS" will flash in the CALORIES display. If you have not entered your age and weight into the console, see HOW TO ENTER YOUR AGE AND WEIGHT on page 10. If you have already entered your age and weight, simply press one of the AGE SET buttons, and then press one of the WEIGHT SET buttons.

When the FAT BURN or FAT BURN PLUS program is selected, the WALK and INCLINE indicators will light. During these programs, the console will automatically control the speed and incline of the treadmill, and the speed range will be 1.5 to 4.5 mph. The RUN and PULSE modes cannot be selected.

Each program is divided into twenty equal time periods, called segments. One speed setting and one incline setting are programmed for each segment. The speed and incline settings of the program you have selected are shown in the columns of indicators in the center of the console. Red indicators will show the speed setting of each segment, and green indicators will show the incline setting of each segment. The speed and incline settings are optimal for maximum fat burning. The difficulty level of the program cannot be changed with the FITNESS LEVEL buttons.

The FAT BURN program is set to last for 40 minutes, as shown in the TIME display. (If the SEGMENT TIME button is pressed, the TIME display will show that each segment is set to last for 120 seconds.) The FAT BURN PLUS program is set to last for 60 minutes. (Each segment is set to last for 180 seconds.) The time settings of these programs cannot be changed.

### 2. Start the program

Stand on the foot rails of the treadmill and press the PROGRAM START button. The first column of indicators

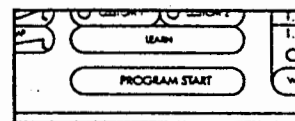

will begin to flash, and the treadmill will automatically adjust to the speed and incline settings of the first segment. Carefully step onto the walking belt and begin exercising.

The time remaining in the program will be shown in the TIME display. (If the SEGMENT TIME button is pressed, the number of seconds remaining in the first segment will be shown). During the last three seconds of the first segment, the TIME display will flash three times. When the first segment is completed, the second column of indicators will begin to flash, and the treadmill will automatically adjust to the speed and incline settings of the second segment. The program will continue in this manner until the twentieth column is flashing and no time remains. The walking belt will then slow to a stop.

Note: The program can be stopped at any time with the STOP button. The console will then be in the same state as if the program had been completed.

## HOW TO USE THE FITNESS TEST PROGRAM

The FITNESS TEST program is designed to measure your relative fitness level. For the best results, take the FITNESS TEST at a time when your energy level is high. The FITNESS TEST should not be taken after you have already exercised during the day.

The FITNESS TEST consists of seven 3-minute segments, and is followed by a 1-minute cool-down period. The console will automatically control the speed and incline of the treadmill during the FITNESS TEST. The speed and incline settings cannot be adjusted.

### 1. Select the FITNESS TEST program

Press the FITNESS TEST button. The indicator on the button will light. Note: If the walking belt is moving, it will slow to a stop.

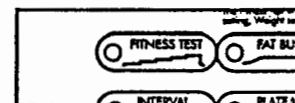

When the **FITNESS TEST** button is pressed, the letters "AGE" will

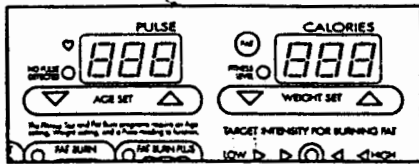

flash in the PULSE display, and the letters "LbS" will flash in the CALORIES display. For the **FITNESS TEST** to operate properly, your age and weight must be entered into the console. If you have not entered your age and weight, see **HOW TO ENTER YOUR AGE AND WEIGHT** on page 10. If you have already entered your age and weight, simply press one of the **AGE SET** buttons, and then press one of the **WEIGHT SET** buttons. Note: If the **PROGRAM START** button is pressed before you have entered your age and weight, the words "SET AGE AND WEIGHT" will move across the center of the console.

The **CALORIES**, **TIME** and **DISTANCE** displays will be reset to zero.

## 2. Put on the pulse sensor

See **HOW TO USE THE PULSE DISPLAY** on page 11. Note: If the **PROGRAM START** button is pressed before your pulse is shown, the letters "PLS" will flash in the PULSE display, and the words "ADJUST PULSE SENSOR" will move across the center of the console.

## 3. Start the FITNESS TEST program

Stand on the foot rails of the treadmill and press the **PROGRAM START** button. The **CALORIES** display will show "L 1," indicating that the first segment of the **FITNESS TEST** has begun. The incline of the treadmill will automatically adjust to 2.0%, and the walking belt will begin to move at 1.5 mph. Step onto the walking belt and begin exercising.

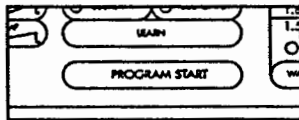

When the **TIME** display reaches 3 minutes, the **CALORIES** display will show "L 2," indicating that the second segment has begun. The incline will increase to 3%, and the speed will increase to 2.0 mph. The **FITNESS TEST** will continue in this manner until your pulse reaches 70% of your maximum heart rate, and the current segment is completed. *The FITNESS TEST will then be completed, regardless of how many segments remain.*

When the **FITNESS TEST** is completed, the letter "C" will be shown in the **CALORIES** display, indicating that the cool-down period has begun. The words "COOL DOWN" will move across the center of the console, and the **TIME** display will count down 1 minute.

When the cool-down period is completed, the walking belt will slow to a stop and the words "FITNESS TEST COMPLETE" will move across the center of the console. The **FITNESS LEVEL** indicator will light, and your fitness level will be shown in the **CALORIES** display. There are ten fitness levels—fitness level 10 (FL10) is the highest fitness level. *Remember, the Fitness Test is intended only to indicate your relative fitness level.*

Note: If at any time during the program your pulse is not detected, the letters "PLS" will flash in the PULSE display, and the words "ADJUST PULSE SENSOR" will move across the center of the console. If your pulse is not detected during the last thirty seconds of any segment, the walking belt will slow to a stop and the words "PULSE SIGNAL LOST" will move across the center of the console. The **FITNESS LEVEL** indicator will light, and the **CALORIES** display will show an estimated fitness level. The **FITNESS TEST** can be stopped at any time by pressing the **STOP** button. The words "FITNESS TEST HALTED" will move across the center of the console, and the **CALORIES** display will show an estimated fitness level. The console will then be in the **MANUAL CONTROL** mode.

## HOW TO CREATE CUSTOM WORKOUT PROGRAMS

When the console is in the program mode, you can create custom workout programs, and save them in the console's memory for future workouts. Two different custom programs can be saved at the same time, and the custom programs can be changed as many times as desired. Follow the instructions below to create a custom program.

### 1. Select one of the custom workout programs

Press the **CUSTOM 1** or **CUSTOM 2** button. (One custom program can be created using each button.) The indicator on the button you press will light. Note: If the walking belt is moving, it will slow to a stop.

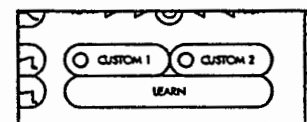

### 2. Select the WALK or RUN mode

When a custom program is selected, the **WALK** and **INCLINE** indicators will light. The console will automatically control the speed and incline of the treadmill during the program, and the speed range will be 1.5 to 4.5 mph. If you want the speed range to be 3.5 to 8.5 mph, press the **RUN** button. The **WALK** indicator will darken, and the **RUN** indicator will light. *Note: No other modes can be selected. If you press the PULSE button, the PLATEAU program will be selected.*

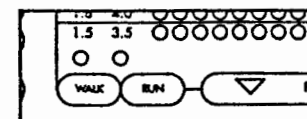

### 3. Press the LEARN button

When the learn button is pressed, the indicator on the CUSTOM 1 or CUSTOM 2 button will begin to flash.

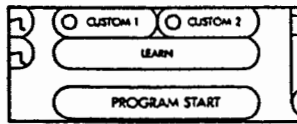

### 4. Set the program time

Press the TIME SET buttons to set the length of time that you want the program to last. Each time one of the buttons

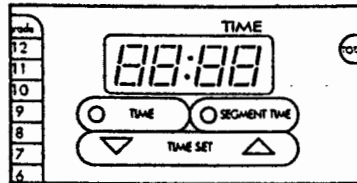

is pressed, the length of time shown in the TIME display will change by 20 seconds. If one of the buttons is held down, the length of time will change in increments of 1 minute. The program can be set to last for a minimum of 5 minutes, up to a maximum of 80 minutes. (If the SEGMENT TIME button is pressed, the TIME display will show how many seconds *each of the twenty segments* will last.)

### 5. Start the program

Stand on the foot rails of the treadmill and press the PROGRAM START button. When the walking belt begins to move, carefully step onto the walking belt and begin exercising.

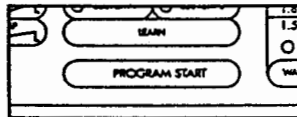

### 6. Program speed and incline settings

Each program is divided into twenty equal time periods, called segments. One speed setting and one incline setting can be programmed for each segment. The speed and incline settings will be shown in the columns of indicators in the center of the console.

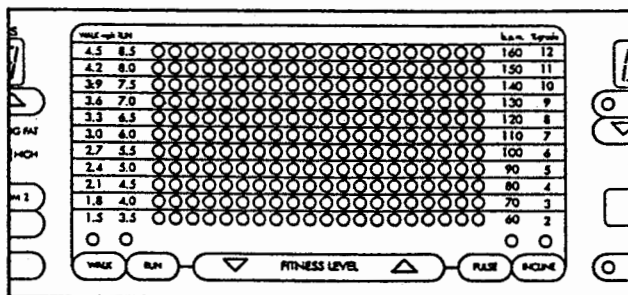

The settings of the first segment will be shown in the far left column, and the settings of the twentieth segment will be shown in the far right column. Red indicators will show the speed setting of each segment, and green indicators will show the incline setting of each segment.

The first column of indicators will be flashing. Program the desired speed setting for the first segment with the INCREASE SPEED and DECREASE SPEED buttons. (Note: If you selected the WALK mode, the speed setting will change in increments of 0.3 mph; if you selected the RUN mode, the speed setting will change in increments of 0.5 mph.) Select the desired incline setting for the first segment with the INCREASE INCLINE and DECREASE INCLINE buttons.

The time remaining in the program will be shown in the TIME display. (If the SEGMENT TIME button is pressed, the number of seconds remaining in the first segment will be shown). During the last three seconds of the first segment, the TIME display will flash three times. When the first segment is completed, the current speed and incline settings will be saved in memory.

When the first segment is completed, the second column of indicators will begin to flash. Program a speed setting and an incline setting for the second segment as described above. When the second segment is completed, the current speed and incline settings will be saved in memory. The program will continue in this manner until the twentieth segment is flashing and no time remains. The walking belt will then slow to a stop.

After the program is completed, one speed setting and one incline setting will be programmed for each of the twenty segments. The speed and incline settings will be saved in the console's memory. To use the program for future workouts, follow the instructions below.

### HOW TO USE A CUSTOM WORKOUT PROGRAM

#### 1. Select one of the custom workout programs

Press the CUSTOM 1 or CUSTOM 2 button. The indicator on the button you press will light. Note: If the walking belt is moving, it will slow to a stop.

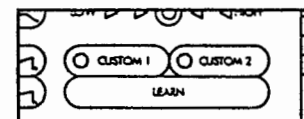

#### 2. Select the WALK or RUN mode

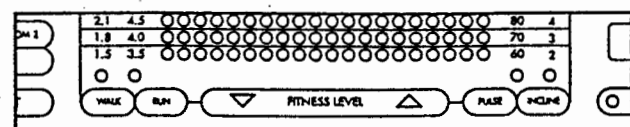

When a custom program is selected, the WALK and INCLINE indicators will light. The console will automatically control the *speed and incline* of the treadmill during the program, and the speed range will be 1.5 to 4.5 mph. If you want the speed range to be 3.5 to 8.5 mph, press the RUN button. The WALK indicator will darken, and the RUN indicator will light. *Note: No other modes can be selected. If you press the PULSE button, the PLATEAU program will be selected.*

### 3. The program settings

The speed and incline settings of the program you have selected will be shown in the columns of indicators in the center of the console. Red indicators will show the speed setting of each segment, and green indicators will show the incline setting of each segment.

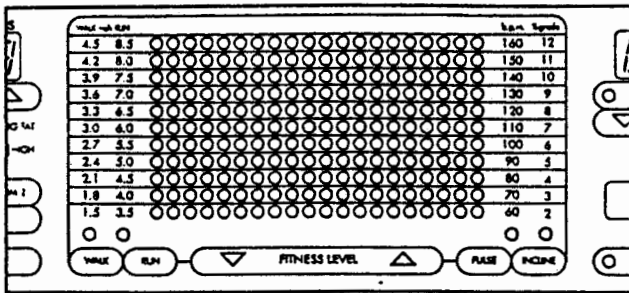

### 4. Adjust the difficulty level of the program

If desired, the difficulty level of the program can be adjusted with the FITNESS LEVEL buttons (see the drawing above). Each time the FITNESS LEVEL increase button is pressed, the speed and incline settings of all segments will increase. Each time the FITNESS LEVEL decrease button is pressed, the speed and incline settings of all segments will decrease. Note: The difficulty level of the program can be increased only until the highest indicator in one of the columns is lit, and decreased only until the lowest indicator in one of the columns is lit.

### 5. Adjust the program time

The length of time the program will last can be adjusted, if desired, with the TIME SET buttons. Each time one of the buttons is pressed, the length of time will change by 20 seconds. If one of the buttons is held down, the length of time will change in increments of 1 minute. The program can be set to last for a minimum of 5 minutes, up to a maximum of 80 minutes. (If the SEGMENT TIME button is pressed, the TIME display will show how many seconds each of the twenty segments will last.)

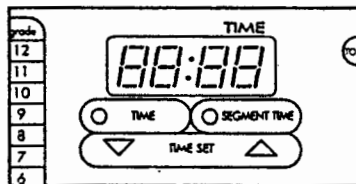

### 6. Start the program

Stand on the foot rails of the treadmill and press the PROGRAM START button. The first column of indicators will begin to flash, and the treadmill will automatically adjust to the speed and incline settings of the first segment.

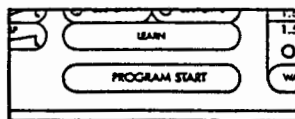

Step onto the walking belt and begin exercising. The time remaining in the program will be shown in the TIME display. (If the SEGMENT TIME button is pressed, the number of seconds remaining in the first segment will be shown). During the last three seconds of the first segment, the TIME display will flash three times. When the first segment is completed, the second column of indicators will begin to flash, and the treadmill will automatically adjust to the speed and incline settings of the second segment. The program will continue in this manner until the twentieth column is flashing and no time remains. The walking belt will then slow to a stop.

Note: During the program, the difficulty level of the program can be adjusted with the FITNESS LEVEL buttons. The length of time that the program will last can be changed with the TIME SET buttons. The program can be stopped at any time with the STOP button. The console will then be in the same state as if the program had been completed.

Note: Although the difficulty level of the program can be adjusted, only the original speed and incline settings will be saved in memory. If you desire to change the original speed and incline settings, see HOW TO CREATE CUSTOM WORKOUT PROGRAMS on page 16.

### HOW TO TURN OFF THE POWER

To turn off the power, remove the key from the console. Store the key in a secure location.

In addition, move the on/off switch to the "off" position. (See the drawing near the bottom of page 10.)

### HOW TO SELECT THE INFORMATION MODE

The console features an information mode that keeps track of trip time and distance, as well as the total time and distance accumulated.

To select the information mode, hold down the STOP button while inserting the key into the console. The indicator on the SEGMENT TIME button will light, and the trip time and distance will be shown in the TIME and DISTANCE displays. (Note: If the distance exceeds 999 miles, the thousands digits will be shown in the SPEED display.) If desired, the trip time and distance can be reset to zero by pressing the TIME SET decrease button.

To view the total time and distance, press the TIME button. The total time and distance will then be shown. The total time and distance cannot be reset.

Note: The PULSE display will show the letter "I," indicating that the console is set for an infrared (cordless) pulse sensor.

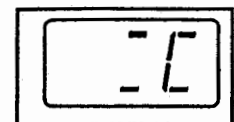

Do not press the AGE SET decrease button, or the setting will change to the letter "C," for a corded pulse sensor.

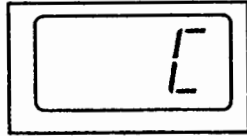

The setting can be changed back by pressing the button again.

To exit the information mode, remove the key.

#### HOW TO ADJUST THE ANGLE OF THE CONSOLE

In order for the console to receive signals from the pulse sensor, the console must be angled toward the pulse sensor. Loosen the knobs on the ends of the console crossbar, rotate the console to the proper angle, and retighten the knobs.

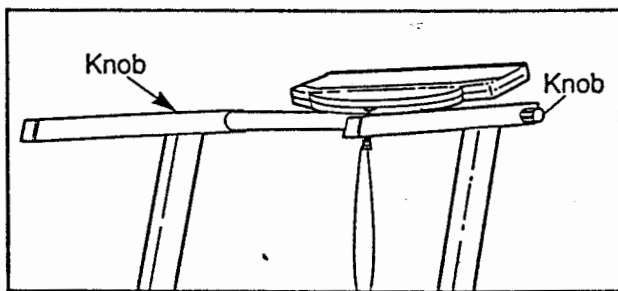

#### HOW TO ADJUST THE CUSHION LEVEL

The rear legs of the treadmill are designed to cushion the impact as you walk or run on the treadmill. The legs can be adjusted for a firmer or softer cushion level using the knob on the right side of the treadmill.

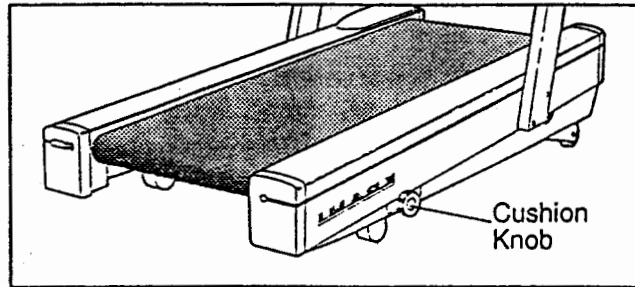

For a firmer cushion level, turn the knob clockwise; for a softer cushion level, turn the knob counterclockwise. Note: The faster you run on the treadmill, the firmer the cushion level should be. If the cushion level is too soft, the treadmill will bounce excessively.

# TROUBLE-SHOOTING AND STORAGE

Most treadmill problems can be solved by following the simple steps below. Find the symptom that applies, and follow the steps listed. If further assistance is needed, call our toll-free HELPLINE at 1-800-736-6879, Monday through Saturday, 7 a.m. until 7 p.m. Central Time (excluding holidays).

## 1. SYMPTOM: THE POWER DOES NOT TURN ON

- Make sure that the power cord is plugged into a surge protector, and that the surge protector is plugged into a properly grounded outlet. (See HOW TO PLUG IN THE POWER CORD on page 9.) Use only a UL-listed surge protector, rated at 15 amps, with a 14-gauge cord of five feet or less in length.
- After the power cord has been plugged in, make sure that the key is fully inserted into the console. Various indicators on the console should light. (See HOW TO TURN ON THE POWER on page 10.)
- Check the circuit breaker located on the treadmill near the power cord. If the switch protrudes as shown, the circuit breaker has tripped. To reset the circuit breaker, wait for five minutes and then press the switch back in.
- Check the on/off switch located at the front of the treadmill near the power cord. The switch must be in the "on" position.

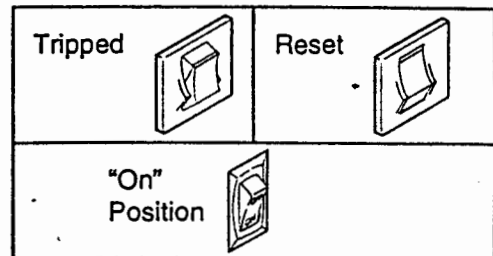

## 2. SYMPTOM: THE POWER TURNS OFF DURING USE

- Check the circuit breaker located on the treadmill near the power cord. If the circuit breaker has tripped (see the drawing above), wait for five minutes and then press the switch back in.
- Make sure that the power cord is plugged in.
- Remove the key from the console. Reinsert the key fully into the console. Various indicators on the console should light.
- Check to make sure the on/off switch is in the "on" position. (See 1. d. above.)
- If the treadmill still will not run, please call our toll-free HELPLINE.

## 3. SYMPTOM: AN ERROR CODE ("E1," "E2," "E3," "E4," OR "E5") APPEARS ON THE CONSOLE

- If error code "E1" appears in the INCLINE display, a malfunction may have occurred in the incline system. Remove the key, wait for ten seconds, and then reinsert the key. If the error code appears again, call our toll-free HELPLINE. Do not operate the treadmill until the problem is corrected.
- Error code "E2" may appear in the SPEED display if the INCREASE SPEED or PROGRAM START button is pressed and no movement of the walking belt is detected within seven seconds. Remove the key, wait for ten seconds, and then reinsert the key. Make sure that you stand on the side rails of the treadmill each time you start walking belt. If the error code appears again, call our toll-free HELPLINE. Do not operate the treadmill until the problem is corrected.
- Error code "E3" may appear in the SPEED display if the speed of the walking belt surges above the selected speed setting. Remove the key, wait for ten seconds, and then reinsert the key. If the error code appears again, call our toll-free HELPLINE. Do not operate the treadmill until the problem is corrected.
- Error code "E4" may appear in the SPEED display if the walking belt is moving at a slow speed, and there is excessive stress on the motor. Remove the key, wait for ten seconds, and then reinsert the key. If you weigh over 200 pounds, it may be helpful to increase the incline of the treadmill. If the error code appears again, call our toll-free HELPLINE. Do not operate the treadmill until the problem is corrected.

e. Error code "E5" may appear in the PULSE display if a pulse error occurs. See HOW TO USE THE PULSE SENSOR on pages 7 and 8, and HOW TO USE THE PULSE DISPLAY on page 11.

#### 4. SYMPTOM: THE PULSE SENSOR DOES NOT FUNCTION PROPERLY

a. See HOW TO USE THE PULSE SENSOR on pages 7 and 8.

#### 5. SYMPTOM: THE WALKING BELT SLOWS WHEN WALKED ON

a. Use only a UL-listed surge protector, rated at 15 amps, with a 14-gauge cord of five feet or less in length.

b. If the walking belt still slows when walked on, please call our toll-free HELPLINE.

#### 6. SYMPTOM: THE WALKING BELT IS OFF-CENTER WHEN WALKED ON

a. If the walking belt has shifted to the left, first remove the key and **UNPLUG THE POWER CORD**. Using the belt tool, turn the rear roller adjustment bolt clockwise 1/4 of a turn. Plug in the power cord, insert the key and run the treadmill for a few minutes. Repeat until the walking belt is centered.

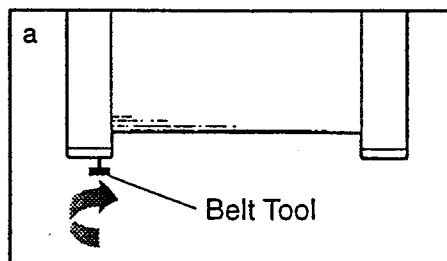

b. If the walking belt has shifted to the right, first remove the key and **UNPLUG THE POWER CORD**. Using the belt tool, turn the rear roller adjustment bolt counterclockwise 1/4 of a turn. Plug in the power cord, insert the key and run the treadmill for a few minutes. Repeat until the walking belt is centered.

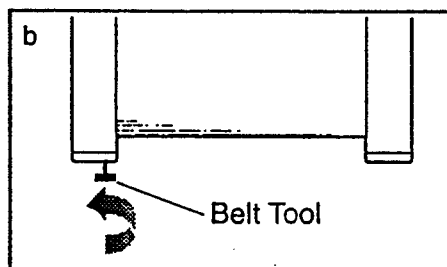

#### STORAGE

Unplug the power cord when the treadmill is not in use.

Remove the indicated bolt and washer from the lower end of each upright. Loosen the other bolt in each upright. Carefully lay the console on the treadmill. Keep the bolts and washers in a secure location.

It is recommended that the treadmill be covered during extended periods of storage.

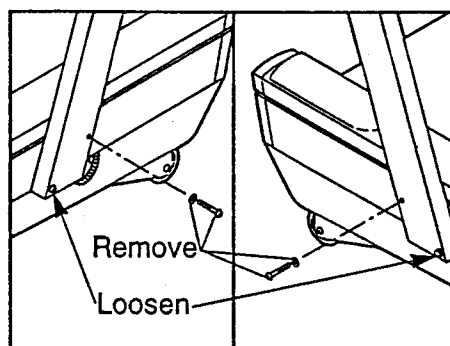

# CONDITIONING GUIDELINES

The following guidelines will help you to plan your exercise program. Remember—these guidelines are general in nature. For more detailed information about exercise, obtain a reputable book or consult your physician.

**⚠ WARNING:** Before beginning this or any exercise program, consult your physician. This is especially important for individuals over the age of 35 or individuals with pre-existing health problems.

The pulse sensor is not a medical device. Various factors, including your movement during exercise, may affect the accuracy of heart rate readings. The sensor is intended only as an exercise aid in determining heart rate trends in general.

## EXERCISE INTENSITY

Whether you want to burn fat or to strengthen your cardiovascular system, you can tailor your exercise to your specific goals. The key to achieving the desired results is to exercise with the proper intensity.

### Burning Fat

To burn fat effectively, you must exercise at a relatively low intensity level for a sustained period of time. During the first few minutes of exercise, your body uses easily accessible *carbohydrate calories* for energy. Only after the first few minutes of exercise does your body begin to use stored *fat calories* for energy.

If your goal is to burn fat, the console's built-in Fat Calorie Monitor will help you to maintain the proper intensity level. As you exercise, the Fat Calorie Monitor will show you when your exercise intensity is too low, too high, or perfect for burning fat. (See HOW TO USE THE FAT CALORIE MONITOR on page 12.)

### Cardiovascular Exercise

If your goal is to strengthen your cardiovascular system, your exercise must be "aerobic." Aerobic exercise is activity that requires large amounts of oxygen for prolonged periods of time. Aerobic exercise increases the demand on the heart to pump blood to the muscles, and on the lungs to oxygenate the blood. The proper intensity level for aerobic exercise can be found by using your pulse as a guide. As you exercise, your pulse should be kept at a level between 70% and 85% of your maximum possible heart rate. This is known as your training zone. You can find your training zone in

Age	Unconditioned Training Zone (Beats/Min.)	Conditioned Training Zone (Beats/Min.)
20	138-167	133-162
25	136-166	132-160
30	135-164	130-158
35	134-162	129-156
40	132-161	127-155
45	131-159	125-153
50	129-156	124-150
55	127-155	122-149
60	126-153	121-147
65	125-151	119-145
70	123-150	118-144
75	122-147	117-142
80	120-146	115-140
85	118-144	114-139

the table above. Training zones are listed according to age and physical condition.

During the first few months of your exercise program, keep your pulse near the low end of your training zone as you exercise. After a few months of regular exercise, your pulse can be gradually increased until it is near the middle of your training zone as you exercise. You can measure your pulse using the pulse sensor. Exercise for about four minutes, and then measure your pulse immediately. If your pulse is too high, decrease the intensity of your exercise. If your pulse is too low, increase the intensity of your exercise.

## WORKOUT GUIDELINES

When exercising, wear loose-fitting, comfortable clothing. Do not wear clothing that could become caught in the treadmill. Always wear athletic shoes for foot protection.

Each workout should include three basic parts: (1) a warm-up, (2) training zone exercise, and (3) a cool-down.

### Warming Up

Warming up prepares the body for exercise by increasing circulation, delivering more oxygen to the muscles and raising the body temperature. Begin each workout with 5 to 10 minutes of stretching and light exercise to warm up (see SUGGESTED STRETCHES on page 23).

## Training Zone Exercise

After warming up, increase the intensity of your exercise until your pulse is in your training zone for 20 to 60 minutes. (During the first few weeks of your exercise program, do not keep your pulse in your training zone for longer than 20 minutes.) Breathe regularly and deeply as you exercise—never hold your breath.

## Cooling Down

Finish each workout with 5 to 10 minutes of stretching

to cool down. This will increase the flexibility of your muscles and will help to prevent post-exercise problems.

## Exercise Frequency

To maintain or improve your condition, complete three workouts each week, with at least one day of rest between workouts. After a few months, you may complete up to five workouts each week if desired.

*The key to success is to make exercise a regular and enjoyable part of your everyday life.*

## SUGGESTED STRETCHES

The correct form for several basic stretches is shown in the drawings below. Move slowly as you stretch—never bounce.

### 1. Toe Touch Stretch

Stand with your knees bent slightly and slowly bend forward from your hips. Allow your back and shoulders to relax as you reach down toward your toes as far as possible. Hold for 15 counts, then relax. Repeat 3 times. Stretches: Hamstrings, back of knees and back.

### 2. Hamstring Stretch

Sit with one leg extended. Bring the sole of the opposite foot toward you and rest it against the inner thigh of your extended leg. Reach toward your toes as far as possible. Hold for 15 counts, then relax. Repeat 3 times for both legs. Stretches: Hamstrings, lower back and groin.

### 3. Calf/Achilles Stretch

With one leg in front of the other, reach forward and place your hands against a wall. Keep your back leg straight and your back foot flat on the floor. Bend your front leg, lean forward and move your hips toward the wall. Hold for 15 counts, then relax. Repeat 3 times for both legs. To cause further stretching of the achilles tendons, bend your back leg as well. Stretches: Calves, achilles tendons and ankles.

### 4. Quadriceps Stretch

With one hand against a wall for balance, reach back and grasp one foot with your other hand. Bring your heel as close to your buttocks as possible. Hold for 15 counts, then relax. Repeat 3 times for both legs. Stretches: Quadriceps and hip muscles.

### 5. Inner Thigh Stretch

Sit with the soles of your feet together and your knees outward. Pull your feet toward your groin area as far as possible. Hold for 15 counts, then relax. Repeat 3 times. Stretches: Quadriceps and hip muscles.

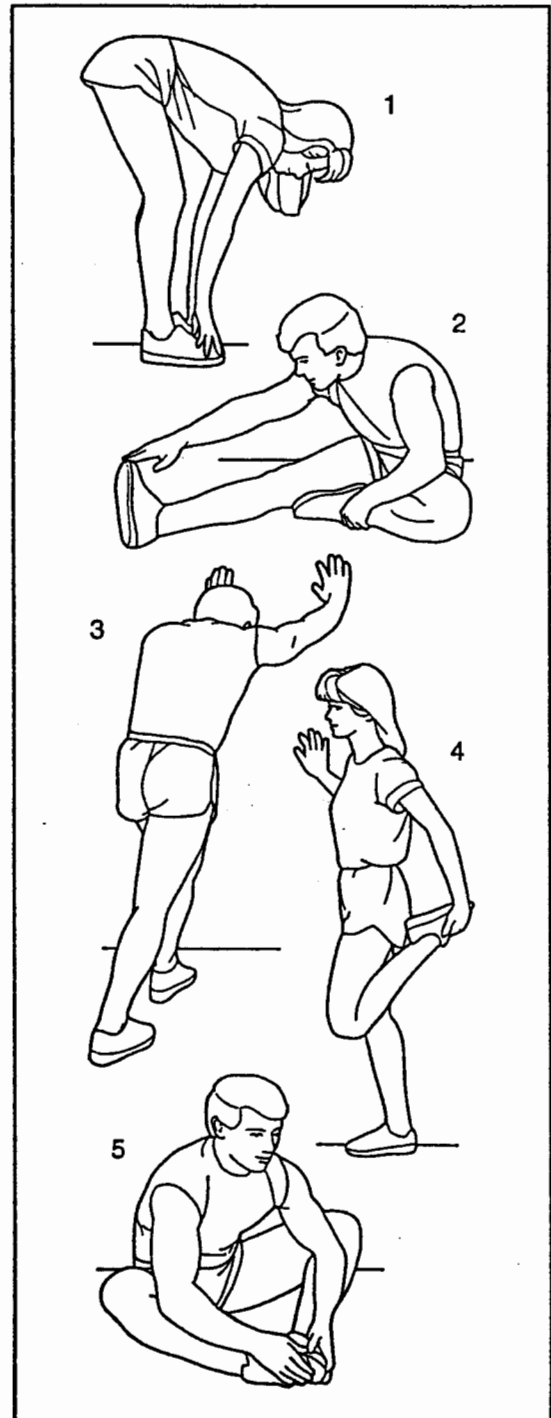



Model No. 831.297562

## QUESTIONS?

If you find that:

- you need help assembling or operating the IMAGE® 10.6
- a part is missing
- or you need to schedule repair service

call our toll-free HELPLINE

**1-800-736-6879**

Monday–Saturday, 7 am–7 pm  
Central Time (excluding holidays)

## REPLACEMENT PARTS

If parts become worn and need to be replaced, call the following toll-free number

**1-800-FON-PART**  
**(1-800-366-7278)**

The model number and serial number of your IMAGE® 10.6 treadmill are listed on a decal attached to the frame. See the front cover of this manual to find the location of the decal.

All replacement parts are available for immediate purchase or special order when you visit your nearest SEARS Service Center. To request service or to order parts by telephone, call the toll-free numbers listed at the left.

When requesting help or service, or ordering parts, please be prepared to provide the following information:

- The NAME OF THE PRODUCT (IMAGE® 10.6 treadmill)
- The MODEL NUMBER OF THE PRODUCT (831.297562)
- The PART NUMBER OF THE PART (see the EXPLODED DRAWING and PART LIST attached to the center of this manual)
- The DESCRIPTION OF THE PART (see the EXPLODED DRAWING and PART LIST attached to the center of this manual)

SEARS, ROEBUCK AND CO., HOFFMAN ESTATES, IL 60179 USA

# **REMOVE THIS EXPLODED DRAWING AND PART LIST FROM THE MANUAL**

**Save this EXPLODED DRAWING and PART LIST for future reference.**

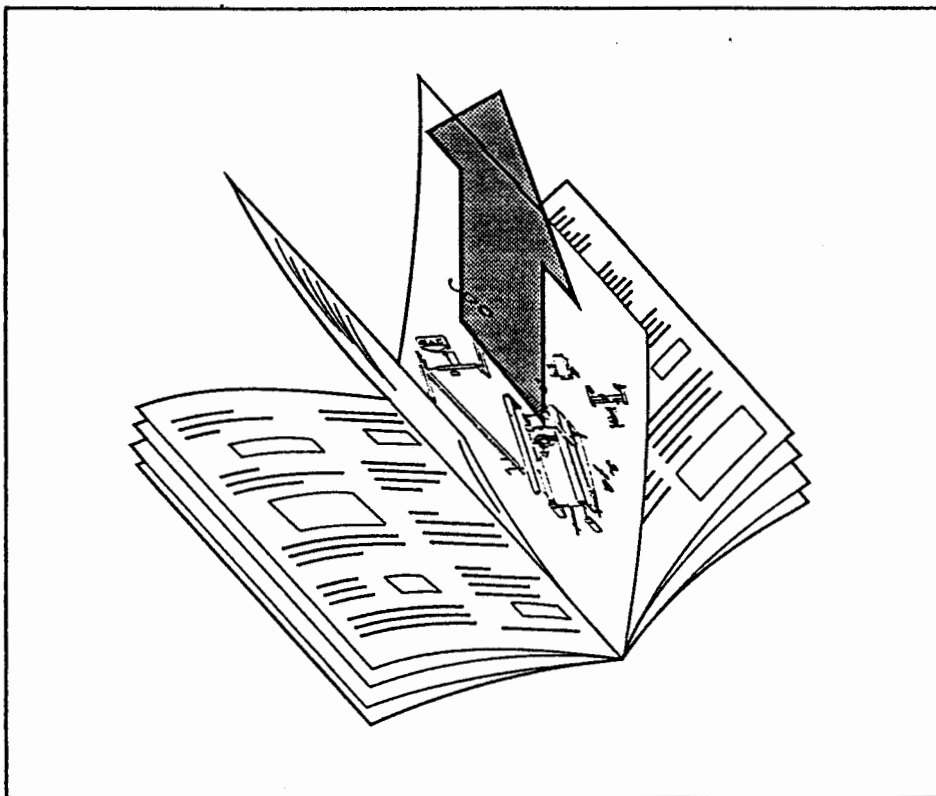

**Note: Specifications are subject to change without notice. For information about ordering replacement parts, see the back cover of the user's manual.**

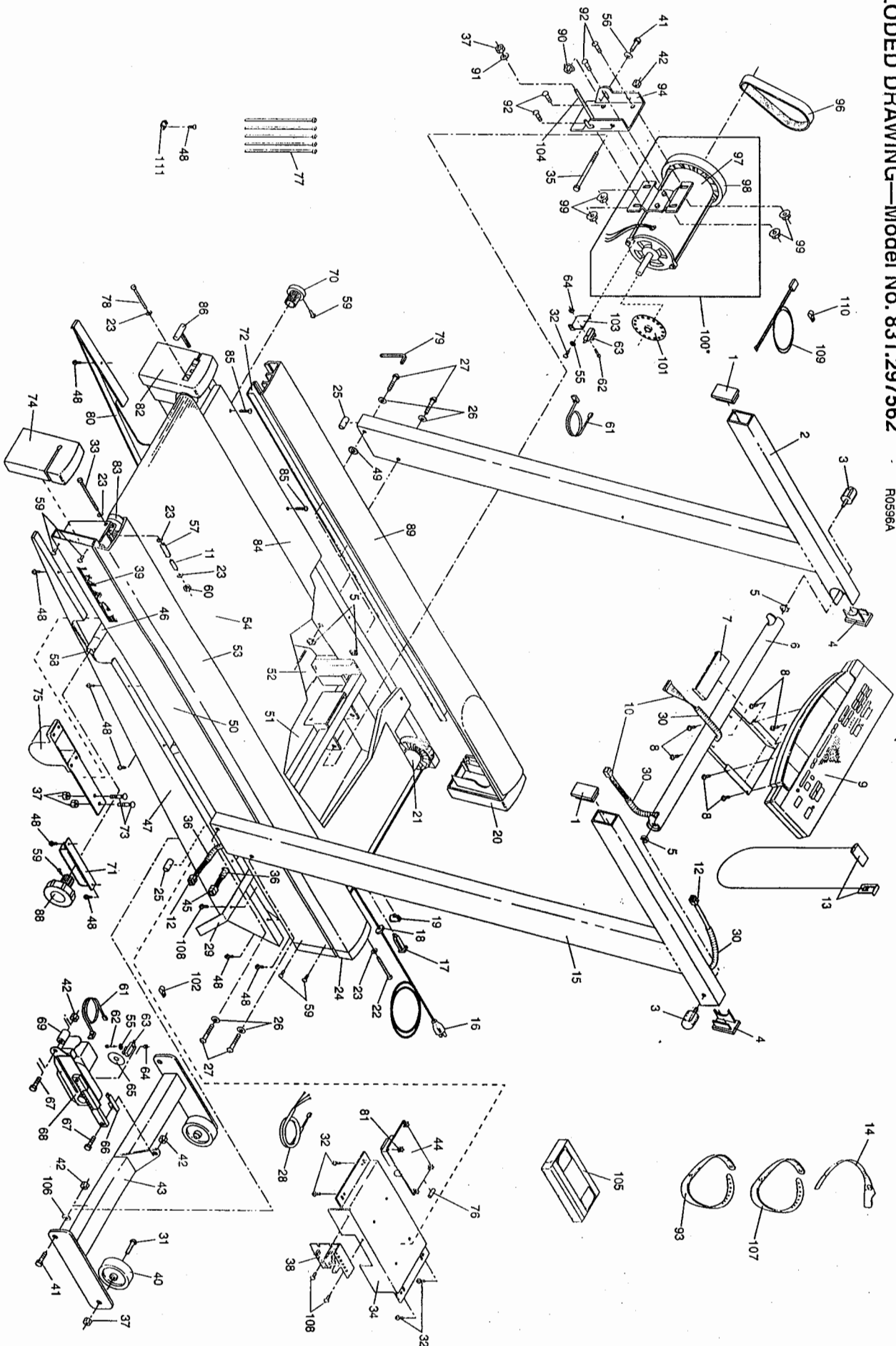

# PART LIST—Model No. 831.297562

R0596A

Key No.	Part No.	Qty.	Description	Key No.	Part No.	Qty.	Description
1	124172	2	Endcap	63	102955	2	Optic Switch
2	124171	1	Left Upright	64	012152	2	Small Nut
3	120244	2	Console Knob	65	109370	1	Incline Optic Switch
4	124174	2	Upright Endcap	66	116892	1	Incline Motor Bracket
5	111869	6	Cage Nut	67	119375	2	Incline Motor Bolt
6	124456	1	Console Crossbar	68	123478	1	Incline Motor
7	124173	1	Wire Cover	69	114270	1	Incline Motor Spacer
8	013141	6	Console Screw	70	128068	1	Bar Endcap
9	124578	1	Console	71	120483	2	Cushion Foot Insert
10	125569	1	Console Wire Harness	72	122860	2	Foot Rail Bracket
11	123470	1	Spacer Sleeve	73	110926	4	Cushion Foot Bolt
12	124010	1	Upright Wire Harness	74	123471	1	Right Rear Endcap
13	119038	1	Key/Clip	75	115046	2	Cushion Foot
14	120644	1	Pulse Sensor	76	110463	1	Power Board Fuse
15	124170	1	Right Upright	77	016057	5	8" Cable Tie
16	013229	1	Power Cord	78	013206	1	Left Rear Belt Tension Bolt
17	109382	1	Circuit Breaker	79	045017	1	7/32" Allen Wrench
18	019084	1	Grommet	80	124450	1	Left Skirt
19	119163	1	On/Off Switch	81	015071	4	Plastic Stand-Off
20	123474	1	Left Front Endcap	82	123472	1	Left Rear Endcap
21	125180	1	Front Roller/Pulley	83	122843	1	Rear Roller
22	112609	1	Front Roller Adj. Bolt	84	124715	1	Walking Platform
23	014127	5	Roller Adj. Washer	85	119779	8	Platform Screw
24	123473	1	Right Front Endcap	86	120844	1	Belt Tool
25	122332	2	Upright Spacer	87	120866	2	Controller Screw
26	014132	4	Upright Washer	88	120482	1	Cushion Knob
27	123494	4	3/8" x 3 1/2" Bolt	89	125681	1	Left Foot Rail
28	120311	1	Power Board-Controller Wire	90	120867	1	Motor Tension Nut
29	121460	1	Belt Guide	91	014041	1	Motor Tension Washer
30	113203	3	6" Cable Loom	92	013445	4	Motor Bolt
31	117806	2	Wheel Bolt	93	126558	1	Blue Headband
32	108080	4	Screw	94	125243	1	Motor Bracket
33	120243	1	Right Rear Belt Tension Bolt	95	124465	1	Motor Pulley
34	123308	1	Electronics Bracket	96	101004	1	Motor Belt
35	107503	1	Motor Swivel Bolt	97	130959	1	Motor
36	113204	2	12" Cable Loom	98	125014	1	Pulley/Flywheel/Fan
37	012056	7	Wheel Nut/Cushion Foot Nut	99	105477	4	Motor Nut
38	120767	1	Controller	100*	130961	1	Motor/Pulley/Flywheel/Fan
39	123530	1	Logo	101	129654	1	Speed Optic Disk
40	052014	2	Front Wheel	102	115872	1	Harness Strain Relief
41	013547	3	Leg Bolt/Motor Tension Bolt	103	120653	1	Optic Switch Bracket
42	012149	5	Leg Nut/Motor Tension Nut	104	100583	1	J-Bolt
43	124451	1	Incline Leg	105	125599	1	Videocassette
44	122215	1	Power Board	106	124009	2	Nylon Washer
45	120823	1	20" Wire Harness	107	126481	1	Red Headband
46	122331	2	Rod Sleeve	108	120630	7	Belt Guide Screw
47	124449	1	Right Skirt	109	124933	1	Thermal Switch
48	013162	23	Skirt Screw/Cover Screw	110	124934	1	Strain Relief
49	014117	2	Star Washer	111	116927	1	Tie Holder Clamp
50	NSP	1	Frame	#	103825	1	20" Black Wire, 2 Female
51	124466	1	Front Safety Cover	#	120873	1	14" Black Wire, Male/Female
52	121447	1	Rear Safety Cover	#	109407	1	4" Black Wire, 2 Female
53	124908	1	Right Foot Rail	#	103823	1	14" White Wire, Male/Female
54	124581	1	Walking Belt	#	102246	1	8" White Wire, 2 Female
55	014157	2	Optic Switch Washer	#	112083	1	8" Blue Wire, 2 Female
56	122812	1	Motor Tension Washer	#	118204	1	8" Blue Wire, Male/Female
57	128986	1	Belt Tension Spring	#	125797	1	11" Red Wire, Male/Female
58	121458	1	Cushion Foot Rod	#	102634	1	8" Green Ground Wire
59	013028	10	Endcap Screw/Knob Screw	#	129272	1	Owner's Manual
60	012096	1	Spring Nut				
61	102633	2	Optic Switch Wire Harness				
62	102959	2	Small Bolt				

\* Includes all parts shown in the box

# These parts are not illustrated