

# FREEMOTION<sup>®</sup> E P I C

# CHEST

## OWNER'S MANUAL

Model No. GZFI8003.6

Serial No. \_\_\_\_\_

Write the serial number in the space above for future reference.

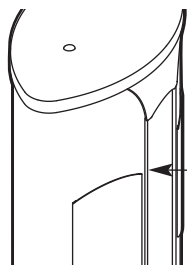

Serial Number  
Decal  
(inside tower)

## QUESTIONS?

At FreeMotion Fitness, we are committed to providing complete customer satisfaction. If you have questions, see HOW TO CONTACT CUSTOMER CARE on the back cover of this manual.

## CAUTION

Read all precautions and instructions in this manual before using this equipment. Save this manual for future reference.

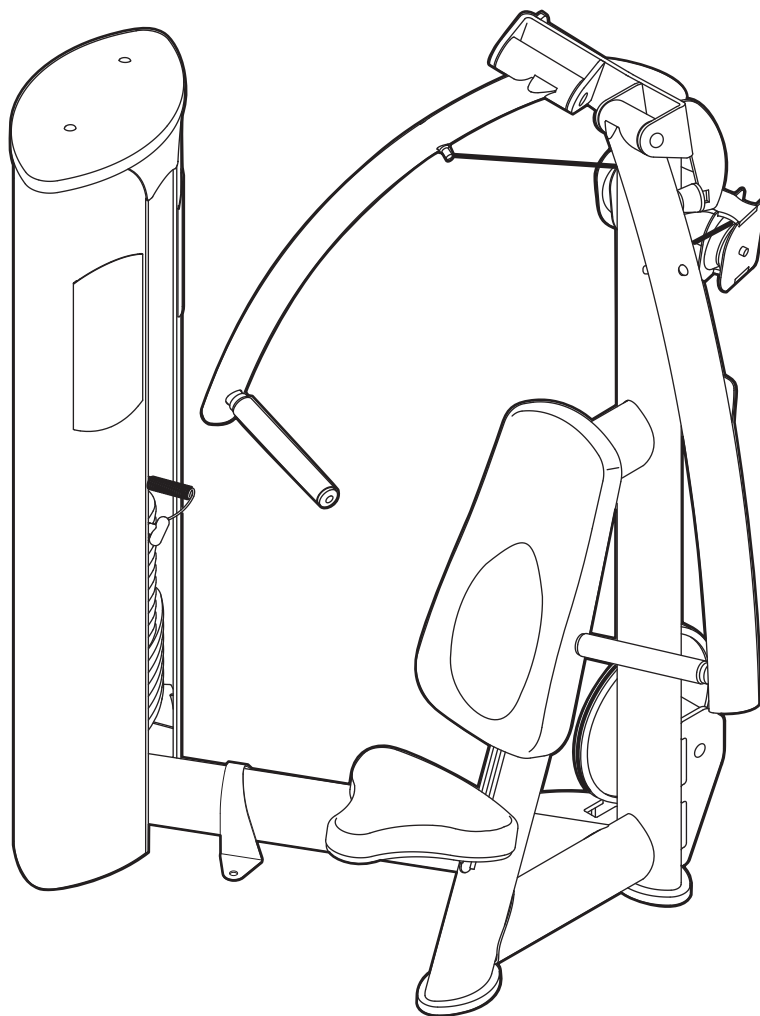

Visit our website at

[www.freemotionfitness.com](http://www.freemotionfitness.com)

---

# TABLE OF CONTENTS

IMPORTANT PRECAUTIONS .....	3
WARNING DECAL PLACEMENT .....	4
BEFORE YOU BEGIN .....	5
ADJUSTMENT .....	6
MAINTENANCE AND TROUBLESHOOTING .....	7
CABLE DIAGRAM .....	11
PART LIST .....	14
EXPLODED DRAWING .....	15
HOW TO CONTACT CUSTOMER CARE .....	Back Cover

# IMPORTANT PRECAUTIONS

**⚠️ WARNING:** To reduce the risk of serious injury, read the following important precautions before using the strength equipment.

1. Read all instructions in this manual before using the strength equipment. Use the strength equipment only as described in this manual.
2. Keep the strength equipment indoors, away from moisture and dust. Do not put the strength equipment in a garage or covered patio, or near water.
3. Use the strength equipment only on a level surface. Cover the floor beneath the strength equipment to protect the floor.
4. It is the purchaser's responsibility to ensure that there is enough space around the strength equipment for the intended exercise. Do not crowd the strength equipment.
5. Anchor the strength equipment to the floor with the anchor strap where required or whenever possible to provide maximum stability.
6. It is the responsibility of the owner to ensure that all users of the strength equipment are adequately informed of all precautions, have read and understood all warning and caution labels, and are informed of how to use the strength equipment properly.
7. The strength equipment is designed to support a maximum user weight of 350 lbs. (160 kg).
8. Keep children under 12 and pets away from the strength equipment at all times.
9. Always wear athletic shoes for foot protection while exercising.
10. Keep hands and feet away from moving parts. Do not lean on or rest your hands on the strength equipment when it is in use.
11. All users of the strength equipment should be instructed to report any injury or strength equipment irregularity to facility staff immediately.
12. Make sure the weight pin is completely inserted into one of the weight plates.
13. Check all cables, cable connections, and pulleys before each use of the strength equipment. Make sure all parts are properly tightened. Replace any worn parts immediately.
14. Make sure the cables remain on the pulleys at all times. If the cables bind while you are exercising, stop immediately and make sure the cables are on the pulleys and nothing is interfering with the cables or pulleys. Replace all cables at least every two years.
15. If you feel pain or dizziness while exercising, stop immediately and begin cooling down.

**⚠️ WARNING:** Before beginning this or any exercise program, consult your physician. This is especially important for persons over the age of 35 or persons with pre-existing health problems. Read all instructions before using. FreeMotion Fitness assumes no responsibility for personal injury or property damage sustained by or through the use of this product.

# WARNING DECAL PLACEMENT

The decals shown below have been placed on the strength equipment in the indicated locations. If a decal is missing or illegible, see HOW TO CONTACT CUSTOMER CARE on the back cover of this manual to order a free replacement decal. Apply the decal in the location shown.

**! WARNING**

- Obtain a medical exam before beginning an exercise program.
- Inspect the machine before use. Do not use if machine appears damaged or inoperable.
- Keep body and clothing free and clear of all moving parts.
- Be certain that the weight pin is completely inserted.
- NEVER pin the weight stack in an elevated position. NEVER use the machine if found in this condition.
- INSPECT all cables, straps and their connections. Do not use if any component is found to be worn or damaged.
- Do not use dumbbells or other means to incrementally increase the weight resistance, other than those provided by the manufacturer.
- Do not allow children on machines. Machine use by teenagers must be supervised by a knowledgeable adult.
- This equipment to be used only under qualified supervision.
- Do not remove this label. REPLACE IF DAMAGED.

**Decal 1**  
Shown at 70%  
GZ7003

**! CAUTION**



Weight selector pin must be fully inserted into the weight plate.

**Decal 2**  
GZ7026

**Decal 4**  
Shown at 85%

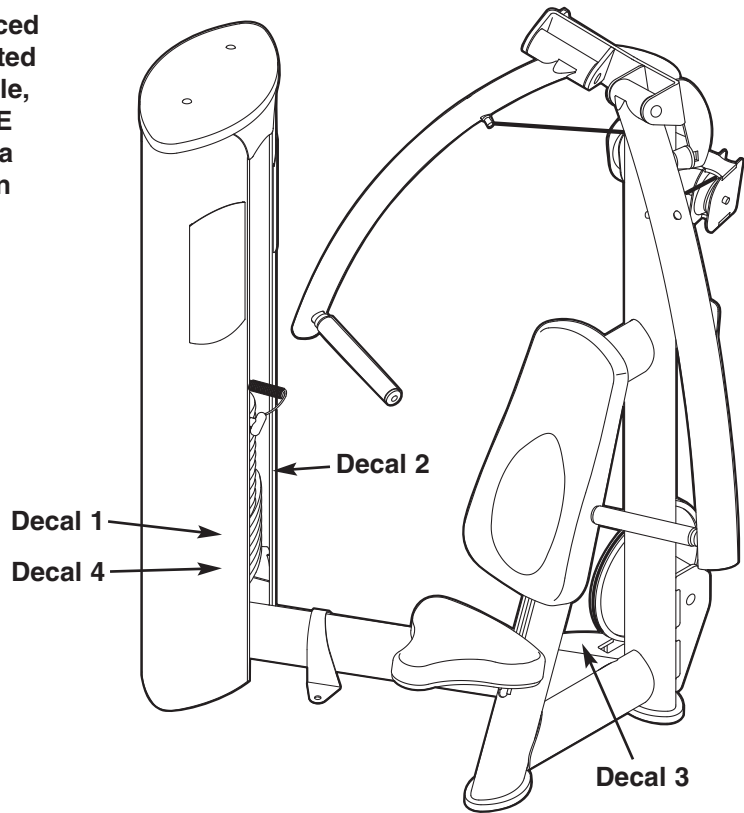

**! CAUTION**

Keep Clear

208842

**Decal 3**

**! CAUTION**

KEEP AWAY FROM MOVING PARTS. FAILURE TO DO SO COULD RESULT IN PERSONAL INJURY.

7005-1199

# BEFORE YOU BEGIN

Thank you for selecting the FREEMOTION® EPIC™ CHEST strength equipment. The strength equipment's stylish ergonomic design and never-before-seen features improve upon traditional strength training. The innovative features and quality construction provide a reliable product for your club. The advanced solutions to isolating individual muscle groups make the strength equipment a key tool for members striving to reach their goals.

**For your benefit, read this manual carefully before using the strength equipment.** If you have questions

after reading this manual, see HOW TO CONTACT CUSTOMER CARE on the back cover of this manual. To help us assist you, please note the product model number and serial number before calling. The model number is GZFI8003.6. The serial number can be found on a decal attached to the strength equipment (see the front cover of this manual).

Before reading further, please review the drawing below and familiarize yourself with the parts that are labeled.

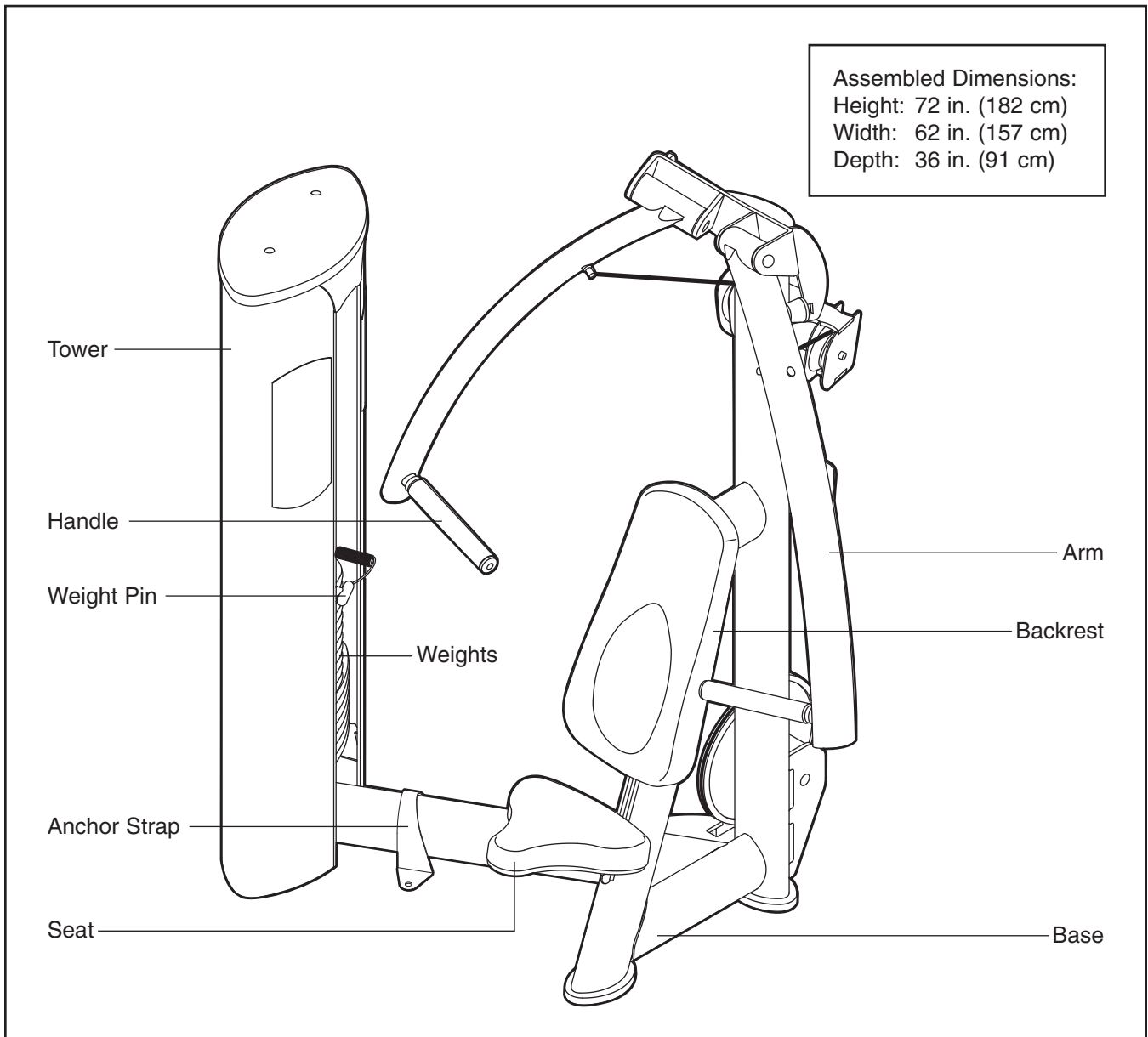

# ADJUSTMENT

This section explains how to adjust the strength equipment. Make sure all parts are properly tightened each time the strength equipment is used. Replace any worn parts immediately.

## ADJUSTING THE RESISTANCE

To change the amount of resistance for your workout, insert the weight pin into the desired weight. Make sure that the weight pin is fully inserted into the weight.

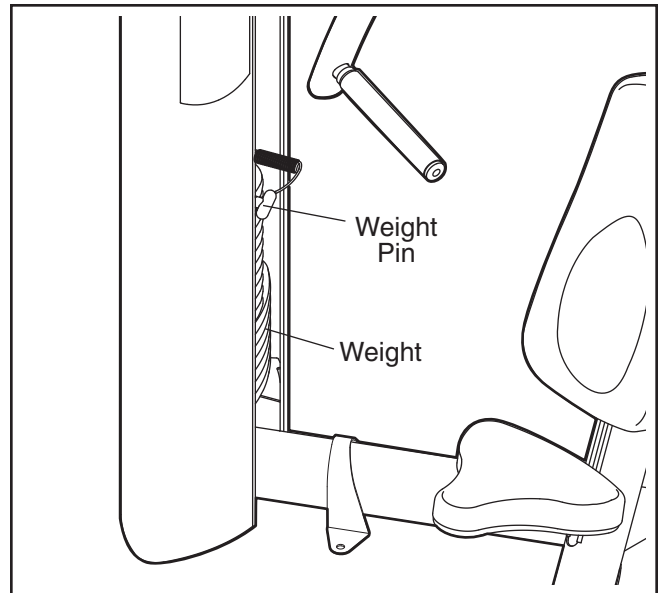

## ADJUSTING THE SEAT

To raise the seat, lift on the end of the seat and move the seat to the desired position. To lower the seat, lift on the end of the seat and press down on the back of the seat until the seat is at the desired height.

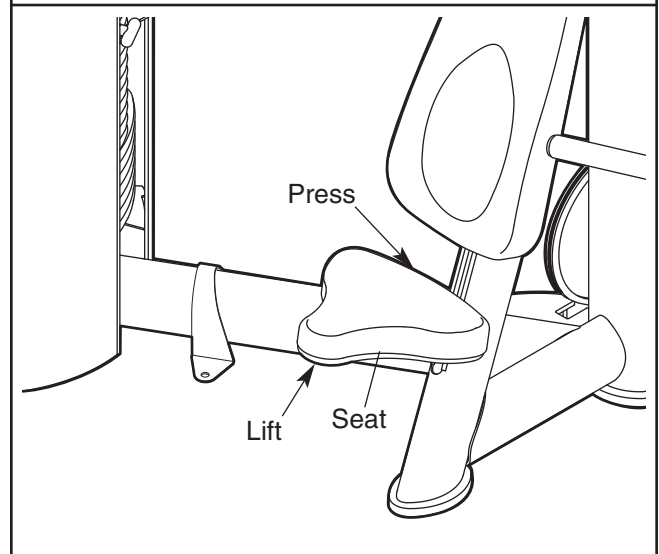

# MAINTENANCE AND TROUBLESHOOTING

For optimal performance of the strength equipment and to reduce the chances of injury to users, you must perform preventive maintenance on a regular basis. Instruct all personnel to perform the procedures described in this section. Personnel must also record and report any accident. To maintain the strength equipment's warranty, use only FREEMOTION EPIC parts for repair or replacement. If there are any questions or concerns, see HOW TO CONTACT CUSTOMER CARE on the back cover of this manual.

## DAILY MAINTENANCE

### Upholstery and Frame—General Cleaning

1. Clean the strength equipment using a soft cloth dampened with a light solution of mild soap and warm water. If necessary, use a soft bristle brush with the cleaning solution.
2. Rinse the area thoroughly using a soft cloth dampened with clean water and dry thoroughly.

### Upholstery—Difficult Stains

1. Spray the stain with a non-abrasive household cleaner such as FORMULA 409® cleaner, SIMPLE GREEN®, or a similar product. Rub the stained area gently and let the cleaning solution sit for a few minutes.
2. Rinse the area thoroughly using a soft cloth dampened with clean water and dry thoroughly.
3. Repeat these steps if necessary using a soft bristle brush.

### Optional Method for Difficult Stains

1. Rub the stained area gently using a soft cloth dampened with rubbing alcohol.
2. Rinse the area thoroughly using a soft cloth dampened with clean water and dry thoroughly.

**CAUTION:** When using any cleaning product, try it first in an unnoticeable place to ensure that there is no damage to the material. Follow the directions and the safety precautions of the manufacturer of each cleaning product used. FreeMotion Fitness and its vendors cannot be held liable for damage or injuries resulting from the use or misuse of cleaning products.

**Important:** Do not use abrasive cleaners, which may scratch the strength equipment. Strong cleaners and abrasives will damage decals; use caution around decals. Do not use solvents such as lacquer thinner, kerosene, gasoline, or similar liquids.

## WEEKLY MAINTENANCE

### Hardware

Check all nuts and bolts and tighten them as required. **Important:** All FREEMOTION EPIC cushions have dense plywood supports with tee-nuts that are used to bolt the cushions to the strength equipment. Because the tee-nuts are held by the plywood, they will not withstand the torque that standard nuts and bolts will. When tightening the bolts securing a cushion, turn them only until they are snug and the cushion does not move or feel loose. Overtightening may strip the tee-nuts from the plywood and make it impossible to remove the cushion in the future.

### Cables

1. Check each cable for proper tension (see CABLE ADJUSTMENT on page 8).
2. Check the entire length of each cable by pulling each handle to its fully extended position and inspecting the cable that is exposed on the exterior of the strength equipment and the cable inside the tower. Run your fingers along the cable, paying close attention at the bends and attachment points. Watch for the following conditions, which may indicate a worn cable in need of replacement:
  - A. a torn or split cable sheath that exposes the cable
  - B. a kinked or severely bent cable
  - C. a curled or twisted sheath
  - D. a stretched cable sheath, showing a thinning cross-section

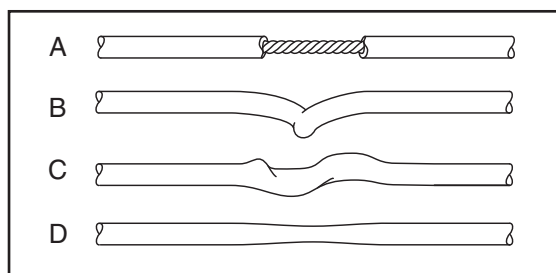

## Cable Guards

Check the cable guards to ensure that they are not rubbing against the cables and that they are holding the cables in the grooves of the pulleys. If a cable guard is not correctly aligned, loosen the bolt slightly, readjust the cable guard as necessary, and retighten the bolt.

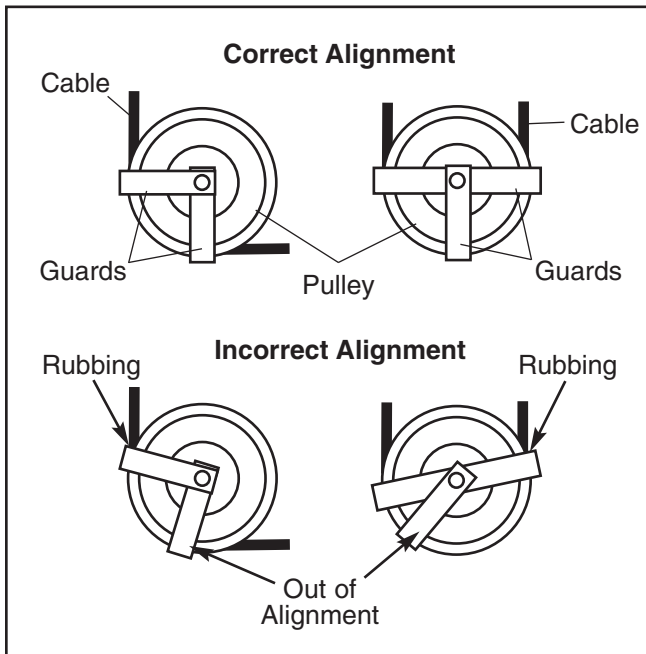

## MONTHLY MAINTENANCE

### Grips

Check the grips and replace them if needed.

### GUIDE ROD LUBRICATION

Clean and lubricate the full length of each guide rod by wiping it with a soft cloth containing a lightweight motor oil, 10W-40 or 10W-30 weight. Apply only a light coating over the entire length of the guide rod. **Do not use TEFLON® or silicone-based lubricants.**

### CABLE ADJUSTMENT

For the strength equipment to function correctly, the cables must be tensioned correctly. To check the tension of the cables, insert the weight pin into the top weight plate. Next, slowly raise and lower the top weight by pulling on a handle. The top weight should come to rest just on top of the second weight when the handle is returned to the resting position.

If there is too much tension on the cables, the top weight will not rest on the second weight, and it may be difficult to insert the weight pin into the weight

plates. If there is not enough tension on the cables, the top weight will not be lifted immediately when one of the handles is pulled. Ideally, the handle/cable should not move more than 1/2 in. (1.5 cm) from the resting position before the top weight is lifted.

If there is too much tension or not enough tension on a cable, adjust the cable as described in the following steps.

### Floating Pulley Adjustment

Tools required: Adjustable wrench

1. Lift the top weight off the weight stack and insert the weight pin into the second weight and the sixth hole from the top of the weight rod.

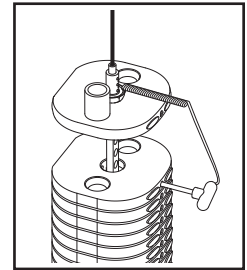

2. Rotate the cam clockwise and disengage the cam cable from the small cam.

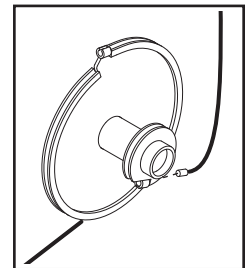

3. Loosen the nut below the "U"-bracket. To remove slack from the cables, turn the cam cable clockwise into the "U"-bracket. To add slack to the cables, turn the cam cable counterclockwise out of the "U"-bracket.

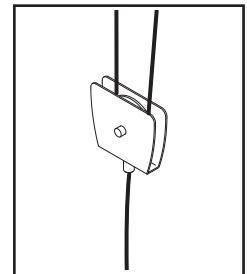

4. Retighten the nut against the "U"-bracket and re-engage the cam cable onto the small cam.
5. Lift the top weight and remove the weight pin. Lower the top weight onto the second weight.
6. Readjust as necessary.
7. Pull a handle using a light load and have someone make sure that the cable is not derailed from a pulley or rubbing on a cable guard.

## Tower Pulley Adjustment

Tools required: 5/16" hex key, 9/16" open end wrench

1. Lift the top weight off the weight stack and insert the weight pin into the second weight and the sixth hole from the top of the weight rod.

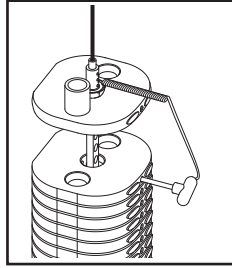

2. Loosen the locknut attaching the pulley to the bracket in the top of the tower.

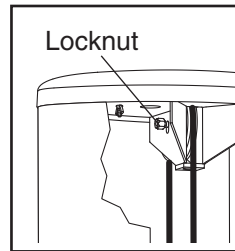

3. Move the pulley to the appropriate location in the bracket. If more slack is needed in the cable, move the pulley down. If less slack is needed in the cable, move the pulley up.
4. Make sure that the cable guard is properly oriented (see CABLE GUARDS on page 8) and retighten the locknut attaching the pulley to the bracket.
5. Lift the top weight and remove the weight pin. Lower the top weight onto the second weight.
6. Readjust as necessary.
7. Pull a handle using a light load and have someone make sure that the cable is not derailed from a pulley or rubbing on a cable guard.

## Top Weight Adjustment

Tools required: 5/32" hex key

1. If the cable needs to be shortened 3/4 in. (2 cm) or more, follow the instructions in steps 1 and 2 at the left; then, go to step 2 below.
2. Lift the coupler cover from the top weight coupler. Loosen but do not remove the two set screws in each side of the weight coupler.

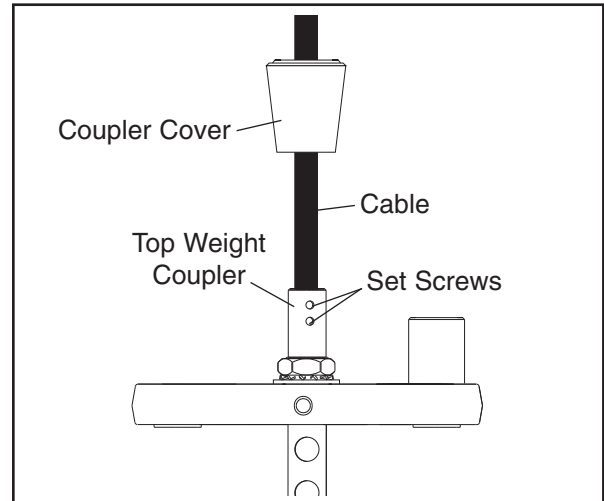

3. Pull the cable out of the top weight coupler. Determine the amount that the cable needs to be shortened, and cut that much off the end of the cable. **The cable must be long enough to be held by the set screws without lifting the top weight.**
4. Cut the cable to the desired length and strip 1 in. (2.5 cm) of the vinyl sheath from the cut end of the cable.
5. Insert the cable into the top weight coupler until all four set screws can be tightened against the cable. Tighten each set screw alternately 1/4 turn, until all are set to 85 inch/pounds (9.6 Newton-meters)
6. Lower the coupler cover over the top weight coupler.
7. Pull a handle using a light load and have someone make sure that the cable is not derailed from a pulley or rubbing on a cable guard.

## WEIGHT STACK SERVICING

Servicing the weight stack involves replacing the two guide bushings and weight insert in the top weight. To order these parts, see HOW TO CONTACT CUSTOMER CARE on the back cover of this manual.

1. Remove the wingnuts under the tower cap and remove the tower cap from the tower.
2. Remove the guide rod nuts and washers from the top of each guide rod.
3. Lift the coupler cover and loosen the four set screws—this will release the cable.
4. Lift the guide rods out of the top of the tower.
5. Remove the rod nut, rod star washer, and rod washer from the top of the weight rod. Lift and rotate the top weight, and remove it through the front opening of the tower.
6. Use a punch to drive the two existing guide bushings and the weight insert out of the top weight.

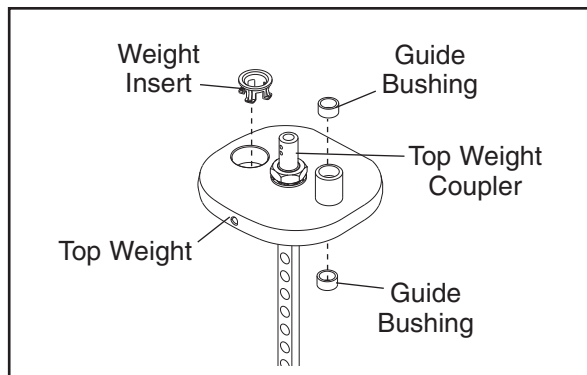

7. Hold one of the new guide bushings square to the face of one of the holes in the top weight, place a protective piece of wood on top of the guide bushing, and lightly tap the guide bushing until it is flush with the surface. **Insert the other guide bushing and the weight insert in the same way.**

8. Replace the top weight. Next, tighten the rod nut, rod star washer, and rod washer onto the weight rod.
9. Reattach the cable to the top weight coupler. Retighten the four set screws into the threaded holes. Tighten the set screws equally until they contact the cable. Then, tighten each screw alternately 1/4 turn, until all are set to 85 inch/pounds (9.6 Newton-meters).
10. Clean and lubricate the guide rods by wiping them with a soft cloth containing a lightweight motor oil, 10W-40 or 10W-30 weight. Apply only a light coating over the entire length. **Do not use TEFLON® or silicone-based lubricants.**
11. Reinsert the guide rods through the top of the tower and into the weight stack.  
Note: If the weight stack has shifted, use a short bar to realign the holes in the weight plates. Hold the weight plates while inserting the guide rods.
12. Reattach the guide rods to the top of the frame with the two guide rod nuts and washers.

**WARNING:** Do not force the guide rods into the weights; doing so will damage the bushings and weight inserts.

13. Insert the weight pin into the top weight. Pull the handle, lifting the top weight all the way to the top. Slowly return the handle to the resting position. If the top weight sticks, loosen one of the guide rod screws. Lift the top weight to the top again. Retighten the guide rod nut. Check the full travel again and readjust the guide screws as necessary.
14. Pull a handle using a light load and have someone make sure that the cable is not derailed from a pulley or rubbing on a cable guard.
15. Replace the tower cap and retighten the wingnuts onto the bolts.

# CABLE DIAGRAM

The cable diagram below shows the proper route of the cables. Use the diagram to make sure that the cables and the cable guards have been assembled correctly. If the cables have not been correctly routed, the strength equipment will not function properly and damage may occur. The numbers show the correct route of the cables. **Make sure that the cable guards do not touch or bind the cables.**

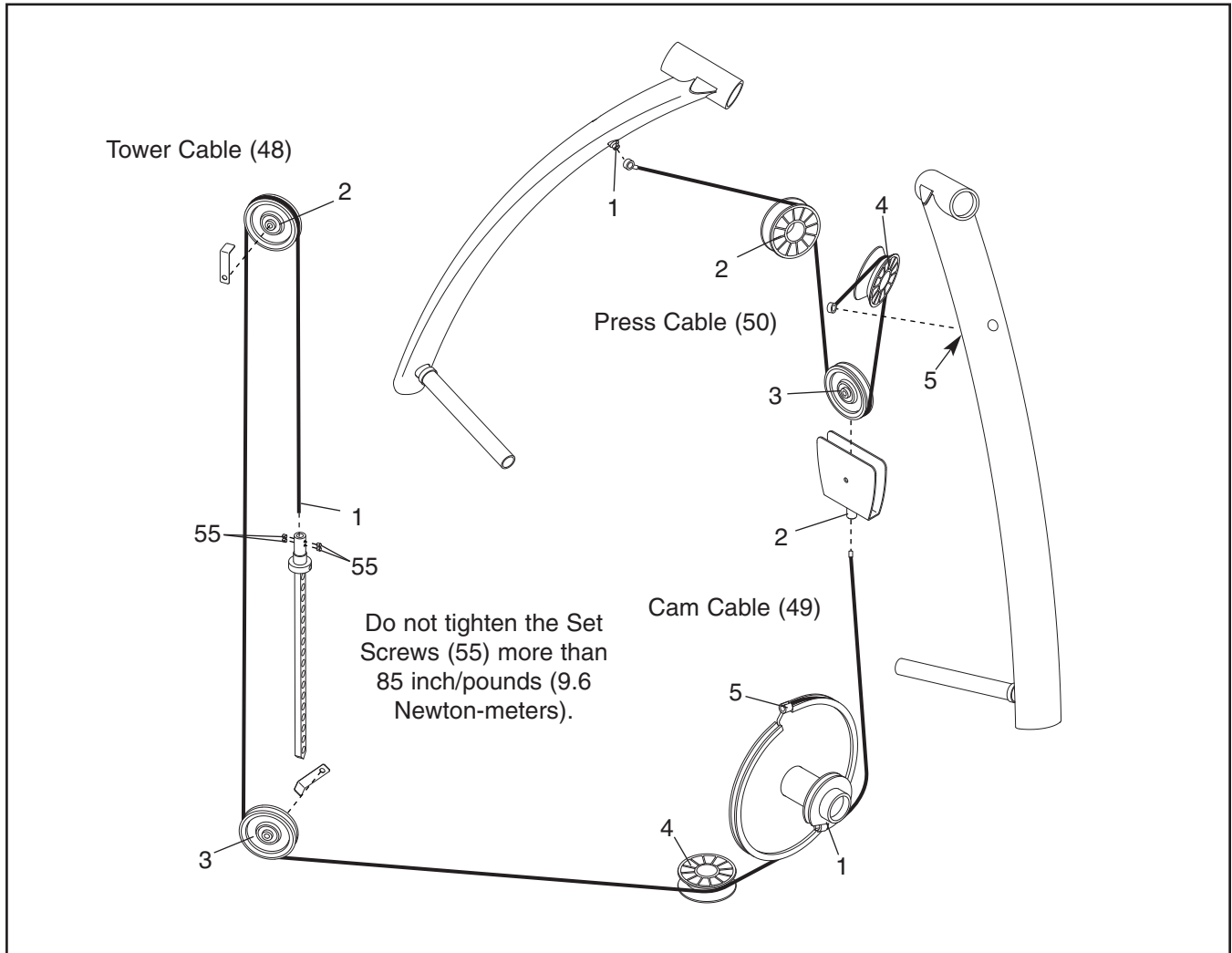

---

# NOTES

---

# NOTES

# PART LIST—Model No. GZFI8003.6

R1006A

If replacement parts are needed, or if parts are missing or damaged, see HOW TO CONTACT CUSTOMER CARE on the back cover of this manual.

Key No.	Qty.	Description	Key No.	Qty.	Description
1	1	Frame	42	1	Cover
2	2	Internal Pivot Bushing	43	1	Short Tower Plate
3	1	Right Arm	44	1	Long Tower Plate
4	1	Left Arm	45	4	Guide Rod Nut
5	1	Tower	46	4	Tower Foot
6	2	Guide Rod	47	2	Frame Foot
7	1	Tower Cap	48	1	Tower Cable
8	1	Weight Rod	49	1	Cam Cable
9	1	Top Weight	50	1	Press Cable
10	10	10-pound Plate	51	2	Wingnut
11	7	20-pound Plate	52	1	Rod Nut
12	2	Guide Bushing	53	1	Star Washer
13	35	Weight Insert	54	1	Rod Washer
14	6	1" Bearing	55	4	Set Screw
15	2	Weight Bumper	56	6	1/4" x 3/4" Flat Head Screw
16	1	Weight Pin	57	12	3/8" x 1/2" Button Screw
17	1	Seat Frame	58	8	3/8" Nylon Locknut
18	1	Seat	59	3	3/8" x 1 3/4" Bolt
19	1	Backrest Bracket	60	4	Rivet
20	1	Backrest	61	2	1/4" x 1" Button Bolt
21	1	Cam	62	2	1/2" x 1 1/4" Bolt
22	1	Long Pivot Rod	63	2	3/8" x 2" Bolt
23	2	Handgrip	64	5	3/8" x 1" Non-patch Bolt
24	2	Handgrip Collar	65	2	3/8" x 2 1/2" Bolt
25	2	Handle Endcap	66	1	3/8" x 3" Bolt
26	8	No. 10 x 1/8" Set Screw	67	1	3/8" x 6 1/2" Non-patch Bolt
27	1	"U"-bracket	68	2	3/8" x 1" Bolt
28	3	Pulley	69	4	Bumper Spacer
29	2	Cable Guard	70	1	3/8" Fine-thread Nut
30	7	Pulley Washer	71	1	Bungee Cord
31	3	"V"-pulley	72	2	Wire Tie
32	1	Long Plate Frame	73	2	1/4" x 3/8" Screw
33	6	"V"-pulley Bearing	74	1	Anchor Strap
34	6	Pivot Bushing	75	4	Guide Rod Washer
35	2	Short Pivot Rod	76	1	Short Plate Frame
36	6	Pivot Washer	77	1	Rear Access Panel
37	6	Snap Ring	78	1	Access Panel Gasket
38	2	Arm Bumper	79	6	1/4" Cage Nut
39	1	Short Trim	80	1	Backrest Cover
40	2	Long Trim	#	-	Owner's Manual
41	1	Coupler Cover			

Note: "#" indicates a non-illustrated part. Specifications are subject to change without notice.

# EXPLODED DRAWING—Model No. GZFI8003.6

R1006A

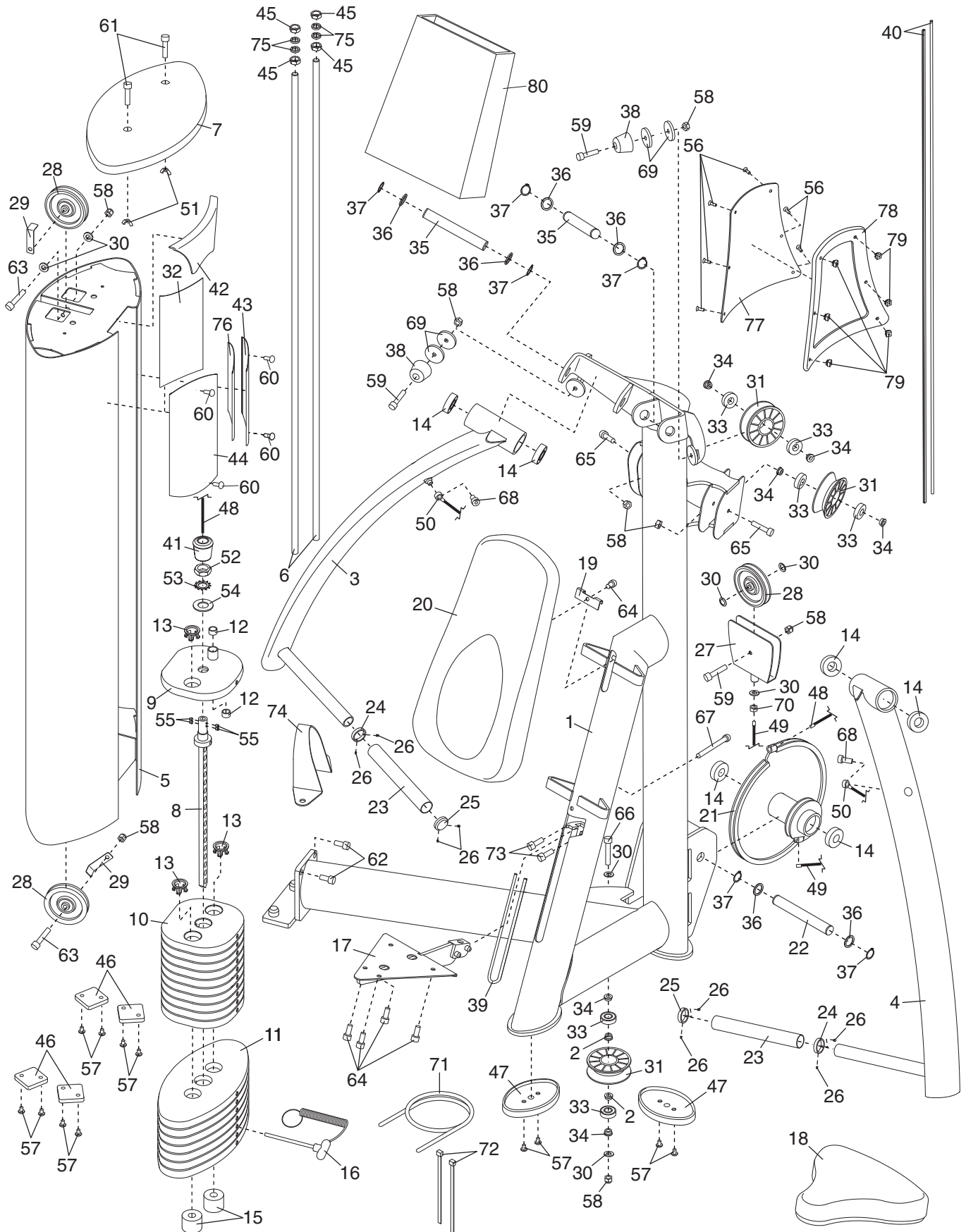

---

# HOW TO CONTACT CUSTOMER CARE

If you have questions after reading this manual, or if you require assistance, please contact Customer Care at the address and phone number listed below. Please be prepared to provide the following information:

- the MODEL NUMBER of the product (GZFI8003.6)
- the NAME of the product (FREEMOTION EPIC CHEST strength equipment)
- the SERIAL NUMBER of the product (see the front cover of this manual)
- when ordering replacement parts, please also give the KEY NUMBER and DESCRIPTION of the part(s) (see the PART LIST and the EXPLODED DRAWING on pages 14 and 15)

**Customer Care: 1-800-201-2109, Monday–Friday, 8 a.m.–5 p.m. Mountain Time  
FreeMotion Fitness, Inc. • 1096 Elkton Dr., Suite 600 • Colorado Springs, CO 80907**