

FreeMotion[®] E P I C

OWNER'S MANUAL

Model No. GZFI8003.5

Serial No. _____

Write the serial number in the space above for future reference.

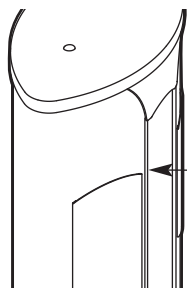

Serial Number
Decal
(inside tower)

QUESTIONS?

At FreeMotion Fitness, we are committed to providing complete customer satisfaction. If you have questions, see HOW TO CONTACT CUSTOMER CARE on the back cover of this manual.

⚠ CAUTION

Read all precautions and instructions in this manual before using this equipment. Save this manual for future reference.

CHEST

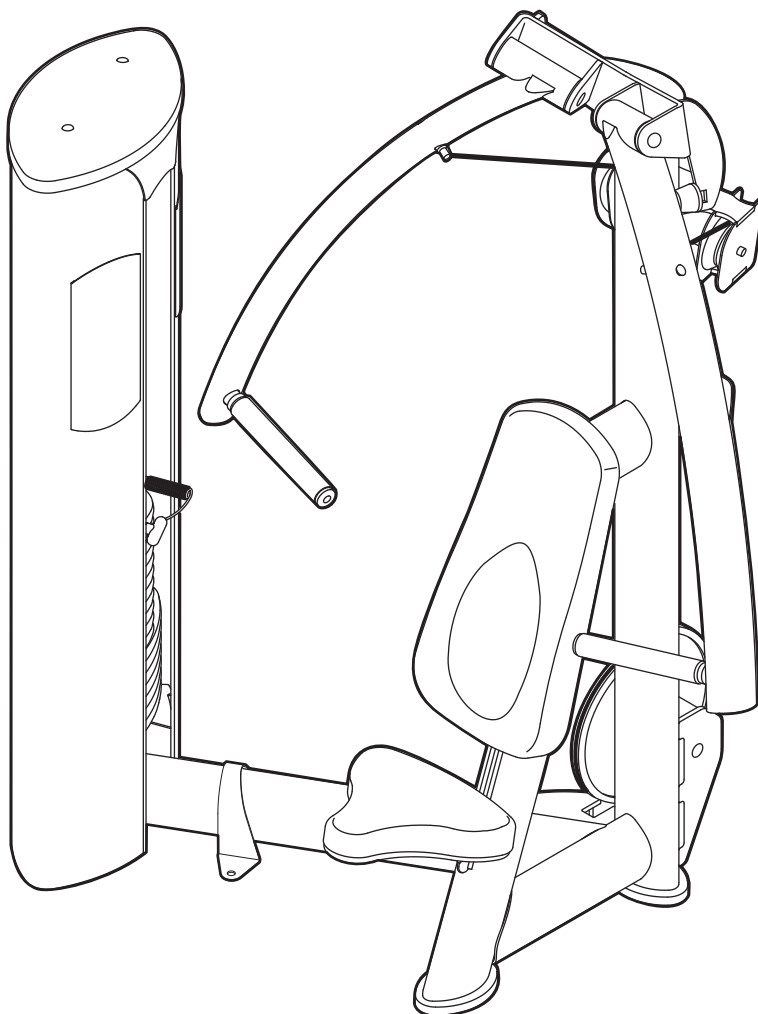

Visit our website at

www.freemotionfitness.com

TABLE OF CONTENTS

IMPORTANT PRECAUTIONS	3
WARNING DECAL PLACEMENT	4
BEFORE YOU BEGIN	5
ADJUSTMENTS	6
MAINTENANCE	7
CABLE DIAGRAM	12
PART LIST	14
EXPLODED DRAWING	15
HOW TO CONTACT CUSTOMER CARE	Back Cover

IMPORTANT PRECAUTIONS

⚠ WARNING: To reduce the risk of serious injury, read the following important precautions before using the strength equipment.

1. Read all instructions in this manual before using the strength equipment. Use the strength equipment only as described in this manual.
2. It is the purchaser's responsibility to ensure that there is enough space around the strength equipment for the intended exercise. Do not crowd the strength equipment.
3. Using the anchor strap to provide maximum stability, anchor the strength equipment to the floor where required or whenever possible.
4. Use the strength equipment only on a level surface. Cover the floor beneath the strength equipment to protect the floor.
5. It is the responsibility of the owner to ensure that all users of the strength equipment are adequately informed of all precautions, have read and understood all warning and caution labels, and are informed of how to use the strength equipment properly.
6. Keep children under 12 and pets away from the strength equipment at all times.
7. Always wear athletic shoes for foot protection while exercising.
8. Keep hands and feet away from moving parts. Do not lean on or rest your hands on the strength equipment when it is in use.
9. All users of the strength equipment should be instructed to report any injury or strength equipment irregularity to facility staff immediately.
10. Make sure the weight pin is completely inserted into one of the weight plates.
11. Check all cables, cable connections, and pulleys before each use of the strength equipment. Make sure all parts are properly tightened. Replace any worn parts immediately.
12. Make sure the cables remain on the pulleys at all times. If the cables bind while you are exercising, stop immediately and make sure the cables are on the pulleys and nothing is interfering with the cables or pulleys. Replace all cables at least every two years.
13. The strength equipment is designed to support a maximum user weight of 160 kg (350 lbs.).
14. Keep the strength equipment indoors, away from moisture and dust. Do not put the strength equipment in a garage or covered patio, or near water.
15. If you feel pain or dizziness at any time while exercising, stop immediately and begin cooling down.

⚠ WARNING: Before beginning this or any exercise program, consult your physician. This is especially important for persons over the age of 35 or persons with pre-existing health problems. Read all instructions before using. ICON assumes no responsibility for personal injury or property damage sustained by or through the use of this product.

WARNING DECAL PLACEMENT

The decals shown below have been placed on the strength equipment in the indicated locations. If a decal is missing or illegible, see HOW TO CONTACT CUSTOMER CARE on the back cover of this manual to order a free replacement decal. Apply the decal in the location shown.

! WARNING

- Obtain a medical exam before beginning an exercise program.
- Inspect the machine before use. Do not use if machine appears damaged or inoperable.
- Keep body and clothing free and clear of all moving parts.
- Be certain that the weight pin is completely inserted.
- NEVER pin the weight stack in an elevated position. NEVER use the machine if found in this condition.
- INSPECT all cables, straps and their connections. Do not use if any component is found to be worn or damaged.
- Do not use dumbbells or other means to incrementally increase the weight resistance, other than those provided by the manufacturer.
- Do not allow children on machines. Machine use by teenagers must be supervised by a knowledgeable adult.
- This equipment to be used only under qualified supervision.
- Do not remove this label. REPLACE IF DAMAGED.

Decal 1
Shown at 70%
GZ7003

! CAUTION



Weight selector pin must be fully inserted into the weight plate.

Decal 2
GZ7026

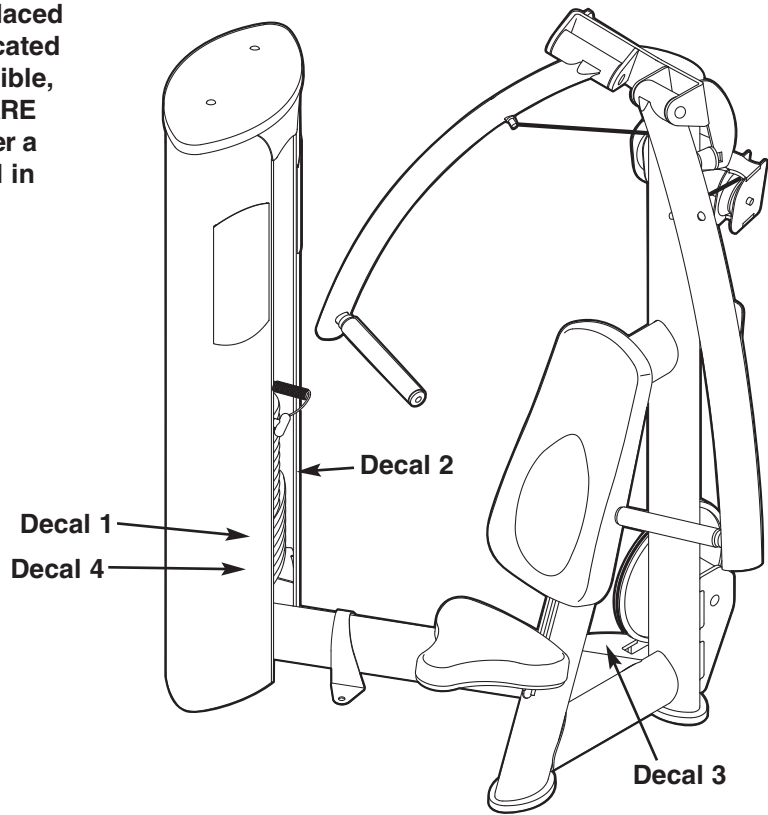

! CAUTION

Keep Clear

208842

Decal 3

! CAUTION

KEEP AWAY FROM MOVING PARTS. FAILURE TO DO SO COULD RESULT IN PERSONAL INJURY.

7005-1199

Decal 4
Shown at 85%

BEFORE YOU BEGIN

Thank you for selecting the FREEMOTION EPIC™ CHEST strength equipment. The strength equipment's stylish ergonomic design and never-before-seen features improve upon traditional strength training. The innovative features and quality construction provide a reliable product for your club. The advanced solutions to isolating individual muscle groups make the CHEST strength equipment a key tool for members to reach their goals.

For your benefit, read this manual carefully before using the strength equipment. If you have questions

after reading this manual, see HOW TO CONTACT CUSTOMER CARE on the back cover of this manual. To help us assist you, please note the product model number and serial number before calling. The model number is GZFI8003.5. The serial number can be found on a decal attached to the strength equipment (see the front cover of this manual).

Before reading further, please review the drawing below and familiarize yourself with the parts that are labeled.

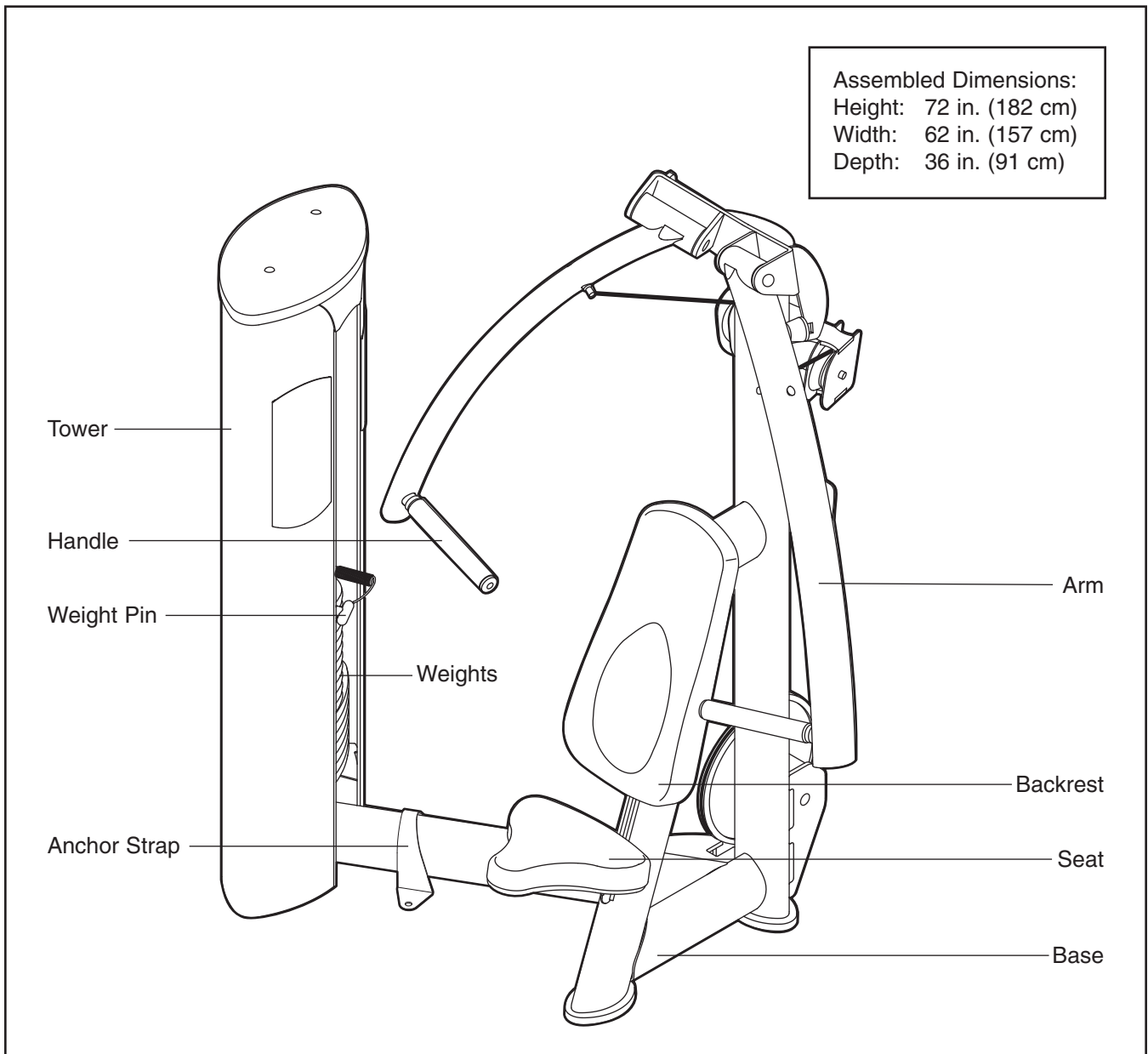

ADJUSTMENTS

This section explains how to adjust the strength equipment. Make sure all parts are properly tightened each time the strength equipment is used. Replace any worn parts immediately.

ADJUSTING THE RESISTANCE

To change the amount of resistance for your workout, insert the weight pin into the desired weight. Make sure that the weight pin is fully inserted into the weight.

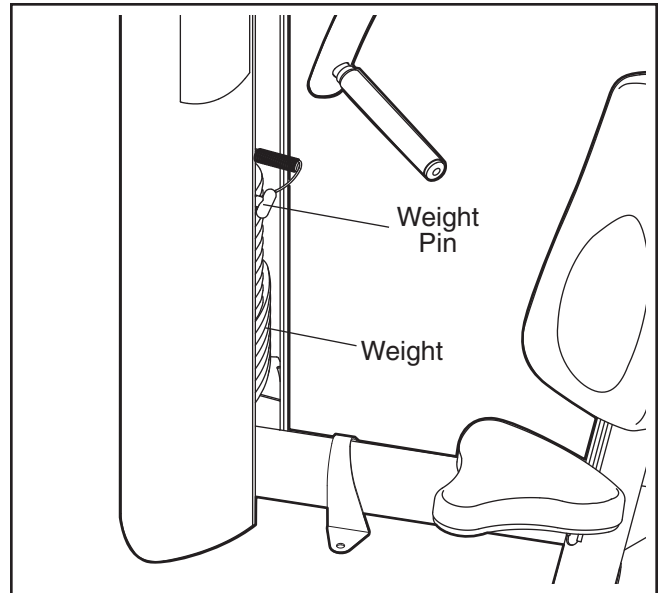

ADJUSTING THE SEAT

To raise the seat, lift on the end of the seat and move the seat to the desired position. To lower the seat, lift on the end of the seat and press down on the back of the seat until the seat is at the desired height.

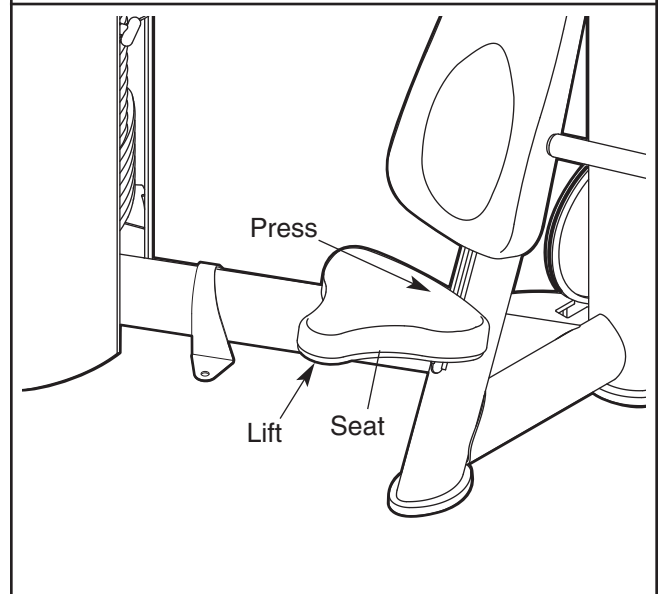

MAINTENANCE

It is important for safe and trouble-free operation of your FREEMOTION EPIC strength equipment to perform routine preventive maintenance on a regular basis. Instruct all personnel to perform equipment inspection and maintenance requirements. Personnel must record and report any accident. To maintain the strength equipment's warranty, use only FREEMOTION EPIC parts for repair or replacement. If there are any questions or concerns, see HOW TO CONTACT CUSTOMER CARE on the back cover of this manual.

SCHEDULED MAINTENANCE

DAILY

1. Upholstery—General cleaning:

- Wipe using a soft cloth dampened with a light solution of mild soap and warm water.
- If necessary, use a soft bristle brush with the cleaning solution.
- Rinse thoroughly using a soft cloth dampened with clean water and dry thoroughly.

2. Upholstery—Difficult stains:

- Spray the stain with a non-abrasive household cleaner such as FORMULA 409® cleaner, SIMPLE GREEN®, or a similar product.
- Rub the area gently and let it sit for a few minutes.
- Rinse thoroughly using a soft cloth dampened with clean water and dry thoroughly.
- Repeat if necessary using a soft bristle brush.

Optional method for difficult stains:

- Rub the area gently using a soft cloth dampened with rubbing alcohol.
- Rinse thoroughly using a soft cloth dampened with clean water and dry thoroughly.

CAUTION: When using any cleaning product, try it first in an inconspicuous place to ensure that there is no damage to the material. Follow the directions and adhere to the safety precautions of the manufacturer of each cleaning product used. FreeMotion Fitness and its vendors cannot be held liable for damage or injuries resulting from the use or misuse of cleaning products.

3. Frames:

- Wipe using a soft cloth dampened with a light solution of mild soap and warm water. Rinse thoroughly using a soft cloth dampened with clean water and dry thoroughly.

Important: Do not use abrasive cleaners because they may scratch the equipment. Strong cleaners and abrasives will damage decals. Use caution around decals. Do not use solvents such as lacquer thinner, kerosene, gasoline, or similar liquids.

WEEKLY

1. Hardware:

- Check all nuts and bolts. Tighten them as required. **Important:** All FREEMOTION EPIC cushions are fabricated using dense plywood with tee-nuts installed for bolting to the machine framework. Because these tee-nuts are held by the plywood, they will not withstand the torque that standard nuts and bolts will. Therefore, when tightening the cushion bolts, turn them only until they are snug and the cushion does not move or feel loose. Overtightening may strip the tee-nuts from the plywood and make it impossible to remove the cushion in the future.

2. Cables:

- Check the cable for proper tension.
- Check the entire length of the cable by pulling each handle individually to its fully extended position and inspecting the cable that is exposed on the exterior of the machine, as well as the cable inside of the cut stack tower.
- Run your fingers along the cable, paying close attention at the bends and attachment points.
- Watch for the following conditions, which may indicate a worn cable in need of replacement:
 - A. torn or split cable sheath that exposes the cable
 - B. kinked or severely bent cable
 - C. curled or twisted sheath
 - D. stretched cable sheath, showing a thinning cross-section

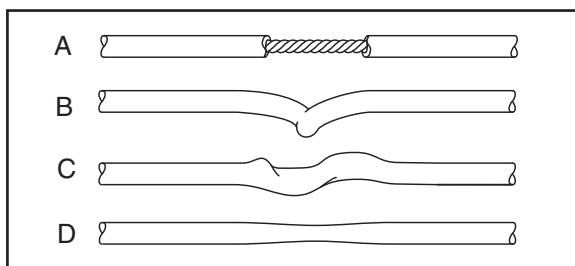

MONTHLY

1. Grips:

- Check and replace as needed.

YEARLY OR AS REQUIRED

1. Weight Stack Guide Rods:

- Clean and lubricate the full length by wiping using a soft cloth containing a lightweight motor oil; 10W-40 or 10W-30 weight. Only a light coating over the entire length is needed.

Note: Do not use TEFLON® or silicone-based lubricants.

CABLE TENSION CHECK

1. Insert the weight pin into the top weight plate.
2. Slowly raise and lower the top weight by normal machine use. The top weight should come to rest just on top of the second weight when the handle is returned to the resting position.
 - If there is too much tension on the cable, the top weight will not rest on the second weight, and it may be difficult to insert the weight pin into the weight plates.
 - If there is not enough tension on the cable, the top weight will not be lifted immediately when one of the handles is pulled. Ideally, the handle/cable should not move more than 1.5 cm (1/2 in.) from the resting position before the top weight begins to be lifted.
3. If there is too much or not enough tension on the cable, adjust the cable as described in CABLE ADJUSTMENTS.

CABLE ADJUSTMENTS

CAUTION: After making any cable adjustment, pull the handle using a light load and have someone make sure that the cable is not derailed from a pulley or rubbing on a guard (see CABLE GUARDS on page 10).

Floating Pulley Adjustment–

Tools required: Adjustable wrench/spanner

1. Lift the top weight off the weight stack and insert the weight pin into the second weight and the sixth hole from the top of the weight rod.

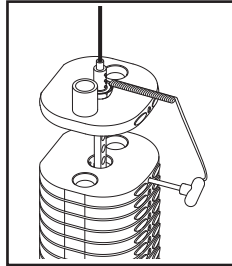

2. Rotate the cam clockwise and disengage the cam cable on the small cam.

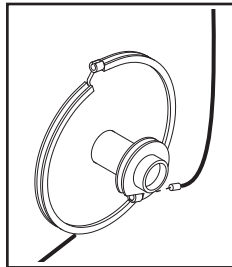

3. Loosen the nut below the “U”-bracket.

To remove slack from the cables, turn the cam cable clockwise into the “U”-bracket.

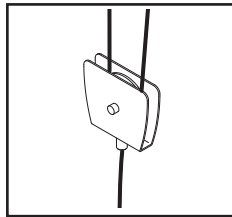

To add slack to the cables, turn the cam cable counterclockwise out of the “U”-bracket.

4. Retighten the nut against the “U”-bracket and re-engage the cam cable onto the small cam.
5. Lift the top weight and remove the weight pin. Lower the top weight onto the second weight.
6. Readjust as necessary.

Tower Pulley Adjustment–

Tools required: 5/16" hex key, 9/16" open end wrench/spanner

1. Lift the top weight off the weight stack and insert the weight pin into the second weight and the sixth hole from the top of the weight rod.

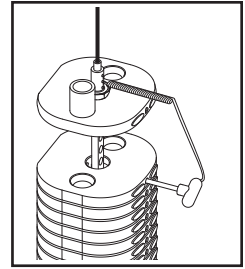

2. Loosen the locknut attaching the pulley to the bracket in the top of the tower.

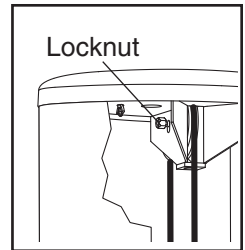

3. Move the pulley to the appropriate location in the bracket:
 - If more slack is needed in the cable, move the pulley down.
 - If less slack is needed in the cable, move the pulley up.
4. Make sure that the cable guard is properly oriented (see CABLE GUARDS on page 10) and retighten the locknut attaching the pulley to the bracket.
5. Lift the top weight and remove the weight pin. Lower the top weight onto the second weight.
6. Readjust as necessary.

Top Weight Adjustment—

Tools required: 5/32" hex key

1. If the cable needs to be shortened 2 cm (3/4 in.) or more, follow the instructions in step 1 in the right hand column on page 9. Then, go to step 2 below.
2. See the drawing in step 2 in the right hand column on page 9. Loosen the locknut and move the pulley to the bottom of the slot.
3. Lift the coupler cover from the top weight coupler. Loosen but do not remove the two set screws from each side of the weight coupler.

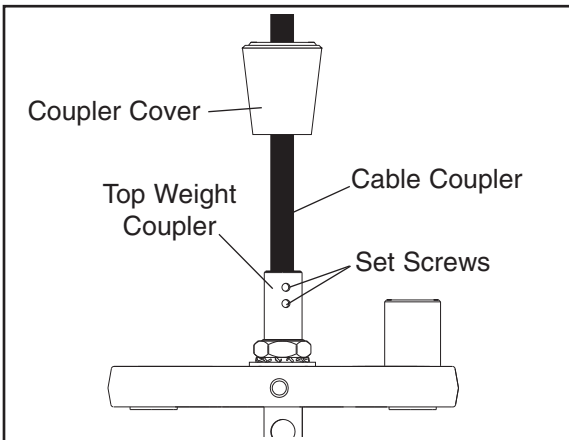

4. Pull the cable from the top weight coupler. Determine the amount the cable needs to be shortened and cut that much off the end of the cable. **The cable must be long enough to be held by the set screws without lifting the top two weights off the third weight.**
5. Cut the cable to the desired length and strip 2.5 cm (1 in.) of the vinyl sheathing from the cut end of the cable.
6. Insert the cable into the top weight coupler until all four set screws can be tightened against the cable. Tighten each set screw alternately until all four set screws have been tightened to 85 inch/pounds (9.6 Newton-meters).
7. Lower the coupler cover over the top weight coupler.

CABLE GUARDS

Check for alignment periodically to ensure that cable guards are not rubbing on the cable and that they are performing their intended duty. If the alignment is not proper, loosen the bolt slightly, readjust the cable guard as necessary, and retighten the bolt.

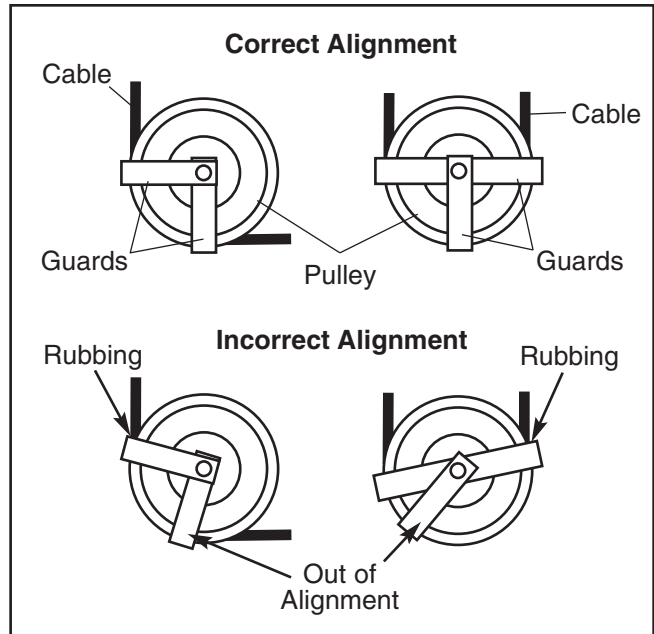

SERVICING THE WEIGHT STACK

Servicing the weight stack involves replacing the two guide bushings and weight insert in the top weight. To order these parts, see HOW TO CONTACT CUSTOMER CARE on the back cover of this manual.

1. Remove the wingnuts under the tower cap and remove the tower cap from the tower.
2. Remove the guide rod nuts and washers from the top of each guide rod.
3. Lift the coupler cover and loosen the four set screws—this will release the cable.
4. Lift the guide rods out of the top of the tower.
5. Remove the rod nut, rod star washer, and rod washer from the top of the weight tube. Lift and rotate the top weight, and remove it through the front opening of the tower.
6. Use a punch to drive the two existing guide bushings and weight insert out of the top weight.

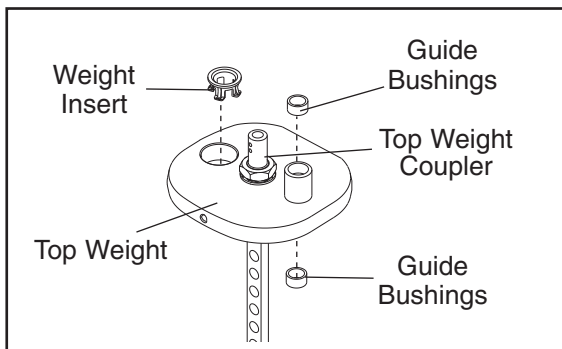

7. To insert the new bushings and weight insert, hold a bushing square to the face of one of the holes in the top weight, place a protective piece of wood on top of the bushing, and lightly tap the bushing into place. The bushing should be flush with the surface. Repeat with the other bushing and weight insert.
8. Replace the top weight. Next, tighten the rod nut, rod star washer, and rod washer onto the weight tube.
9. Reattach the cable to the top weight coupler. Retighten the four set screws into the threaded

holes. Tighten the set screws equally until they contact the cable. Then, tighten each screw alternately 1/4 turn, until all are set to 85 inch/pounds (9.6 Newton-meters).

10. Clean and lubricate the guide rods by wiping them with a soft cloth containing a lightweight motor oil, 10W-40 or 10W-30 weight. Apply only a light coating over the entire length. **Note: Do not use TEFLON® or silicone-based lubricants.**
11. Reinsert the guide rods through the top of the tower and into the weight stack. **Note: If the weight stack has shifted, use a short bar to realign the holes in the weight plates. Hold the weight plates while inserting the guide rods.**

⚠ WARNING: Do not force the guide rods into the weights; doing so will damage the bushings and weight inserts.

12. Reattach the guide rods to the top of the frame with the two guide rod nuts and washers.
13. Insert the weight pin in the top weight. Pull the handle, lifting the top weight all of the way to the top. Slowly return the handle to the resting position. If the top weight sticks, loosen one of the guide rod screws. Lift the top weight to the top again. Retighten the guide rod nut. Check the full travel again and readjust the guide screws as necessary.
14. While slowly pulling the handle, have someone check the cable guard on the top weight to ensure that it is not dragging or rubbing on the cable.
15. Replace the tower cap and retighten the wingnuts onto the bolts.

CABLE DIAGRAM

The cable diagram below shows the proper route of the cables. Use the diagram to make sure that the cables and the cable guards have been assembled correctly. If the cables have not been correctly routed, the strength equipment will not function properly and damage may occur. The numbers show the correct route of the cables. **Make sure that the cable guards do not touch or bind the cables.**

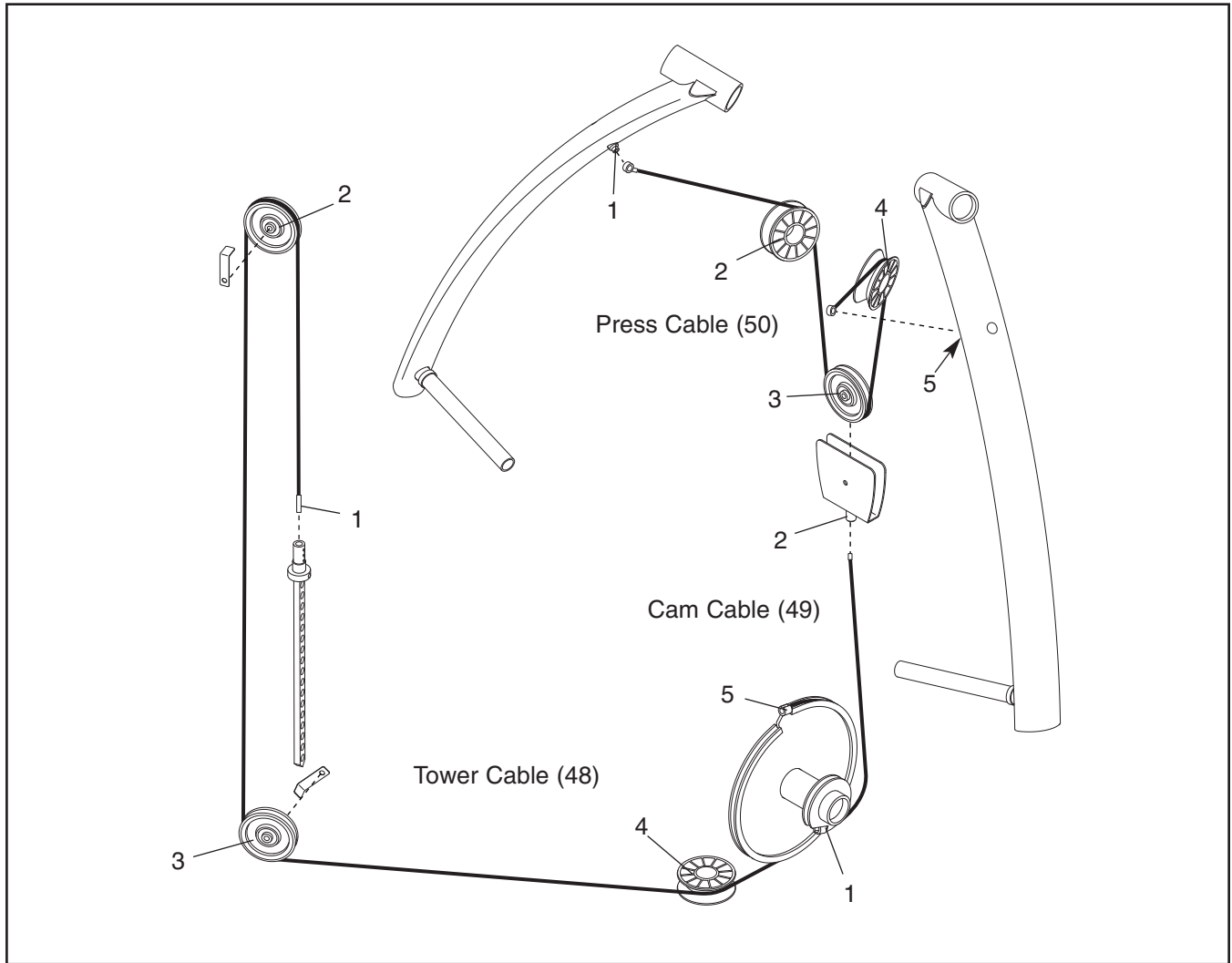

NOTES

PART LIST—Model No. GZFI8003.5

R0206A

If replacement parts are needed, or if parts are missing or damaged, see HOW TO CONTACT CUSTOMER CARE on the back cover of this manual.

Key No.	Qty.	Description	Key No.	Qty.	Description
1	1	Frame	40	2	Long Trim
2	2	Internal Pivot Bushing	41	1	Coupler Cover
3	1	Right Arm	42	1	Cover
4	1	Left Arm	43	1	Short Tower Plate
5	1	Tower	44	1	Long Tower Plate
6	2	Guide Rod	45	4	Guide Rod Nut
7	1	Tower Cap	46	4	Tower Foot
8	1	Weight Rod	47	2	Frame Foot
9	1	Top Weight	48	1	Tower Cable
10	10	10-pound Plate	49	1	Cam Cable
11	7	20-pound Plate	50	1	Press Cable
12	2	Guide Bushing	51	2	Wingnut
13	35	Weight Insert	52	1	Rod Nut
14	6	1" Bearing	53	1	Star Washer
15	2	Weight Bumper	54	1	Rod Washer
16	1	Weight Pin	55	4	Set Screw
17	1	Seat Frame	56	2	1/4" x 1" Flat Head Screw
18	1	Seat	57	12	3/8" x 1/2" Button Screw
19	1	Backrest Bracket	58	8	3/8" Nylon Locknut
20	1	Backrest	59	3	3/8" x 1 3/4" Bolt
21	1	Cam	60	4	Rivet
22	1	Long Pivot Rod	61	2	1/4" x 1" Button Bolt
23	2	Handle Grip	62	2	1/2" x 1 1/4" Bolt
24	2	Handle Bushing	63	2	3/8" x 2" Bolt
25	2	Handle Endcap	64	5	3/8" x 1" Non-patch Bolt
26	2	1/4" Spider Nut	65	2	3/8" x 2 1/2" Bolt
27	1	"U"-bracket	66	1	3/8" x 3" Bolt
28	3	Pulley	67	1	3/8" x 6 1/2" Non-patch Bolt
29	2	Cable Guard	68	2	3/8" x 1" Bolt
30	7	Pulley Washer	69	4	Bumper Spacer
31	3	"V"-pulley	70	1	3/8" Fine-thread Nut
32	1	Long Plate Frame	71	1	Bungee Cord
33	6	"V"-pulley Bearing	72	2	Wire Tie
34	6	Pivot Bushing	73	2	1/4" x 3/8" Screw
35	2	Short Pivot Rod	74	1	Anchor Strap
36	6	Pivot Washer	75	4	Guide Rod Washer
37	7	Snap Ring	76	1	Short Plate Frame
38	2	Arm Bumper	#	1	Owner's Manual
39	1	Short Trim			

Note: "#" indicates a non-illustrated part. Specifications are subject to change without notice.

EXPLODED DRAWING—Model No. GZFI8003.5

R0206A

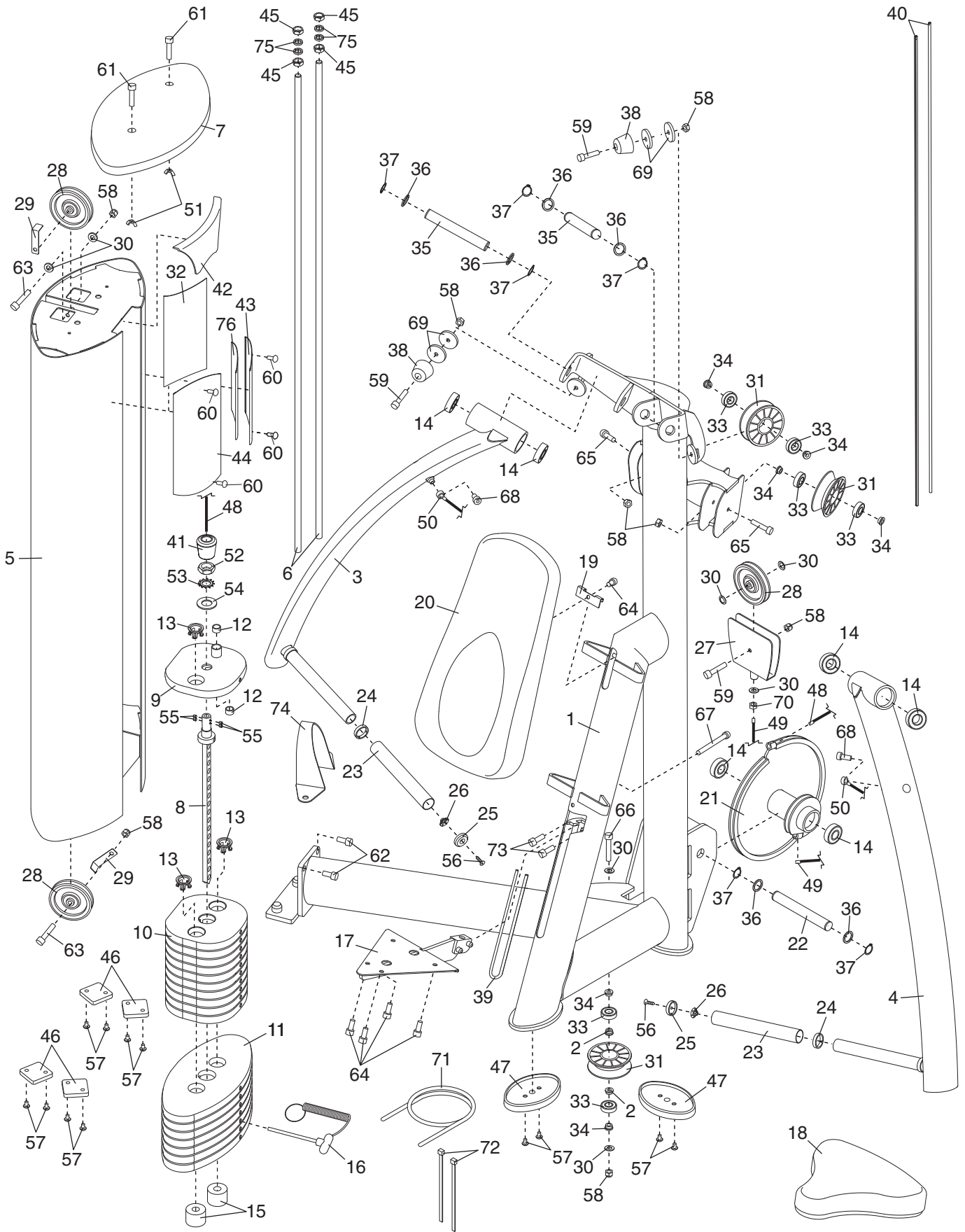

HOW TO CONTACT CUSTOMER CARE

If you have questions after reading this manual, or if you require assistance, please contact Customer Care at the address and phone number listed below. Please be prepared to give the following information:

- The MODEL NUMBER of the product (GZF18003.5).
- The NAME of the product (FREEMOTION EPIC CHEST strength equipment).
- The SERIAL NUMBER of the product (see the front cover of this manual).
- When ordering replacement parts, please also give the KEY NUMBER and DESCRIPTION of the part(s) (see the PART LIST and the EXPLODED DRAWING on pages 14 and 15 of this manual).

**Customer Care: 1-800-201-2109, Monday–Friday, 8 a.m.–5 p.m. Mountain Time
FreeMotion Fitness, Inc. • 1096 Elkton Dr., Suite 600 • Colorado Springs, CO 80907**