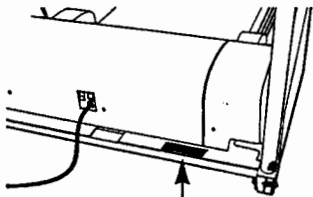

IMAGE 10.4 Q

Model No. IMTL12071

Serial No. _____

Write the serial number in the space above for future reference.



Serial Number Decal

QUESTIONS?

As a manufacturer, we are committed to providing complete customer satisfaction. If you have questions, or if there are missing or damaged parts, we will guarantee complete satisfaction through direct assistance from our factory.

TO AVOID UNNECESSARY DELAYS, PLEASE CALL DIRECT TO OUR TOLL-FREE CUSTOMER HOT LINE. The trained technicians on our Customer Hot Line will provide immediate assistance, free of charge to you.

CUSTOMER HOT LINE:

1-800-999-3756

Mon.-Fri., 6 a.m.-6 p.m. MST

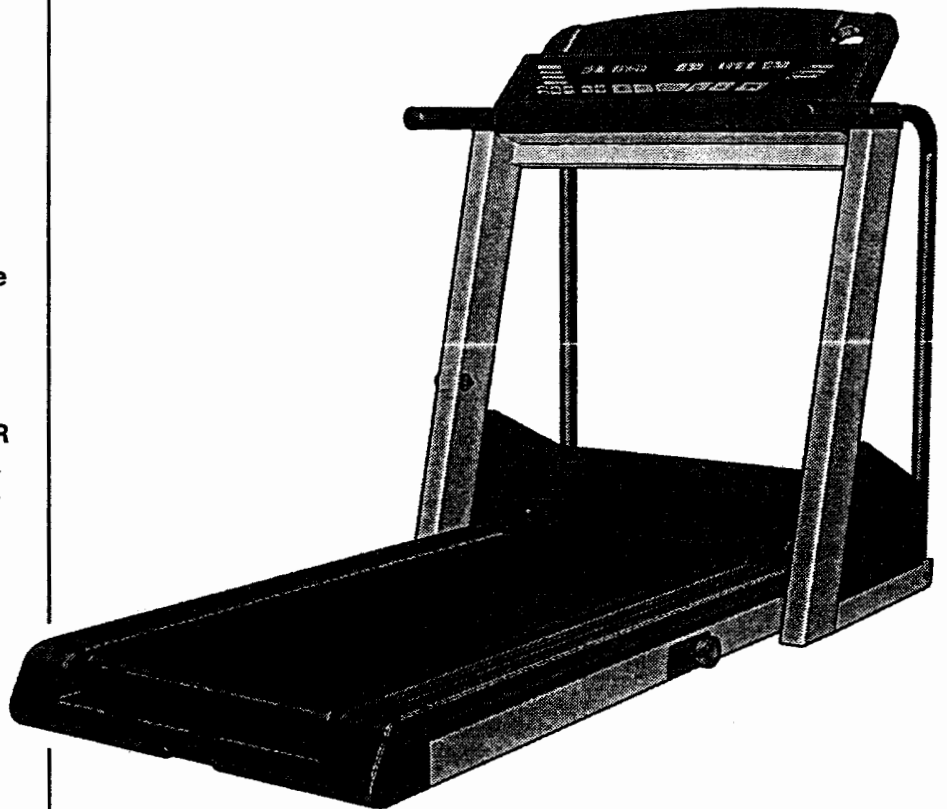

⚠ CAUTION

Read all precautions and instructions in this manual before using this equipment. Save this manual for future reference.

USER'S MANUAL

14. Never start the treadmill while you are standing on the walking belt. Always hold the handrails while using the treadmill.
15. The treadmill is capable of high speeds. Adjust the speed in small increments to avoid sudden jumps in speed.
16. To reduce the possibility of the treadmill overheating, do not operate the treadmill continuously for longer than 1 hour.
17. The heart rate monitor is not a medical device. Various factors, including the user's movement, may affect the accuracy of heart rate readings. The heart rate monitor is intended only as an exercise aid in determining heart rate trends in general.
18. Never leave the treadmill unattended while it is running. Always remove the key and move the on/off switch to the "off" position when the treadmill is not in use. (See the drawing on page 4 for the location of the on/off switch.)
19. Do not attempt to raise, lower, or move the treadmill until it is properly assembled. (See ASSEMBLY on page 5, and HOW TO MOVE

THE TREADMILL on page 16.) You must be able to safely lift 45 pounds (20 kg) in order to raise, lower, or move the treadmill.

20. When folding or moving the treadmill, make sure that the storage latch is fully closed.
21. Inspect and tighten all parts of the treadmill every three months.
22. Never insert any object into any opening.
23. The roller guards must be 1/8 inch from the rear roller. Remove the key and adjust the roller guards, if necessary.
24. Always unplug the power cord before performing the maintenance and adjustment procedures described in this manual. Never remove the motor hood unless instructed to do so by an authorized service representative. Servicing other than the procedures in this manual should be performed by an authorized service representative only.
25. This treadmill is intended for in-home use only. Do not use this treadmill in any commercial, rental, or institutional setting.

SAVE THESE INSTRUCTIONS

⚠ WARNING: Before beginning this or any exercise program, consult your physician. This is especially important for persons over the age of 35 or persons with pre-existing health problems. Read all instructions before using. ICON assumes no responsibility for personal injury or property damage sustained by or through the use of this product.

The decal shown at the right has been placed on the treadmill. If the decal is missing, or if it is not legible, please call our Customer Service Department, toll-free, to order a free replacement decal (see ORDERING REPLACEMENT PARTS on page 23). Apply the decal in the location shown.

⚠ WARNING

- Never allow children to play on or around treadmill.
- Storage latch must be fully engaged before treadmill is moved or stored.

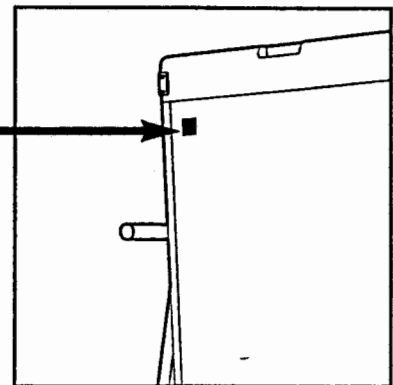

BEFORE YOU BEGIN

Thank you for selecting the IMAGE® 10.4Q treadmill. The IMAGE® 10.4Q treadmill combines advanced technology with innovative design to let you enjoy an effective form of cardiovascular exercise in the convenience and privacy of your home. And when you're not exercising, the unique IMAGE® 10.4Q can be folded up, requiring less than half the floor space of other treadmills.

For your benefit, read this manual carefully before using the treadmill. If you have additional questions, please call our Customer Service Department toll-free

at 1-800-999-3756, Monday through Friday, 6 a.m. until 6 p.m. Mountain Time (excluding holidays). To help us assist you, please note the product model number and serial number before calling. The model number of the treadmill is IMTL12071. The serial number can be found on a decal attached to the treadmill (see the front cover of this manual for the location).

Before reading further, please review the drawing below and familiarize yourself with the parts that are labeled.

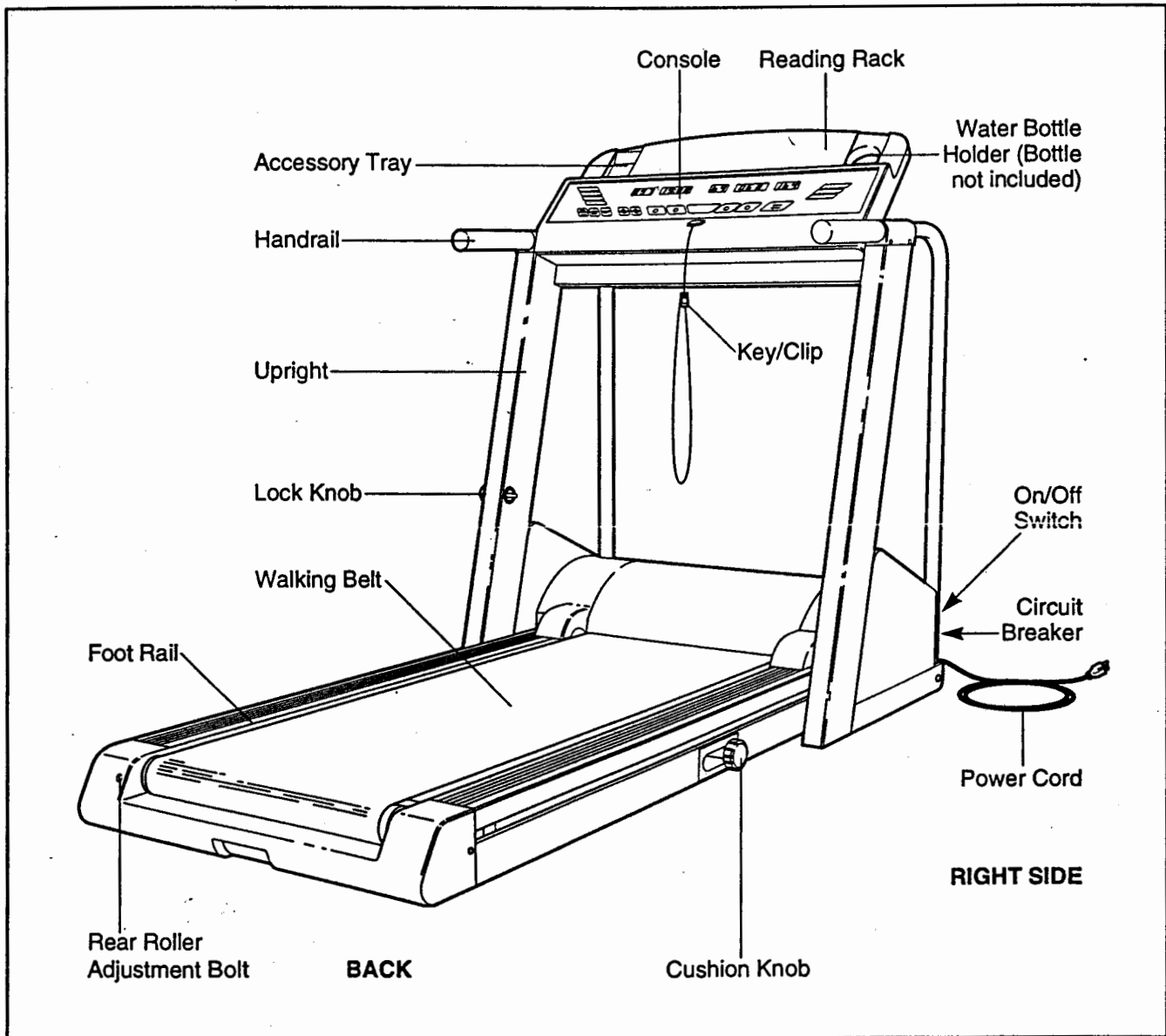

ASSEMBLY

Assembly requires two people. Set the treadmill in a cleared area and remove all packing materials. Do not dispose of the packing materials until assembly is completed. **No tools are required for assembly.**

1. With the help of a second person, carefully raise the Uprights (115) until the treadmill is in the position shown.

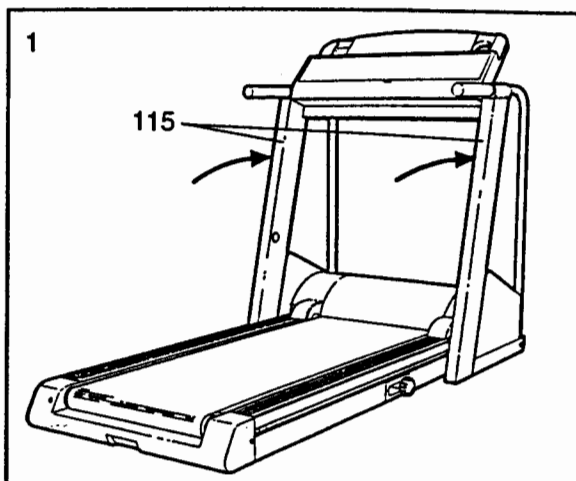

2. Press the Lock Knob Sleeve (100) into the left Upright (115).

Remove the Lock Knob (99) from the Lock Pin (103). Make sure that the Lock Pin Collar (102) and the Spring (101) are on the Lock Pin. Insert the Lock Pin into the left Upright (115) and tighten the Lock Knob onto the Lock Pin.

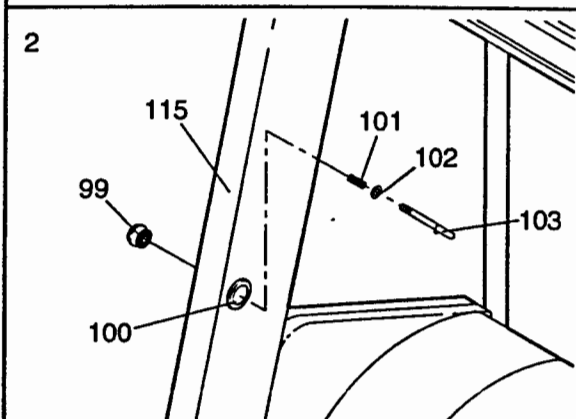

3. Remove the backing from the Adhesive Clip (94). Press the Adhesive Clip onto the base of the Uprights (115) in the indicated location. Press the Allen Wrench (95) into the Adhesive Clip.

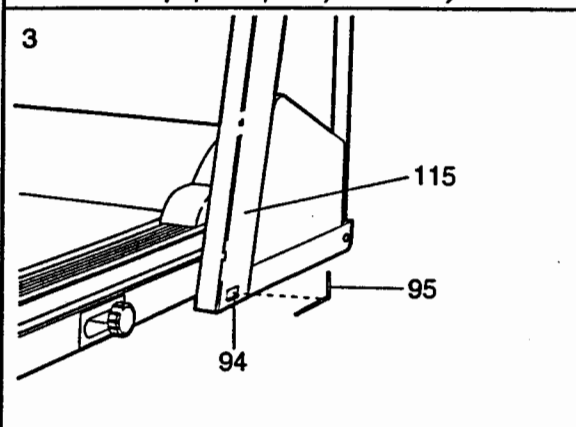

4. Make sure that all parts are tightened before you use the treadmill. Place a mat under the treadmill to protect the floor or carpet.

HOW TO USE THE HEART RATE MONITOR

HOW TO PUT ON THE HEART RATE MONITOR

The heart rate monitor consists of two components: the chest strap and the sensor unit (see the drawing below). Insert the tab on one end of the chest strap through one of the holes in the sensor unit. Press the end of the sensor unit under the buckle on the chest strap. The tab should be almost flush with the front of the sensor unit.

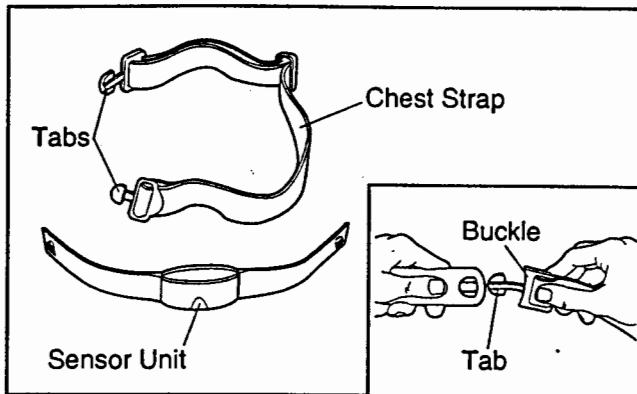

Next, wrap the heart rate monitor around your chest and attach the other end of the chest strap to the sensor unit. Adjust the length of the chest strap, if necessary. The heart rate monitor should be under your clothing, tight against your skin, and as high under the pectoral muscles or breasts as is comfortable. Make sure that the logo on the sensor unit is facing forward and is right-side-up.

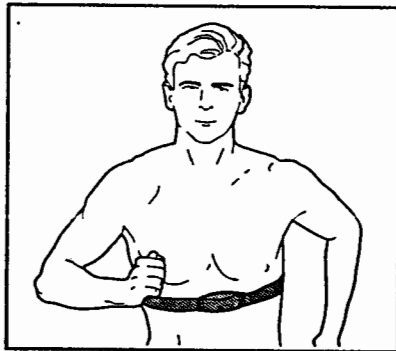

Pull the sensor unit away from your body a few inches and locate the two electrode areas on the inner side. The electrode areas are the areas covered by shallow ridges. Using saline solution such as saliva or contact lens solution, wet both electrode areas. Return the sensor unit to a position against your chest.

HEART RATE MONITOR CARE AND MAINTENANCE

Thoroughly dry the heart rate monitor after each use. The heart rate monitor is activated when the electrode areas are wetted and the heart rate monitor is put on; the heart rate monitor shuts off when it is removed and the electrode areas are dried. If the heart rate monitor is not dried after each

use, it may remain activated longer than necessary, draining the battery prematurely.

- Store the heart rate monitor in a warm, dry place. Do not store the heart rate monitor in a plastic bag or other container that may trap moisture.
- Do not expose the heart rate monitor to direct sunlight for extended periods of time; do not expose it to temperatures above 122° Fahrenheit (50° Celsius) or below 14° Fahrenheit (-10° Celsius).
- Do not excessively bend or stretch the sensor unit when using or storing the heart rate monitor.
- Clean the sensor unit using a damp cloth—never use alcohol, abrasives, or chemicals. The chest strap may be hand washed and air dried.

HEART RATE MONITOR TROUBLE-SHOOTING

The instructions on the following pages explain how the heart rate monitor is used with the console. If the letters "PLS" appear in the CALS./FAT CALS./PULSE display or if the displayed heart rate is excessively high or low, try the steps below.

- Make sure that the heart rate monitor is under your clothing, tight against your skin, and as high under the pectoral muscles or breasts as is comfortable. The logo on the sensor unit must be facing forward and be right-side-up. Note: If the heart rate monitor does not function when positioned as described, try moving it slightly lower or higher on your chest.
- Use saline solution such as saliva or contact lens solution to wet the two electrode areas on the sensor unit. If heart rate readings do not appear until you begin perspiring, re-wet the electrode areas.
- As you walk or run on the treadmill, position yourself near the center of the walking belt. For the console to display heart rate readings, the user must be within arm's length of the console.
- The heart rate monitor is designed to work with people who have normal heart rhythms. Heart rate reading problems may be caused by medical conditions such as premature ventricular contractions (pvc's), tachycardia bursts, and arrhythmia.
- The operation of the heart rate monitor can be affected by magnetic interference caused by high power lines or other sources. If it is suspected that magnetic interference may be causing a problem, try relocating the treadmill.

OPERATION AND ADJUSTMENT

THE PERFORMANT LUBE™ WALKING BELT

Your treadmill features a walking belt coated with PERFORMANT LUBE™, a high-performance lubricant. **Important: Never apply silicone spray or other substances to the walking belt or the walking platform. They will deteriorate the walking belt and cause excessive wear.**

HOW TO PLUG IN THE POWER CORD

⚠ DANGER: Improper connection of the equipment-grounding conductor can result in an increased risk of electric shock. Check with a qualified electrician or serviceman if you are in doubt as to whether the product is properly grounded. Do not modify the plug provided with the product—if it will not fit the outlet, have a proper outlet installed by a qualified electrician.

Your treadmill, like any other type of sophisticated electronic equipment, can be seriously damaged by sudden voltage changes in your home's power. Voltage surges, spikes, and noise interference can result from weather conditions or from other appliances being turned on or off.

To decrease the possibility of your treadmill being damaged, always use a surge protector (not included) with your treadmill.

Surge protectors are sold at most hardware stores and department stores. Use only a UL-listed surge protector, rated at 15 amps, with a 14-gauge cord of five feet or less in length.

This product must be grounded. If it should malfunction or break down, grounding provides a path of least resistance for electric current to reduce the risk of

electric shock. This product is equipped with a cord having an equipment-grounding conductor and a grounding plug. Plug the power cord into a surge protector, and plug the surge protector into an appropriate outlet that is properly installed and grounded in accordance with all local codes and ordinances.

This product is for use on a nominal 120-volt circuit, and has a grounding plug that looks like the plug illustrated in drawing 1 below. A temporary adapter that looks like the adapter illustrated in drawing 2 may be used to connect the surge protector to a 2-pole receptacle as shown in drawing 2 if a properly grounded outlet is not available.

The temporary adapter should be used only until a properly grounded outlet (drawing 1) can be installed by a qualified electrician.

The green-colored rigid ear, lug, or the like extending from the adapter must be connected to a permanent ground such as a properly grounded outlet box cover. Whenever the adapter is used it must be held in place by a metal screw. Some 2-pole receptacle outlet box covers are not grounded. Contact a qualified electrician to determine if the outlet box cover is grounded before using an adapter.

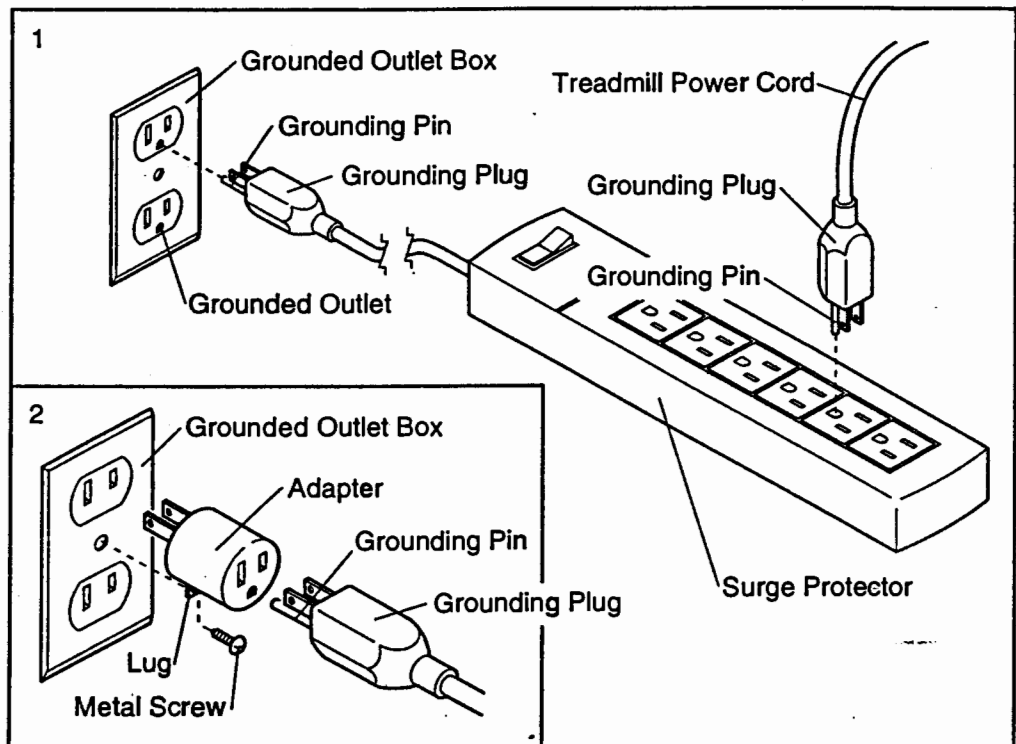
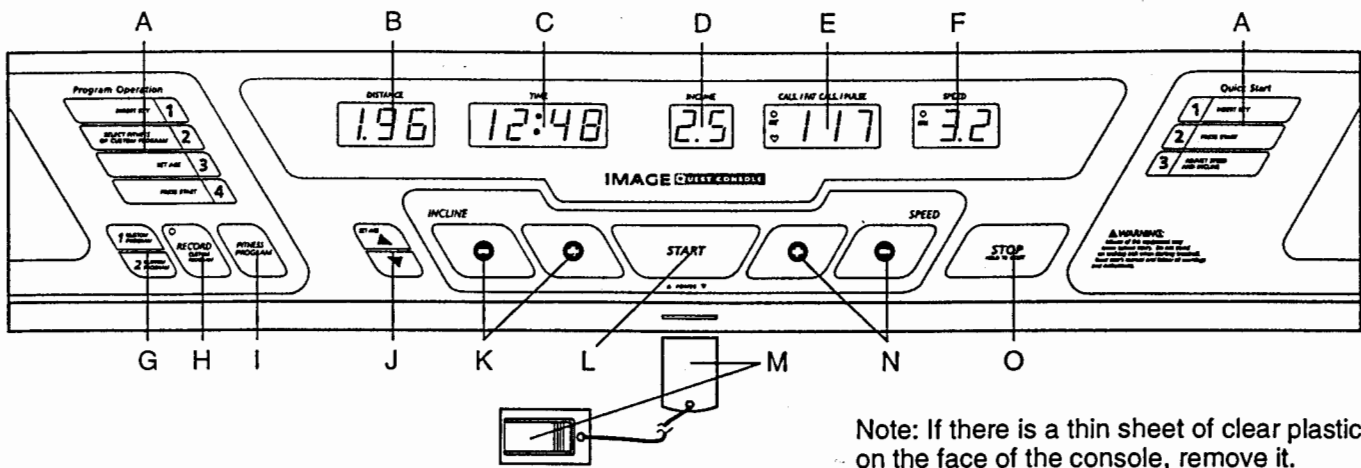

DIAGRAM OF THE CONSOLE



CAUTION: To reduce the risk of serious injury, read the following precautions before operating the console.

- Do not stand on the walking belt when turning on the power or starting the walking belt.
- Always wear the clip (see part "M" in the drawing above) while operating the treadmill. If the key is pulled from the console, the walking belt will stop.
- The treadmill is capable of high speeds. Adjust the speed in small increments.
- The heart rate monitor is not a medical device. Various factors may affect the accuracy of heart rate readings. The heart rate monitor is intended only as an exercise aid in determining heart rate trends in general.
- To reduce the risk of electric shock, keep the console dry, avoid spilling liquids on the console, and use only a sealable water bottle.

FEATURES OF THE CONSOLE

The treadmill console offers an impressive array of features designed to make your workouts more effective.

When the console is in the manual mode, the speed and incline of the treadmill can be changed with a touch of a button. As you exercise, the five displays will provide continuous exercise feedback. The console also features two custom workout programs. Each custom program automatically controls the speed and the incline of the treadmill according to settings that you program. In addition, the console offers a unique fitness program that measures the relative fitness level you have achieved.

To use the manual mode, follow the steps beginning on page 10. To create a custom program, see page 12. To use a custom program, see page 13. To use the fitness program, see page 14.

Note: The console can display speed and distance in either miles or kilometers (see SPEED DISPLAY on page 11). For simplicity, all instructions in this section refer to miles.

DIAGRAM OF THE CONSOLE

Refer to the drawing on the opposite page.

- A. Step-by-step instructions—These instructions provide a quick overview of console operation.
- B. DISTANCE display—This display shows the distance that you have walked or run. Note: This display is also used to enter your age into the console.
- C. TIME display—When the console is in the manual mode, or when the fitness program is selected, this display shows the elapsed time. If a custom program is selected, the display will show the time remaining in the program.
- D. INCLINE display—This display shows the incline level of the treadmill.
- E. CALORIES/FAT CALORIES/PULSE display—This display shows three different numbers: the approximate number of calories you have burned, the number of fat calories you have burned, and your heart rate (if the heart rate monitor is worn). The display will change from one number to the next every seven seconds.
- F. SPEED display—This display shows the speed of the walking belt.
- G. CUSTOM PROGRAM buttons—These buttons are used to select custom programs 1 and 2.
- H. RECORD button—This button is used to create and modify custom programs.
- I. FITNESS PROGRAM button—This button is used to select the fitness program.
- J. SET AGE buttons—These buttons are used to enter your age into the console. Your age must be entered when the fitness program is used.
- K. INCLINE buttons—These buttons are used to change the incline of the treadmill. The incline range is 1% to 12%.
- L. START button—This button is used to start the walking belt when the manual mode, a custom program, or the fitness program is selected.
- M. Key with clip—The key turns the console on and off. The clip is designed to be worn on the waistband of your clothes.
- N. SPEED buttons—These buttons are used to change the speed of the walking belt. The speed range is 0.5 mph to 10 mph. Note: When the START button is pressed, the walking belt will begin to move at 1.0 mph.
- O. STOP button—This button is used to pause or stop the walking belt.

Note: Each time one of the buttons is pressed, a tone will sound. If an invalid button press is made (for example, if a SPEED button is pressed while the walking belt is stationary), a different tone will sound.

HOW TO TURN ON THE POWER

- 1 Make sure that the on/off switch, located on the front of the treadmill, is in the "on" position.

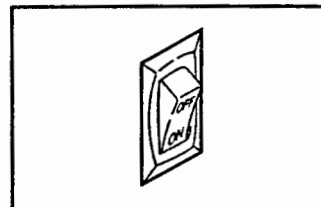

- 2 Plug in the power cord (see page 7). All displays and indicators on the console will flash once and then darken. Note: If the key is in the console when the power cord is plugged in, the letters "PO" will flash in the SPEED display. If this occurs, remove the key.

- 3 Stand on the foot rails of the treadmill and insert the key into the console. After a moment, the five displays will light.

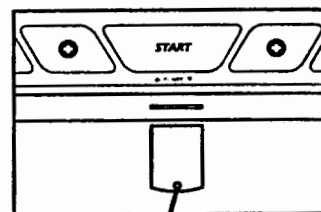

HOW TO USE THE MANUAL MODE

1 Insert the key into the console.

See HOW TO TURN ON THE POWER on page 9.

2 Select the MANUAL mode.

When the key is inserted, the manual mode will automatically be selected. If a custom program or the fitness program has been selected, hold down the STOP button for two seconds to select the manual mode.

3 Put on the heart rate monitor if desired.

For the console to show your heart rate, the heart rate monitor must be worn. To put on the heart rate monitor, see HOW TO USE THE HEART RATE MONITOR on page 6.

4 Press the START button.

After a moment, the walking belt will begin to move at 1.0 mph. Hold the handrails and step onto the walking belt.

To stop the walking belt temporarily, press the STOP button. All displays will pause and the TIME display will begin to flash. To restart the walking belt, press the START button. To stop the walking belt and reset the displays, hold down the STOP button for two seconds. The console will then be in the same state as if the key had just been inserted.

5 Adjust the speed and Incline of the treadmill.

While the walking belt is moving, adjust the speed of the walking belt by pressing the SPEED buttons. Each time one of the

buttons is pressed, the speed will change by 0.1 mph. If one of the buttons is held down, the speed will change in increments of 0.5 mph. The speed range is 0.5 mph to 10 mph. Note: When the SPEED buttons are pressed, the SPEED display will show the selected speed setting for three seconds. The display will then show the actual speed of the walking belt.

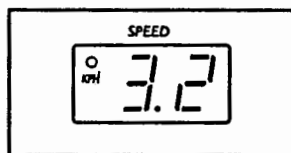

The incline of the treadmill can be adjusted with the INCLINE buttons.

Each time one of the buttons is pressed, the incline will change by 0.5%. The buttons can be held down to change the incline quickly. The incline range is 1% to 12%. Note: After the buttons are pressed, it may take a moment for the treadmill to reach the selected incline setting. Because the INCLINE display has only two digits, the display will show a "10" when the incline is set at either 10% or 10.5%.

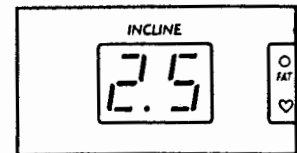

6 Follow your progress with the five displays.

DISTANCE display—This display shows the distance that you have walked or run. Note: If the KPH indicator in the SPEED display is

lit, the distance will be shown in kilometers; if the indicator is dark, the distance will be shown in miles (see SPEED DISPLAY on page 11).

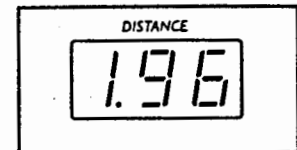

TIME display—This display shows the elapsed time. (If a custom program is selected, the display will show the time remaining in the program.)

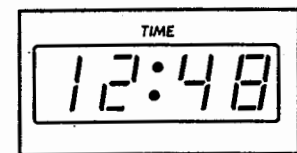

INCLINE display—This display shows the incline level of the treadmill.

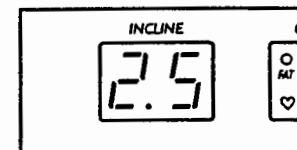

CALS./FAT CALS./ PULSE display—This display shows three different numbers: the approximate number of calories you have

burned, the number of fat calories you have burned, and your heart rate (if the heart rate monitor is worn). The display will change from one number to the next every seven seconds. (If the fitness program is selected, your heart rate will be displayed continuously). When your heart rate is shown, the heart-shaped indicator in the display will flash with each heartbeat; when the number of fat calories is shown, the "fat" indicator will light; when the number of calories is shown, no indicator will light. Note: When the heart rate monitor is first put on, it may take up to ten seconds for an accurate heart rate to be shown.

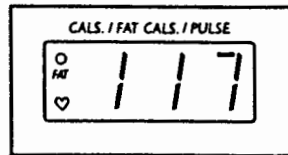

SPEED display—This display shows the speed of the walking belt. If the KPH indicator in the display is lit, the speed will be shown in kilometers per hour; if the indicator is dark, the speed will be shown in miles per hour.



Note: To change the unit of measurement, first hold down the STOP button while inserting the key into the console. The CALS./FAT CALS./ PULSE display will show an "E" for "English" (miles) or an "M" for "Metric" (kilometers). Press the SPEED "+" button to change the unit of measurement. Remove and then reinsert the key.

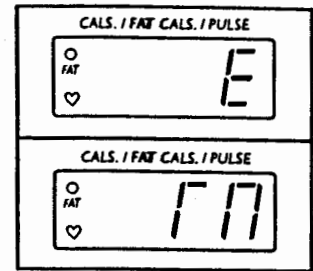

7 When you are finished exercising, stop the walking belt and remove the key.

Step onto the foot rails, press the STOP button, and remove the key from the console. Store the key in a secure place. In addition, press the on/off switch to the "off" position. (See the drawing on page 9.)

HOW TO CREATE A CUSTOM PROGRAM

Custom programs are workout programs that you create. Custom programs automatically control both the speed and the incline of the treadmill, and can be up to 40 minutes long. The programs are stored in the console's memory, and can be changed as many times as desired. Follow the steps below to create a custom program.

1 Insert the key into the console.

See HOW TO TURN ON THE POWER on page 9.

2 Select one of the custom programs.

To select one of the custom programs, press the CUSTOM PROGRAM 1 or 2 button. The letters "CP1" or "CP2" will

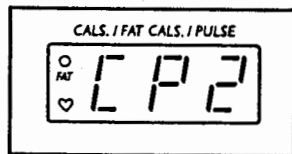

appear in the CALC./FAT CALC./PULSE display to show which program you have selected. The TIME display will show that the program is preset to last for 40 minutes. (The program can be set to last for a shorter length of time, as explained later.) Note: If the walking belt is moving when the CUSTOM PROGRAM 1 or 2 button is pressed, the walking belt will slow to a stop. In addition, if the incline of the treadmill is higher than 1%, it will automatically decrease to 1%.

3 Put on the heart rate monitor if desired.

For the console to show your heart rate, the heart rate monitor must be worn. To put on the heart rate monitor, see HOW TO USE THE HEART RATE MONITOR on page 6.

4 Press the START button.

After a moment, the walking belt will begin to move at 1.0 mph. Hold the handrails and step onto the walking belt.

5 Press the RECORD button and program the desired speed and incline settings.

When the RECORD button is pressed, the indicator on the button will light. **Speed and incline settings can be programmed only when the indicator on the button is lit.**

Each custom program is divided into one-minute periods. One speed setting and one incline setting can be programmed for each period. To program speed and incline settings for the first one-minute period of the program, simply adjust the speed and incline of the treadmill as desired with the SPEED and INCLINE buttons.

When the first one-minute period of the program is completed, the current speed and incline settings will be stored in the console's memory. Program speed and incline settings for the second one-minute period as described above.

Repeat this procedure until you have programmed speed and incline settings for as many one-minute periods as desired. Custom programs can have up to forty periods.

Note: To pause a custom program temporarily, press the STOP button. All displays will pause and the TIME display will begin to flash. To restart the program, press the START button.

6 Hold down the STOP button for two seconds.

When you have programmed speed and incline settings for as many one-minute periods as desired, hold down the STOP button for two seconds. The speed and incline settings that you programmed and the length of the program will then be stored in the console's memory. To use the program again, see HOW TO USE A CUSTOM PROGRAM at the right.

7 Remove the key from the console.

When the program is completed, remove the key from the console. Store the key in a secure place. In addition, press the on/off switch to the "off" position. (See the drawing on page 9.)

HOW TO USE A CUSTOM PROGRAM

1 Insert the key into the console.

See HOW TO TURN ON THE POWER on page 9.

2 Select one of the custom programs.

To select one of the custom programs, press the CUSTOM PROGRAM 1 or 2 button. The letters "CP1" or "CP2" will

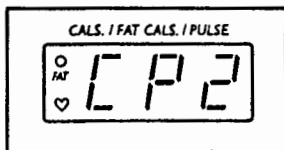

appear in the CALS./FAT CALS./PULSE display to show which program you have selected. The TIME display will show how long the program will last.

Note: If the walking belt is moving when the CUSTOM PROGRAM 1 or 2 button is pressed, the walking belt will slow to a stop. In addition, if the incline of the treadmill is higher than 1%, it will automatically decrease to 1%.

3 Put on the heart rate monitor if desired.

For the console to show your heart rate, the heart rate monitor must be worn. To put on the heart rate monitor, see HOW TO USE THE HEART RATE MONITOR on page 6.

4 Press the START button.

After a moment, the walking belt will begin to move. Hold the handrails and step onto the walking belt.

During the first one-minute period of the program, the speed and incline of the treadmill will automatically adjust to the first settings that you programmed previously. When the first one-minute period is completed, the speed and incline of the treadmill will automatically change to the second settings that you programmed. The program will continue in this manner until no time remains in the TIME display. The walking belt will then slow to a stop.

To stop the walking belt temporarily, press the STOP button. All displays will pause and the TIME display will begin to flash. To restart the walking belt, press the START button. To stop the walking belt and end the program, hold down the STOP button for two seconds. The console will then be in the same state as if the key had just been inserted.

Note: While a custom program is running, the speed and incline of the treadmill can be adjusted with the SPEED and INCLINE buttons. Adjustments will not be stored in the console's memory. To reprogram the speed and incline settings of the current period of the program, press the RECORD button. The indicator on the button will light. **Speed and incline settings can be reprogrammed only when the indicator on the button is lit.** Next, adjust the speed and incline of the treadmill with the SPEED and INCLINE buttons. When the current period is completed, the new speed and incline settings will be stored in memory. When you have reprogrammed speed and incline settings for as many periods as desired, press the RECORD button again.

5 Follow your progress with the five displays.

Refer to step 6 on page 10.

6 Remove the key from the console.

When the program has ended, remove the key from the console. Store the key in a secure place. In addition, press the on/off switch to the "off" position. (See the drawing on page 9.)

HOW TO USE THE FITNESS PROGRAM

The fitness program is designed to measure the relative fitness level you have achieved. For the best results, the fitness program should be used at a time when your energy level is high; the fitness program should not be used if you have already exercised during the day.

The fitness program consists of seven 4-minute periods, and is followed by a 2-minute cool-down period. The speed and/or incline of the treadmill will automatically increase at the beginning of each 4-minute period. To use the fitness program, follow the steps below.

1 Insert the key into the console.

See HOW TO TURN ON THE POWER on page 9.

2 Select the fitness program.

To select the fitness program, press the FITNESS PROGRAM button. The letters "FP" will appear in the CALS./FAT CALS./PULSE display and the letters "AGE" will flash in the DISTANCE display. Note: If the walking belt is moving when the FITNESS PROGRAM button is pressed, the walking belt will slow to a stop. In addition, if the incline of the treadmill is higher than 1%, it will automatically decrease to 1%.

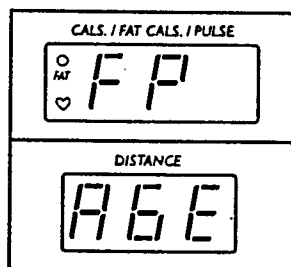

3 Enter your age into the console.

You must enter your age to use the fitness program.

Press either of the SET AGE buttons.

The current age setting will appear in the DISTANCE display. To enter your age, press the SET AGE buttons again. Each time one of the buttons is pressed, the age setting will change by 1 year. If one of the buttons is held down, the age setting will change in increments of 5 years. Once your age is entered, it will be saved in the console's memory. **Note: If you have already entered your age, you must press one of the SET AGE buttons to verify the age setting before the fitness program can be started.**

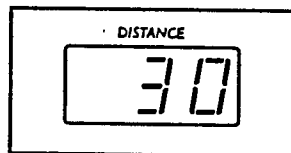

4 Put on the heart rate monitor.

The heart rate monitor must be worn when the fitness program is used. To put on the heart rate monitor, see HOW TO USE THE HEART RATE MONITOR on page 6. Note: The fitness program can be started without your heart rate being detected; however, the program will automatically stop if your heart rate is not detected 4 minutes after the program is started.

5 Press the START button.

When the START button is pressed, the TIME display will begin counting up and the DISTANCE display will show an "L 1" (level 1), indicating that the first 4-minute period of the fitness program has begun. The incline of the treadmill will automatically adjust to 2.0% and the walking belt will begin to move at 1.5 mph. Hold the handrails and step onto the walking belt.

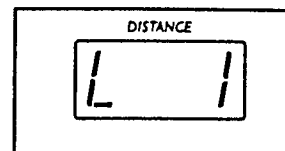

When the first 4-minute period of the fitness program is completed, the DISTANCE display will show an "L 2," indicating that the second 4-minute period has begun. The incline and speed of the treadmill will then increase. When the second 4-minute period is completed, the DISTANCE display will show an "L 3." The incline will remain the same, but the speed will then increase. At the beginning of each 4-minute period, the speed and/or incline of the treadmill will automatically increase. The fitness program will continue in this manner until your heart rate reaches 70% of your theoretical maximum heart rate, and the current 4-minute period is completed. The fitness program will then be completed, regardless of how many periods remain.

When the fitness program is completed, the letter "C" will appear in the DISTANCE display, indicating that the cool-down period has begun. The TIME display will count down from 2 minutes.

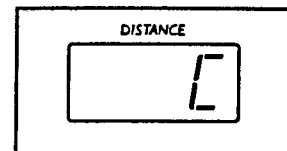

When the cool-down period is completed, the walking belt will slow to a stop. **Note: During the last ten seconds of the cool-down period, the incline of the treadmill will automatically adjust to 1%. Keep your feet and objects from beneath the treadmill.** After the fitness program is completed, your fitness level will be shown in the TIME display. There are ten fitness levels—fitness level 10 (FL:10) is the highest. Remember, the fitness program is intended only to indicate your relative fitness level.

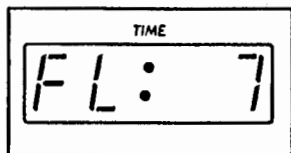

Note: The SPEED and INCLINE buttons will not function while the fitness program is selected. If your pulse is not detected during the program, the letters "PLS" will flash in the CALS./FAT CALS./PULSE display. If your pulse is not detected during the last thirty seconds of any 4-minute period (after 4 minutes, after 8 minutes, etc.), the fitness program will end and the TIME display will show a fitness level of 0 (FL: 0). (See HEART RATE MONITOR TROUBLE-SHOOTING on page 6.) The fitness program cannot be stopped temporarily and then restarted. However, the program can be stopped at any time by pressing the STOP button. The TIME display will then show an estimated fitness level.

6 Remove the key from the console.

When the program is completed, remove the key from the console. Store the key in a secure place. In addition, press the on/off switch to the "off" position. (See the drawing on page 9.)

HOW TO SELECT THE INFORMATION MODE

The console features an information mode that keeps track of the total time and distance accumulated on the treadmill. To access the information mode, hold down the STOP button while inserting the key into the console. Continue to hold down the STOP button until the following information is displayed:

The DISTANCE display will show the total number of miles accumulated on the treadmill.

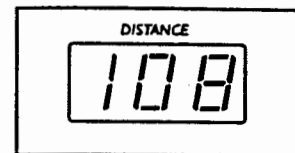

The TIME display will show the total number of hours accumulated on the treadmill.

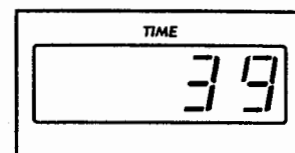

The CALS./FAT CALS./PULSE display will show an "E" for "English" (miles) or an "M" for "Metric" (kilometers). **Note:** Press the SPEED "+" button to change the unit of measurement.

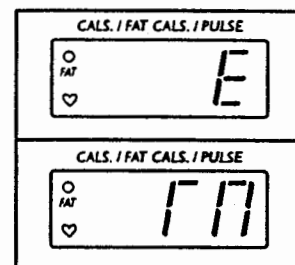

To exit the information mode, remove the key from the console.

HOW TO ADJUST THE FIRMNESS OF THE WALKING PLATFORM

The walking platform is specially designed to cushion the impact as you walk or run on the treadmill. The firmness of the walking platform can be adjusted with the

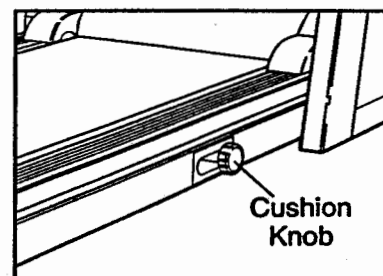

knob on the right side of the treadmill. For a firmer walking platform, turn the knob counterclockwise. For a softer walking platform, turn the knob clockwise. **Note:** The faster you run on the treadmill, the firmer the walking platform should be. If the walking platform is too soft, the treadmill may bounce excessively.

HOW TO FOLD AND MOVE THE TREADMILL

HOW TO FOLD THE TREADMILL FOR STORAGE

Before folding the treadmill, unplug the power cord. **Caution: You must be able to safely lift 45 pounds (20 kg) in order to raise, lower, or move the treadmill.**

1. Hold the treadmill with your hands in the locations shown at the right. **To decrease the possibility of injury, bend your legs and keep your back straight. As you raise the treadmill, make sure to lift with your legs rather than your back.** Raise the treadmill about halfway to the vertical position.

2. Move your right hand to the position shown and hold the treadmill firmly. Hold the lock knob with your left hand and pull it to the side. Raise the treadmill until the lock knob is aligned with the catch. Slowly release the knob. **Make sure that the pin on the lock knob is inside of the catch.**

To protect the floor or carpet from damage, place a mat under the treadmill. Keep the treadmill out of direct sunlight. Do not leave the treadmill in the storage position in temperatures above 85° Fahrenheit.

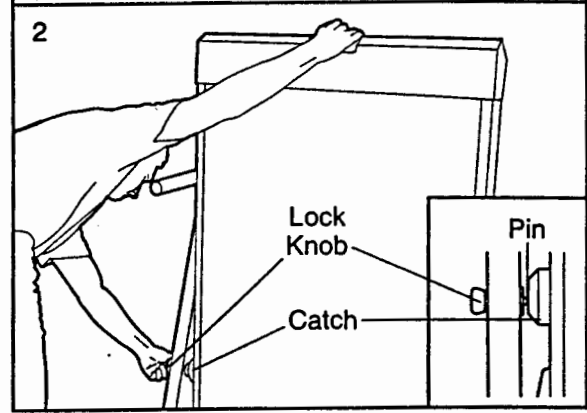
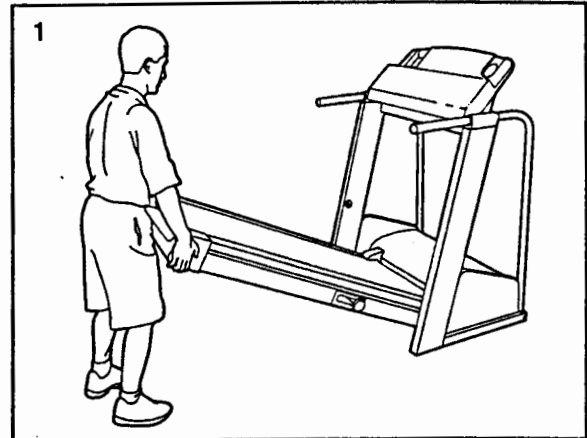

HOW TO MOVE THE TREADMILL

Before moving the treadmill, convert the treadmill to the storage position as described above. **Make sure that the pin on the lock knob is inside of the catch.**

1. Hold the handrails and place one foot on the base as shown.
2. Tilt the treadmill back until it rolls freely on the front wheels. Carefully move the treadmill to the desired location. **Never move the treadmill without tipping it back. To reduce the risk of injury, use extreme caution while moving the treadmill. Do not move the treadmill over an uneven surface.**
3. Place one foot on the base and carefully lower the treadmill until it is resting on the base.

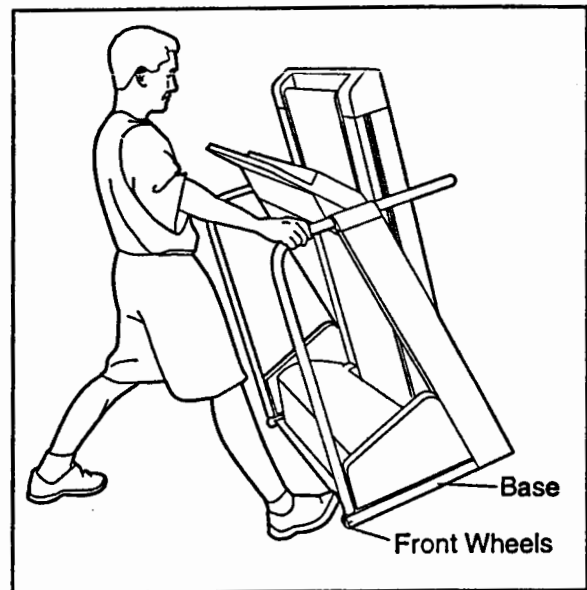

HOW TO LOWER THE TREADMILL FOR USE

1. Hold the upper end of the treadmill with your right hand as shown. Hold the lock knob with your left hand and pull it to the side. Pivot the treadmill down a few inches.

2. Hold the treadmill firmly with both hands, and lower the treadmill to the floor. **To decrease the possibility of injury, bend your legs and keep your back straight.**

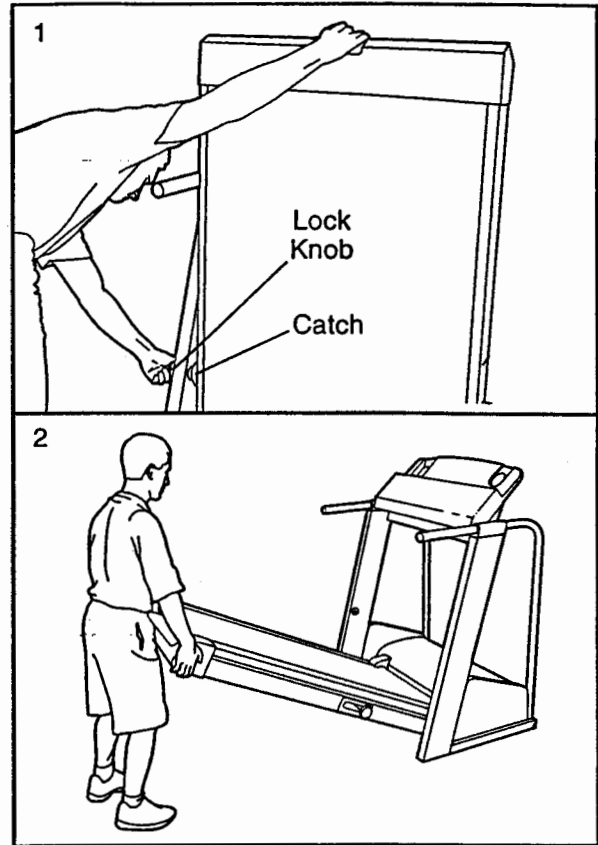

MAINTENANCE AND TROUBLE-SHOOTING

Most treadmill problems can be solved by following the steps below. Find the symptom that applies, and follow the steps listed. If further assistance is needed, please call our Customer Service Department toll-free at 1-800-999-3756, Monday through Friday, 6 a.m. until 6 p.m. Mountain Time (excluding holidays).

1. SYMPTOM: THE POWER DOES NOT TURN ON

- Make sure that the power cord is plugged into a surge protector, and that the surge protector is plugged into a properly grounded outlet. (See HOW TO PLUG IN THE POWER CORD on page 7.) Use only a UL-listed surge protector, rated at 15 amps, with a 14-gauge cord of five feet or less in length.
- After the power cord has been plugged in, make sure that the key is fully inserted into the console. (See step 3 on page 9.)
- Check the circuit breaker located on the treadmill near the power cord. If the switch protrudes as shown, the circuit breaker has tripped. To reset the circuit breaker, wait for five minutes and then press the switch back in.
- Check the on/off switch located at the front of the treadmill near the power cord. The switch must be in the "on" position.

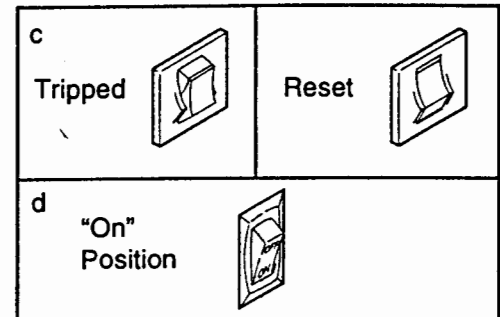

2. SYMPTOM: THE POWER TURNS OFF DURING USE

- Check the circuit breaker located on the treadmill frame near the power cord (see 1. c. above). If the circuit breaker has tripped, wait for five minutes and then press the switch back in.
- Make sure that the power cord is plugged in.
- Remove the key from the console. Reinsert the key fully into the console. (See step 3 on page 9.)
- Make sure that the on/off switch is in the "on" position. (See 1. d. above.)
- If the treadmill still will not run, please call our Customer Service Department, toll-free.

3. SYMPTOM: THE WALKING BELT SLOWS WHEN WALKED ON

- Use only a UL-listed surge protector, rated at 15 amps, with a 14-gauge cord of five feet or less in length.
- If the walking belt still slows when walked on, please call our Customer Service Department, toll-free.

4. SYMPTOM: THE WALKING BELT IS OFF-CENTER WHEN WALKED ON

- If the walking belt has shifted to the left, first remove the key and **UNPLUG THE POWER CORD**. Using the allen wrench, turn the left adjustment bolt clockwise 1/4 of a turn. Plug in the power cord, insert the key and run the treadmill for a few minutes. Repeat until the walking belt is centered.

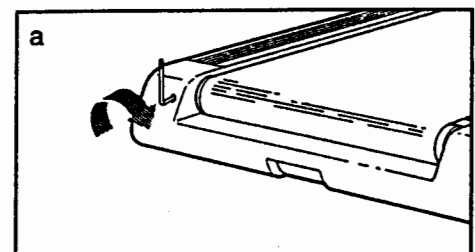

- b. If the walking belt has shifted to the right, first remove the key and **UNPLUG THE POWER CORD**. Using the allen wrench, turn the left adjustment bolt counterclockwise 1/4 of a turn. Plug in the power cord, insert the key and run the treadmill for a few minutes. Repeat until the walking belt is centered.

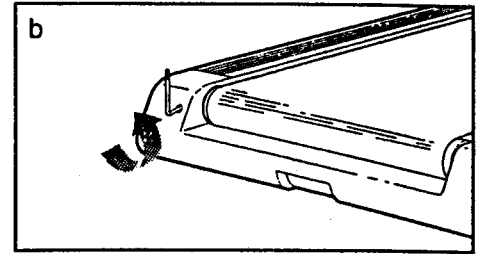

5. SYMPTOM: THE HEART RATE MONITOR DOES NOT FUNCTION PROPERLY

- a. If the heart rate monitor does not function properly, refer to HEART RATE MONITOR TROUBLESHOOTING on page 6.
- b. If the heart rate monitor still does not function properly, the battery should be changed. To replace the battery, locate the battery cover on the back of the sensor unit. Insert a coin into the slot in the cover and turn the cover counterclockwise to the "open" position. Remove the cover.

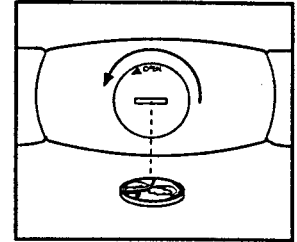

Remove the old battery from the sensor unit. Insert a new battery, making sure that the writing is on top. In addition, make sure that the rubber gasket is in place in the sensor unit. Replace the battery cover and turn it to the closed position.

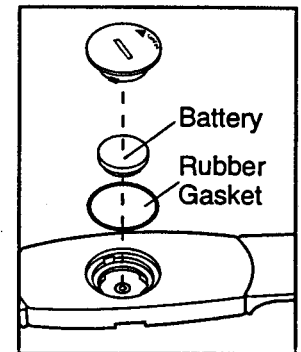

6. SYMPTOM: AN ERROR CODE (E1, E20, E21, E22, E23, OR E24) APPEARS ON THE CONSOLE

- a. If an error code appears, remove the key from the console, wait for a moment, and then reinsert it. If the error code appears again, call our Customer Service Department. Do not use the treadmill until the problem is corrected.

CONDITIONING GUIDELINES

⚠ WARNING: Before beginning this or any exercise program, consult your physician. This is especially important for individuals over the age of 35 or individuals with pre-existing health problems.

The following guidelines will help you to plan your exercise program. Remember—these are general guidelines. For more detailed information about exercise, obtain a book or consult your physician.

EXERCISE INTENSITY

Whether your goal is to burn fat or strengthen your cardiovascular system, the key to achieving the desired results is to exercise with the proper intensity. The proper intensity level can be found by using your heart rate as a guide. For effective exercise, your heart rate should be maintained at a level between 70% and 85% of your maximum heart rate as you exercise. This is known as your training zone.

You can find your training zone in the table below. Training zones are listed according to age and physical condition.

Age	Training Zone (Beats/Min.)	
	Unconditioned	Conditioned
20	138-167	133-162
25	136-166	132-160
30	135-164	130-158
35	134-162	129-156
40	132-161	127-155
45	131-159	125-153
50	129-156	124-150
55	127-155	122-149
60	126-153	121-147
65	125-151	119-145
70	123-150	118-144
75	122-147	117-142
80	120-146	115-140
85	118-144	114-139

Burning Fat

To burn fat, you must exercise at a low intensity level for a sustained period of time. During the first few minutes of exercise, your body uses easily accessible *carbohydrate* calories for energy. Only after the first few minutes of exercise does your body begin to use stored *fat* calories for energy. If your goal is to burn fat, adjust the intensity of your exercise until your heart rate is near the low end of your training zone as you exercise.

⚠ WARNING: The heart rate monitor is not a medical device. Various factors, including your movement, may affect the accuracy of heart rate readings. The heart rate monitor is intended only as an exercise aid in determining heart rate trends in general.

Aerobic Exercise

If your goal is to strengthen your cardiovascular system, your exercise must be "aerobic." Aerobic exercise is activity that requires large amounts of oxygen for prolonged periods of time. This increases the demand on the heart to pump blood to the muscles, and on the lungs to oxygenate the blood. For aerobic exercise, adjust the intensity of your exercise until your heart rate is near the middle of your training zone.

WORKOUT GUIDELINES

Each workout should include the following three important parts: (1) a warm-up, (2) training zone exercise, and (3) a cool-down.

Warm-up

Warming up prepares the body for exercise by increasing circulation, delivering more oxygen to the muscles, and raising the body temperature. Begin each workout with 5 to 10 minutes of stretching and light exercise to warm up (see SUGGESTED STRETCHES on page 21).

Training Zone Exercise

After warming up, increase the intensity of your exercise until your heart rate is in your training zone for 20 to 60 minutes. (During the first few weeks of your exercise program, do not keep your heart rate in your training zone for longer than 20 minutes.) Breathe regularly and deeply as you exercise—never hold your breath.

Cool-down

Finish each workout with 5 to 10 minutes of stretching to cool down. This will increase the flexibility of your muscles and will help to prevent post-exercise problems.

Exercise Frequency

To maintain or improve your condition, complete three workouts each week, with at least one day of rest be-

tween workouts. After a few months, you may complete up to five workouts each week if desired.

The key to success is to make exercise a regular and enjoyable part of your everyday life.

SUGGESTED STRETCHES

The correct form for several basic stretches is shown at the right. Move slowly as you stretch—never bounce.

1. Toe Touch Stretch

Stand with your knees bent slightly and slowly bend forward from your hips. Allow your back and shoulders to relax as you reach down toward your toes as far as possible. Hold for 15 counts, then relax. Repeat 3 times. Stretches: Hamstrings, back of knees and back.

2. Hamstring Stretch

Sit with one leg extended. Bring the sole of the opposite foot toward you and rest it against the inner thigh of your extended leg. Reach toward your toes as far as possible. Hold for 15 counts, then relax. Repeat 3 times for each leg. Stretches: Hamstrings, lower back and groin.

3. Calf/Achilles Stretch

With one leg in front of the other, reach forward and place your hands against a wall. Keep your back leg straight and your back foot flat on the floor. Bend your front leg, lean forward and move your hips toward the wall. Hold for 15 counts, then relax. Repeat 3 times for each leg. To cause further stretching of the achilles tendons, bend your back leg as well. Stretches: Calves, achilles tendons and ankles.

4. Quadriceps Stretch

With one hand against a wall for balance, reach back and grasp one foot with your other hand. Bring your heel as close to your buttocks as possible. Hold for 15 counts, then relax. Repeat 3 times for each leg. Stretches: Quadriceps and hip muscles.

5. Inner Thigh Stretch

Sit with the soles of your feet together and your knees outward. Pull your feet toward your groin area as far as possible. Hold for 15 counts, then relax. Repeat 3 times. Stretches: Quadriceps and hip muscles.

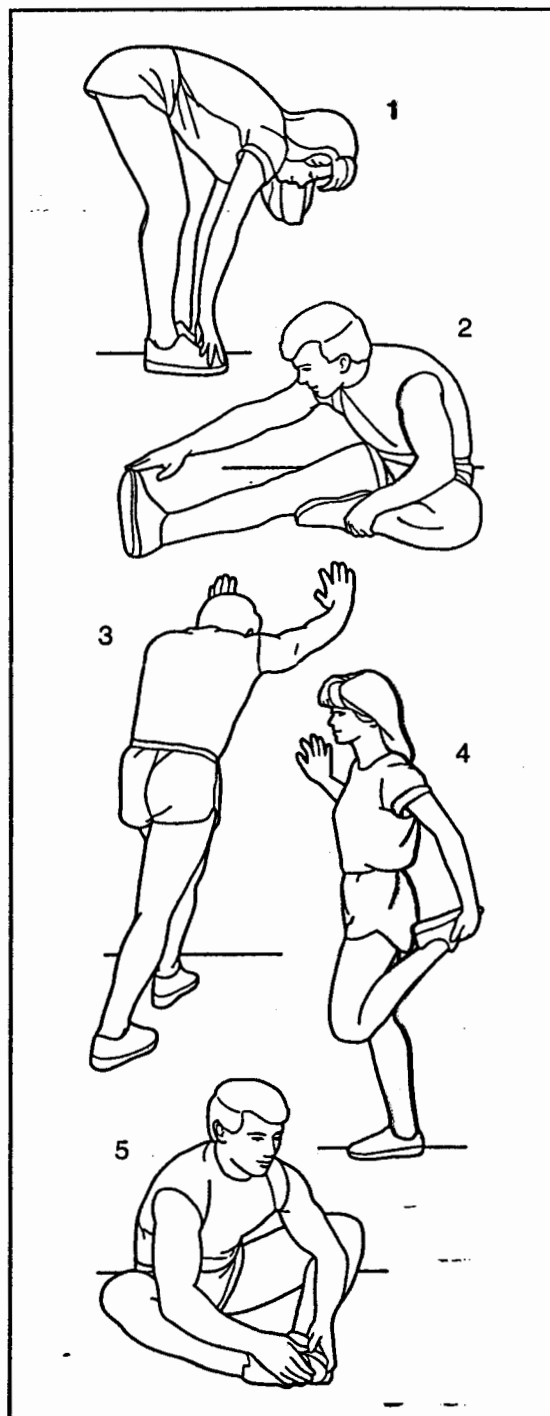

PART LIST—Model No. IMTL12071

R0598A

Note: To identify the parts listed below, refer to the EXPLODED DRAWING attached in the center of this manual.

Key No.	Qty.	Description	Key No.	Qty.	Description
1	1	Frame	54	2	Shock
2	52	Screw	55	1	Walking Belt
3	6	Spring Nut	56	8	Belly Pan Spacer
4	4	Spring Bolt	57	1	Motor Lock Washer
5	2	Cushion Spring	58	1	Cushion Shaft
6	2	Isolator	59	1	Belly Pan
7	2	Cushion Adj. Rack	60	1	Right Foot Rail
8	8	Rack Screw	61	6	8" Cable Tie
9	2	Cushion Adj. Gear	62	1	Motor Belt
10*	1	Motor/Pulley/Flywheel/Fan	63	5	Tie Holder
11	1	Latch Housing	64	1	Releasable Tie
12	1	Left Foot Rail	65	1	Short Rear Roller Adj. Bolt
13	2	Rear Platform Screw	66	1	Rear Roller Endcap
14	2	Roller Guard	67	5	Endcap Pad
15	1	Walking Platform	68	1	Pulse Monitor
16	1	Rear Roller	69	1	Monitor Strap
17	2	Incline Pivot Bolt	70	1	Console
18	1	Front Roller/Pulley	71	2	Incline Leg Washer
19	4	Console Plate Screw	72	1	Motor
20	1	Console Base	73	4	Upright Cap
21	1	8" Ground Wire	74	5	Console Screw
22	2	Hood Anchor	75	1	Console Plate
23	2	Hood Anchor Bracket	76	1	Electronic Guard
24	4	Motor Bracket Bolt	77	1	Hood
25	2	Incline Warning Decal	78	19	Small Screw
26	3	Long Hood Bracket	79	1	Cushion Knob
27	2	Belt Guide	80	1	Power Board
28	6	Wheel Washer	81	4	Plastic Stand-Off
29	1	Outlet Bracket	82	22	Electronics Screw
30	1	Circuit Breaker	83	1	Controller
31	1	Power Cord	84	1	Upright Wire Harness
32	1	Power Cord Grommet	85	2	Isolator Bolt
33	1	On/Off Switch	86	1	Electronics Plate
34	1	Incline Leg	87	1	Upright Cover (right inside)
35	1	Front Roller Adj. Bolt	88	2	Upright Cover
36	8	Roller Adj. Washer	89	2	Platform Screw (front)
37	2	Incline Leg Spacer	90	2	Wheel Bolt
38	1	Sensor Bracket Nut	91	4	Front Wheel
39	1	Motor Nut	92	4	Wire Tie
40	1	Motor Pivot Bolt	93	4	Wheel Nut
41	1	Set Screw	94	1	Adhesive Clip
42	1	Key/Clip	95	1	Allen Wrench
43	2	Cushion Spring Spacer	96	2	Upright Foot
44	1	Motor Tension Nut	97	2	Handrail Foam
45	2	Small Nut	98	2	Handrail Endcap
46	1	Speed Bracket Screw	99	1	Lock Knob
47	2	Small Bolt	100	1	Lock Knob Sleeve
48	2	Sensor	101	1	Lock Knob Spring
49	1	Speed Sensor Bracket	102	1	Lock Pin Collar
50	1	Speed Disk	103	1	Lock Pin
51	2	Hood Anchor Screw	104	1	Pin Clip
52	1	Long Rear Roller Adj. Bolt	105	2	Platform Washer
53	2	Sensor Wire	106	1	Stop Bracket

LIMITED WARRANTY

WHAT IS COVERED—The entire IMAGE 10.4Q ("Product") is warranted to be free of all defects in material and workmanship.

WHO IS COVERED—The original purchaser or any person receiving the Product as a gift from the original purchaser.

HOW LONG IS IT COVERED—ICON Health & Fitness, Inc. ("ICON"), warrants the hood, covers, belly pan, and decals for six months after the date of purchase. The belt and deck are covered for one year after the date of purchase. All mechanical components are covered for one year after the date of purchase. All electrical components are covered for one year after the date of purchase. Labor is covered for one year within the contiguous United States.

WHO PAYS TRANSPORTATION AND INSURANCE FOR SERVICE—If the Product or any covered part must be returned to a service facility for repairs, we will pay all transportation and insurance charges for the first year for electrical and mechanical components.

WHAT WE DO TO CORRECT COVERED DEFECTS—We will ship to you, without charge, any replacement part or component, providing the repairs are authorized by ICON first and are performed by an ICON trained and authorized service provider, or, at our option, we will replace the Product.

WHAT IS NOT COVERED—Any failures or damage caused by unauthorized service, misuse, accident, negligence, improper assembly or installation, alterations, modifications without our written authorization or by failure on your part to use, operate, and maintain as set out in your User's Manual ("Manual").

WHAT YOU MUST DO—Always retain proof of purchase, such as your bill of sale; store, operate, and maintain the Product as specified in the Manual; notify our Customer Service Department of any defect within 10 days after discovery of the defect; as instructed, return any defected part for replacement or, if necessary, the entire product, for repair.

USER'S MANUAL—It is VERY IMPORTANT THAT YOU READ THE MANUAL before operating the Product. Remember to do the periodic maintenance requirements specified in the Manual to assure proper operation and your continued satisfaction.

HOW TO GET PARTS AND SERVICE—Simply call our Customer Service Department at 1-800-999-3756 and tell them your name and address and the serial number of your Product. They will tell you how to get a part replaced, or if necessary, arrange for service where your Product is located or advise you how to ship the Product for service. Before shipping, always obtain a Return Authorization Number (RA No.) from our Customer Service Department; securely pack your Product (save the original shipping carton if possible); put the RA No. on the outside of the carton and insure the product. Include a letter explaining the product or problem and a copy of your proof of purchase if you believe the service is covered by warranty.

ICON is not responsible or liable for indirect, special or consequential damages arising out of or in connection with the use or performance of the product or damages with respect to any economic loss, loss of property, loss of revenues or profits, loss of enjoyment or use, costs of removal, installation or other consequential damages of whatsoever nature. Some states do not allow the exclusion or limitation of incidental or consequential damages. Accordingly, the above limitation may not apply to you.

The warranty extended hereunder is in lieu of any and all other warranties and any implied warranties of merchantability or fitness for a particular purpose is limited in its scope and duration to the terms set forth herein. Some states do not allow limitations on how long an implied warranty lasts. Accordingly, the above limitation may not apply to you.

No one is authorized to change, modify or extend the terms of this limited warranty.

This warranty gives you specific legal rights and you may have other rights which vary from state to state.

ICON HEALTH & FITNESS, INC., 1500 S. 1000 W., LOGAN, UT 84321-9813

