

IMAGE[®] 10.6Qi

Patent Pending

Model No. IMTL15990

Serial No. _____

Write the serial number in the space above for future reference.

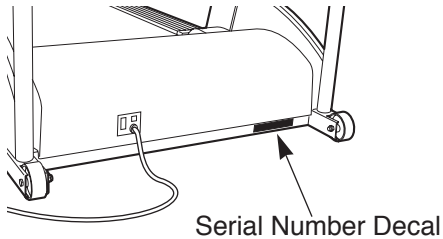

USER'S MANUAL

Questions?

As a manufacturer, we are committed to providing complete customer satisfaction. If you have questions, or if there are missing parts, we will guarantee complete satisfaction through direct assistance from our factory.

TO AVOID UNNECESSARY DELAYS, PLEASE CALL DIRECT TO OUR TOLL-FREE CUSTOMER HOT LINE. The trained technicians on our Customer Hot Line will provide immediate assistance, free of charge to you.

CUSTOMER HOT LINE:
1-800-999-3756
Mon.-Fri., 6 a.m.-6 p.m. MST

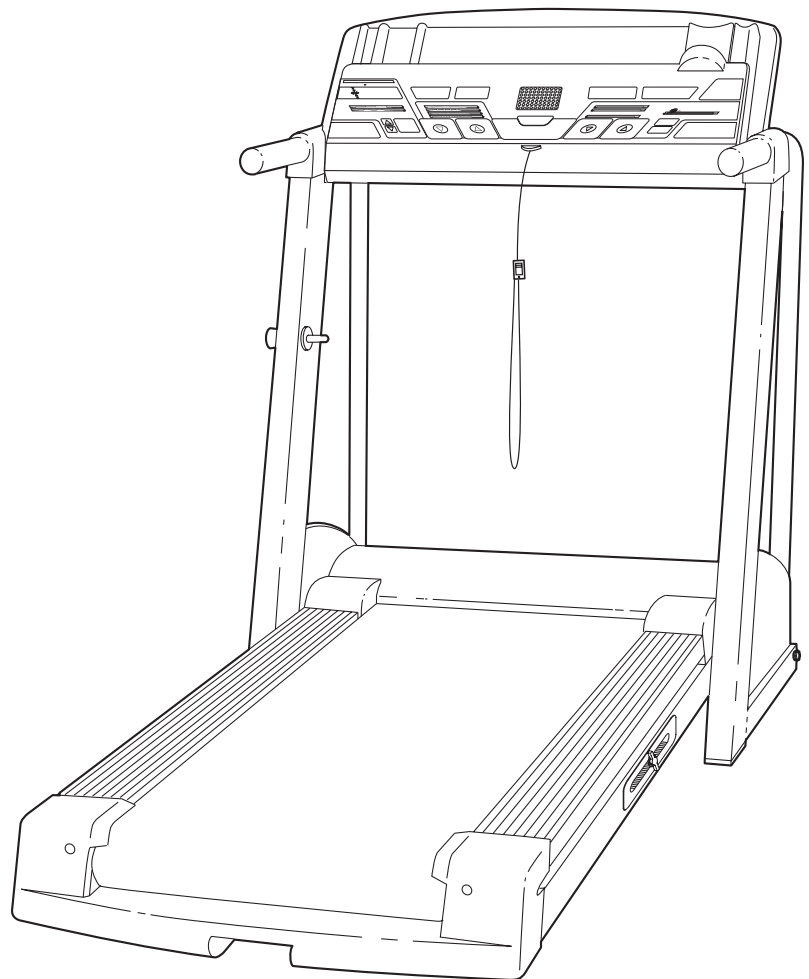

CAUTION

Read all precautions and instructions in this manual before using this equipment. Save this manual for future reference.



Visit our website at

www.imagefitness.com

new products, prizes,
fitness tips, and much more!

TABLE OF CONTENTS

IMPORTANT PRECAUTIONS	2
BEFORE YOU BEGIN	4
ASSEMBLY	5
HOW TO USE THE HEART RATE MONITOR	6
OPERATION AND ADJUSTMENT	7
HOW TO FOLD AND MOVE THE TREADMILL	24
TROUBLE-SHOOTING	25
CONDITIONING GUIDELINES	28
PART LIST	30
ORDERING REPLACEMENT PARTS	31
FULL ONE YEAR WARRANTY	Back Cover

Note: An EXPLODED DRAWING is attached in the center of this manual.

IMPORTANT PRECAUTIONS

⚠ WARNING: To reduce the risk of burns, fire, electric shock, or injury to persons, read the following important precautions and information before operating the treadmill.

1. It is the responsibility of the owner to ensure that all users of this treadmill are adequately informed of all warnings and precautions.
2. Use the treadmill only as described in this manual.
3. Place the treadmill on a level surface, with eight feet of clearance behind it. Do not place the treadmill on any surface that blocks air openings. To protect the floor or carpet from damage, place a mat under the treadmill.
4. Keep the treadmill indoors, away from moisture and dust. Do not put the treadmill in a garage or covered patio, or near water.
5. Do not operate the treadmill where aerosol products are used or where oxygen is being administered.
6. Keep children under the age of 12 and pets away from the treadmill at all times.
7. The treadmill should not be used by persons weighing more than 300 pounds.
8. Never allow more than one person on the treadmill at a time.
9. Wear appropriate exercise clothing when using the treadmill. Do not wear loose clothing that could become caught in the treadmill. Athletic support clothes are recommended for both men and women. Always wear athletic shoes. Never use the treadmill with bare feet, wearing only stockings, or in sandals.
10. When connecting the power cord (see page 7), plug the power cord into a surge protector (not included) and plug the surge protector into a grounded circuit capable of carrying 15 or more amps. No other appliance should be on the same circuit.
11. Use only a UL-listed surge protector, rated at 15 amps, with a 14-gauge cord of five feet or less in length. Do not use an extension cord.
12. Keep the power cord and the surge suppressor away from heated surfaces.
13. Never move the walking belt while the power is turned off. Do not operate the treadmill if the power cord or plug is damaged, or if the treadmill is not working properly. (See BEFORE YOU BEGIN on page 4 if the treadmill is not working properly.)

14. Never start the treadmill while you are standing on the walking belt. Always hold the handrails while using the treadmill.
15. The treadmill is capable of high speeds. Adjust the speed in small increments to avoid sudden jumps in speed.
16. The heart rate monitor is not a medical device. Various factors, including the user's movement, may affect the accuracy of heart rate readings. The heart rate monitor is intended only as an exercise aid in determining heart rate trends in general.
17. Using the included hand weights and not holding the handrails may compromise your ability to maintain your balance. Exercises using hand weights should be attempted only by experienced users.
18. Never leave the treadmill unattended while it is running. Always remove the key, unplug the power cord and move the on/off switch to the off position when the treadmill is not in use. (See the drawing on page 4 for the location of the on/off switch.)
19. Do not attempt to raise, lower, or move the treadmill until it is properly assembled. (See ASSEMBLY on page 5, and HOW TO MOVE

THE TREADMILL on page 24.) You must be able to safely lift 45 pounds (20 kg) in order to raise, lower, or move the treadmill.

20. When folding or moving the treadmill, make sure that the pin on the lock knob is inside of the catch (see page 24).
21. Inspect and tighten all parts of the treadmill every three months.
22. Never drop or insert any object into any opening.
23. **DANGER:** Always unplug the power cord immediately after use, before cleaning the treadmill, and before performing the maintenance and adjustment procedures described in this manual. Never remove the motor hood unless instructed to do so by an authorized service representative. Servicing other than the procedures in this manual should be performed by an authorized service representative only.
24. This treadmill is intended for in-home use only. Do not use this treadmill in any commercial, rental, or institutional setting.

SAVE THESE INSTRUCTIONS

⚠ WARNING: Before beginning this or any exercise program, consult your physician. This is especially important for persons over the age of 35 or persons with pre-existing health problems. Read all instructions before using. ICON assumes no responsibility for personal injury or property damage sustained by or through the use of this product.

The decal shown below has been placed on the treadmill. If the decal is missing, or if it is not legible, please call our Customer Service Department, toll-free, to order a free replacement decal (see ORDERING REPLACEMENT PARTS on page 31 of this manual). Apply the decal in the location shown.

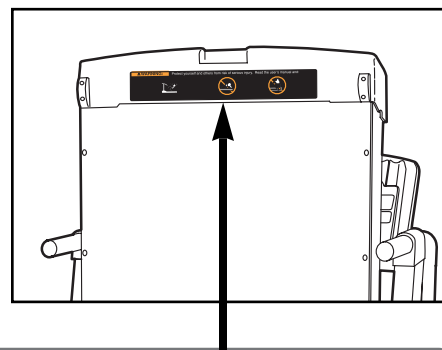

Note: The decal is shown at 38% of actual size.

⚠ WARNING:

Protect yourself and others from risk of serious injury. Read the user's manual and:

- Fully engage storage latch before treadmill is moved or stored.
- Reduce incline to lowest level before folding treadmill into storage position.



- Stand only on side rails when starting or stopping treadmill.
- Change speed in small increments.
- Hold handrails to prevent falling, and always wear the safety clip while operating treadmill.
- Stop if you feel faint, dizzy, or short of breath.



- Never allow children on or around treadmill.
- Remove key when not in use.



- Keep clothing, fingers, and hair away from moving belt.
- Never try to adjust or fix the belt while it is moving.
- Always wear athletic shoes while operating treadmill.

BEFORE YOU BEGIN

Thank you for selecting the IMAGE® 10.6Qi treadmill. The IMAGE 10.6Qi treadmill combines advanced technology with innovative design to let you enjoy an effective form of cardiovascular exercise in the convenience and privacy of your home. And when you're not exercising, the unique IMAGE 10.6Qi can be folded up, requiring less than half the floor space of other treadmills.

For your benefit, read this manual carefully before using the treadmill. If you have additional questions, please call our Customer Service Department toll-free

at 1-800-999-3756, Monday through Friday, 6 a.m. until 6 p.m. Mountain Time (excluding holidays). To help us assist you, please note the product model number and serial number before calling. The model number of the treadmill is IMTL15990. The serial number can be found on a decal attached to the treadmill (see the front cover of this manual for the location).

Before reading further, please familiarize yourself with the parts that are labeled in the drawing below.

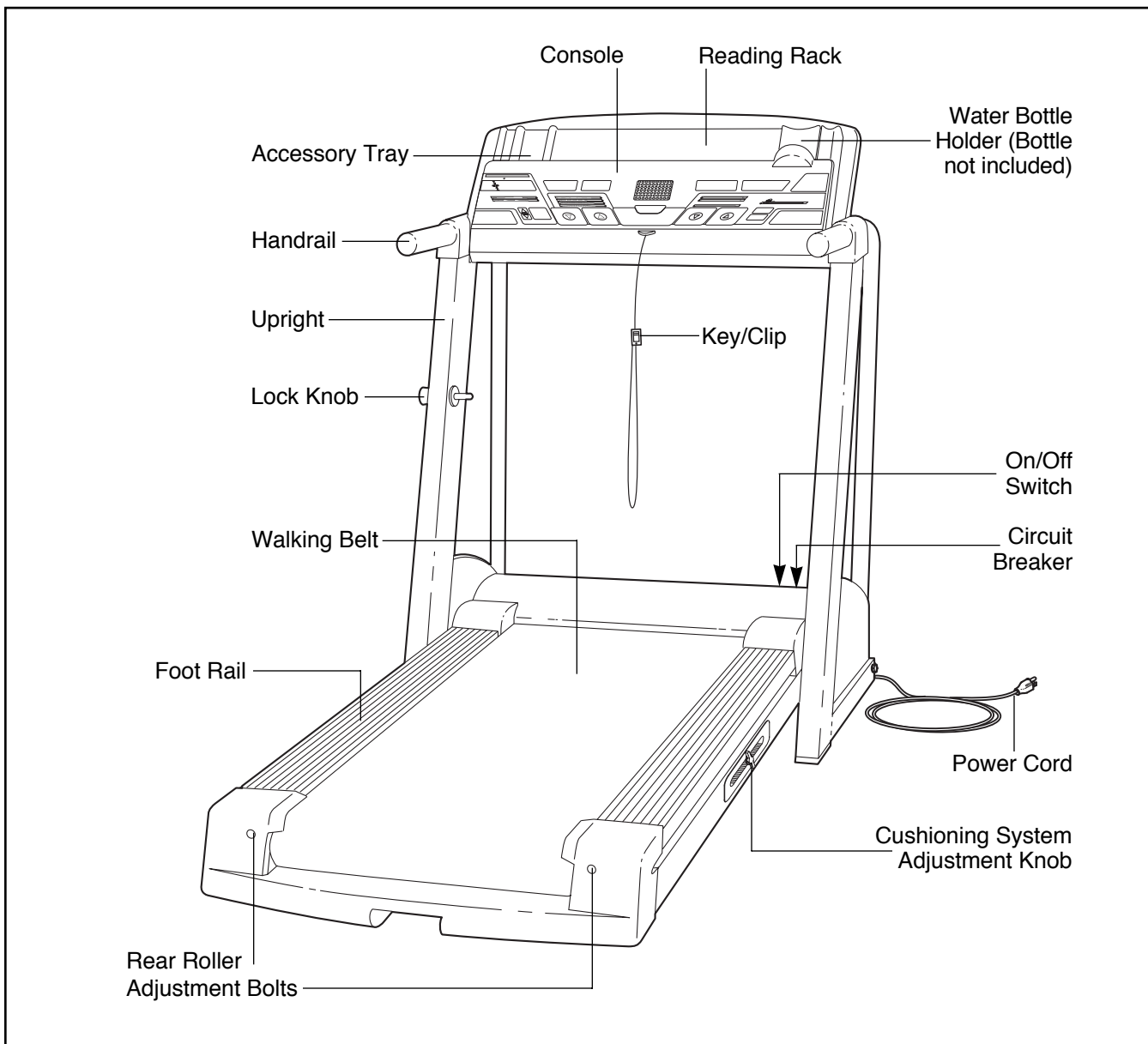

ASSEMBLY

Assembly requires two people. Set the treadmill in a cleared area and remove all packing materials. Do not dispose of the packing materials until assembly is completed. **No tools are required for assembly.**

Note: The underside of the treadmill walking belt is coated with high-performance lubricant. During shipping, a small amount of lubricant may be transferred to the top of the walking belt or the shipping carton. This is a normal condition and does not affect treadmill performance. If there is lubricant on top of the walking belt, simply wipe off the lubricant with a soft cloth and a mild, non-abrasive cleaner.

1. With the help of a second person, carefully raise the Uprights (65) until the treadmill is in the position shown.

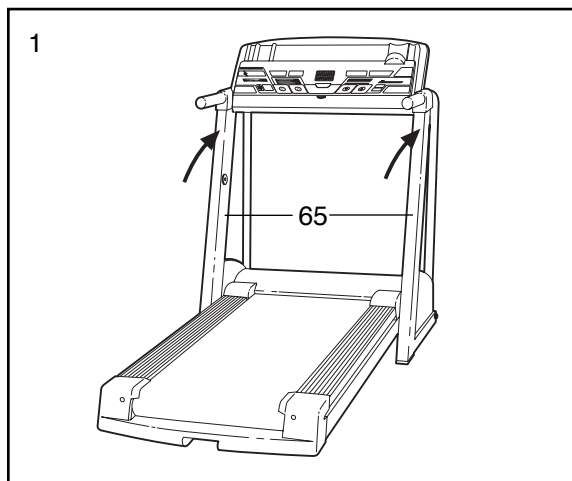

2. Press the Lock Knob Sleeve (68) into the left Upright (65).

Remove the Lock Knob (67) from the Lock Pin (72). Make sure that the Lock Pin Collar (70) and the Spring (69) are on the Lock Pin and insert the Lock Pin into the left Upright (65). Tighten the Lock Knob onto the Lock Pin.

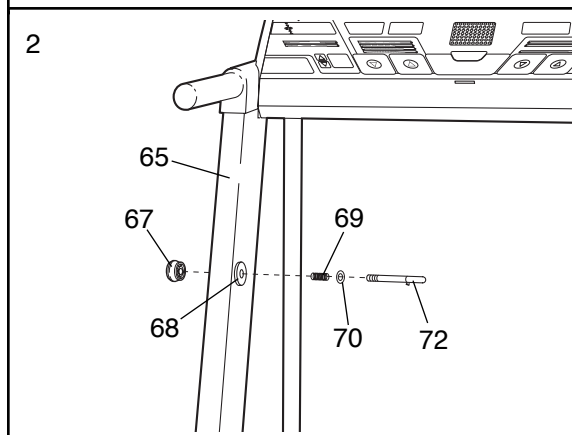

3. **Make sure that all parts are tightened before you use the treadmill.** Keep the included allen wrench in a secure place. The allen wrench is used to adjust the walking belt (see pages 25 and 26). To protect the floor or carpet from damage, place a mat under the treadmill.

HOW TO USE THE HEART RATE MONITOR

HOW TO PUT ON THE HEART RATE MONITOR

The heart rate monitor consists of two components: the chest strap and the sensor unit (see the drawing below). Insert the tab on one end of the chest strap through the hole in one end of the sensor unit. Press the end of the sensor unit under the buckle on the chest strap. The tab should be almost flush with the front of the sensor unit.

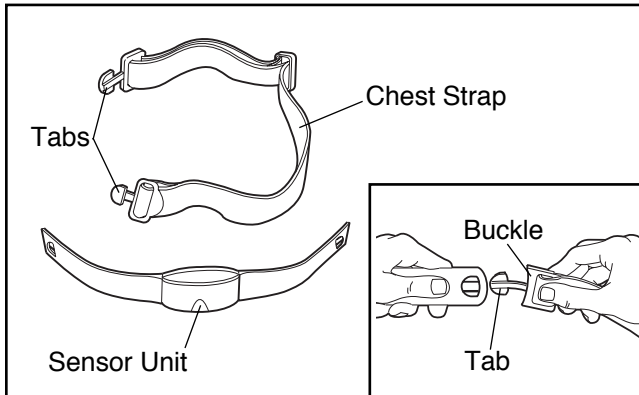

Next, wrap the heart rate monitor around your chest and attach the other end of the chest strap to the sensor unit. Adjust the length of the chest strap, if necessary. The heart rate monitor

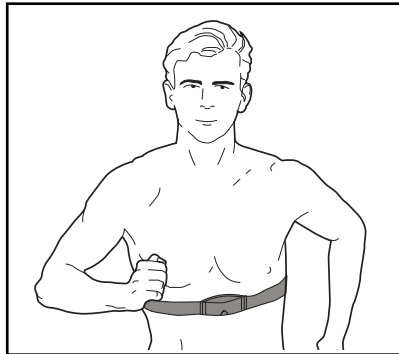

should be under your clothing, tight against your skin, and as high under the pectoral muscles or breasts as is comfortable. Make sure that the logo on the sensor unit is facing forward and is right-side-up.

Pull the sensor unit away from your body a few inches and locate the two electrode areas on the inner side. The electrode areas are the areas covered by shallow ridges. Using saline solution such as saliva or contact lens solution, wet both electrode areas. Return the sensor unit to a position against your chest.

HEART RATE MONITOR CARE AND MAINTENANCE

- Thoroughly dry the heart rate monitor after each use. The heart rate monitor is activated when the electrode areas are wetted and the heart rate monitor is put on; the heart rate monitor shuts off when it is removed and the electrode areas are dried. If the heart rate monitor is not dried after each

use, it may remain activated longer than necessary, draining the battery prematurely.

- Store the heart rate monitor in a warm, dry place. Do not store the heart rate monitor in a plastic bag or other container that may trap moisture.
- Do not expose the heart rate monitor to direct sunlight for extended periods of time; do not expose it to temperatures above 122° Fahrenheit (50° Celsius) or below 14° Fahrenheit (-10° Celsius).
- Do not excessively bend or stretch the sensor unit when using or storing the heart rate monitor.
- Clean the sensor unit using a damp cloth—never use alcohol, abrasives, or chemicals. The chest strap may be hand washed and air dried.

HEART RATE MONITOR TROUBLE-SHOOTING

The instructions on the following pages explain how the heart rate monitor is used with the console. If the heart rate monitor does not function properly, try the steps below.

- Make sure that the heart rate monitor is under your clothing, tight against your skin, and as high under the pectoral muscles or breasts as is comfortable. The logo on the sensor unit must be facing forward and be right-side-up. Note: If the heart rate monitor does not function when positioned as described, try moving it slightly lower or higher on your chest.
- Use saline solution such as saliva or contact lens solution to wet the two electrode areas on the sensor unit. If heart rate readings do not appear until you begin perspiring, re-wet the electrode areas.
- As you walk or run on the treadmill, position yourself near the center of the walking belt. **For the console to display heart rate readings, the user must be within arm's length of the console.**
- The heart rate monitor is designed to work with people who have normal heart rhythms. Heart rate reading problems may be caused by medical conditions such as premature ventricular contractions (pvc's), tachycardia bursts, and arrhythmia.
- The operation of the heart rate monitor can be affected by magnetic interference caused by high power lines or other sources. If it is suspected that this is a problem, try relocating the treadmill.
- The CR2032 battery may need to be replaced (see page 27).

OPERATION AND ADJUSTMENT

THE PERFORMANT LUBE™ WALKING BELT

Your treadmill features a walking belt coated with PERFORMANT LUBE™, a high-performance lubricant. **IMPORTANT: Never apply silicone spray or other substances to the walking belt or the walking platform. They will deteriorate the walking belt and cause excessive wear.**

HOW TO PLUG IN THE POWER CORD

⚠ DANGER: Improper connection of the equipment-grounding conductor can result in an increased risk of electric shock. Check with a qualified electrician or serviceman if you are in doubt as to whether the product is properly grounded. Do not modify the plug provided with the product—if it will not fit the outlet, have a proper outlet installed by a qualified electrician.

Your treadmill, like any other type of sophisticated electronic equipment, can be seriously damaged by sudden voltage changes in your home's power. Voltage surges, spikes, and noise interference can result from weather conditions or from other appliances being turned on or off.

To decrease the possibility of your treadmill being damaged, always use a surge protector (not included) with your treadmill.

Surge protectors are sold at most hardware stores and department stores. Use only a UL-listed surge protector, rated at 15 amps, with a 14-gauge cord of five feet or less in length.

This product must be grounded. If it should malfunction or break down, grounding provides a path of least resistance for electric current to reduce the risk of

electric shock. This product is equipped with a cord having an equipment-grounding conductor and a grounding plug. **Plug the power cord into a surge protector, and plug the surge protector into an appropriate outlet that is properly installed and grounded in accordance with all local codes and ordinances.**

This product is for use on a nominal 120-volt circuit, and has a grounding plug that looks like the plug illustrated in drawing 1 below. A temporary adapter that looks like the adapter illustrated in drawing 2 may be used to connect the surge protector to a 2-pole receptacle as shown in drawing 2 if a properly grounded outlet is not available.

The temporary adapter should be used only until a properly grounded outlet (drawing 1) can be installed by a qualified electrician.

The green-colored rigid ear, lug, or the like extending from the adapter must be connected to a permanent ground such as a properly grounded outlet box cover. Whenever the adapter is used it must be held in place by a metal screw. **Some 2-pole receptacle outlet box covers are not grounded. Contact a qualified electrician to determine if the outlet box cover is grounded before using an adapter.**

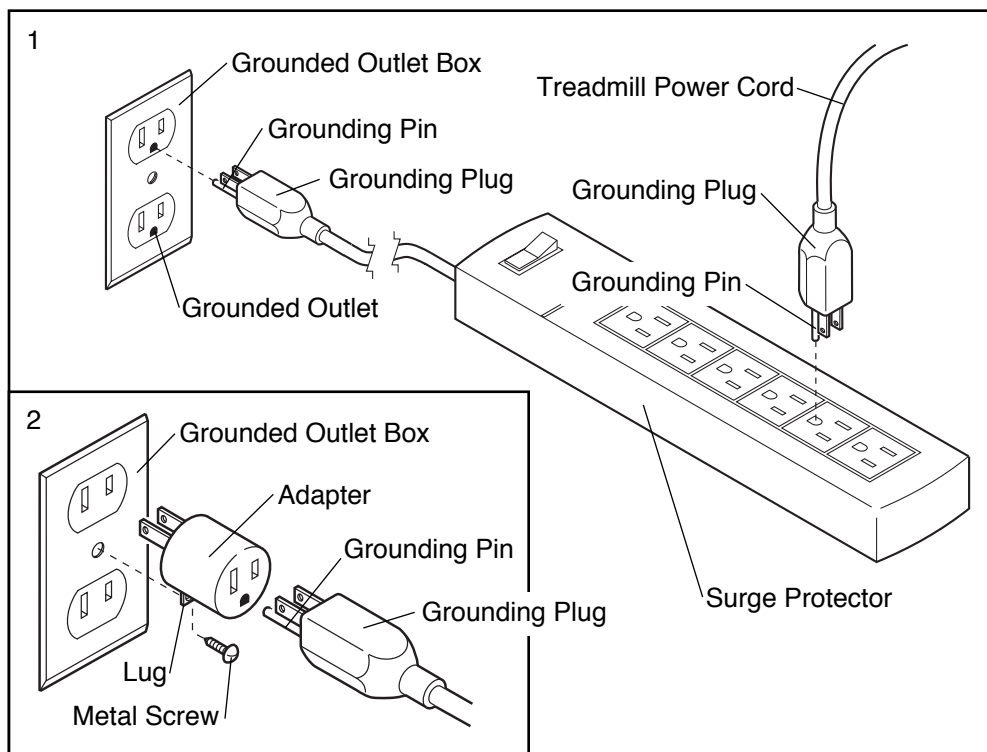
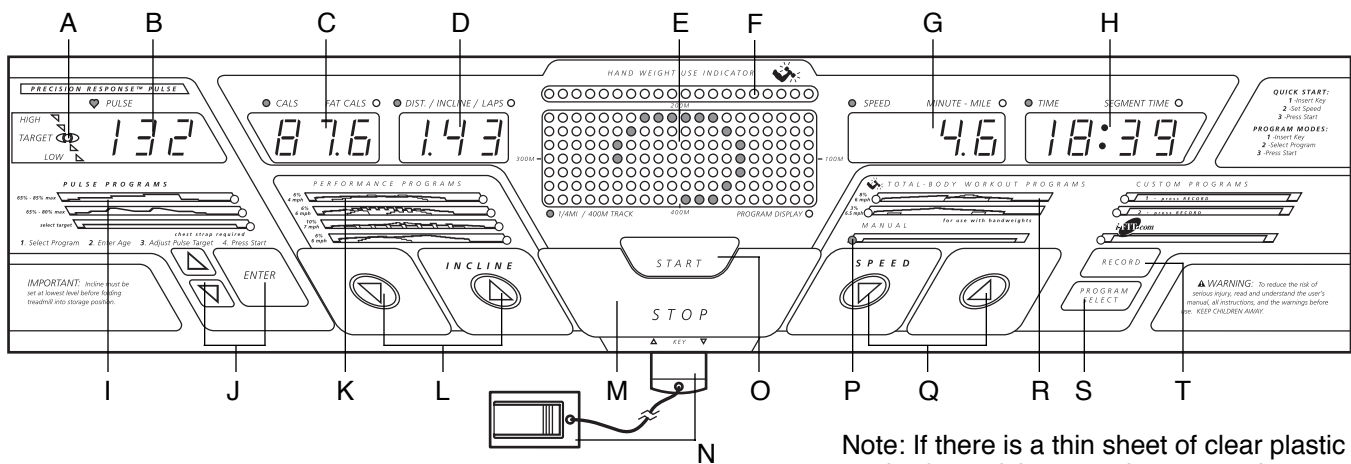

DIAGRAM OF THE CONSOLE



FEATURES OF THE CONSOLE

The treadmill console offers an impressive array of features to help you get the most from your exercise.

When the console is in the manual mode, the speed and incline of the treadmill can be changed with a touch of a button. As you exercise, the console will display instant exercise feedback—you can watch your progress on the LED track while the five displays show your heart rate, the number of calories and fat calories you have burned, the distance you have walked, the incline level of the treadmill, the number of laps completed, your speed, your pace, and workout time.

The console also offers four performance programs and two total-body workout programs. Each program automatically controls the speed and incline of the treadmill as it guides you through an effective workout. The total-body workout programs also prompt you to use the included hand weights for upper-body exercise. Three pulse programs are also featured. Each program controls the speed and incline of the treadmill to keep your heart rate near a target level during your workout.

The console even allows you to create custom workout programs and store them in memory for future use.

The console also includes built-in iFit.com technology. iFit.com technology is like having a personal trainer right in your home. Using the included audio cable, you can connect the treadmill to your home stereo, portable stereo, or computer and play special iFit.com CD programs (CD's are available separately). iFit.com

CD programs automatically control the speed and incline of the treadmill as a personal trainer guides you through every step of your workout. High-energy music provides added motivation. Each CD features two different programs designed by certified personal trainers.

In addition, you can connect the treadmill to your VCR and TV and play iFit.com video programs (videocassettes are available separately). Video programs offer the same benefits as iFit.com CD programs, but add the excitement of working out with a class and an instructor—the hottest new trend at health clubs.

With the treadmill connected to your computer, you can also go to our new internet site at www.iFit.com and access basic programs, audio programs, and video programs directly from the internet. And by adding an optional upgrade module to the console, you can use virtually endless features from our internet site. See www.iFit.com for complete details.

To purchase iFit.com CD's, iFit.com videocassettes, or an optional upgrade module, call toll-free 1-800-735-0768.

To use the manual mode of the console, follow the steps beginning on page 10. **To use a performance program or a total-body workout program**, see page 12. **To use a pulse program**, see page 13 or page 15. **To create a custom program**, see page 16. **To use a custom program**, see page 17.

To use iFit.com CD or video programs, refer to page 21. **To use iFit.com programs directly from our internet site**, see page 22.

DIAGRAM OF THE CONSOLE

Refer to the drawing on the opposite page. **Note: The console can display exercise feedback in either miles or kilometers. For simplicity, all instructions in this section refer to miles.**

- A. Target Heart Rate display—When you are using a pulse program, this display will show whether your heart rate is near the target heart rate.
- B. Pulse display—This display shows your heart rate when the heart rate monitor is worn. The heart-shaped indicator will flash each time your heart beats.
- C. Calories/Fat Calories display—This display shows the numbers of calories and fat calories you have burned (see BURNING FAT on page 28). The display will alternate between one number and the other every seven seconds.
- D. Distance/Incline/Laps display—This display shows the distance you have walked, the number of 1/4-mile laps you have completed, and the incline level of the treadmill. The display will change from one number to the next every seven seconds. Note: Each time the Incline buttons are pressed, the display will show the incline setting.
- E. Program display—When the manual mode or an iFit.com program is selected, this display will show your progress on an LED track. When a performance program, a total-body workout program, a pulse program, or a custom program is selected, the display will show the program's speed or heart rate settings.
- F. Hand Weight display—During the two total-body workout programs, this display will prompt you to use the included hand weights for upper-body exercise as you walk on the treadmill.
- G. Speed/Minutes-Mile display—This display shows the speed of the walking belt and your current pace (pace is measured in minutes per mile). The display will alternate between one number and the other every seven seconds. Note: Each time the Speed buttons are pressed, the display will show the speed setting.
- H. Time/Segment Time display—When the manual mode or an iFit.com program is selected, this display will show the elapsed time. When a performance program, a total-body workout program, a pulse program, or a custom program is selected, the display will show both the time remaining in the program and the time remaining in the current period of the program. The display will alternate between one number and the other every seven seconds. Note: When the Select Target program is selected, the display will show the elapsed time and the time remaining in the current period of the program.
- I. Pulse program profiles—These profiles show how the target heart rate will change during pulse programs.
- J. Age and Enter buttons—These buttons are used to enter your age for pulse programs.
- K. Performance program profiles—These profiles show how the speed and incline of the treadmill will change during performance programs.
- L. Incline buttons—These buttons control the incline of the treadmill. The incline range is 0% to 10%.
- M. Stop button—This button is used to stop the walking belt.
- N. Key with clip—The key turns the console on and off. The clip is worn on the waistband of your clothes.
- O. Start button—This button is used to start the walking belt.
- P. Mode indicators—These indicators show whether the manual mode, a performance program, a total-body workout program, a pulse program, a custom program, or an iFit.com program is selected.
- Q. Speed buttons—These buttons control the speed of the walking belt. The speed range is 0.5 mph to 12 mph. Note: When the Start button is pressed, the walking belt will begin to move at 1.0 mph.
- R. Total-body workout program profiles—These profiles show how the speed and incline of the treadmill will change during total-body workout programs.
- S. Program Select button—This button is used to select the manual mode, performance programs, total-body workout programs, pulse programs, custom programs, and iFit.com programs. Note: If the walking belt is moving when the Select Program button is pressed, the walking belt will slow to a stop and the displays will be reset.
- T. Record button—This button is used to program speed and incline settings for custom programs.

⚠ WARNING: To reduce the risk of serious injury, read the following precautions before operating the console.

- Do not stand on the walking belt when turning on the power or starting the walking belt.
- Always wear the clip (see part “N” on page 8) securely on the waistband of your clothing while using the treadmill. If the key is pulled from the console, the walking belt will stop.
- The treadmill is capable of high speeds. Adjust the speed in small increments.
- The heart rate monitor is not a medical device. Various factors may affect the accuracy of heart rate readings. The heart rate monitor is intended only as an exercise aid in determining heart rate trends in general.
- If you have heart problems, or if you are over 60 years of age and have been inactive, do not use the pulse programs. If you are taking medication regularly, consult your physician to find whether the medication will affect your exercise heart rate.
- To reduce the risk of electric shock, keep liquids away from the console and use only a sealed water bottle.

HOW TO TURN ON THE POWER

1 Plug in the power cord (see HOW TO PLUG IN THE POWER CORD on page 7).

2 Locate the on/off switch on the front of the treadmill. Make sure that the on/off switch is in the on position.

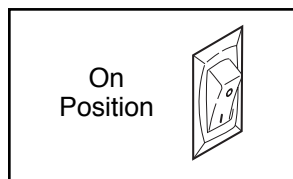

3 Stand on the foot rails of the treadmill. Find the clip attached to the key and **slide the clip securely onto the waistband of your clothing.** Next, insert the key into the console. After a moment, the displays, the LED track, and various indicators on the console will light.

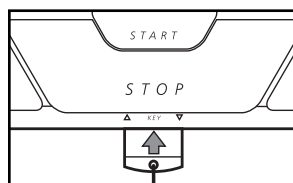

HOW TO USE THE MANUAL MODE

1 Insert the key into the console.

See HOW TO TURN ON THE POWER at the left.

2 Select the manual mode.

When the key is inserted, the manual mode will automatically be selected and the manual indicator will light. If a program has been selected, press the Program Select button repeatedly to select the manual mode again.

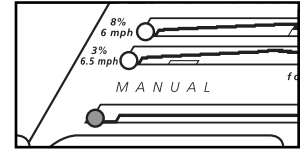

3 Put on the heart rate monitor if desired.

For the Pulse display to show your heart rate, the heart rate monitor must be worn. To put on the heart rate monitor, see HOW TO USE THE HEART RATE MONITOR on page 6.

4 Press the Start button to start the walking belt.

When the Start button is pressed, the LED track in the center of the console will disappear in a counterclockwise direction. One flashing indicator will then appear and the walking belt will begin to move at 1.0 mph. Hold the handrails and begin walking.

The LED track represents a distance of 1/4 mile. As you exercise, the indicators around the track will light one at a time until the entire track is lit. The track will then disappear in a counterclockwise direction and a new lap will begin.

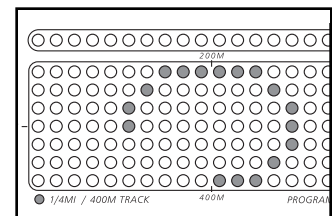

To stop the walking belt, press the Stop button. All displays will pause and the Time/Segment Time display will begin to flash. To restart the walking belt, press the Start button. To stop the walking belt and reset the displays, press the Stop button, remove the key, and then reinsert the key.

5 Adjust the speed and incline of the treadmill.

While the walking belt is moving, adjust the speed of the walking belt by pressing the Speed buttons. Each time one of the buttons is pressed, the speed will change by 0.1 mph. If the buttons are held down, the speed will change in increments of 0.5 mph. The speed range of the walking belt is 0.5 mph to 12 mph.

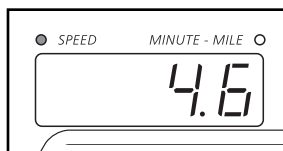

To vary your exercise, the incline of the treadmill can be adjusted with the Incline buttons. Each time one of the buttons is pressed, the incline will change by 0.5%. The incline range is 0% to 10%. Note: After the buttons are pressed, it may take a moment for the treadmill to reach the selected incline setting.

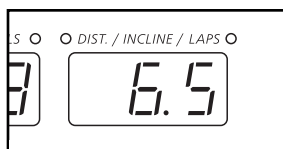

6 Follow your progress with the five displays.

Pulse display—This display shows your heart rate when the heart rate monitor is worn. Note: The heart rate monitor will sample your heart rate every few seconds; it may take several seconds before an accurate heart rate is shown. If your heart rate is not shown, see HEART RATE MONITOR TROUBLE-SHOOTING on page 6.

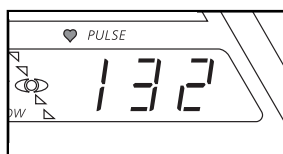

Calories/Fat Calories display—This display shows the numbers of calories and fat calories you have burned (see BURNING FAT on page 28). The display will alternate between one number and the other every seven seconds.

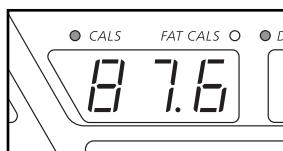

Distance/Incline/Laps display—This display shows the distance you have walked, the number of 1/4-mile laps you have completed, and the incline level of the treadmill. The display will change from one number to the next every seven seconds. Note: Each time the Incline buttons are pressed, the display will show the incline setting.



Note: If the speed is displayed in miles per hour, the distance will be displayed in miles; if the speed is displayed in kilometers per hour, the distance will be displayed in kilometers.

Speed/Minutes-Mile display—This display shows the speed of the walking belt and your current pace (pace is measured in minutes per mile). The display will alternate between one number and the other every seven seconds. Each time the Speed buttons are pressed, the display will show the speed setting.

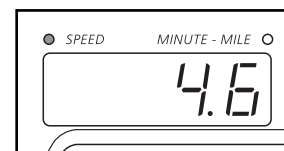

Note: The speed can be displayed in either miles per hour (mph) or kilometers per hour (kph). To see which unit of measurement is selected, first hold down the Stop button while inserting the key into the console. The Speed/Minutes-Mile display will show an “E” for English miles or an “M” for metric kilometers. Press the Speed Δ button to change the unit of measurement. Remove and then reinsert the key.

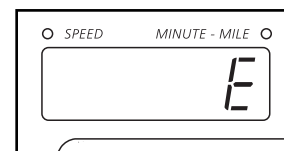

Time/Segment Time display—When the manual mode or an iFit.com program is selected, this display will show the elapsed time.

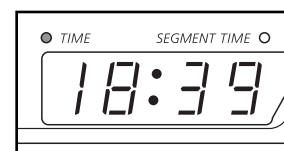

When a performance program, a total-body workout program, a pulse program, or a custom program is selected, this display will show both the time remaining in the program and the time remaining in the current period of the program. The display will alternate between one number and the other every seven seconds. Note: When the Select Target program is selected, the display will show the elapsed time and the time remaining in the current period of the program.

7 When you are finished exercising, stop the walking belt and remove the key.

Step onto the foot rails, press the Stop button, and **adjust the incline of the treadmill to 0%**. Next, remove the key from the console. Keep the key in a secure place. **Note: If the displays and indicators on the console remain lit after the key is removed, the console is in the “demo” mode. Refer to page 23 and turn off the demo mode.**

Next, move the on/off switch near the power cord to the off position.

HOW TO USE A PERFORMANCE PROGRAM OR A TOTAL-BODY WORKOUT PROGRAM

1 Insert the key into the console.

See HOW TO TURN ON THE POWER on page 10.

2 Select one of the performance programs or one of the total-body workout programs.

When the key is inserted, the manual mode will be selected and the manual indicator will light. Press the Program Select button repeatedly until one of the four performance program indicators or one of the two total-body workout program indicators lights.

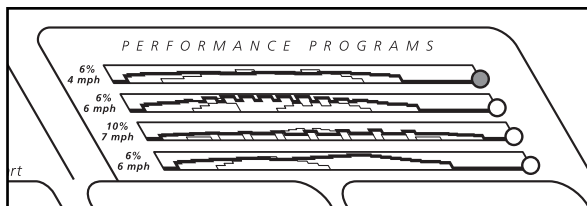

The profiles on the console show how the speed and incline of the treadmill will change during the programs. The numbers at the left ends of the profiles show the maximum speed and incline settings for the programs. For example, the first performance program profile shows that the treadmill will reach a maximum incline level of 6% and a maximum speed of 4 mph during the program.

When a program is selected, the program display will show a simplified profile of the program.

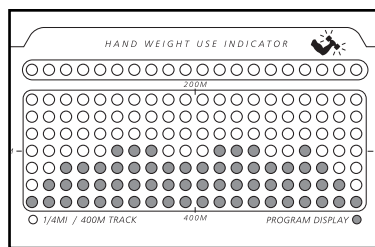

3 Put on the heart rate monitor if desired.

For the Pulse display to show your heart rate, the heart rate monitor must be worn. To put on the heart rate monitor, see HOW TO USE THE HEART RATE MONITOR on page 6.

4 Press the Start button to start the program.

A moment after the button is pressed, the treadmill will automatically adjust to the first speed and incline settings for the program. Hold the handrails and begin walking.

Each program is divided into several time periods of different lengths. (The Time/Segment Time display shows both the time remaining in the program and the time remaining in the current period.)

One speed setting and one incline setting are programmed for each period. The speed setting for the first period is shown in the flashing Current Period column of the program display. (The incline settings are not shown in the program display.) The speed settings for the next seventeen periods are shown in the seventeen columns to the right.

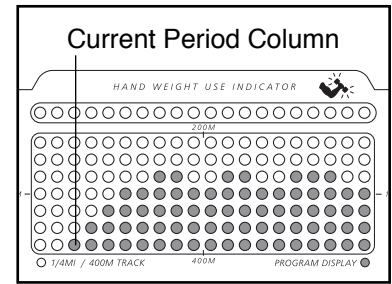

When only three seconds remain in the first period of the program, both the Current Period column and the column to the right will flash, the Time/Segment Time display will flash, a series of tones will sound, and all speed settings will move one column to the left. The speed setting for the second period will then be shown in the flashing Current Period column and the treadmill will automatically adjust to the speed and incline settings for the second period. Note: If a total-body workout program is selected, one or more indicators will be lit in the Hand Weight display. At the end of each period, the indicators in the Hand Weight display will also move one column to the left. When a lit indicator in the Hand Weight display is above the Current Segment column of the program display, the indicator will begin to flash. While the indicator is flashing, use the included hand weights for upper-body exercise, if desired.

WARNING: Using hand weights and not holding the handrails may compromise your ability to maintain your balance. Exercises using hand weights should be attempted only by experienced users.

The program will continue until the speed setting for the last period is shown in the Current Period column and the Time/Segment Time display counts down to zero. The walking belt will then slow to a stop.

Note: Each time a period ends and the speed settings move one column to the left, if all of the indicators in the Current Period column are lit, all speed settings will move downward so that only the highest indicators in the columns will appear in the program display. When the speed settings move to the left again and not all of the indicators in the Current Period column are lit, the speed settings will move back up.

If the speed or incline setting for the current period is too high or too low, you can manually override the setting by pressing the Speed or Incline buttons on the console. Every few times one of the Speed buttons is pressed, an additional indicator will light or darken in the Current Period column. If any of the columns to the right of the Current Period column have the same number of lit indicators as the Current Period column, an additional indicator will light or darken in those columns as well. Note: If you manually adjust the speed setting so that all of the indicators in the Current Period column are lit, the speed settings in the program display will not move downward as described above.

To stop the program temporarily, press the Stop button. All displays will pause and the Time/Segment Time display will begin to flash. To restart the program, press the Start button. To end the program, press the Stop button, remove the key, and then reinsert the key.

5 Follow your progress with the five displays.

Refer to step 6 on page 11.

6 Remove the key from the console.

When the program has ended, **make sure that the incline of the treadmill is at 0%**. Next, remove the key from the console. Keep the key in a secure place. **Note: If the displays and indicators on the console remain lit after the key is removed, the console is in the “demo” mode. Refer to page 23 and turn off the demo mode.**

Next, move the on/off switch near the power cord to the off position.

HOW TO USE THE 65%–85% PULSE PROGRAM AND THE 65%–80% PULSE PROGRAM

1 Insert the key into the console.

See HOW TO TURN ON THE POWER on page 10.

2 Select the 65%–85% program or the 65%–80% program.

When the key is inserted, the manual mode will be selected and the manual indicator will light. To select the 65%–85% program or the 65%–80% program, press the Program Select button repeatedly until the appropriate program indicator lights.

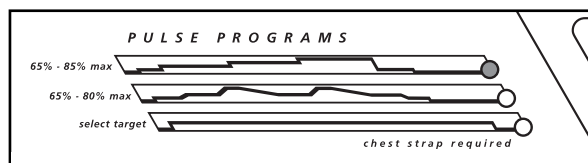

The profiles on the console show how the target heart rate will change during the pulse programs. Note that the program display shows a simplified profile of the program.

3 Enter your age.

When a pulse program is selected, the letters “AGE” will appear in the Pulse display. You must enter your age to use a pulse program. If you have already entered your age, press the Enter button and go to step 4. If you have not entered your age, press the Δ or ∇ button beside the Enter button to enter your age. When your age is shown, press the Enter button. **Once you have entered your age, your age will be saved in memory.**

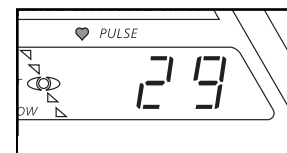

4 Enter a target heart rate.

After you have entered your age, the letters “PLS” will appear in the Pulse display. Press the Δ button beside the Enter button. The pulse display will then show the maximum target heart rate setting for the program, in beats per minute. If desired, press the Δ or ∇ button to adjust the setting.

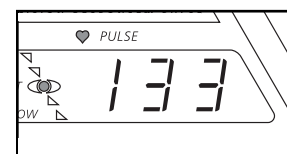

When the desired setting is shown, press the Enter button. Note: The maximum target heart rate setting can be between 65% and 85% (or 65% and 80%) of your estimated maximum heart rate (your estimated maximum heart rate is 220 minus your age). If the setting does not change when the Δ or ∇ button is pressed, the setting has reached its high or low limit.

5 Put on the heart rate monitor.

The heart rate monitor must be worn when a pulse program is used. See HOW TO USE THE HEART RATE MONITOR on page 6. Note: A pulse program can be started without a heart rate reading; however, the speed and/or incline of the treadmill may automatically decrease if your heart rate is not detected during the program.

6 Press the Start button.

A moment after the button is pressed, the walking belt will begin to move. Hold the handrails and begin walking.

Each pulse program is divided into twenty-three, one-minute periods. One heart rate setting is programmed for each period.

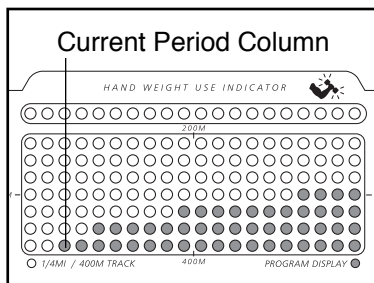

The heart rate setting for the first period will be shown in the flashing Current Period column of the program display. The heart rate settings for the next seventeen periods will be shown in the seventeen columns to the right.

When only three seconds remain in the first period of the program, both the Current Period column and the column to the right will flash, the Time/Segment Time display will flash, a series of tones will sound, and all heart rate settings will move one column to the left. The heart rate setting for the second period will then be shown in the flashing Current Period column and the speed and/or incline of the treadmill will automatically change, if necessary, to bring your heart rate closer to the heart rate setting for the second period.

As you exercise, the Target Heart Rate display will show whether your heart rate is near the target heart rate. If

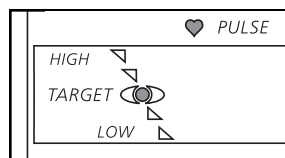

your heart rate is within 15 beats per minute of the target heart rate, the indicator in the center will light. If your heart rate is too low or too high, the low or high arrows will light.

If your heart rate is not detected during the program, the Pulse display will be blank. (See HEART RATE MONITOR TROUBLE-SHOOTING on page 6.) The speed and/or incline of the treadmill may also decrease until your heart rate is detected.

The program will continue until the heart rate setting for the last period is shown in the Current Period column and the Time/Segment Time display counts down to zero. The walking belt will then slow to a stop.

While the program is in progress, minor adjustments can be made to the speed or incline of the treadmill with the Speed or Incline buttons. However, if you increase the speed, the incline will automatically decrease; if you decrease the speed, the incline will increase. If you increase the incline, the speed will decrease; if you decrease the incline, the speed will increase. The console will always attempt to keep your heart rate near the target heart rate setting for the current period. Note: When the incline reaches the lowest setting, the speed cannot be increased any further. When the incline reaches the highest setting, the speed cannot be decreased any further.

To stop the program temporarily, press the Stop button. All displays will pause and the Time/Segment Time display will begin to flash. To restart the program, press the Start button. To end the program, press the Stop button, remove the key, and then reinsert the key.

7 Follow your progress with the five displays.

Refer to step 6 on page 11.

8 Remove the key from the console.

When the program has ended, **make sure that the incline of the treadmill is at 0%**. Next, remove the key from the console. Keep the key in a secure place. **Note: If the displays and indicators on the console remain lit after the key is removed, the console is in the “demo” mode. Refer to page 23 and turn off the demo mode.**

Next, move the on/off switch near the power cord to the off position.

HOW TO USE THE SELECT TARGET PULSE PROGRAM

1 Insert the key into the console.

See HOW TO TURN ON THE POWER on page 10.

2 Select the Select Target program.

When the key is inserted, the manual mode will be selected and the manual indicator will light. To select the Select Target program, press the Program Select button repeatedly until the appropriate program indicator lights.

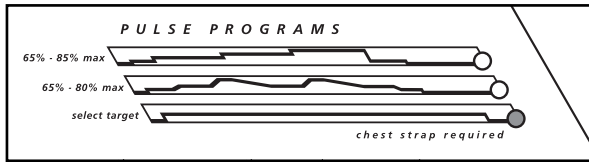

The profile on the console shows that the target heart rate will not change during the Select Target program. Note: The graphic in the program display will be explained in step 6.

3 Enter your age.

When the Select Target program is selected, the letters “AGE” will appear in the Pulse display. You must enter your age to use the Select Target program. If you have already entered your age, press the Enter button and go to step 4. If you have not entered your age, press the Δ or ∇ button beside the Enter button to enter your age. When your age is shown, press the Enter button. **Once you have entered your age, your age will be saved in memory.**

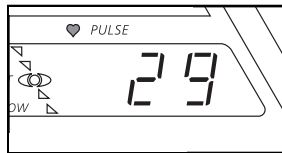

4 Enter a target heart rate.

After you have entered your age, the letters “PLS” will appear in the Pulse display. Press the Δ button beside the Enter button. The pulse display will then show the target heart rate setting for the program, in beats per minute. If desired, press the Δ or ∇ button to adjust the

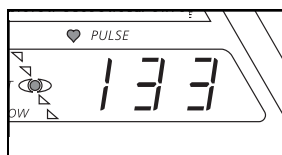

setting. When the desired setting is shown, press the Enter button. Note: The target heart rate setting can be between 50% and 85% of your estimated maximum heart rate (your estimated maximum heart rate is 220 minus your age). If the setting does not change when the Δ or ∇ button is pressed, the setting has reached its high or low limit.

5 Put on the heart rate monitor.

The heart rate monitor must be worn when the Select Target program is used. See HOW TO USE THE HEART RATE MONITOR on page 6. Note: The program can be started without a heart rate reading; however, the speed and/or incline of the treadmill may automatically decrease if your heart rate is not detected during the program.

6 Press the Start button.

A moment after the button is pressed, the walking belt will begin to move. Hold the handrails and begin walking.

The Select Target program is divided into twenty-three one-minute periods. When only three seconds remain in the first period of the program, the Time/Segment Time display will flash, a series of tones will sound, and the speed and/or incline of the treadmill will automatically change, if necessary, to bring your heart rate closer to the target heart rate setting.

The program display will show a moving graphic that represents your heart rate. The faster your heart beats, the closer together the points on the graphic will be.

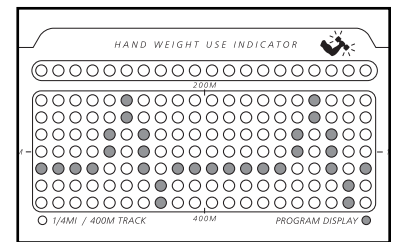

As you exercise, the Target Heart Rate display will show whether your heart rate is near the target heart rate. If your heart rate is within 15 beats per minute of the target heart rate, the indicator in the center will light. If your heart rate is too low or too high, the low or high arrows will light.

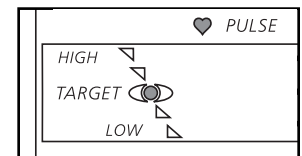

If your heart rate is not detected during the program, the Pulse display will be blank. (See HEART RATE MONITOR TROUBLE-SHOOTING on page 6.) The speed and/or incline of the treadmill may also decrease until your heart rate is detected.

The program will continue until the Time/Segment Time display counts up to twenty-three minutes. The walking belt will then slow to a stop.

While the program is in progress, minor adjustments can be made to the speed or incline of the treadmill with the Speed or Incline buttons. However, if you increase the speed, the incline will automatically decrease; if you decrease the speed, the incline will increase. If you increase the incline, the speed will decrease; if you decrease the incline, the speed will increase. The console will always attempt to keep your heart rate near the target heart rate setting. Note: When the incline reaches the lowest setting, the speed cannot be increased any further. When the incline reaches the highest setting, the speed cannot be decreased any further.

To stop the program temporarily, press the Stop button. All displays will pause and the Time/Segment Time display will begin to flash. To restart the program, press the Start button. To end the program, press the Stop button, remove the key, and then reinsert the key.

7 Follow your progress with the five displays.

Refer to step 6 on page 11.

8 Remove the key from the console.

When the program has ended, **make sure that the incline of the treadmill is at 0%**. Next, remove the key from the console. Keep the key in a secure place. **Note: If the displays and indicators on the console remain lit after the key is removed, the console is in the “demo” mode. Refer to page 23 and turn off the demo mode.**

Next, move the on/off switch near the power cord to the off position.

HOW TO CREATE A CUSTOM PROGRAM

1 Insert the key into the console.

See HOW TO TURN ON THE POWER on page 10.

2 Select one of the custom programs.

When the key is inserted, the manual mode will be selected and the manual indicator will light. To select one of the custom programs, press the Program Select button repeatedly until one of the two custom program indicators lights.

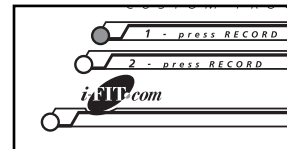

When a custom program is selected, a “C1” or “C2” will appear in the program display. Custom programs are workout programs that you create. The programs are stored in the console’s memory and can be changed as many times as desired. Custom programs control both the speed and the incline of the treadmill.

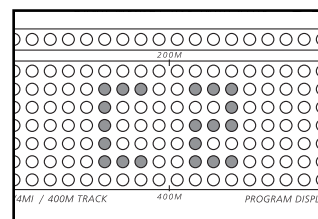

3 Put on the heart rate monitor if desired.

For the Pulse display to show your heart rate, the heart rate monitor must be worn. To put on the heart rate monitor, see HOW TO USE THE HEART RATE MONITOR on page 6.

4 Press the Start button.

A moment after the button is pressed, the walking belt will begin to move. Hold the handrails and begin walking.

5 Press the Record button and program the desired speed and incline settings.

When the Record button is pressed, the custom program indicator will begin to flash. **Speed and incline settings can be programmed only when the indicator is flashing.**

Refer to the program display. Each custom program is divided into one-minute periods. One speed setting and one incline setting can be programmed for each period. The speed setting for

the first period will be shown in the flashing Current Period column of the program display. (The incline settings are not shown in the program display.)

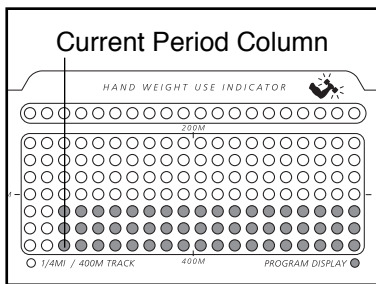

To program the desired speed and incline settings for the first period, simply adjust the speed and incline of the treadmill to the desired levels with the Speed and Incline buttons. Every few times one of the Speed buttons is pressed, an additional indicator will light or darken in the Current Segment column. Note: Indicators will light or darken in the columns to the right of the Current Segment column as well; disregard these columns.

When the first period of the program is completed, the current speed setting and the current incline setting will be stored in memory. All columns in the program display will then move one column to the left, and the speed setting for the second period will be shown in the flashing Current Period column. Program speed and incline settings for the second period as described above.

Repeat this procedure until you have programmed speed and incline settings for as many periods as desired—custom programs can have from one to forty periods. When you are finished, press the Stop button, remove the key from the console, and then reinsert the key. The speed and incline settings you programmed and the number of periods will be stored in memory.

To stop the program temporarily, press the Stop button. All displays will pause and the Time/Segment Time display will begin to flash. To restart the program, press the Start button.

6 Follow your progress with the five displays.

Refer to step 6 on page 11.

7 Remove the key from the console.

When the program has ended, **make sure that the incline of the treadmill is at 0%.** Next, remove the key from the console. Keep the key in a secure place. **Note: If the displays and indicators on the console remain lit after the key is removed, the console is in the “demo” mode. Refer to page 23 and turn off the demo mode.**

Next, move the on/off switch near the power cord to the off position.

HOW TO USE A CUSTOM PROGRAM

1 Insert the key into the console.

See HOW TO TURN ON THE POWER on page 10.

2 Select one of the custom programs.

When the key is inserted, the manual mode will be selected and the manual indicator will light.

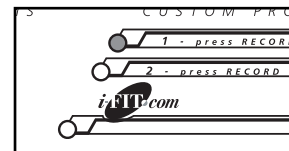

To select one of the custom programs, press the Program Select button repeatedly until one of the two custom program indicators lights.

When a custom program is selected, a “C1” or “C2” will appear in the program display.

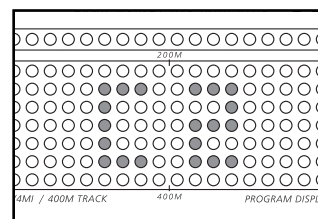

3 Put on the heart rate monitor if desired.

For the Pulse display to show your heart rate, the heart rate monitor must be worn. To put on the heart rate monitor, see HOW TO USE THE HEART RATE MONITOR on page 6.

4 Press the Start button.

A moment after the button is pressed, the walking belt will begin to move. Hold the handrails and begin walking.

Each custom program is divided into one-minute periods. One speed setting and one incline setting are programmed for each period.

The speed setting for the first period will be shown in the flashing Current Period column of the program display. (The incline settings are not shown in the program display.) The speed settings for the next seven-teen periods will be shown in the seventeen columns to the right.

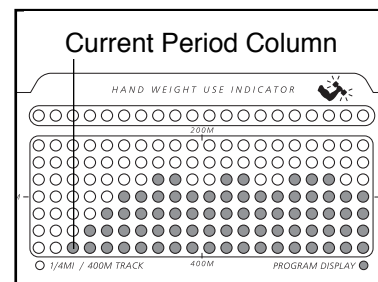

When only three seconds remain in the first period of the program, both the Current Period column and the column to the right will flash, a series of tones will sound, and all speed settings will move one column to the left. The speed setting for the second period will then be shown in the flashing Current Period column and the treadmill will automatically adjust to the second speed and incline settings that you programmed previously.

The program will continue until the speed setting for the last period is shown in the Current Period column and the Time/Segment Time display counts down to zero. The walking belt will then slow to a stop.

Note: If the program is too easy or too difficult, the speed or incline setting for the current period can be adjusted with the Speed or Incline buttons. Adjustments will not be stored in memory. To **reprogram** the speed or incline setting for the current period, press the Record button. The custom program indicator will begin to flash. **Speed and incline settings can be programmed only when the indicator is flashing.** Adjust the speed or incline setting for the current period with the Speed or Incline buttons. After the period is completed, press the Record button again. The new setting will be stored in memory.

To stop the program temporarily, press the Stop button. All displays will pause and the Time/Segment Time display will begin to flash. To restart the program, press the Start button. To end the program, press the Stop button, remove the key, and then reinsert the key.

5 Follow your progress with the five displays.

Refer to step 6 on page 11.

6 Remove the key from the console.

When the program has ended, **make sure that the incline of the treadmill is at 0%.** Next, remove the key from the console. Keep the key in a secure place. **Note: If the displays and indicators on the console remain lit after the key is removed, the console is in the “demo” mode. Refer to page 23 and turn off the demo mode.**

Next, move the on/off switch near the power cord to the off position.

HOW TO CONNECT THE TREADMILL TO YOUR CD PLAYER, VCR, OR COMPUTER

To use **iFit.com CD's**, the treadmill must be connected to your portable CD player, portable stereo, home stereo, or computer with CD player. See pages 18 to 20 for connecting instructions. To use **iFit.com videocassettes**, the treadmill must be connected to your VCR. See page 20 for connecting instructions. To use **iFit.com programs directly from our internet site**, the treadmill must be connected to your home computer. See page 20 for connecting instructions.

HOW TO CONNECT YOUR PORTABLE CD PLAYER

Note: If your CD player has separate LINE OUT and PHONES jacks, see instruction A below. If your CD player has only one jack, see instruction B.

- A. Plug one end of the audio cable into the jack on the front of the treadmill near the power cord. Plug the other end of the cable into the LINE OUT jack on your CD player. Plug your headphones into the PHONES jack.

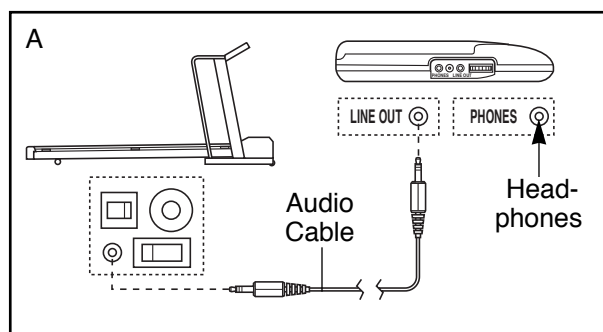

- B. Plug one end of the audio cable into the jack on the front of the treadmill near the power cord. Plug the other end of the cable into a 3.5mm Y-adapter (available at electronics stores). Plug the Y-adapter into the PHONES jack on your CD player. Plug your headphones into the other side of the Y-adapter.

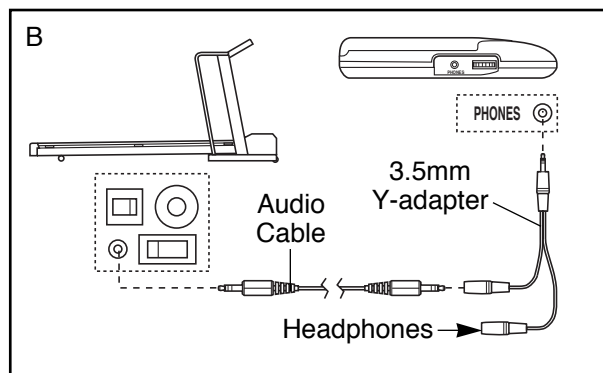

HOW TO CONNECT YOUR PORTABLE STEREO

Note: If your stereo has an RCA-type AUDIO OUT jack, see instruction A below. If your stereo has a 3.5mm LINE OUT jack, see instruction B. If your stereo has only a PHONES jack, see instruction C.

- A. Plug one end of the audio cable into the jack on the front of the treadmill near the power cord. Plug the other end of the cable into the included adapter. Plug the adapter into an AUDIO OUT jack on your stereo.

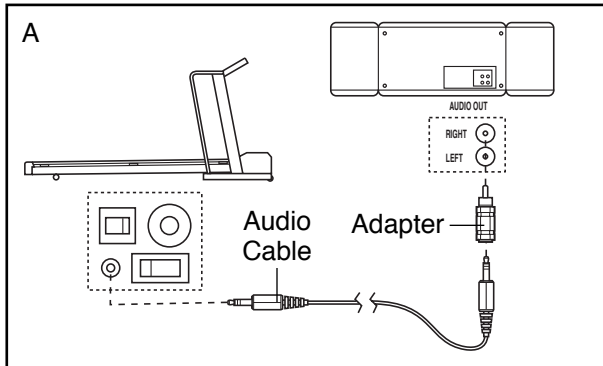

- B. Plug one end of the audio cable into the jack on the front of the treadmill near the power cord. Plug the other end of the cable into the LINE OUT jack on your stereo.

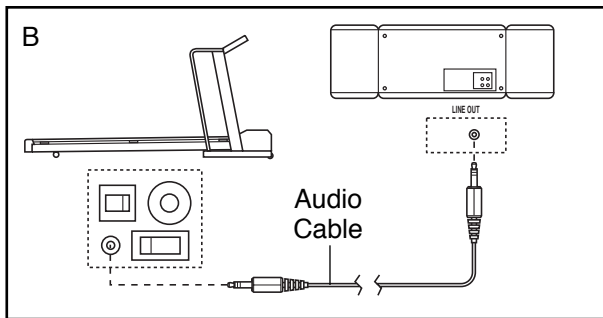

- C. Plug one end of the audio cable into the jack on the front of the treadmill near the power cord. Plug the other end of the cable into a 3.5mm Y-adapter (available at electronics stores). Plug the Y-adapter into the PHONES jack on your stereo. Plug your headphones into the other side of the Y-adapter.

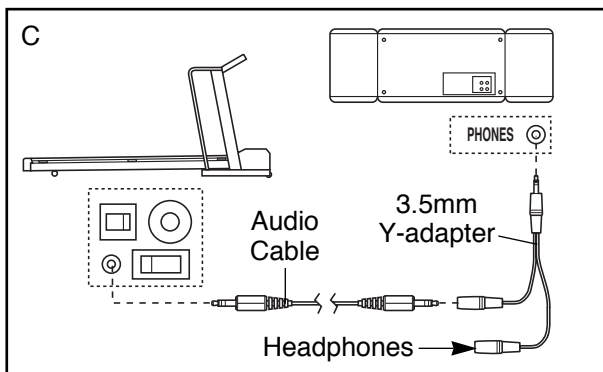

HOW TO CONNECT YOUR HOME STEREO

Note: If your stereo has an unused LINE OUT jack, see instruction A below. If the LINE OUT jack is being used, see instruction B.

- A. Plug one end of the audio cable into the jack on the front of the treadmill near the power cord. Plug the other end of the cable into the included adapter. Plug the adapter into the LINE OUT jack on your stereo.

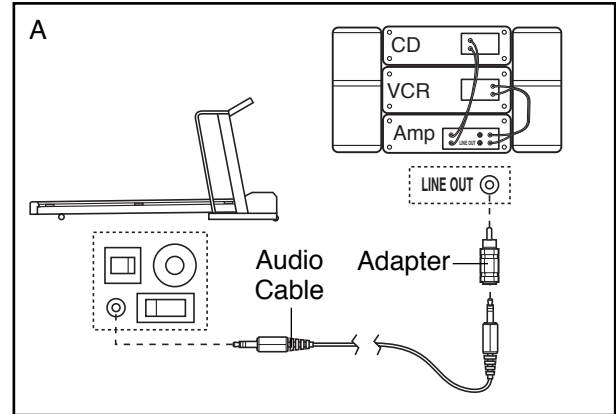

- B. Plug one end of the audio cable into the jack on the front of the treadmill near the power cord. Plug the other end of the cable into the included adapter. Plug the adapter into an RCA adapter (available at electronics stores). Next, remove the wire that is currently plugged into the LINE OUT jack on your stereo and plug the wire into the unused side of the RCA adapter. Plug the RCA adapter into the LINE OUT jack on your stereo.

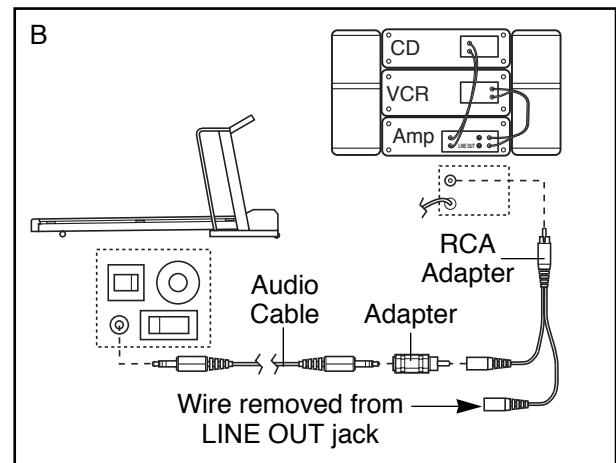

HOW TO CONNECT YOUR COMPUTER

Note: If your computer has a 3.5mm LINE OUT jack, see instruction A. If your computer has only a PHONES jack, see instruction B.

- A. Plug one end of the audio cable into the jack on the front of the treadmill near the power cord. Plug the other end of the cable into the LINE OUT jack on your computer.

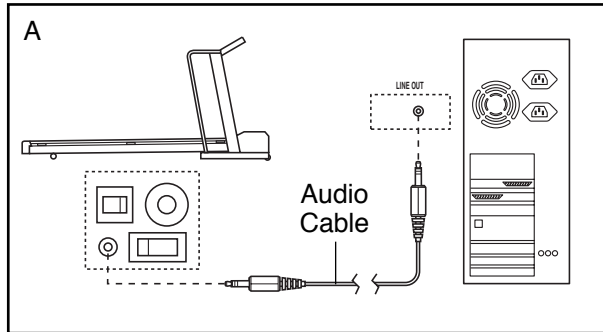

- B. Plug one end of the audio cable into the jack on the front of the treadmill near the power cord. Plug the other end of the cable into a 3.5mm Y-adapter (available at electronics stores). Plug the Y-adapter into the PHONES jack on your computer. Plug your headphones or speakers into the other side of the Y-adapter.

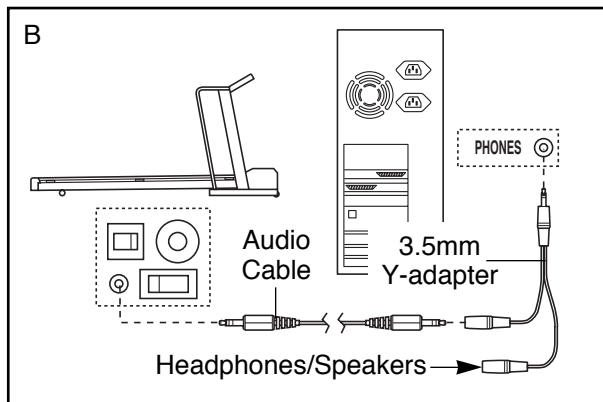

HOW TO CONNECT YOUR VCR

Note: If your VCR has an unused AUDIO OUT jack, see instruction A below. If the AUDIO OUT jack is being used, see instruction B. If you have a TV with a built-in VCR, see instruction B. If your VCR is connected to your home stereo, see HOW TO CONNECT YOUR HOME STEREO on page 19.

- A. Plug one end of the audio cable into the jack on the front of the treadmill near the power cord. Plug the other end of the cable into the included adapter. Plug the adapter into the AUDIO OUT jack on your VCR.

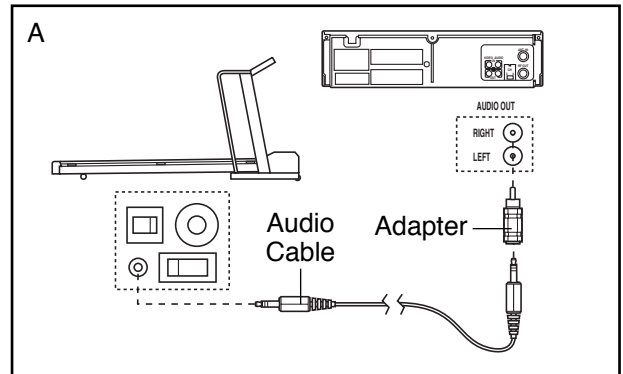

- B. Plug one end of the audio cable into the jack on the front of the treadmill near the power cord. Plug the other end of the cable into the included adapter. Plug the adapter into an RCA adapter (available at electronics stores). Next, remove the wire that is currently plugged into the AUDIO OUT jack on your VCR and plug the wire into the unused side of the RCA adapter. Plug the RCA adapter into the AUDIO OUT jack on your VCR.

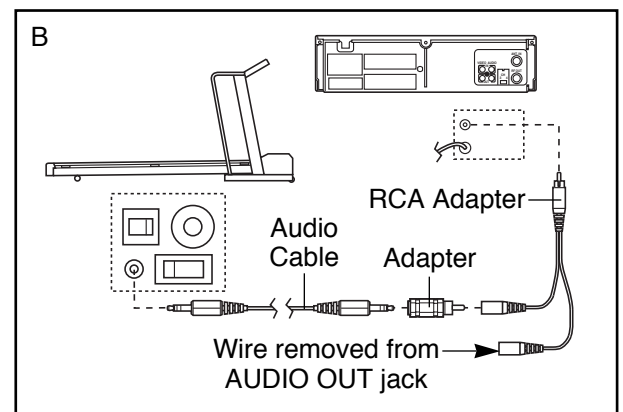

HOW TO USE IFIT.COM CD AND VIDEO PROGRAMS

To use iFit.com CD's or videocassettes, the treadmill must be connected to your portable CD player, portable stereo, home stereo, computer with CD player, or VCR. See HOW TO CONNECT THE TREADMILL TO YOUR CD PLAYER, VCR, OR COMPUTER on page 18. **Note: To purchase iFit.com CD's or iFit.com videocassettes, call toll-free 1-800-735-0768.**

Follow the steps below to use an iFit.com CD or video program.

1 Insert the key into the console.

See HOW TO TURN ON THE POWER on page 10.

2 Select the iFit.com mode.

When the key is inserted, the manual mode will be selected and the manual indicator will light.

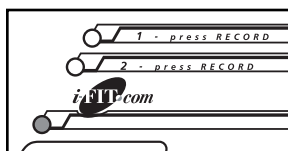

To use iFit.com CD's or videocassettes, press the Program Select button repeatedly until the iFit.com indicator lights.

3 Insert the iFit.com CD or videocassette.

If you are using an iFit.com CD, insert the CD into your CD player. If you are using an iFit.com videocassette, insert the videocassette into your VCR.

4 Press the PLAY button on your CD player or VCR.

A moment after the button is pressed, your personal trainer will begin guiding you through your workout. **Note:** If the Time/Segment Time display is flashing, press the Start button on the console. The treadmill will not respond to a CD or video program when the display is flashing.

During the program, an electronic "chirping" sound will alert you when the speed and/or incline of the treadmill is about to change. **CAUTION: Always listen for the "chirp" and be prepared for speed and/or incline changes. In some instances, the speed and/or incline may change before the personal trainer describes the change.**

If the speed or incline settings are too high or too low, you can manually override the settings at any time by pressing the Speed or Incline buttons on the console. However, **when the next "chirp" is heard, the speed and/or incline will change to**

the next settings of the CD or video program.

To stop the program at any time, press the Stop button on the console. The Time/Segment Time display will begin to flash. To restart the program, press the Start button. After a moment, the walking belt will begin to move at 1.0 mph. **When the next "chirp" is heard, the speed and incline will change to the next settings of the CD or video program.** The program can also be stopped by pressing the Stop button on your CD player or VCR.

When the CD or video program is completed, the walking belt will stop and the Time/Segment Time display will begin to flash. **Note:** To use another CD or video program, press the Stop button or remove the key and go to step 1.

Note: If the speed or incline of the treadmill does not change when a "chirp" is heard:

- make sure that the iFit.com indicator is lit and that the Time/Segment Time display is not flashing. If the Time/Segment Time display is flashing, press the Start button on the console
- adjust the volume of your CD player or VCR. If the volume is too high or too low, the console may not detect the program signals
- make sure that the audio cable is properly connected, that it is fully plugged in, and that it is not wrapped around a power cord
- if you are using your portable CD player and the CD skips, set the CD player on the floor or another flat surface instead of on the console.

5 Follow your progress with the LED track and the five displays.

See step 6 on page 11.

6 When the iFit.com CD or video program is finished, remove the key.

When the program has ended, **make sure that the incline of the treadmill is at 0%.** Next, remove the key from the console. Keep the key in a secure place. **Note: If the displays and indicators on the console remain lit after the key is removed, the console is in the "demo" mode. Refer to page 23 and turn off the demo mode.**

Next, move the on/off switch near the power cord to the off position. **CAUTION: Always remove iFit.com CD's and videocassettes from your CD player or VCR when you are finished using them.**

HOW TO USE PROGRAMS DIRECTLY FROM OUR INTERNET SITE

Our new internet site at www.iFit.com allows you to access a large selection of programs that interactively control your treadmill to help you achieve your specific exercise goals. In addition, you can play iFit.com audio and video programs directly from the internet. By adding an optional upgrade module to the console, you can use virtually endless features on our internet site. Explore www.iFit.com for details. To purchase an upgrade module, call toll-free 1-800-735-0768.

To use programs from our internet site, the treadmill must be connected to your home computer. See HOW TO CONNECT YOUR COMPUTER on page 20. In addition, you must have at least a 56K modem and an account with an internet service provider. A list of additional system and software requirements will be found on our internet site.

Follow the steps below to use a program from our internet site.

1 Insert the key into the console.

See HOW TO TURN ON THE POWER on page 10.

2 Select the iFit.com mode.

When the key is inserted, the manual mode will be selected and the manual indicator will light. To use a program from our internet site, press the Program Select button repeatedly until the iFit.com indicator lights.

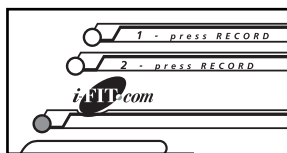

3 Go to your computer and start an internet connection.

4 Start your web browser, if necessary, and go to our internet site at www.iFit.com.

5 Follow the desired links on our internet site to select a program.

Read and follow the on-line instructions for using a program.

6 Follow the on-line instructions to start the program.

When you start the program, an on-screen countdown will begin.

7 Return to the treadmill and stand on the foot rails. Find the clip attached to the key and slide the key onto the waistband of your clothing.

When the on-screen countdown ends, the program will begin and the walking belt will begin to move. Hold the handrails, step onto the walking belt, and begin walking.

During the program, an electronic “chirping” sound will alert you when the speed and/or incline of the treadmill is about to change. **CAUTION: Always listen for the “chirp” and be prepared for speed and/or incline changes.**

If the speed or incline settings are too high or too low, you can manually override the settings at any time by pressing the Speed or Incline buttons on the console. However, **when the next “chirp” is heard, the speed and/or incline will change to the next settings of the program.**

To stop the program at any time, press the Stop button on the console. The Time/Segment Time display will begin to flash. To restart the program, press the Start button. After a moment, the walking belt will begin to move at 1.0 mph. **When the next “chirp” is heard, the speed and incline will change to the next settings of the program.**

When the program is completed, the walking belt will stop and the Time/Segment Time display will begin to flash. Note: To use another program, press the Stop button and go to step 5.

Note: If the speed or incline of the treadmill does not change when a “chirp” is heard, make sure that the iFit.com indicator is lit and that the Time/Segment Time display is not flashing. In addition, make sure that the audio cable is properly connected, that it is fully plugged in, and that it is not wrapped around a power cord.

8 Follow your progress with the LED track and the five displays.

See step 6 on page 11.

9 When the program is finished, remove the key.

When the program has ended, **make sure that the incline of the treadmill is at 0%.** Next, remove the key from the console. Keep the key in a secure place. **Note: If the displays and indicators on the console remain lit after the key is removed, the console is in the “demo” mode. Refer to page 23 and turn off the demo mode.** Next, move the on/off switch near the power cord to the off position.

THE INFORMATION MODE/DEMO MODE

The console features an information mode that keeps track of the total number of hours that the treadmill has been operated and the total number of miles that the walking belt has moved. The information mode also allows you to switch the console from miles per hour to kilometers per hour. In addition, the information mode allows you to turn on and turn off the demo mode.

To select the information mode, hold down the Stop button while inserting the key into the console. When the information mode is selected, the following information will be shown:

The Distance/Incline/Laps display will show the total number of miles that the walking belt has moved.



An "E," for English miles, or an "M," for metric kilometers, will appear in the Speed/Minutes-Mile display. Press the Speed Δ button to change the unit of measurement.

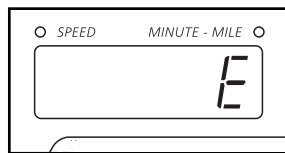

The Time/Segment Time display will show the total number of hours the treadmill has been used.

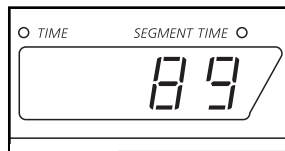

IMPORTANT: The Calories/Fat Calories display should be blank. If a "d" appears in the display, the console is in the "demo" mode. This mode is intended to be used only when a treadmill is displayed in a store. When the console is in the demo mode, the power cord can be plugged in, the key can be removed from the console, and the displays and indicators on the console will automatically light in a pre-set sequence, although the buttons on the console will not operate. **If a "d" appears in the Calories/Fat Calories display when the information mode is selected, press the Speed ∇ button so the Calories/Fat Calories display is blank.**

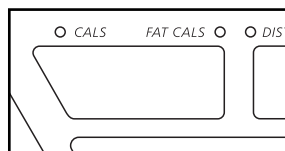
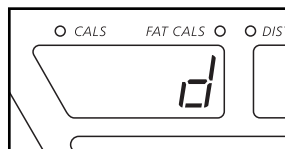

To exit the information mode, remove the key from the console.

HOW TO ADJUST THE FIRMNESS OF THE CUSHIONING SYSTEM

The treadmill features a cushioning system that reduces the impact as you walk or run on the treadmill. The firmness of the cushioning system is controlled with the knob on the right side of the treadmill. To increase the firmness, turn the knob clockwise; to decrease the firmness, turn the knob counterclockwise. The decal above the knob will help you select the desired firmness according to your weight. **Note: The faster you run on the treadmill, the firmer the cushioning system should be. If the cushioning system is too soft, you will hear the walking platform hitting the platform bumpers as you run.**

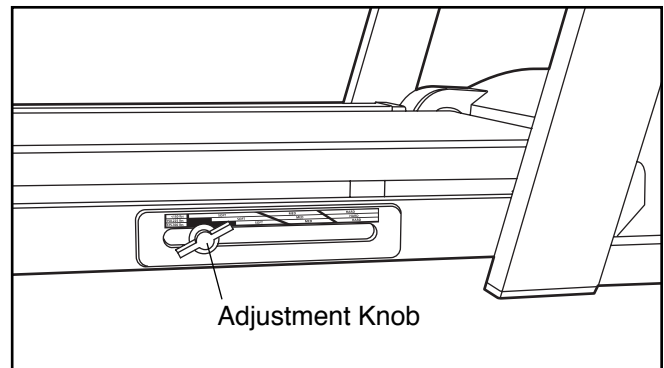

HOW TO FOLD AND MOVE THE TREADMILL

HOW TO FOLD THE TREADMILL FOR STORAGE

Before folding the treadmill, adjust the incline to the lowest position. If this is not done, the treadmill may be permanently damaged. Next, unplug the power cord. **Caution: You must be able to safely lift 45 pounds (20 kg) in order to raise, lower, or move the treadmill.**

1. Hold the treadmill with your hands in the locations shown at the right. **To decrease the possibility of injury, bend your legs and keep your back straight. As you raise the treadmill, make sure to lift with your legs rather than your back.** Raise the treadmill about halfway to the vertical position.

2. Move your right hand to the position shown and hold the treadmill firmly. Hold the lock knob with your left hand and pull it to the side. Raise the treadmill until the lock knob is aligned with the catch. Slowly release the lock knob. **Make sure that the pin on the lock knob is inside of the catch.**

To protect the floor or carpet from damage, place a mat under the treadmill. Keep the treadmill out of direct sunlight. Do not leave the treadmill in the storage position in temperatures above 85° Fahrenheit.

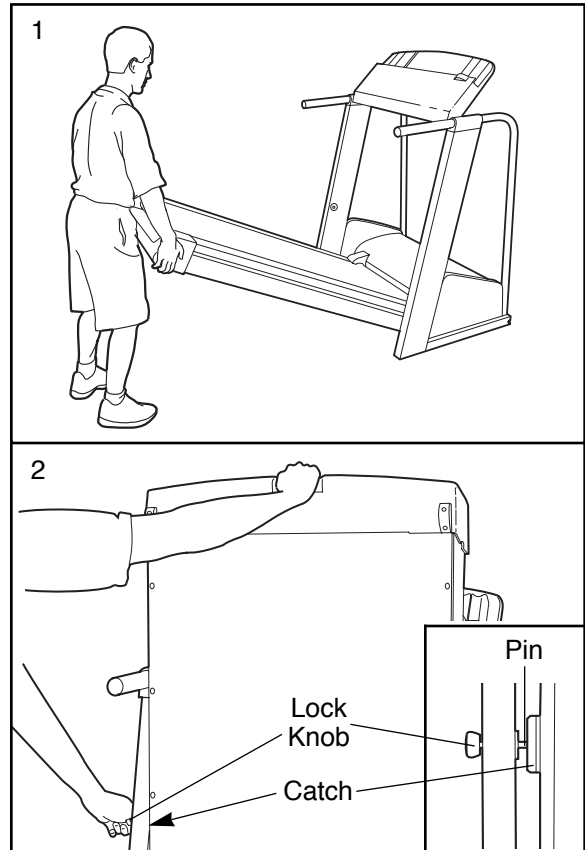

HOW TO MOVE THE TREADMILL

Before moving the treadmill, convert the treadmill to the storage position as described above. **Make sure that the pin on the lock knob is inside of the catch.**

1. Hold the handrails and place one foot on a front wheel as shown.
2. Tilt the treadmill back until it rolls freely on the front wheels. Carefully move the treadmill to the desired location. **Never move the treadmill without tipping it back. To reduce the risk of injury, use extreme caution while moving the treadmill. Do not move the treadmill over an uneven surface.**
3. Place one foot on the base and carefully lower the treadmill until it is resting on the base.



HOW TO LOWER THE TREADMILL FOR USE

1. Refer to drawing 2 above. Hold the upper end of the treadmill with your right hand as shown. Hold the lock knob with your left hand and pull it to the side. Pivot the treadmill down a few inches.
2. Refer to drawing 1 above. Hold the treadmill firmly with both hands, and lower the treadmill to the floor. **To decrease the possibility of injury, bend your legs and keep your back straight.**

TROUBLE-SHOOTING

Most treadmill problems can be solved by following the steps below. Find the symptom that applies, and follow the steps listed. If further assistance is needed, please call our Customer Service Department toll-free at 1-800-999-3756, Monday through Friday, 6 a.m. until 6 p.m. Mountain Time (excluding holidays).

PROBLEM: The power does not turn on

SOLUTION: a. Make sure that the power cord is plugged into a surge protector, and that the surge protector is plugged into a properly grounded outlet. (See HOW TO PLUG IN THE POWER CORD on page 7.) Use only a UL-listed surge protector, rated at 15 amps, with a 14-gauge cord of five feet or less in length

b. After the power cord has been plugged in, make sure that the key is fully inserted into the console.

c. Check the circuit breaker located on the treadmill near the power cord. If the switch protrudes as shown, the circuit breaker has tripped. To reset the circuit breaker, wait for five minutes and then press the switch back in.

d. Check the on/off switch located on the treadmill near the power cord. The switch must be in the on position.

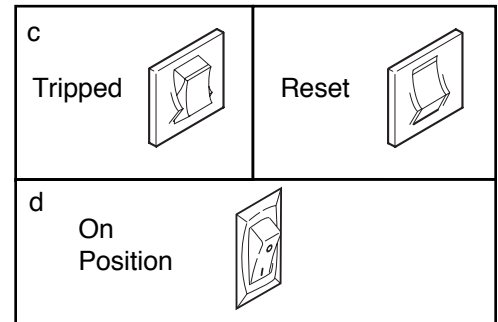

PROBLEM: The power turns off during use

SOLUTION: a. Check the circuit breaker located on the treadmill near the power cord (see c. above). If the circuit breaker has tripped, wait for five minutes and then press the switch back in.

b. Make sure that the power cord is plugged in.

c. Remove the key from the console. Reinsert the key fully into the console.

d. Make sure that the on/off switch is in the on position (see d. above).

e. If the treadmill still will not run, please call our Customer Service Department, toll-free.

PROBLEM: The walking belt slows when walked on

SOLUTION: a. Use only an appropriate surge protector (see a. near the top of this page).

b. If the walking belt is overtightened, treadmill performance may decrease and the walking belt may become damaged. Remove the key and **UNPLUG THE POWER CORD**. Using the allen wrench, turn both rear roller adjustment bolts counterclockwise 1/4 of a turn. When the walking belt is properly tightened, you should be able to lift each side of the walking belt 3 to 4 inches off the walking platform. Be careful to keep the walking belt centered. Plug in the power cord, insert the key, and run the treadmill for a few minutes. Repeat until the walking belt is properly tightened.

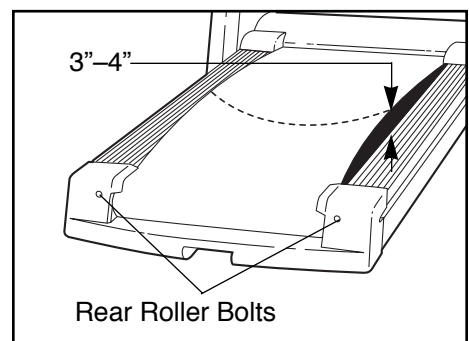

c. If the walking belt still slows when walked on, please call our Customer Service Department, toll-free.

PROBLEM: The walking belt is off-center

SOLUTION: a. If the walking belt has shifted to the left, first remove the key and **UNPLUG THE POWER CORD**. Using the allen wrench, turn the left rear roller adjustment bolt clockwise, and the right bolt counterclockwise, 1/4 of a turn each. Be careful not to overtighten the walking belt. Plug in the power cord, insert the key and run the treadmill for a few minutes. Repeat until the walking belt is centered.

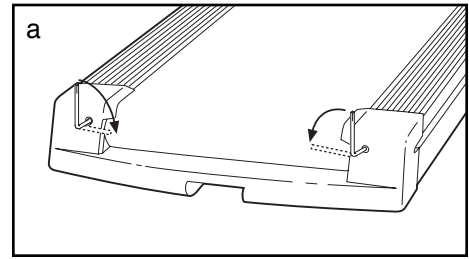

b. If the walking belt has shifted to the right, first remove the key and **UNPLUG THE POWER CORD**. Using the allen wrench, turn the left rear roller adjustment bolt counterclockwise, and the right bolt clockwise, 1/4 of a turn each. Be careful not to overtighten the walking belt. Plug in the power cord, insert the key and run the treadmill for a few minutes. Repeat until the walking belt is centered.

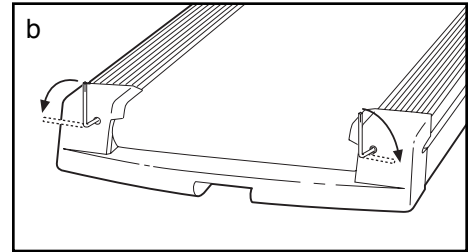

c. If the walking belt slips when walked on, first remove the key and **UNPLUG THE POWER CORD**. Using the allen wrench, turn both rear roller adjustment bolts clockwise 1/4 of a turn. When the walking belt is correctly tightened, you should be able to lift each side of the walking belt 3 to 4 inches off the walking platform. Be careful to keep the walking belt centered. Plug in the power cord, insert the key and carefully walk on the treadmill for a few minutes. Repeat until the walking belt is properly tightened.

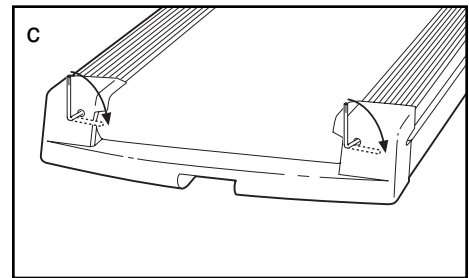

PROBLEM: The Speed/Minutes-Mile display on the console does not function properly

SOLUTION: a. Remove the key from the console and **unplug the power cord**. Remove the screws from the hood and carefully remove the hood. Locate the Reed Switch (17) and the Magnet (12) on the left side of the Pulley (11). Turn the Pulley until the Magnet is aligned with the Reed Switch. **Make sure that the gap between the Magnet and the Reed Switch is about 1/8"**. If necessary, loosen the Reed Switch Screw (26) and move the Reed Switch slightly. Retighten the Screw. Re-attach the hood and run the treadmill for a few minutes to check for a correct speed reading.

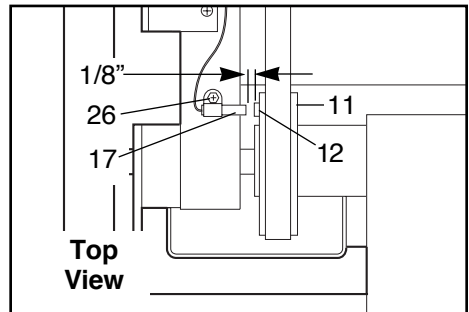

PROBLEM: The heart rate monitor does not function properly

SOLUTION: a. If the heart rate monitor does not function properly, see HEART RATE MONITOR TROUBLE-SHOOTING on page 6.

b. If the heart rate monitor still does not function properly, the battery should be changed. To replace the battery, locate the battery cover on the back of the sensor unit. Insert a coin into the slot in the cover and turn the cover counterclockwise to the “open” position. Remove the cover.

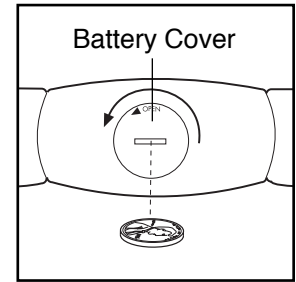

Remove the old battery from the sensor unit. Insert a new **CR 2032 battery**, making sure that the writing is on top. In addition, make sure that the rubber gasket is in place in the sensor unit. Replace the battery cover and turn it to the closed position.

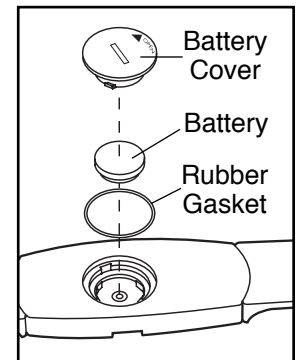

CONDITIONING GUIDELINES

⚠ WARNING: Before beginning this or any exercise program, consult your physician. This is especially important for individuals over the age of 35 or individuals with pre-existing health problems.

The following guidelines will help you to plan your exercise program. Remember—these are general guidelines. For more detailed information about exercise, obtain a book or consult your physician.

EXERCISE INTENSITY

Whether your goal is to burn fat or strengthen your cardiovascular system, the key to achieving the desired results is to exercise with the proper intensity. The proper intensity level can be found by using your heart rate as a guide. For effective exercise, your heart rate should be maintained at a level between 65% and 85% of your maximum heart rate as you exercise. This is known as your training zone.

You can find your training zone in the table below. Training zones are listed according to age and physical condition.

Age	Training Zone (Beats/Min.)	
	Unconditioned	Conditioned
20	138-167	133-162
25	136-166	132-160
30	135-164	130-158
35	134-162	129-156
40	132-161	127-155
45	131-159	125-153
50	129-156	124-150
55	127-155	122-149
60	126-153	121-147
65	125-151	119-145
70	123-150	118-144
75	122-147	117-142
80	120-146	115-140
85	118-144	114-139

Burning Fat

To burn fat, you must exercise at a low intensity level for a sustained period of time. During the first few minutes of exercise, your body uses easily accessible carbohydrate calories for energy. Only after the first few minutes of exercise does your body begin to use stored fat calories for energy. If your goal is to burn fat, adjust the intensity of your exercise until your heart rate is near the low end of your training zone as you exercise.

Aerobic Exercise

If your goal is to strengthen your cardiovascular system, your exercise must be “aerobic.” Aerobic exercise is activity that requires large amounts of oxygen for prolonged periods of time. This increases the demand on the heart to pump blood to the muscles, and on the lungs to oxygenate the blood. For aerobic exercise, adjust the intensity of your exercise until your heart rate is near the middle of your training zone.

⚠ WARNING: The heart rate monitor is not a medical device. Various factors, including your movement, may affect the accuracy of heart rate readings. The heart rate monitor is intended only as an exercise aid in determining heart rate trends in general.

WORKOUT GUIDELINES

Each workout should include the following three important parts: (1) a warm-up, (2) training zone exercise, and (3) a cool-down.

Warming Up

Warming up prepares the body for exercise by increasing circulation, delivering more oxygen to the muscles, and raising the body temperature. Begin each workout with 5 to 10 minutes of stretching and light exercise to warm up (see SUGGESTED STRETCHES on page 29).

Training Zone Exercise

After warming up, increase the intensity of your exercise until your heart rate is in your training zone for 20 to 60 minutes. (During the first few weeks of your exercise program, do not keep your heart rate in your training zone for longer than 20 minutes.) Breathe regularly and deeply as you exercise—never hold your breath.

Cooling Down

Finish each workout with 5 to 10 minutes of stretching to cool down. This will increase the flexibility of your muscles and will help to prevent post-exercise problems.

Exercise Frequency

To maintain or improve your condition, complete three workouts each week, with at least one day of rest between workouts. After a few months, you may complete up to five workouts each week if desired. The key to success is to make exercise a regular and enjoyable part of your everyday life.

SUGGESTED STRETCHES

The correct form for several basic stretches is shown at the right. Move slowly as you stretch—never bounce.

1. Toe Touch Stretch

Stand with your knees bent slightly and slowly bend forward from your hips. Allow your back and shoulders to relax as you reach down toward your toes as far as possible. Hold for 15 counts, then relax. Repeat 3 times. Stretches: Hamstrings, back of knees and back.

2. Hamstring Stretch

Sit with one leg extended. Bring the sole of the opposite foot toward you and rest it against the inner thigh of your extended leg. Reach toward your toes as far as possible. Hold for 15 counts, then relax. Repeat 3 times for each leg. Stretches: Hamstrings, lower back and groin.

3. Calf/Achilles Stretch

With one leg in front of the other, reach forward and place your hands against a wall. Keep your back leg straight and your back foot flat on the floor. Bend your front leg, lean forward and move your hips toward the wall. Hold for 15 counts, then relax. Repeat 3 times for each leg. To cause further stretching of the achilles tendons, bend your back leg as well. Stretches: Calves, achilles tendons and ankles.

4. Quadriceps Stretch

With one hand against a wall for balance, reach back and grasp one foot with your other hand. Bring your heel as close to your buttocks as possible. Hold for 15 counts, then relax. Repeat 3 times for each leg. Stretches: Quadriceps and hip muscles.

5. Inner Thigh Stretch

Sit with the soles of your feet together and your knees outward. Pull your feet toward your groin area as far as possible. Hold for 15 counts, then relax. Repeat 3 times. Stretches: Quadriceps and hip muscles.

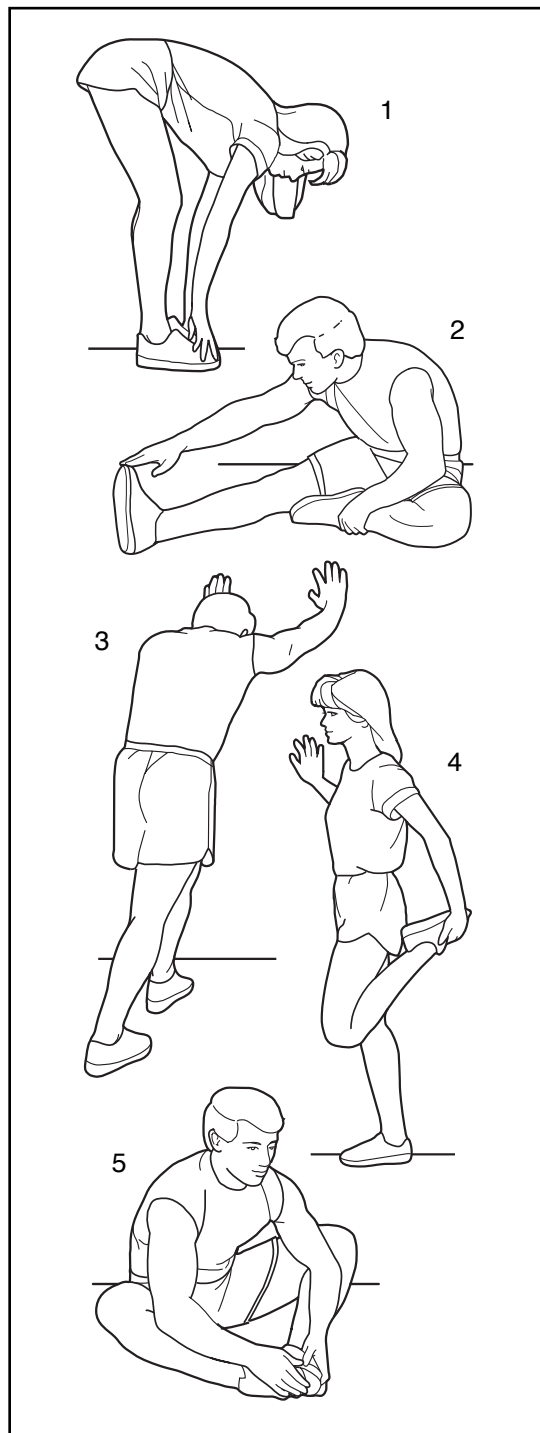

PART LIST—Model No. IMTL15990

R0100A

Note: To identify the parts listed below, refer to the EXPLODED DRAWING attached in the center of this manual.

Key No.	Qty.	Description	Key No.	Qty.	Description
1	2	Foot Rail Insert	51	1	Chest Pulse Strap
2	1	Right Foot Rail	52	4	Roller Adj. Washer
3*	1	Idler Assembly	53	2	Rear Roller Adjustment Bolt
4	2	Isolator	54	1	Rear Endcap
5	1	Latch Catch	55	1	Frame
6	1	Platform	56	1	Allen Wrench
7	5	Walking Deck Screw	57	3	Rear Platform Screw
8	1	Walking Belt	58	1	Rear Roller
9	2	Frame Pivot Bolt	59	2	Left Upright Cover
10	1	Latch Assembly	60	2	Right Upright Cover
11	1	Front Wheel/Pulley	61	6	Upright Cover Screw
12	1	Magnet	62	1	Left Foam Grip
13	4	Front Wheel Nut/Frame Pivot Nut	63	2	Handrail Endcap
14	2	Spacer Insert	64	1	Pulse Sensor
15	2	Frame Pivot Spacer	65	1	Upright
16	1	Reed Switch Clip	66	4	Base Mounting Screw
17	1	Reed Switch	67	1	Lock Knob
18	1	Lift Frame	68	1	Lock Knob Sleeve
19	4	Wire Clip	69	1	Lock Knob Spring
20	1	Idler Arm	70	1	Lock Pin Collar
21	1	Left Foot Rail Endcap	71	1	Pin Clip
22	1	Motor Belt	72	1	Lock Pin
23	1	Idler Pulley	73	2	Incline Pivot Bolt
24	1	Motor	74	1	Wire Harness Grommet
25	1	Pulley Spacer	75	4	Console Screw (long)
26	22	Screw	76	2	Wheel Spacer
27	4	Hood Bracket	77	2	Front Wheel
28	1	Pulley Nut	78	2	Wheel Bolt
29	1	Idler Spring	79	1	Right Foam Grip
30	5	Lift Motor Nut/Pivot Nut	80	1	Console Base (Top)
31	1	Lift Motor Bolt	81	1	Console
32	4	Motor Bolt	82	1	Key/Clip
33	1	Outlet Bracket	83	1	Console Base (Bottom)
34	4	Plastic Stand-Off	84	1	Left Foot Rail
35	1	Power Supply	85	1	Upright Wire Harness
36	1	Power Supply Bracket	86	1	Shock
37	1	Controller	87	2	Upright Endcap
38	1	Controller Bracket	88	2	Pulley Washer
39	1	Motor Hood	89	1	Right Foot Rail Endcap
40	24	Hood Screw	90	1	Latch Warning Decal
41	1	Motor Belly Pan	91	1	Incline Motor
42	2	Belt Guide	92	1	8" Wire Harness
43	4	Belt Guide Screw	93	2	Incline Motor Spacer
44	13	Plastic Fastener	94	1	Tie Holder Screw
45	1	Frame Belly Pan	95	1	Tie Holder
46	1	24" Reed Wire	96	1	Tie
47	1	Ground Screw	97	5	8" Cable Tie
48	2	Rear Foot	98	2	Bumper
49	4	Isolator Washer	99	4	Bumper Screw
50	6	Isolator Nut	100	1	On/Off Switch

Key No.	Qty.	Description	Key No.	Qty.	Description
101	1	Circuit Breaker	123	4	Gear Screw
102	1	Power Cord	124	4	Leaf Spring Nut
103	1	Power Cord Grommet	125	4	Leaf Spring Bolt
104	1	Warning Decal	126	2	Leaf Spring Spacer Bolt
105	1	Chest Pulse Sensor	127	2	Outlet Bracket Star Washer
106	1	Jack	128	12	Rack Screw
107	1	10' IFit.com Audio Cable	129	4	Push Nut
108	2	Foam Grip Screw	130	2	Leaf Spring Spacer
109	2	2-pound Weight	131	2	Leaf Spring Cap
110	4	Console Screw (short)	132	2	Adj. Rod Spacer
111	1	12" Audio Wire	#	1	14" White Wire, 2 F
112	1	Tension Washer	#	1	4" White Wire, M/F
113	1	Tension Bolt	#	1	4" Blue Wire, 2 F
114	2	Motor Mounting Washer	#	1	8" Blue Wire, 2 F
115	2	Front Isolator	#	1	8" Black Wire, M/F
116	2	Leaf Spring	#	1	4" Black Wire, 2 F
117	1	Cushion Adjustment Rod	#	1	8" Red Wire, M/F
118	1	Left Cushion Adj. Rack	#	1	14" Green Wire, F/Ring
119	1	Right Cushion Adj. Rack	#	1	User's Manual
120	2	Cushion Adj. Gear			
121	1	Cushion Adj. Knob			
122	1	Roll Pin			

* Includes all parts shown in the box

These parts are not illustrated

ORDERING REPLACEMENT PARTS

To order replacement parts, call our Customer Service Department toll-free at 1-800-999-3756, Monday through Friday, 6 a.m. until 6 p.m. Mountain Time (excluding holidays). When ordering parts, please be prepared to give the following information:

When requesting help or service, or ordering parts, please be prepared to provide the following information:

- The MODEL NUMBER of the product (IMTL15990)
- The NAME of the product (IMAGE® 10.6Qi treadmill)
- The SERIAL NUMBER of the product (see the front cover of this manual)
- The KEY NUMBER AND DESCRIPTION OF THE PART (see the PART LIST at the left and above and the EXPLODED DRAWING in the center of this manual)

If possible, place the treadmill near your telephone for easy reference when calling.

EXPLODED DRAWING—Model No. IMTL15990

R0100A

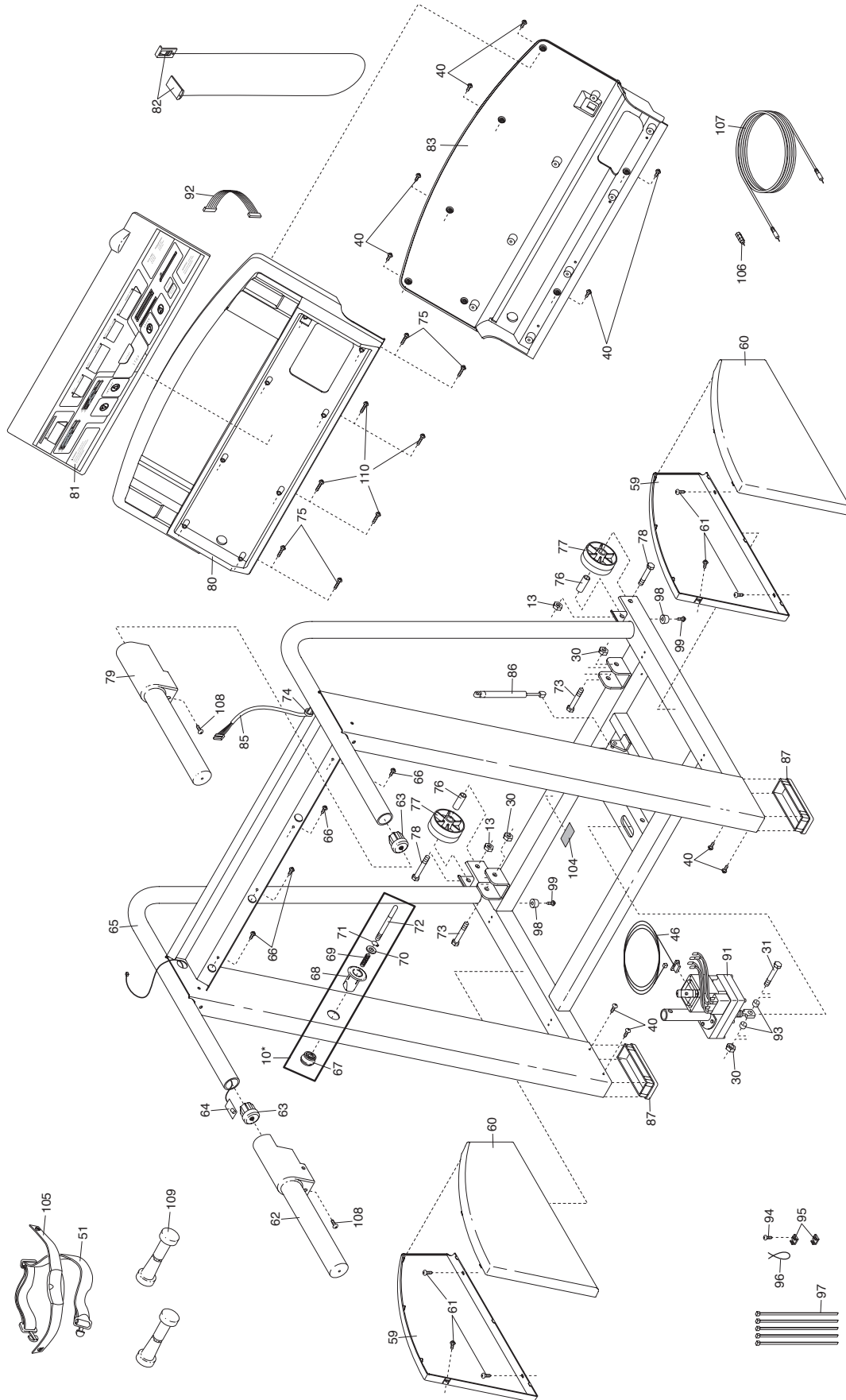

Limited Warranty

WHAT IS COVERED—The entire IMAGE® 10.6Qi (“Product”) is warranted to be free of all defects in material and workmanship.

WHO IS COVERED—The original purchaser or any person receiving the Product as a gift from the original purchaser.

HOW LONG IS IT COVERED—ICON Health & Fitness, Inc. (“ICON”), warrants the motor for three years after the date of purchase. The belt and deck are covered for two years after the date of purchase. All mechanical components are covered for two years after the date of purchase. All electrical components are covered for two years after the date of purchase. Labor is covered for one year.

WHAT WE DO TO CORRECT COVERED DEFECTS—We will ship to you, without charge, any replacement part or component, providing the repairs are authorized by ICON first and are performed by an ICON trained and authorized service provider, or, at our option, we will replace the Product.

WHAT IS NOT COVERED—Any failures or damage caused by unauthorized service, misuse, accident, negligence, improper assembly or installation, alterations, modifications without our written authorization or by failure on your part to use, operate, and maintain as set out in your User’s Manual (“Manual”).

WHAT YOU MUST DO—Always retain proof of purchase, such as your bill of sale; store, operate, and maintain the Product as specified in the Manual; notify our Customer Service Department of any defect within 10 days after discovery of the defect; as instructed, return any defected part for replacement or, if necessary, the entire product, for repair.

USER’S MANUAL—It is VERY IMPORTANT THAT YOU READ THE MANUAL before operating the Product. Remember to do the periodic maintenance requirements specified in the Manual to assure proper operation and your continued satisfaction.

HOW TO GET PARTS AND SERVICE—Simply call our Customer Service Department at 1-800-999-3756 and tell them your name and address and the serial number of your Product. They will tell you how to get a part replaced, or if necessary, arrange for service where your Product is located or advise you how to ship the Product for service. Before shipping, always obtain a Return Authorization Number (RA No.) from our Customer Service Department; securely pack your Product (save the original shipping carton if possible); put the RA No. on the outside of the carton and insure the product. Include a letter explaining the product or problem and a copy of your proof of purchase if you believe the service is covered by warranty.

ICON is not responsible or liable for indirect, special or consequential damages arising out of or in connection with the use or performance of the product or damages with respect to any economic loss, loss of property, loss of revenues or profits, loss of enjoyment or use, costs of removal, installation or other consequential damages of whatsoever nature. Some states do not allow the exclusion or limitation of incidental or consequential damages. Accordingly, the above limitation may not apply to you.

The warranty extended hereunder is in lieu of any and all other warranties and any implied warranties of merchantability or fitness for a particular purpose is limited in its scope and duration to the terms set forth herein. Some states do not allow limitations on how long an implied warranty lasts. Accordingly, the above limitation may not apply to you.

No one is authorized to change, modify or extend the terms of this limited warranty.

This warranty gives you specific legal rights and you may have other rights which vary from state to state.

ICON HEALTH & FITNESS, INC., 1500 S. 1000 W., LOGAN, UT 84321-9813

IMAGE is a registered trademark of ICON Health & Fitness, Inc.