

# ACCESS™

# 3000 IMAGE

Model No. IMTL30261

## QUESTIONS?

As a manufacturer, we are committed to providing complete customer satisfaction. If you have questions, or find that there are missing or damaged parts, we will guarantee complete satisfaction through direct assistance from our factory.

**TO AVOID UNNECESSARY DELAYS, PLEASE CALL DIRECT TO OUR TOLL-FREE CUSTOMER HOT LINE.** The trained technicians on our Customer Hot Line will provide immediate assistance, free of charge to you.

**CUSTOMER HOT LINE:  
1-800-999-3756**  
Mon.-Fri., 6 a.m.-6 p.m. MST

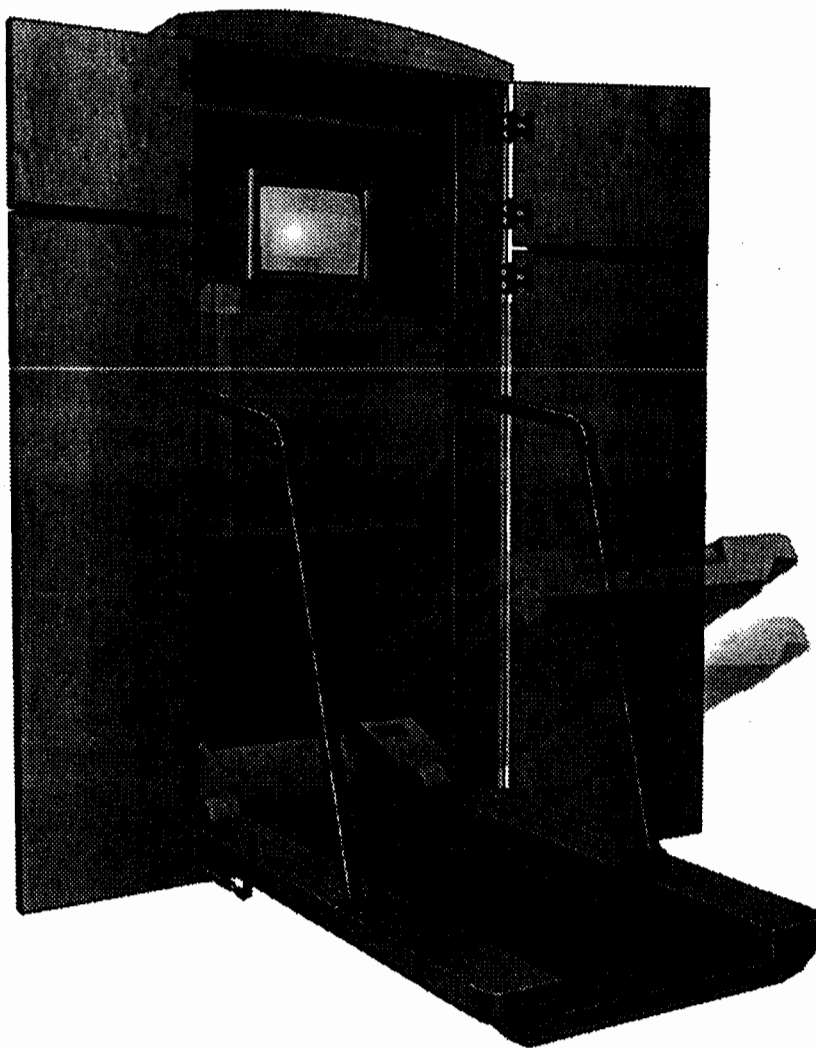

## **▲ CAUTION**

Read all precautions and instructions in this manual before using this equipment. Save this manual for future reference.

# USER'S MANUAL

# ACCESS™

# 3000 IMAGE®

---

## TABLE OF CONTENTS

IMPORTANT PRECAUTIONS .....	3
BEFORE YOU BEGIN .....	6
ASSEMBLY .....	7
GROUNDING INSTRUCTIONS .....	10
CONSOLE OPERATION .....	11
TELEVISION OPERATION .....	17
HOW TO FOLD THE TREADMILL .....	24
TROUBLE-SHOOTING .....	25
CONDITIONING GUIDELINES .....	28
PART LIST .....	30
ORDERING REPLACEMENT PARTS .....	BACK COVER
LIMITED WARRANTY .....	BACK COVER

Note: An EXPLODED DRAWING is attached to the center of this manual. Please save the EXPLODED DRAWING for future reference.

**⚠ WARNING:** Before beginning this or any exercise program, consult your physician. This is especially important for persons over the age of 35 or persons with pre-existing health problems. Read all instructions before using. ICON assumes no responsibility for personal injury or property damage sustained by or through the use of this product.

# IMPORTANT PRECAUTIONS

**⚠ WARNING:** To reduce the risk of burns, fire, electric shock, or injury to persons, read all important precautions and information in this manual before operating the treadmill or the television.

1. It is the responsibility of the owner to ensure that all users of this treadmill are adequately informed of all warnings and precautions.
2. Use the treadmill only as described in this manual.
3. The treadmill is intended for home use only. Do not use the treadmill in any commercial, rental, or institutional setting.
4. Place the treadmill on a level surface, with eight feet of clearance behind it. To protect the floor or carpet from damage, place a mat under the treadmill.
5. Slots and openings in the treadmill and TV are provided for ventilation, to ensure reliable operation, and to help prevent overheating. These openings must not be blocked or covered. Do not place the treadmill on any surface that blocks openings, or near a radiator or other heat source.
6. Keep the treadmill indoors, away from moisture and dust. Do not place the treadmill in a garage or covered patio, or near water.
7. Do not operate the treadmill where aerosol products are used or where oxygen is being administered.
8. You must be able to safely lift 45 pounds (20 kg) in order to raise or lower the treadmill.
9. Keep small children and pets away from the treadmill at all times.
10. The treadmill should not be used by persons weighing more than 250 pounds.
11. Never allow more than one person on the treadmill at a time.
12. Wear appropriate exercise clothing when using the treadmill. Do not wear loose clothing that could become caught in the treadmill. Athletic support clothes are recommended for both men and women. *Always wear athletic shoes. Never use the treadmill with bare feet, wearing only stockings, or in sandals.*
13. Inspect and tighten all parts of the treadmill every three months.
14. Objects placed on the cabinet shelves may shift and fall when the treadmill is in use. Never place objects on the lower shelf when the treadmill is in use. The lower shelf is designed for storing items when the treadmill is not in use.
15. The treadmill operates on 120 V, 60 Hz, AC power only. Consult your dealer before connecting the treadmill if you do not know the AC voltage in your area, as incorrect voltage might damage the treadmill or TV. Never connect the treadmill to other than the specified voltage such as 50 Hz or to direct current.
16. When connecting the power cord (see HOW TO PLUG IN THE POWER CORD on page 10), plug the power cord into a surge protector (not included) and plug the surge protector into a grounded circuit capable of carrying 15 or more amps. No other appliance should be on the same circuit. Do not overload wall outlets as this can result in a risk of electric shock, fires and other hazards.
17. Use only a UL-listed surge protector, rated at 15 amps, with a 14-gauge cord of five feet or less in length. Do not use an extension cord.
18. The power cord and surge protector should be positioned so they are not likely to be walked on or pinched by items placed upon or against them, paying particular attention to the cords at the plugs, convenience receptacles, and the point where the power cord exits the treadmill. Keep the power cord and surge protector away from heated surfaces.
19. Do not operate the treadmill if the power cord or plug is damaged or if the treadmill is not working properly. (See BEFORE YOU BEGIN on page 6 if the treadmill is not working properly.)
20. If an outside antenna or cable system is connected, be sure that the antenna or cable system is grounded so as to provide some protection against voltage surges and built-up

static charges. Section 810 of the National Electrical Code, ANSI/NFPA No. 70-1984, provides information with respect to proper grounding of the mast and supporting structure, grounding of the lead-in wire to an antenna discharge unit, size of grounding conductors, location of antenna discharge unit, connection to grounding electrodes, and requirements for the grounding electrode.

21. An outside antenna system should not be located in the vicinity of overhead power lines or other electric light or power circuits, or where it can fall into such power lines or circuits. When installing an outside antenna system, extreme care should be taken to keep from touching such power lines or circuits as contact with them might be fatal.
22. Never start the treadmill while you are standing on the walking belt. Always hold the handrails while using the treadmill.
23. The treadmill is capable of high speeds. Adjust the speed in small increments to avoid sudden jumps in speed.
24. To reduce the possibility of the treadmill overheating, do not operate the treadmill continuously for longer than one hour.
25. Never leave the treadmill unattended while it is running. Move the on/off switch to the "off" position when the treadmill is not in use.
26. To protect the treadmill and TV during lightning storms, unplug the power cord from the wall outlet and disconnect the antenna or cable system. This will prevent damage due to lightning and power line surges.
27. Do not push objects through any openings in the treadmill or TV as they may touch dangerous voltage points or short out parts that could result in fire or electric shock. Never spill or spray any type of liquid into the treadmill or TV.
28. Unplug the treadmill from the wall outlet before cleaning. Do not use liquid cleaners or aerosol cleaners. Use a damp cloth for cleaning.
29. Always unplug the power cord before performing the maintenance and adjustment procedures described in this manual. Never remove the motor hood unless instructed to

do so by an authorized service representative. Servicing other than the procedures in this manual should be performed by an authorized service representative only.

30. To reduce the risk of electric shock, do not remove the cover or back of the TV. There are no user serviceable parts inside. Refer servicing to qualified service personnel.
31. The graphic symbols on the back cover of the TV mean the following:

The lightning flash with arrowhead symbol within an equilateral triangle is intended to alert the user to the presence of uninsulated "dangerous voltage" within the TV's enclosure that may be of sufficient magnitude to constitute a risk of electric shock to persons.



The exclamation point within an equilateral triangle is intended to alert the user to the presence of important operating and maintenance (servicing) instructions in this manual.



32. Unplug the treadmill from the wall outlet and refer servicing to qualified service personnel under the following conditions:
  - When the power cord or plug is damaged.
  - If liquid has been spilled, or objects have fallen into the treadmill.
  - If the treadmill has been exposed to water.
  - If the treadmill or TV does not operate normally when the operating instructions are followed. Adjust only those controls that are covered by the operating instructions, as improper adjustment of other controls may result in damage and will often require extensive work by a qualified technician to restore normal operation.
  - If the treadmill has been dropped.
  - When the treadmill exhibits a distinct change in performance.
33. When replacement parts are required, be sure the service technician uses replacement parts specified by the manufacturer or those that have the same characteristics as the original part. Unauthorized substitutions may result in fire, electric shock, or other hazards.

34. Upon completion of any service or repairs to the treadmill or TV, ask the service technician to perform safety checks to determine that the unit is in proper operating condition (refer to the drawing below).

- Use No. 10 AWG (5.3mm<sup>2</sup>) copper, No. 8 AWG (8.4mm<sup>2</sup>) aluminum, No. 17 AWG (1.0mm<sup>2</sup>) copper-clad steel or bronze wire, or larger as a ground wire.
- Secure antenna lead-in and ground wires to house with stand-off insulators spaced from 4 to 6 feet (1.22 to 1.83m) apart.
- Mount antenna discharge unit as close as

possible to where the lead-in enters the house.

- Use Jumper wire not smaller than No. 6 AWG (13.3mm<sup>2</sup>) copper, or the equivalent when a separate antenna-grounding electrode is used. See NEC Section 810-21 (j).

Note to CATV system Installer: This reminder is provided to call the CATV system installer's attention to Article 820-40 of the NEC that provides guidelines for proper grounding and, in particular, specifies that the cable ground shall be connected to the grounding system of the building, as close to the point of cable entry as practical.

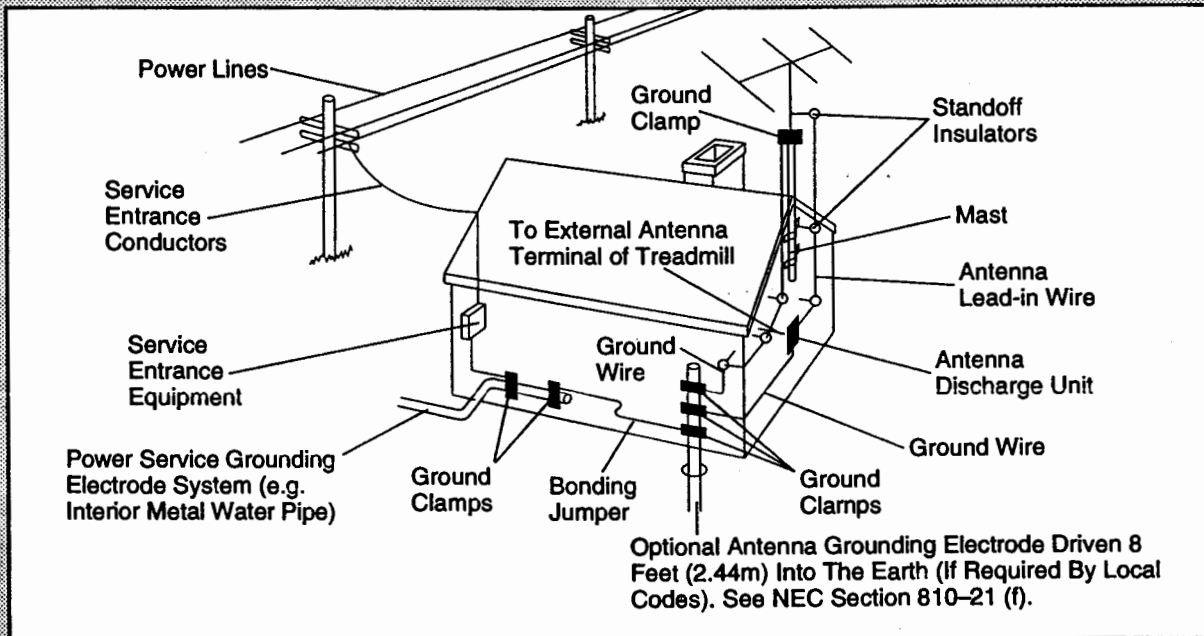

## SAVE THESE INSTRUCTIONS

The decal shown below is found in the indicated locations on the treadmill. If the decal is missing, or if it is not legible, call our Customer Service Department, toll-free, to order a free replacement decal (see ORDERING REPLACEMENT PARTS on the back cover of this manual). Apply the decal in the locations shown.

**IMPORTANT:** *Incline must be at lowest level before folding treadmill into storage position.*

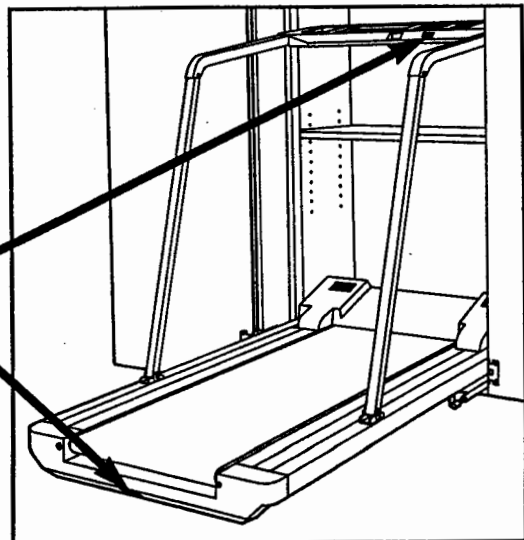

# BEFORE YOU BEGIN

Congratulations for selecting the IMAGE® ACCESS 3000 treadmill. The revolutionary ACCESS 3000 offers an impressive array of features that provide you with enjoyable and effective workouts in the convenience and privacy of your home.

**For your benefit, read this manual carefully before using the ACCESS 3000.** If you have questions after reading this manual, please call our Customer Service Department, toll-free, at 1-800-999-3756, Monday

through Friday, 6 a.m. until 6 p.m. Mountain Time (excluding holidays). To help us assist you, please note the product model number and serial number before calling. The model number of the ACCESS 3000 is IMTL30261. The serial number can be found on a decal attached to the treadmill (see the inset drawing below).

Before reading further, please review the drawing below and familiarize yourself with the labeled parts.

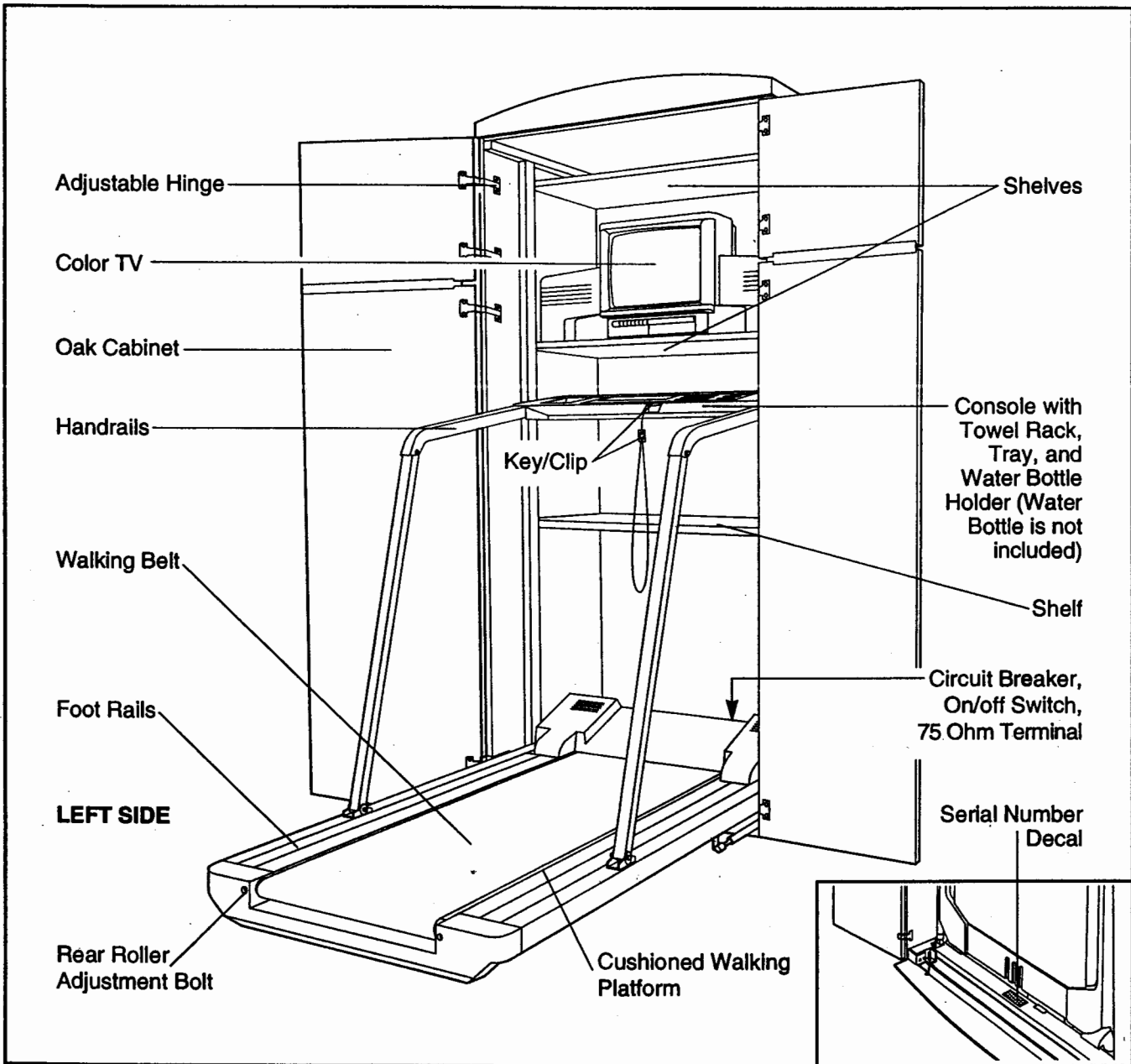

# ASSEMBLY

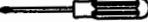
Assembly requires two people. Set the treadmill in a cleared area and remove the packing materials. Do not dispose of the packing materials until assembly is completed. Assembly requires a crescent wrench  and a phillips screwdriver  (not included).

1. Remove the Shelf Board (168), Stabilizer (162), Remote Control (92), batteries, and packing materials from the top of the cabinet.

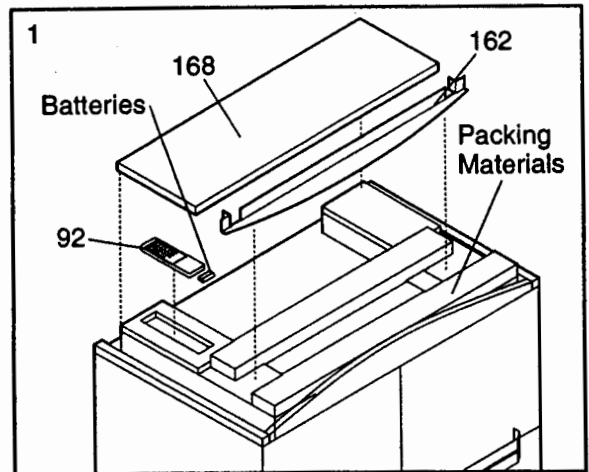

2. Using wire cutters, cut the plastic ties underneath the pallet base.

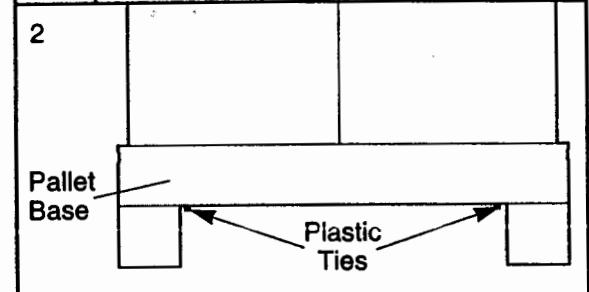

3. With the help of a second person, carefully tip the cabinet to one side until the Base Feet (147) are lifted out of the holes in the pallet base. Turn the cabinet slightly and lower the cabinet so the Base Feet are resting on top of the pallet base. Lift the Base Feet out of the other side of the pallet base in the same manner.

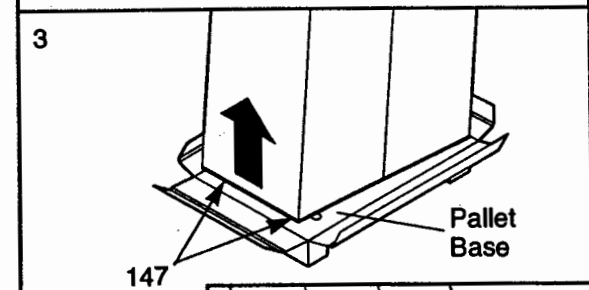

Refer to the inset drawing. With the help of a second person, carefully "walk" the cabinet back until one edge of the cabinet can be tipped onto the floor as shown. With the cabinet tipped back slightly, slide the pallet base out from underneath the cabinet.

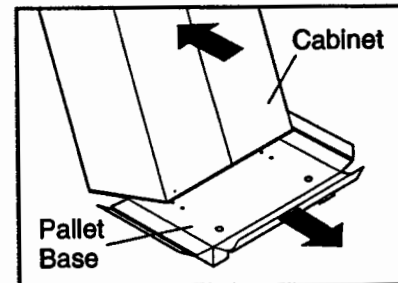

Move the cabinet to the desired location.

4. Open the cabinet doors. Using wire cutters, cut the cable ties around the Handrails (52).

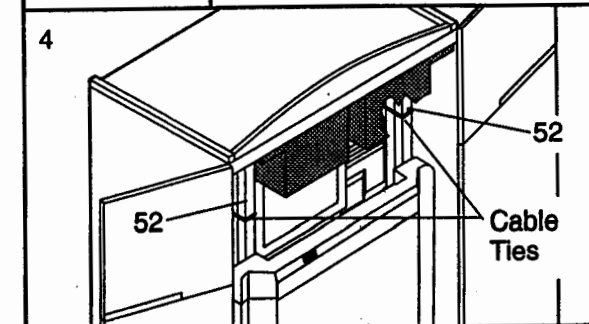

5. Open the Lower Doors (158). Using a crescent wrench, adjust the four Base Feet (147) so that the two indicated Base Feet are slightly higher than the other two Base Feet (147). This will cause the cabinet to lean back slightly. **Make sure that all four Base Feet (147) are firmly resting on the floor.**

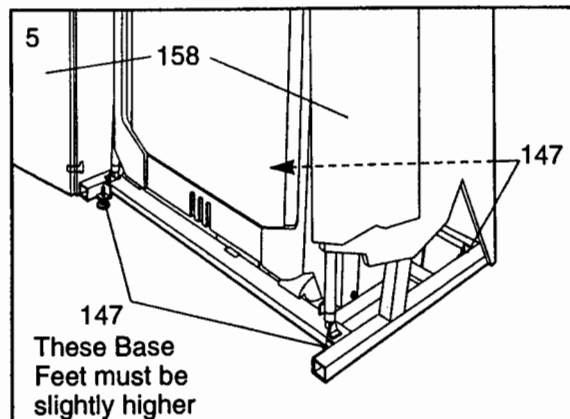

6. Attach three Stabilizer Pads (93) to the Stabilizer (162) in the indicated locations. Note: One extra Stabilizer Pad may be included.

Attach the Stabilizer (162) to the Base (75) with the four Screws (140).

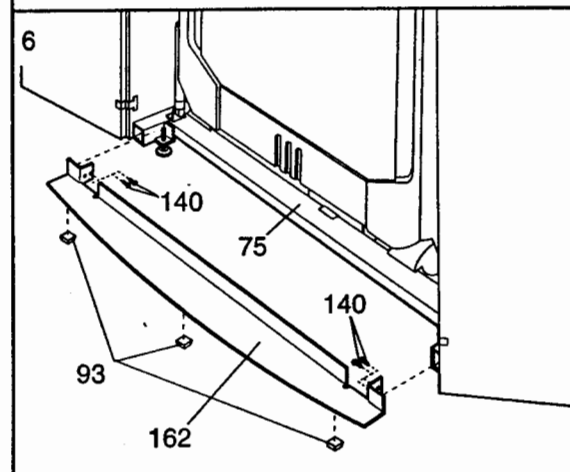

7. Each of the four cabinet doors is attached with two adjustable Hinge Plates (159). If the doors are not properly aligned, adjust them by turning the screws in the Hinge Plates.

To raise or lower a door slightly, loosen screw A in the Hinge Plates (159); to adjust a door forward or back, loosen screw B; to adjust a door from side to side, turn screw C.

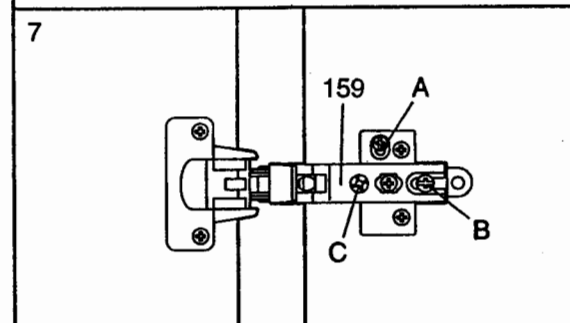

8. Hold the treadmill firmly with both hands as shown, and lower the treadmill to the floor. **Caution: You must be able to safely lift 45 pounds (20 kg) in order to raise or lower the treadmill. To avoid pinching your hands, do not hold the treadmill in the locations indicated by the arrows. To decrease the possibility of Injury, bend your legs and keep your back straight.**

Remove the indicated packing materials.

**To protect the floor or carpet from damage, place a mat under the treadmill.**

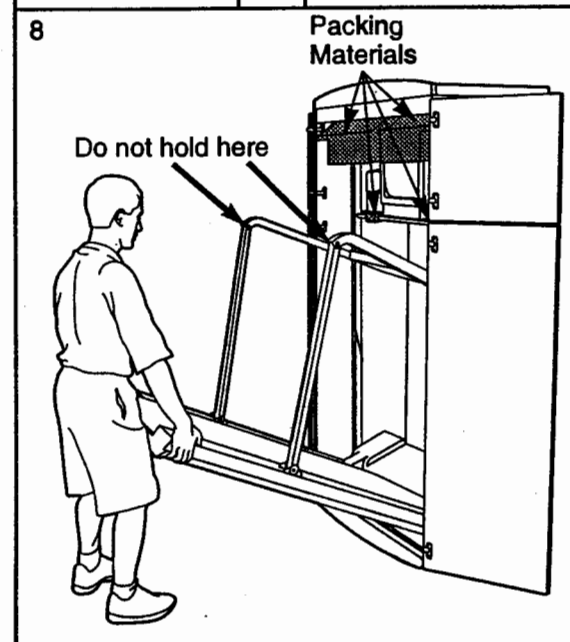

9. Insert two Shelf Pins (152) into the small holes in the Left Side Board (172), and two Shelf Pins into the small holes in the Right Side Board (not shown). Raise the Shelf Board (168) inside the cabinet and remove the indicated packing material and the plastic bag covering the television. Set the Shelf Board on the Shelf Pins.

Insert two Shelf Pins (152) into the lower holes in the Left Side Board (172), and two Shelf Pins into the lower holes in the Right Side Board (not shown). Carefully place the other Shelf Board (168) on the Shelf Pins.

**Make sure that the Shelf Board is level. Note: Objects placed on the Shelf Boards may shift and fall when the treadmill is in use. Never place objects on the lower Shelf Board when the treadmill is in use. The lower Shelf Board is designed for storing items when the treadmill is not in use.**

Find the Power Cord (60) located behind the Hood (53). Feed the end of the Power Cord out of the hole near the bottom of the cabinet.

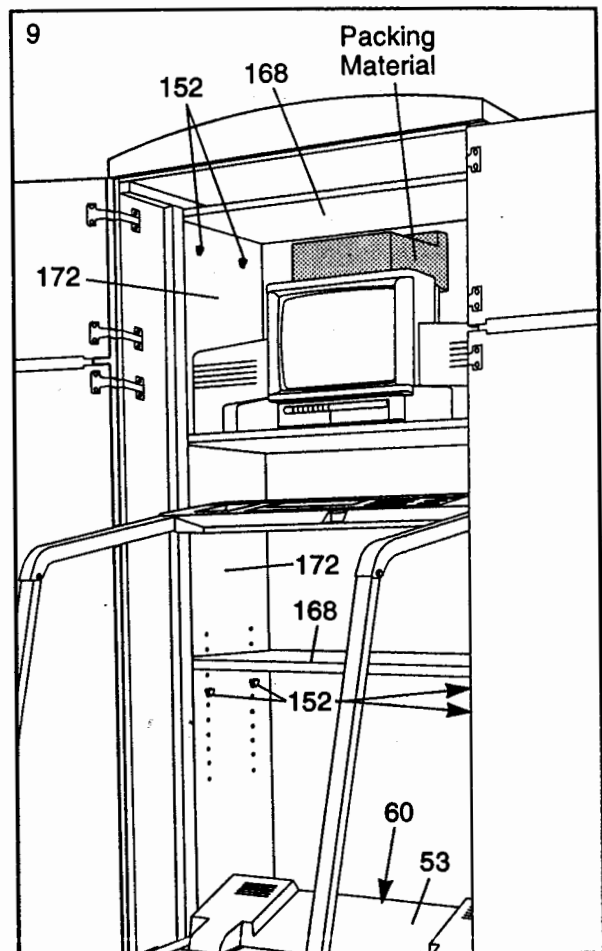

10. Remove the backing from the Adhesive Clip (79). Press the Adhesive Clip onto the Rear Roller Cover (71) in the indicated location. Press the Allen Wrench (78) into the Adhesive Clip.

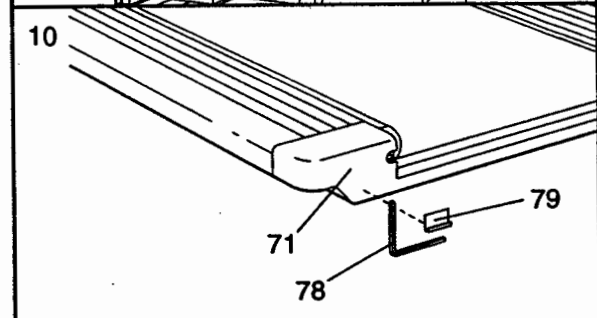

11. For the console and television to operate properly, an antenna, a CATV cable, or a VCR must be connected to the 75 ohm antenna terminal on the treadmill (see the drawing at the right).

**If you are using an antenna, it must be properly connected and adjusted for optimal reception. Refer to ANTENNA CONNECTIONS on page 18 to properly connect an antenna.**

**If you are using a CATV cable, refer to CATV CABLE CONNECTION on page 18 to properly connect the cable.**

**If you are using a VCR, refer to HOW TO CONNECT A VCR on page 23 to properly connect the VCR.**

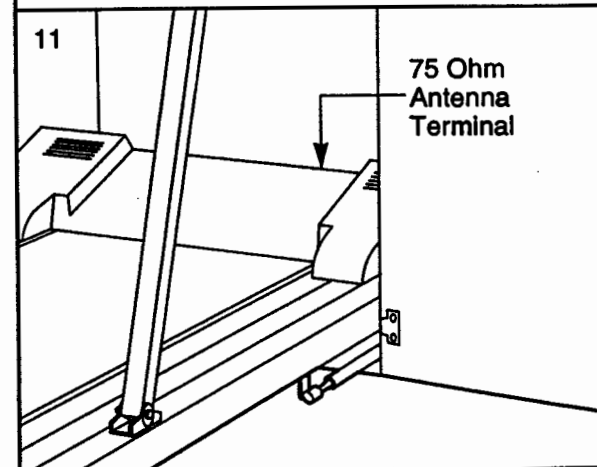

**Make sure that all parts of the treadmill are properly tightened. Read all instructions in this manual before operating the treadmill.**

# GROUNDING INSTRUCTIONS

## THE PERFORMANT LUBE™ WALKING BELT

Your treadmill features a walking belt coated with PERFORMANT LUBE™, a high-performance lubricant. **IMPORTANT: Never apply silicone spray or other substances to the walking belt or the walking platform; such substances will deteriorate the walking belt and cause excessive wear.**

## HOW TO PLUG IN THE POWER CORD

**⚠ DANGER:** Improper connection of the equipment-grounding conductor can result in an increased risk of electric shock. Check with a qualified electrician or serviceman if you are in doubt as to whether the product is properly grounded. Do not modify the plug provided with the product—if it will not fit the outlet, have a proper outlet installed by a qualified electrician.

Your treadmill, like any other type of sophisticated electronic equipment, can be seriously damaged by sudden voltage changes in your home's power. Voltage surges, spikes, and noise interference can result from weather conditions or from other appliances being turned on or off. **To decrease the possibility of your treadmill being damaged, always use a surge protector (not included) with your treadmill.**

Surge protectors are sold at most hardware stores and department stores. Use only a UL-listed surge protector, rated at 15 amps, with a 14-gauge cord of five feet or less in length.

**This product must be grounded.** If it should malfunction or break down, grounding provides a path of least resistance for electric current to reduce the risk of

electric shock. This product is equipped with a cord having an equipment-grounding conductor and a grounding plug. **Plug the power cord into a surge protector, and plug the surge protector into an appropriate outlet that is properly installed and grounded in accordance with all local codes and ordinances.**

This product is for use on a nominal 120-volt circuit, and has a grounding plug that looks like the plug illustrated in drawing 1 below. A temporary adapter that looks like the adapter illustrated in drawing 2 may be used to connect the surge protector to a 2-pole receptacle as shown in drawing 2 if a properly grounded outlet is not available.

The temporary adapter should be used only until a properly grounded outlet (drawing 1) can be installed by a qualified electrician.

The green-colored rigid ear, lug, or the like extending from the adapter must be connected to a permanent ground such as a properly grounded outlet box cover. Whenever the adapter is used it must be held in place by a metal screw. **Some 2-pole receptacle outlet box covers are not grounded. Contact a qualified electrician to determine if the outlet box cover is grounded before using an adapter.**

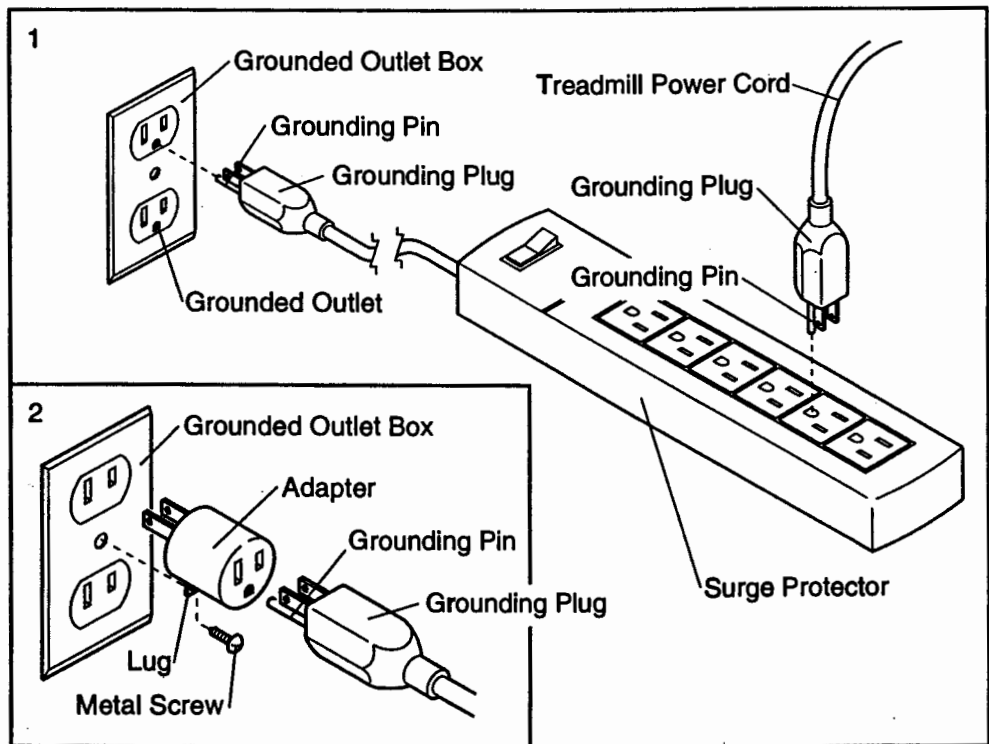

# CONSOLE OPERATION

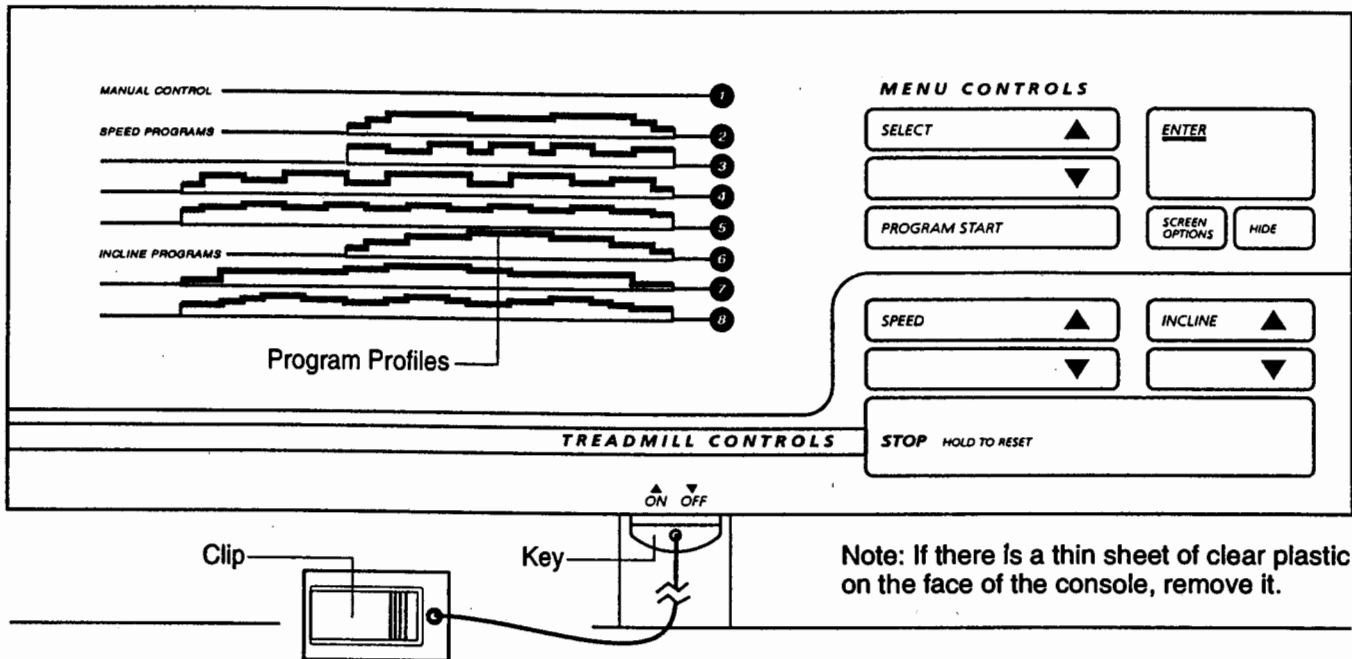

Note: If there is a thin sheet of clear plastic on the face of the console, remove it.

## CAUTION: Before operating the console, read the following precautions.

- Always wear the clip (see the drawing above) while operating the treadmill. If the key is pulled from the console, the walking belt will stop.
- Do not stand on the walking belt when turning on the power or starting the walking belt.
- The treadmill is capable of high speeds. Adjust the speed in small increments.
- To reduce the possibility of the treadmill overheating, do not operate the treadmill continuously for longer than one hour.
- Never leave the treadmill unattended while it is running. Move the on/off switch to the "off" position when the treadmill is not in use.
- To reduce the risk of electric shock, keep the console dry, avoid spilling liquids on the console, and use only a sealed water bottle. Remove the water bottle from the console before folding the treadmill for storage.
- Never place objects on the lower shelf when the treadmill is in use.

## FEATURES OF THE CONSOLE

The revolutionary ACCESS 3000 offers an impressive array of features designed to make your workouts more enjoyable and effective. When the console is in the manual mode, the speed and incline of the treadmill can be changed with a touch of a button. As you exercise, the integral color TV will show your favorite television programs while displaying instant exercise feedback—you can view the elapsed time, speed, distance, incline, and numbers of calories and fat calories burned. In addition, the console offers seven preset workout programs. Each program is designed to automatically control either the speed or the incline of the treadmill as it guides you through an effective workout.

Complete instructions for operating the color TV are found in the section beginning on page 17 of this manual. To operate the console with the TV, read the instructions on pages 12 to 16. **IMPORTANT: For the console and television to operate properly, an antenna, a CATV cable, or a VCR must be connected to the 75 ohm antenna terminal on the treadmill.**

If you are using an antenna, it must be properly connected and adjusted. Refer to ANTENNA CONNECTIONS on page 18 to properly connect an antenna.

If you are using a CATV cable, refer to CATV CABLE CONNECTION on page 18 to connect the cable.

If you are using a VCR, refer to HOW TO CONNECT A VCR on page 23 to properly connect the VCR.

## DIAGRAM OF THE CONSOLE

Please refer to the drawing at the top of page 11.

A. Program profiles—These profiles show how the speed or incline of the treadmill will change during the preset workout programs. During program 6, for example, the incline will gradually increase during the first half of the program, and then gradually decrease during the last half.

B. Key and clip—This key turns the console on and off. The attached clip is designed to be worn on your waistband. If the key is pulled from the console, the power will automatically turn off.

C. SELECT buttons—These buttons are used to select the manual mode and the seven preset workout programs. They are also used to set your weight, select a maximum speed setting for a speed program, and select a maximum incline setting for an incline program.

D. PROGRAM START button—This button is used to start preset workout programs.

E. ENTER button—This button is pressed after you enter your weight, or select the manual mode or one of the preset workout programs.

F. SCREEN OPTIONS button—This button is used to select the way that exercise feedback is shown on the TV. There are three different options:

Option 1—The bottom of the TV screen will show the elapsed time and the speed for seven seconds, the distance and the incline for seven seconds, and then the numbers of calories and fat calories burned for seven seconds (see page 28 for an explanation of fat calories). The cycle will then repeat. Note: If a preset program is selected, the speed or incline settings of the program will also be shown.

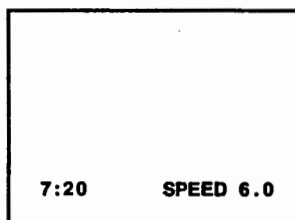

Option 2—The TV will simultaneously show the elapsed time, speed, incline, distance, and numbers of calories and fat calories burned.

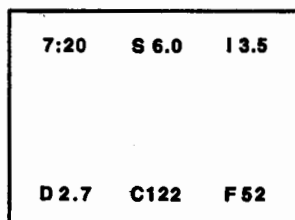

Option 3—The TV will show only the speed in the lower right corner. Note: If a speed program is selected, the speed will flash for five seconds each time the speed of the walking belt is about to change.

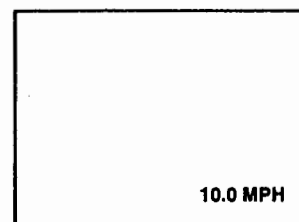

G. HIDE button—This button is used to select the way that the TV screen will appear when exercise feedback is shown. The three modes are described below.

Mode 1—The text will be displayed over a normal TV picture.

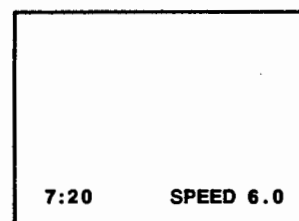

Mode 2—A horizontal black stripe will appear behind the text, making it easier to read the text if the TV picture is light.

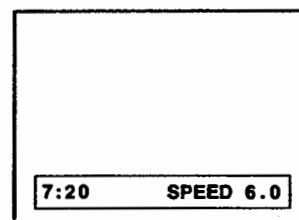

Mode 3—A black box will appear behind the text, covering the TV picture.

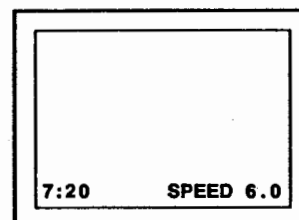

H. SPEED buttons—These buttons are used to control the speed of the walking belt. Each time one of the buttons is pressed, the speed will change by 0.1 mph. The buttons can be held down to change the speed quickly. The speed range of the walking belt is 0.5 mph to 10 mph.

I. INCLINE buttons—These buttons are used to control the incline of the treadmill. Each time one of the buttons is pressed, the incline will change by 0.5%. The buttons can be held down to change the incline quickly. The incline range is 1.5% to 10%.

J. STOP button—This button is used to stop the walking belt. If the button is pressed briefly, the values of the six feedback modes will be retained. If the button is held down for two seconds, the elapsed time, speed, distance, incline, and numbers of calories and fat calories will be reset to zero.

## HOW TO USE THE MANUAL MODE

Make sure that the on/off switch located near the power cord is in the "on" position. In addition, make sure that the power cord is properly plugged in (see page 10).

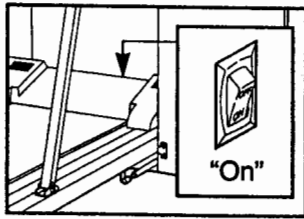

To turn on the TV, press the POWER button on the TV or the remote control.

Step onto the foot rails of the treadmill. Find the clip attached to the key, and slide the clip onto the waistband of your clothing. Follow the steps below to use the manual mode of the console.

### 1 Insert the key into the console.

Note: When you are familiar with the operation of the treadmill, you may go directly to step 4 after inserting the key. While learning to use the console, please read and follow all steps below.

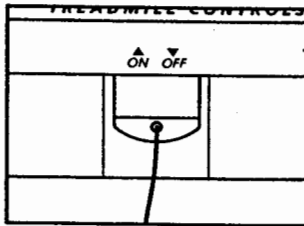

### 2 Enter your weight if desired.

A few seconds after the key is inserted, a message on the TV will prompt you to enter your weight. You do not have to enter your weight in order to use the console; however, the calorie and fat calorie feedback will be more accurate if you enter your weight.

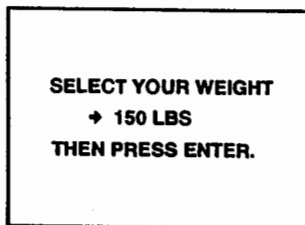

If you do not wish to enter your weight, press the ENTER button and go to step 3.

If you wish to enter your weight, press the SELECT buttons. Each time one of the buttons is pressed, the weight shown on the TV will change by 1 pound. The buttons can be held down to enter your weight quickly. When the correct weight is shown on the TV, press the ENTER button.

### 3 Select the manual mode.

A message on the TV will prompt you to select a program. To use the manual mode, the arrow on the TV should point to the number 1 (see the drawing at the right). If the arrow is pointing to a different number, press the SELECT buttons repeatedly until the arrow points to the number 1. Then press the ENTER button.

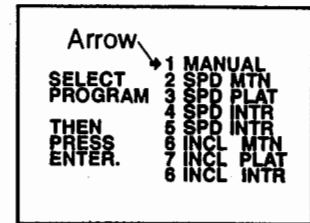

Note: To select a preset workout program, see HOW TO USE A PRESET PROGRAM on page 14.

### 4 Start the walking belt.

A message on the TV will prompt you to adjust the speed of the walking belt. The speed of the walking belt is controlled with the SPEED buttons. Each time one of the buttons is pressed, the speed will change by 0.1 mph. The buttons can be held down to change the speed quickly. The speed range of the walking belt is 0.5 to 10 mph.

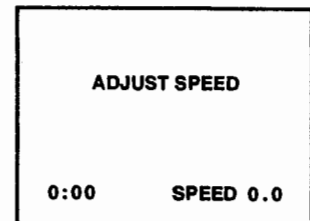

Press the SPEED increase button once. The walking belt will begin to move at 1.0 mph. Hold the handrails and begin walking. Change the speed of the walking belt as desired by pressing the SPEED buttons. Note: Any time that the SPEED buttons are pressed, the TV will show the speed setting for seven seconds.

To stop the walking belt, press the STOP button. The information shown on the TV will begin to flash. To restart the walking belt, press the SPEED buttons. Note: To stop the walking belt and reset the elapsed time, speed, distance, Incline, and numbers of calories and fat calories to zero, hold down the STOP button for two seconds.

### 5 Adjust the Incline if desired.

The incline of the treadmill is controlled with the INCLINE buttons. Each time one of the buttons is pressed, the incline will change by 0.5%. The buttons can be held down to change the incline quickly. The incline range is 1.5% to 10%. Note: After the buttons are pressed, it may take a few seconds for the treadmill to reach the selected incline setting. Any time that the INCLINE buttons are pressed, the TV will show the incline setting for seven seconds.

**6** Follow your progress with the exercise feedback shown on the TV.

As you exercise, the TV will display the elapsed time and the speed for seven seconds, the distance and the incline for seven seconds, and then the numbers of calories and fat calories burned for seven seconds. The cycle will then repeat.

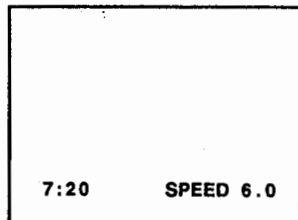

By pressing the SCREEN OPTIONS and HIDE buttons, you can modify the way that exercise feedback is shown on the TV. The different options are described on page 12 (see F and G).

**7** When you are finished exercising, stop the walking belt and remove the key.

Step onto the foot rails, stop the walking belt, and remove the key from the console.

**IMPORTANT:** The treadmill must be at the lowest incline level before it is folded for storage. If the treadmill is not at the lowest incline level when the key is removed, a message on the TV will prompt you to press the ENTER button to lower the treadmill.

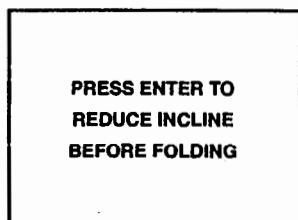

When the treadmill is at the lowest incline level, a message on the TV will verify that the treadmill is ready to be folded.

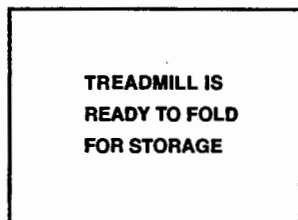

After removing the key, be sure to store it in a secure place. Move the on/off switch to the "off" position. (See the drawing near the top of page 13.)

To turn off the TV, press the POWER button on the TV or the remote control.

**HOW TO USE A PRESET WORKOUT PROGRAM**

Make sure that the on/off switch located near the power cord is in the "on" position. In addition, make sure that the power cord is properly plugged in (see page 10).

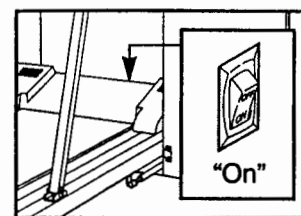

To turn on the TV, press the POWER button on the TV or the remote control.

Step onto the foot rails of the treadmill. Find the clip attached to the key, and slide the clip onto your waistband. Follow the steps below to use a preset workout program.

**1** Insert the key into the console.

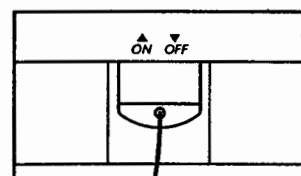

**2** Enter your weight if desired.

A few seconds after the key is inserted, a message on the TV will prompt you to enter your weight. You do not have to enter your weight in order to use the console; however, the calorie and fat calorie feedback will be more accurate if you enter your weight.

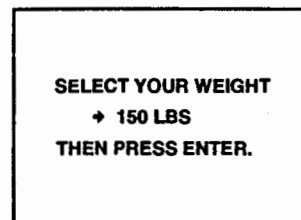

If you do not wish to enter your weight, press the ENTER button and go to step 3.

If you wish to enter your weight, press the SELECT buttons. Each time one of the buttons is pressed, the weight shown on the TV will change by 1 pound. The buttons can be held down to enter your weight quickly. When the correct weight is shown on the TV, press the ENTER button.

**3** Select a preset program.

A message on the TV will prompt you to select a program. Press the SELECT buttons repeatedly until the arrow points to the desired program. Then press the ENTER button.

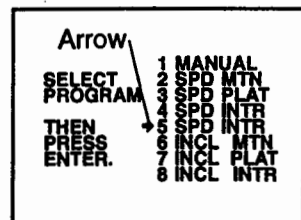

Programs 2, 3, 4, and 5 are speed programs—the console will automatically control the speed of the walking belt as you control the incline. Programs 6, 7, and 8 are incline programs—the console will control the incline of the treadmill as you control the speed. The profiles on the left side of the console show how the speed or incline will change during the programs. During program 6, for example, the incline will gradually increase during the first half of the program, and then gradually decrease during the last half. Programs 2, 3, and 6 are twenty-minute programs; programs 4, 5, 7, and 8 are thirty-minute programs.

#### 4 Select a maximum speed or Incline setting.

**If you selected a speed program** (programs 2, 3, 4, or 5), a message on the TV will prompt you to select the maximum speed that you want the walking belt to move during the program. Press the SELECT buttons to select a maximum speed setting. Each time one of the buttons is pressed, the setting will change by 0.5 mph. The setting must be between 2.5 mph and 10 mph.

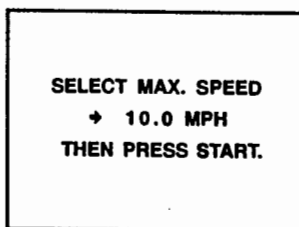

**If you selected an Incline program** (programs 6, 7, or 8), a message on the TV will prompt you to select the maximum incline that you want the treadmill to reach during the program. Press the SELECT buttons to select a maximum Incline setting. Each time one of the buttons is pressed, the setting will change by 0.5%. The setting must be between 6.5% and 10%.

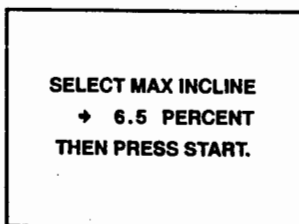

#### 5 Press the PROGRAM START button.

When the PROGRAM START button is pressed, a program profile will be shown on the TV for three seconds to show the speed or incline settings of the program you selected.

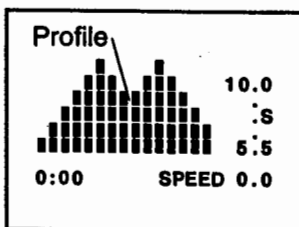

After three seconds, the TV will display the information shown at the right. The word "WARM" will flash to indicate that the warm-up period of the program has begun.

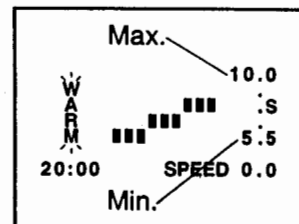

(Each program begins with a one-minute warm-up period, and ends with a one-minute cool-down period.) The white indicators to the right show upcoming speed or incline settings. The numbers at the right side of the TV show the maximum and minimum speed or incline settings of the program. The letter "S" or "I" shows whether a speed or incline program is selected.

A few seconds after the PROGRAM START button is pressed, the walking belt will begin to move. Hold the handrail and begin walking on the walking belt.

After the warm-up period is completed, the TV will display the information at the right. The flashing white indicator will show the current speed or incline setting. The

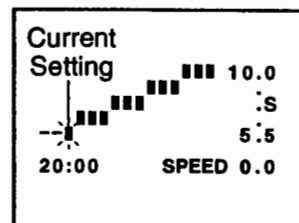

white indicators to the right show upcoming speed or incline settings. The dashes to the left show the most recent speed or incline settings. As the program progresses, the white indicators will move to the left and the speed or incline of the treadmill will automatically change as shown by the white indicators.

If a speed program is selected, the incline of the treadmill can be changed at any time during the program with the INCLINE buttons. If an incline program is selected, the speed of the walking belt can be changed at any time with the SPEED buttons.

During the last minute of the program, the word "cool" will flash on the TV to indicate that the cool-down period of the program is in progress. During the last ten seconds of the program, the incline of the treadmill will automatically decline to the lowest incline level. The walking belt will then slow to a stop and the program will be completed.

Note: If the program is too easy or too challenging, the maximum speed or incline setting can be adjusted by pressing the SPEED or INCLINE buttons. The new maximum and minimum settings will be shown on the TV. To pause the program, press the STOP button. The exercise feedback shown on the TV will begin to flash. When you are ready to restart the program, press the PROGRAM START button. To terminate the program before it is completed, hold down the STOP button for two seconds.

**6** Follow your progress during the program with the exercise feedback shown on the TV.

As you exercise, the TV will display the elapsed time and the speed for seven seconds, the distance and the incline for seven seconds, and then the numbers of calories and fat calories burned for seven seconds. The cycle will then repeat.

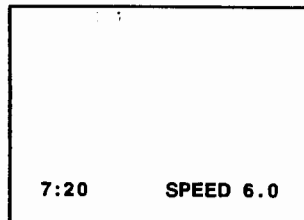

By pressing the SCREEN OPTIONS and HIDE buttons, you can modify the way that exercise feedback is shown on the TV. The different options are described on page 12 (see F and G). Note: The white indicators and other program information will be shown on the TV only when screen option 1 is selected.

**7** When you are finished exercising, stop the walking belt and remove the key.

Step onto the foot rails and remove the key from the console. A message on the TV will verify that the treadmill is ready to be folded.

After removing the key, be sure to store it in a secure place. Move the on/off switch to the "off" position. (See the drawing near the top of page 14.)

To turn off the TV, press the POWER button on the TV or the remote control.

**HOW TO SELECT THE INFORMATION MODE**

The console features an information mode that lets you modify the format of text displayed on the TV and shows the total time and distance accumulated on the treadmill.

To access the information mode, first make sure that the on/off switch located near the power cord is in the "on" position. In addition, make sure that the power cord is properly plugged in (see page 10).

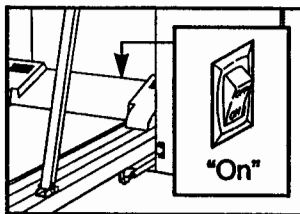

Press the POWER button on the TV or the remote control to turn the TV on.

Next, hold down the STOP button, insert the key into the console, and continue holding down the STOP button until the TV displays the information shown at the right. When single lines of text are displayed on the TV, the text can appear at either the bottom or the top of the screen. To change the position of the text, press the SELECT buttons. The words "BOTTOM LINE" or "TOP LINE" will show which setting is selected. To see more user information, press the ENTER button.

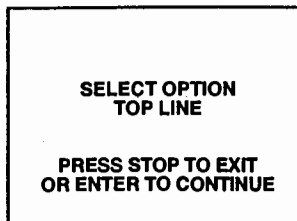

After the ENTER button is pressed, the TV will show the total number of hours that the treadmill has been used, and the total number of miles that the walking belt has moved. (Note: When the total number of hours exceeds 999, it will reset to zero; when the total number of miles exceeds 99,999, it will reset to zero.) To see more user information, press the ENTER button.

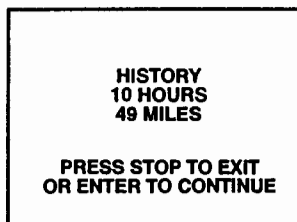

If the text displayed on the TV is too far to the right or left side of the screen, the text can be centered. To center the text, press the SELECT buttons while the message at the right appears on the TV.

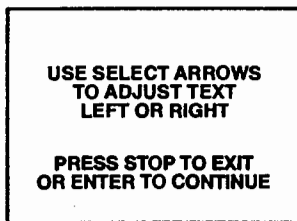

To exit the information mode at any time, press the STOP button.

# TELEVISION OPERATION

## FEATURES OF THE TELEVISION

- Blackstripe Picture Tube
- 181 cable ready channels (68 standard TV channels plus 113 cable channels)
- Full-featured on-screen display
- User-friendly menu-driven TV controls
- Video and audio input jacks
- Full-function 27-key infrared remote control
- Real time clock with 1 on-timer and 1 off-timer
- Sleep timer (10 to 120 minutes selectable)
- Earphone jack
- LED power indicator
- Built-in closed caption decoder for hearing impaired
- Auto memory and auto search for TV channel
- Automatically skips unavailable channels in your area

Note: If desired, the TV can be viewed without the treadmill being used. Make sure that the on/off switch located near the power cord is in the "on" position. (See the drawing near the top of page 14.)

## DIAGRAM OF THE TELEVISION

1. Infrared Remote Sensor
2. Power Indicator
3. Power On/Stand-by Button
4. Channel  $\Delta/\nabla$  Buttons
5. Volume +/- Buttons
6. Compartment Door\*
7. TV/CATV Button
8. TV/AV Button
9. Pop-up Menu Button
10. Earphone Jack

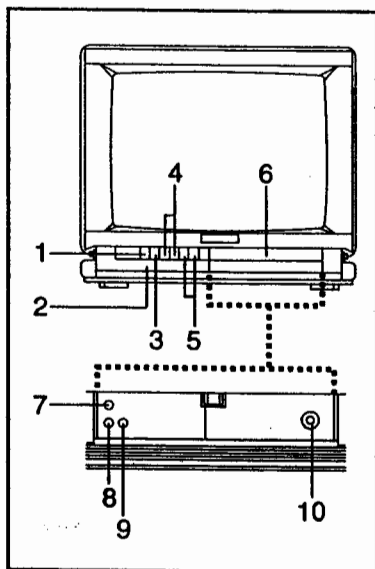

**\*IMPORTANT:** The treadmill and TV, like a computer or other electronic equipment, can be damaged by static electricity. Before touching any of the controls behind the compartment door, touch one of the treadmill handrails to discharge static electricity.

## DIAGRAM OF THE REMOTE CONTROL

1. TV/CATV Channel Selection Buttons—Used to select a channel by keying in the channel number.
2. TV/CATV Select Button—Used to toggle between TV and cable TV channels.
3. TV/AV Select Button—Used to select between TV and video input.

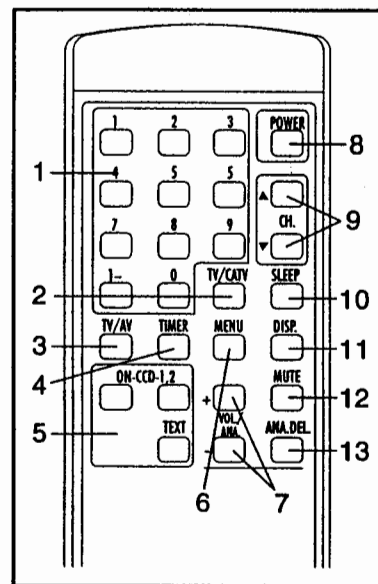

4. TIMER Select Button—Used to adjust menu-driven real time clock, on timer, and off timer. Used together with +/- buttons.
5. Closed Caption Select Buttons—Used to select CCD On/Off, C1, C2, and CCD Text.
6. Pop-up MENU Button—Used to select channel memory timer and analog select menu.
7. VOLUME +/- Buttons—Used to adjust the volume level and picture levels.
8. POWER Button—Used to turn the TV on and off.
9. CHANNEL  $\Delta/\nabla$  Buttons—Used to step through favorite channels from the memory of the TV.
10. SLEEP Timer Button—Press once to display the sleep time. Press again to change and activate the sleep timer.
11. Channel/Time DISPLAY Button—Used to display the current channel number and time on the screen.
12. MUTE Button—Press once to turn off the volume. Press again to restore the volume.
13. ANALOG SELECT Button—Used to select which picture level (contrast, brightness, color, or tint) you want to adjust. Used together with the +/- buttons.

## ANTENNA CONNECTIONS

### Indoor Antenna

1. Place the VHF antenna in the desired location. Connect the 300 ohm flat wire to the screws on the 300 ohm to 75 ohm adapter.

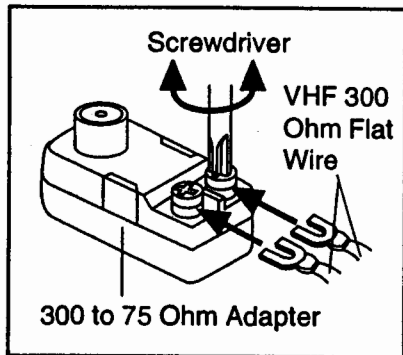

2. Connect the 300 to 75 ohm adapter to the 75 ohm antenna terminal on the treadmill. (See assembly drawing 11 on page 9 for the location of the terminal.)

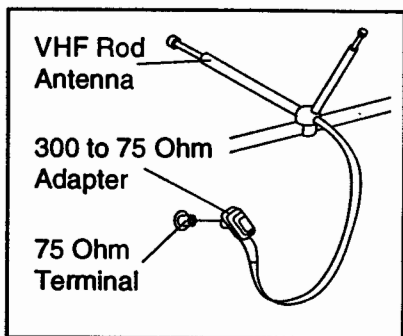

### Outdoor Antenna

Outdoor antennas are subject to weathering that can reduce signal quality. Inspect the antenna and lead-in wiring before connecting the antenna. Any service center can explain the various outdoor antennas available.

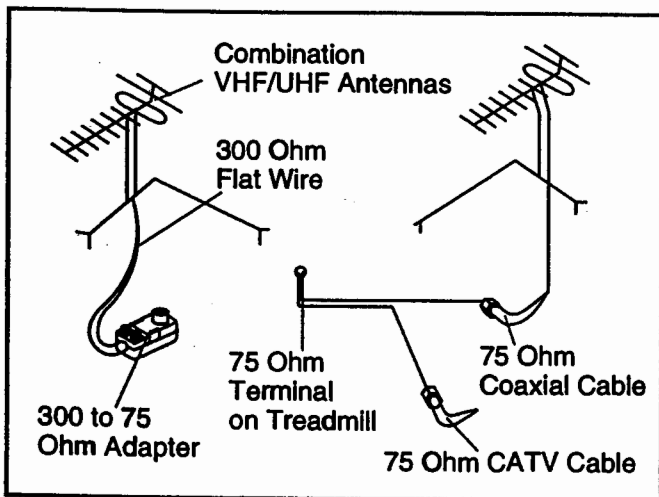

- 300 Ohm Flat Wire

1. Refer to the drawing above. Connect the 300 ohm flat wire to the 300 ohm to 75 ohm adapter.

2. Push the end of the 300 ohm to 75 ohm adapter into the 75 ohm antenna terminal on the treadmill. (See assembly drawing 11 on page 9 for the location of the terminal.)

- 75 Ohm Coaxial Cable

Refer to the drawing in the lower left corner of this page. Connect the 75 ohm coaxial cable directly to the 75 ohm antenna terminal. (See assembly drawing 11 on page 9 for the location of the terminal.)

## CATV CABLE CONNECTION

1. Remove the VHF 300 to 75 ohm adapter or the VHF cable from the antenna terminal.

2. Connect the CATV cable (75 ohm coaxial cable) to the 75 ohm antenna terminal on the treadmill. (See assembly drawing 11 on page 9 for the location of the terminal.)

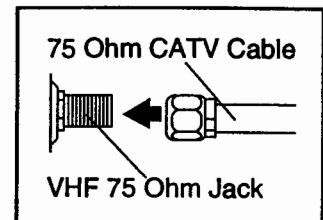

## BASIC TV OPERATION

Read the important precautions on pages 3 to 5 of this manual. Before operating the TV, make sure that the on/off switch located near the power cord is in the "on" position, and that the power cord is properly plugged in (see page 10).

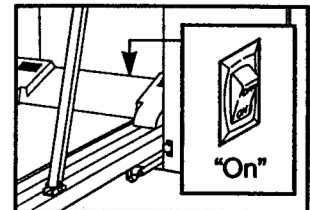

### Battery Installation

Before the remote control can be operated, two "AAA" batteries (included) must be installed. Slide the battery cover off the back of the remote control. Press two batteries into the remote control. Make sure that the batteries are turned as shown.

Reattach the battery cover.

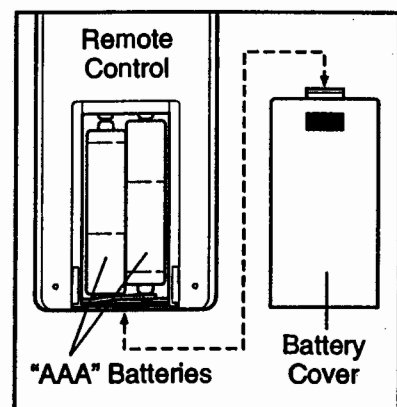

## Turning on the Power

To turn on the TV, press the POWER button on the TV or the remote control.

## Volume Control

To adjust the volume to the desired level, press the VOLUME + or - button.

The sound level will be shown by a bar on the TV screen. As the sound level is increased, the bar will move to the right. As the sound level is decreased, the bar will move to the left.

Note: If no broadcasting signal is received, the sound will be muted and the volume control will be disabled.

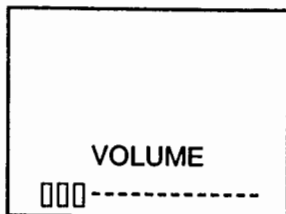

## Direct Channel Selection (by Remote Control)

Use the channel selection buttons on the remote control to select a channel number. The channel number will appear on the upper right corner of the TV screen. For channels 2 through 9, press the 0 button and then press the desired channel number (if the 0 button is not pressed first, channel selection will be delayed for 3 seconds).

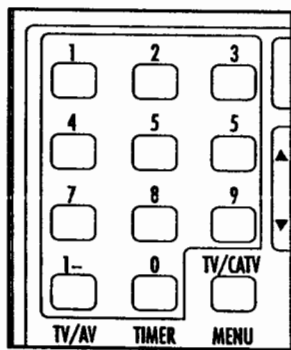

For channels 10 through 99, press the two digits in order. Be sure to press the second digit within 3 seconds after pressing the first. For CATV channels over 100, press the 1-- button first and then press the desired channel numbers.

## Skip Mode

Press the CHANNEL  $\Delta$  or  $\nabla$  button to select memorized channels, skipping over empty channels. Hold down the CHANNEL  $\Delta$  or  $\nabla$  button to change channels continuously. Note: If no channels are memorized, the TV will switch to the SEARCH mode.

## Search Mode

Press the CHANNEL  $\Delta$  or  $\nabla$  button to search for the next available channel. Hold down the CHANNEL  $\Delta$  or  $\nabla$  button to search through all available channels.

Note: Before selecting channels with the CHANNEL  $\Delta$  or  $\nabla$  button, the channels must be set into the TV's memory. See MEMORIZING CHANNELS at the right.

## CHANNEL PROGRAMMING

### Memorizing Channels

The TV is equipped with a channel memorizing function that allows you to step up or down from the current channel to the next channel set into memory. Before channels can be selected in this way, they must be set into the TV's memory. Note: When programming channels, if no buttons are pressed for four seconds, the TV will return to the normal screen.

### Automatic Memory Tuning

1. Press the MENU button to turn on the pop up menu in the TV mode or CATV mode. Press the MENU button again to select CH MEMORY (channel memory).

▷ CH MEMORY  
ANALOG  
CLOCK/TIMER

2. Press the MENU button again to select AUTO MEMORY.

▷ AUTO MEMORY  
SEARCH/SKIP  
MEMORY ADD  
•ERASE  
TV/CATV

3. Press the + button to start AUTO MEMORY. The TV will begin setting into memory all the channels available in your area. When no broadcast signal is detected on a channel, the channel is erased from memory. When a signal is detected, the channel is stored in memory and the next channel is selected.

TV 07

AUTO MEMORY  
START [+]

This process will be repeated until the highest channel is reached. It then stops at the lowest channel stored in memory, and returns to a normal screen after four seconds. The TV will then be in the SKIP mode.

TV 07

AUTO MEMORY  
END

## Erasing Channels

After all channels available in your area have been set into memory, you can erase unwanted channels by following the steps below:

1. Select the unwanted channel by using the CHANNEL  $\Delta$  or  $\nabla$  button or the channel selection buttons.

2. Press the MENU button to turn on the pop up menu. Press the MENU button again to select CH MEMORY.

```

▶ CH MEMORY
  ANALOG
  CLOCK/TIMER
    
```

3. Press the + or - button to move the arrow to MEMORY ADD•ERASE. Select MEMORY ADD•ERASE by pressing the MENU button.

```

  AUTO MEMORY
  SEARCH/SKIP
▶ MEMORY ADD
  •ERASE
  TV/CATV
    
```

4. Press the - button to erase the stored channel from memory. The channel number will change from green to red.

```

TV                07
CHANNEL MEMORY
END              ERASE
[+]             [-]
    
```

## Adding Channels

Channels that are not in memory can be stored manually. To manually store a channel, follow the steps above, but press the + button when MEMORY ADD•ERASE is selected. The channel will be stored in memory, and the channel number will change from red to green.

## Manually Searching for and Storing Channels

1. Press the MENU button to turn on the pop up menu. Press the MENU button again to select CH MEMORY.

```

▶ CH MEMORY
  ANALOG
  CLOCK/TIMER
    
```

2. Press the + or - button to move the arrow to SEARCH/SKIP. Select SEARCH/SKIP by pressing the MENU button.

```

  AUTO MEMORY
▶ SEARCH/SKIP
  MEMORY ADD
  •ERASE
  TV/CATV
    
```

3. Press the - button to select the SEARCH mode. The TV will return to the normal screen after four seconds.

```

CHANNEL UP/DOWN
SKIP      :      [+]
SEARCH   :      [-]
    
```

4. Press the CHANNEL  $\Delta$  or  $\nabla$  button to start searching. It will stop whenever an available channel is found.

5. If you do not want to store the channel in memory, press the CHANNEL  $\Delta$  or  $\nabla$  button again. To store the channel in memory, refer to ADDING CHANNELS at the left.

6. Until all desired channels have been stored, return to SEARCH/SKIP as described above and press the + button to return to the SKIP mode.

## CABLE TV (CATV) OPERATION

In addition to normal broadcast reception, the TV is equipped to receive up to 125 cable channels (113 plus 12 TV channels). To use the TV with a cable TV system, following the steps below.

1. Press the MENU button to turn on the pop up menu. Press the MENU button again to select CH MEMORY.

▷ CH MEMORY  
ANALOG  
CLOCK/TIMER

2. Press the + or – button to move the arrow to TV/CATV. Select TV/CATV by pressing the MENU button.

AUTO MEMORY  
SEARCH/SKIP  
MEMORY ADD  
•ERASE  
▷ TV/CATV

3. Press the MENU button to cycle through the four channel modes: (1) TV; (2) STD (Standard) for cable TV mode; (3) HRC (Harmonic Related Carrier) for cable TV subscriber; (4) IRC (Incremental Related Carrier) for cable TV subscriber.

TV 07

Once the appropriate cable TV mode is selected, the screen will return to normal after two seconds. Note: Consult your cable company if you are not sure which system you are using, or try different systems to obtain the maximum number of channels.

To toggle between the TV mode and the cable TV mode, press the TV/CATV button on the TV or the remote control.

To memorize cable TV channels, refer to CHANNEL PROGRAMMING on pages 19 and 20.

### CATV Channel Reference Table

Use the table below to find which CATV channel your TV is displaying. The top row (in **bold**) represents the channel number shown on the TV screen; the bottom row represents the corresponding CATV channel.

<b>1, 2 . . . . 6 . . . . 13, 14 . . . . 26 . . . . 36, 37 . . . . 50 . . . . 65,</b> 5A, 2 . . . . 6 . . . . 13, A . . . . M . . . . W, W+1 . . W+14 . . W+29,
66 . . . . 75 . . . . 86 . . . . 94, 95 . . . . 99, 100 . . . . 112 . . . . 125 W+30 . . W+39 . . W+50 . . W+58, A-5 . . A-1, W+59 . . W+71 . . W+84

## PICTURE LEVEL ADJUSTMENTS

Picture level controls are preset to nominal levels. If desired, you can individually adjust the contrast, brightness, color, or tint by following the steps below.

1. Press the ANALOG SELECT button repeatedly to select the attribute that you want to adjust: contrast, brightness, color, or tint.

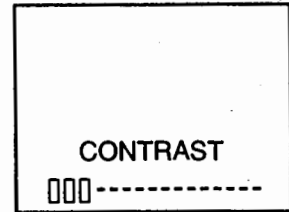

2. Press the + or – button to adjust the level. Note: If four seconds elapse without a button being pressed, the display will return to the normal screen.

## SELECTING VIDEO INPUT

Press the TV/AV button on the TV or the remote control to toggle between TV and VIDEO input.

## USING AUDIO MUTE

The volume of the TV can be momentarily muted, if desired, for a reason such as a telephone call. To mute the volume, press the MUTE button. A bar on the TV screen will indicate that the volume is at the minimum level. To return the volume to the previous level, press the MUTE button again or press the VOLUME + or – button.

## USING THE SLEEP TIMER

To set the TV to turn off after a preset amount of time, press the SLEEP button on the remote control. Each time the button is pressed, the clock will count down by 10 minutes: 120, 110, 100, . . . 20, 10, 0.

```
SLEEP 120
```

To cancel the sleep timer, press the SLEEP button repeatedly until the clock counts down to 0.

## USING THE RECORDING TIMER

Your TV has the capability to turn on, switch to a channel for recording, and then turn off again—all automatically. Follow the instructions below to use this feature. Note: When setting the clock, the on timer, or the off timer, if no buttons are pressed for four seconds, the TV will return to the normal screen.

### Setting the Clock

1. Press the TIMER button to turn on the setting menu.

```
▷ CLOCK AM 12:00
ON TIME
AM 12:00 OFF
ON CH 02 TV
OFF TIME
AM 12:00 OFF
```

2. Press the + or – button to set the clock to the correct time.

### Setting the On Timer

1. After the clock has been set, press the TIMER button repeatedly to select ON TIME.

```
CLOCK AM 12:00
▷ ON TIME
AM 12:00 OFF
ON CH 02 TV
OFF TIME
AM 12:00 OFF
```

2. Press the + or – button to set the time that you want the TV to turn on.

## Setting the Channel to be Recorded

1. After the on timer has been set, press the TIMER button repeatedly to select ON CH (on channel).

```
CLOCK AM 12:00
ON TIME
AM 12:00 OFF
▷ ON CH 02 TV
OFF TIME
AM 12:00 OFF
```

2. Press the + button to cycle through the channels until the desired channel is selected.
3. Press the – button to cycle through the four channel modes: (1) TV, (2) STD, (3) HRC, (4) IRC.

After the channel has been set, press the TIMER button repeatedly to select the on/off setting mode of the on timer. Pressing the + or – button at this point will change the display to “ON,” reset the seconds of the on timer, and start the count.

### Setting the Off Timer

1. After a channel has been set, press the TIMER button repeatedly to select OFF TIME.

```
CLOCK AM 12:00
ON TIME
AM 12:00 OFF
ON CH 02 TV
▷ OFF TIME
AM 12:00 OFF
```

2. Press the + or – button to set the time that you want the TV to turn off.

After the channel has been set, pressing the TIMER button will select the on/off setting mode of the off timer. Pressing the + or – button at this point will change the display to “ON,” reset the seconds of the off timer, and start the count.

## VIEWING THE CHANNEL NUMBER AND TIME

Pressing the DISPLAY button on the remote control makes it possible to display either the channel number or the AV mode and time. Displays activated by the DISPLAY button remain until the DISPLAY button is pressed a second time, or until the power is turned off.

Note: If the closed caption decoder is active, the display of the channel number and time will appear on the screen for only three seconds.

## USING THE CLOSED CAPTION DECODER (CCD)

To turn the CCD on or off, press the CCD ON button. When the CCD is on, the TV screen will appear as shown below.

### 1. With CCD broadcast

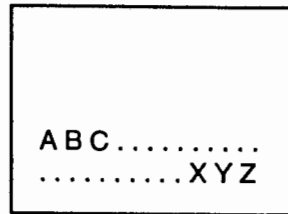

### 2. Without CCD broadcast caption mode on, text off

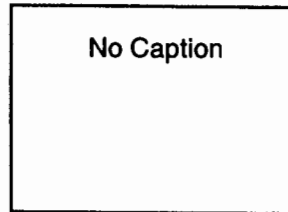

### 3. Push CCD buttons, CCD

Note: In the cases shown above, the display is for CCD caption mode on, text mode off.

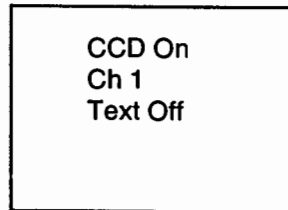

## Selecting the Data Channel

When the CCD function is on, the data channel is selected by pressing the CCD-1, 2 button. The CCD function status will be displayed for four seconds.

## Using the Text Display Function

The text function can be toggled on or off by pressing the CCD TEXT button. When the text function is on but no text data is received, the TV screen will appear as shown in drawing 2 above. The data channel can be selected while in the text mode, just as when in the caption mode.

## USING THE MENU FUNCTION

When the menu is used, pressing the MENU button will display a menu that allows selection of channel memory, the clock, the on timer, the off timer, or picture level controls. When the MENU button is pressed, the display will be as shown below.

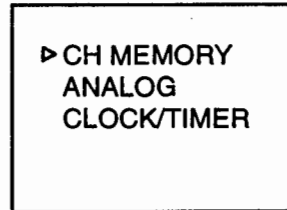

TV Mode

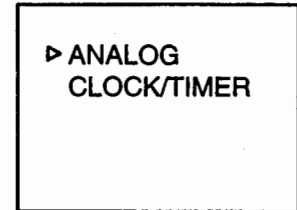

Video Mode

## HOW TO CONNECT A VCR

Follow the steps below to connect your VCR (not included) to the treadmill. A CATV cable (75 ohm coaxial cable) at least nine feet long is required.

1. Before placing your VCR on the shelf of the cabinet, connect one end of the CATV cable to the video output jack on the VCR.
2. Place the VCR on the shelf of the cabinet. Feed the power cord of the VCR and the end of the CATV cable out of the hole in the back of the cabinet.
3. Plug in the power cord of the VCR. Refer to your VCR user's manual for proper grounding instructions.
4. Feed the end of the CATV cable into the hole near the bottom of the cabinet. Connect the CATV cable to the 75 ohm antenna terminal on the treadmill. The terminal is located on the front of the motor hood next to the power cord.

To operate the VCR with the TV, make sure that the on/off switch located near the power cord is in the "on" position, and that the power cord is properly plugged in (see page 10).

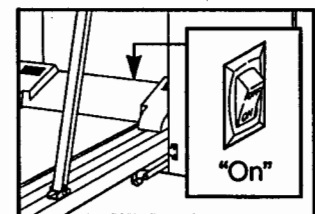

To turn on the TV, press the POWER button on the TV or the remote control. Make sure that the TV is on channel 3 or 4. Note: When the treadmill is not in use, you may want to leave the surge protector plugged in. Each time the power cord is unplugged, the TV must go through an automatic channel resetting routine when the power is turned on again.

# HOW TO FOLD THE TREADMILL

Before folding the treadmill, adjust the incline to the lowest position. If the incline is not at the lowest position, the treadmill will be permanently damaged. Next, unplug the power cord.

Hold the treadmill firmly with both hands as shown at the right. **Caution: You must be able to safely lift 45 pounds (20 kg) in order to raise or lower the treadmill.** To avoid pinching your hands, do not hold the treadmill in the locations indicated by the arrows. To decrease the possibility of injury, bend your legs and keep your back straight. As you raise the treadmill, make sure to lift with your legs rather than your back. Raise the treadmill to the vertical position. Close the cabinet doors.

To protect the floor or carpet from damage, place a mat under the treadmill. Keep the treadmill out of direct sunlight. Do not leave the treadmill in the storage position in temperatures above 85° Fahrenheit.

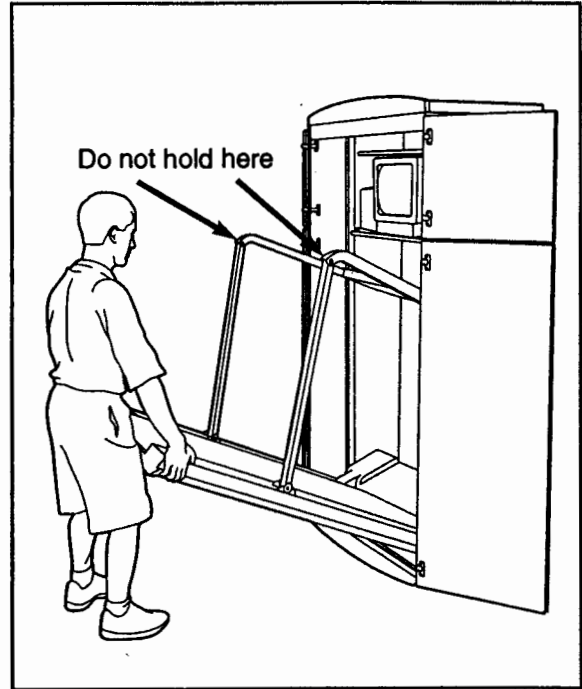

# TROUBLE-SHOOTING

Most treadmill problems can be solved by following the steps below. Find the symptom that applies, and follow the steps listed. If further assistance is needed, please call our Customer Service Department toll-free at 1-800-999-3756, Monday through Friday, 6 a.m. until 6 p.m. Mountain Time (excluding holidays).

## 1. SYMPTOM: THE POWER DOES NOT TURN ON

- Make sure that the power cord is plugged into a surge protector, and that the surge protector is plugged into a properly grounded outlet. (See HOW TO PLUG IN THE POWER CORD on page 10.) Use only a UL-listed surge protector, rated at 15 amps, with a 14-gauge cord of five feet or less in length.
- After the power cord has been plugged in, make sure that the key is fully inserted into the console. (See step 1 on page 13.)
- Check the circuit breaker located on the treadmill near the power cord. If the switch protrudes as shown, the circuit breaker has tripped. To reset the circuit breaker, wait for five minutes and then press the switch back in.
- Check the on/off switch located at the front of the treadmill near the power cord. The switch must be in the "on" position.

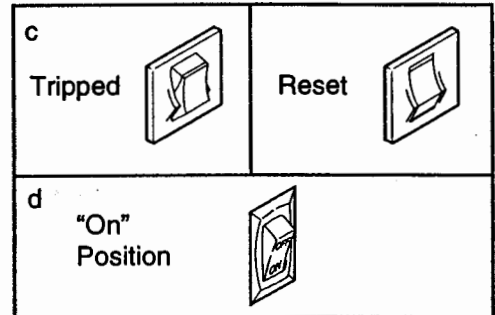

## 2. SYMPTOM: THE POWER TURNS OFF DURING USE

- Check the circuit breaker located on the treadmill frame near the power cord (see 1. c. above). If the circuit breaker has tripped, wait for five minutes and then press the switch back in.
- Make sure that the power cord is plugged in.
- Remove the key from the console. Reinsert the key fully into the console. (See step 1 on page 13.)
- Check to make sure that the on/off switch is in the "on" position. (See 1. d. above.)
- If the treadmill still will not run, please call our Customer Service Department, toll-free.

## 3. SYMPTOM: THE REMOTE CONTROL DOESN'T FUNCTION PROPERLY

- If the remote control doesn't function properly, the batteries should be replaced. Slide the battery cover off the back of the remote control. Press two "AAA" batteries into the remote control. **Make sure that the batteries are turned as shown.** Reattach the battery cover.

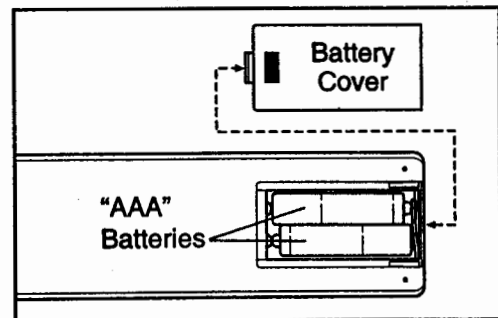

## 4. SYMPTOM: THE WALKING BELT SLOWS WHEN WALKED ON

- Use only a UL-listed surge protector, rated at 15 amps, with a 14-gauge cord of five feet or less in length.
- If the walking belt still slows when walked on, please call our Customer Service Department, toll-free.

## 5. SYMPTOM: THE WALKING BELT IS OFF-CENTER WHEN WALKED ON

- a. If the walking belt has shifted to the left, first remove the key and **UNPLUG THE POWER CORD**. Using the allen wrench, turn the left rear roller adjustment bolt clockwise 1/4 of a turn. Plug in the power cord, insert the key and run the treadmill for a few minutes. Repeat until the walking belt is centered.

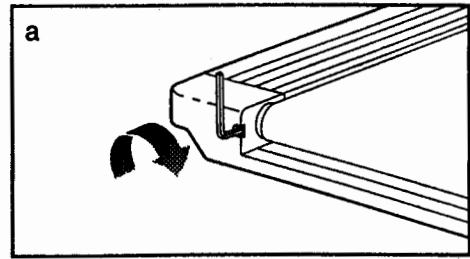

- b. If the walking belt has shifted to the right, first remove the key and **UNPLUG THE POWER CORD**. Using the allen wrench, turn the left rear roller adjustment bolt counterclockwise 1/4 of a turn. Plug in the power cord, insert the key and run the treadmill for a few minutes. Repeat until the walking belt is centered.

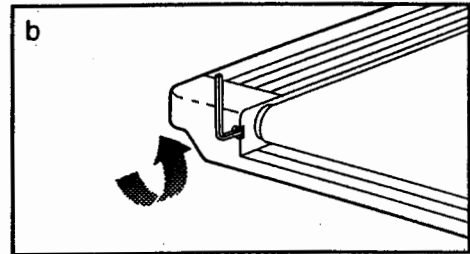

## 6. SYMPTOM: THE CABINET DOORS ARE NOT PROPERLY ALIGNED

- a. Each of the four cabinet doors is attached with two adjustable Hinge Plates (159). If the doors are not properly aligned, adjust them by turning the screws in the Hinge Plates. To raise or lower a door slightly, loosen screw A in the Hinge Plates; to adjust a door forward or back, loosen screw B; to adjust a door from side to side, turn screw C.

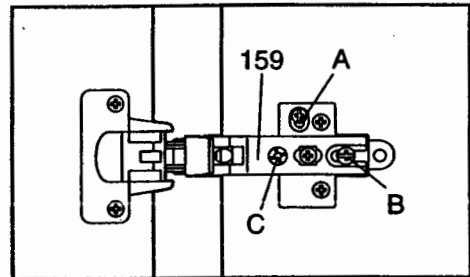

## 7. SYMPTOM: TV RECEPTION IS POOR

- a. Antenna—For the console and television to operate properly, good reception is necessary. If you are using an antenna, make sure that it is properly connected and that it is adjusted for optimal reception. (See **ANTENNA CONNECTIONS** on page 18.) In addition, refer to the information below.
- b. Ignition—Black spots or horizontal streaks appear or the picture may flutter or drift. Usually this is caused by interference from automobile ignition systems, neon lamps, electric drifts, or other electric appliances. Changing the position of the treadmill or other electric appliances may correct the problem.
- c. Ghosts—Ghosts are caused by the television signal following two paths—one is the direct path and the other is reflected from tall buildings, hills, or other objects. Changing the direction or position of the antenna may improve reception.
- d. Snow—If the TV is located in the fringe area of a television station where the signal is weak, the picture may be marred by the appearance of small dots. When the signal is weak, it may be necessary to install an external antenna to improve the picture.
- e. Radio Frequency interference—This interference produces moving ripples or diagonal streaks and in some cases causes loss of contrast in the picture.
- f. Picture Size Variation—A slight picture size variation is normal when you adjust the **CONTRAST** or **BRIGHTNESS** control.

Note: If one of these symptoms appears when the cable from a CATV company is connected, the symptom may be caused by the local company broadcast.

## 8. SYMPTOM: AN ERROR CODE APPEARS ON THE TV SCREEN

a. Error code "ERROR 2" may appear on the TV if the SPEED increase button or the PROGRAM START button is pressed and no movement of the walking belt is detected within seven seconds. Remove the key from the console, wait for ten seconds, and then reinsert the key. Make sure that you stand on the foot rails of the treadmill each time you start the walking belt. If the error code appears again, call our toll-free Customer Service Department. Do not operate the treadmill until the problem is corrected.

ERROR 2:  
NO SPEED SIGNAL  
CHECK USER MANUAL

b. Error code "ERROR 3" may appear on the TV if the speed of the walking belt surges above the selected speed setting. Remove the key from the console, wait for ten seconds, and then reinsert the key. If the error code appears again, call our toll-free Customer Service Department. Do not operate the treadmill until the problem is corrected.

ERROR 3:  
OVERSPEED  
CHECK USER MANUAL

c. Error code "ERROR 4" may appear on the TV if the speed of the walking belt remains below 1.0 mph when a higher speed setting is selected. Remove the key from the console, wait for ten seconds, and then reinsert the key. If you weigh over 200 pounds, it may be helpful to increase the incline of the treadmill. If the error code appears again, call our toll-free Customer Service Department. Do not operate the treadmill until the problem is corrected.

ERROR 4:  
LOW SPEED HIGH PWM  
CHECK USER MANUAL

d. Error code "ERROR 6" may appear on the TV when the console is first turned on. Remove the key from the console, unplug the power cord, and wait for thirty seconds. Plug in the power cord and reinsert the key. If the error code appears again, call our toll-free Customer Service Department. Do not operate the treadmill until the problem is corrected.

ERROR 6:  
CHECKSUM  
CHECK USER MANUAL

e. Error code "ERROR 7" may appear on the TV when the console is first turned on. Remove the key from the console, unplug the power cord, and wait for thirty seconds. Plug in the power cord and reinsert the key. If the error code appears again, call our toll-free Customer Service Department. Do not operate the treadmill until the problem is corrected.

ERROR 7:  
RAMTEST  
CHECK USER MANUAL

# CONDITIONING GUIDELINES

**⚠ WARNING:** Before beginning this or any exercise program, consult your physician. This is especially important for individuals over the age of 35 or individuals with pre-existing health problems.

The following guidelines will help you to plan your exercise program. Remember that proper nutrition and adequate rest are essential for successful results.

## EXERCISE INTENSITY

Whether your goal is to burn fat or to strengthen your cardiovascular system, the key to achieving the desired results is to exercise with the proper intensity. The proper intensity level can be found by using your heart rate as a guide. For effective exercise, your heart rate should be maintained at a level between 70% and 85% of your maximum heart rate as you exercise. This is known as your training zone. You can find your training zone in the table below. Training zones are listed according to age and physical condition.

Age	Training Zone (Beats/Min.)	
	Unconditioned	Conditioned
20	138-167	133-162
25	136-166	132-160
30	135-164	130-158
35	134-162	129-156
40	132-161	127-155
45	131-159	125-153
50	129-156	124-150
55	127-155	122-149
60	126-153	121-147
65	125-151	119-145
70	123-150	118-144
75	122-147	117-142
80	120-146	115-140
85	118-144	114-139

## Burning Fat

To burn fat, you must exercise at a low intensity level for a sustained period of time. During the first few minutes of exercise, your body uses easily accessible car-

bohydrate calories for energy. Only after the first few minutes does your body begin to use stored fat calories for energy. If your goal is to burn fat, adjust the intensity of your exercise until your heart rate is near the low end of your training zone.

## Aerobic Exercise

If your goal is to strengthen your cardiovascular system, your exercise must be "aerobic." Aerobic exercise is activity that requires large amounts of oxygen for prolonged periods of time. This increases the demand on the heart to pump blood to the muscles, and on the lungs to oxygenate the blood. For aerobic exercise, adjust the intensity of your exercise until your heart rate is near the middle of your training zone.

## HOW TO MEASURE YOUR HEART RATE

To measure your heart rate, stop exercising and place two fingers on your wrist as shown. Take a six-second heartbeat count, and multiply the result by ten to find your heart rate. (A six-second count is used because your heart rate drops quickly when you stop exercising.) If your heart rate is too high, decrease the intensity of your exercise. If your heart rate is too low, increase the intensity of your exercise.

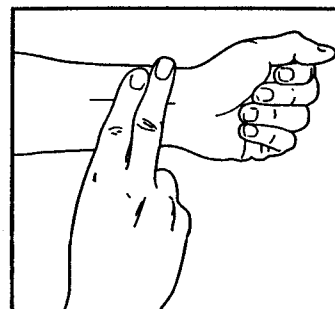

## WORKOUT GUIDELINES

Each workout should include three parts: (1) a warm-up, (2) training zone exercise, and (3) a cool-down.

### Warming-up

Warming up prepares the body for exercise by increasing circulation, delivering more oxygen to the muscles and raising the body temperature. Begin each workout with 5 to 10 minutes of stretching and light exercise to warm up (see SUGGESTED STRETCHES on page 29).

### Training Zone Exercise

After warming up, increase the intensity of your exercise until your heart rate is in your training zone for 20 to 60 minutes. (During the first few weeks of your exercise program, do not keep your heart rate in your training zone for longer than 20 minutes.) Breathe regularly and deeply as you exercise—never hold your breath.

## A Cool-down

Finish each workout with 5 to 10 minutes of stretching to cool down. This will increase the flexibility of your muscles and will help to prevent post-exercise problems.

## Exercise Frequency

To maintain or improve your condition, complete three workouts each week, with at least one day of rest between workouts. After a few months of regular exercise, you may complete up to five workouts each week if desired. *The key to success is to make exercise a regular and enjoyable part of your everyday life.*

### SUGGESTED STRETCHES

The correct form for several basic stretches is shown in the drawings below. Move slowly as you stretch—never bounce.

#### 1. Toe Touch Stretch

Stand with your knees bent slightly and slowly bend forward from your hips. Allow your back and shoulders to relax as you reach down toward your toes as far as possible. Hold for 15 counts, then relax. Repeat 3 times. Stretches: Hamstrings, back of knees and back.

#### 2. Hamstring Stretch

Sit with one leg extended. Bring the sole of the opposite foot toward you and rest it against the inner thigh of your extended leg. Reach toward your toes as far as possible. Hold for 15 counts, then relax. Repeat 3 times for each leg. Stretches: Hamstrings, lower back and groin.

#### 3. Calf/Achilles Stretch

With one leg in front of the other, reach forward and place your hands against a wall. Keep your back leg straight and your back foot flat on the floor. Bend your front leg, lean forward and move your hips toward the wall. Hold for 15 counts, then relax. Repeat 3 times for each leg. To cause further stretching of the achilles tendons, bend your back leg as well. Stretches: Calves, achilles tendons and ankles.

#### 4. Quadriceps Stretch

With one hand against a wall for balance, reach back and grasp one foot with your other hand. Bring your heel as close to your buttocks as possible. Hold for 15 counts, then relax. Repeat 3 times for each leg. Stretches: Quadriceps and hip muscles.

#### 5. Inner Thigh Stretch

Sit with the soles of your feet together and your knees outward. Pull your feet toward your groin area as far as possible. Hold for 15 counts, then relax. Repeat 3 times. Stretches: Quadriceps and hip muscles.

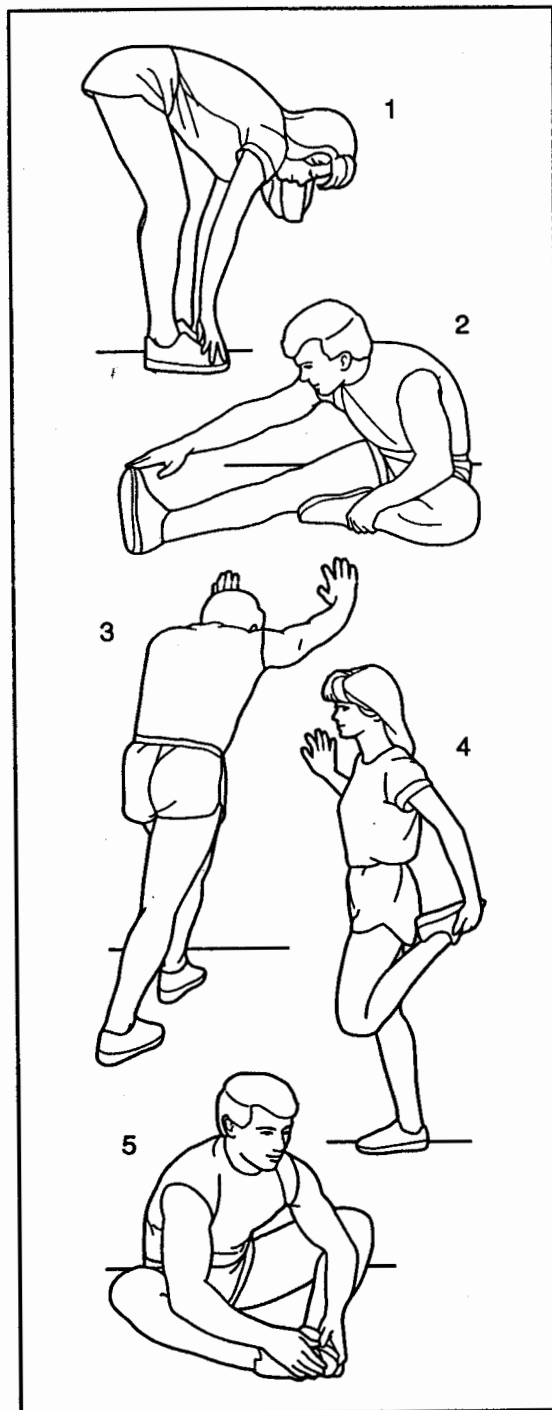

# PART LIST—Model No. IMTL30261

R0197A

Note: To identify the parts listed below, refer to the EXPLODED DRAWING attached to the center of this manual.

Key No.	Qty.	Description	Key No.	Qty.	Description
1	2	Handlebar Pivot Bolt	53	1	Hood
2	1	Motor Sleeve	54	2	Small Plastic Washer
3	6	Nut	55	2	Motor Bushing
4	2	Upright Bracket Bolt	56	1	Console
5	5	Small Screw	57	1	Motor
6	6	Console Screw	58	1	Motor Belt
7	1	Ground Wire	59	1	Incline Motor
8	1	Clevis Pin	60	1	Power Cord
9	1	Cotter Pin	61	1	Grommet
10	2	Hex-head bolt	62	1	Wire Harness
11	2	Washer	63	4	Trim Screw
12	10	Screw	64	2	Wire Harness Grommet
13	4	Washer	65	2	Shock
14	6	Belly Pan Screw	66	1	Power Supply w/Clips
15	4	Endcap Bolt	67	1	Controller
16	1	Adjustment Bolt (short)	68	1	Incline Leg
17	12	Adjustment Washer	69	1	Belly Pan
18	4	Frame Isolator Screw	70	1	Endcap Plug
19	2	Isolator	71	1	Rear Roller Endcap
20	8	Spring Cushion	72	1	Frame
21	6	Platform Screw	73	1	Walking Platform
22	3	Wire Clip	74	1	Console Base
23	1	Tension Spring	75	1	Base
24	1	Spring Sleeve	76	2	Endcap Foot
25	3	Roller Tension Nut	77	1	Magnet
26	2	Spacer	78	1	Allen Wrench
27	1	Roller Bushing (left)	79	1	Adhesive Clip
28	6	Endcap Fastener	80	10	Trim Bracket Screw
29	10	Pan Screw	81	1	Walking Belt
30	26	Small Screw	82	1	Frame Cover
31	2	Frame Pivot Bolt	83	1	Adjustment Bolt (long)
32	1	Motor Tension Bolt	84	2	Elbow Mount Bolt
33	1	Star Washer	85*	1	Motor/Pulley/Flywheel/Fan
34	1	Motor Tension Washer	86	1	Pulley/Flywheel/Fan
35	1	Motor Tension Nut	87	1	Wire Tie Holder
36	1	Motor Pivot Bolt	88	2	Handlebar Elbow
37	4	Spring	89	1	Motor/Controller Wire
38	2	Upright Bracket	90	2	8" Wire Tie
39	5	Hood Anchor	91	1	Key/Clip
40	5	Hood Bracket	92	1	TV Remote Control
41	4	Plastic Stand-off	93	3	Stabilizer Pad
42	1	Choke	94	2	Optic Switch Wire
43	1	Bracket	95	1	Incline Cover Shield
44	1	Roller Bushing (right)	96	1	Incline Cover
45	1	Circuit Breaker	97	2	Frame Spacer
46	1	Electronics Bracket	98	1	Choke Plate
47	2	Belt Guide	99	1	Battery Cover
48	1	Rear Roller	100	4	Releaseable Tie
49	1	Front Roller/Pulley	101	1	4" Wire Tie
50	2	Foot Rail	102	1	Incline Bracket
51	2	Upright Arm	103	1	On/Off Switch
52	2	Handlebar Arm	104	2	Incline Cover Clip

Key No.	Qty.	Description	Key No.	Qty.	Description
105	1	Upright Plug	148	4	Angle Bracket
106	1	Incline Motor Bolt	149	8	Hinge
107	2	Incline Motor Nut	150	1	Wire Cover
108	1	Console/Control Board Wire	151	2	Upright Endcap
109	2	Large Washer	152	8	Shelf Pin
110	2	Monitor Bracket	153	2	Handlebar Pivot Spacer
111	1	TV/Control Board Wire	154	5	Trim Bracket
112	2	Monitor Isolator	155	2	Top Trim Board
113	10	Panel Screws	156	1	Inner Trim Board
114	1	Right Face Panel	157	1	Front Trim Board
115	1	Right Rear Panel	158	2	Lower Door
116	1	Left Face Panel	159	8	Hinge Plate
117	1	Left Rear Panel	160	2	Top Door
118	1	Control Board	161	4	Corner Bracket Screw
119	1	Color TV Monitor	162	1	Stabilizer
120	1	Cable Connection	163	1	Right Upright
121	1	Cable Connection Bolt	164	1	Left Upright
122	1	Incline Motor Spacer	165	4	Upright Bolt
123	1	Speed Disk	166	4	Upright Nut
124	1	Optic/Filter Bracket	167	1	Top Cross Member
125	1	Optic Switch Bracket Nut	168	2	Shelf Board
126	1	Incline Optic Disk	169	1	Monitor Shelf
127	2	Bracket Screw	170	1	Top Board
128	2	Optic Switch Nut	171	1	Right Side Board
129	2	Optic Switch Star Washer	172	1	Left Side Board
130	2	Optic Switch	173	1	Back Board
131	4	Endcap Bolt Washer	174	32	Hinge Screw
132	1	Filter	175	1	Incline Stop Bracket
133	2	Pad Screw	176	1	Control Board Cover
134	8	Upright Bracket Screw	177	3	Control Board Cover Screw
135	12	Small Wood Screw	#	12	Fastener
136	14	Medium Wood Screw	#	1	8" Green Wire, Female/Ring
137	2	Plastic Washer	#	1	8" Blue Wire, 2 Female
138	24	Upright Screw	#	1	6" Black Wire, Pigtail
139	12	Back Board Screw	#	1	14" White Wire, Pigtail
140	22	Screw	#	1	8" White Wire, 2 Female
141	2	Motor Bushing	#	1	8" Black Wire, 2 Female
142	1	Left Lower Door Handle	#	1	16" Red Wire, 2 Female
143	1	Right Lower Door Handle	#	1	User's Manual
144	1	Left Top Door Handle			
145	1	Right Top Door Handle			
146	3	Stabilizer Pad			
147	4	Base Foot			

\* Includes all parts shown in the box

# These parts are not illustrated

Note: Specifications are subject to change without notice. For information about ordering replacement parts, see the back cover of this manual.

# ORDERING REPLACEMENT PARTS

To order replacement parts, call our Customer Service Department toll-free at 1-800-999-3756, Monday through Friday, 6 a.m. until 6 p.m. Mountain Time (excluding holidays). When ordering parts, please be prepared to give the following information:

- The MODEL NUMBER of the product (IMTL30261).
- The NAME of the product (IMAGE® ACCESS 3000 treadmill).
- The SERIAL NUMBER of the product (see BEFORE YOU BEGIN on page 6 for the location of the serial number decal).
- The KEY NUMBER of the part(s) (see the PART LIST on pages 30 and 31, and the EXPLODED DRAWING attached to the center of this manual).
- The DESCRIPTION of the part(s) (see the PART LIST on pages 30 and 31, and the EXPLODED DRAWING attached to the center of this manual).

IMAGE is a registered trademark of ICON Health & Fitness, Inc.

## LIMITED WARRANTY

ICON Health & Fitness, Inc. (ICON), warrants this product to be free from defects in workmanship and material, under normal use and service conditions, for a period of ninety (90) days from the date of purchase. This warranty extends only to the original purchaser. ICON's obligation under this warranty is limited to replacing or repairing, at ICON's option, the product at one of its authorized service centers. All products for which warranty claim is made must be received by ICON at one of its authorized service centers with all freight and other transportation charges prepaid, accompanied by sufficient proof of purchase. All returns must be pre-authorized by ICON. This warranty does not extend to any product or damage to a product caused by or attributable to freight damage, abuse, misuse, improper or abnormal usage or repairs not provided by an ICON authorized service center, to products used for commercial or rental purposes, or to products used as store display models. No other warranty beyond that specifically set forth above is authorized by ICON.

ICON is not responsible or liable for indirect, special or consequential damages arising out of or in connection with the use or performance of the product or damages with respect to any economic loss, loss of property, loss of revenues or profits, loss of enjoyment or use, costs of removal, installation or other consequential damages of whatsoever nature. Some states do not allow the exclusion or limitation of incidental or consequential damages. Accordingly, the above limitation may not apply to you.

The warranty extended hereunder is in lieu of any and all other warranties and any implied warranties of merchantability or fitness for a particular purpose is limited in its scope and duration to the terms set forth herein. Some states do not allow limitations on how long an implied warranty lasts. Accordingly, the above limitation may not apply to you.

This warranty gives you specific legal rights. You may also have other rights which vary from state to state.

**ICON HEALTH & FITNESS, INC., 1500 S. 1000 W., LOGAN, UT 84321-9813**

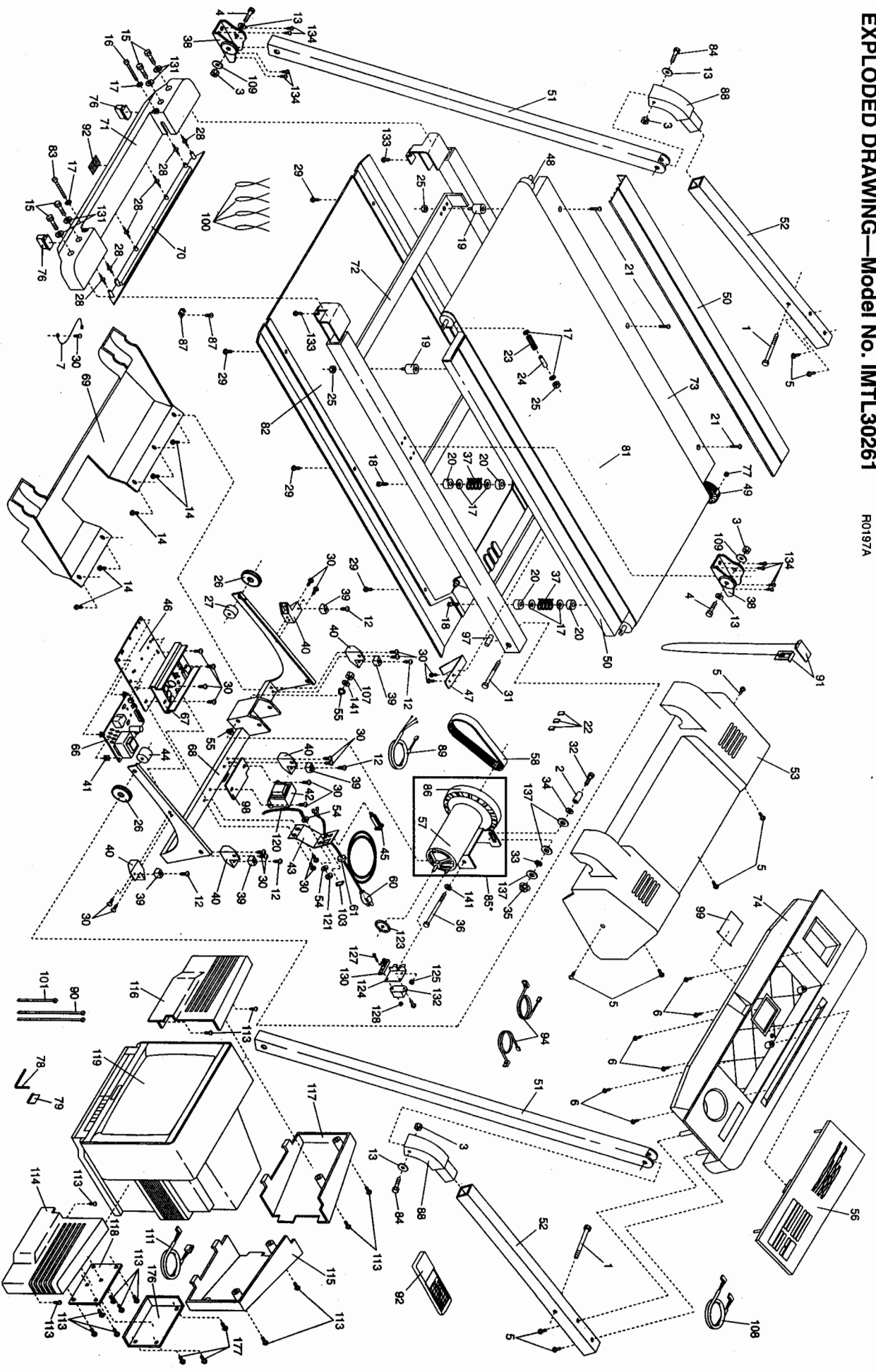

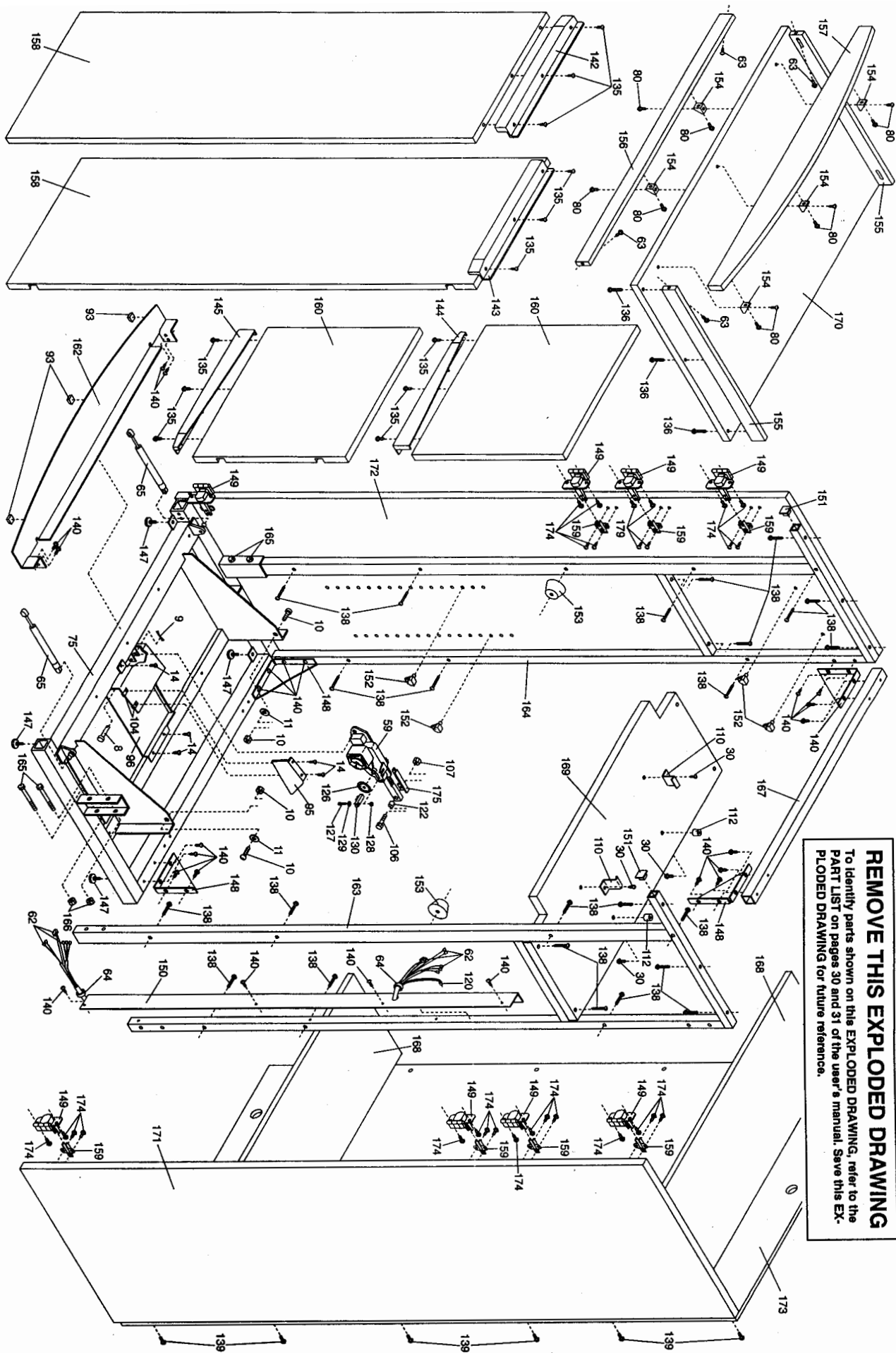

**REMOVE THIS EXPLODED DRAWING**  
 To identify parts shown on this EXPLODED DRAWING, refer to the PART LIST on pages 30 and 31 of the user's manual. Save this EXPLODED DRAWING for future reference.