

DayBreak

by WESLO®

Model No. SPRW52461

Serial No. _____

Write the serial number in the space above for reference.

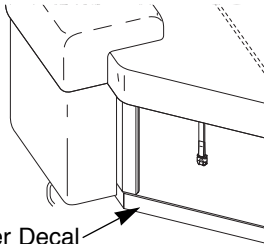

Serial Number Decal

QUESTIONS?

As a manufacturer, we are committed to providing complete customer satisfaction. If you have questions, or find that there are missing or damaged parts, we will guarantee complete satisfaction through direct assistance from our factory.

TO AVOID UNNECESSARY DELAYS, PLEASE CALL DIRECT TO OUR TOLL-FREE CUSTOMER HOT LINE. The trained technicians on our customer hot line will provide immediate assistance, free of charge to you.

CUSTOMER HOT LINE:

1-800-999-3756

Mon.–Fri., 6 a.m.–6 p.m. MST

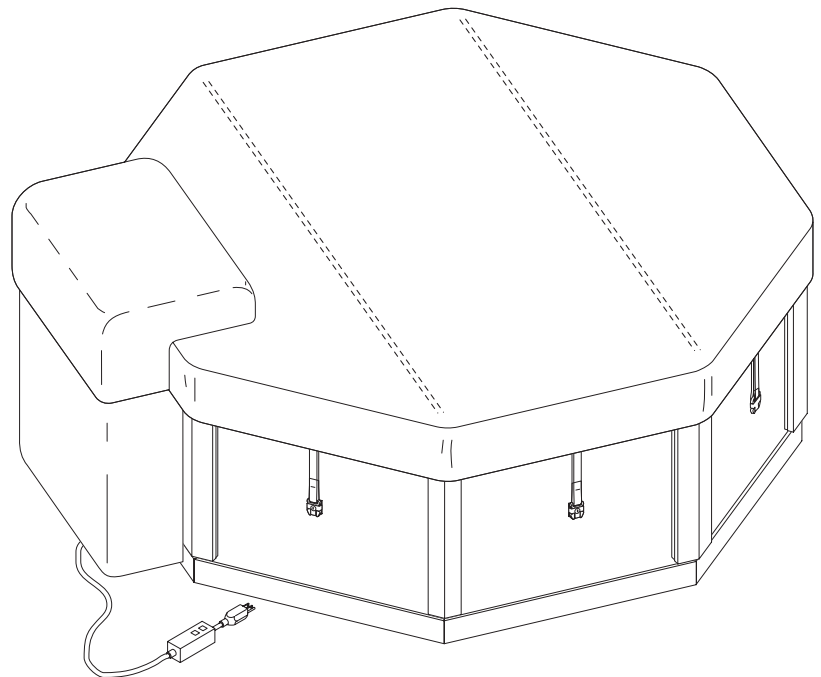

USER'S MANUAL

CAUTION

Read all precautions and instructions in this manual before using this equipment. Save this manual for future reference.

A pH testing kit (not included) is required for proper use and maintenance of the DAYBREAK. A pH testing kit can be purchased at any spa or pool supply store.

TABLE OF CONTENTS

LIMITED WARRANTY	2
IMPORTANT SAFETY INSTRUCTIONS	3
WARNING DECAL PLACEMENT	5
BEFORE YOU BEGIN	6
CHOOSING A LOCATION FOR THE DAYBREAK	7
ASSEMBLY	8
USING THE DAYBREAK	12
MAINTENANCE	15
TROUBLE-SHOOTING	16
WIRING DIAGRAM	17
PART LIST	18
EXPLODED DRAWING	19
ORDERING REPLACEMENT PARTS	Back Cover

WESLO® is a registered trademark of ICON Health & Fitness, Inc.

LIMITED WARRANTY

ICON Health & Fitness, Inc. (ICON), warrants this product to be free from defects in workmanship and material, under normal use and service conditions, for a period of ninety (90) days from the date of purchase. This warranty extends only to the original purchaser. ICON's obligation under this warranty is limited to replacing or repairing, at ICON's option, the product at one of its authorized service centers. All products for which warranty claim is made must be received by ICON at one of its authorized service centers with all freight and other transportation charges prepaid, accompanied by sufficient proof of purchase. All returns must be pre-authorized by ICON. This warranty does not extend to any product or damage to a product caused by or attributable to freight damage, abuse, misuse, improper or abnormal usage or repairs not provided by an ICON authorized service center, products used for commercial or rental purposes, or products used as store display models. No other warranty beyond that specifically set forth above is authorized by ICON.

ICON is not responsible or liable for indirect, special or consequential damages arising out of or in connection with the use or performance of the product or damages with respect to any economic loss, loss of property, loss of revenues or profits, loss of enjoyment or use, costs of removal, installation or other consequential damages of whatsoever nature. Some states do not allow the exclusion or limitation of incidental or consequential damages. Accordingly, the above limitation may not apply to you.

The warranty extended hereunder is in lieu of any and all other warranties and any implied warranties of merchantability or fitness for a particular purpose is limited in its scope and duration to the terms set forth herein. Some states do not allow limitations on how long an implied warranty lasts. Accordingly, the above limitation may not apply to you.

This warranty gives you specific legal rights. You may also have other rights which vary from state to state.

ICON HEALTH & FITNESS, INC., 1500 S. 1000 W., LOGAN, UT 84321-9813

IMPORTANT SAFETY INSTRUCTIONS

WARNING: To reduce the risk of drowning, electric shock, or serious injury, read the following important precautions before using the DAYBREAK.

READ AND FOLLOW ALL INSTRUCTIONS

1. It is the responsibility of the owner to ensure that all users of the DAYBREAK are adequately informed of all precautions.
2. Use the DAYBREAK only as described in this manual.
3. The DAYBREAK is intended for home use only. Do not use the DAYBREAK in any commercial, rental, or institutional setting.
4. Use the DAYBREAK only on a level surface. Do not use the DAYBREAK on carpet or other materials that could be damaged by moisture. Do not use the DAYBREAK on rough or sharp surfaces such as gravel or wood chips.
5. The DAYBREAK will weigh approximately 1600 pounds when it is assembled and filled with water. Be sure that the location you select for the DAYBREAK will support this weight, plus the weight of the occupants.
6. Inspect and tighten all parts regularly. Replace any worn parts immediately.
7. **DANGER—Risk of injury:** Do not remove or alter the covers on the suction fittings. Never operate the DAYBREAK if the suction guard is missing or broken. Keep hair and body away from the suction guard. If you need to replace a suction fitting, be sure that the flow rate of the replacement is compatible.
8. Do not bring any object into the DAYBREAK that could puncture the liner.
9. Never insert any object into any opening.
10. Do not sit on the spa cover or place objects on it. It is not designed to support weight.
11. Remove any water which may collect on the spa cover.
12. Keep children and pets away from the DAYBREAK when it is not in use.
13. Keep all chemicals away from children and pets.
14. The pH and chemical balance of the water must be maintained as explained in this manual (see page 15). Failure to do so may cause injury to users or damage to the spa jet unit, and will void the warranty.
15. The water pump in the spa jet unit must be primed before you use the DAYBREAK the first time. You must also prime the pump before using the unit each time you re-fill the spa. The spa jet unit may be seriously damaged if the pump is not properly primed (see PRIMING THE SPA JET UNIT on page 12).
16. **DANGER—**When connecting the power cord (see PLUGGING IN THE DAYBREAK on page 12), plug the power cord directly into a grounded circuit capable of carrying 15 or more amps. No other appliance should be on the same circuit. Replace the power cord immediately if damaged.
17. Do not use an extension cord with the DAYBREAK. This could damage the motor and will void the warranty.
18. **DANGER—**If you will be using the DAYBREAK outside, do not bury the power cord; you should also keep the power cord away from lawn mowers, hedge trimmers, and other similar equipment.
19. **WARNING—**The power cord is equipped with a Ground Fault Circuit Interrupter (GFCI), located at the end of the power cord. The GFCI must be tested before each use. To test the GFCI, press the “test” button while the spa jet unit is running. The spa jet unit should shut off. Press the “reset” button. The spa jet unit should resume normal operation. If the spa jet unit continues to run after the “test” button is pressed, then the GFCI is damaged. Do not use the DAYBREAK until the GFCI has been repaired or replaced by a qualified electrician.

20. Keep all electrical appliances such as radios, telephones, televisions, and lights at least five feet (1.52 meters) away from the water.
21. A wire connector is provided on the pump motor of this unit to connect a minimum No. 8 AWG (804 mm²) solid copper conductor between this unit and any metal equipment, electrical enclosure made of metal, metal water pipes, or conduit within five feet (1.52m) of the unit.
22. **DANGER**—Risk of electric shock: Do not set up the DAYBREAK within five feet of any metal objects or surfaces. As an alternative, you may use the DAYBREAK within five feet of metal objects if each metal object is permanently connected to the wire connector on the pump motor of this unit by a minimum No. 8 AWG (804 mm²) solid copper conductor (see instruction 21).
23. **DANGER**—Risk of drowning: Exercise extreme caution to prevent unauthorized and unsupervised use of the DAYBREAK by children. Children must always be supervised.
24. **DANGER**—To reduce the risk of drowning:
 - Never use the DAYBREAK alone;
 - Children should not use the DAYBREAK unless they are supervised by an adult;
 - Keep pets away from the DAYBREAK at all times;
 - Always replace and lock the spa cover when the DAYBREAK is not in use.
25. **WARNING**—To reduce the risk of injury: The water temperature should never exceed 104°F (40°C). Temperatures between 100°F (38°C) and 104°F (40°C) are considered to be safe for healthy adults. However, if you plan to remain in the DAYBREAK for more than 10 to 15 minutes, a lower temperature is recommended. Lower temperatures are also recommended for children.
26. **WARNING**—To reduce the risk of injury: Always use an accurate thermometer to determine the water temperature before using the DAYBREAK.
27. **WARNING**—To reduce the risk of injury: Pregnant women should consult with their physician before using the DAYBREAK. Pregnant women should not use the DAYBREAK if the water temperature is above 100°F (38°C); the unborn child could be seriously harmed.
28. **DANGER**—To reduce the risk of drowning: Prolonged immersion in the DAYBREAK may cause hyperthermia, a dangerous condition which occurs when the internal body temperature rises several degrees above the normal body temperature of 98.6°F. The symptoms of hyperthermia are nausea, dizziness, drowsiness, and fainting. Effects include: a lack of awareness, inability to perceive heat or danger, and a greater risk of drowning due to a loss of consciousness. Special note: Individuals suffering from hyperthermia may be unable to realize that they must exit the DAYBREAK, and they also may be physically unable to do so.
29. **WARNING**—To reduce the risk of drowning: Heat from the water, in conjunction with alcohol or drugs can cause unconsciousness. Do not use the DAYBREAK if you are under the influence of drugs or alcohol.
30. **WARNING**—To reduce the risk of injury or drowning: Consult your physician about possible side-effects of any medications you may be taking before using the DAYBREAK. Heat from the water, in conjunction with some medications may cause drowsiness and increase the risk drowning. Others can effect blood pressure, heart rate, and circulation.
31. **WARNING**—To reduce the risk of injury: It is especially important for persons over the age of 35 or persons with pre-existing health problems, such as obesity, heart disease, high or low blood pressure, circulatory problems, or diabetes to consult your physician before using this product.
32. If you feel pain or dizziness at any time while using the DAYBREAK, discontinue use and contact a physician.

WARNING: Read all instructions before using the DAYBREAK. ICON assumes no responsibility for personal injury or property damage sustained by or through the use of this product.

SAVE THESE INSTRUCTIONS

WARNING DECAL PLACEMENT

The decals shown below have been placed on the DAYBREAK. If a decal is missing, or if it is not legible, please call our Customer Service Department toll-free at 1-800-999-3756, Monday through Friday, 6 a.m. until 6 p.m. Mountain Time, to order a replacement decal. Apply the decal in the location shown.

WARNING

AVOID DROWNING RISK

- STAY OFF COVER—WILL NOT SUPPORT WEIGHT.
- KEEP CHILDREN AWAY. CHILDREN OR OBJECTS CANNOT BE SEEN UNDER COVER.
- REMOVE STANDING WATER—CHILD CAN DROWN ON TOP OF COVER.
- REMOVE COVER(S) COMPLETELY BEFORE ENTRY OF BATHERS—ENTRAPMENT POSSIBLE.
- NON-SECURED OR IMPROPERLY SECURED COVERS ARE A HAZARD.
- FAILURE TO FOLLOW ALL INSTRUCTIONS MAY RESULT IN INJURY OR DROWNING.
- THIS IS NOT A SAFETY COVER.

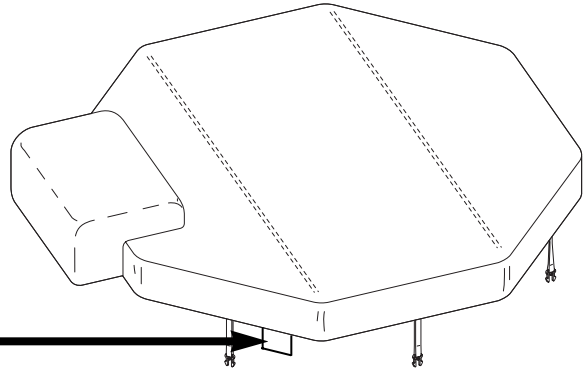

WARNING

PREVENT DROWNING

- SUPERVISE CHILDREN AT ALL TIMES.
- ATTACH SPA COVER AFTER EACH USE.
- SPA HEAT CAN CAUSE HYPERTHERMIA AND UNCONSCIOUSNESS.
- SPA HEAT IN CONJUNCTION WITH ALCOHOL, DRUGS, OR MEDICATION CAN CAUSE UNCONSCIOUSNESS.

PREVENT ELECTROCUTION

- NEVER PLACE ANY ELECTRIC APPLIANCE WITHIN 5 FEET OF SPA.
- NEVER SUBMERGE ENTIRE EQUIPMENT PACK IN WATER — REFER TO OWNER'S MANUAL FOR PROPER INSTALLATION.

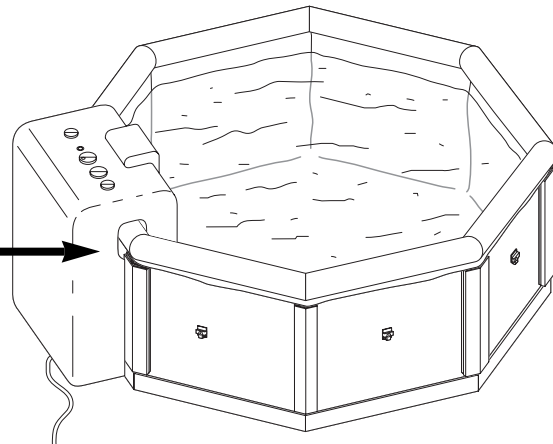

BEFORE YOU BEGIN

Thank you for selecting the DAYBREAK by WESLO®. The innovative DAYBREAK offers the features and quality of a traditional hot tub at an affordable price. Best of all, the DAYBREAK is fully portable, so you can take it wherever there is an electrical outlet. The DAYBREAK allows you to relax and unwind in the comfort of your own home.

For your benefit, read this manual carefully before using the DAYBREAK by WESLO®. If you have additional questions, please call our Customer Service

Department toll-free at 1-800-999-3756, Monday through Friday, 6 a.m. until 6 p.m. Mountain Time (excluding holidays). To help us assist you, please note the product model number and serial number before calling. The model number is SPRW52461. The serial number can be found on a decal attached to one of the floor caps (see the front cover of this user's manual).

Before reading further, please familiarize yourself with the parts that are labeled in the drawing below.

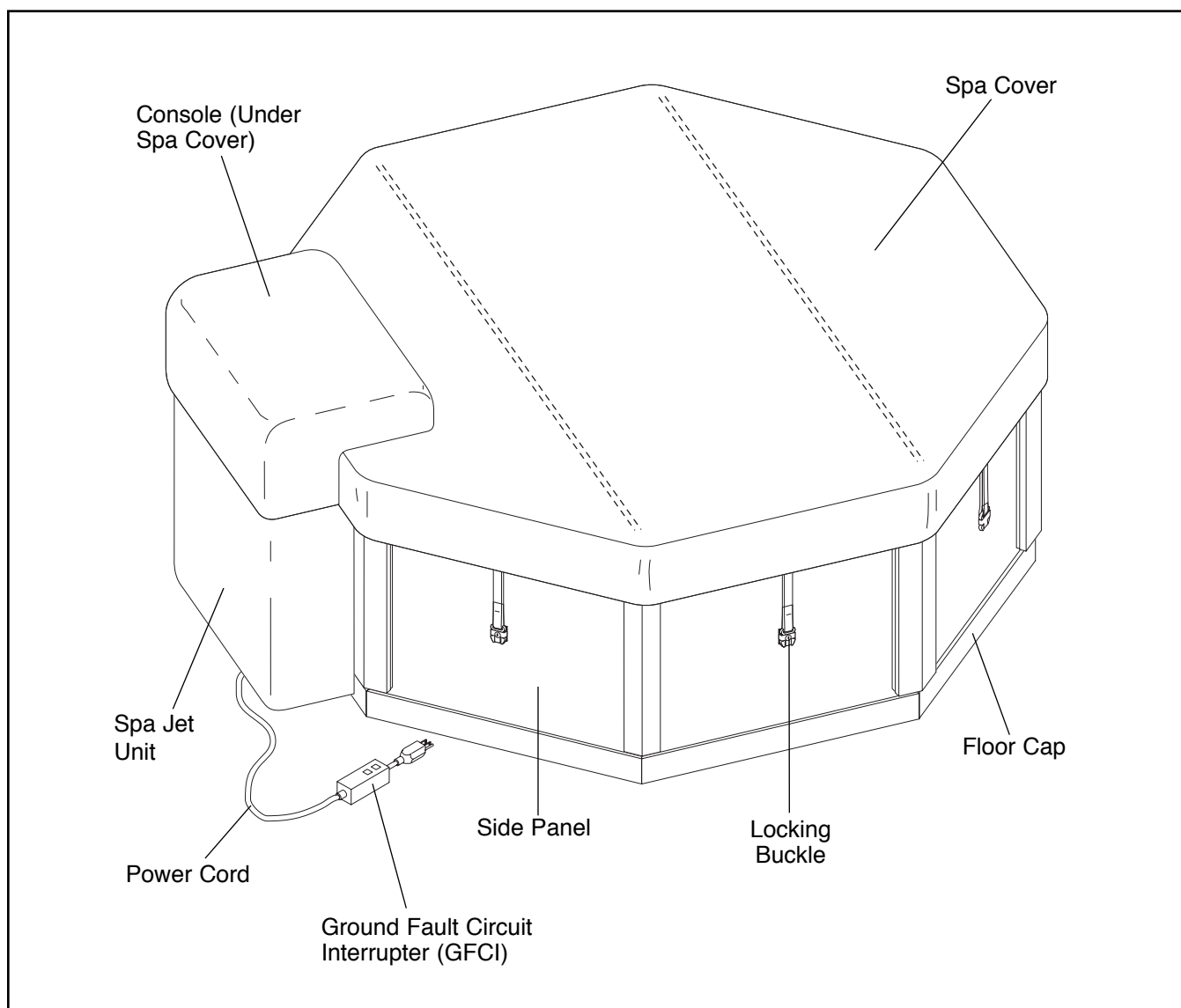

CHOOSING A LOCATION FOR THE DAYBREAK

There are many factors to consider when choosing a location to set up the DAYBREAK. These factors vary depending on whether you use the DAYBREAK inside or outside. We have listed several factors you may wish to consider as you decide where you want to use the DAYBREAK.

If you set up the DAYBREAK inside:

1. The DAYBREAK will increase the level of humidity in your home. The location you choose should be well ventilated. You may need to install a ventilation fan or use a dehumidifier.
2. The location must be close to an electrical outlet. **Do not use an extension cord with the DAYBREAK.**
3. The DAYBREAK should be close to a source of water.
4. Do not use the DAYBREAK on carpet or other material that may be damaged by moisture. We recommend that you place the DAYBREAK on a water- and stain-resistant, non-slip surface with a floor drain for any water that may splash from the DAYBREAK.
5. Be sure that the location you choose is stable. It must be able to support the weight of the DAYBREAK when it is filled with water, plus the weight of the occupants. The DAYBREAK weighs approximately 1600 pounds when filled with water.
6. Do not use the DAYBREAK above a finished living area, due to the risk of water damage.
7. Be sure that there is room around the DAYBREAK to permit servicing of the unit. The diameter of the tub is 60". You should allow for this size, plus the size of the spa jet unit, when choosing the location.
8. Be sure to note any other considerations, such as aesthetics or privacy concerns, that may affect the safety or enjoyment of using the DAYBREAK.

If you set up the DAYBREAK outside:

1. You should check your local building codes concerning the use of outdoor spas.
2. The location must be close to an electrical outlet. **Do not use an extension cord with the DAYBREAK.**
3. The DAYBREAK should be close to a source of water.
4. We recommend that you place the DAYBREAK on a water- and stain-resistant, non-slip surface.
5. Be sure that the location you choose is stable. It must be able to support the weight of the DAYBREAK when it is filled with water, plus the weight of the occupants. The DAYBREAK weighs approximately 1600 pounds when filled with water.
6. Think about environmental factors, such as rain, wind, shade, sunlight, and so forth.
7. You should be able to monitor the use of the DAYBREAK from your home, to prevent unauthorized use by children.
8. Be sure that there is room around the DAYBREAK to permit servicing of the unit. The diameter of the tub is 60". You should allow for this size, plus the size of the spa jet unit, when choosing the location.
9. Be sure to note any other considerations, such as aesthetics or privacy concerns, which may affect the safety or enjoyment of using the DAYBREAK.



ASSEMBLY

Before beginning assembly, carefully read the following information and instructions:

- Place all parts in a cleared area and remove the packing materials; do not dispose of the packing materials until assembly is completed.
- Assembly requires two people.
- Tighten all parts as you assemble them, unless instructed to do otherwise.

- Read each assembly step before you begin.
- During assembly, make sure that all parts are oriented as shown in the drawings.

TOOLS REQUIRED FOR ASSEMBLY:

- **Your own phillips screwdriver** 
- **The included allen wrench** 
- **You may also need a hammer** 

- Before beginning assembly, be sure that you have read and understand the information in the box above and on the previous page.**

Press a Floor Cap (2) onto the bottom of each of the eight Side Panels (1). **Be sure to align the indicated holes. The Side Panels must be oriented and fully inserted in the Floor Caps as shown in the inset drawing.**

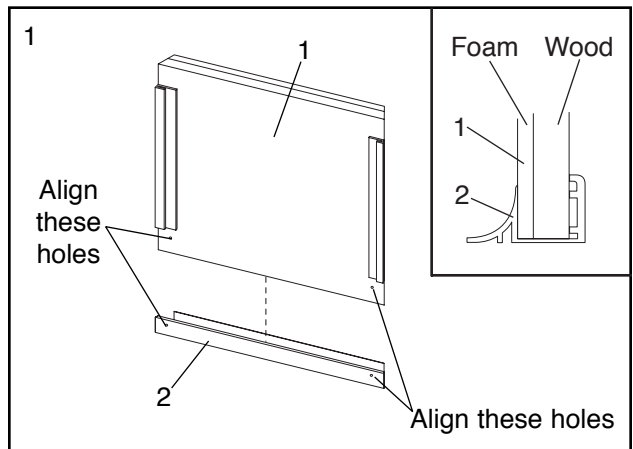

- Slide an Angle Bracket (3) between one of the Side Panels (1) and the Floor Cap (2), as shown. Attach the Angle Bracket to the Side Panel with a Bracket Screw (4).

Attach an Angle Bracket (3) to each of the remaining Side Panels (1) in the same manner.

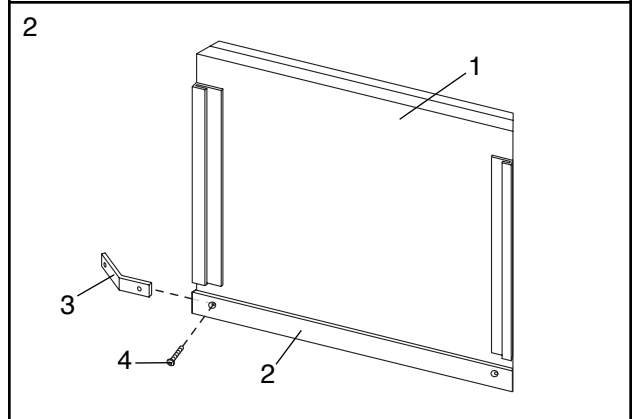

- Slide two of the Side Panels (1) together as shown. **The indicated Angle Bracket (3) should go between the Side Panel and the Floor Cap (2).** Slide a Connector Bracket (6) into the Side Brackets (5). Attach the Angle Bracket to the other Side Panel with a Bracket Screw (4).

Continue to connect the remaining Side Panels (1) in the same manner.

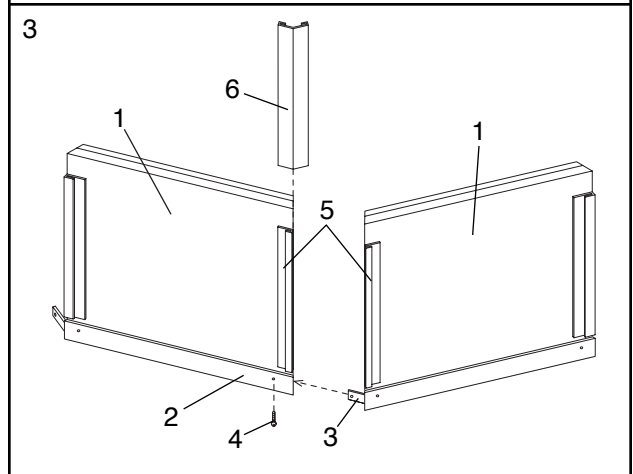

- Place the Insulated Floor Cover (8) inside the assembled Side Panels (1). The edge of the Insulated Floor Cover should cover the bottom two inches of the Side Panels (see the inset drawing).

Measure the width of the DAYBREAK, from the top center of one Side Panel (1) to the top center of the Side Panel directly across from it. Take two measurements, as shown. **Both measurements must be the same.** The measurement should be between 56" and 58". If the frame is not squared, the Spa Cover (not shown) will not fit properly. If necessary, adjust the positions of the Side Panels so the frame is squared.

- Place the Spa Liner (9) on top of the Insulated Floor Cover (8). Smooth out the Spa Liner, working the wrinkles to the edges. The seam in the Spa Liner should be lined up with a joint between two of the Side Panels (1).

Stretch the edge of the Spa Liner (9) over the top of the Side Panels (1), working the wrinkles to the top. **The edge of the Spa Liner should hang over the Side Panels about two inches.**

- Place the Small Edge Protector (14) on top of the Side Panel (1) closest to the electrical outlet which you will use to power the DAYBREAK. **This is the Side Panel where the Spa Jet Unit (not shown) will be placed.**

Place the seven Edge Protectors (12) around the top of the remaining Side Panels (1).

- Remove the power cord from the Spa Jet Unit (13). Place the Spa Jet Unit over the Side Panel (1) with the Small Edge Protector (14). **Be extremely careful not to tear the Spa Liner (9) as you slide the Spa Jet Unit into place.**

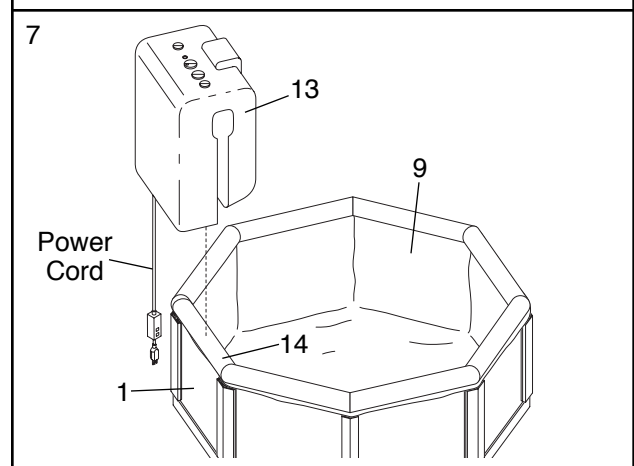
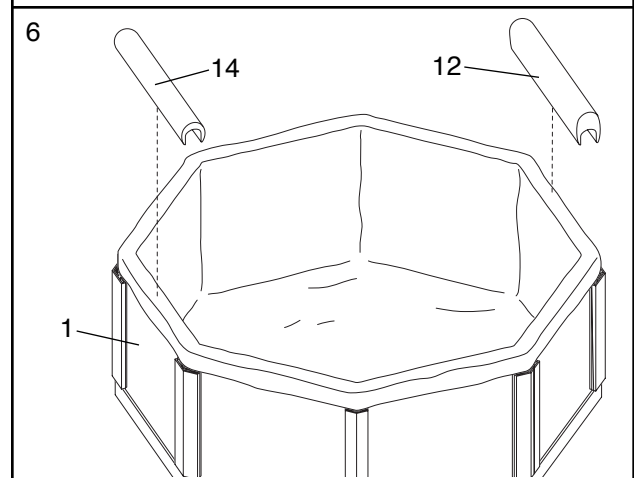
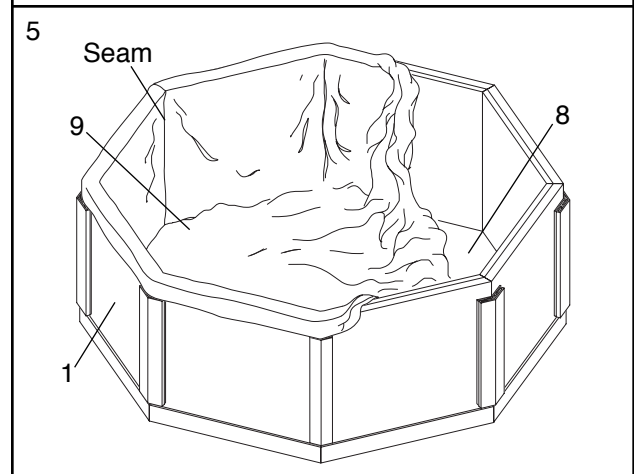
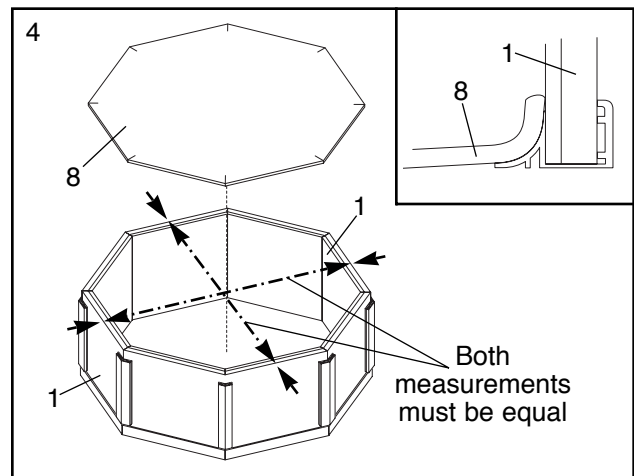

8. Before you fill the DAYBREAK, be sure that it is in the position you want, and that it can be easily serviced, if needed. Once the DAYBREAK is filled with water, it will need to be drained to be moved.

Using a garden hose or other clean water source, begin filling the DAYBREAK. Be sure to check for wrinkles, which may form in the Spa Liner (9) as the water begins to cover the bottom. It is very important that you remove as many wrinkles from the floor and sides of the DAYBREAK as possible. To do this, you should smooth any wrinkles out toward the sides, and then smooth the wrinkles to the top. It is normal to have some wrinkles around the Spa Jet Unit (13).

Continue to fill the DAYBREAK, until the jet and filter openings on the Spa Jet Unit (13) are covered with water. **Do not fill the DAYBREAK above the bottoms of the Edge Protectors (12).**

After the DAYBREAK is full, you must prime the Spa Jet Unit (13) before using the DAYBREAK (see PRIMING THE SPA JET UNIT on page 12).

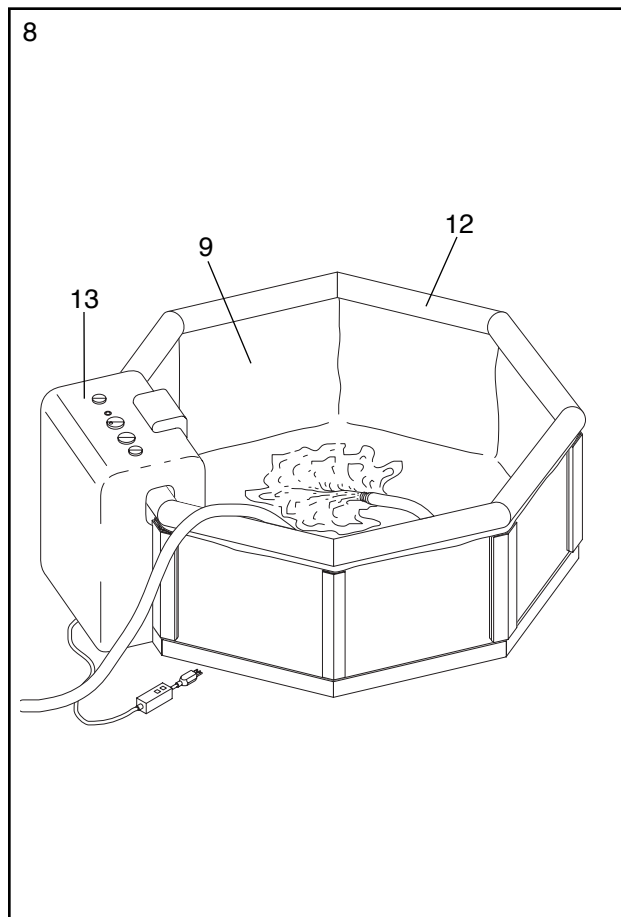

9. Insert the Support Ball (15) into the mesh pocket on the underside of the Spa Cover (11).

See inset drawing A. Insert the inflation tube into the hole in the Support Ball (15). Inflate the Support Ball.

See inset drawing B. When the Support Ball (15) is inflated, remove the inflation tube from the Support Ball and insert the ball plug through the mesh into the Support Ball. **The head of the ball plug will hold the Support Ball in place.**

Note: The Support Ball (15) is not a toy.

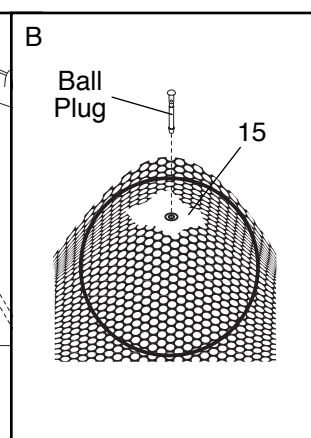
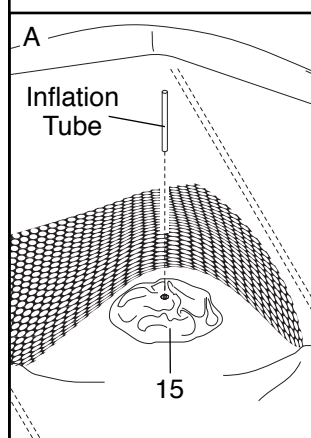
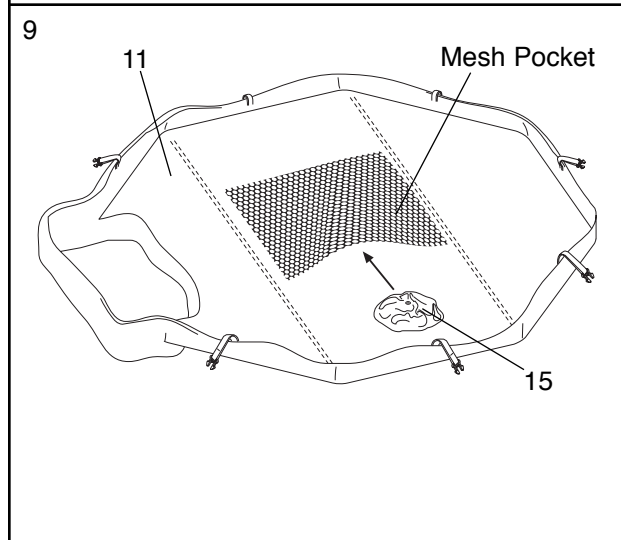

10. Place the Spa Cover (11) over the Side Panels (1) and the Spa Jet Unit (13). **Be sure that the Spa Cover is properly centered and that the corners of the Spa Cover line up with the corners of the Side Panels (1).**

Snap a Buckle (21) onto each of the seven latches on the Spa Cover (11).

See the inset drawing. Position one of the Buckles (21) on the Side Panel (1) and hold the Buckle in place, so the strap on the Spa Cover (11) is tight. (Note: It may be easier to position the Buckles if a second person holds the strap on the opposite side of the Spa Cover tight.) **Do not place the Buckle over one of the grooves in the Side Panel.** Remove the latch. Attach the Buckle to the Side Panel with two Buckle Screws (23). **Note: It may be helpful to use a hammer and a nail to tap starter holes in the Side Panels. You may also want to apply a little soap or wax to the screw threads.**

Attach the other six Buckles (21) to the Side Panels (1) in the same manner.

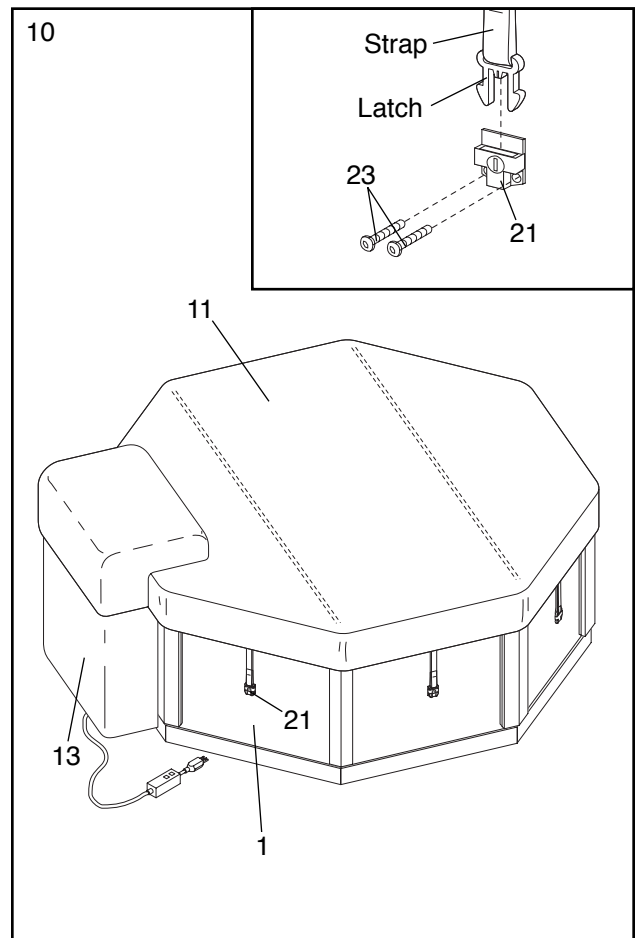

USING THE DAYBREAK

The DAYBREAK is designed for up to four adults. The six water jets can be regulated to provide a relaxing massage to sooth away stress, and the strength of the water massage can be adjusted by the air control. The DAYBREAK holds 170 gallons of water and offers an automatic, programmable heating (70°F to 104°F) and filtration system.

The guidelines below explain how to properly use the DAYBREAK. Follow these guidelines to maintain the DAYBREAK for your long-term enjoyment.

PRIMING THE SPA JET UNIT

The water pump in the spa jet unit must be primed before you use the DAYBREAK the first time. You must also prime the pump before using the unit each time you re-fill the DAYBREAK.

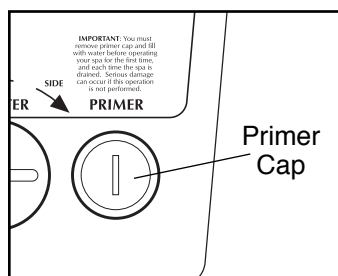

To prime the spa jet unit, remove the primer cap from the console. Fill the spa jet unit with at least 64 oz. of water. **Replace and tighten the primer cap. IMPORTANT: The spa jet unit may be seriously damaged if the pump is not properly primed, or if the primer cap is not replaced and fully tightened.**

PLUGGING IN THE DAYBREAK

Once the DAYBREAK is filled with enough water to cover the water jets and the pump has been primed, the power cord can be plugged in and the spa jet unit can be turned on. Note: The first time the power cord is plugged in, the spa jet unit will turn on automatically.

When connecting the power cord, plug the power cord directly into a grounded circuit capable of carrying 15

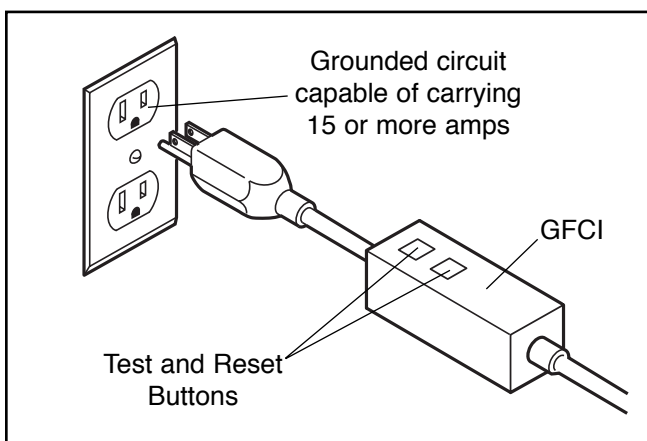

or more amps. No other appliance should be on the same circuit. Replace the power cord immediately if it becomes damaged.

The power cord is equipped with a Ground Fault Circuit Interrupter (GFCI), located at the end of the power cord. You should always test the GFCI before using the DAYBREAK.

First, turn on the DAYBREAK by pressing the power button on the console. Once the unit is running, press the GFCI “test” button. The DAYBREAK should shut off. Press the “reset” button. The DAYBREAK should resume normal operation. If the DAYBREAK continues to run after the “test” button is pressed, then the GFCI is damaged. Do not use the DAYBREAK until the GFCI has been repaired or replaced by a qualified electrician.

STARTING THE DAYBREAK

Once you have tested the GFCI, you should verify the water flow from the pumping unit. Set the air control on the console to the lowest setting (see USING THE CONSOLE on the next page). The pumping unit will heat the water as it pumps. Cover the DAYBREAK with the spa cover. **The spa cover must be tight.** The water will heat at about 1.5°F an hour with the cover on. If you are using the DAYBREAK indoors, and the room temperature is maintained at 70°F, it will take approximately 36 to 48 hours for the water to reach the set temperature.

The temperature and water flow can be set or changed by the controls on the console (see USING THE CONSOLE on the next page).

TESTING AND TREATING THE WATER

The DAYBREAK comes with a starter chemical pack for maintaining the water in the spa. Disregard the directions on the individual packages of “QUICK pHix It DOWN” and “QUICK pHix It UP.” However, the directions on the bottle of “Non-chlorine Shox” and “Bromine Base” are correct. **Always keep the chemicals away from children and pets.**

The first time you use the spa, you should test and treat the water. Once you have verified that the spa jet unit is functioning properly, and have allowed the water to circulate for a while, you should remove the spa cover and add 1/3 of the “Bromine Base” bottle, and 1/3 of the “Non-chlorine Shox” bottle to the water in the spa. Allow the water to circulate for five minutes. You should now test the pH level of the water. You will need a pH test kit (not included), which can

be obtained at a pool and spa supply store. The pH reading should be between 7.2 and 7.8.

If the level is too low, add half of one of the “QUICK pHix It UP” packets to the water. Let the water circulate through the spa jet unit for five minutes. Test the pH level again. Repeat until the pH level is correct.

If the level is too high, add half of one of the “QUICK pHix It DOWN” packets to the water. Let the water circulate through the spa jet unit for five minutes. Test the pH level again. Repeat until the pH level is correct.

Replace the spa cover and allow the water to continue to heat.

See WATER CHEMISTRY on page 15 for information concerning proper water maintenance.

SECURING THE SPA COVER

The spa cover can be secured by snapping the latches on the spa cover into the buckles on the side panels.

The buckles can be locked by inserting the key and turning it clockwise a quarter turn. To unlock the buckles, insert the key and turn it counter-clockwise a quarter turn.

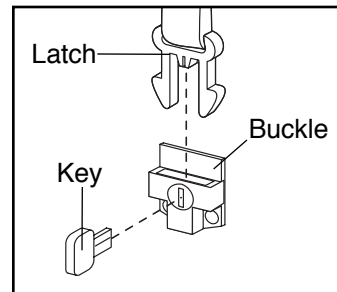

Always keep the buckles locked when the spa is not in use. Keep the keys in a safe place, out of the reach of children.

DIAGRAM OF THE CONSOLE

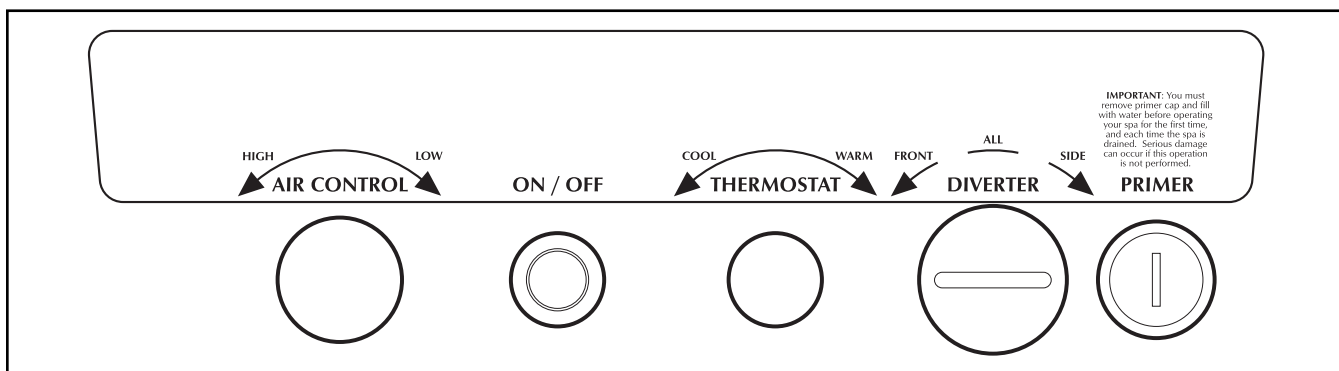

USING THE CONSOLE

Refer to the console diagram above. The function of each console control is explained below:

Air Control: Determines the amount of air that is in the spa jet system during operation. If the control is turned to the left, the amount of air flowing through the jets will increase. If the control is turned to the right, the amount will decrease.

On/Off: Turns the spa jet unit on and off. To turn the spa jet unit on, press the control once. To turn the spa jet unit off, press the control twice. After you press it once, the spa jet unit will shut off for about 30 seconds, and restart. Press the control again. The spa jet unit will remain off for three hours, at which time it will begin running the filter cycle. At any time after the spa jet unit has been shut off, the pump will begin cycling the water if the temperature falls below the minimum setting. Note: To keep the filter and heat cycles from running, the power cord must be unplugged.

Thermostat: Controls the temperature of the water. The water heats at about 1.5°F an hour with the cover on. The thermostat can be set to heat the water from 70°F to 104°F. You should use a medical or other accurate thermometer to check the temperature of the water.

Diverter: Controls the flow of water through the hydro-therapy jets and the whirlpool diverter. The direction of the flow can be adjusted by turning the diverter control. When the control is set to “front,” the flow will be through the hydro-therapy jets; when it is set to “side,” the flow will be through the whirlpool diverter; when it is set to “all,” the flow will be evenly distributed through both the hydro-therapy jets and the whirlpool diverter.

Primer: This opening allows you to prime the spa jet unit before operation (see PRIMING THE SPA JET UNIT on page 12).

SPA JET UNIT OPERATION

The spa jet unit features five hydro-therapy jets, a whirlpool diverter, a suction vent, and a filter housing.

The **five hydro-therapy jets (A)**, located on the front of the spa jet unit, focus the water massage on your neck and back.

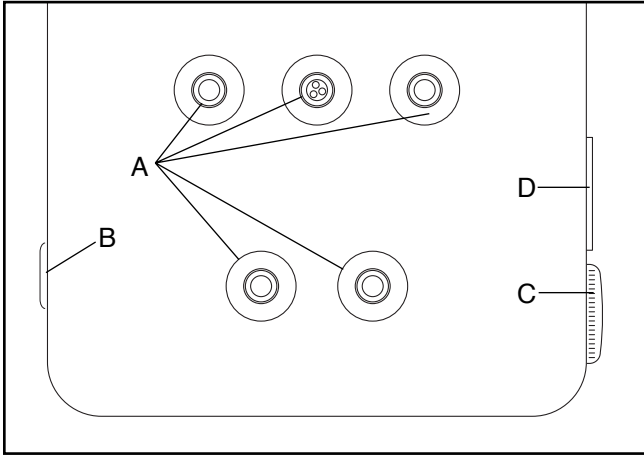

The **whirlpool diverter (B)**, located on the left side of the spa jet unit, directs the flow of the water to create a whirlpool action in the DAYBREAK.

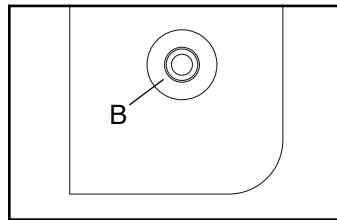

The **suction vent (C)**, located on the right side of the spa jet unit, pulls the water into the spa unit, in order to operate the system. The suction cover should always be in place over the suction vent. **Never operate the DAYBREAK without the suction cover in place.**

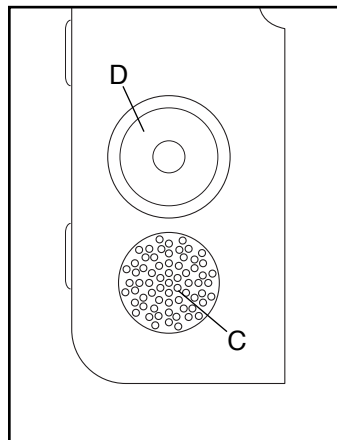

The **filter housing (D)**, also located on the right side of the spa jet unit, and filter can be removed for cleaning and replacement by pulling the fitting from the spa jet unit.

The spa jet unit features an automatic filter cycle and freeze protection. If the spa jet unit has not been operated for three hours, the pump will begin circulating the water for twenty minutes to filter any impurities. Also, if the water temperature falls below 40°F, the pump will begin circulating and heating the water to prevent the water from freezing.

DRAINING THE DAYBREAK

To drain the DAYBREAK, you must use a garden hose to siphon the water. Place one end of the hose in the DAYBREAK and hold it in front of a hydro-therapy jet until there is a flow of water coming out of the hose. **Turn off the spa unit and unplug the power cord. The unit will be damaged if it is run without water circulating.** Be sure the end of the hose in the DAYBREAK is on the floor of the spa.

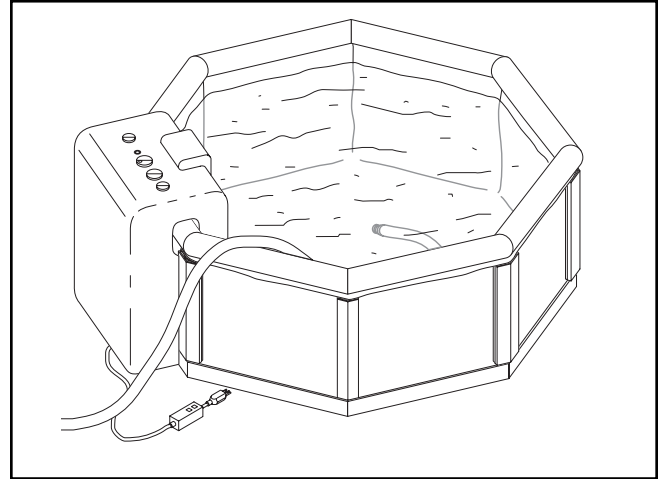

DRAINING THE PUMP

After the DAYBREAK is drained (see DRAINING THE DAYBREAK above), the pump in the spa jet unit should also be drained if the DAYBREAK will be stored for more than thirty days, or if it may be exposed to freezing temperatures.

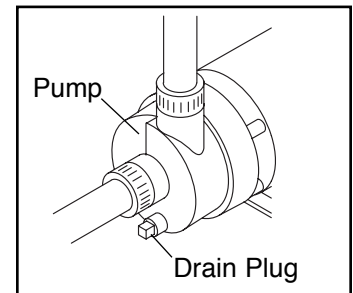

To drain the pump, remove the spa jet unit from the side panels. **Be careful not to tear the spa liner.** Locate the pump inside the spa jet unit. Remove the indicated bolt from the pump. Tip the spa jet unit slightly, until all the water has drained from the pump. Replace the drain plug.

MAINTENANCE

CLEANING THE SPA LINER

The liner should be cleaned with a mild soap solution. Do not use solvents. The liner should always be clean and dry before being moved or stored.

CHECKING AND CLEANING THE FILTER

The filter should be checked periodically for build-up of dirt and oil. If the filter needs to be cleaned, follow the steps below:

1. Turn off the power.
2. Remove the filter from the spa jet unit by pulling the white filter from the side of the spa jet unit.
3. Check the filter for any dirt or debris. If the filter needs to be cleaned, rinse the filter with a hose. If the filter still is dirty, you will need to soak it in a cleaning solution which can be obtained from a pool and spa supply store.
4. Inspect the filter for damage. Replace the filter if there are any signs of damage.
5. Re-insert the cleaned filter into the spa jet unit.

MAINTAINING THE SPA COVER

The spa cover should be cleaned monthly. To clean the spa cover, hang it over a clothes line and spray it with a hose. Leave the cover on the clothes line until it is fully dry.

WINTER USE AND CARE

The DAYBREAK is designed for year-round use. If you decide to store the DAYBREAK for the winter, store it in a warm, dry location. (See DRAINING THE DAYBREAK and DRAINING THE PUMP on page 14.)

WATER CHEMISTRY

The DAYBREAK comes with a starter chemical pack for maintaining the water in the spa. (See TESTING AND TREATING THE WATER on page 12.) Additional chemicals can be purchased at a pool and spa supply store.

CAUTION: The chemicals used to maintain the pH balance of the water and to sanitize the water can be dangerous. Always follow these basic guidelines when handling the chemicals:

1. **Always read and follow the directions on the label, unless directed otherwise.**
2. **Never mix different chemicals.**
3. **Do not exceed the recommended amounts—follow the directions on the label closely.**

4. **Keep all chemicals out of the reach of children and pets.**
5. **Keep all containers closed tightly when not in use.**
6. **Never add water to the chemicals—always add the chemicals to the water as directed.**
7. **Always store chemicals in a cool, dry place.**
8. **Always keep chemicals away from children and pets.**

MAINTAINING THE PROPER PH BALANCE

The pH factor is a measure of relative acidity or alkalinity in the water. It is measured on a scale of 1 to 14. Pure water has a value of 7, which is neutral. Any value above 7 is alkaline, and any value below 7 is acidic. You should maintain a slightly alkaline pH level, between 7.2 and 7.8, in the DAYBREAK.

Severe problems can occur when the pH balance is not maintained within this range. If the pH level exceeds 7.8, dissolved minerals can build-up and clog the plumbing in the spa jet unit. If the pH level falls below 7.2, the acid level in the water will begin to corrode the metal parts in the spa jet unit. Also, the sanitation agents in the water will not be effective if the pH level is not properly maintained. Damage caused by improper pH levels is not covered under the warranty.

To maintain the proper pH level, you should test the pH of the water regularly. You will need a pH test kit (not included), which can be obtained at a pool and spa supply store. The pH reading should be between 7.2 and 7.8. If the level is too low, add a pH increaser (usually soda ash). If the level is too high, add a pH reducer (usually sodium bisulfate). Test the water again after five minutes. See the instructions with your pH test kit for additional information about testing and adjusting the pH.

SANITIZING THE DAYBREAK

Please refer to your local pool and spa supplier for information concerning which chemicals you should use in your area to sanitize the spa.

The most common sanitizing agent is a solid bromine concentrate. The amount required varies according to several factors, such as user load, temperature, water conditions, and so forth.

Proper water maintenance is a fairly complex process. We recommend that you contact your local pool and spa supplier for information on how you should best accomplish this.

TROUBLE-SHOOTING

Most problems can be solved by following the simple steps below. Find the symptom that applies, and follow the steps listed. If further assistance is needed, call our Customer Service Department toll-free at 1-800-999-3756, Monday through Friday, 6 a.m. until 6 p.m. Mountain Time.

1. SYMPTOM: THE SPA WILL NOT OPERATE

- a. Check the power cord. The power cord must be plugged into a grounded outlet (see PLUGGING IN THE DAYBREAK on page 12).
- b. Check to see if the GFCI breaker is tripped, or was not turned on. Reset the GFCI breaker.

2. SYMPTOM: THE CIRCUIT BREAKER OR GFCI BREAKER TRIPS WHILE THE SPA IS OPERATING

- a. Reset the circuit breaker. If the circuit breaker trips again, contact a qualified electrician for service.

3. SYMPTOM: THE PUMP HUMS

- a. The filter may be dirty or damaged. Remove the filter housing from the spa jet unit and clean or replace the filter.
- b. The pump may have a foreign object stuck in the impeller. Contact our customer service department or a local spa and pool service provider.
- c. The pump may have a loose wire connection. Contact our customer service department or a local spa and pool service provider.

4. SYMPTOM: THE PUMP HUMS BUT DOES NOT ROTATE

- a. The pump may be jammed. Contact our customer service department or a local spa and pool service provider.

5. SYMPTOM: THE PUMP IS NOISY WHILE OPERATING

- a. There may be debris in the pump. Contact our customer service department or a local spa and pool service provider.
- b. The pump may have a bad bearing. Contact our customer service department or a local spa and pool service provider.

6. SYMPTOM: THE WATER DOES NOT HEAT

- a. The pump in the spa jet unit is the heater. If the pump is operating, the water should heat. Cover the DAYBREAK with the spa cover. **The spa cover must be tight.** Set the air control to low. The water will heat at a rate of 1.5°F an hour. If you are using the DAYBREAK indoors, and the room temperature is maintained at 70°F, it will take approximately 36 to 48 hours for the water to reach the set temperature.
- b. If you are using the DAYBREAK outdoors, it may take longer for the water to heat. See the chart below for the approximate heating time.

<u>Air Temperature</u>	<u>Heating Time</u>
70°F +	36 to 48 hours
50°F–70°F	2 to 4 days
30°F–50°F	4 to 6 days

If the water still has not heated after six days, contact our customer service department or a local spa and pool service provider.

7. SYMPTOM: THE WATER PULSATES OR THERE IS MINIMUM WATER FLOW

- a. Adjust the water level. This usually occurs only when the water level is low. Add water until the filter and jets are covered.

8. SYMPTOM: THE SPA JET UNIT CAVITATES DURING USE

- a. This problem is caused by excess air in the pump circulation system. Check to see if the primer cap is fully tightened. Prime the pump again and fully tighten the primer cap (see PRIMING THE SPA JET UNIT on page 12).

9. SYMPTOM: THE WATER IS NOT BEING CLEANED BY THE FILTER

- a. Check to see if the filter is in place. Clean the filter if it is dirty.
- b. Check the chemical balance of the water. If the pH is incorrect, the sanitizing agents will not function properly.

10. SYMPTOM: THE SPA JET UNIT CONTINUES TO RUN AFTER IT HAS BEEN SHUT OFF

- a. To turn the spa jet unit on, press the ON/OFF control once. To turn the spa jet unit off, press the control twice. After you press it once, the spa jet unit will shut off for about 30 seconds, and restart. Press the control again. The spa jet unit will remain off for three hours, at which time it will begin running the filter cycle. At any time after the spa jet unit has been shut off, the pump will begin cycling the water if the temperature falls below the minimum setting.

11. SYMPTOM: THE WATER LEVEL DROPS

- a. Some water loss due to evaporation is normal. If rapid water loss occurs, or if you notice wetness on the floor around the DAYBREAK, then the liner may have a leak. Locate the leak, and patch it using a pool patch kit that you can purchase at any pool and spa supply store.

- b. A clamp or seal inside the spa jet may be loose. Check the floor around the spa jet unit for excess water, and watch the spa jet unit while it is operating to see if water drips from the spa jet unit housing. If you can identify the location of the leak inside the spa jet unit, tighten the clamp or replace the damaged seal.

12. SYMPTOM: THERE ARE WRINKLES IN THE LINER

- a. Drain the water from the DAYBREAK, until the water level is below the wrinkles. Smooth out any wrinkles that you can see. Begin to refill the DAYBREAK. Be sure to check for new wrinkles that may form in the spa liner as the water begins to cover the bottom. Smooth out any wrinkles toward the sides, and then smooth the wrinkles to the top. It is normal to have some wrinkles around the spa jet unit.

WIRING DIAGRAM

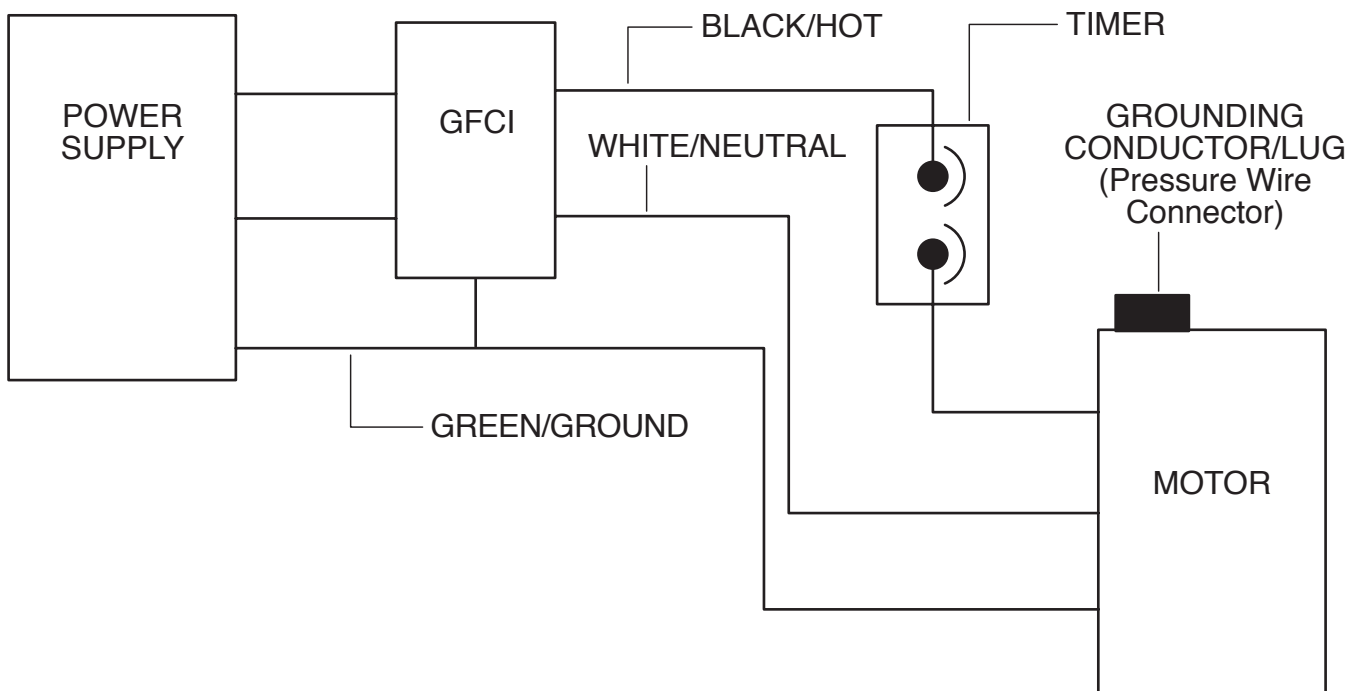

See the manufacturer’s wiring diagram on the pump motor for more information.

PART LIST—Model No. SPRW52461

R0497A

Key No.	Qty.	Description	Key No.	Qty.	Description
1	8	Side Panel	20	1	Pump Motor
2	8	Floor Cap	21	7	Buckle
3	8	Angle Bracket	22	1	Heat Controller
4	64	Bracket Screw	23	14	Buckle Screw
5	16	Side Bracket	24	1	Heat Sensor
6	8	Bracket Connector	25	1	Electronic Control
7	4	Bolt	26	1	Tri-jet Nozzle
8	1	Insulated Floor Cover	27	1	Headrest
9	1	Spa Liner	28	4	Fastener
10	4	Spa Jet Nozzle	29	1	Trim
11	1	Spa Cover	30	4	Rubber Insulator
12	7	Edge Protector	31	4	Washer
13	1	Spa Jet Unit	32	1	Whirlpool Diverter
14	1	Small Edge Protector	33	1	Rubber Damper
15	1	Support Ball (Set)	34	4	Nut
16	1	Filter	#	2	Key
17	1	Cover Screw	#	1	Allen Wrench
18	1	Suction Cover	#	1	Starter Chemical Pack
19	1	Suction Fitting	#	1	User's Manual

Note: “#” indicates a non-illustrated part. Specifications are subject to change without notice.

EXPLODED DRAWING—Model No. SPRW52461

R0497A

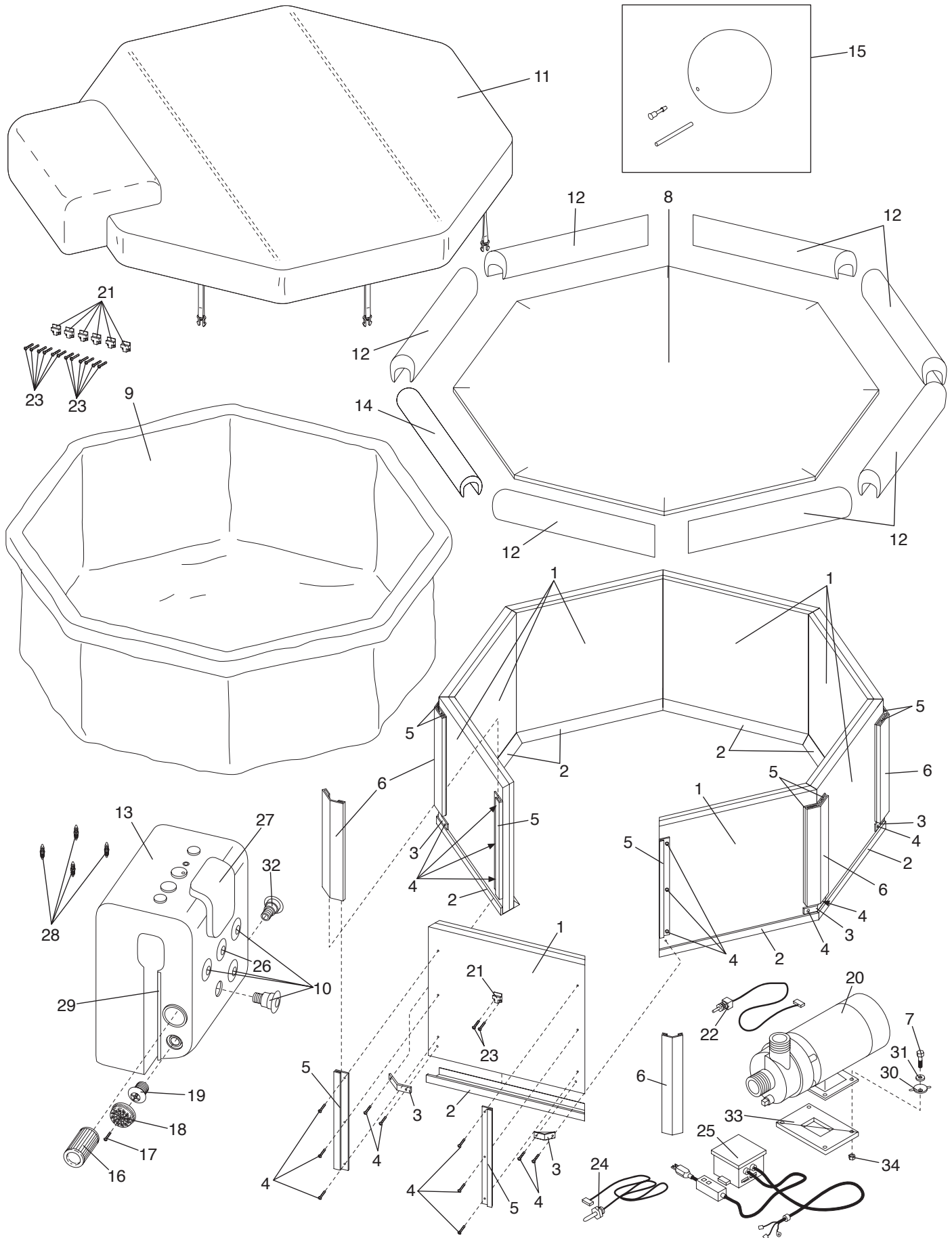

ORDERING REPLACEMENT PARTS

To order replacement parts, simply call our Customer Service Department toll-free at 1-800-999-3756, Monday through Friday, 6 a.m. until 6 p.m. Mountain Time (excluding holidays). To help us assist you, please be prepared to give the following information when calling:

1. The MODEL NUMBER of the product (SPRW52461).
2. The NAME of the product (DAYBREAK by WESLO®).
3. The SERIAL NUMBER of the product (see the front cover of this manual).
4. The KEY NUMBER and DESCRIPTION of the desired part(s) (see the PART LIST on page 18 of this manual).