

FLEX CTS

CROSS TRAINING SYSTEM



**WORKOUT
TRAINING
MANUAL**



FLEX CTS

WESLO

A good name to know in home fitness

Of the many ways to shape and tone your body, resistance training is the most complete and direct. The stepper provides a great way to improve your cardiovascular system, train your legs and help release tension. The **FLEX Cross Training Program** enables you to isolate and exercise specific muscles in every area of the body, making it the most economical way to achieve the greatest results in the shortest length of time.

There are four kinds of programs:

1. Building

In order to build your muscles and gain strength, you have to progressively increase the resistance so that the muscles will continue to adapt. When you are training to build your muscles and grow in size, your resistance level should never get easy. All that counts is that you are forcing the muscles to work hard enough to make them adapt. Following are some basic suggestions: If you want to build your muscles, you need to increase your load progressively. Do three sets of 8 to 12 repetitions until you can complete three sets of 12. Then you should increase the resistance. When you have reached the muscle size you want to maintain, stop adding resistance.

2. Toning

If you simply want to tone your muscles, you should use a moderate amount of resistance and increase the number of repetitions in each set. Do as many sets of 15 to 20 repetitions as you feel you can comfortably handle.

3. Losing Weight

For losing weight, a light resistance level should be used to tone your body, and more repetitions of each exercise to increase the amount of calories burned. At least 20 minutes of aerobic exercise on the stepper three times per week will also help shed extra pounds.

4. Cross Training

In the pursuit of total body fitness many have found that cross training is the key to a healthy, well balanced fitness program. Our program suggests that on Monday, Wednesday and Friday you do one exercise from the following groups: Abdomen, Arms, Back, Calves and Thighs, Chest, Neck and Shoulders. Then you should allow your muscles to rest one full day by using the stepper on Tuesday and Thursday to increase your cardiovascular endurance. By combining the weight training program and the stepper you can reshape and change your body plus develop a stronger heart and lungs.

Personalize Your Program

We have not specified the exact length of time or number of repetitions for each exercise. It is up to you to gauge your limits. It is very important to start easy and increase both your total time and number of repetitions each week. We have provided a chart for you to keep track of the exercises and the number of repetitions and sets you are doing. Simply copy the chart provided on page 18 and jot the figures down on your chart each day. Overdoing it in the beginning will cause unnecessary soreness. If at any time you feel excessive pain, stop and find out what is wrong before continuing. Rest is very important in helping your muscles tone and develop. To maximize exercise effectiveness, we recommend resting the muscles one full day before exercising them again.

Warming Up

Begin each exercise session with a 5 to 15 minute warm-up period. It is important to slowly increase your heart rate and pump blood out to your muscles where it will be needed. Start by stretching all your limbs:



Reach for the sky 8 times with each arm.

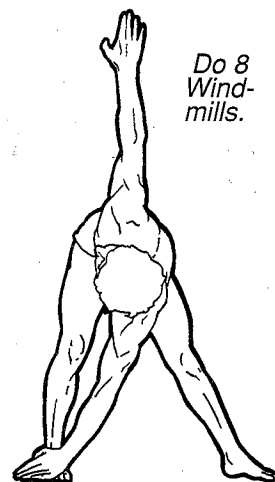

Do 8 Wind-mills.

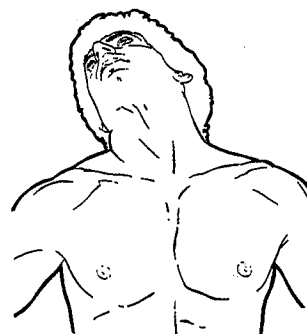

Rotate your neck 4 times in each direction.



Run in place for 20 seconds.

CONSULT YOUR DOCTOR BEFORE BEGINNING THIS OR ANY OTHER REGIMEN OF EXERCISE.

Exercise Form

It is essential that you maintain proper form while exercising. On the following pages of this manual you will find each exercise illustrated, demonstrating correct form and showing the areas of the body that will benefit. The repetitions in each set should follow one another smoothly without pausing in between. It may take time to become flexible enough to maintain a steady rhythm. Maintaining form means moving over the full range of the exercise motion as shown in the manual and only moving the parts of the body that should be moved in the exercise. You should take the first two weeks to familiarize yourself with the **FLEX CTS** and learn the proper form required for each exercise. Exercise done in an indefinite pattern will drain your energy and leave you feeling exhausted.

Working Out

Each workout requires only 30 minutes, and should include 6-10 different exercises. It is also important to rest about 60-90 seconds between each set. To make the most of your workout you should learn to breathe properly during exercise. The basic rule is to exhale as you encounter the most resistance and inhale when you encounter the least resistance. Schedule your workout for the time of day when your energy level is highest. Once you find the right schedule for you, stick to it.

Stretches

End each exercise session with some stretching movements. Stretching should not be stressful and should be done in a manner that is as relaxed as possible. It is very important to go into a stretch gradually and only as far as you can go without strain. Hold each stretch 20 to 40 seconds. Repeat 8 times on each side for a total body stretch.

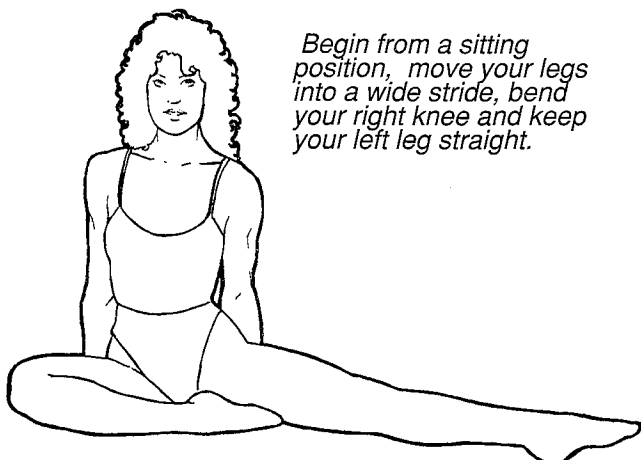

Begin from a sitting position, move your legs into a wide stride, bend your right knee and keep your left leg straight.



Gradually grasp your left leg with both hands and pull your head down to touch your left knee.

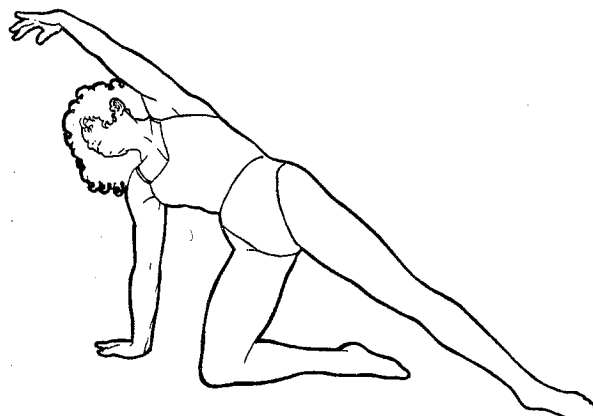

Reach your left hand over your head and put your right hand on the floor next to your right knee and stretch your left arm over your head.

Safety

Your **FLEX CTS** is a tool, and learning to use it properly is very important to your personal safety and the success of your program. Read through your owner's manual carefully before using the equipment. It is important to make sure that the lock knob is always firmly in place. before

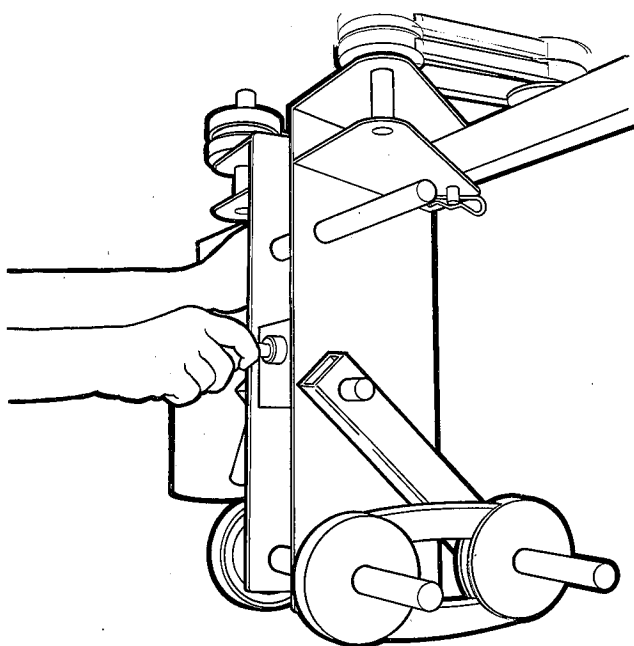

Suggested workout for **Monday, Wednesday, Friday.**

Do one exercise from each of the following groups:

- Abdomen,**
- Arms,**
- Back,**
- Calves and Thighs,**
- Chest,**
- Neck and Shoulders.**

Suggested workout for **Tuesday, Thursday.**

The stepper provides a good workout for the heart and lungs as well as working the calves.

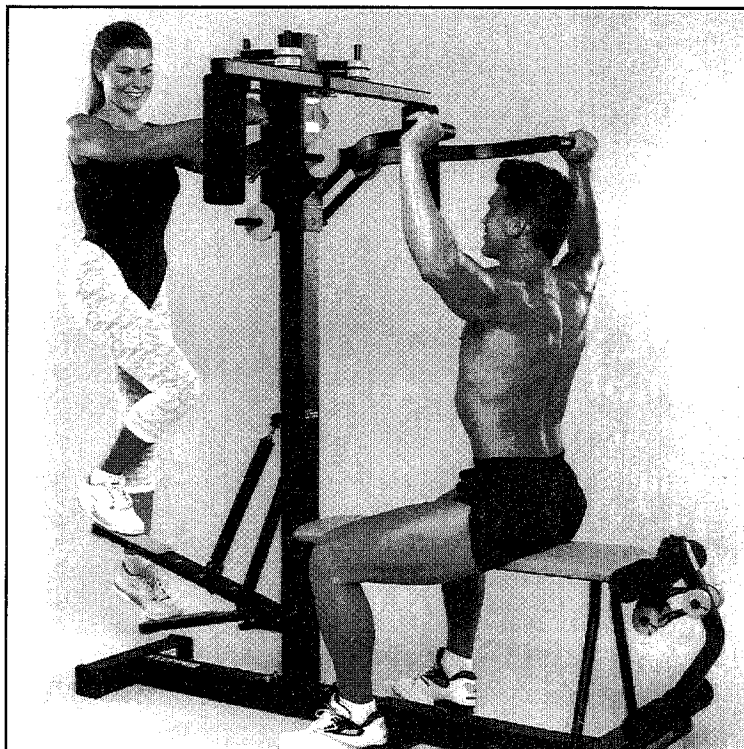

EXERCISE DATE RESISTANCE REPS SETS

MONDAY

EXERCISE	DATE	RESISTANCE	REPS	SETS

**TUESDAY
WEDNESDAY**

STEPPER

**THURSDAY
FRIDAY**

STEPPER

Exercise Form

It is essential that you maintain proper form while exercising. On the following pages of this manual you will find each exercise illustrated, demonstrating correct form and showing the areas of the body that will benefit. The repetitions in each set should follow one another smoothly without pausing in between. It may take time to become flexible enough to maintain a steady rhythm. Maintaining form means moving over the full range of the exercise motion as shown in the manual and only moving the parts of the body that should be moved in the exercise. You should take the first two weeks to familiarize yourself with the **FLEX CTS** and learn the proper form required for each exercise. Exercise done in an indefinite pattern will drain your energy and leave you feeling exhausted.

Working Out

Each workout requires only 30 minutes, and should include 6-10 different exercises. It is also important to rest about 60-90 seconds between each set. To make the most of your workout you should learn to breathe properly during exercise. The basic rule is to exhale as you encounter the most resistance and inhale when you encounter the least resistance. Schedule your workout for the time of day when your energy level is highest. Once you find the right schedule for you, stick to it.

Stretches

End each exercise session with some stretching movements. Stretching should not be stressful and should be done in a manner that is as relaxed as possible. It is very important to go into a stretch gradually and only as far as you can go without strain. Hold each stretch 20 to 40 seconds. Repeat 8 times on each side for a total body stretch.

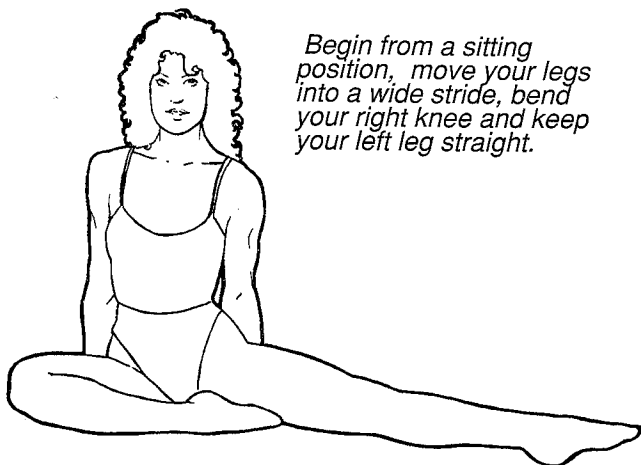

Begin from a sitting position, move your legs into a wide stride, bend your right knee and keep your left leg straight.

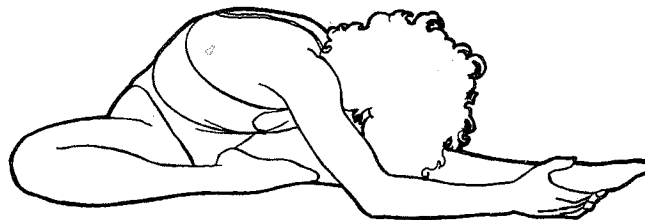

Gradually grasp your left leg with both hands and pull your head down to touch your left knee.

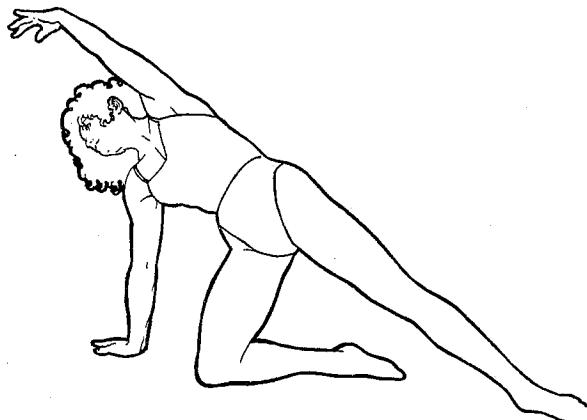

Reach your left hand over your head and put your right hand on the floor next to your right knee and stretch your left arm over your head.

Safety

Your **FLEX CTS** is a tool, and learning to use it properly is very important to your personal safety and the success of your program. Read through your owner's manual carefully before using the equipment. It is important to make sure that the lock knob is always firmly in place. before

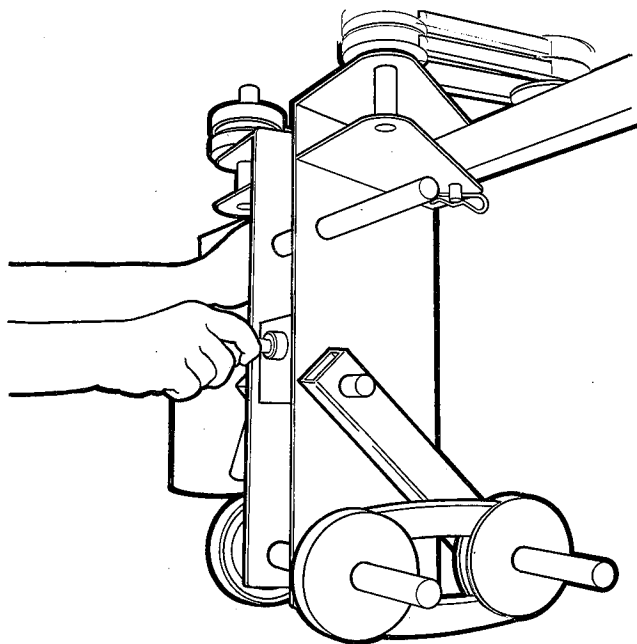

Suggested workout for
Monday, Wednesday, Friday.

Do one exercise from
each of the following groups:

- Abdomen,**
- Arms,**
- Back,**
- Calves and Thighs,**
- Chest,**
- Neck and Shoulders.**

Suggested workout for
Tuesday, Thursday.

The stepper provides a
good workout for the heart
and lungs as well as working
the calves.

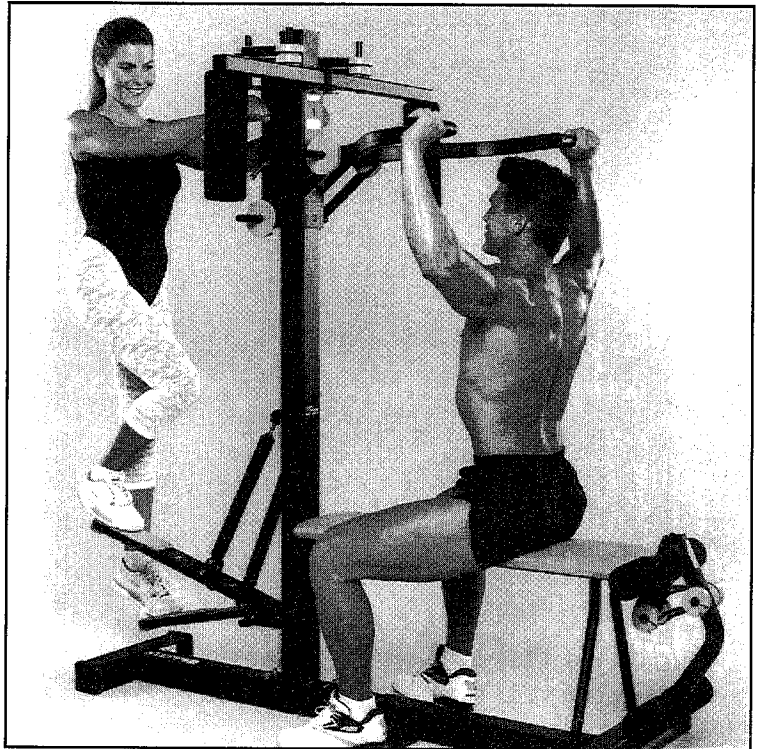

EXERCISE DATE RESISTANCE REPS SETS

MONDAY

EXERCISE	DATE	RESISTANCE	REPS	SETS

**TUESDAY
WEDNESDAY**

STEPPER

**THURSDAY
FRIDAY**

STEPPER

Abdomen

Alternate Leg Bend (23)
Abdominal Crunch (24)
Vertical Knee Raise* (25)
Incline Sit-up (22)

Arms

Reverse Military (21)
Dip (6)
Incline Bench Press (9)
Incline Push-up (12)
Lat Pull Down (4)
Wide Grip Chin* (11)
Military Press (1)
Undergrip Close Hand
Chin* (10))
Reverse Curl (14)
Seated Curl (2)
Triceps Extension (8)
Triceps Press (5)
Triceps Press Down (3)
Standing Curl (13)
Upright Row (7)
Bent Over Row (19)

Back

Bent Over Row (19)
Dead Lift (20)
Frontal Squat (18)
Squat (30)

Thigh

Dead Lift (20)
Frontal Squat (18)
Leg Extension (29)
Leg Press (32)
Squat (30)
Stepper (26)
Standing Single Leg Curl (31)

Chest

Bench Press (16)
Butterfly (17)
Dip (6)
Incline Bench Press (9)
Incline Push-up (12)
Military Press (1)

Calves

Calf Raise (27)
Stepper (26)
Toe Press (28)
Standing Single Leg Curl (31)

Neck/Shoulder

Dip (6)
Military Press (1)
Shoulder Shrug (15)
Reverse Military (21)
Bent Over Row (19)
Bench Press (16)
Upright Row (7)

*These exercises require Locking Bands.

FLEX CTS

6 For personal home training, see page 19.

1

MILITARY PRESS

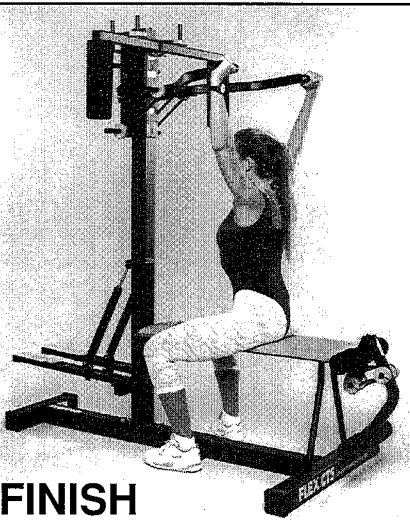
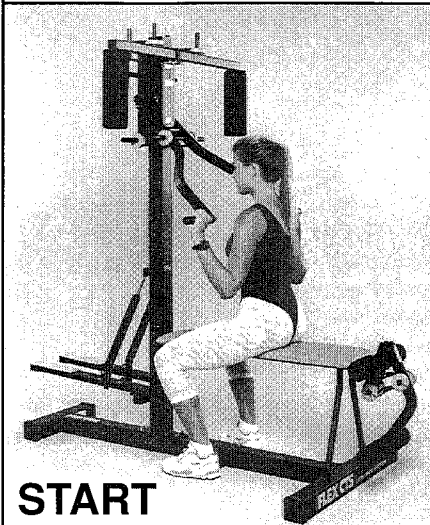

Sit on the bench facing the machine, position the bar at collarbone level. Fully extend arms upward, then return them to the starting position. Keep the back straight, feet flat on the floor.

Muscles worked:
Biceps, Pectorals, Triceps, Upper Deltoids.

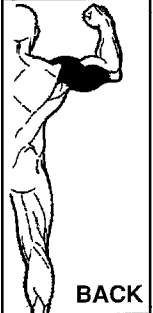
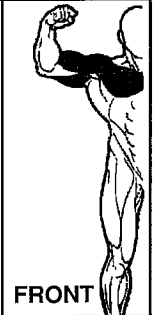

2

SEATED CURL

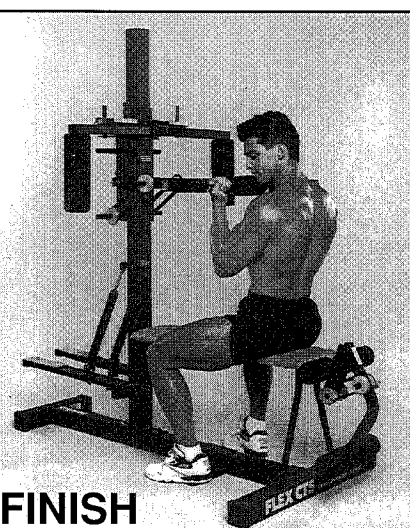
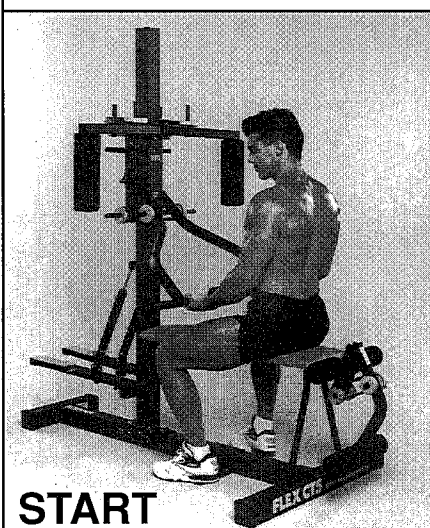

Sit on the bench facing the machine. Insert the lat bar into the main arm and position it at stomach level. Curl arms upward then back to the starting position. Keep your power stroke at an even pace. Don't jerk.

Muscles worked:
Biceps.

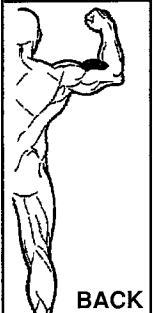
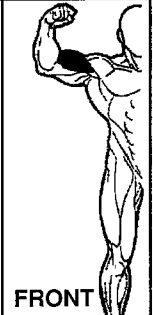

3

TRICEPS PRESS DOWN

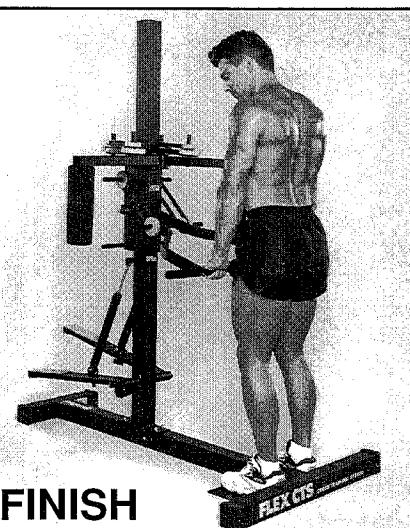
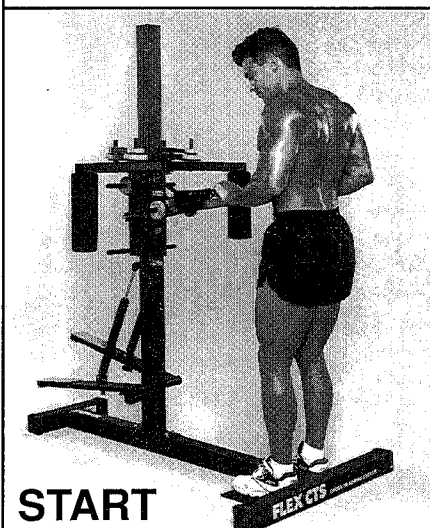

Insert the lat bar into the main arm. Stand on the foot plate and position the main arm so when your forearms are horizontal you can grasp the bar. Keep your elbows tight and extend your arms down, then slowly come back to the starting position. Don't cheat by letting your elbows move out.

Muscles worked:
Forearms, Triceps.

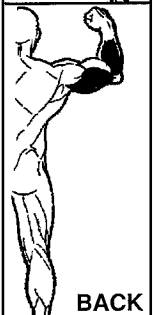

4

LAT PULL DOWN

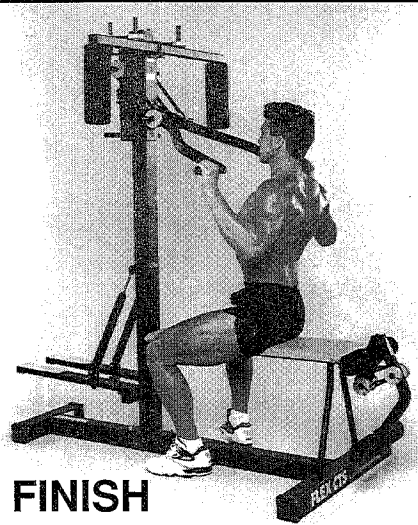
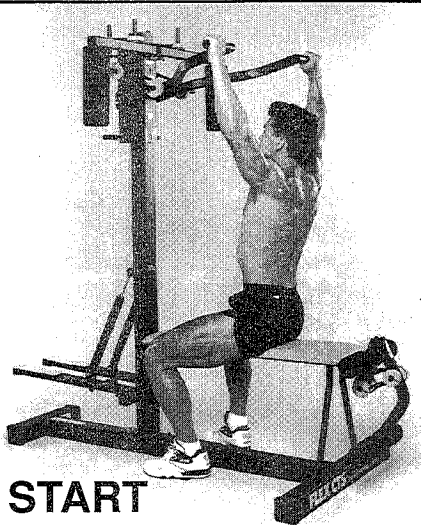

Sit on the bench facing the machine, as shown. Position the bands on the main arm so that you are pulling down, not pushing up. Grasp the main arm and pull down until your hands are at head level, then slowly return to the starting position.

Muscles Worked:
Biceps, Latissimus Dorsi.

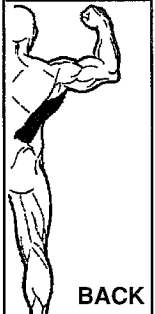

5

TRICEPS PRESS

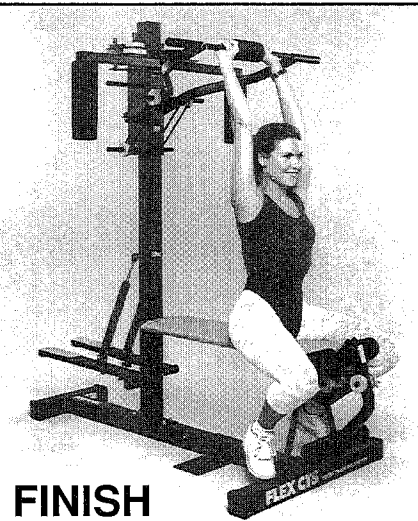
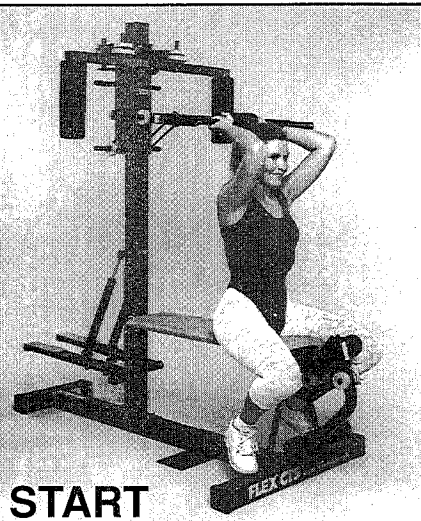

Sit on the bench facing away from the machine and grasp the lat bar with both hands. Extend your arms all the way up and return to the starting position.

Muscles worked:
Triceps.



6

DIP

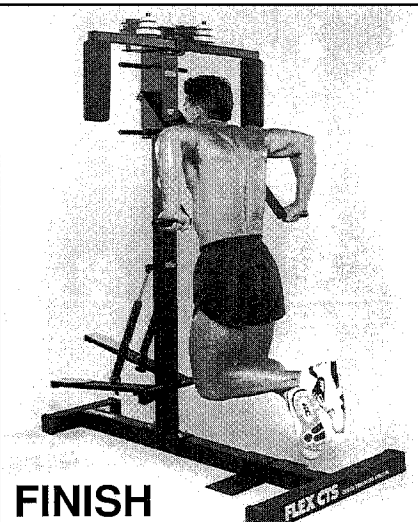
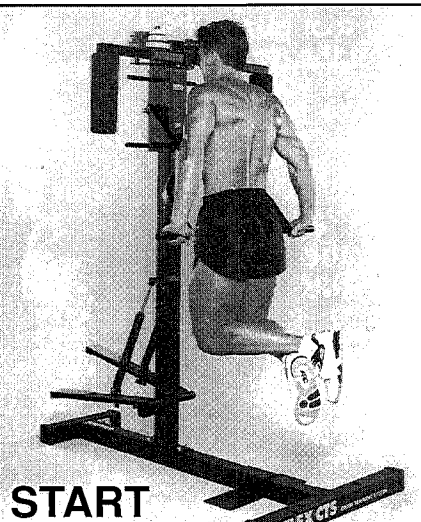

Remove the bench, leg extension and the lat bar. Grasp the main arm facing the machine and position yourself, as shown. Try to keep an even pace all the way up and down. This will be hard at first, and will take a while to build endurance.

Muscles worked:
Deltoids, Lower Pectorals, Triceps.



8

7

UPRIGHT ROW

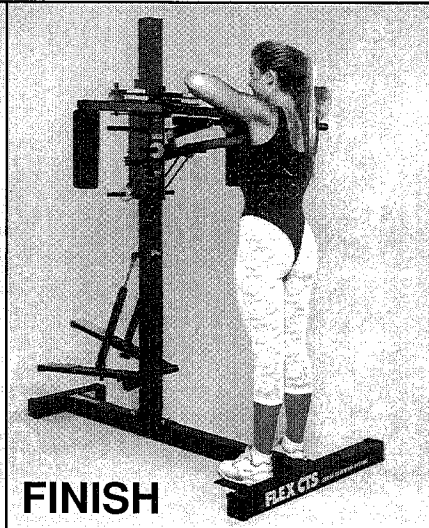
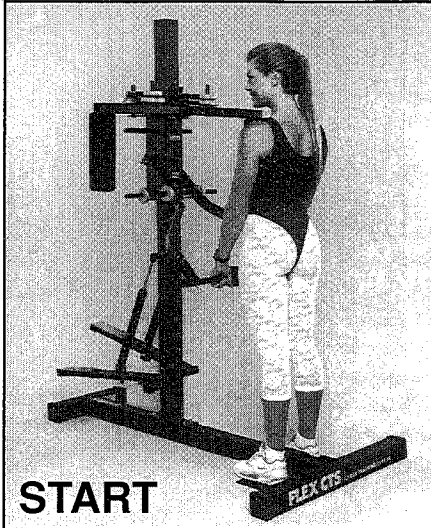

Take off the bench. Step onto the foot plate, grasp the lat bar in the middle with both hands touching. Pull up toward your chin and return to the starting position.

Muscles worked:
Biceps, Deltoids, Trapezius.

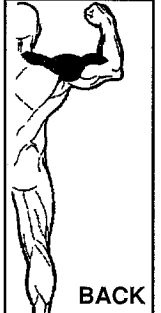
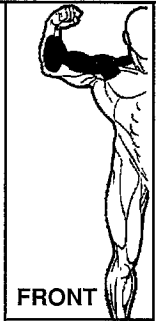

8

TRICEPS EXTENSION

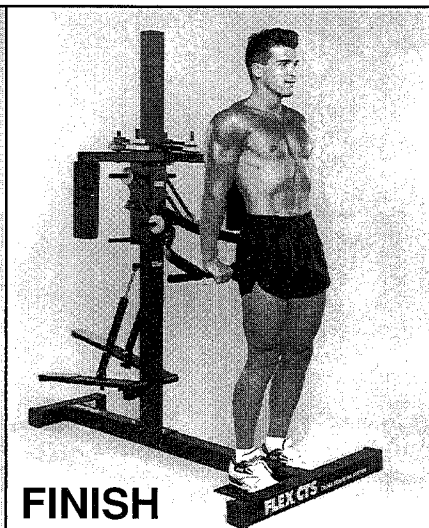
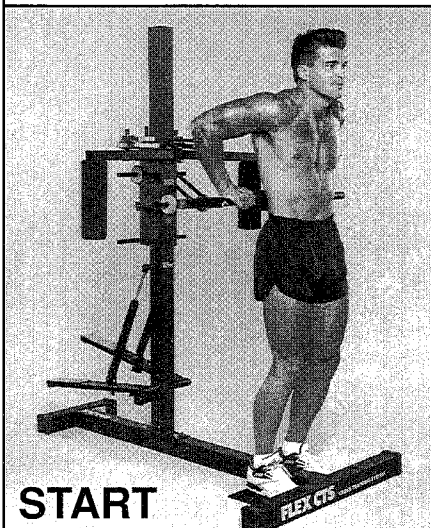

Remove the bench. Stand on the foot plate facing away from the machine. Grasp the lat bar and push down. Keep your elbows in.

Muscles worked:
Triceps.

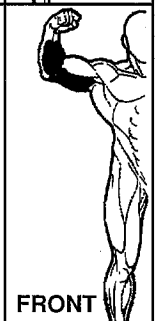

9

INCLINE BENCH PRESS

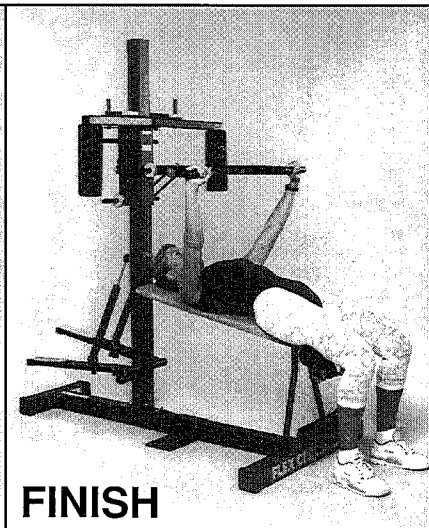
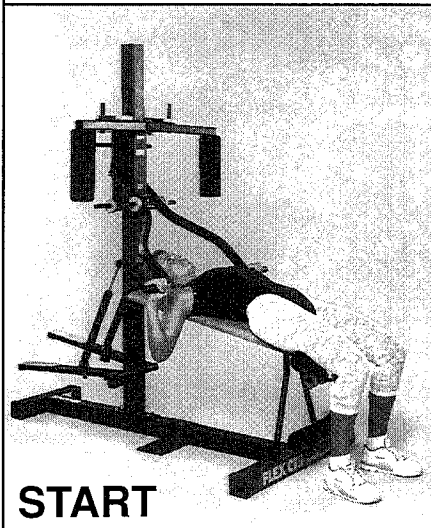

Remove the frame pin from the seat. Move the seat up to the hole just below where the shock connects to the main frame. Keep your elbows out parallel with the bar. Fully extend your arms upward, then return to the starting position. Make your chest do the work.

Muscles worked:
Deltoids, Triceps, Upper Pectorals.



10

UNDERGRIP CLOSE HAND CHIN*

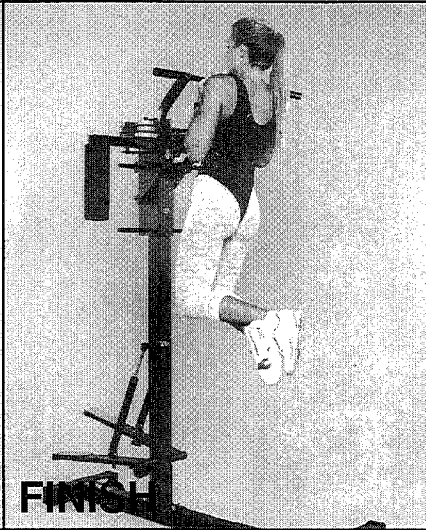
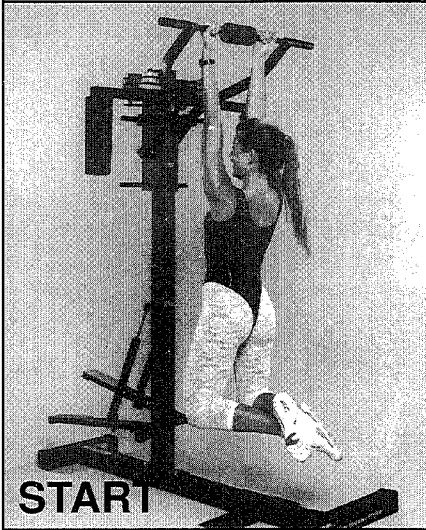

Remove the bench. Move the frame sleeve to the top position (make sure arm is securely locked in place). Extend the main arm up and attach the locking bands. Grasp the lat bar as shown, and pull yourself up. You can vary your grip from under to overhand.

Muscles worked:
Biceps, Deltoids,
Forearm,
Latissimus Dorsi.

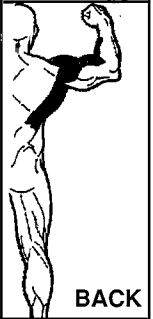
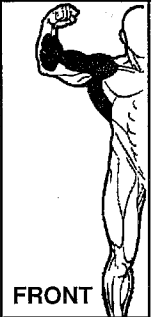

11

WIDEGRIP CHIN*

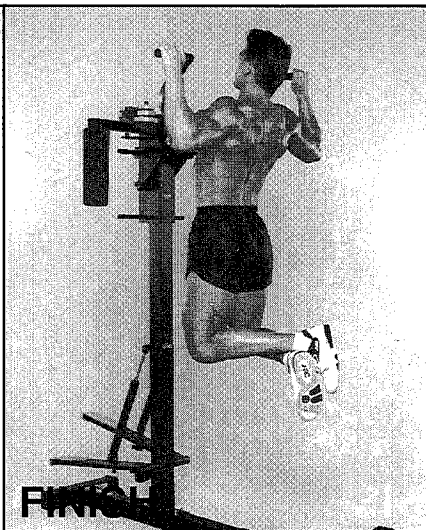
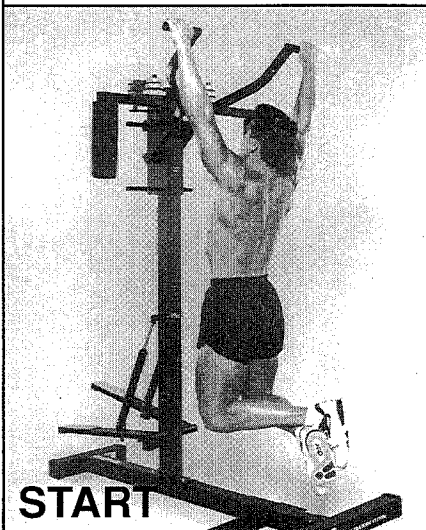

Remove the bench and the leg extension, move the main arm into the upward position and use the locking bands to hold into place. Grasp the main arm and bend your legs at the knees. Pull yourself up, then return to the starting position.

Muscles worked:
Biceps.

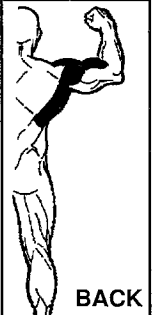

12

INCLINE PUSH-UP

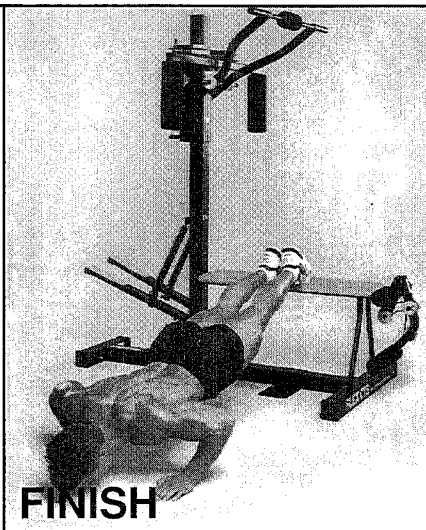
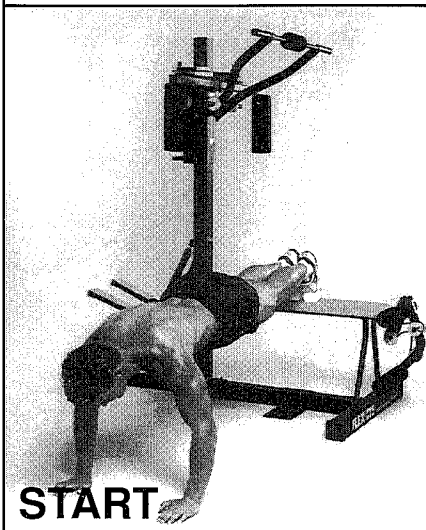

Place your feet on the bench, your hands on the ground, and go for it.

Muscles worked:
Pectorals, Triceps.

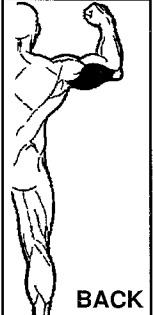
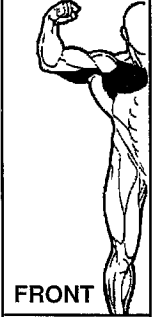

13

STANDING CURL

Remove the bench and stand on the foot plate. Grasp the main arm, curl your arms up toward your chest and slowly let them back down. Keep your back straight, your motion slow and don't rock.

Muscles worked:
Biceps.

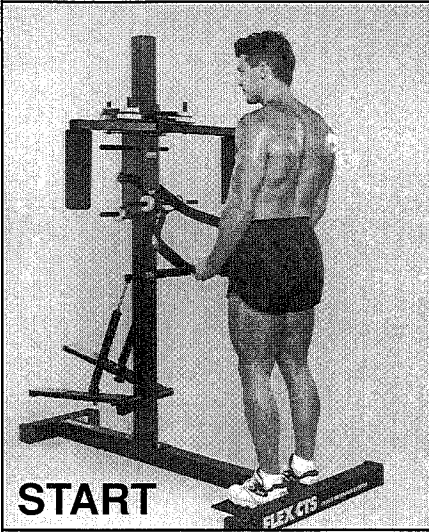

START

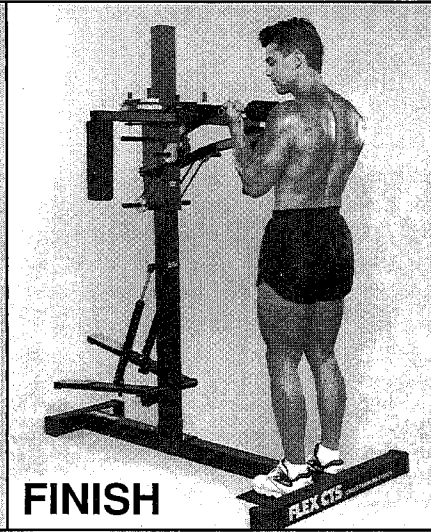

FINISH



FRONT

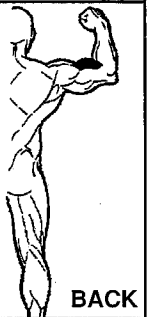

BACK

14

REVERSE CURL

Remove the bench, stand on the foot plate, and grasp the lat bar, as shown. Bending at the elbow, pull your arms up to your chest, then slowly let them back down. Keep your back straight and don't use a jerking motion.

Muscles worked:
Biceps, Forearm.

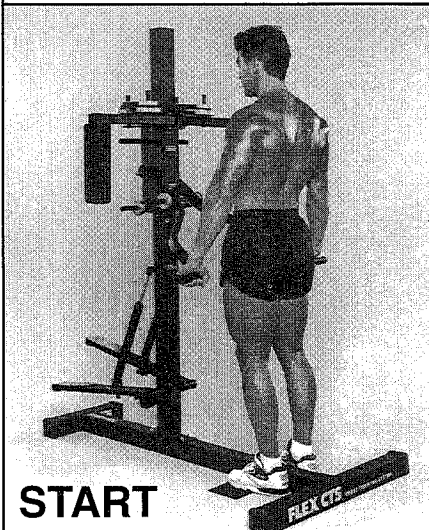

START

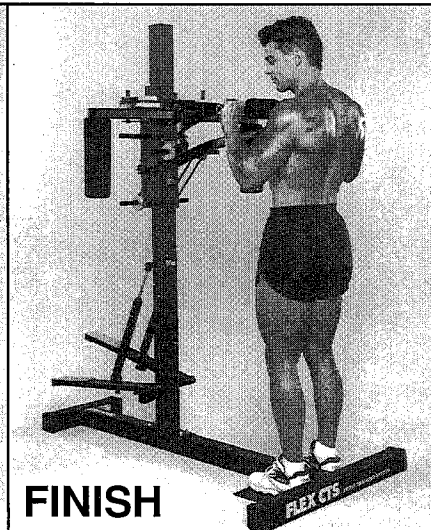

FINISH



FRONT



BACK

15

SHOULDER SHRUG

Take off the bench. Step on the foot plate, and grasp the main arm as shown. Keep your arms straight and move your shoulders up and down in a circular motion.

Muscles worked:
Deltoids, Trapezius.

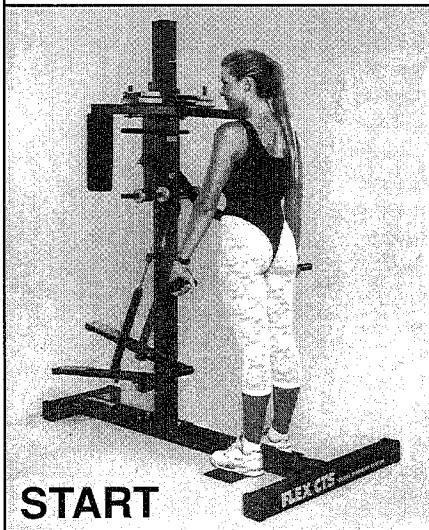

START

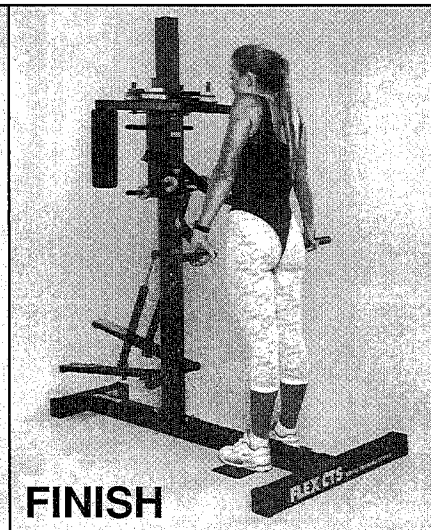

FINISH



FRONT



BACK

16

BENCH PRESS

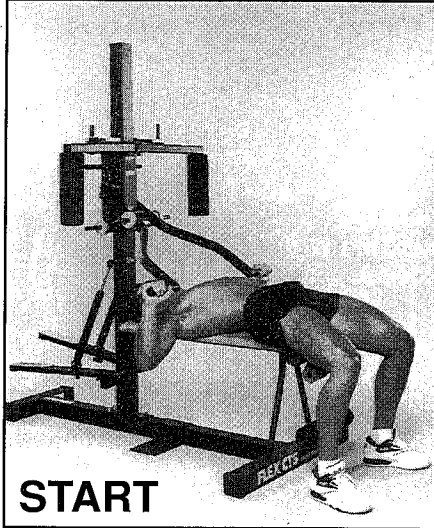

START

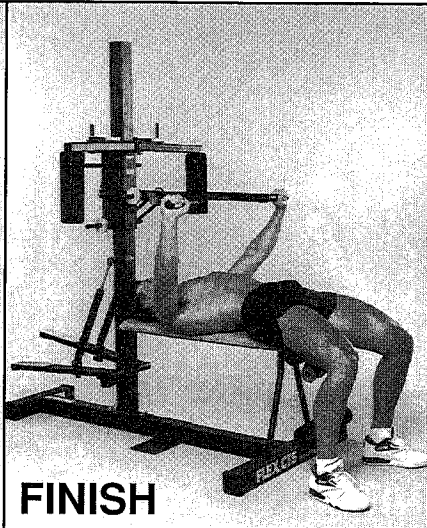

FINISH

Position yourself so the bar is at chest level. Keep your elbows out parallel with the bar. Fully extend your arms upward, then return to the starting position. Don't use your legs; make your chest do the work.
Muscles worked:
 Deltoids, Upper Pectorals.

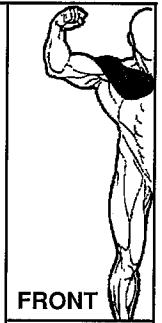

FRONT

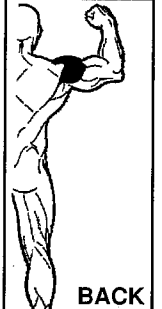

BACK

17

BUTTERFLY

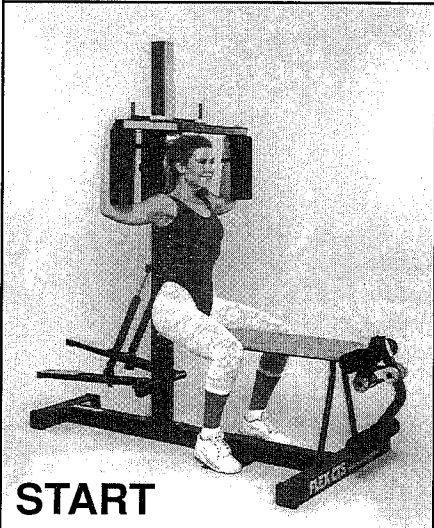

START

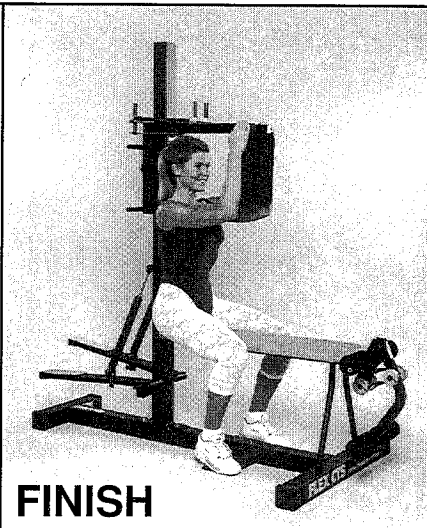

FINISH

Remove the main arm from the frame sleeve. Position the frame sleeve so that the butterfly arms are at least two inches above your head when you are seated on the bench. Sit on the bench facing away from the machine with your back against the main frame. Move arms forward toward each other then back to starting position.
Muscles worked:
 Upper and Inner Pectorals.

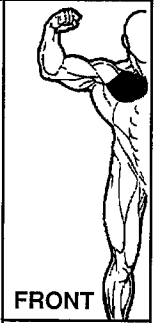

FRONT

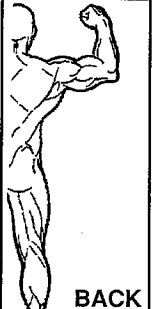

BACK

18

FRONTAL SQUAT

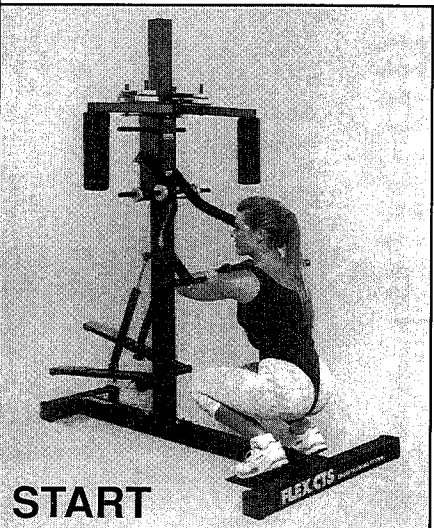

START

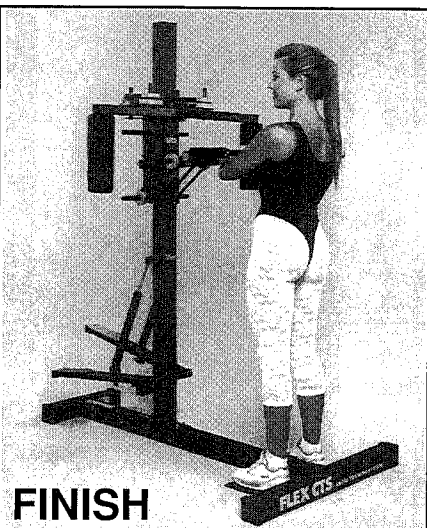

FINISH

Remove the bench and the leg extension and position yourself under the main arm, as shown. Stand on the foot plate and grasp the lat bar. Try to carry the load on your shoulders, not with your biceps. Extend yourself upward, then back to the starting position.
Muscles worked:
 Thighs, Glutes, Lower Back.



FRONT

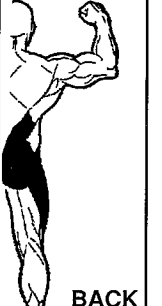

BACK

19

BENT OVER ROW

Adjust the frame sleeve so that when you are standing on the bench, as shown, you can grasp the main arm when your arms are extended downward. Pull the bar up toward your chest and return the bar to the starting position. Be sure to keep your back straight and don't use your legs.

Muscles worked:
Biceps, Triceps, Upper Back.



FRONT



BACK

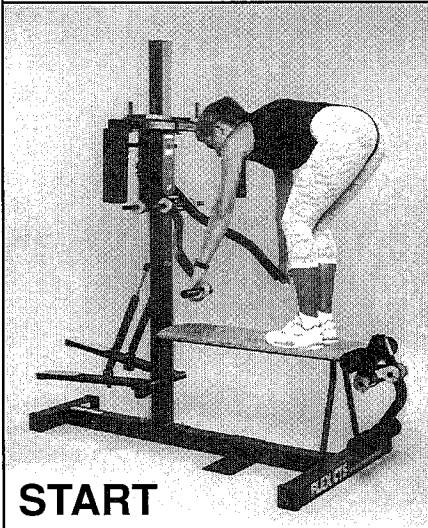

START

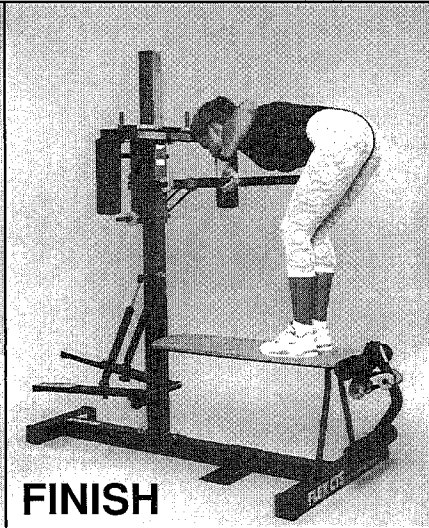

FINISH

20

DEAD LIFT

Bend down at the knees and grasp the main arm as shown. Stand up, making your legs do the work, not your back. Keep your head up.

Muscles worked:
Lower Back, Thighs, Quadriceps.



FRONT



BACK

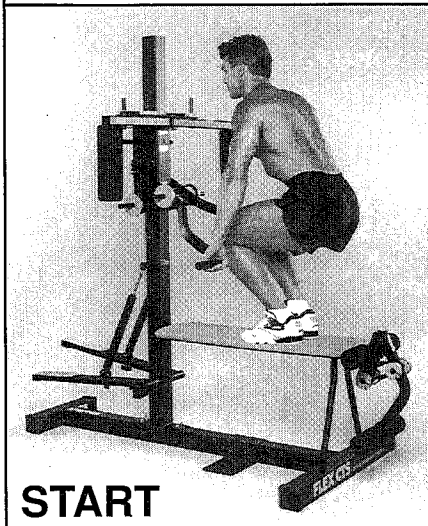

START

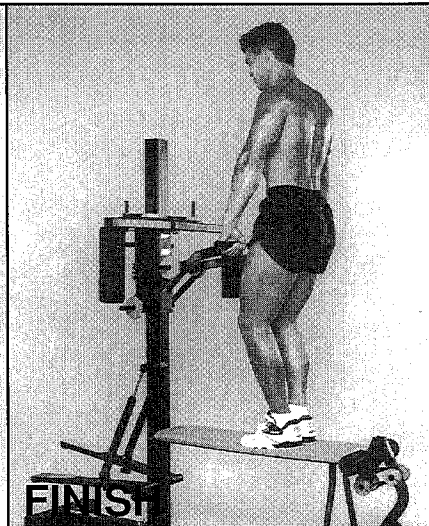

FINISH

21

REVERSE MILITARY

Sit on the bench facing away from the machine. Position the main arm at shoulder level. Fully extend arms upward, then return them to the starting position. Keep your back straight, feet flat on the floor.

Muscles worked:
Front Deltoids, Triceps.

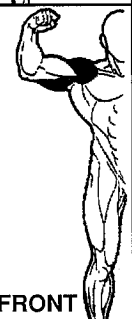

FRONT



BACK

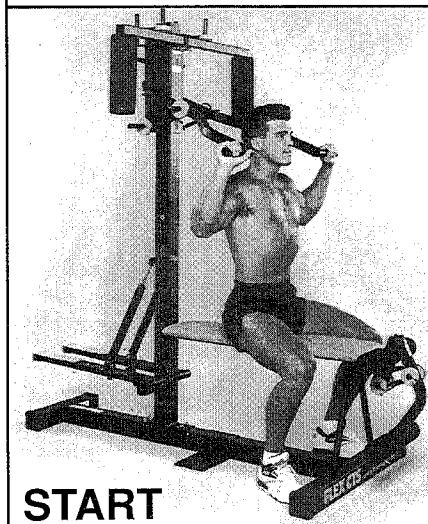

START

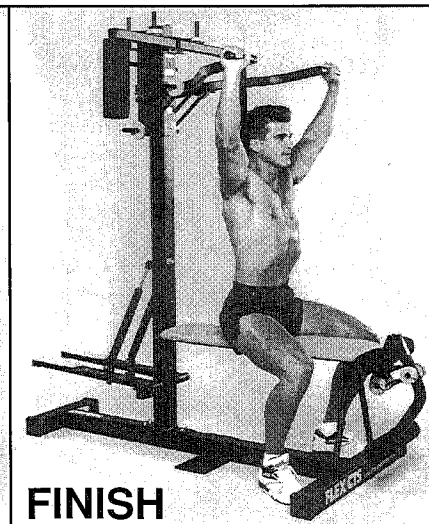

FINISH

22

INCLINE SIT-UP

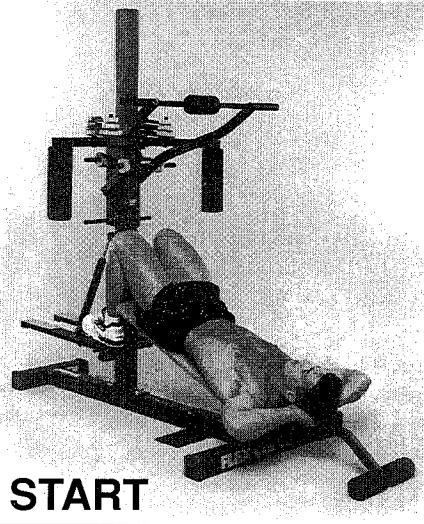

START

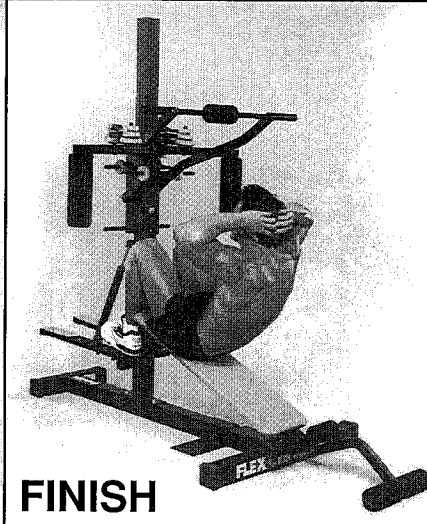

FINISH

Remove the bench support, rest the bench on the stabilizer, and hook your feet under the brace. Lie back with your knees bent. Pull yourself forward, then slowly return to the starting position. To strengthen and tone while avoiding big stomach muscles, do one long set.

Muscles worked:
Abdominal.



FRONT

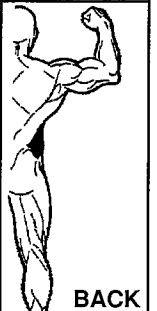

BACK

23

ALTERNATE LEG BEND

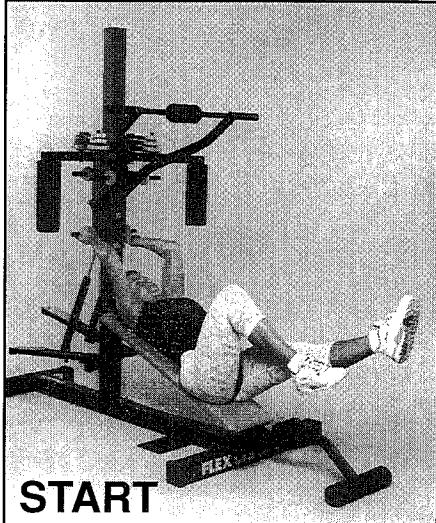

START

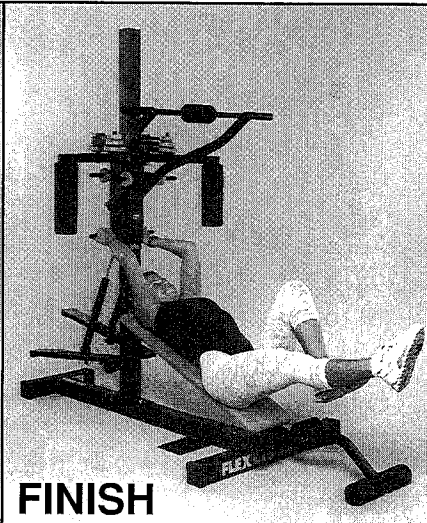

FINISH

Remove the bench support, lie back on the bench and grasp the brace, as shown. Alternately bend one leg while holding the other straight, as shown. For a variation, keep legs together, toes pointed up, and lift your legs above your head. Return to start.

Muscles worked:
Lower Abdominal.



FRONT

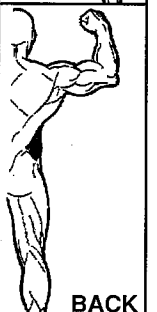

BACK

24

ABDOMINAL CRUNCH

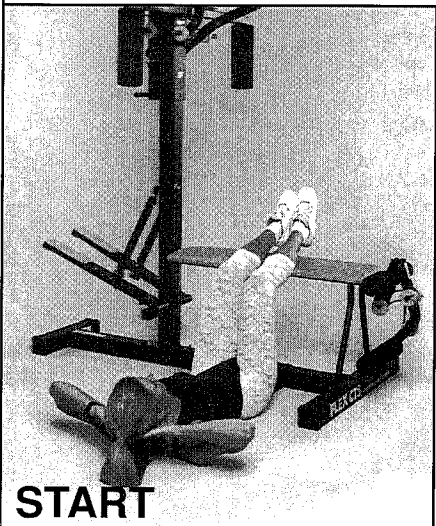

START

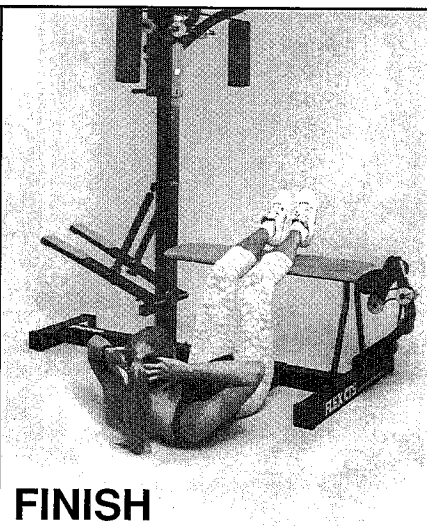

FINISH

Lie on the ground with your feet up on the bench, as shown. Lean forward without bending at the waist and return to the starting position.

Muscles worked:
Abdominal.



FRONT

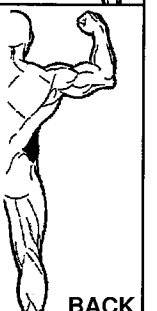

BACK

25 VERTICAL KNEE RAISE/LAT BAR*

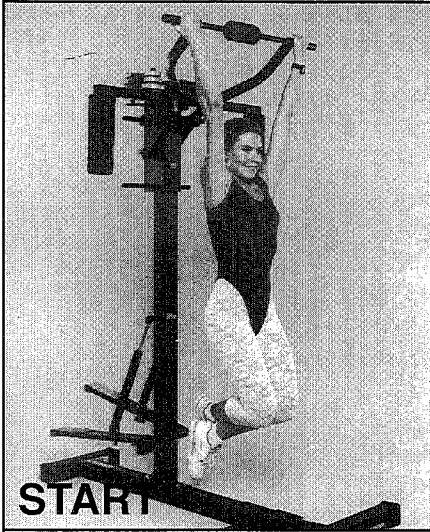

START

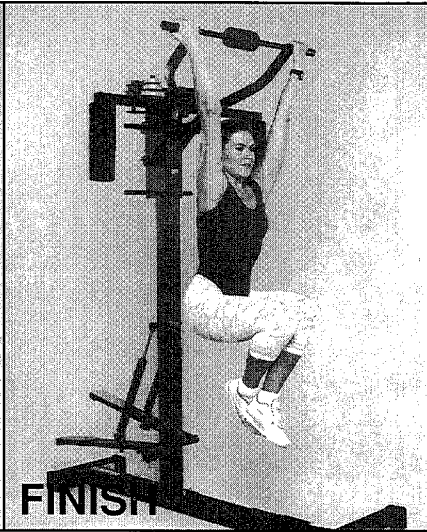

FINISH

Move the main arm into the upward position and insert the locking bands to hold into place. Grasp the main arm and bend your knees so that your feet are off the ground. With your legs together, bring both legs up to your chest, bending at the waist. Keep your motion smooth raising and lowering your legs.

Muscles worked:
Lower Abdominal.



FRONT

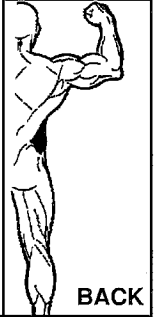

BACK

26

STEPPER

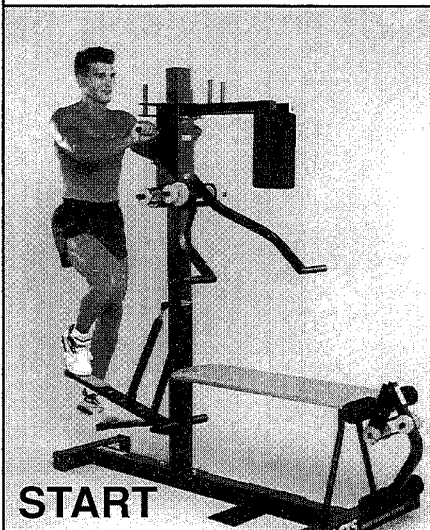

START

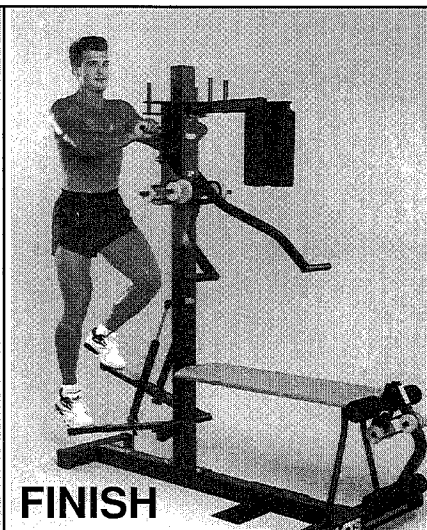

FINISH

Set the stepper to one of the five resistance levels. Press a stepper pedal down and place one foot on the pedal. Place your other foot on the raised pedal. Alternately press the pedals down, and keep your back straight. For an effective cardio-vascular workout, take short, rapid steps at low resistance.

Muscles worked:
Calves.

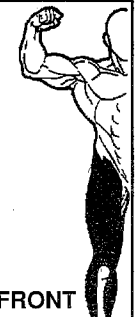

FRONT



BACK

27

CALF RAISE

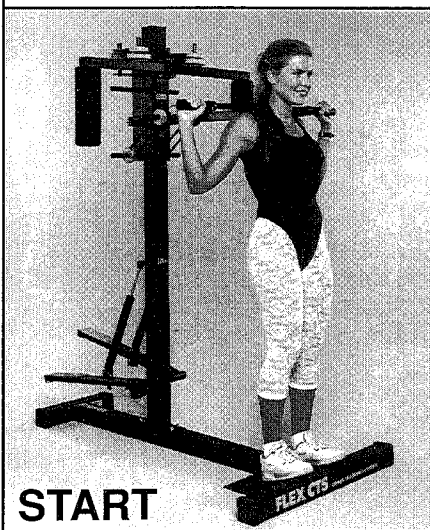

START

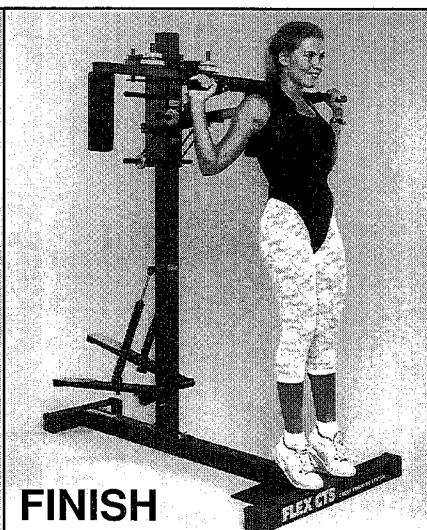

FINISH

Remove the bench. Place the balls of your feet on the stabilizer bar and your heel on the ground as shown. Grasp the main arm with your hands and position the lat bar in the center of your shoulder. Lift your heel up and extend yourself onto your toes.

Muscles worked:
Calves.



FRONT

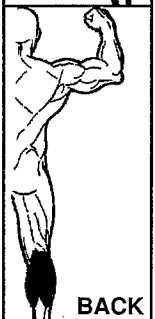

BACK

28

TOE PRESS

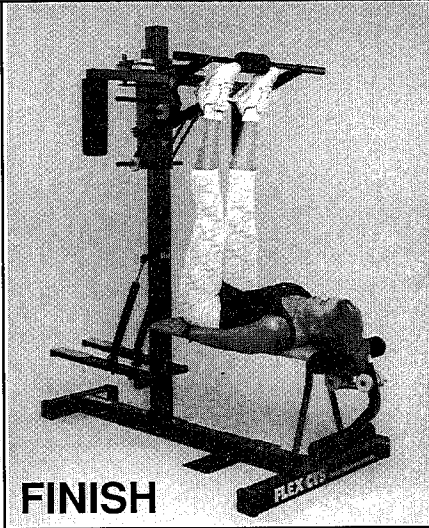
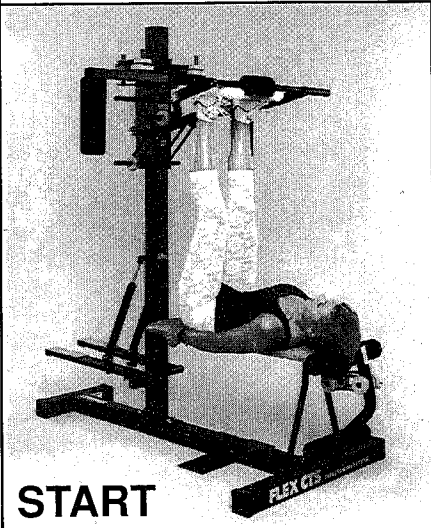

Lie on the bench, as shown. Stretch your legs up and press your toes against the lat bar. Stay in the starting position for a few seconds to stretch your calves, then push up with your toes. At first you won't be able to do many without a burning sensation, but keep it up. If the leg extension is in the way when you lie back, move your head to one side.
Muscles worked:
 Calves.

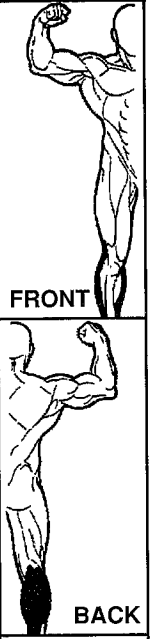

29

LEG EXTENSION

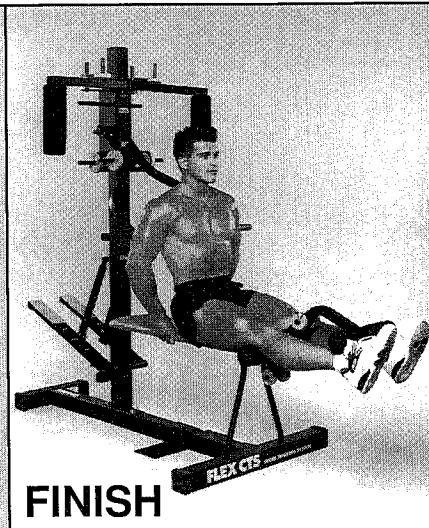
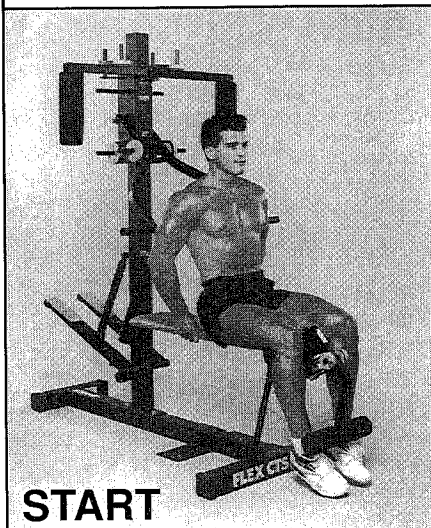

Sit on the bench facing away from the machine and extend your legs over the bench with your feet under the leg extension, as shown. Extend your legs up as far as you can, then slowly let them back down to the starting position.
Muscles worked:
 Quadriceps.

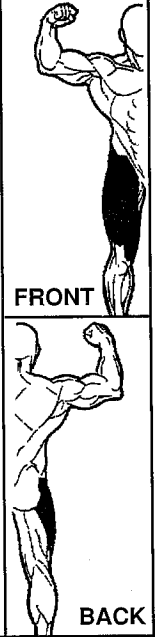

30

SQUAT

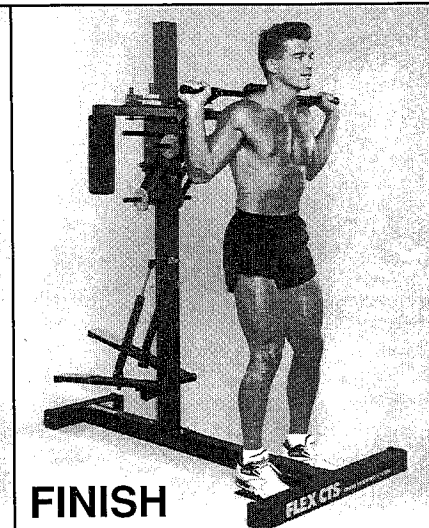
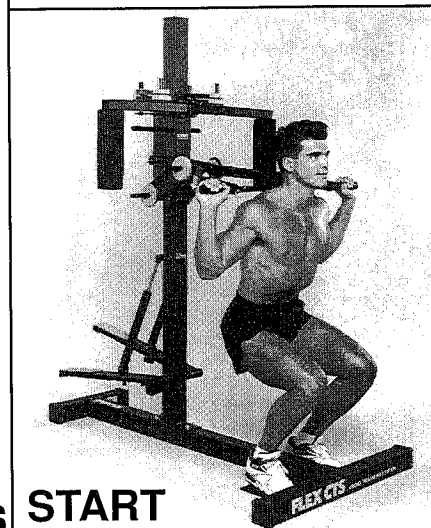

Remove the bench. Insert the lat bar into the main arm. Stand under the main arm facing away from the machine, as shown in the picture. Do not use your back on this one, make your legs do the work. Keep your head up and look forward.
Muscles worked:
 Glutes, Quadriceps.

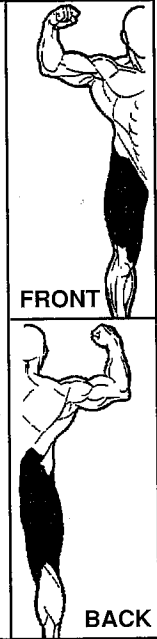

31

STANDING SINGLE LEG CURL

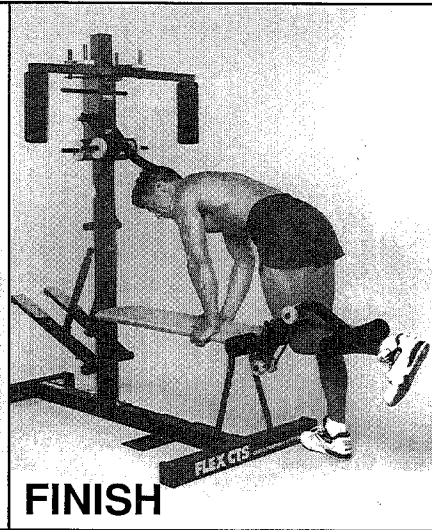
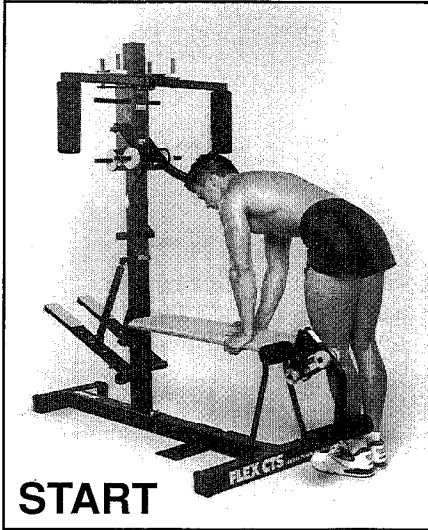

Stand facing the machine with the lower leg placed under the lift bar, as shown. Hold bench for balance and curl your leg up with a controlled motion. Return to the starting position.

Muscles worked:
Hamstring, Glutes, Thigh.

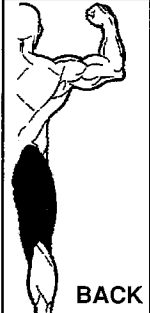
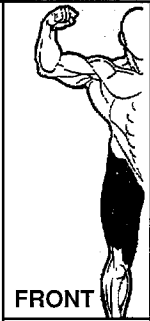

32

LEG PRESS

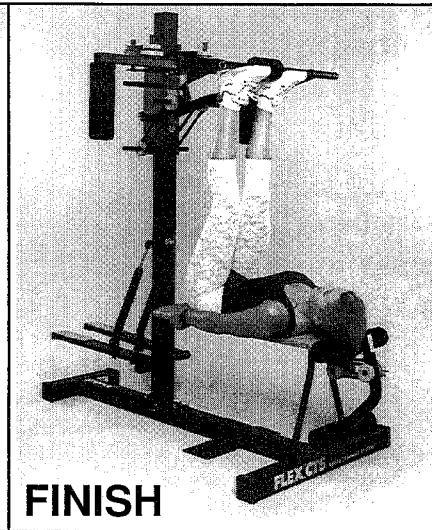
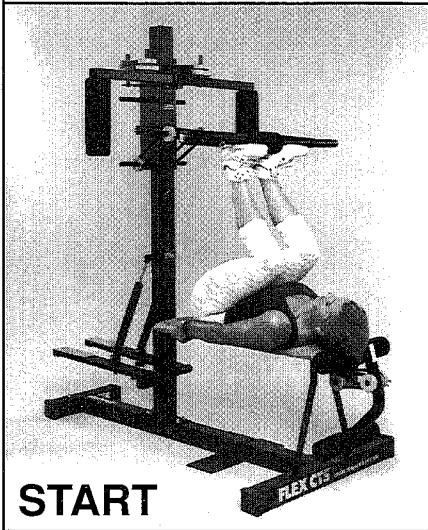

Position the frame sleeve so that when the legs are curled against the chest there is no tension on the bands. Fully extend legs, then slowly return to the starting position. If you have back problems, this would be a good substitute for squats.

Muscles worked:
Glutes, Hamstring, Quadriceps.

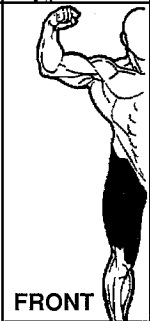

To order Locking bands and additional weights, call 1-800-99-WESLO.

MONDAY

EXERCISE DATE	RESISTANCE	REPS	SETS

MONDAY

EXERCISE DATE	RESISTANCE	REPS	REPS

THURSDAY STEPPER

EXERCISE DATE	RESISTANCE	REPS	SETS

WEDNESDAY

EXERCISE DATE	RESISTANCE	REPS	REPS

THURSDAY STEPPER

THURSDAY STEPPER

EXERCISE DATE	RESISTANCE	REPS	SETS

THURSDAY STEPPER

EXERCISE DATE	RESISTANCE	REPS	REPS

FRIDAY

FRIDAY

NEED SOME HELP?

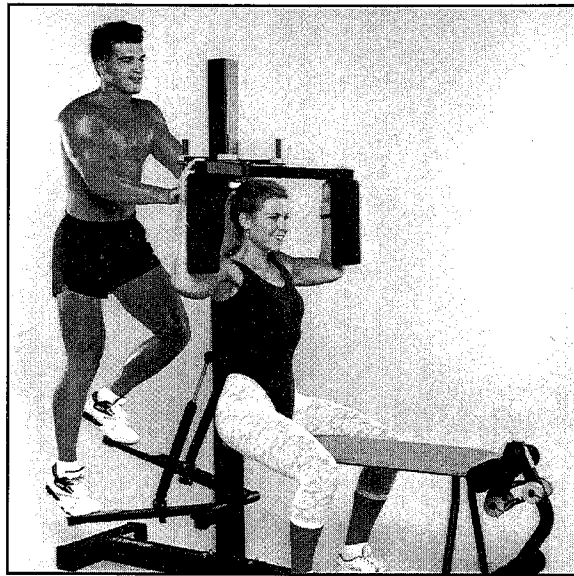

What muscles do I need to work to strengthen my tennis serve?

Personal Trainers has been exclusively commissioned by ProForm to design a fitness program specific to your needs.

You purchased the FLEX CTS because you want to do something with your body. Something specific. If your goal is to lose weight, firm up or build your muscles in specific areas, you can achieve results by letting **Personal Trainers** custom design a program specific to your needs. You don't need to spend a lot of money on a gym membership to get expert advice.

I wish I knew what kind of workout would help my golf game.

How should I train to firm and tone my body?

Whether you want to gear up for the football season, accelerate your tennis swing, strengthen your golf game or get in shape to ski, our trainers can prescribe a workout for you to make it happen. All you really need is a little motivation and some good advice.

It's simple. Call **Personal Trainers** at 1-900-726-FLEX, 6:00 a.m. - 6:00 p.m. MST. They will ask you questions about your health, lifestyle and fitness goals and send your personal plan for improvement. It's just \$3 the first minute and 95 cents for each additional minute. The real work is up to you.

CONSULT YOUR DOCTOR before beginning this or any other regimen of exercise. For best results and in order to avoid injuries and negative effects, all participants must understand that any exercise program requires that you begin gradually, slowly and cautiously.

WESLO

A good name to know in home fitness

A subsidiary of Weider Health & Fitness
1500 South 1000 West • Logan, Utah 84321-9813