

# weslo<sup>®</sup> INVERSION FLEXsystem

Model No. WLBE13320

Serial No. \_\_\_\_\_

Write the serial number in the space above for future reference.

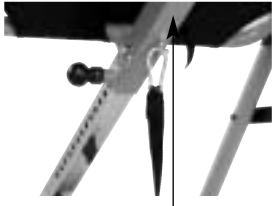

Serial Number Decal

## USER'S MANUAL

### QUESTIONS?

As a manufacturer, we are committed to providing complete customer satisfaction. If you have questions, or if there are missing or damaged parts, we will guarantee complete satisfaction through direct assistance from our factory.

TO AVOID DELAYS, PLEASE CALL DIRECT TO OUR TOLL-FREE CUSTOMER HOT LINE. The trained technicians on our customer hot line will provide immediate assistance, free of charge.

CUSTOMER HOT LINE:

**1-800-999-3756**

Mon.–Fri., 6 a.m.–6 p.m. MST



### CAUTION

Read all precautions and instructions in this manual before using this equipment. Save this manual for future reference.



Visit our website at

[www.weslo.com](http://www.weslo.com)

*new products, prizes,  
fitness tips, and much more!*

# TABLE OF CONTENTS

WARNING DECAL PLACEMENT .....	2
IMPORTANT PRECAUTIONS .....	3
BEFORE YOU BEGIN .....	4
ASSEMBLY .....	5
ADJUSTMENTS .....	9
ROTATING ON THE BENCH .....	12
DEVELOPING A PROGRAM .....	13
PART LIST .....	14
EXPLODED DRAWING .....	15
ORDERING REPLACEMENT PARTS .....	Back Cover
LIMITED WARRANTY .....	Back Cover

## WARNING DECAL PLACEMENT

The decals shown here have been placed on the bench. If a decal is missing or illegible, please call our Customer Service Department toll-free at 1-800-999-3756, Monday through Friday, 6 a.m. until 6 p.m. Mountain Time, to order a free replacement decal. Apply the decal in the location shown.

Warning Decal 1

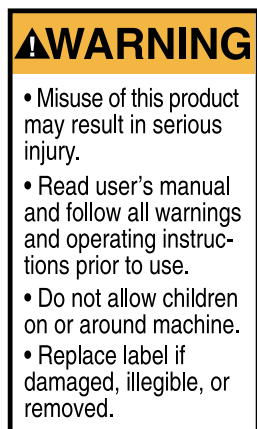

Warning Decal 2



# IMPORTANT PRECAUTIONS

**⚠ WARNING:** To reduce the risk of serious injury, read the following important precautions before using the bench.

1. Read all instructions in this manual before using the bench. Use the bench only as described in this manual. Have a second person read to help you as you set up and learn how to use the bench.
2. It is the responsibility of the owner to ensure that all users of the bench are adequately informed of all precautions.
3. The bench is intended for home use only. Do not use the bench in any commercial, rental, or institutional setting.
4. Use the bench only on a level surface. Cover the floor beneath the bench to protect the floor.
5. Make sure all parts are properly tightened each time you use the bench. Replace any worn parts immediately.
6. Keep children under 12 and pets away from the bench at all times.
7. Keep hands and feet away from moving parts.
8. Always wear athletic shoes with laces to help secure your feet in the bench, and for foot protection while exercising.
9. The bench should be used only by persons 6 feet 6 inches (198cm) tall or less.
10. Always engage the pins on the backrest frame into the same hole in each pivot bar. Always be sure the safety lock is engaged before using the bench.
11. The bench is designed to support a maximum user weight of 300 pounds. Note: Do not use weights with the bench.
12. Make sure the pivot bars are held in the brackets on the backrest frame before using the bench.
13. Always make sure the ankle lock is secured snugly against your ankles before using the bench.
14. Always make sure the linking bars are straight across before using the bench.
15. Do not use the handlebars to rotate up on the bench; the handlebars are for mounting and dismounting the bench.
16. Perform all activities on the bench in a slow, controlled manner. Aggressive exercise can cause the bench to tip over.
17. If you feel pain or dizziness at any time while exercising, stop immediately and begin cooling down.

**⚠ WARNING:** Before beginning this or any exercise program, consult your physician. This is especially important for persons over the age of 35 or persons with pre-existing health problems. Read all instructions before using. ICON assumes no responsibility for personal injury or property damage sustained by or through the use of this product.

**⚠ WARNING:** A list of contraindication for inversion is as follows (this is not an exhaustive list; it is intended only for reference).

- \* Pregnancy
- \* Hiatal Hernia, Ventral Hernia
- \* Glaucoma, retinal detachment or conjunctivitis
- \* High blood pressure, hypertension, recent stroke or transient ischemic attack
- \* Heart or circulatory disorders for which you're being treated
- \* Spinal injury, Cerebral Sclerosis, and acutely swollen joints
- \* Bone weakness (osteoporosis), recent unhealed fractures, medullary pins, and surgically implanted orthopedic supports
- \* The use of anticoagulants, including high doses of aspirin
- \* Middle ear infection, and extreme obesity

If you have one or more of the above contraindications, you may still be able to invert. However, you must first obtain approval from your licensed physician.

# BEFORE YOU BEGIN

Thank you for selecting the WESLO® INVERSION FLEX SYSTEM bench. The INVERSION FLEX SYSTEM bench will increase your intervertebral dimension, decrease pressure on intervertebral discs, stretch and relax your muscles, and temporarily relieve back pain associated with the listed conditions.

**For your benefit, read this manual carefully before using the INVERSION FLEX SYSTEM bench.** If you have additional questions, please call our Customer Service Department toll-free at 1-800-999-3756,

Monday through Friday, 6 a.m. until 6 p.m. Mountain Time (excluding holidays). To help us assist you, please note the product model number and serial number before calling. The model number is WLBE13320. The serial number can be found on a decal attached to the bench (see the front cover of this manual).

Before reading further, please review the drawing below and familiarize yourself with the parts that are labeled.

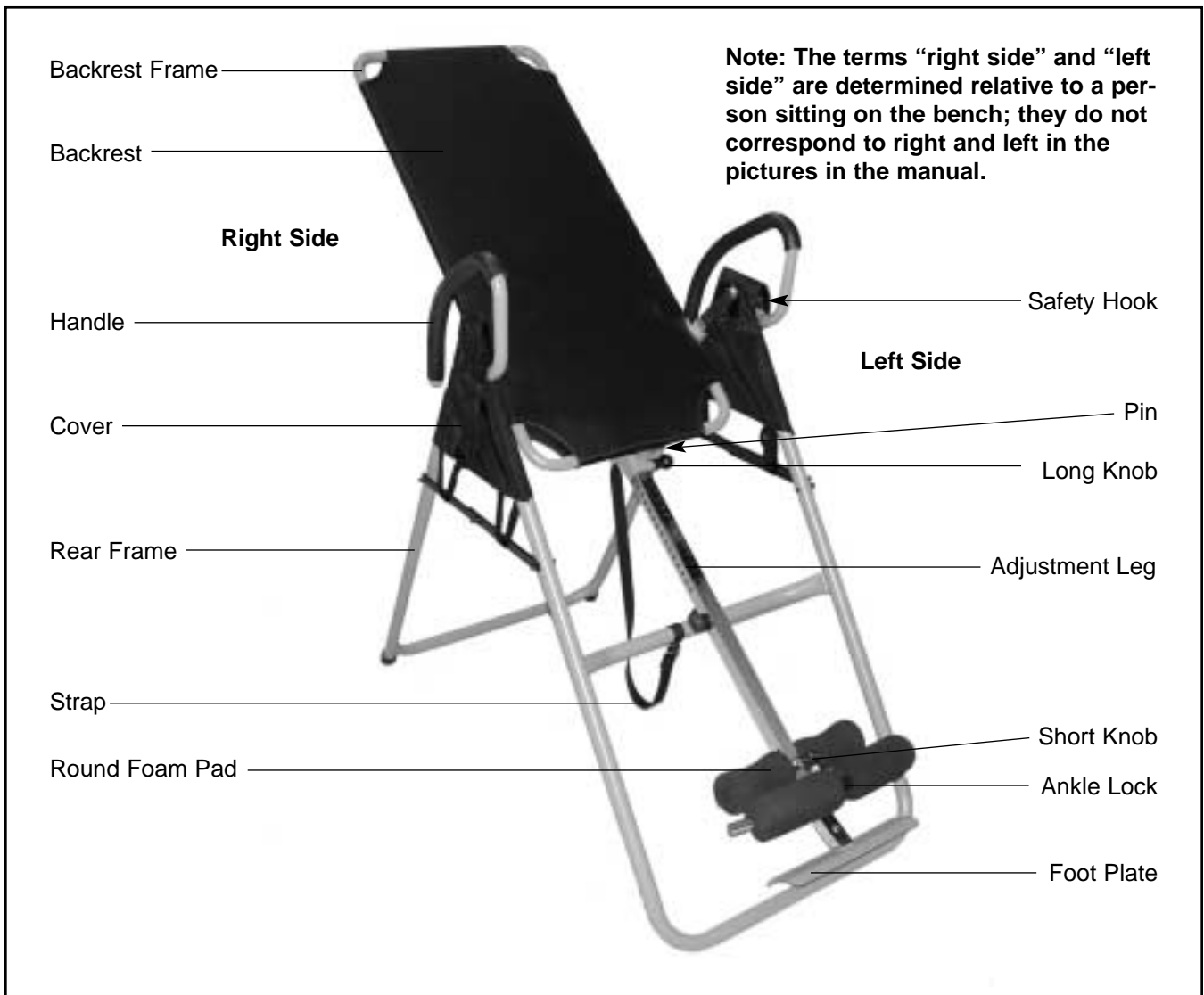

# ASSEMBLY

## Make Things Easier for Yourself



This manual is designed to ensure that the bench can be assembled successfully by anyone. Most people find that by setting aside plenty of time, assembly will go smoothly.

**Before beginning assembly, carefully read the following information and instructions:**

- Assembly requires two people.
- Tighten all parts as you assemble them, unless instructed to do otherwise.
- As you assemble the bench, make sure all parts are oriented as shown in the pictures.

- Place all parts in a cleared area and remove the packing materials. Do not dispose of the packing materials until assembly is completed.

**The following tools (not included) are required for assembly:**

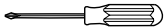
- **Two adjustable wrenches** 
- **One standard screwdriver** 
- **One Phillips screwdriver** 
- **Lubricant, such as grease or petroleum jelly, and soapy water.**

Assembly will be more convenient if you have a socket set, a set of open-end or closed-end wrenches, or a set of ratchet wrenches.

1. Open the Front and Rear Frames (5, 6) and push down on the Linking Bars (7, 8) so that they are straight across.

Slide the Covers (11, 12) over the Front and Rear Frames (5, 6) with the straps on the outside, as shown. Attach the straps around the Linking Bars (7, 8) as shown in the inset picture. **Note: The wide side of the Covers must be on the side shown.**

2. Slide the end of a Pivot Bar (23) with the adjustment holes into the bracket on one side of the Backrest Frame (1). Engage the pin on the Backrest Frame into the center adjustment hole.

**Repeat with the other Pivot Bar (23).**

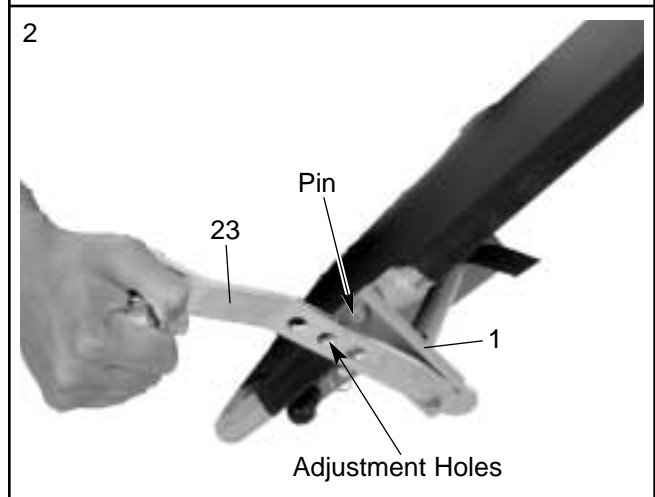
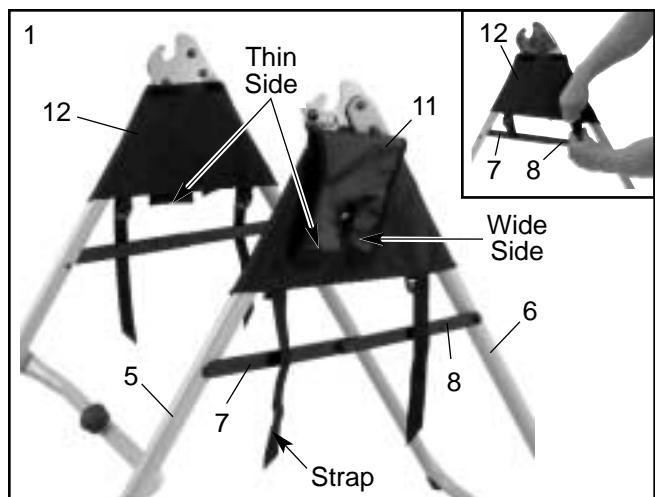

3. Rest the Pulleys (29) inside the slots in the Saddle Plates (20 [not shown], 49) as shown. **Be sure the Backrest (2) is oriented as shown on the front cover of this manual.** Rotate the Safety Lock (28) so that it secures the left Pulley in place.

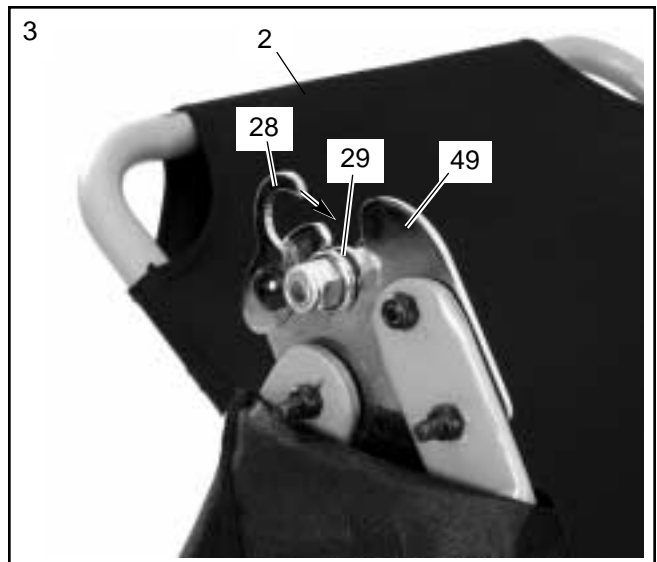

4. Pull the Short Knob (26) out as far as it will go. Pull the Ankle Lock (16) out of the Adjustment Leg (3), rotate it 90 degrees, and reinsert it into the Adjustment Leg. Engage the Knob into an adjustment hole in the Ankle Lock.

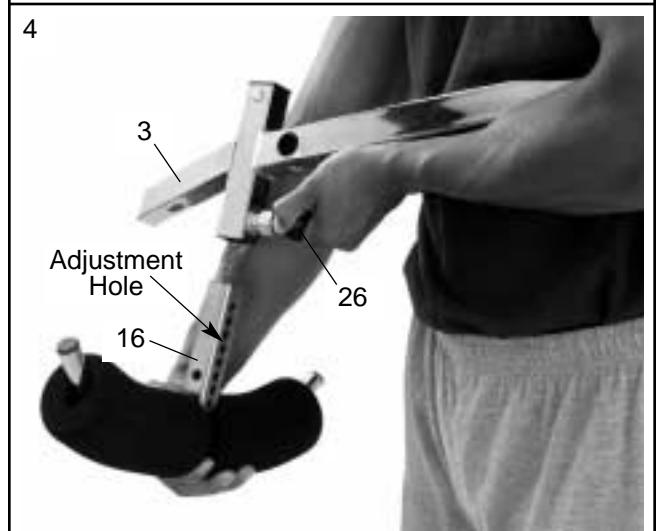

5. Insert the Pad Tube (13) into the indicated hole in the Adjustment Leg (3) and secure it with an M8 x 50mm Bolt (40), an M8 Washer (37), and an M8 Nylon Nut (43).

Slide two Round Foam Pads (14) onto the ends of the Pad Tube (13).

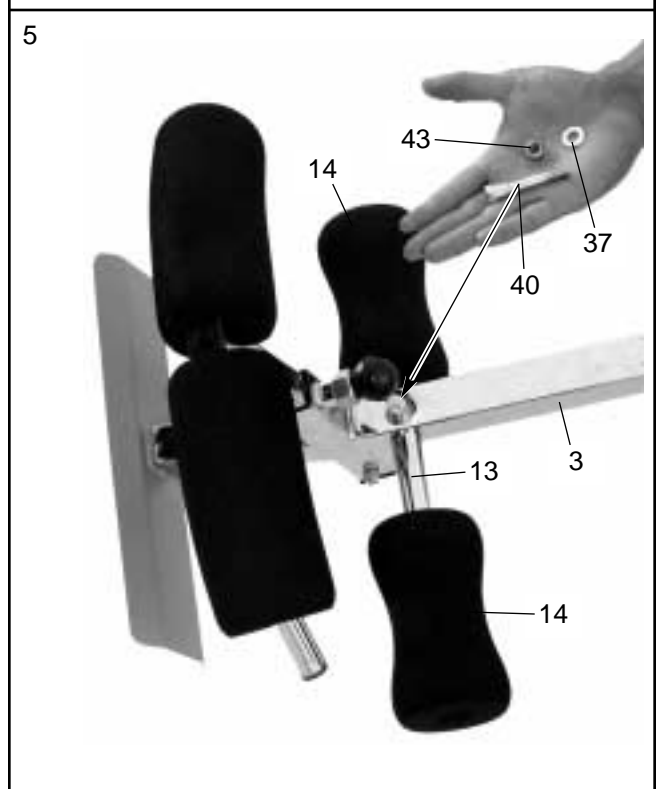

6. Orient the Foot Plate (4) as shown. Insert the Foot Plate into the end of the Adjustment Leg (3) and secure it with an M8 x 40mm Bolt (21) and an M8 Nylon Nut (43).

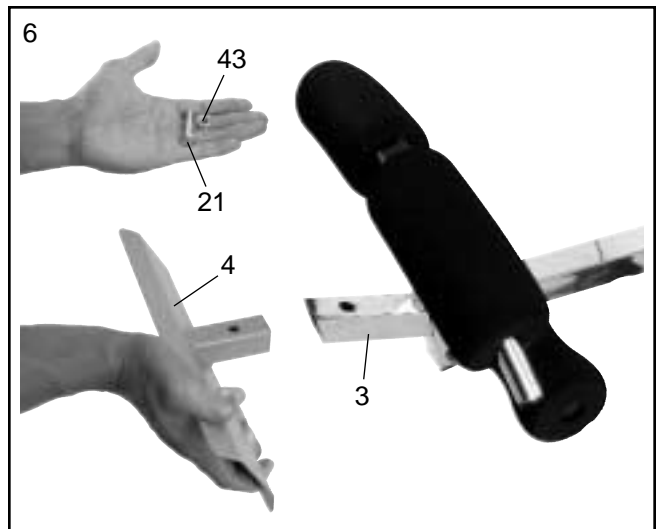

7. Remove the Pin (30) from the Backrest Frame (1). Pull the Long Knob (27) out as far as it will go. Slide the Adjustment Leg (3) into the Backrest Frame. Engage the Knob into an adjustment hole in the Adjustment Leg. Insert the Pin into the Backrest Frame and the Adjustment Leg.

**Note: The Adjustment Leg (3) should be set at the height measurement that is one or two inches greater than the height of the person using the bench.**

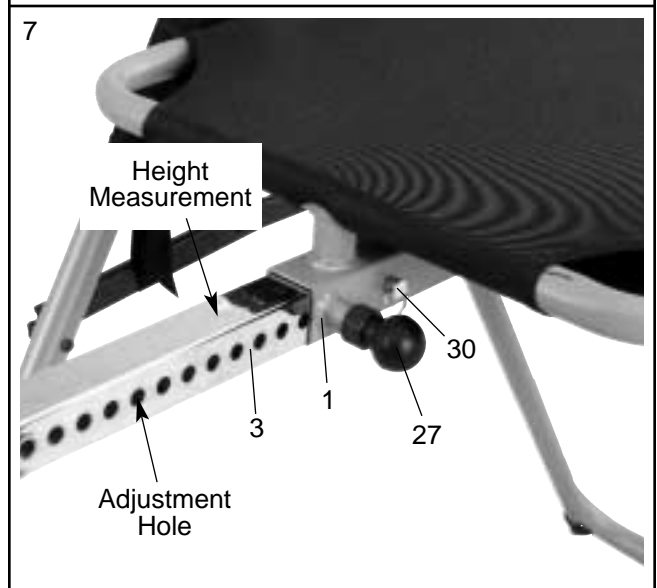

8. Attach the Strap (17) to the crossbar on the Front Frame (5). Attach the Clip (35) on the Strap to the hook on the bottom of the Backrest Frame (1).

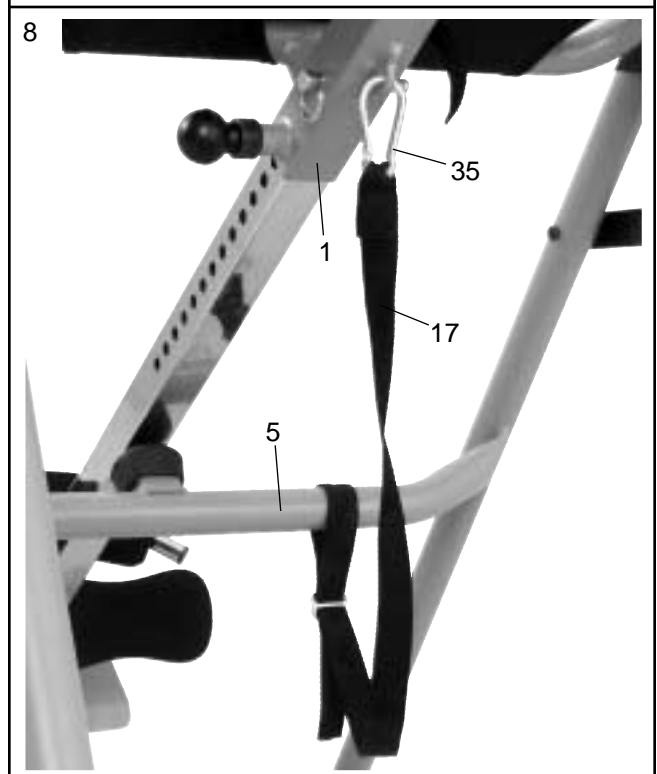

9. Attach a Handlebar (9) to the M8 x 30mm Bolts (48) on the Front and Rear Frames (5, 6), with two M8 Nylon Nuts (43). Be sure the Handlebar is oriented as shown.

**Repeat with the other Handlebar (9).**

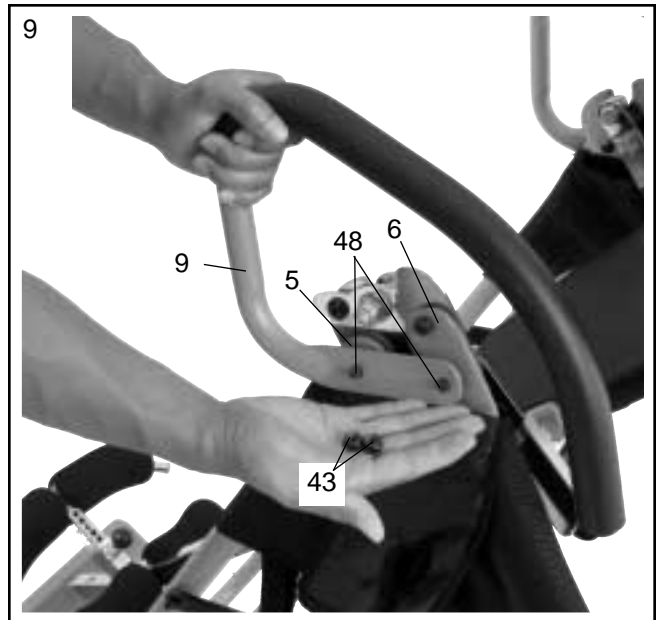

10. Cover the Saddle Plates (20) with the Covers (11, 12).

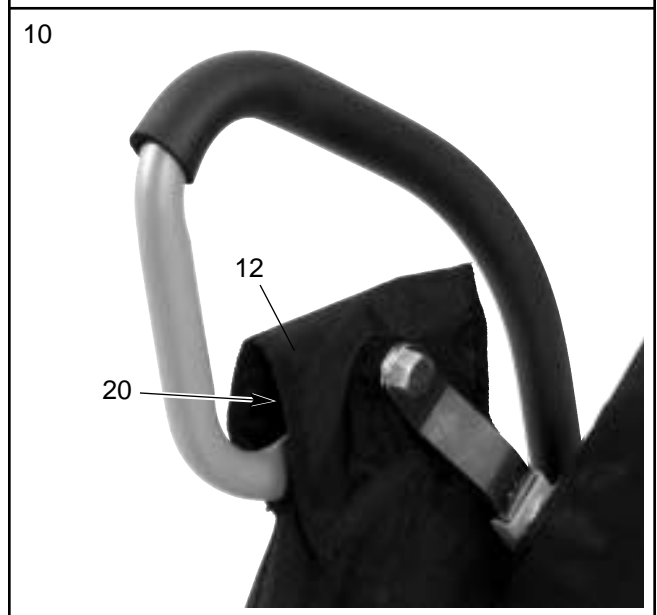

11. Make sure all parts are properly tightened before using the bench. The use of parts will be explained in ADJUSTMENTS, beginning on the following page.

# ADJUSTMENTS

This section explains how to adjust the bench. See DEVELOPING A PROGRAM on page 13 for important information about how to get the most benefit from your exercise program.

Make sure all parts are properly tightened each time the bench is used. Replace any worn parts immediately. The bench can be cleaned with a damp cloth and a mild, non-abrasive detergent. Do not use solvents.

## SELECTING THE PIVOT BAR POSITION

The Pivot Bars (23) have three adjustment holes. The correct hole to use will depend on the user's body weight and the desired level of responsiveness. Refer to the chart to determine which hole to use.

To adjust the Pivot Bars (23), uncover the Saddle Plates (20, 49) and disengage the Safety Lock (28). Lift a Pulley (29) out of a Saddle Plate. Move the Pivot Bar so that the pin on the Backrest Frame (1) engages the desired adjustment hole. Rest the Pulley back in the slot in the Saddle Plate. **Repeat this process with the other Pivot Bar.**

Re-engage the Safety Lock (28) and cover the Saddle Plates (20, 49) with the Covers (11, 12).

Use the bench with the Pivot Bars adjusted to each position to determine which is best for you.

**WARNING:** Always engage the pins on the Backrest Frame (1) into the same holes in both Pivot Bars (23). Always be sure the Safety Lock (28) is engaged before using the bench.

## ADJUSTING THE LENGTH OF THE STRAP

The Strap (17) can be used to stop the bench from becoming inverted more than desired. To adjust the Strap, rotate the Backrest (2) to the most inverted position that you want it to go. Have a second person tighten the Strap.

For the first week or two of use, adjust the Strap (17) to stop the Backrest (2) from rotating more than 15–20 degrees. Lengthen the Strap to allow for the Backrest to rotate a few more degrees as your body becomes accustomed to using the bench.

	Hole A	Hole B	Hole C
80–120 lbs.	#*		
120–220 lbs.	*		#
220–300 lbs.		*	#

Hole A—Most Responsive # Beginner/Partial Inversion  
 Hole B—Moderately Responsive \*Suggested for Full Inversion  
 Hole C—Least Responsive

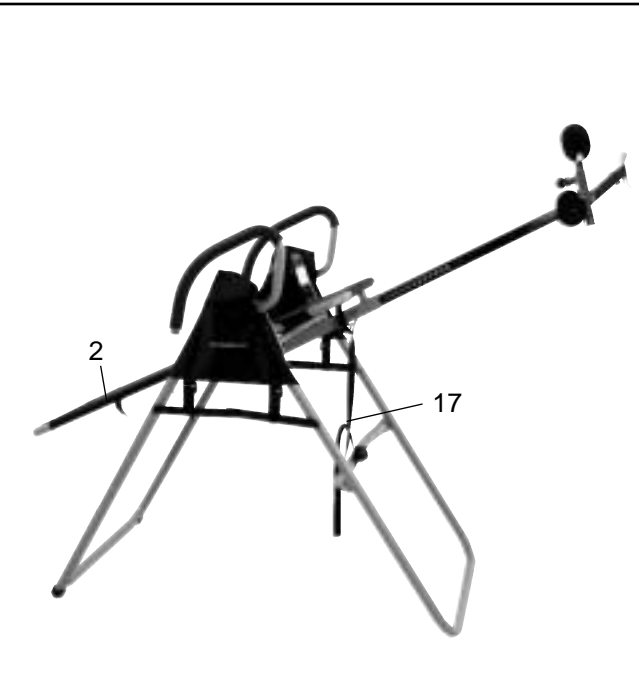
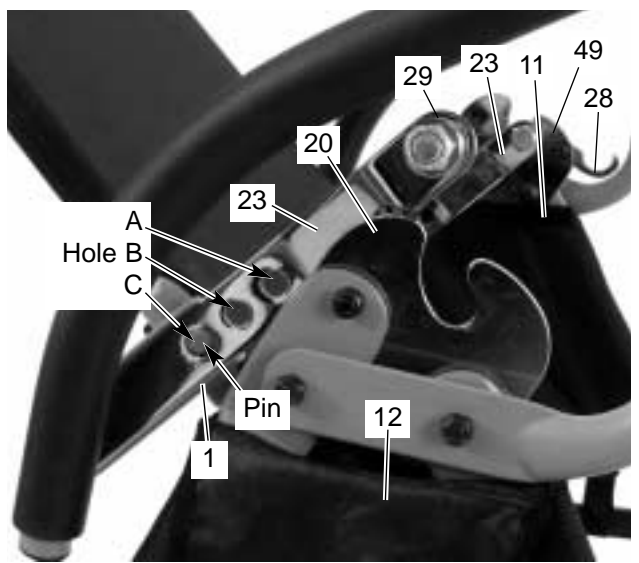

## ADJUSTING THE ADJUSTMENT LEG

The length of the Adjustment Leg (3) can be adjusted to correspond with the height of the user. Remove the Pin (30) from the Backrest Frame (1). Pull the Long Knob (27) out as far as it will go. Slide the Adjustment Leg into, or out of, the Backrest Frame so that the first or second measurement greater than the user's height is covered by the Backrest Frame. Reengage the Knob and Pin into adjustment holes in the Adjustment Leg and the Backrest Frame.

Use the bench with the Adjustment Leg (3) adjusted to a few different lengths to determine which length is best for you.

**WARNING:** The bench is designed to be used by persons 6 feet 6 inches (198cm) tall or less.

## USING THE ANKLE LOCK

To secure your ankles in the bench, pull the Short Knob (26) out as far as it will go and pull the Ankle Lock (16) away from the Adjustment Leg (3). Stand on the Foot Plate (4) with the backs of your legs against the Round Foam Pads (14) and toes under the Ankle Lock. Push the Ankle Lock against your ankles and engage the Knob into an adjustment hole in the Ankle Lock.

**WARNING:** Always make sure the Ankle Lock (16) is secured snugly against your ankles before using the bench. Always wear athletic shoes with laces to help secure your feet in the bench.

## TIGHTENING THE BACKREST

The Backrest (2) may stretch as it is used. If this happens, tighten the five straps on the back of the Backrest.

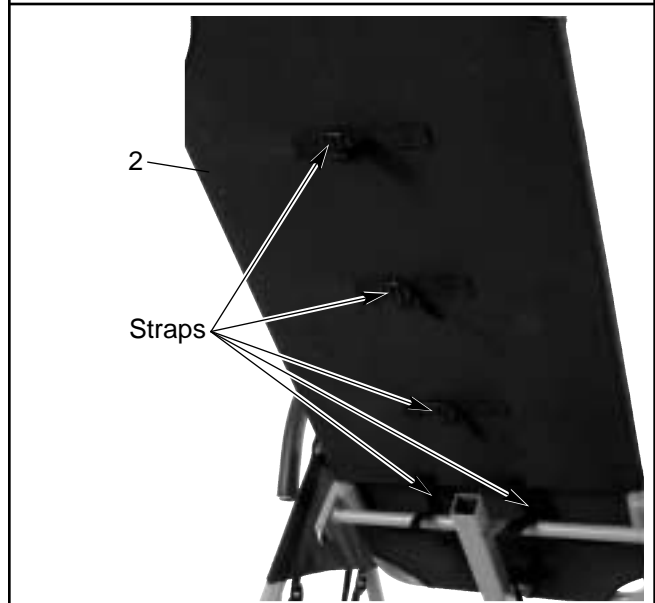
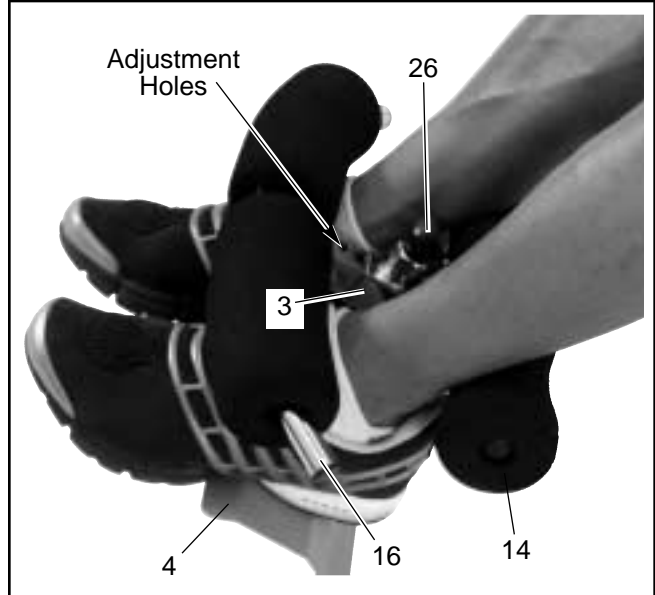
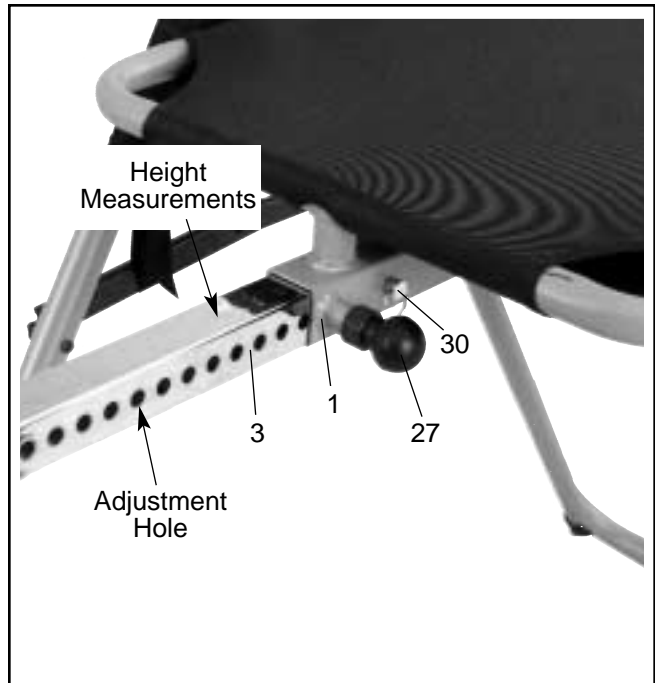

## STORING THE BENCH

To store the bench, adjust the Adjustment Leg (3) to the shortest length (see ADJUSTING THE ADJUSTMENT LEG, on page 10). Adjust the Ankle Lock (16) to the position closest to the Adjustment Leg (see USING THE ANKLE LOCK, on page 10). Then, lift on the Linking Bars (7, 8) and fold the Frames (5, 6) together.

**⚠ WARNING:** Always make sure the Linking Bars (7, 8) are straight across before using the bench.

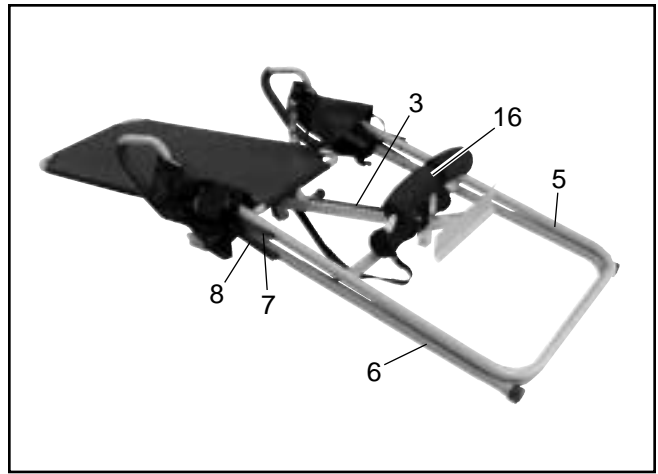

# ROTATING ON THE BENCH

This section explains how to rotate back on the bench, and return to the starting position. It may be helpful to have a second person ready to assist you as you learn to use the bench.

## SETTING UP AND MOUNTING THE BENCH

Before using the bench, adjust the Pivot Bars (23), the Adjustment Leg (3), and the Strap (17) to the correct settings for the user. Secure your ankles in the Ankle Lock (16). **Refer to the ADJUSTMENTS section on page 9 of this manual.**

## ROTATING BACK ON THE BENCH

To rotate back on the bench, slowly lift your arms over your head until reaching the desired position. The speed at which the arms are lifted will determine how quickly the bench will rotate. Rest your arms in a comfortable position without causing the bench to rotate.

To lock the backrest in the fully inverted position it may be necessary to push against the floor or Rear Frame (6) for the last few degrees, so that the Backrest Frame (1) rests against the crossbar on the Front Frame (5). The weight of the body will then lock the bench in the fully inverted position

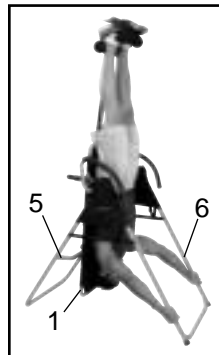

## ROTATING UP ON THE BENCH

To return to the starting position, bend your knees slightly and slowly move your hands toward your waist until rotating to a horizontal position. Rest in a horizontal position for 30 to 60 seconds, before rotating to the starting position. This will allow your body to readjust. Return to the starting position slowly. Dizziness after using the bench is an indication that you have returned to the starting position too quickly.

To rotate up from the fully inverted position, hold the corner of the Backrest Frame (1) behind your head with one hand, and the bottom of the Rear Frame (6) with the other hand. Pull the Backrest Frame toward the Rear Frame. This will release the Backrest Frame (9) from the fully inserted position. Rotate up as described above.

**Do not try to sit up or use the Handles (9) to return to the starting position.**

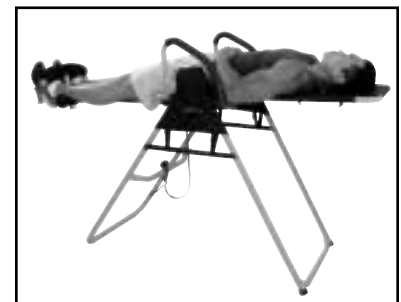
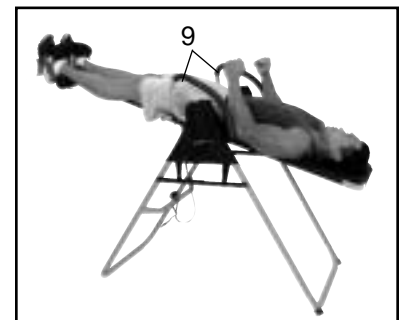
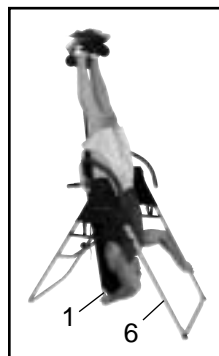

---

# DEVELOPING A PROGRAM

This section contains information and suggestions about using the bench. Make sure all parts are properly tightened each time the bench is used. Replace any worn parts immediately.

## GETTING THE MOST OUT OF USING THE BENCH

If you feel nauseated while using the bench, return to the starting position. Note that it may take a few weeks of use for your inner ear to become accustomed to being inverted.

Do not use the bench right after you have eaten.

Moving while using the bench may make it a more comfortable experience, and may help joints and muscles stretch and relax. Always move in a slow, controlled manner.

The greater the angle at which the bench is used, the shorter the time that you should rotate back before rotating up. Increase the amount of inverted time and the angle of use gradually.

Always pay attention to how your body feels as you use the bench. Increase the level of intensity only as it is comfortable for you. When you feel like you have had enough, return to the starting position.

## BEGINNER PROGRAM

The following are suggestions for persons who are just starting to use the bench.

Set the Strap (17) to allow the Backrest Frame (1) to rotate to 20° or less for the first one or two weeks. This will allow the body time to adjust to the change in gravitational pull.

Use the bench for one or two minutes at a time, two or three times a day.

Only stay inverted for as long as it is comfortable. This may be only a few seconds at first.

## INTERMEDIATE PROGRAM

The following are suggestions for persons who have become comfortable using the bench as described under the BEGINNER PROGRAM.

Increase the angle to which the bench can rotate, as it is comfortable. Adjust the Strap (17) to allow the bench to rotate to up to 60°, a few degrees at a time.

Start to do gentle stretching while using the bench.

Gradually increase the amount of time that you use the bench to 10 minutes or more, two or three times a day. Routines can be varied from rotating back for 1 or 2 minutes and then up for 30 seconds, to rotating back and up for equal amounts of time.

## FULL INVERSION PROGRAM

The following are suggestions for persons who have become comfortable using the bench as described under the INTERMEDIATE PROGRAM and desire to rotate to greater angles, or to do sit-ups. Note that all the benefits of inversion can be gained by rotating to 60°. **Do not attempt to sit-ups unless the Backrest Frame is locked in the fully inverted position.**

Increase the angle to which the bench can rotate, as it is comfortable. Adjust the Strap (17) to allow the bench to rotate until it comes in contact with the back of the crossbar on the Front Frame (5).

Adjust the Pivot Bars (23) so that the pin on the Backrest Frame (1) is in the top hole (see SELECTING THE PIVOT BAR POSITION, on page 9). If the user weighs 220 pounds or more, adjust the pin to the center hole in the Pivot Bars. Rotate back and up as described on page 12.

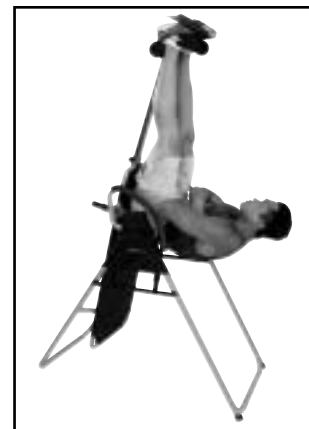

## PART LIST—Model No. WLBE13320

R1202A

Key No.	Qty.	Description	Key No.	Qty.	Description
1	1	Backrest Frame	27	1	Long Knob
2	1	Backrest	28	1	Safety Lock
3	1	Adjustment Leg	29	2	Pulley
4	1	Foot Plate	30	1	Pin
5	1	Front Frame	31	1	33mm Square Inner Cap
6	1	Rear Frame	32	1	30mm Square Inner Cap
7	2	Long Linking Bar	33	1	Spring
8	2	Short Linking Bar	34	1	Bolt Spacer
9	2	Handlebar	35	1	Clip
10	2	Foam Grip	36	6	M6 Washer
11	1	Left Cover	37	2	M8 Washer
12	1	Right Cover	38	2	M6 x 13mm Bolt
13	1	Pad Tube	39	4	M6 x 45mm Bolt
14	2	Round Foam Pad	40	1	M8 x 50mm Bolt
15	2	Foam Pad	41	2	M12 Nylon Nut
16	1	Ankle Lock	42	1	M6 Nylon Nut
17	1	Strap	43	13	M8 Nylon Nut
18	2	Large Round Outer Cap	44	6	M6 Nylon Dome Nut
19	4	Small Round Inner Cap	45	2	M12 x 50mm Bolt
20	1	Right Saddle Plate	46	1	M6 x 40mm Bolt
21	1	M8 x 40mm Bolt	47	2	M8 x 20mm Bolt
22	1	Bumper	48	4	M8 x 30mm Bolt
23	2	Pivot Bar	49	1	Left Saddle Plate
24	2	Spacer	50	1	M8 x 20mm Screw
25	2	Round Inner Cap	51	1	M8 Bushing
26	1	Short Knob	#	1	User's Manual

Note: “#” indicates a non-illustrated part. Specifications are subject to change without notice. See the back cover of the user's manual for information about ordering replacement parts.

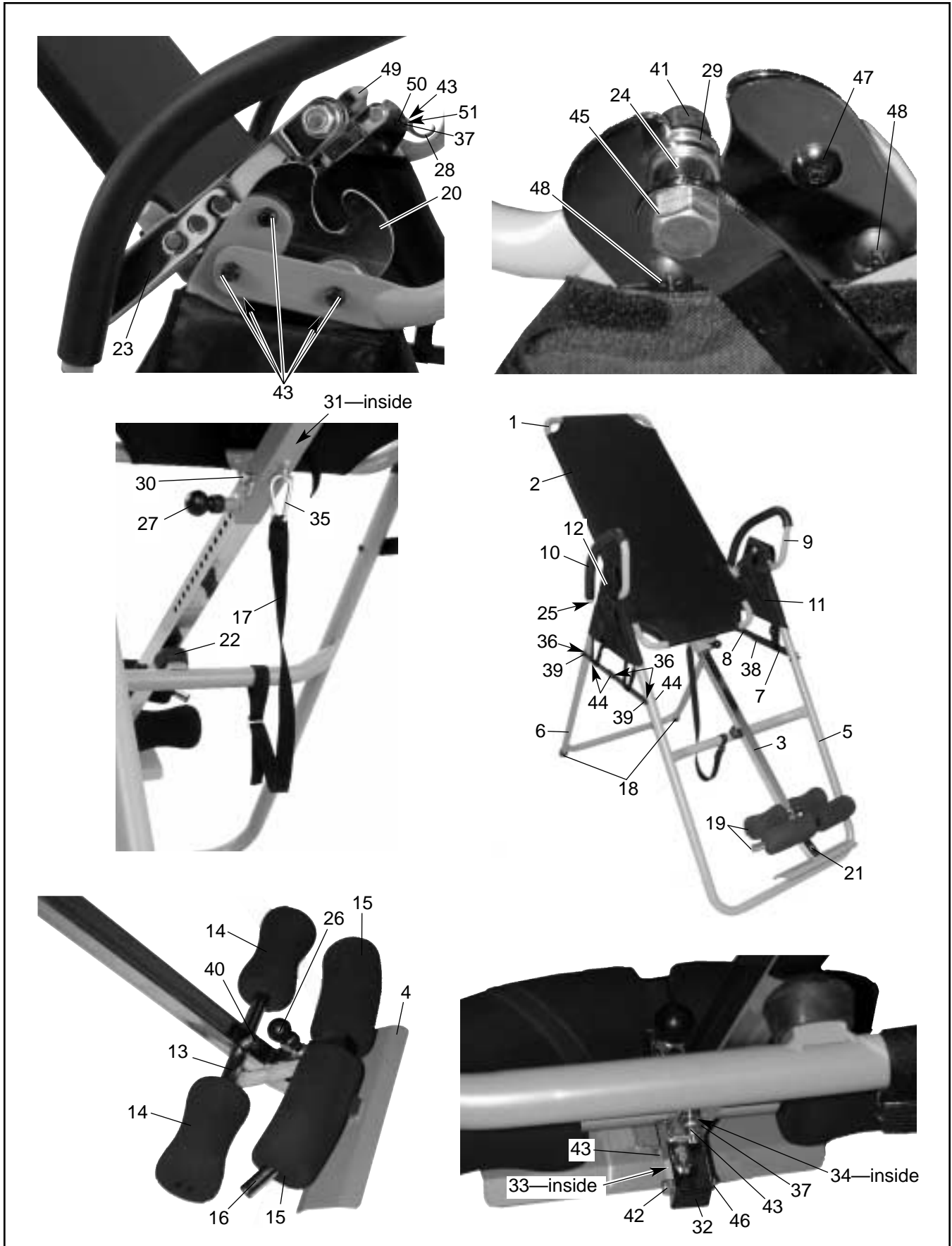

---

# ORDERING REPLACEMENT PARTS

To order replacement parts, simply call our Customer Service Department toll-free at 1-800-999-3756, Monday through Friday, 6 a.m. until 6 p.m. Mountain Time (excluding holidays). To help us assist you, please be prepared to give the following information:

1. The MODEL NUMBER of the product (WLBE13320)
2. The NAME of the product (WESLO® INVERSION FLEX SYSTEM bench)
3. The SERIAL NUMBER of the product (see the front cover of this manual)
4. The KEY NUMBER and DESCRIPTION of the part(s) (see the PART LIST and the EXPLODED DRAWING on pages 14 and 15 of this manual)

---

## LIMITED WARRANTY

ICON Health & Fitness, Inc. (ICON), warrants this product to be free from defects in workmanship and material, under normal use and service conditions, for a period of ninety (90) days from the date of purchase. This warranty extends only to the original purchaser. ICON's obligation under this warranty is limited to replacing or repairing, at ICON's option, the product at one of its authorized service centers. All products for which warranty claim is made must be received by ICON at one of its authorized service centers with all freight and other transportation charges prepaid, accompanied by sufficient proof of purchase. All returns must be pre-authorized by ICON. This warranty does not extend to any product or damage to a product caused by or attributable to freight damage, abuse, misuse, improper or abnormal usage or repairs not provided by an ICON authorized service center, products used for commercial or rental purposes, or products used as store display models. No other warranty beyond that specifically set forth above is authorized by ICON.

ICON is not responsible or liable for indirect, special or consequential damages arising out of or in connection with the use or performance of the product or damages with respect to any economic loss, loss of property, loss of revenues or profits, loss of enjoyment or use, costs of removal, installation or other consequential damages of whatsoever nature. Some states do not allow the exclusion or limitation of incidental or consequential damages. Accordingly, the above limitation may not apply to you.

The warranty extended hereunder is in lieu of any and all other warranties and any implied warranties of merchantability or fitness for a particular purpose is limited in its scope and duration to the terms set forth herein. Some states do not allow limitations on how long an implied warranty lasts. Accordingly, the above limitation may not apply to you.

This warranty gives you specific legal rights. You may also have other rights which vary from state to state.

**ICON HEALTH & FITNESS, INC., 1500 S. 1000 W., LOGAN, UT 84321-9813**