

DRAWING NO	PTM699-1US-C		
PART NAME	Explosive Rendering		
PART NO	MTM0602-00	REV	A
APPROVE	Harvey	DATE	2016.05.26

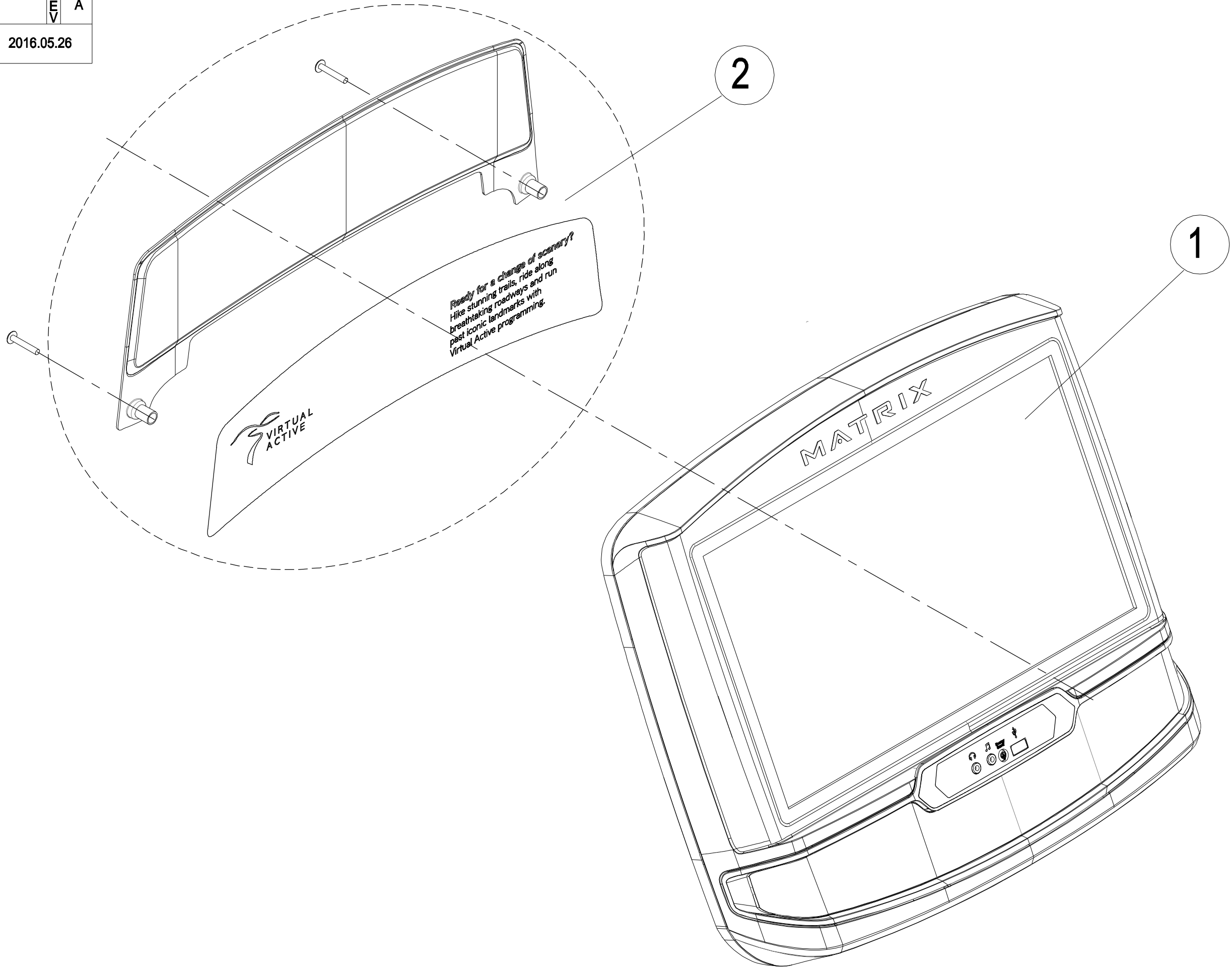

DRAWING NO	TM699-A12		
PART NAME	Console Set		
PART NO	1000354727	REV	A
APPROVE	Harvey	DATE	2016.05.26

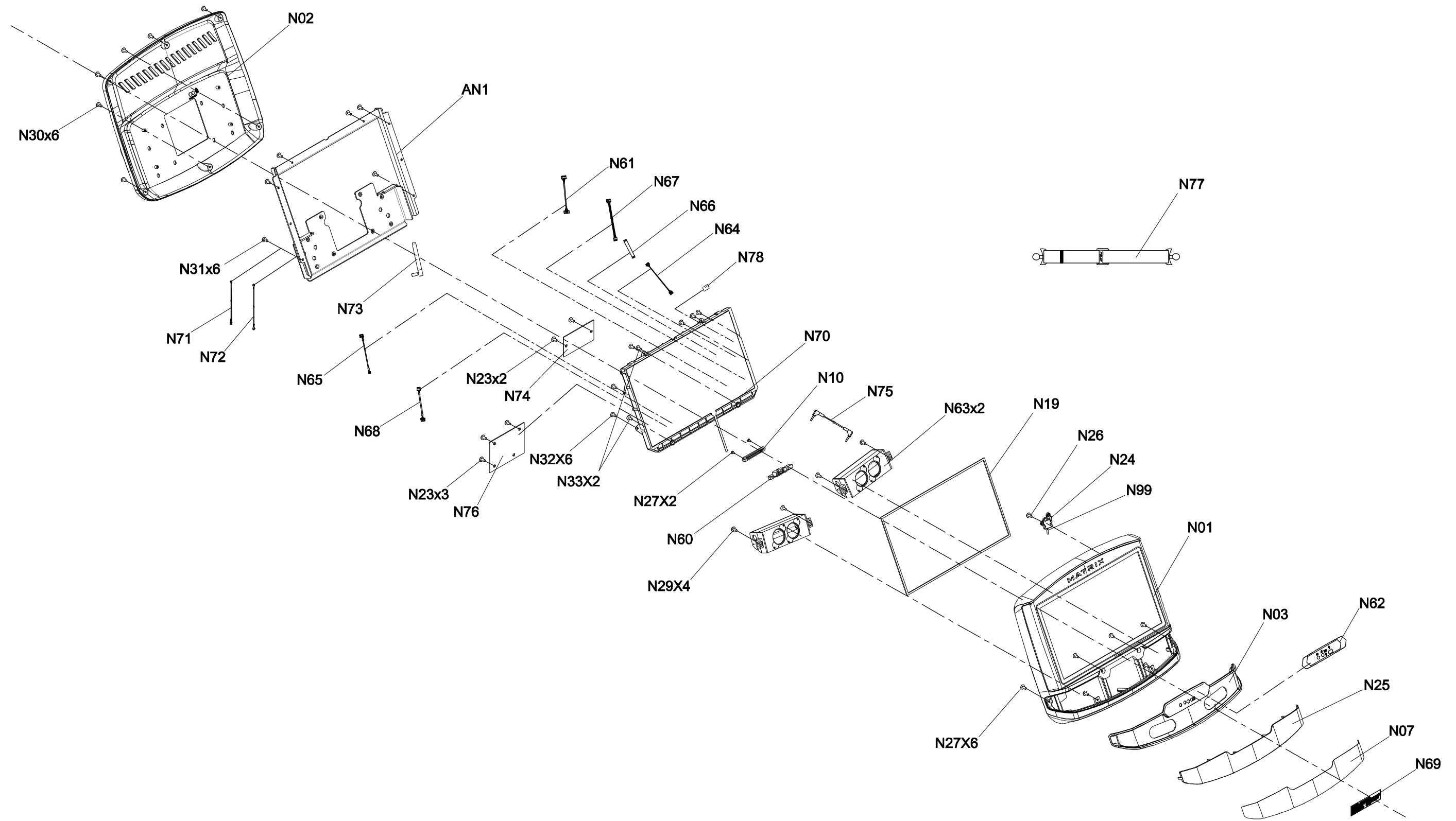

DRAWING NO	TM699-AN3		
PART NAME	Label set;;;POP;English		
PART NO	1000390281	REV	A
APPROVE	Harvey	DATE	2016.05.30

