

DRAWING NO	PEP599-1US-C		
PART NAME	Explode drawing		
PART NO	MEP0472-00	REV	A
APPROVE	Dragon Long	DATE	2016.6.20

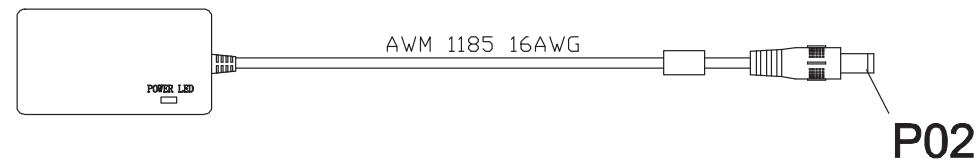

DRAWING NO	EP599-AW72		
PART NAME	control Set		
PART NO	1000389816	REV	A
APPROVE	Dragon Long	DATE	2016.6.20

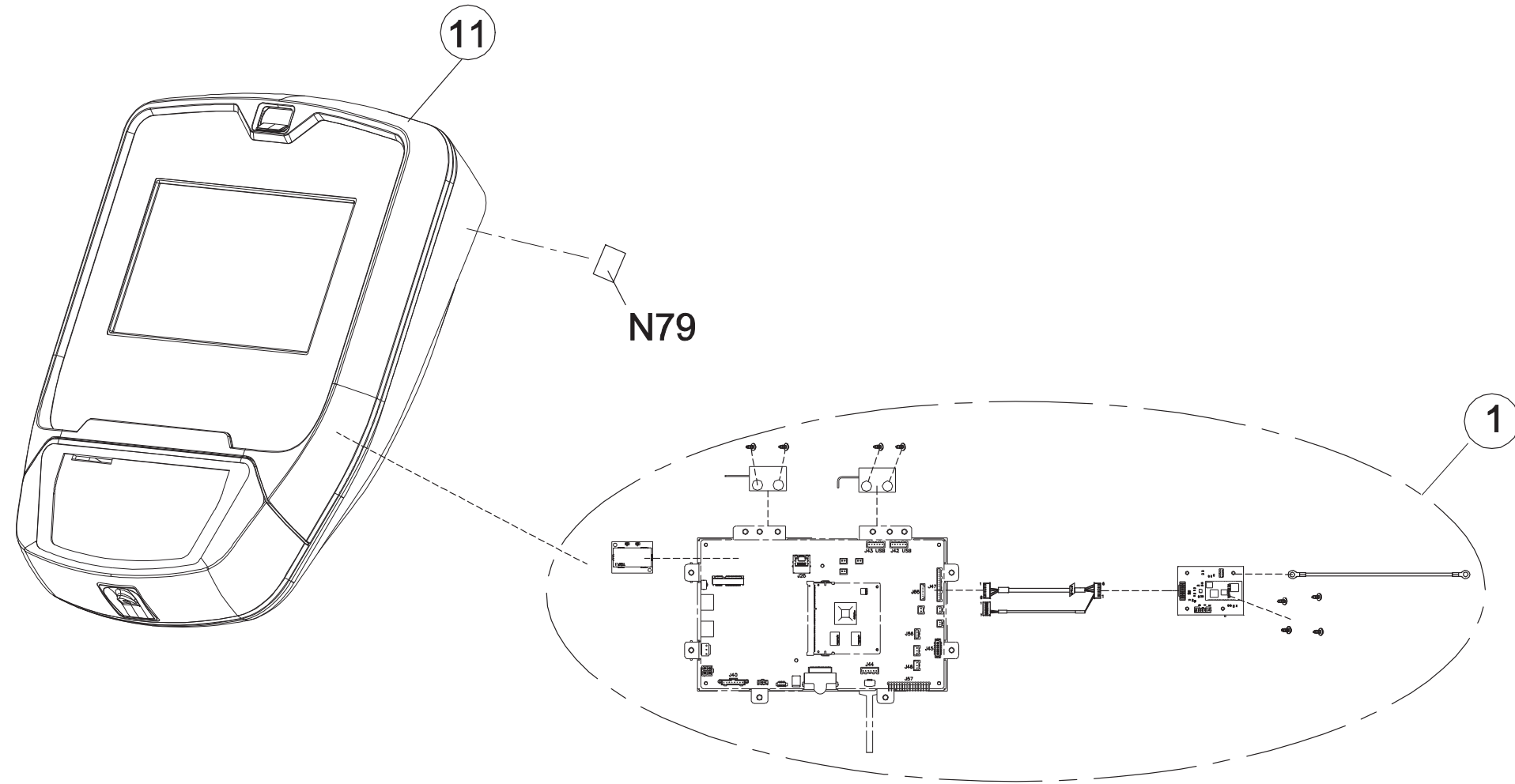
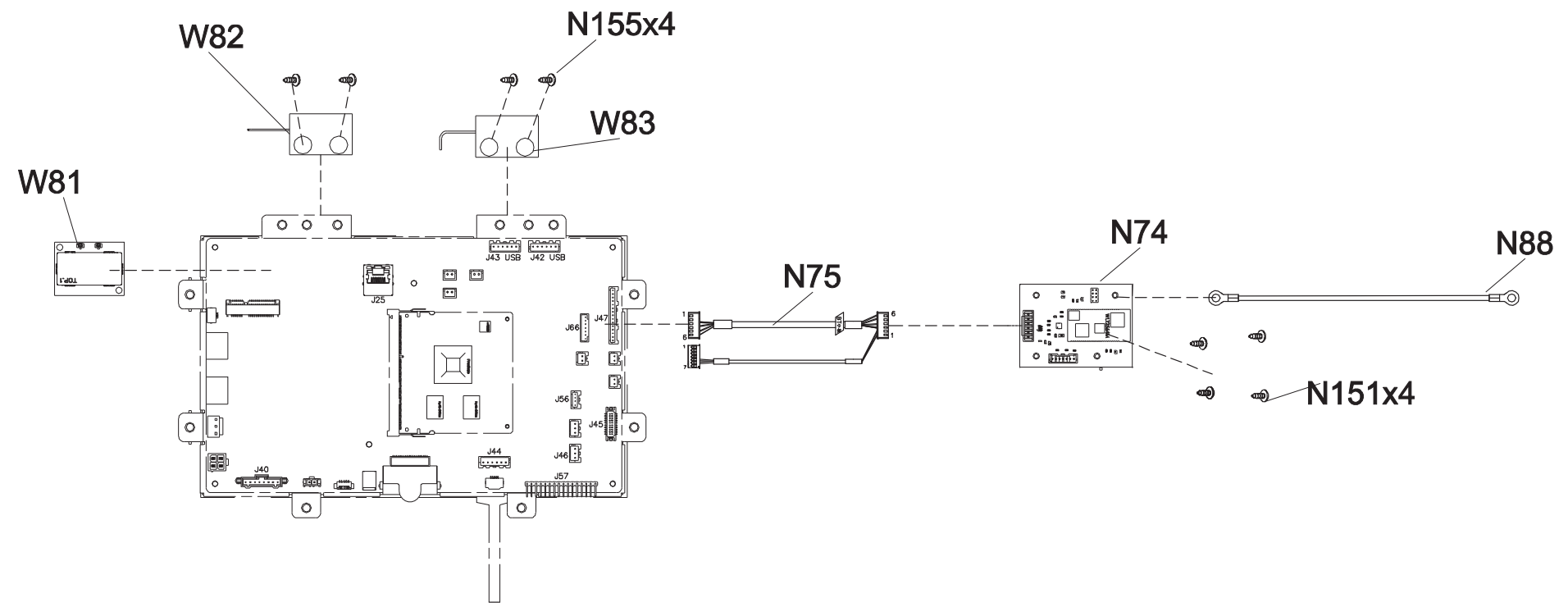

DRAWING NO	EP599-AN34		
PART NAME	Console Set		
PART NO	1000365246	REV	A
APPROVE	HERO	DATE	2016.7.11

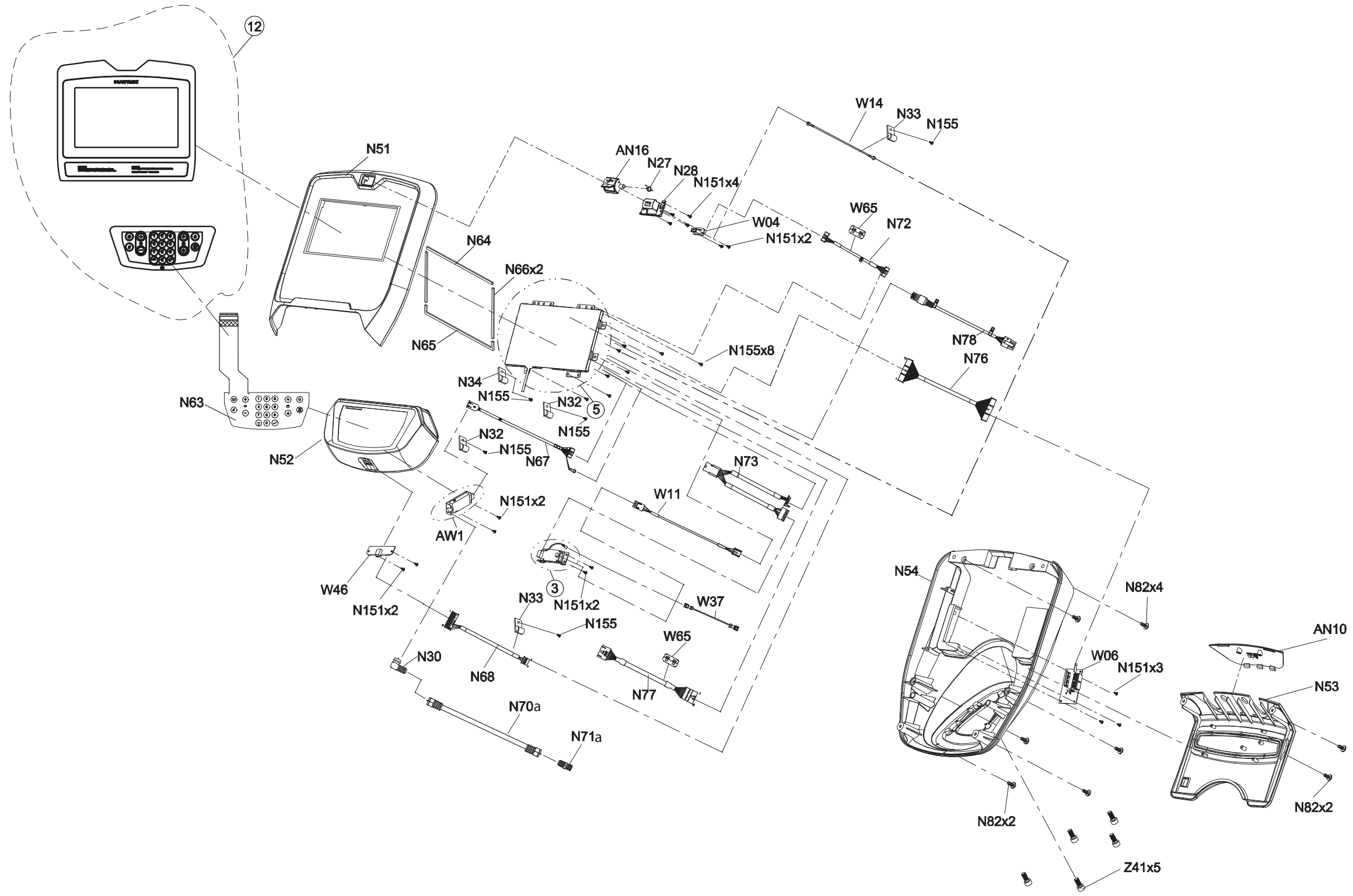

DRAWING NO	EP599-AN6		
PART NAME	Panel Set		
PART NO		REV	A
APPROVE	Dragon Long	DATE	2016.6.23

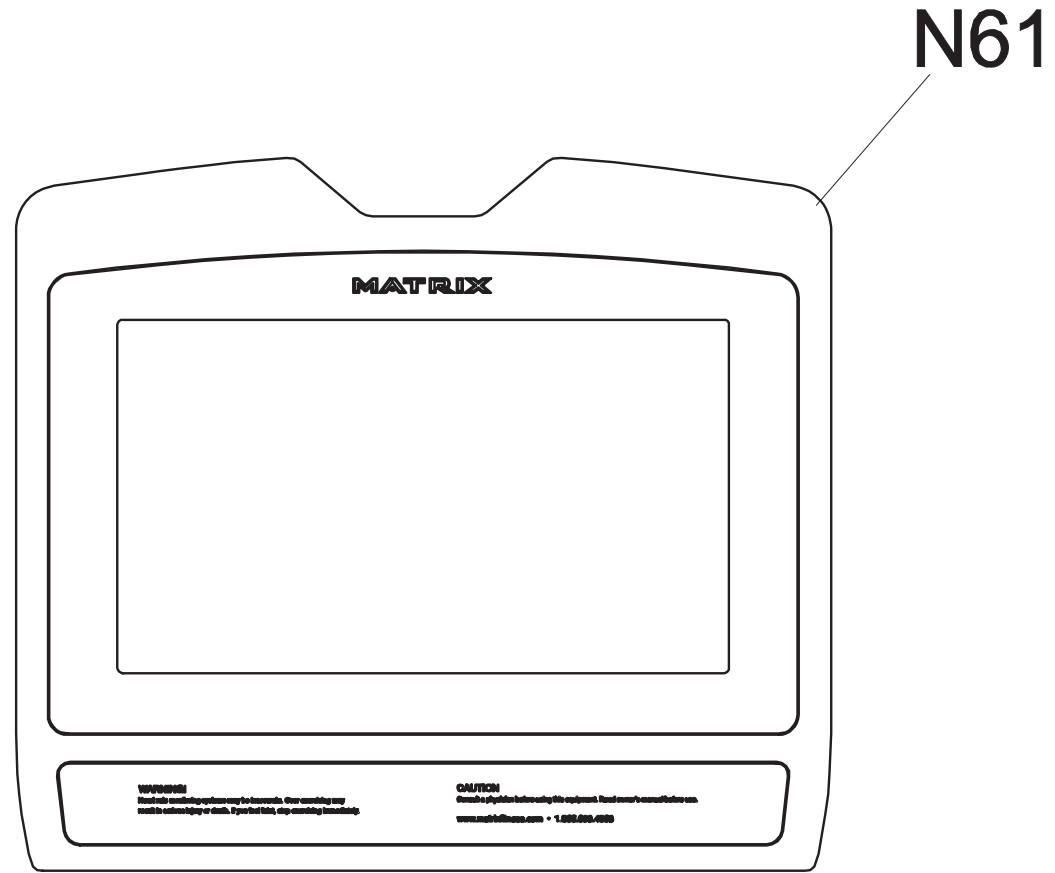

SAP NO.	Material specification
1000366939	面板組;;;英文;EP599;;
1000382466	面板組;;;德文;EP599
1000382468	面板組;;;西班牙文;EP599;;
1000382469	面板組;;;法文;EP599;;
1000382470	面板組;;;義大利文;EP599;;
1000382471	面板組;;;荷蘭文;EP599;;
1000382477	面板組;;;波蘭文;EP599;;
1000382480	面板組;;;葡萄牙文;EP599;;
1000382482	面板組;;;中文繁體+英文;;EP599;;
1000384318	儀表組;;;丹麥;;EP599;;
1000382481	面板組;;;日文;EP599;;

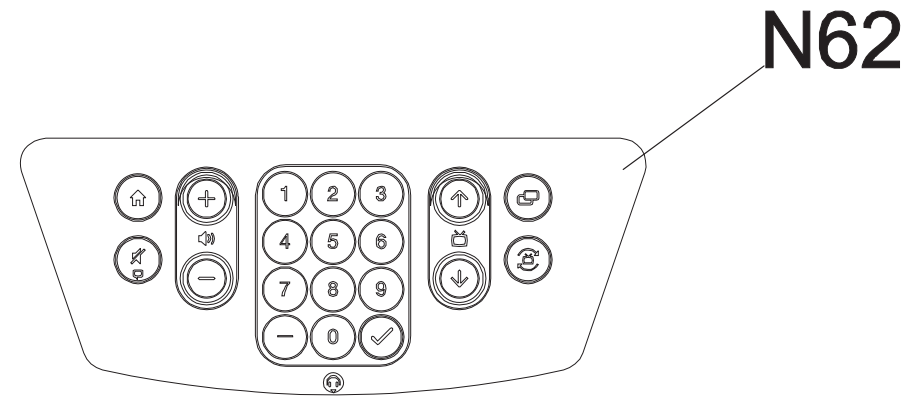

DRAWING NO	EP93C-AN51		
PART NAME	Heart Board Set		
PART NO	1000208535	REV	A
APPROVE	Dragon Long	DATE	2016.6.20

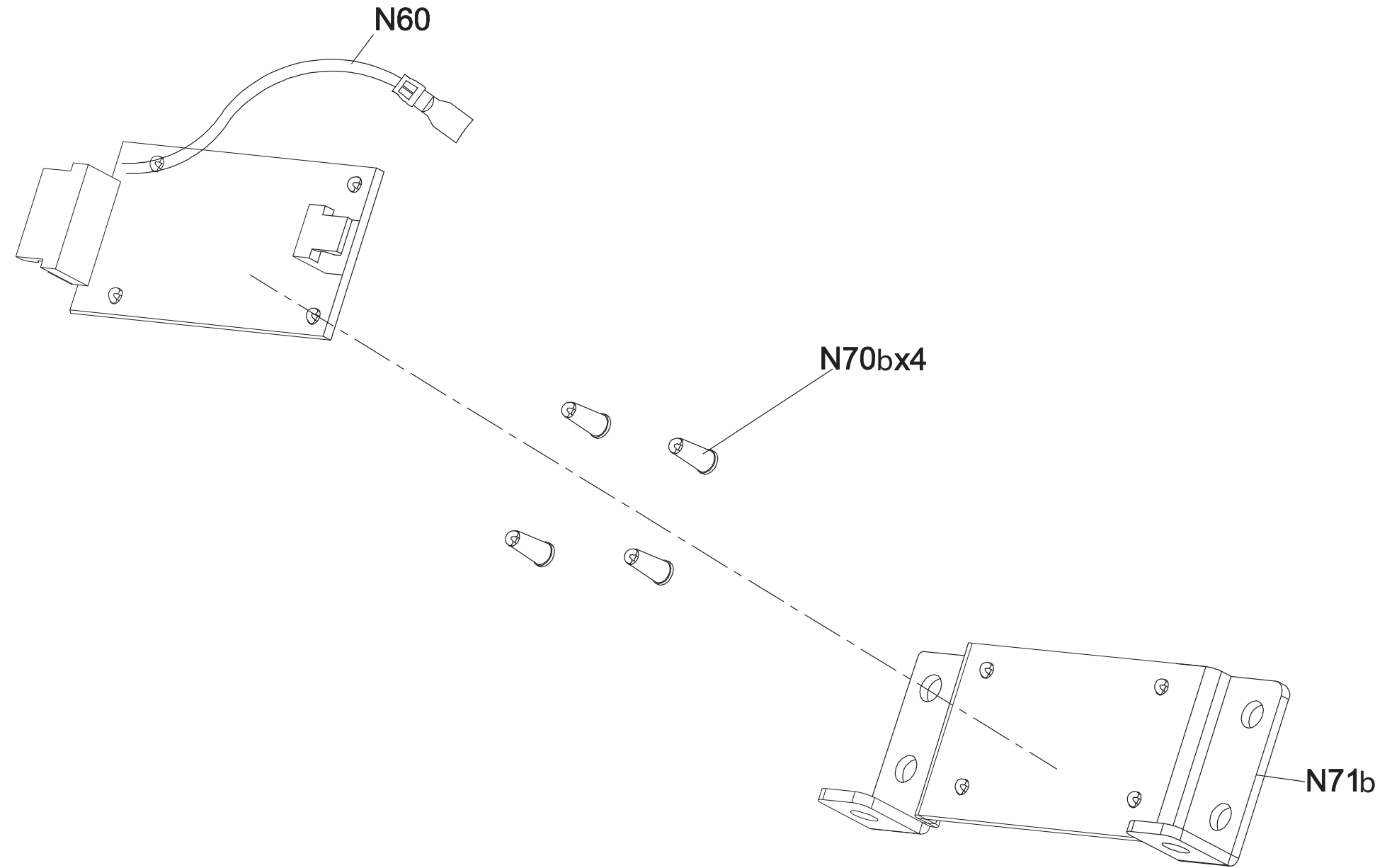

DRAWING NO	EP599-AW1		
PART NAME	Control Board Set		
PART NO	1000366459	REV	A
APPROVE	Dragon Long	DATE	2016.6.20

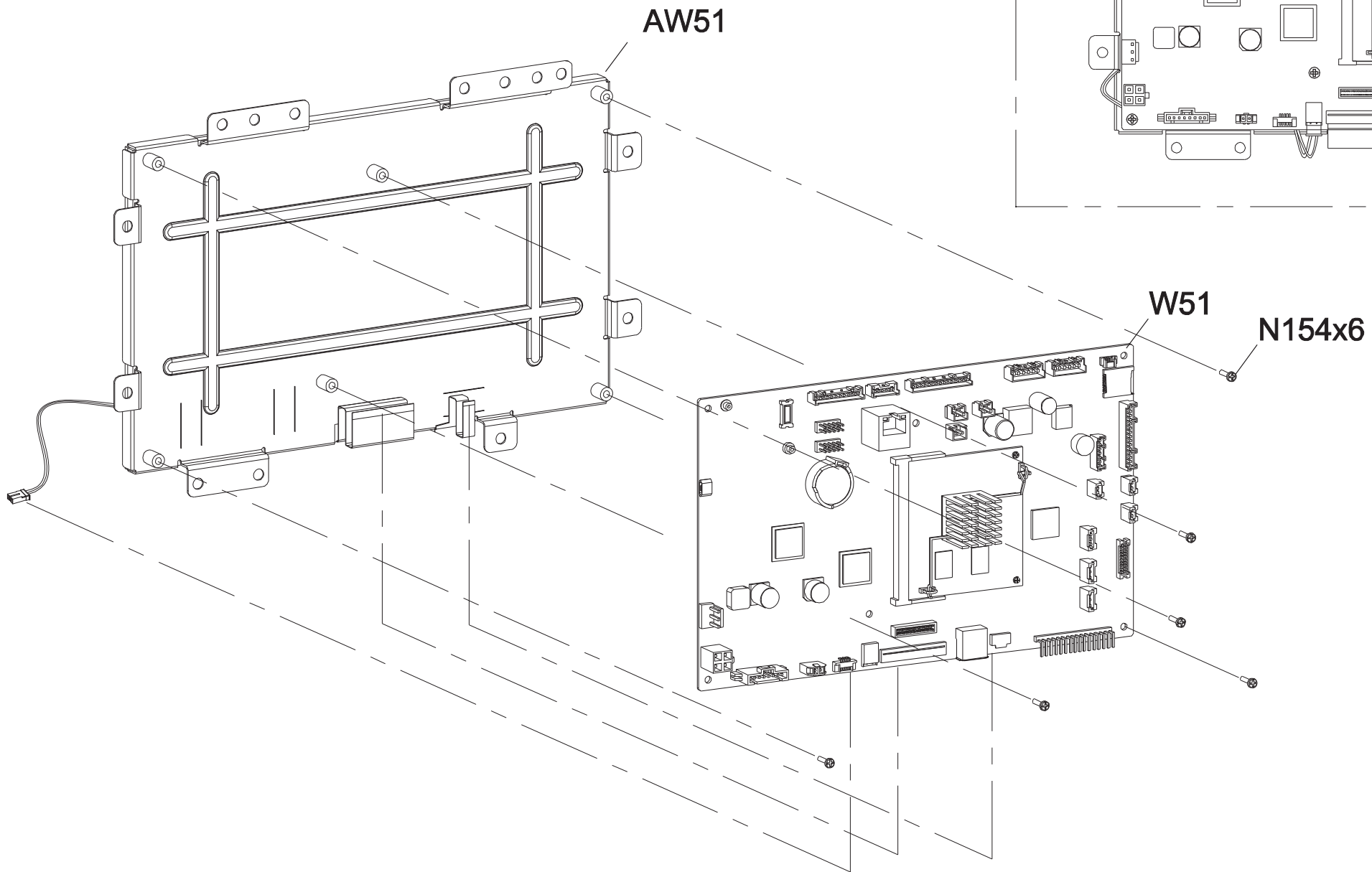
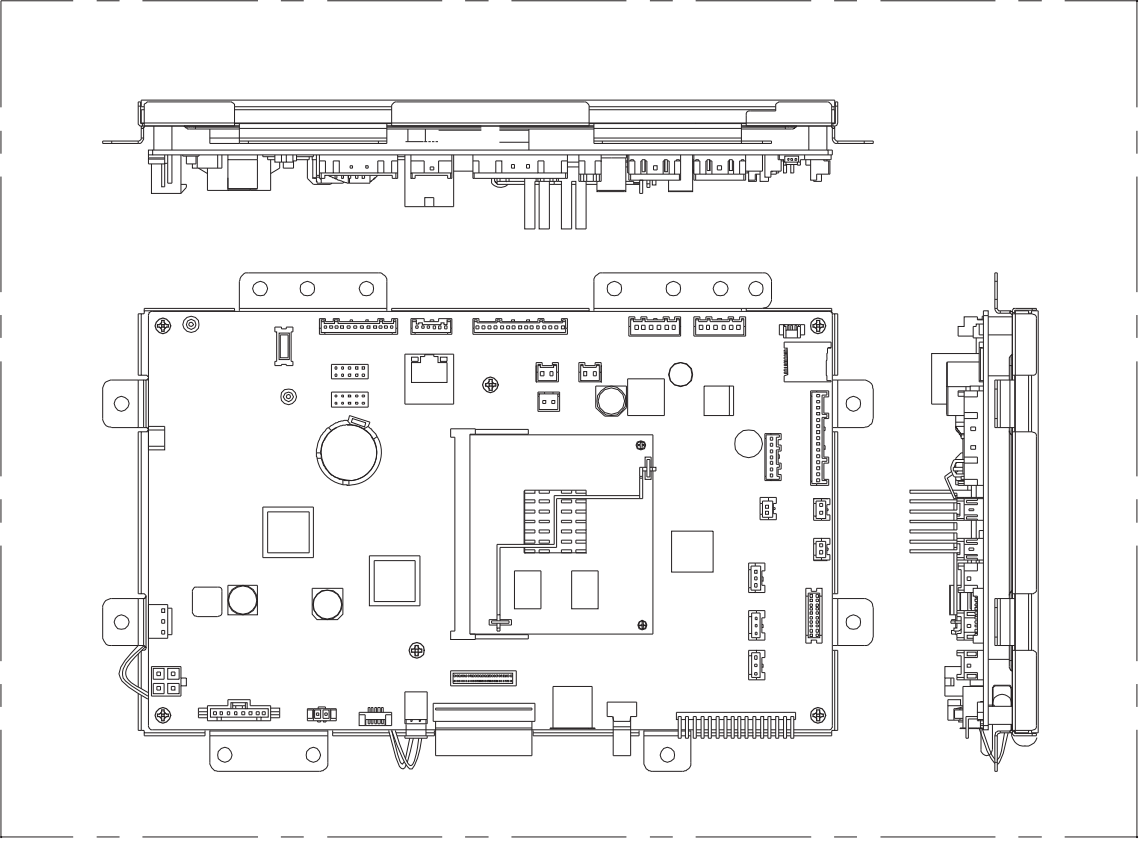

DRAWING NO	EP625-AW55		
PART NAME	Panel Board Set		
PART NO	1000378955 B		
APPROVE	Gingo	DATE	20151204

微星(MSI) PANEL 板組示意圖

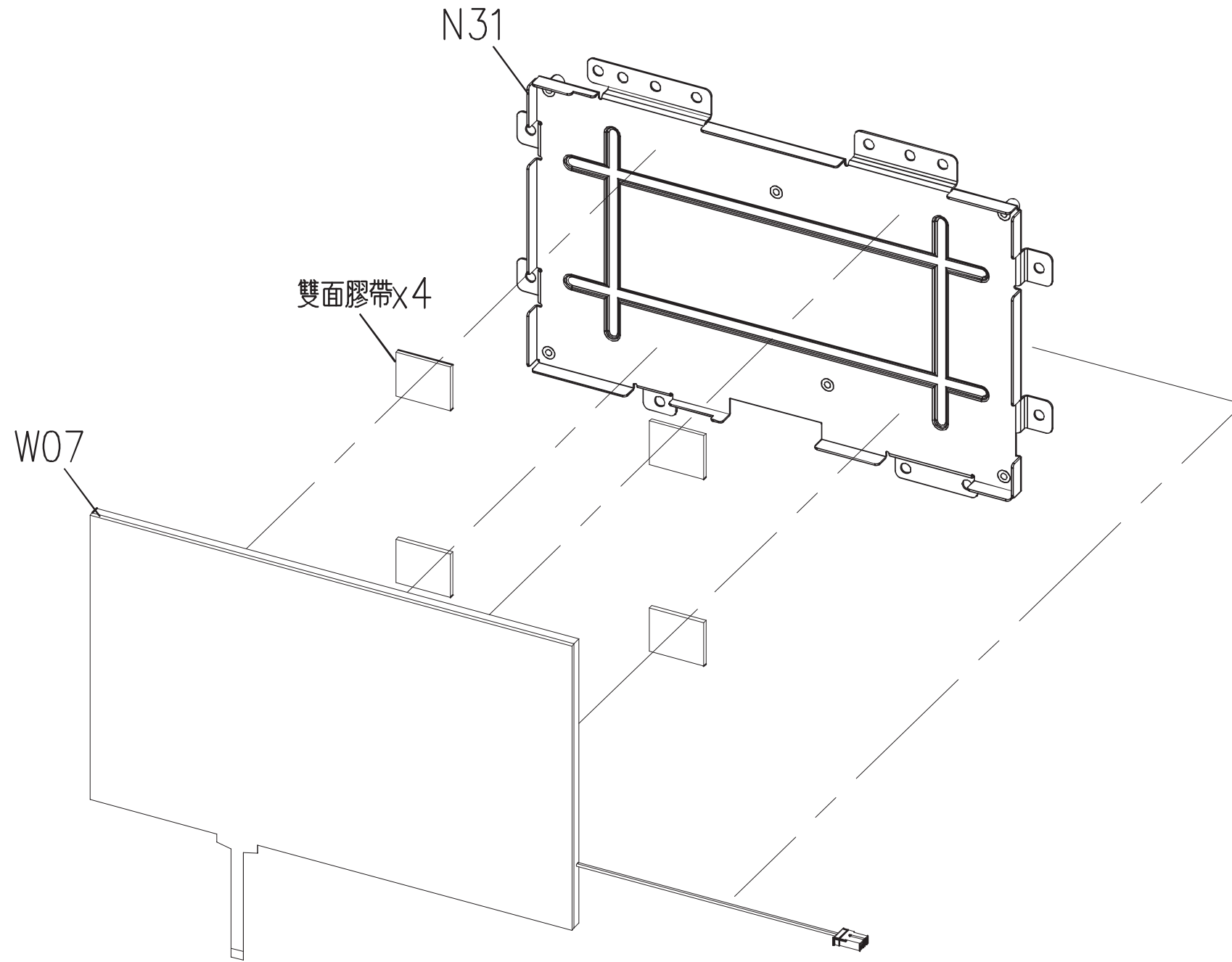
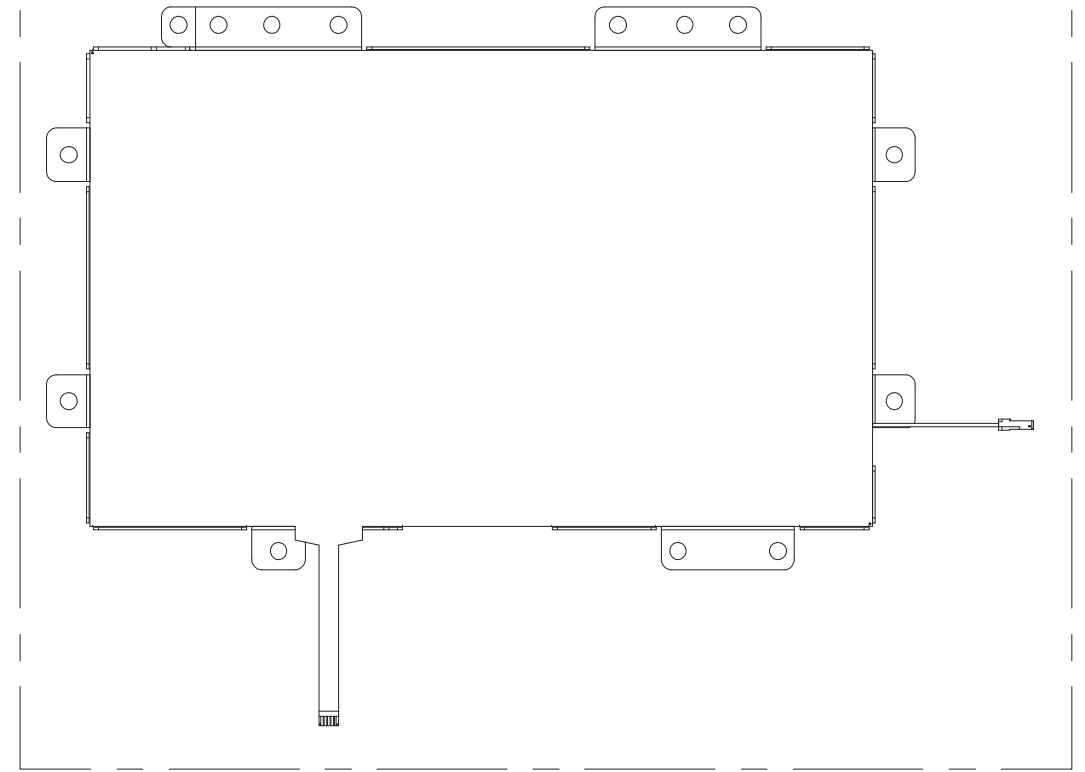

備註: 1. 此物料為微星(MSI) 客供料
 2. 硬體版次、軟體版本請見SAP

DRAWING NO	EP614C-AW51		
PART NAME	TV STICK SET		
PART NO	1000356574	REV	C
APPROVE	Dragon Long	DATE	2016.6.20

