

# Elevation Series Engage

15DT-INTXP-01M

## Parts Manual

1/5/2019 3:03:14 AM

**Table of Contents**

---

[Bezels](#).....3  
[Console Pcb's And Cables - Cables](#).....4  
[Console Pcb's And Cables - Pcb's](#).....5  
[Display Components](#).....6  
[Serial Number Table](#).....7

## Bezels

---



Ref #	Part Number	Qty	Description
BZ-001	AK70-00020-0000	1	Front Bezel "E" Tread World
BZ-003	AK70-00014-0000	1	Assembly: Console Back CaseTi/Te

## Console Pcb's And Cables - Cables

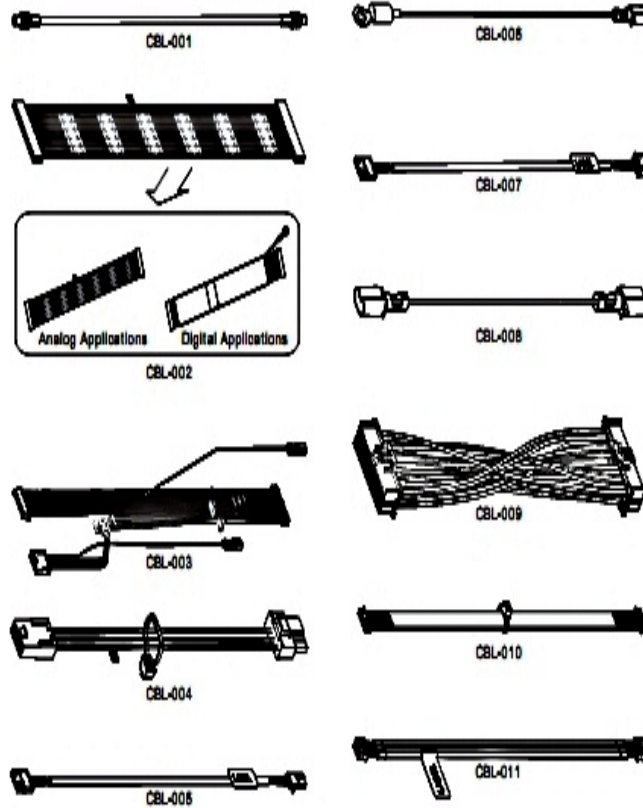

Ref #	Part Number	Qty	Description
CBL-001	AK65-00056-0000	1	Short Coax Cable
CBL-002	AK65-00061-0000	1	Cable: Single Board Controller 15" LCD
CBL-003	AK65-00041-0000	1	Cable: Single Board Controller - User Opt
CBL-004	AK65-00102-0001	1	Cable: External Headphone
CBL-005	AK70-00037-0000	1	Cable: Unencoded Polar
CBL-006	AK65-00103-0000	1	Ground ESD Cable
CBL-010	AK65-00057-0001	1	Cable: Single Board Controller to Inverter 3.5"
CBL-010	AK65-00057-0000	1	Cable: Single Board Controller - Inverter

## Console Pcb's And Cables - Pcb's

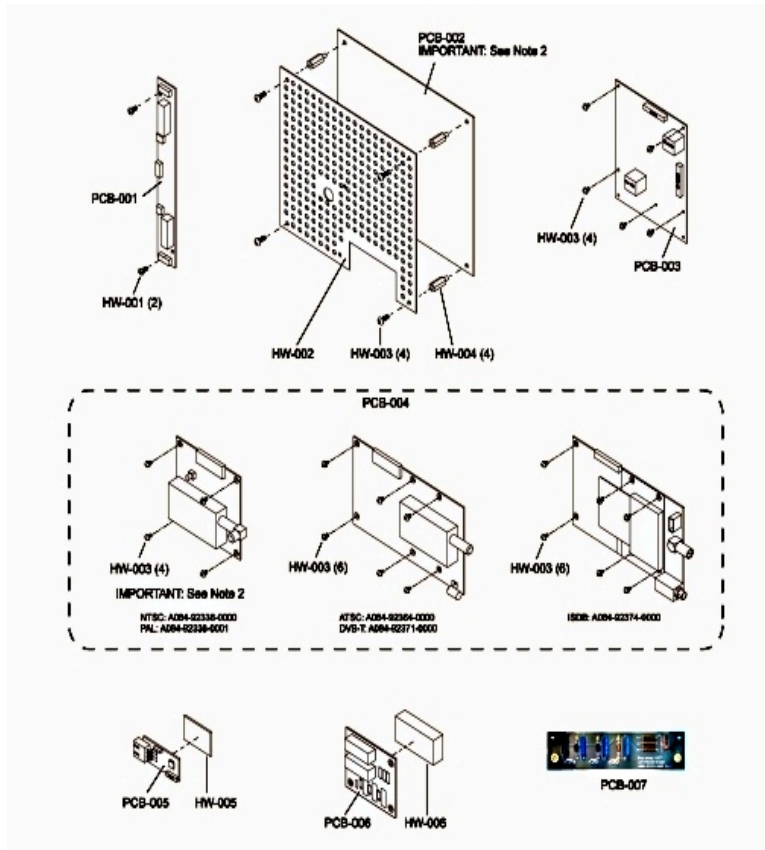

Ref #	Part Number	Qty	Description
PCB-001	135E-00002-0006	1	PCB: Inverter; 12V 6W -20-+70C
PCB-001	135E-00002-0007	1	Inverter for CCFL
PCB-002	B084-92338-0001	1	PCB Assembly Analog Tuner; PAL; BM only
PCB-003	A084-92335-0001	1	Programmed PCB
PCB-004	A084-92334-0000	1	Programmed DSP PCB Assy APOLLO Machine Interface Board
PCB-005	B084-92353-0000	1	PCB: ESD HD Phone

## Display Components

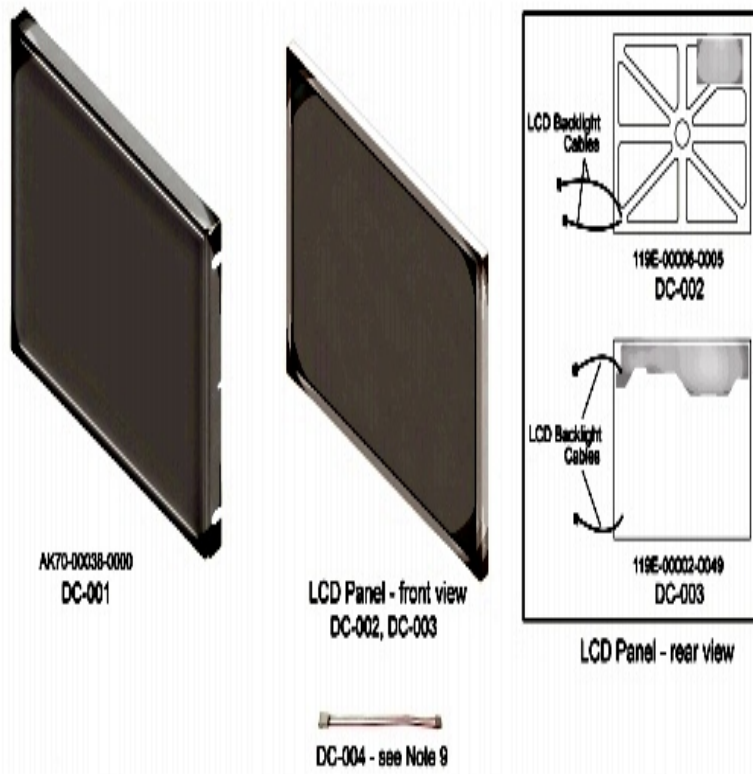

Ref #	Part Number	Qty	Description
DC-001	AK70-00038-0001	1	ASSY: BOLT-ON TOUCHSCREEN W/FLANGE & GASKET
DC-002,DC-003	119E-00002-0049	2	15-Inch LCD Non-PSWG

# Serial Number Table

### Treadmill Consoles - Analog

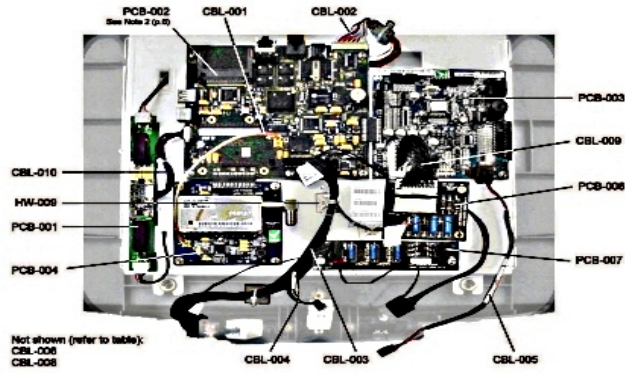

### Non-Treadmill Consoles - Analog

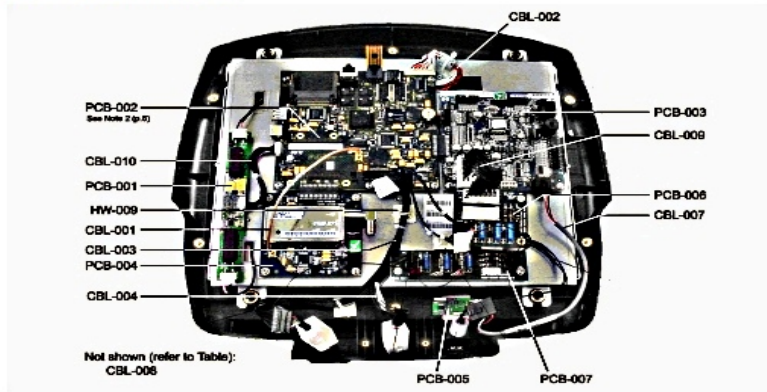

**Treadmill Consoles - Digital**

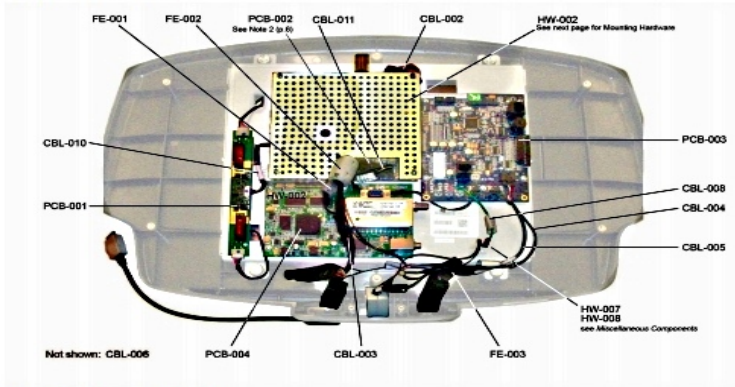

**Non-Treadmill Consoles - Digital**

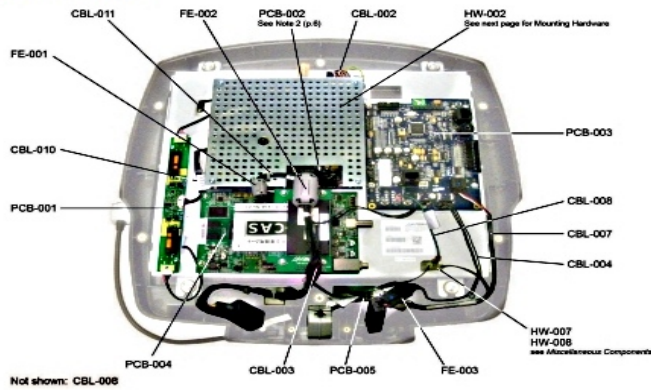

Ref #	Part Number	Qty	Description
-	15DT-INTXP-01	2	15 inch Engage Treadmill Console International PAL
-	15DT-INTXP-01	2	15 inch Engage Treadmill Console International PAL
-	15DT-INTXP-01	2	15 inch Engage Treadmill Console International PAL
-	15DT-INTXP-01	2	15 inch Engage Treadmill Console International PAL

