

# Elevation Series - 95R Recumbent Lifecycle Exercise Bike

95R-ALLXX-03

## Parts Manual

1/5/2019 10:08:54 AM



## Table of Contents

---

<a href="#">Base Frame Electronics - Cables.....</a>	<a href="#">3</a>
<a href="#">Base Frame Electronics - Generator and GBC Assembly.....</a>	<a href="#">4</a>
<a href="#">Drive System - Idler Assembly.....</a>	<a href="#">6</a>
<a href="#">Drive System - Pedals and Cranks.....</a>	<a href="#">7</a>
<a href="#">Drive System - Pully and Belt.....</a>	<a href="#">8</a>
<a href="#">Heart Rate System - Seat Handle Components.....</a>	<a href="#">9</a>
<a href="#">Lower Frame - Battery and Power Pack Assembly.....</a>	<a href="#">10</a>
<a href="#">Lower Frame - Front Stabilizer, Leg Leveler and Components.....</a>	<a href="#">11</a>
<a href="#">Miscellaneous.....</a>	<a href="#">12</a>
<a href="#">Seat Assembly - Carriage Assembly.....</a>	<a href="#">13</a>
<a href="#">Seat Assembly - Extrusion Assembly.....</a>	<a href="#">14</a>
<a href="#">Seat Assembly - Optional Recumbent Arm Rests.....</a>	<a href="#">15</a>
<a href="#">Seat Assembly - Seat Pad and Back Pad.....</a>	<a href="#">16</a>
<a href="#">Upper Frame - Monocolumn Assembly.....</a>	<a href="#">17</a>
<a href="#">Upper Frame - Shrouds.....</a>	<a href="#">18</a>

## Base Frame Electronics - Cables

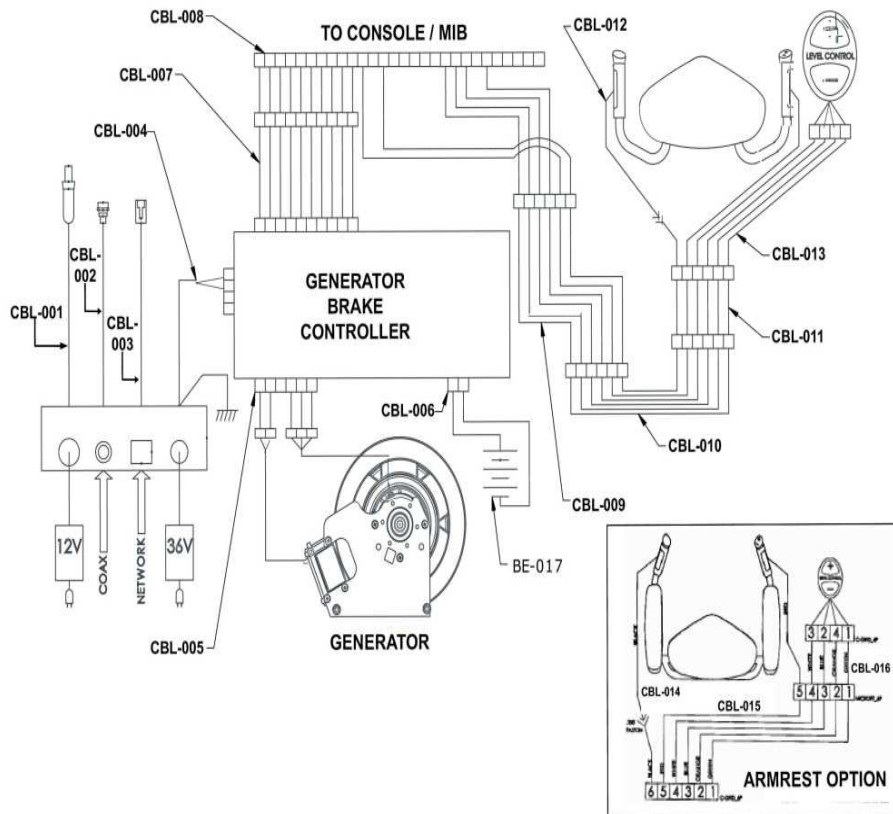

Ref #	Part Number	Qty	Description
CB-001	AK32-00160-0000	1	Ext Power Cable with Ferrite
CB-002	AK65-00062-0000	1	Cable: Coax RG6 Base
CB-003	AK65-00051-0001	1	C-safe Network Cable 65"
CB-004	AK67-00108-0000	1	External Power Cable
CB-005	AK66-00107-0000	1	Generator/Brake Cable
CB-006	AK66-00109-0000	1	Battery cable: Recumbent
CB-007	AK66-00106-0000	1	PCB to Console Cable: Recumbent
CB-008	AK66-00105-0000	1	Console/Handlebar Cable - Recumbent Bike
CB-009	AK66-00104-0000	1	Keypad/LifePulse Cable
CB-010	AK66-00103-0000	1	Flat Flex Cable Seat Adjustment
CB-011	AK66-00111-0000	1	Carriage Cable: Recumbent
CB-012	AK66-00101-0000	1	Cable: Handlebar; Recumbent
CB-013	AK66-00102-0000	1	Cable: Carriage Recumbent
CB-014	AK66-00101-0001	1	Cable Assembly: Armrest; Recumbent
CB-015	AK66-00179-0000	1	CABLE ASSY: LIFE PULSE, RECUMBENT ARMREST, RIGHT TUBE
CB-016	AK66-00180-0000	1	CABLE ASSY: LIFE PULSE, RECUMBENT ARMREST/SWITCH, RIGHT

## Base Frame Electronics - Generator and GBC Assembly

---

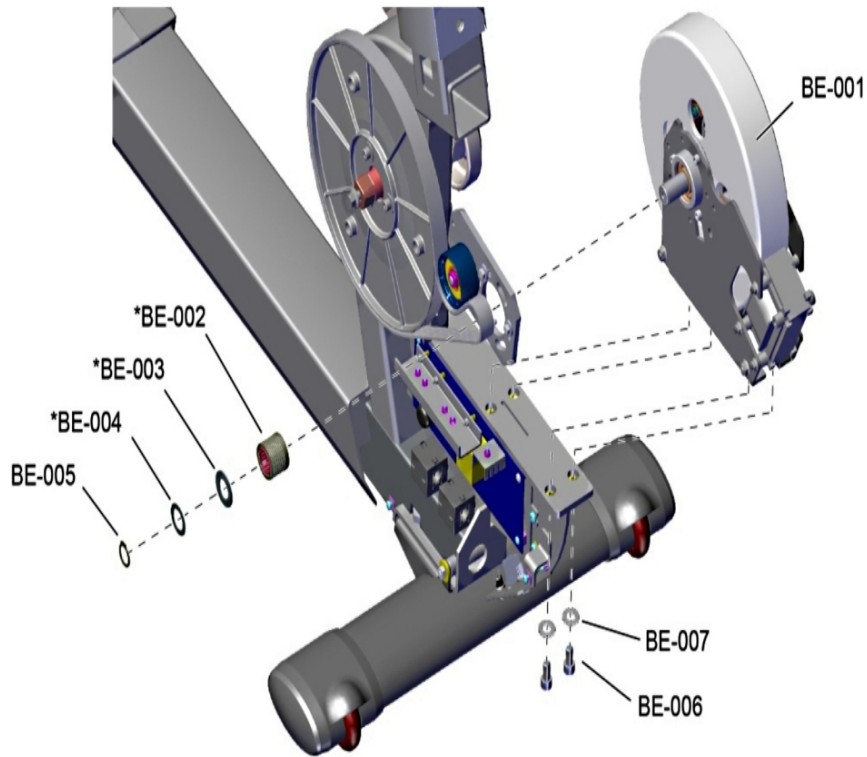

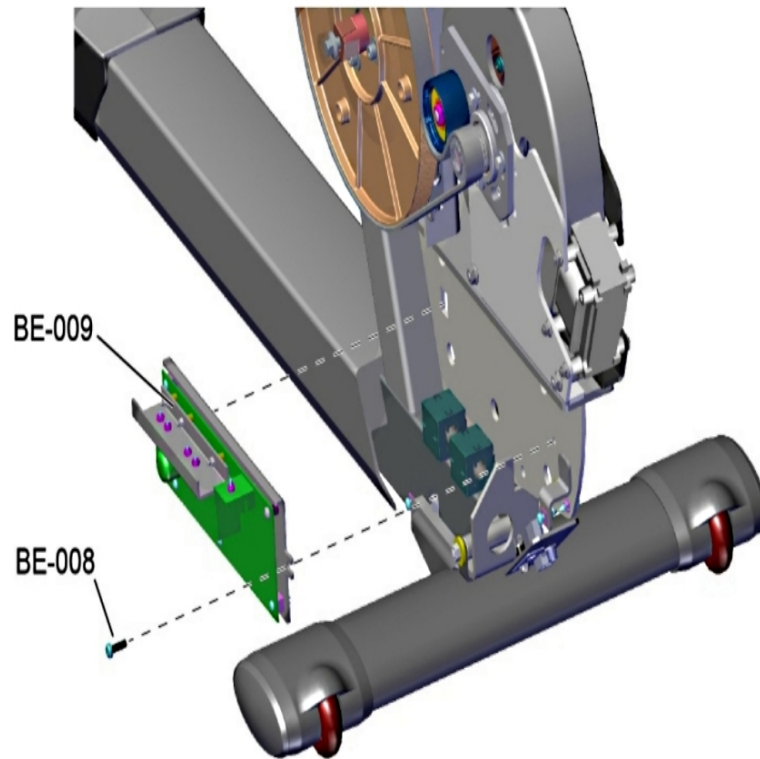

Ref #	Part Number	Qty	Description
BE-001	AK66-00138-0001	1	GEN/BRAKE: EXT. PURCH.
BE-002	AK66-00139-0000	1	Clutch and Pulley Assembly
BE-003	0K66-01237-0000	1	Hardware: Shaft Washer Large
BE-004	0017-00104-0498	1	Hardware: Shaft Washer Small .734' OD
BE-005	0017-00100-0257	1	Retaining Ring
BE-006	0017-00101-1920	4	Hardware: Mounting Screw 16MM
BE-007	0017-00104-0479	4	Hardware: Flat Washer 25.4MM OD
BE-008	0017-00101-1986	1	Hardware: Mounting Screw 16MM
BE-009	AK66-00100-0006	1	PWR-PCB BRKT ASSY W/ SOFTWARE

## Drive System - Idler Assembly

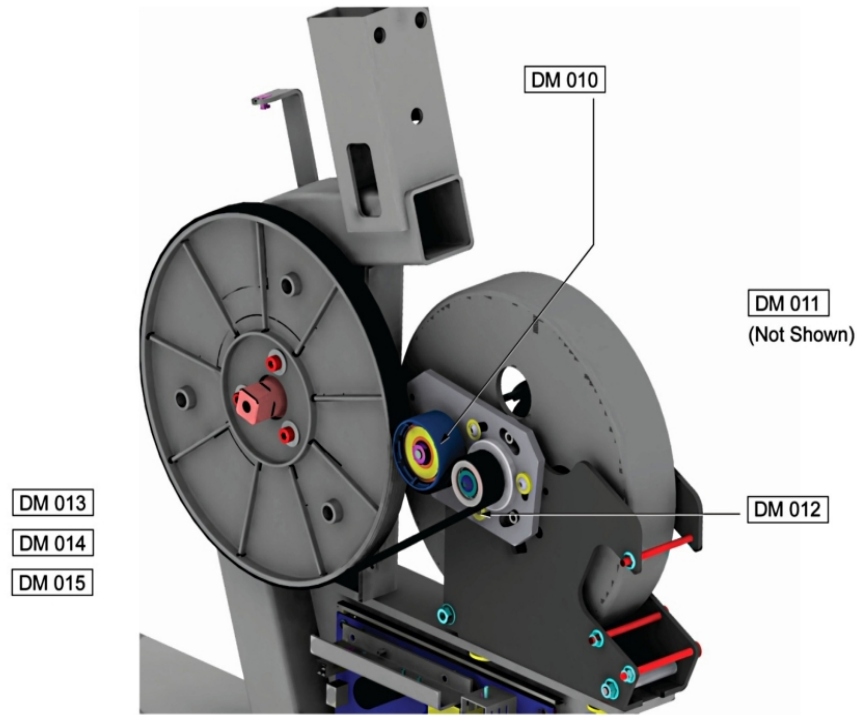

Ref #	Part Number	Qty	Description
DM-010,D M-014	AK66-00145-0000	2	Idler Assembly
DM-011	0K66-01092-0000	1	Idler Spring
DM-012	0017-00101-1894	1	Hardware: Idler Assembly Mounting Bolt 16MM
DM-013	AK66-00122-0000	1	Idler Bracket
DM-015	0017-00103-0338	1	Hardware: Hex Nut 8 MM

## Drive System - Pedals and Cranks



Ref #	Part Number	Qty	Description
DM-001	0K76-01054-0000	1	Right Crank Arm
DM-002	0K76-01053-0000	1	Left Crank Arm
DM-003	AK66-00047-0001	1	Right Pedal W/ Strap Assembly
DM-004	AK66-00048-0001	1	Left Pedal W/ Strap Assembly
DM-007	0K66-01096-0000	2	Crank Connector Plate
DM-008	0K66-01121-0000	2	Crank Cap
DM-009	0017-00101-2043	2	Hardware: Crank Screw 25MM
DM-009	0017-00101-2077	2	Hardware: Screw 30MM

## Drive System - Pulley and Belt

---

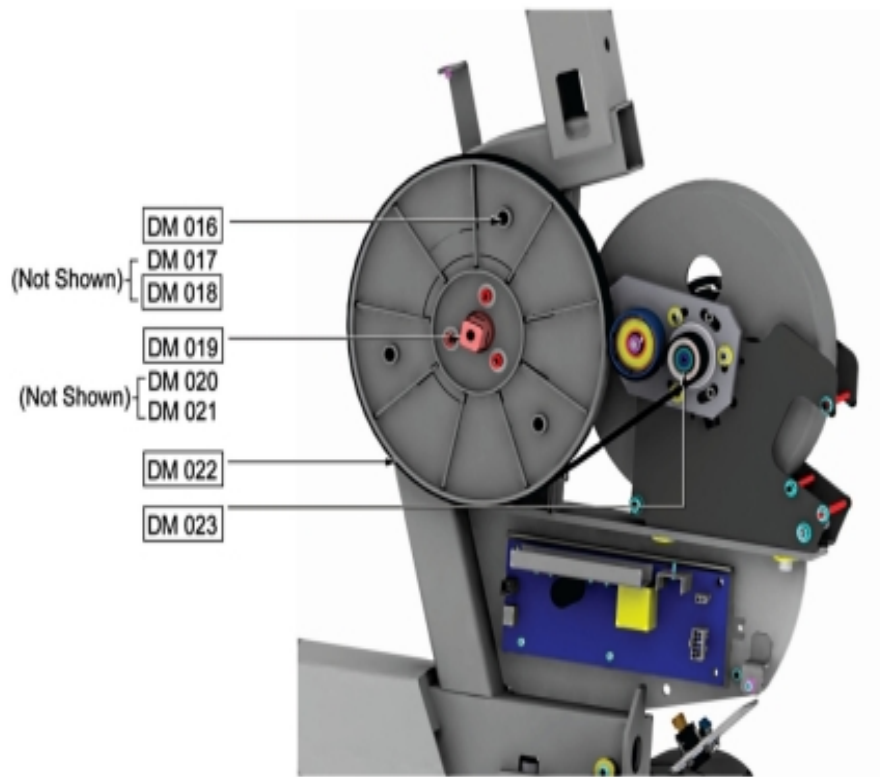

Ref #	Part Number	Qty	Description
DM-016	0K66-01005-0000	1	Crank Pulley
DM-017,D M-018	0017-00101-1891	2	Hardware: Mounting Screw 16MM
DM-019	AK66-00003-0001	1	Crank/Hub Bearing Shaft Assembly
DM-020	0017-00101-1881	1	Hardware: Screw 20 MM
DM-021	0017-00104-0469	1	Hardware: Flat Washer 16MM OD
DM-022	0017-00009-0837	1	Poly-V Drive Belt
DM-023	AK66-00139-0000	1	Clutch and Pulley Assembly

## Heart Rate System - Seat Handle Components

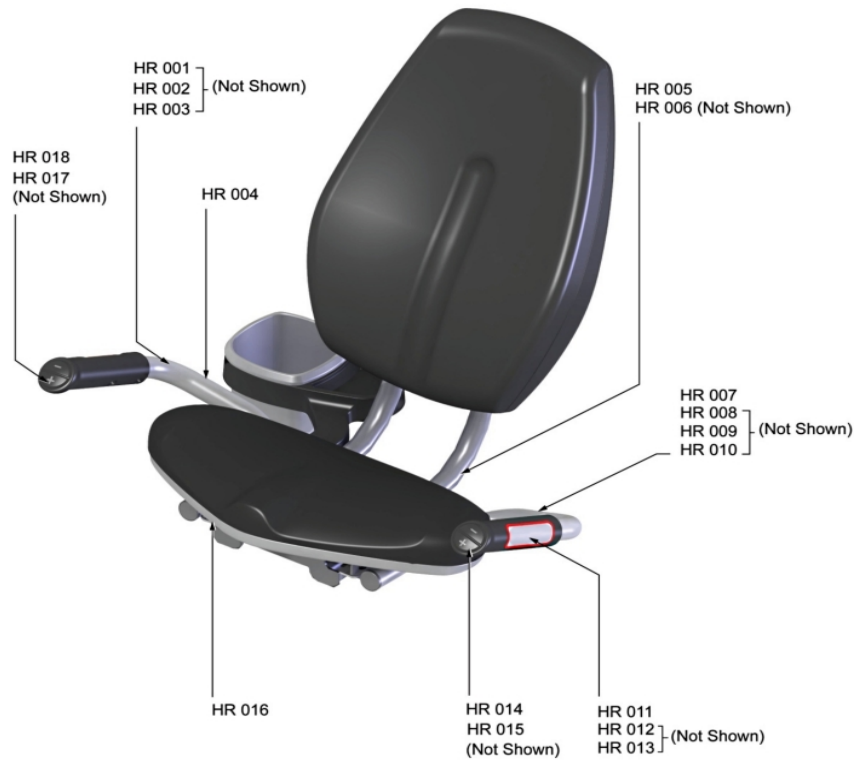

Ref #	Part Number	Qty	Description
HR-001	AK66-00102-0000	1	Cable: Carriage Recumbent
HR-002,HR-006,HR-009	0017-00101-1881	3	Hardware: Screw 20 MM
HR-003,HR-010	0017-00104-0469	2	Hardware: Flat Washer 16MM OD
HR-004,HR-005,HR-007	GK66-00002-0007	3	KIT: ELEVATION REC HANDLEBAR/SEAT FRAME CONV
HR-008	AK66-00101-0000	1	Cable: Handlebar; Recumbent
HR-011	AK63-00014-0004	1	Heart Rate Electrode
HR-012	0K66-01141-0000	1	Insulator Plug
HR-013	0017-00101-1720	1	Hardware: Mounting Screw 1"
HR-014	0K69-01166-0000	1	Dummy End Cap
HR-015,HR-017	0017-00101-2032	2	Hardware: Mounting Screw
HR-016	0K66-01143-0000	1	Seat Frame End Cap - 1.125"
HR-018	AK69-00100-0000	1	Resistance Level Button Assembly

## Lower Frame - Battery and Power Pack Assembly

---



Ref #	Part Number	Qty	Description
LF-008	0017-00003-0685	1	6V Battery
LF-009	0017-00101-1796	1	Hardware: Mounting Screw 19 MM
LF-010	AK66-00036-0000	1	Bracket Assembly: Power/Coax Input

## Lower Frame - Front Stabilizer, Leg Leveler and Components

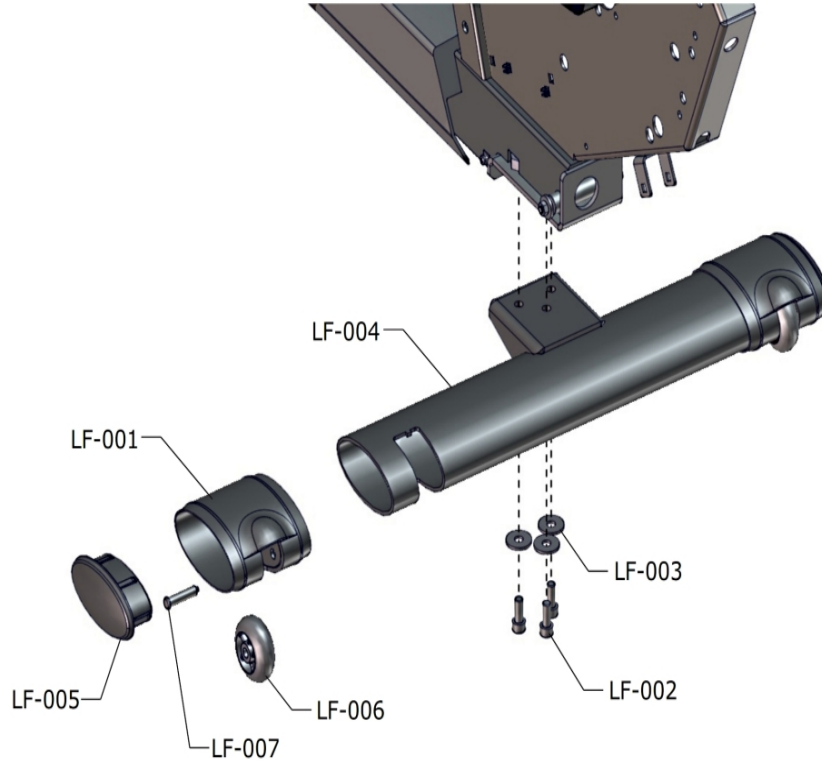

Ref #	Part Number	Qty	Description
LF-001	0K66-01041-0000	2	Shorud Stabilizer Front
LF-002	0017-00101-1881	3	Hardware: Screw 20 MM
LF-003	0017-00104-0479	3	Hardware: Flat Washer 25.4MM OD
LF-004	0K66-01042-0000	1	End Cap (Front and Rear)
LF-005	AK66-00016-0001	2	Front Stabilizer
LF-006	0K66-01039-0000	2	Wheel
LF-007	0K66-01040-0000	1	Wheel Shaft

## Miscellaneous

---

Ref #	Part Number	Qty	Description
MISC-002	0017-00003-1051	1	POWER SUPPLY: 39VDC, 1.66A
MISC-003	0017-00003-0889	1	Line Cord Cont U.K. 10A
MISC-003	0017-00003-0918	1	Line Cord - Australia
MISC-003	0017-00003-0704	1	Line Cord 10A 125 V
MISC-003	0017-00003-0691	1	Line Cord Cont 10A 250 V
MISC-004	0017-00008-0204	1	Paint Spray Can - Arctic Silver
MISC-005	0017-00008-0205	1	5 oz Bottle - Arctic Silver
MISC-006	0017-00008-0206	1	.33oz Pen - Arctic Silver
MISC-007	AK66-00036-0000	1	Bracket Assembly: Power/Coax Input
MISC-008	0K66-01063-0000	1	Power Coax Bracket
MISC-009	0017-00021-2846	1	F-Type Panel Connector
MISC-010	0017-00021-3195	1	COUPLER: CAT5E, SHIELDED, RJ45
MISC-011	AK66-00079-0000	1	Hardward Bag: Recumbent Bike
MISC-012	LCBCT-DOMLX-01	1	Kit: Bike/Cross-Trainer Domestic Line Cord LV

## Seat Assembly - Carriage Assembly

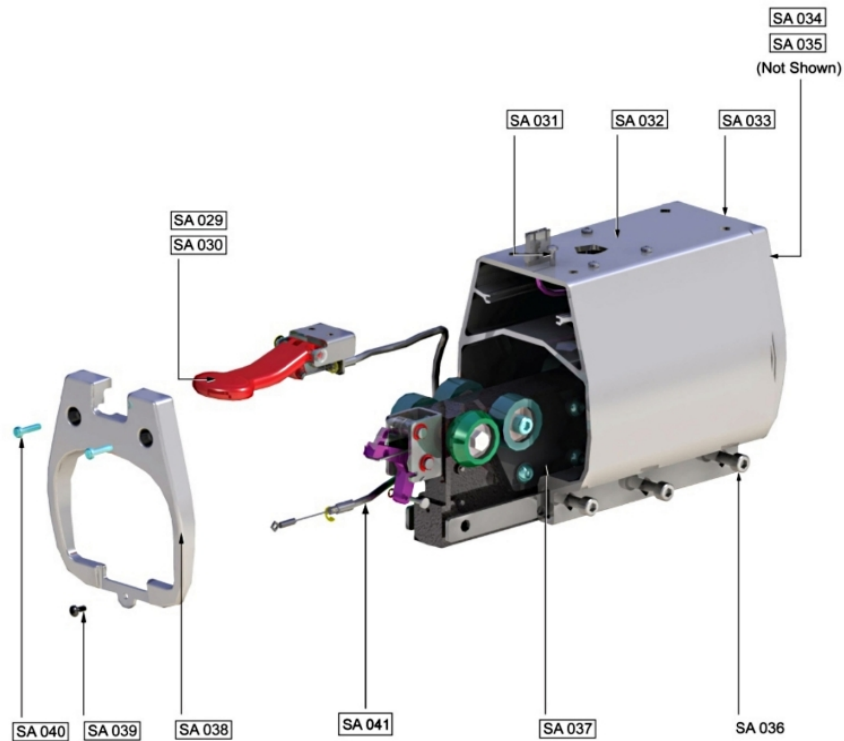

Ref #	Part Number	Qty	Description
SA-029,SA-041	AK66-00027-0000	2	Handle Assembly
SA-031	0017-00101-1874	1	Hardware: Handle Mounting Screw 16 MM
SA-032	0K66-01028-0000	1	Seat Carriage
SA-033	AK66-00087-0000	1	Rear Carriage Cover
SA-034,SA-040	0017-00101-2009	2	Hardware: Mounting Screw 0.75"
SA-035,SA-039	0017-00101-0233	2	Rear Cover Mounting Screw
SA-036	0017-00101-1881	3	Hardware: Screw 20 MM
SA-037	AK66-00009-0000	1	Roller Assembly
SA-038	0K66-01034-0000	1	Front Carriage Cover

## Seat Assembly - Extrusion Assembly

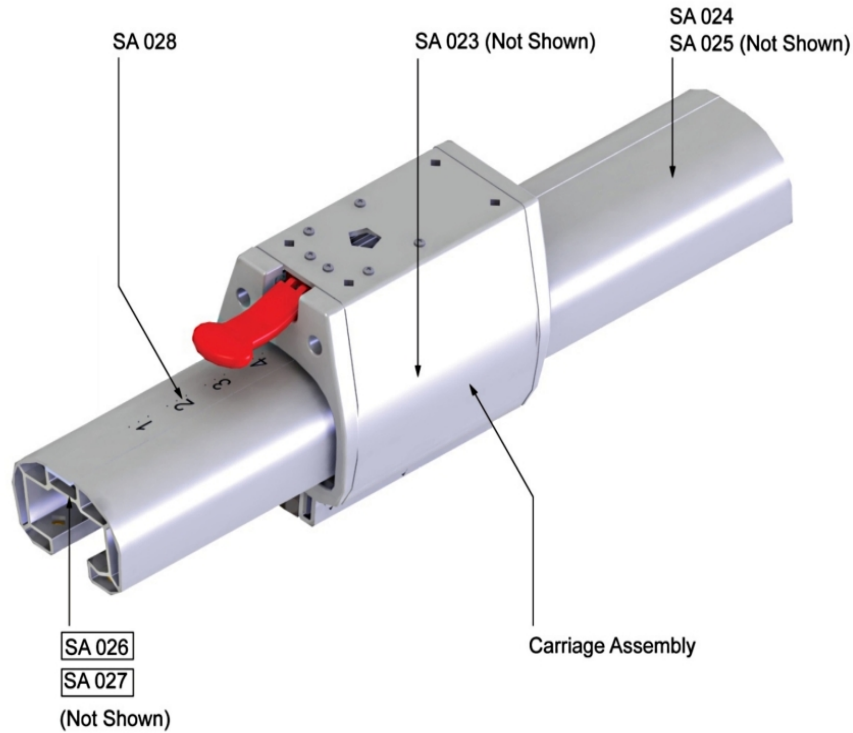

Ref #	Part Number	Qty	Description
SA-021,SA-023	0017-00101-1882	2	Hardware: Stabilizer Mounting Screw 30MM
SA-022,SA-025	0017-00104-0469	2	Hardware: Flat Washer 16MM OD
SA-024	AK66-00031-0000	1	Extrusion Assembly: Recumbent
SA-026	0K66-01023-0000	1	Accessory: Rack
SA-027	0017-00101-1891	1	Hardware: Mounting Screw 16MM
SA-028	0K66-01061-0000	1	Decal

## Seat Assembly - Optional Recumbent Arm Rests

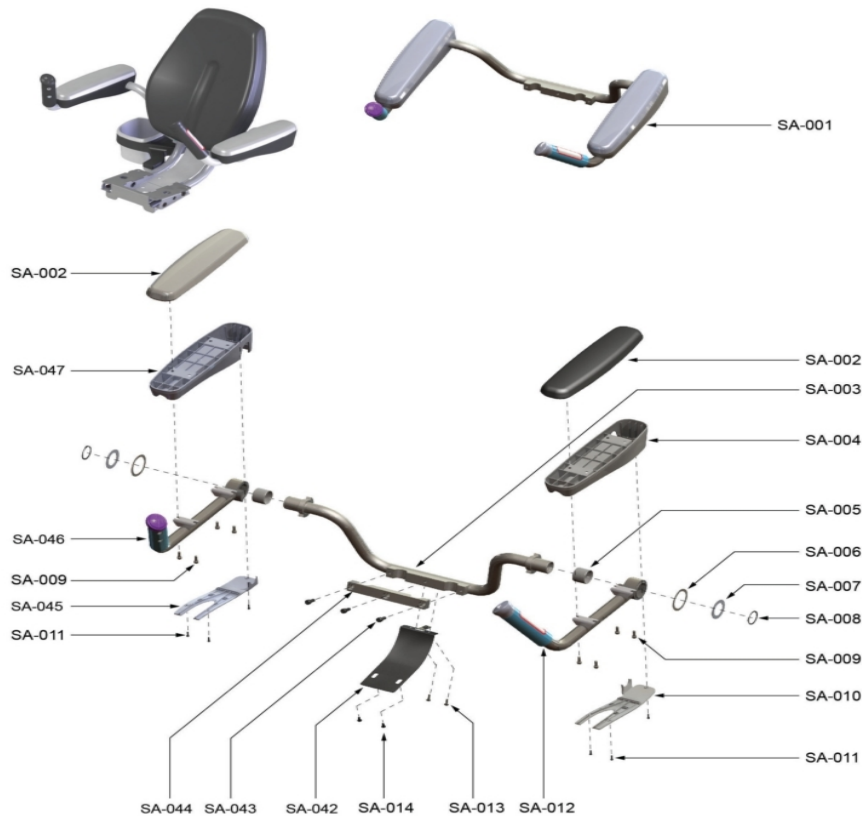

Ref #	Part Number	Qty	Description
SA-001	AK66-00088-0000	1	Arm Rest Frame Assembly
SA-002	AK66-00084-0000	2	Arm Rest Pad
SA-003	AK66-00133-0000	1	Arm Rest Support Weldment
SA-004	0K66-01156-0000	1	Left Arm Rest Shroud
SA-005	0017-00006-0298	2	Sleeve Bearing
SA-006	0K66-01228-0000	2	Wave Washer Steel 1.872 ID
SA-007	0K66-01159-0000	2	Hardware: Washer
SA-008	0017-00100-0256	2	Retaining Ring
SA-009	0017-00101-1891	8	Hardware: Mounting Screw 16MM
SA-010	0K66-01161-0000	1	Left Bottom Shroud
SA-011	0017-00101-2012	6	Hardware: Shroud Mounting Screw (3 per Shroud) 12MM
SA-012	AK66-00089-0001	1	Armrest with Grip Assembly: Left
SA-013	0017-00101-1972	2	Hardware: Screw 14MM
SA-014	0017-00101-2011	2	Hardware: Screw 10MM
SA-041	AK66-00137-0000	1	Bracket And Cable Assembly
SA-042	0017-00101-1881	3	Hardware: Screw 20 MM
SA-043	0K66-01218-0000	1	Arm Rest Support Clamp
SA-044	0K66-01162-0000	1	Right Bottom Shroud
SA-045	AK66-00089-0000	1	Armrest with Grip Assembly: Right
SA-046	0K66-01165-0000	1	Right Arm Rest Shroud

## Seat Assembly - Seat Pad and Back Pad



Ref #	Part Number	Qty	Description
SA-015	AK66-00052-0000	1	Recumbent Seat
SA-016	0017-00101-1881	1	Hardware: Screw 20 MM
SA-017	AK66-00072-0000	1	Seat Back
SA-018	0017-00101-2018	1	Hardware: Mounting Screw 60MM
SA-019	AK62-00124-0000	2	Leg Leveler
SA-020	0K66-01131-0000	1	Rear Stabilizer

## Upper Frame - Monocolumn Assembly

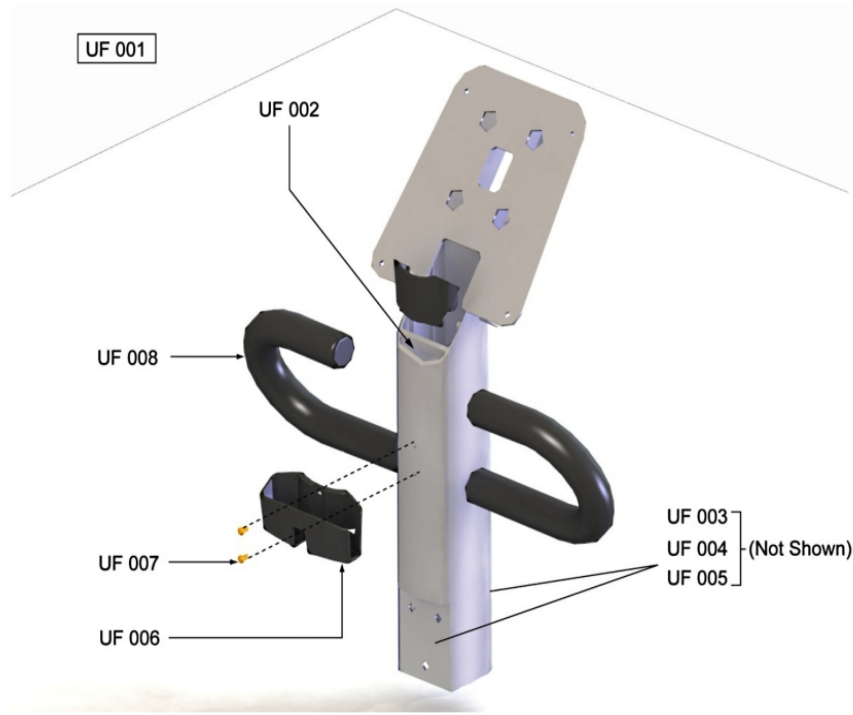

Ref #	Part Number	Qty	Description
UF-001	AK66-00038-0000	1	Monocolumn Assembly - Recumbent
UF-002	0K66-01099-0000	1	Mocolumn Cover
UF-003	0K67-01117-0000	1	Rear Mount Plate
UF-004	0K67-01118-0000	1	Bracket Plate
UF-005	0017-00101-2035	1	Hardware: Mounting Screw
UF-006	0K66-01112-0000	1	I-pod Bracket
UF-007	0017-00101-1732	2	Hardware: I-pod Bracket Mounting Screw 0.375"
UF-008	0K66-01072-0000	2	Grip

## Upper Frame - Shrouds



Ref #	Part Number	Qty	Description
UF-009,UF-016,UF-019,UF-021,UF-024	0017-00101-1796	20	Hardware: Mounting Screw 19 MM
UF-010	0K66-01100-0000	1	Console Back Cover
UF-011	0K67-01061-0000	1	Console Rear Middle Shroud
UF-012	AK66-00055-0000	1	Accessory: Cupholder
UF-013	0017-00101-2030	1	Hardware: Mounting Screw 16MM
UF-014	0K67-01055-0000	1	Accessory: Cupholder
UF-015	0K66-01055-0000	1	Rear End Cap Mounting Screw
UF-017	AK66-00044-0004	1	SHROUD/DECAL:REAR; MFG; LIFECYCLE RT NP
UF-018	AK66-00045-0004	1	SHROUD/DECAL:REAR; MFG; LIFECYCLE LT NP
UF-020	0K66-01059-0000	1	Middle Shroud
UF-022	AK66-00042-0003	1	Front Right Shroud LF Decal Shadow Gray with Vents - 95R
UF-023	AK66-00043-0003	1	Front Left Shroud LF Decal Shadow Gray with Vents - 95R
UF-025	0K65-01264-0000	1	LF Bug Decal
UF-026	0K66-01057-0000	1	Accessory: Media Holder

