

# LC-8500 Recumbent Exercise Bike

LC85R-0103-27

## Parts Manual

1/5/2019 14:45:35 PM

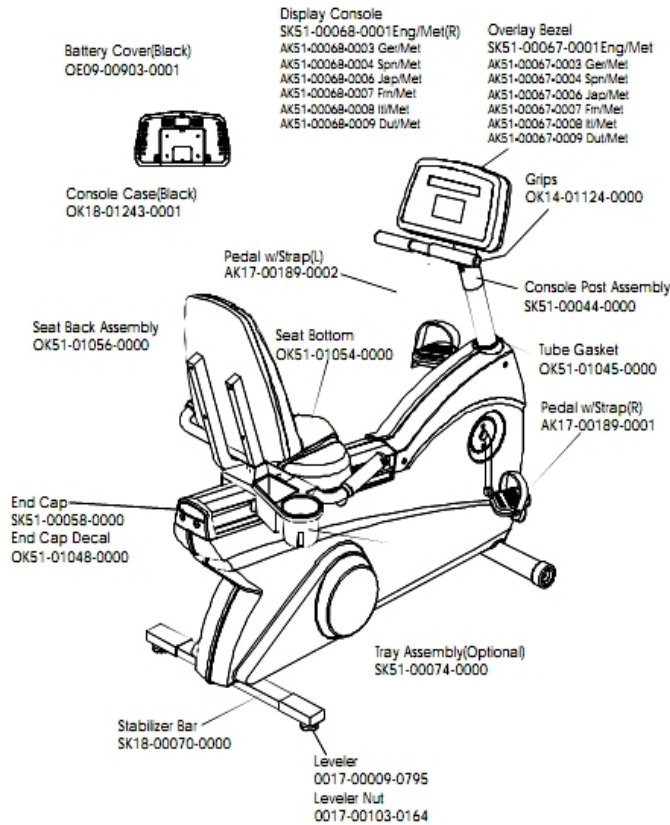

**Table of Contents**

---

<a href="#">Component Assembly 1</a> .....	3
<a href="#">Component Assembly 2</a> .....	4
<a href="#">Component Assembly 3</a> .....	5

# Component Assembly 1



Ref #	Part Number	Qty	Description
-	OK51-01054-0000	1	Seat Bottom
-	OK51-01048-0002	1	End Cap Decal
-	SK51-00068-0001	1	Display Console English/Metric
-	SK51-00067-0001	1	Overlay Bezel English/Metric
-	AK17-00189-0001	1	Pedal with Strap - Right
-	SK18-00021-0000	2	Leveler
-	SK18-00070-0000	1	Stabilizer Bar
-	AK17-00189-0002	1	Pedal with Strap - Left
-	OK14-01926-0000	1	Foam Grip
-	OK51-01056-0000	1	Seat Back
-	OK51-01045-0000	1	Tube Gasket
-	OE09-00903-0001	1	Battery Door
-	0017-00103-0164	2	Hardware: Leveler Nut
-	SK51-00058-0000	1	End Cap
-	SK51-00044-0000	1	Console Post Assembly
-	OK18-01243-0001	1	Console Case
-	SK51-00074-0000	1	Tray Assembly

## Component Assembly 2

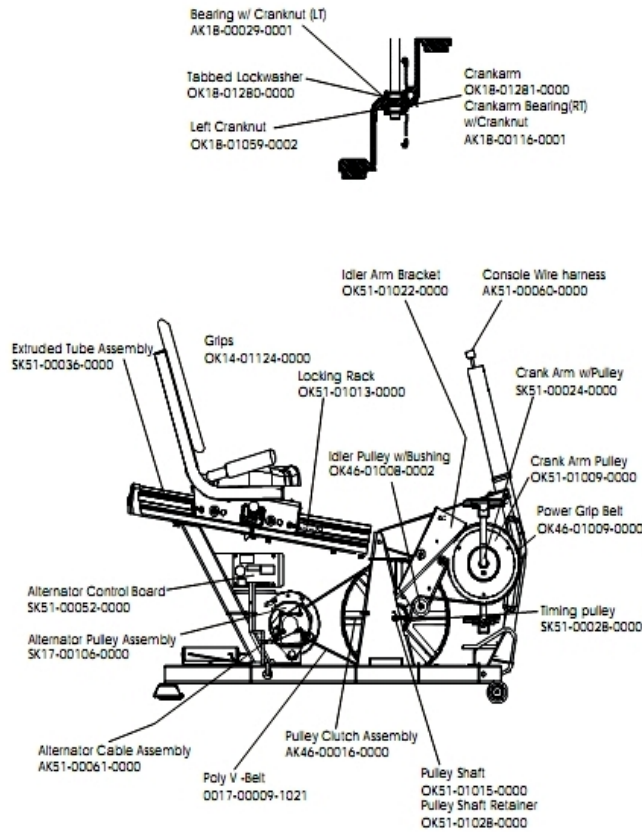

Ref #	Part Number	Qty	Description
-	OK46-01008-0004	1	Idler Pulley with Bushing
-	OK51-01009-0000	1	Crank Arm Pulley
-	AK51-00061-0000	1	Alternator Cable Assembly
-	AK18-00116-0001	1	Hardware: Bearing Nut - Right
-	OK18-01281-0000	1	Crankarm
-	OK14-01926-0000	1	Foam Grip
-	0017-00009-1021	1	Poly V -Belt
-	SK51-00036-0000	1	Extruded Tube Assembly
-	SK17-00106-0000	1	Alternator Pulley Assembly
-	AK51-00060-0000	1	Console Wire Harness
-	AK18-00029-0001	1	Hardware: Bearing Nut - Left
-	OK51-01028-0000	1	Pulley Shaft Retainer
-	OK18-01280-0000	1	Hardware: Tabbed Lock Washer
-	OK51-01013-0000	1	Locking Rack
-	SK51-00052-0000	1	Alternator Control Board
-	OK18-01059-0002	1	Hardware: Locknut
-	SK51-00024-0000	1	Crank Arm with Pulley
-	OK51-01015-0000	1	Pulley Shaft
-	AK51-00089-0001	1	Idler Arm Bracket
-	AK46-00052-0000	1	Cog Pulley
-	AK46-00016-0000	1	Freewheel Pulley Assembly
-	OK46-01009-0000	1	Power Grip Belt

## Component Assembly 3

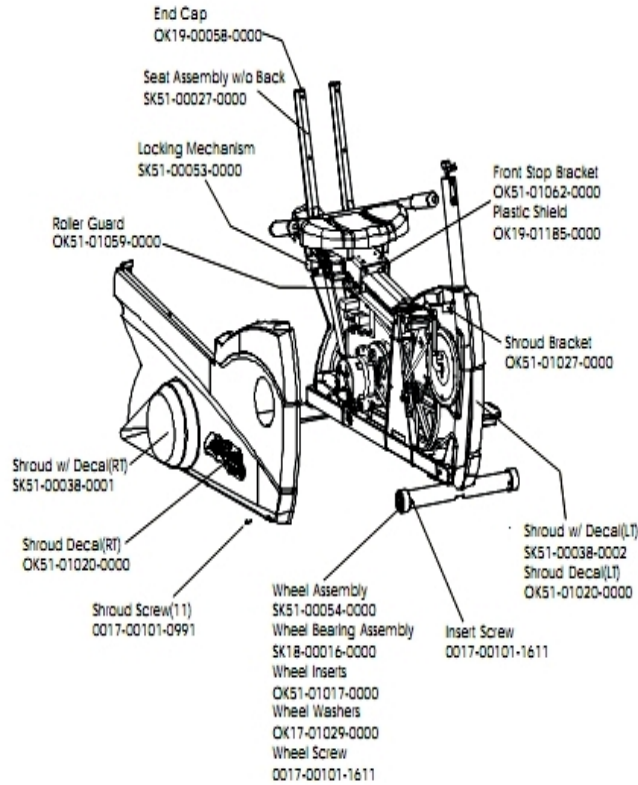

Ref #	Part Number	Qty	Description
-	OK51-01059-0000	1	Roller Guard
-	0017-00101-0991	11	Hardware: Phillips Pan Screw 0.75"
-	SK18-00016-0000	2	Wheel Bearing Assembly
-	OK51-01062-0000	1	Front Stop Bracket
-	0017-00101-1611	3	Hardware: Insert Screw
-	SK51-00054-0000	2	Wheel Assembly
-	SK51-00053-0000	1	Lock Assembly
-	GK63-00002-0022	2	NLA: KIT: SERV; SHROUD-SET; LC85 BM
-	OK51-01020-0000	2	Shroud Decal(LT)
-	OK17-01029-0000	2	Hardware: Washer
-	OK19-01185-0000	1	Plastic Shield
-	OK51-01027-0000	1	Shroud Bracket
-	OK51-01017-0000	2	Wheel Insert
-	SK51-00027-0000	1	Seat Assembly

