

Engage 15-inch LCD Console

PM CN 15DN-xxxxx-xx 15DT-xxxxx-xx English

Parts Manual

20.11.12

Table of Contents

Serial Number Table	2
Parts Locator	3
PCBs	5
Cables	7
Miscellaneous Components	8
Bezels	9
Display Components	10

Serial Number Table

Analog Consoles

Item No.	Alpha Code (Prefix)	Description	Starting Serial #	Ending Serial #
15DT-DOMXN-01	DTN	15 inch Engage Treadmill Console, Domestic, NTSC	100000	
15DT-INTXN-01	ITN	15 inch Engage Treadmill Console, International, NTSC	100000	
15DT-INTXP-01	ITP	15 inch Engage Treadmill Console, International, PAL	100000	
15DN-ALLXN-01	ANN	15 inch Engage BIKE/CT Console, Domestic, NTSC	100000	
15DN-ALLXN-02	ANN	15 inch Engage BIKE/CT Console, Domestic, NTSC, Hybrid	100000	
15DN-ALLXP-01	ANP	15 inch Engage BIKE/CT Console, International, PAL	100000	

Digital Consoles

Item No.	Alpha Code (Prefix)	Description	Starting Serial #	Ending Serial #
15DT-DOMXA-01	DLT	15 inch Engage DTV Treadmill Console, Domestic, ATSC	100000	
15DT-DOMXA-02	DAS	15 inch Engage DTV Treadmill Hybrid Console, Domestic, ATSC	100000	
15DN-ALLXA-01	DLB	15 inch Engage DTV BIKE/CT Console, Domestic, ATSC	100000	
15DN-ALLXA-02	DSC	15 inch Engage DTV BIKE/CT Hybrid Console, Domestic, ATSC	100000	
15DT-INTDV-01	DTV	15 inch Engage Treadmill Console, International, DVB-T	100000	
15DN-INTDV-01	DTC	15 inch Engage BIKE/CT Console, International, DVB-T	100000	
15DT-ALLIS-01	DJT	15 inch Engage Treadmill Console, Japan, ISDB-T	100000	
15DN-ALLIS-01	DJN	15 inch Engage BIKE/CT, Console, Japan, ISDB-T	100000	

Parts Locator

Use this section to locate a part (PCBs, Cables, Miscellaneous Components), then find the part number in the sections that follow. Illustrations are for reference only and actual parts may look different than shown.

Treadmill Consoles - Analog

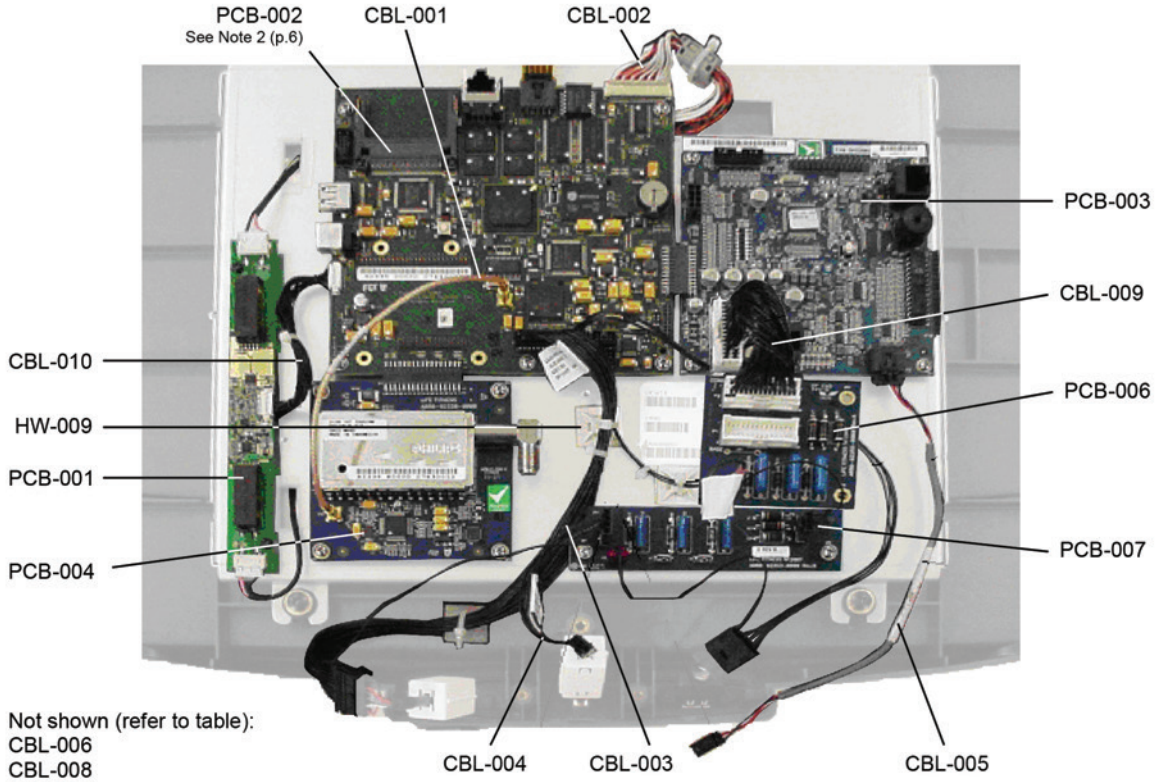

Non-Treadmill Consoles - Analog

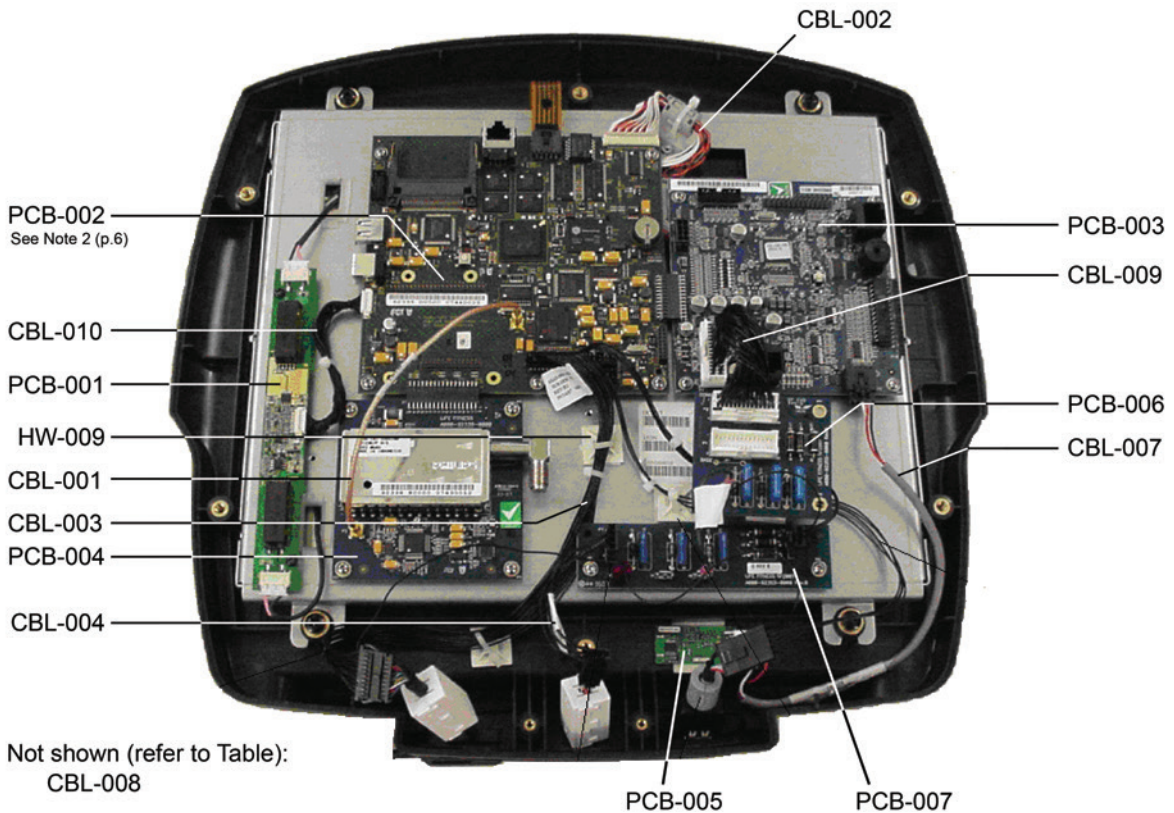

Treadmill Consoles - Digital

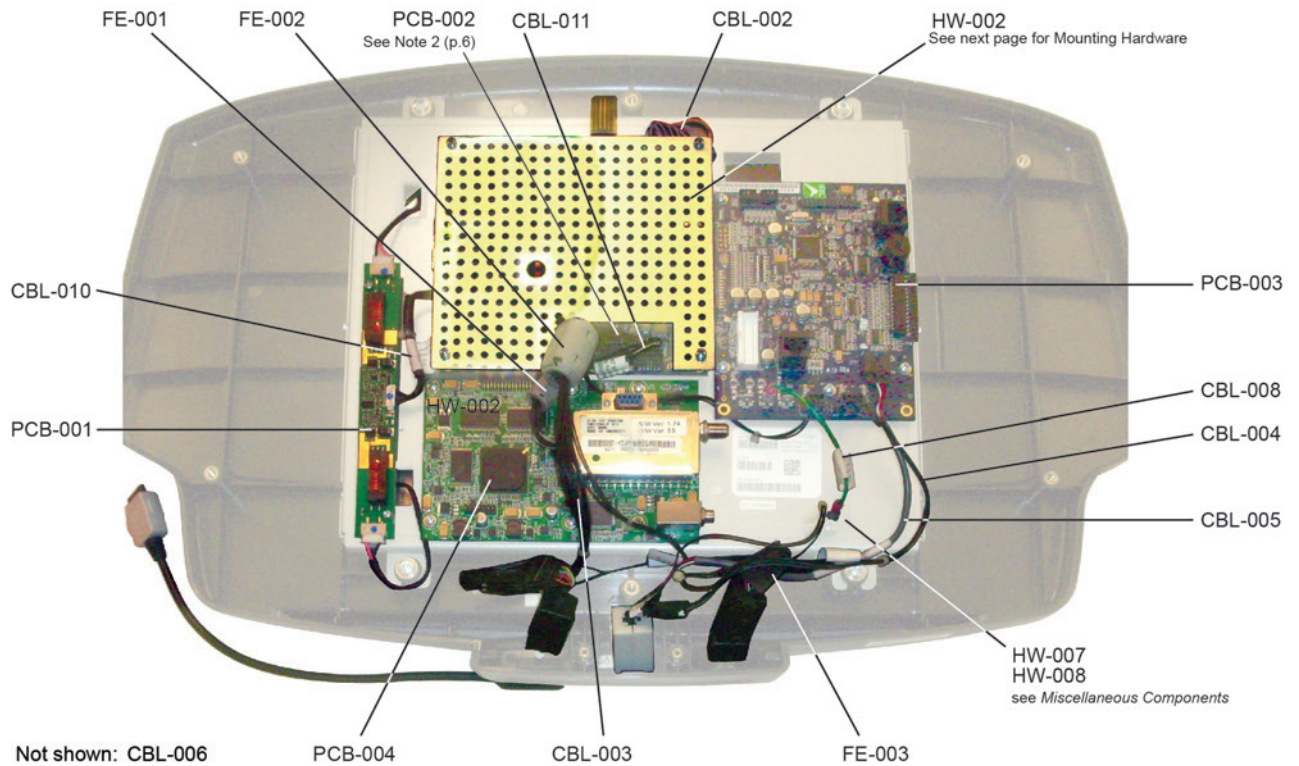

Non-Treadmill Consoles - Digital

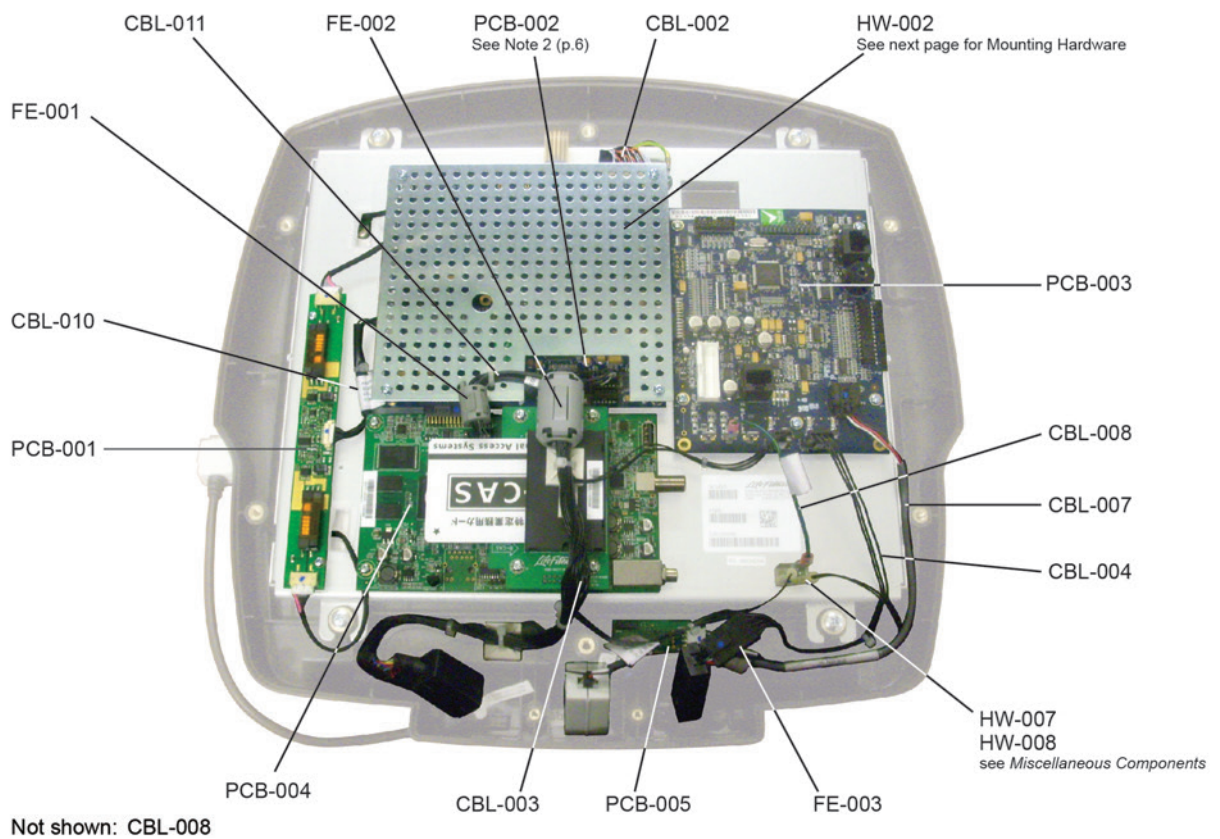

PCBs

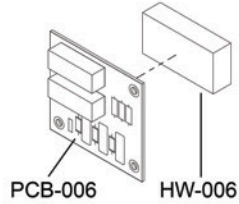
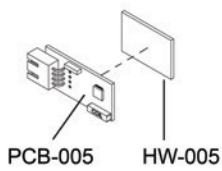
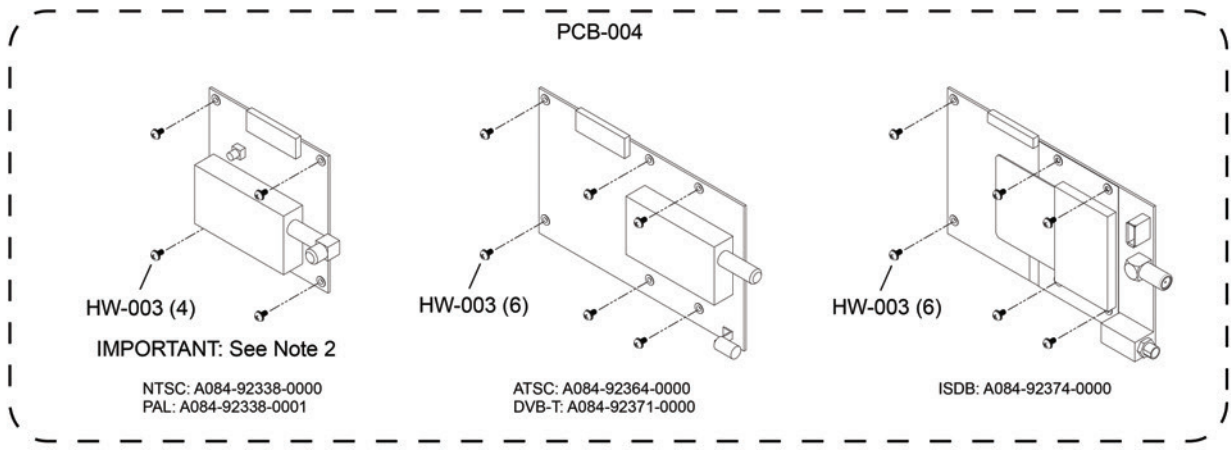
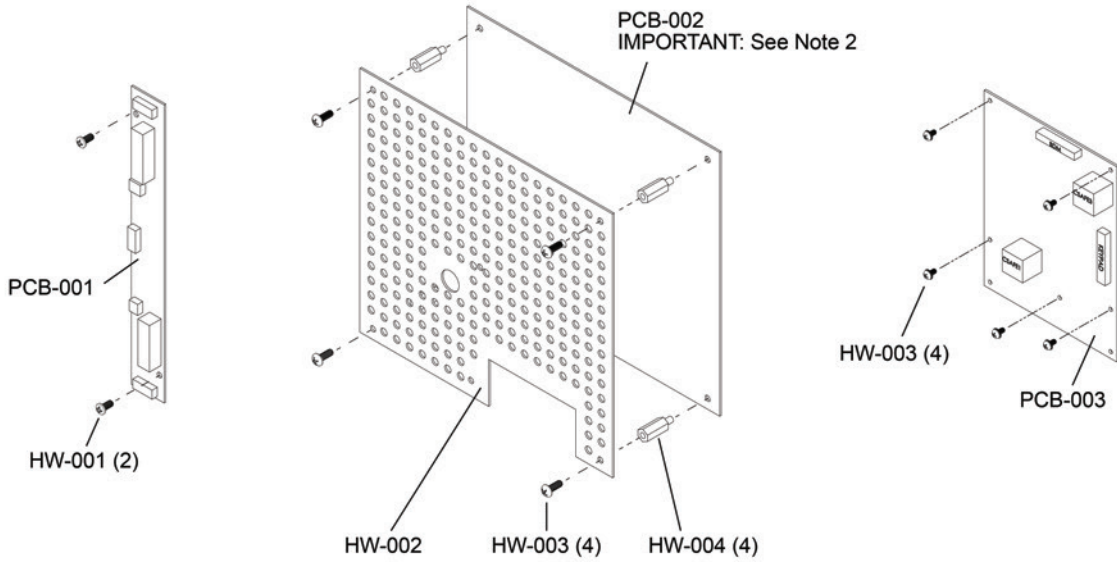

PCB-007

PCB Parts List (PCB)

Item	Alpha Code	Part Number	Description
PCB-001	ANN, ANP, DTN, ITN, ITP	135E-00002-0006 (see Note 1)	PCB: Inverte; 12V, 6W, -20-+70C
"	ANN, ANP, DTN, ITN, ITP,	135E-00002-0007 (see Note 1)	Inverter for CCFL
"	DLT, DLB, DTV, DTC, DJT, DJN, DAS	135E-00002-0007	Inverter for CCFL
PCB-002	ANN, ANP, DTN, ITN, ITP, DLT, DLB, DTV, DTC, DJT, DJN, DAS, DSC	A084-92335-0001 (see Note 2)	Programmed SBC PCB
PCB-003	ANN, ANP	A084-92334-0000	Programmed MIB PCB Assy, APOLLO MIB
"	DTN, ITN, ITP	A084-92334-0000 (see Note 3)	Programmed MIB PCB Assy, APOLLO MIB. Change PCB-006 also.
"	DLT, DLB, DTV, DTC, DJT, DJN, DAS, DSC	A084-92334-0003	Programmed MIB PCB
PCB-004	ANN, DTN, ITN	B084-92338-0000 (see Note 2)	PCB Assembly, Analog Tuner; NTSC BM only
"	ANP, ITP	B084-92338-0001 (see Note 2)	PCB Assembly, Analog Tuner; PAL; BM only
"	DLT, DLB, DAS, DSC	A084-92364-0000	Programmed Digital ATSC Tuner Module
"	DTV, DTC	A084-92371-0000	Programmed Digital DVB Tuner Module (EMEA)
"	DJT, DJN	A084-92374-0000	Programmed PCB: Digital ISDB Tuner (JAPAN)
PCB-005	ANN, ANP, DLB, DTC, DJN, DSC	118E-00001-0244 (see Note 4)	Heart Rate Receiver, Coded, RE07L
PCB-006	ANN, ANP, DTN, ITN, ITP	B084-92355-0000 (see Note 5)	Lifepulse ESD Board
PCB-007	ANN, ANP, DTN, ITN, ITP	B084-92353-0000	PCB Assembly, ESD PCB

Note 1: IMPORTANT - See *LCD Panel Component Compatibility Chart* (page 8) for compatibility requirements.

Note 2: IMPORTANT - Programmed SBC PCB Assy (Item PCB-002) p/n A084-92335-0001 replaces p/n A084-92335-0000. If replacing PCB-002 p/n A084-92335-0000 with p/n A084-92335-0001 and PCB-004 is an NTSC or PAL Analog Tuner, cut PCB-004 pins 2 and 4 on Connector P1.

Note 3: Must order and replace Item PCB-006 (see Note 5) at the same time.

Note 4: Must be ordered with Tape, P/N 0K39-01044-0000 (see table below - Item HW-005)

Note 5: Must be ordered with 0K70-01069-0000 (see table below - Item HW-006). If Treadmill Analog Console does not have PCB-006 already installed, then order CBL-008 and CBL-009 to install as shown on page 3.

Associated Hardware Parts List (HW)

Item	Alpha Code	Part Number	Description
HW-001	ANN, ANP, DTN, ITN, ITP, DLT, DLB, DTV, DTC, DJT, DJN, DAS, DSC	0017-00101-1935	M3.0X.5-6G6G X 6.0 DIN PHS PAN MS ST ZN
HW-002	DLT, DLB, DTV, DTC, DJT, DJN, DAS, DSC	0K88-01004-0000	Metal Shield: Metal Ccover SBC
HW-003	ANN, ANP, DTN, ITN, ITP, DLT, DLB, DTV, DTC, DJT, DJN, DAS, DSC	0017-00101-1971	M3 X .5 - 6g6g X 6 DIN PHL PAN MS ST ZN
HW-004	DLT, DLB, DTV, DTC, DJT, DJN, DAS, DSC	0017-00009-1294	Standoff: Male-Female Threaded Hex : M3 X .5 X 13 (4)
HW-005	ANN, ANP, DLB, DTC, DJN, DSC	0K39-01044-0000	Tape: Adhesive B (used to to secure PCB-007)
HW-006	ANN, ANP	0K70-01069-0000	Tape, Foam, Double-sided (used to secure PCB-006)

Cables

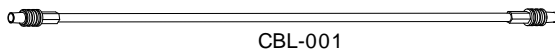

CBL-001

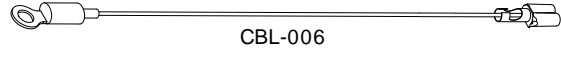

CBL-006

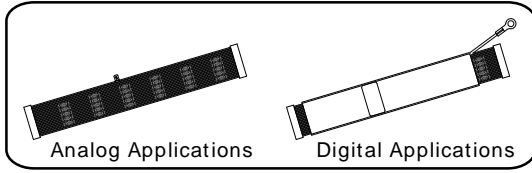
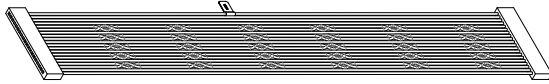

CBL-002

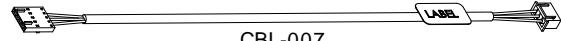

CBL-007

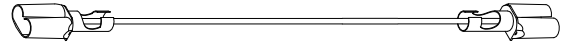

CBL-008

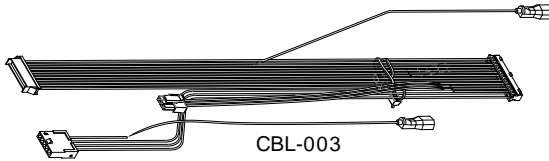

CBL-003



CBL-009



CBL-004



CBL-010

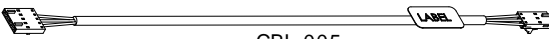

CBL-005

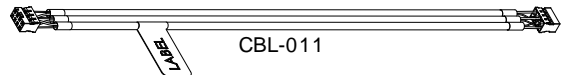

CBL-011

Item	Alpha Code	Part Number	Description
CBL-001	ANN, ANP, DTN, ITN, ITP	AK65-00056-0000	CABLE ASSY: COAX ; SHORT
CBL-002	ANN, ANP, DTN, ITN, ITP	AK65-00061-0000	CABLE ASSY: SBCE 15" LCD
"	DLT, DLB, DTV, DTC, DJT, DJN, DAS, DSC	AK65-00061-0001	CABLE ASSY: SBCE TO 15" LCD - SHIELDED
CBL-003	ANN, ANP, DTN, ITN, ITP	AK65-00041-0000	CABLE ASSY: SBC - User Option Panel
"	DLT, DLB, DTV, DTC, DJT, DJN, DAS, DSC	AK65-00041-0001	CABLE ASSY: Options Panel
CBL-004	ANN, ANP, DTN, ITN, ITP, DLT, DLB, DTV, DTC, DJT, DJN, DAS, DSC	AK65-00102-0001	CABLE ASSY: Headphone Extension
CBL-005	DTN, ITN, ITP, DLT, DTV, DJT, DAS	AK70-00037-0000	CABLE ASSY: Polar, U/W PCB Rcvr
CBL-006	DTN, ITN, ITP, DLT, DTV, DJT, DAS	AK65-00103-0000	CABLE ASSY: Ground ESD
CBL-007	ANN, ANP, DLB, DTC, DJN, DSC	AK69-00119-0000	CABLE ASSY: Coded Polar PCB To MIB
CBL-008	ANN, ANP, DTN, ITN, ITP, DLB, DTC, DJN, DSC, DLT, DTV, DJT, DAS	AK69-00142-0000	CABLE ASSY: Ground LP ESD
CBL-009	ANN, ANP, DTN, ITN, ITP	AK70-00063-0000	CABLE ASSY: Console, ESD
CBL-010	ANN, ANP, DTN, ITN, ITP	AK65-00057-0000 (see Note 6)	CABLE ASSY: SBC to Inverter, 8.5"
"	ANN, ANP, DTN, ITN, ITP	AK65-00057-0001 (see Note 6)	CABLE ASSY: SBC to Inverter, 3.5"
"	DLT, DLB, DTV, DTC, DJT, DJN, DAS, DSC	AK65-00057-0001	CABLE ASSY: SBC to Inverter, 3.5"
CBL-011	DLT, DLB, DTV, DTC, DJT, DJN, DAS, DSC	AK88-00001-0000	CBL ASSY: DTV VIDEO

Note 6: **IMPORTANT** - See LCD Panel Component Compatibility Chart (page 10) for compatibility requirements.

Miscellaneous Components

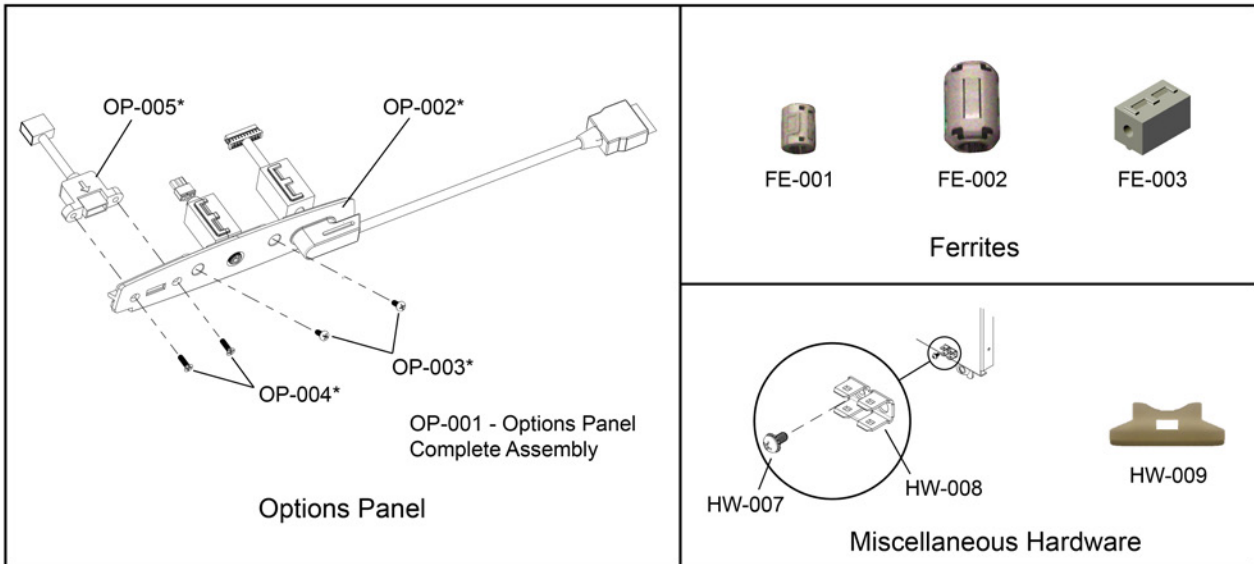

Parts List - Options Panel

Item	Alpha Code	Part Number	Description
OP-001	ANN, ANP, DTN, ITN, ITP, DLT, DLB, DTV, DTC, DJT, DJN, DAS, DSC	AK70-00101-0200	ASSY: OPTIONS PANEL; PURCH - includes Items in asterisk (*)
OP-002*	ANN, ANP, DTN, ITN, ITP, DLT, DLB, DTV, DTC, DJT, DJN, DAS, DSC	see Note 7	
OP-003*	ANN, ANP, DTN, ITN, ITP, DLT, DLB, DTV, DTC, DJT, DJN, DAS, DSC	0017-00101-1970	M3 x .5 x 8 PHL PAN MS ST BZ
OP-004*	ANN, ANP, DTN, ITN, ITP, DLT, DLB, DTV, DTC, DJT, DJN, DAS, DSC	0017-00101-2031	M3 X .5 - 6G6G X 10 DIN PHL FLT MS SS NO
OP-005*	ANN, ANP, DTN, ITN, ITP, DLT, DLB, DTV, DTC, DJT, DJN, DAS, DSC	0K39-01044-0000	CABLE ASSY: USB

Note 7: not available separately; order complete Assembly (Item OP-001)

Parts List - Ferrites

Item	Alpha Code	Part Number	Description
FE-001	DLT, DLB, DTV, DTC, DJT, DJN, DAS, DSC	121E-00001-0025	CLAMP FILTER: FERRITE CORE W/CASE; Z-CAT SERIES
FE-002	DLT, DLB, DTV, DTC, DJT, DJN, DAS, DSC	121E-00001-0016	FERRITE-BEAD: SNAP-ON;13MM N/D
FE-003	DLT, DLB, DTV, DTC, DJT, DJN, DAS, DSC	121E-00001-0011	FERRITE-BEAD: SUPPRESSION B

Parts List - Miscellaneous Hardware

Item	Alpha Code	Part Number	Description
HW-007	DLT, DLB, DTV, DTC, DJT, DJN, DAS, DSC	0017-00101-1971	M3 X .5 - 6g6g X 6 DIN PHL PAN MS ST ZN
HW-008	DLT, DLB, DTV, DTC, DJT, DJN, DAS, DSC	0017-00021-3141	QUICK DISCONNECT TERMINAL
HW-009	ANN, ANP, DTN, ITN, ITP, DLT, DLB, DTV, DTC, DJT, DJN, DAS, DSC	0017-00042-1207	HOLDER: FLAT TIE W/TAPE NATURAL; NYLON

Bezels



BZ-001



BZ-002



BZ-003



BZ-004



BZ-005

Parts List

Item	Alpha Code	Part Number	Description
BZ-001	ITN, ITP, DTV	AK70-00020-0000	ASSY: FRONT BEZEL "E" TREAD WORLD
BZ-002	DTN, DLT, DJT, DAS	AK70-00020-0001	ASSY: FRONT BEZEL "E" TREAD DOMESTIC
BZ-003	DTN, ITN, ITP, DTV, DJN, DLT	AK70-00014-0000	ASSY: CONSOLE BACK CASE/FASTENER; Ti/Te, PURCH
BZ-004	ANN, ANP, DLB, DTC, DJN, DSC	AK70-00022-0000	ASSY: FRONT BEZEL "E" NON-TREAD UNIVERSAL
BZ-005	ANN, ANP, DLB, DTC, DJN	AK70-00023-0000	ASM: BACK BEZEL;NON-TREAD UNIVERSAL PURCH

Display Components

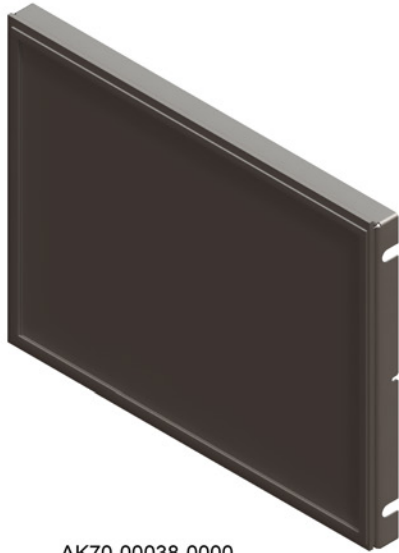

AK70-00038-0000
DC-001

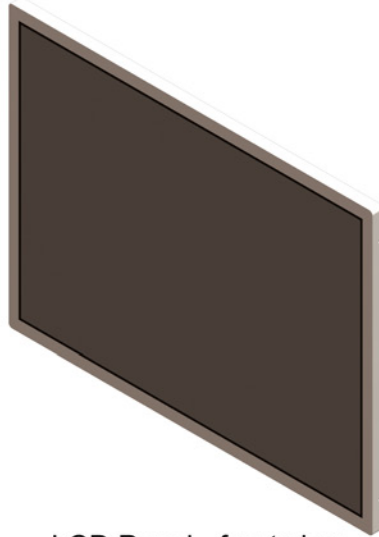

LCD Panel - front view
DC-002, DC-003

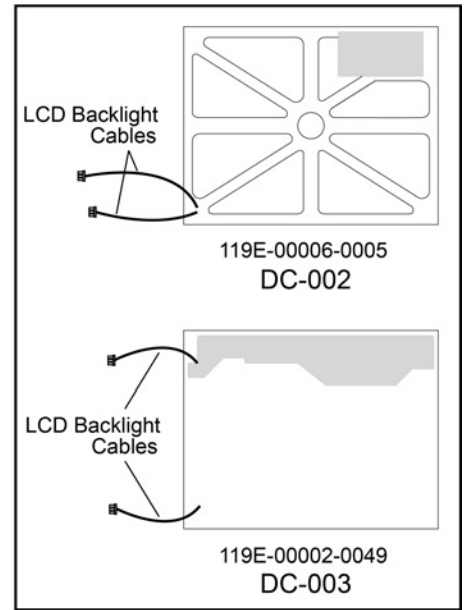

LCD Panel - rear view



DC-004 - see Note 10

Parts List

Item	Alpha Code	Part Number	Description
DC-001	ANN, ANP, DTN, ITN, ITP, DLT, DLB, DTV, DTC, DJT, DJN, DAS, DSC	AK70-00038-0000	ASSY: FLANGE TO TOUCHSCREEN
DC-002	ANN, ANP, DTN, ITN, ITP	119E-00006-0005 (see Notes 8 and 9)	LCD MODULE; TFT, 1024 X 768RES, LVDS, 3.3
DC-003	ANN, ANP, DTN, ITN, ITP, DLT, DLB, DTV, DTC, DJT, DJN, DAS, DSC	119E-00002-0049 (see Note 8)	15-INCH LCD, NON-PSWG
DC-004	ANN, ANP, DTN, ITN, ITP	see Note 10	Extension Cable

LCD Panel Component Compatibility Chart

Component	15-Inch LCD	
	DC-002	DC-003
Inverter (PCB-001)	135E-00002-0006	135E-00002-0007
SBC to Inverter Cable (CBL-010)	AK65-00057-0000	AK65-00057-0001 (see Note 11)

Note 8: 15-inch LCD panels DC-002 and DC-003 (see rear views for distinctions) require the replacement of respective components (*Inverter* and *SBC to Inverter Cable*) as listed in table above.

Note 9: If LCD Panel P/N **119E-00006-0005** (DC-002) is not available, it can be replaced with P/N **119E-00002-0049** (DC-003), which will also require *Inverter* and *SBC to Inverter Cable* to be replaced with respective part numbers listed in the table above.

Note 10: Required part if LCD Panel P/N **119E-00002-0049** (DC-003) is used and bracket has only one LCD backlight cable thru-hole (at bottom). Available from Quadrangle Cable (www.quadrangleproducts.com); P/N **QD3504-8**.

Note 11: Cable P/N **AK65-00057-0000** can also be used but will be longer.