

1.26" Front Light Panel

11655-xx | Product Data Sheet | 2018



For more information:

WEB flexlighting.com

CONTACT flexlighting.com/contact

PHONE 773-295-0305

Overview

The **FLEX Front Light Panel** optical film is designed to laminate to the front surface of **Sharp reflective display (LS013B7DH05)** to provide high quality on-demand display lighting. This thin plastic panel incorporates only a single LED which enables product designers to develop ultra-thin devices and minimize battery use.

- One **low-power** LED (included in Front Light)
- Over **80x less power** compared to traditional backlighting
- 0.05 mm thick FLEX film is over **5x thinner** than alternative lightguides

SHARP

Approved

Value-Added Partner

Mechanical

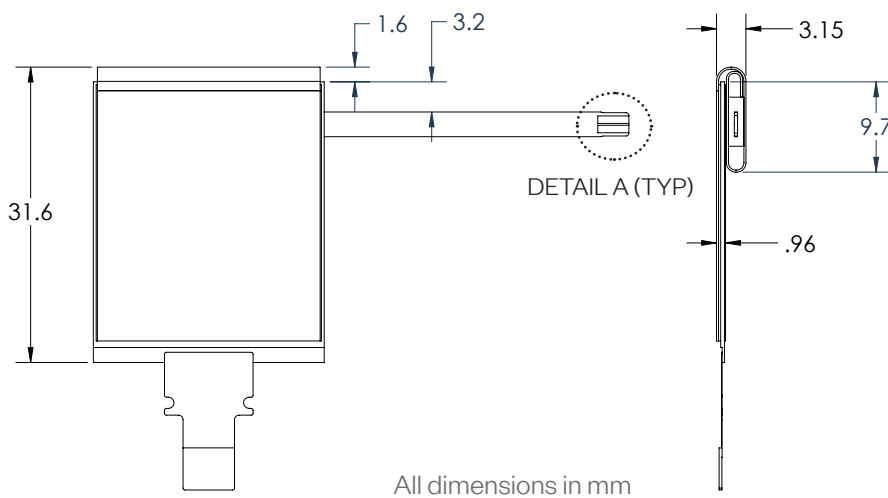

Flexible film allows for different placement options for the light source (examples below)

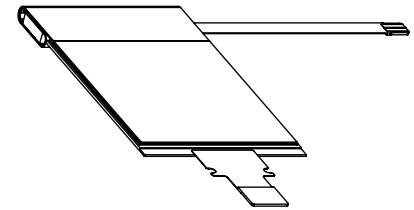

11655-01

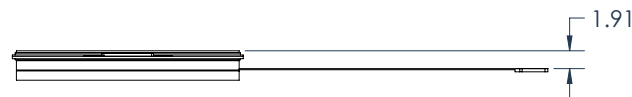

11655-03
UNDER DISPLAY

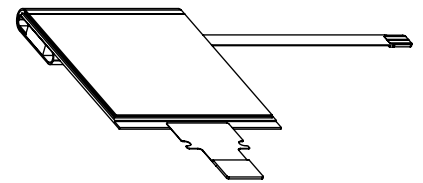

11655-03

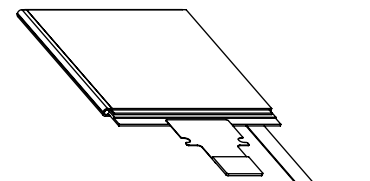
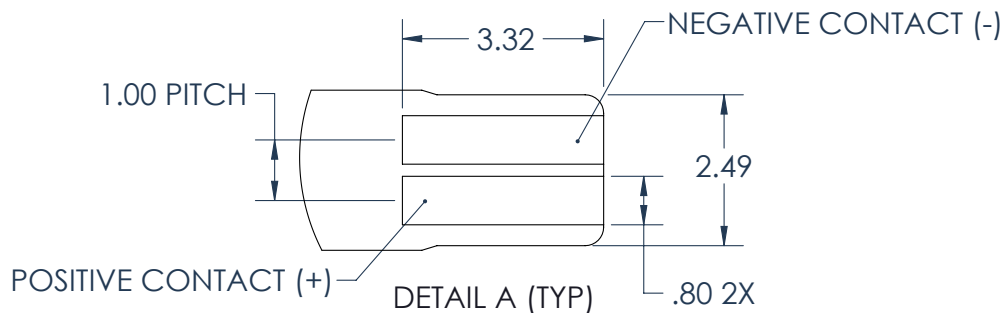

11655-06
PRELIMINARY

1.26" Front Light Panel

11655-xx | Product Data Sheet | 2018



For more information:

WEB flexlighting.com

CONTACT flexlighting.com/contact

PHONE 773-295-0305

Electrical

Item	Symbol	Typical	Absolute Max	Unit
Forward Current	I_F	5	25	mA
Pulse Forward Current	I_{FP}	--	80	mA
Reverse Voltage	V_R	--	5	V

Example ZIF Connectors:

- Molex 503480-0400
- Molex 52745-0497
- Molex 54550-0471
- Molex 54548-0471 (bottom)
- Molex 505110-0492

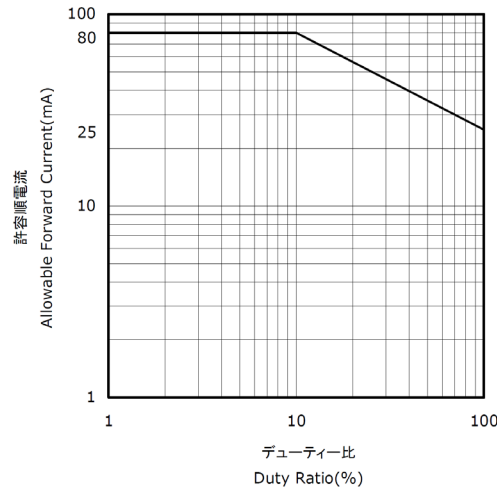
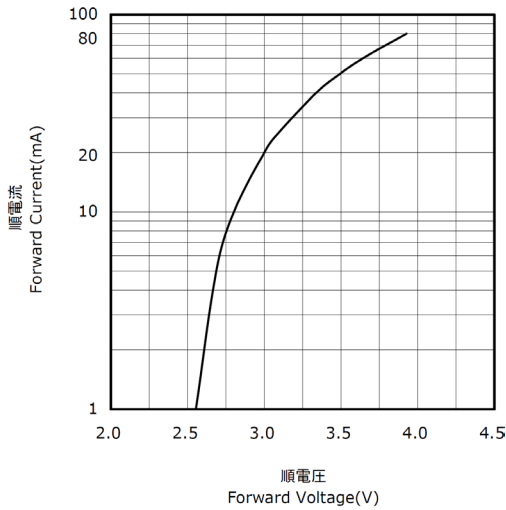

Optical

1.26" Sharp + Front Light (11655-03)					
Item	Symbol	TYP.	Unit	Remark	
Viewing Angle CR > 2	V	$\Theta 11$ $\Theta 12$	60 30	° (Degree)	[Remark 1]
	H	$\Theta 21$ $\Theta 22$	65 65	° (Degree)	
Contrast Ratio	Front light ON	CR	14	--	[Remark 2]

Brightness vs. Power

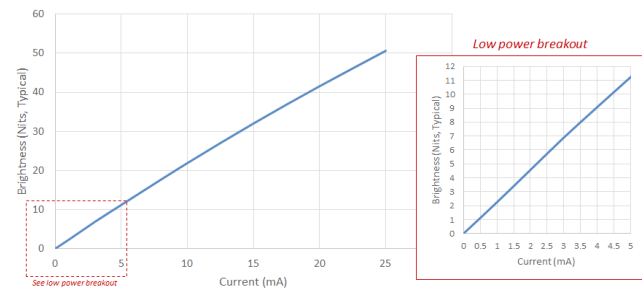

Remark 1: Viewing Angle

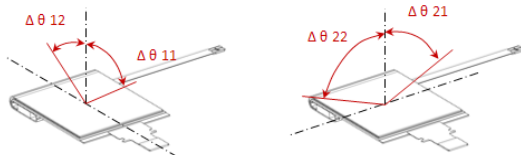

Remark 2: Definition of Contrast Ratio

$$\text{Contrast Ratio (CR)} = \frac{\text{Reflection intensity in white display}}{\text{Reflection intensity in black display}}$$

Measurements taken with a Minolta Chroma Meter CS-100 at a 17" view distance