

Model GC-TBZ48 Battery Powered Z-Wave Thermostat Installation & Operation Guide

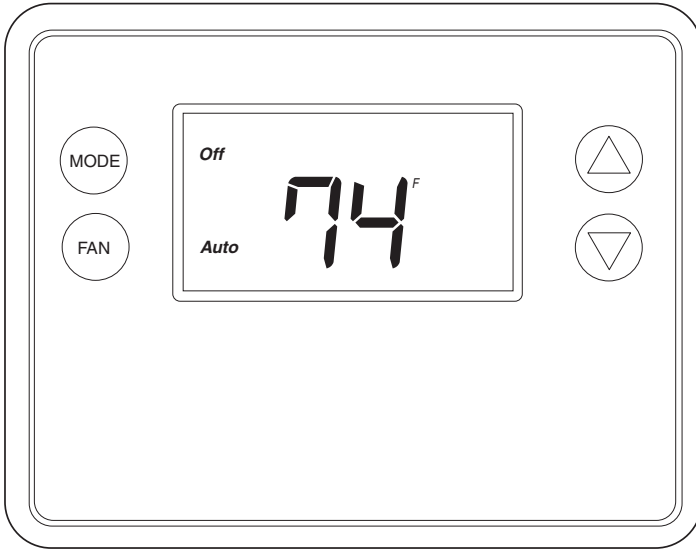

Table of Contents

Typical Wiring for Standard Gas/Electric HVAC System	2
Typical Wiring for Heat Pump HVAC System	3
Thermostat Power	4
The C Wire	4
24VAC Power	4
Battery Power	4
Z-Wave Operation when Battery Powered	4
Remove Existing Thermostat	5
Wiring Colors	5
Install the Back Panel	6
Standard HVAC System Connections	7
Single and Dual Transformer Systems (Split Systems)	7
Single Transformer System	7
Dual Transformer Systems	8
Heat Pump HVAC System Connections	9
Mount the Thermostat	10
Battery Installation	10
Thermostat Setup Menus	11
Preset HVAC System settings	11
Wait Mode	11
Minimum Run Time (MRT)	11
Entering Menu Mode	12
Menu Mode Navigation	12
System Menu	13
System Type	13
Fan Type (For Standard HVAC systems only)	13
Changeover Type (For Heat Pump HVAC Systems Only)	13
Z-Wave Installation	14
Inclusion and Exclusion	14
Clock Menu	15
Setting the Clock	15
INFO Menu	15
Advanced System Settings Menu	16
Thermostat Operation	18
Main Thermostat Screen	18
Backlight and Button Operation	18
Display	18
Staging Indicators	18
Setting the System Mode	19
System Modes	19
Special Heat Pump Mode: Emergency Heat	19
Setting the Heating or Cooling Temperature Setpoint	20
Automatic Setpoint Push	20
Setting the Fan Mode	21
Fan Modes	21
User Customization	22
User preference settings	22
Clock Menu	23
Setting the Clock	23
INFO Menu	23
Specifications	24
Regulatory Information	25
Industry Canada Notices	25
Limited Warranty	25

GC-TBZ48

BATTERY POWERED Z-WAVE THERMOSTAT

INSTALLATION INSTRUCTIONS

The Z-Wave Thermostat (GC-TBZ48) is a programmable, Z-Wave communicating thermostat. It can be powered using 24VAC (if both "R" & "C" wires are available at the thermostat), or using four (4) AA batteries. Using Z-Wave technology, end users have the ability to use the 2GIG Go!Control panel to control the thermostat, configure programming settings, as well as to display current conditions in the home or office.

Figure 1. Z-Wave Thermostat Front View

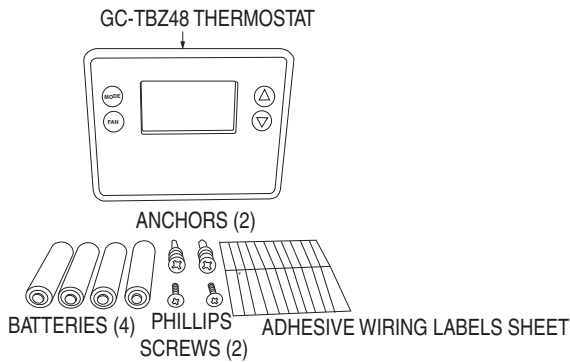

Features Include:

- A fixed format display with white backlight
- Heating and cooling setup display options
- System mode (OFF, Heat, Cool, Auto, E-Heat)
- Fan mode control and display (Auto, ON)
- Changeover type for Heat Pump (HP) systems
- On-screen setup of HVAC type, Fan type
- F/C mode, and sensor calibration

Box Contents

- 1–Z-Wave Thermostat
- 1–Sheet Adhesive Wiring Labels
- 2–Plastic Wall Anchors
- 4–AA Batteries

Compatible with 24 VAC gas, oil, or electric heating and air conditioning systems; or gas millivolt heating systems

DO NOT USE ON 120VAC SYSTEMS!

Standard Systems

- 1 Stage Heating and Cooling
- 2 Stage Heating and Cooling

Heat Pump Systems

- 1 Stage Heating and Cooling
- 2 Stage Heating and Cooling
- 2nd or 3rd Stage Aux Heating (Electric Heat Strips)

Installation Outline

- Step 1 Remove Existing Thermostat
- Step 2 Install GC-TBZ48 Thermostat
- Step 3 Setup Thermostat to match System Type
- Step 4 Install into Z-Wave Network

Typical Wiring for Standard Gas/Electric HVAC System

TYPICAL THERMOSTAT WIRING COLORS.
CAUTION: VERIFY THAT ORIGINAL WIRING
MATCHES. COLORS MAY BE DIFFERENT

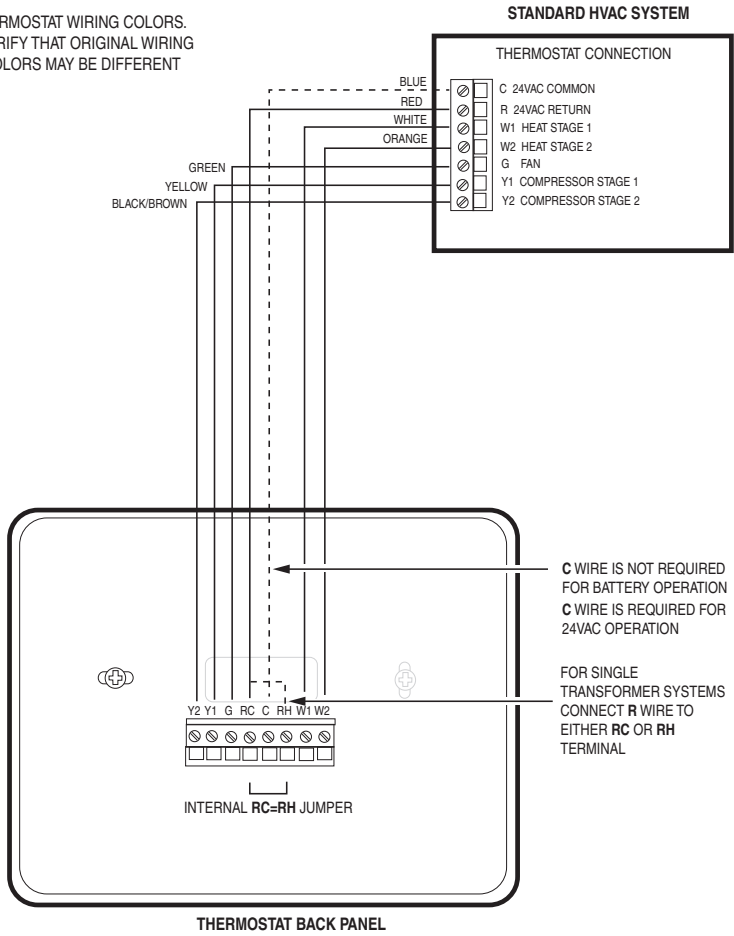

DEFAULT THERMOSTAT SETUP:
TYPE: STANDARD HVAC
FAN: GAS HEAT
1 STAGE HEATING
1 STAGE COOLING
NO SETUP CHANGE REQUIRED FOR THIS CONFIGURATION

FOR SYSTEMS WITH SEPARATE HEATING AND COOLING TRANSFORMERS, CONNECT HEATING R TO RH AND COOLING R TO RC. NOTE! THE RC-RH JUMPER MUST BE CUT ON THE THERMOSTAT BOARD.

Typical Wiring for Heat Pump HVAC System

TYPICAL THERMOSTAT WIRING COLORS.
CAUTION: VERIFY THAT ORIGINAL WIRING
MATCHES. COLORS MAY BE DIFFERENT

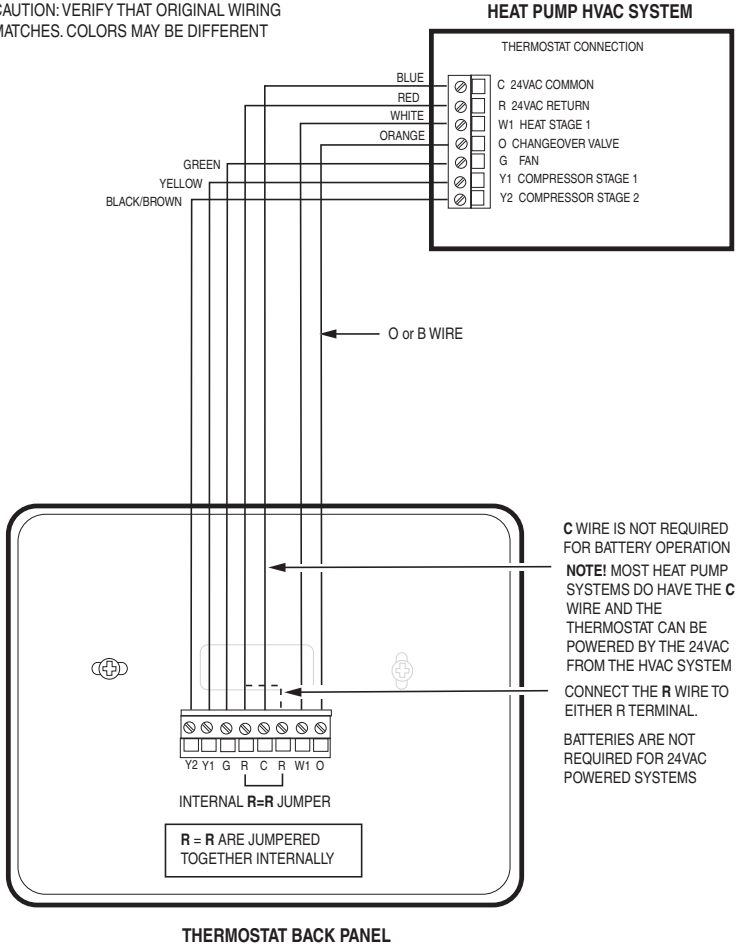

NOTE: IF HEATING IS OCCURRING WHEN COOLING IS EXPECTED, OR VICE-VERSA, CHANGE THE CHANGEOVER TYPE TO THE OPPOSITE SETTING.

Thermostat Power

The thermostat can be powered by either 24VAC from the HVAC system or from four (4) type AA internal batteries. **DO NOT** use this thermostat for line voltage controls (120/240VAC).

The C Wire

If the 24VAC common wire (usually blue) is present and is connected to 24VAC common at the HVAC system end, the thermostat can be powered from the HVAC system and batteries are not required. If there is no common wire, batteries are required.

24VAC Power

Powering the thermostat with 24VAC power **requires** both the 24VAC "C" common wire (typically a blue wire) and the 24VAC "R" return wire (typically a red wire).

Battery Power

Powering the thermostat from batteries **does not** require a "C" wire connection.

DO NOT install batteries if the thermostat is powered by 24VAC. They are not required for backup.

If the thermostat is powered by batteries, the thermostat will operate for approximately (2) two years on four (4) AA Alkaline batteries depending on the frequency of user operations and backlight operation. Always use Alkaline batteries and replace in complete sets of four (4) at a time.

Z-Wave Operation when Battery Powered

IMPORTANT: If the thermostat is installed on a Z-Wave network, while it is battery powered, it will **NOT** work as a Z-Wave repeater.

CAUTION: Do not install batteries and temporarily power the thermostat from 24VAC to include onto a Z-Wave network. Shortened battery life may occur when 24VAC power is removed.

Remove Existing Thermostat

- Turn off the power to the thermostat. This is usually done at the heating/cooling system or circuit breaker panel.
- Remove the cover of old thermostat to expose the wiring terminals.
- **Take a picture of the wiring terminals and the wires before disconnecting them!**
- Mark the existing thermostat wires with the wiring labels included according to the terminal markings. Some installations may have additional wires not shown in this example illustration. Y1, Y2, W1, W2, O,B.
- Use the thermostat terminal “names/markings” (not the wiring color) to mark the wires.
- Remove the old thermostat base.

CAUTION: When removing thermostat, don't let the wires slip into the wall and **don't let the wires touch each other.**

- If the old thermostat was a mercury style thermostat, dispose of it properly as described below.

Figure 2. Label Wire Terminals

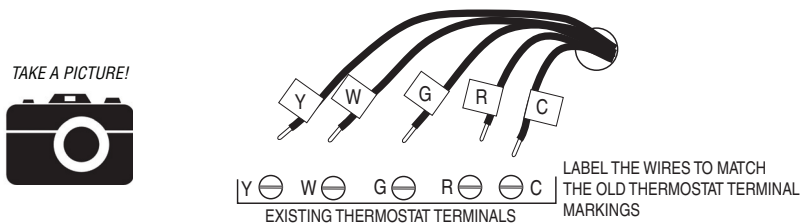

NOTE: Taking a picture is critical if problems are encountered. This will allow reinstallation of the old thermostat and will help with troubleshooting later if needed.

Terminal	Typical Wire Color	Function
Y	YELLOW	Cool
W	WHITE	Heat
G	GREEN	Fan
R	RED	24VAC Return
C	BLUE	24V Common (typically BLUE). When the wire is present, the thermostat can be powered without batteries. When the wire is absent, the thermostat must be powered by batteries if 24VAC is present across the R&C wires

Wiring Colors

While the thermostat terminal markings are intended to match the wire color, (R=RED, G=GREEN, W=WHITE, Y=YELLOW) be sure to follow the terminal marking when marking the wires, even if the wire color doesn't match.

WARNING: If the existing thermostat is a mercury-containing device, it must be disposed of in compliance with federal, state, and local regulations. Many states and /or local agencies have collection/exchange programs or hazardous waste collection programs for mercurycontainingdevices. For more information, see the U.S. Environmental Protection Agencywebsite at:<http://www.epa.gov/osw/hazard/wastetypes/universal/mce.htm> For Canada: Environment Canada and Disposing of Mercury Products at: <https://www.ec.gc.ca/mercure-mercury/default.asp?lang=En&n=F111AAC6-1>.

Install the Back Panel

Remove the back panel of the thermostat by pushing down the thumb tab on the bottom of the body.

Figure 3. Removing back panel of thermostat.

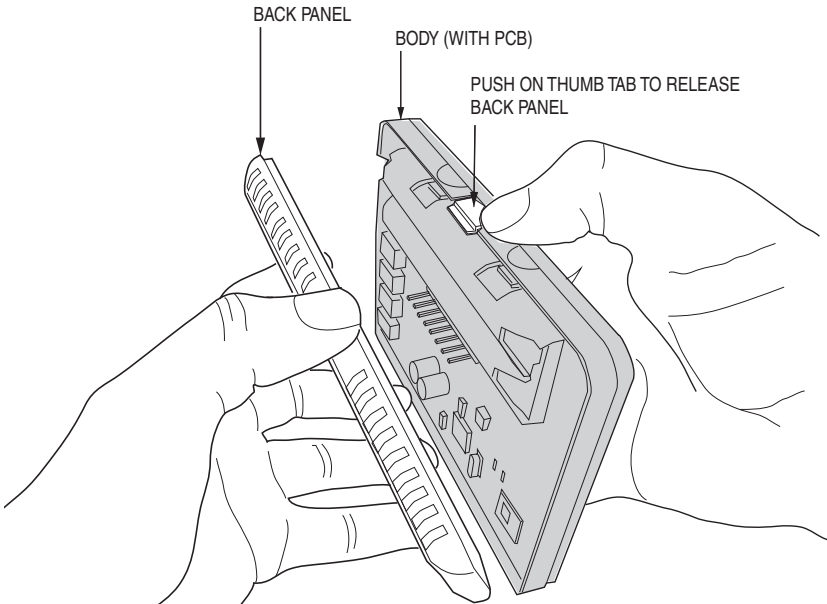

Mount the thermostat back panel on the wall (See Figure 4).

1. Use the two (2) wall anchors and two (2) Phillips screws (provided) to mount the back panel.
2. Level as needed.

Figure 4. Mounting the Back Panel

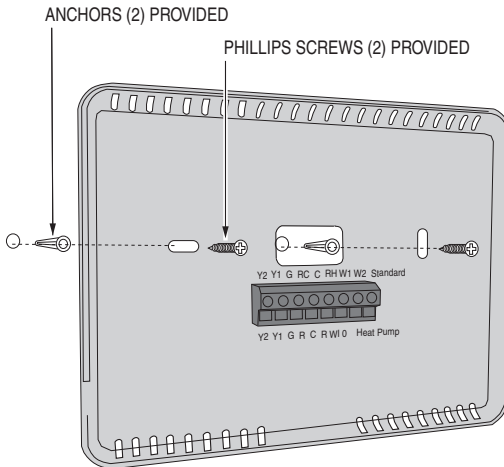

Standard HVAC System Connections

NOTE: For typical connections to a Standard HVAC system, refer to the diagram on Page 2.

The terminals on the back panel have two sets of labels. The upper label shows the **STANDARD HVAC** terminal connections. The lower label shows **HEAT PUMP HVAC** terminal connections.

Figure 5. Standard HVAC System Terminal Block Labeling

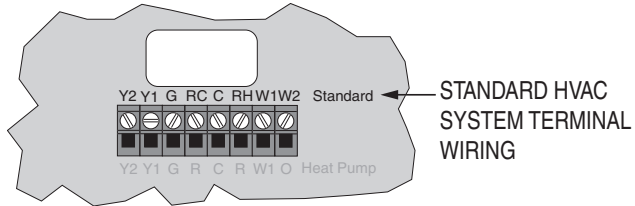
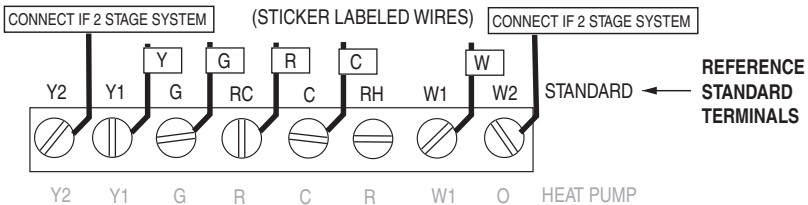

Figure 6. Standard HVAC Systems Terminal Block Connections



Single and Dual Transformer Systems (Split Systems)

HVAC systems may have one or two transformers. The “R” wire connects differently depending on the system.

Single Transformer System

Most HVAC systems have a single 24VAC transformer. For these systems, there is only one “R” wire and it can be connected to either the thermostat’s RC or RH terminal as these are **internally jumpered** together.

If installing a Standard HVAC system, connect the wires from the HVAC system to the corresponding terminals on the thermostat back terminal block. Use the table below as a guideline for connecting the wires.

Wire	Terminal
Y	Connect to the Y1 terminal
G	Connect to the G terminal
R	Connect to either RC or RH terminals (Except for Dual Transformer Systems, See Next Page)
C	Connect to the C terminal. C wire (24VAC common) may not be present. If not present, batteries MUST be installed.
W	Connect to the W1 terminal

NOTES: Ensure that the appropriate wires are screwed into the terminal blocks firmly.
Gently pull on the wires to confirm the connection.
Push all excess wiring back into the wall opening.

Dual Transformer Systems

For HVAC systems that have separate heating and cooling systems, each with their own 24VAC transformers, there will be an “R” wire from the heating system and an “R” wire from the cooling system.

For dual transformer systems, connect the “C” wire from the **cooling** system to the thermostat’s “C” terminal. **DO NOT CONNECT THE “C” WIRE FROM THE HEATING SYSTEM.**

Figure 7. Dual Transformer HVAC System Thermostat Terminal Connections

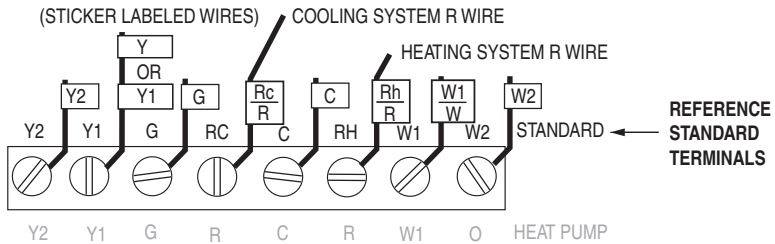

Connect the wires from the HVAC system to the corresponding terminals on the thermostat back terminal block. Use the table below as a guideline for connecting the wires.

Wire	Terminal
Y2	Connect to the Y2 terminal (2-stage systems only)
Y or Y1	Connect to the Y1 terminal
G	Connect to the G terminal
COOL Rc	Connect to RC terminal
C	Connect to C terminal (Cooling System C Wire, NOT Heating System C Wire)
HEAT Rh	Connect to RH terminal
W or W1	Connect to W1 terminal
W2	Connect to W2 terminal (2-stage system only)

IMPORTANT! FOR SEPARATE RC/RH SYSTEMS, THE INTERNAL RC=RH JUMPER MUST BE CUT ON THE BACK OF THE THERMOSTAT’S PRINTED CIRCUIT BOARD— (See Figure 8).

Figure 8. Internal RC=RH Jumper

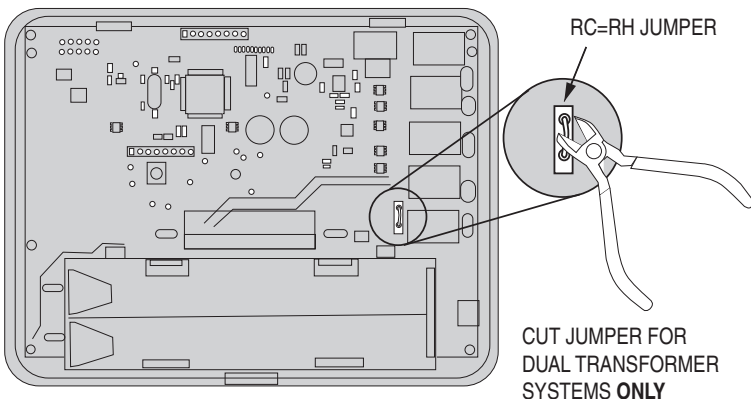

Heat Pump HVAC System Connections

NOTE: For typical connections to a Heat Pump HVAC system, refer to the diagram on Page 3.

The terminals on the back panel have two sets of labels. The lower label shows **HEAT PUMP HVAC** terminal connections. The upper label shows the **STANDARD HVAC** terminal connections.

Figure 9. Heat Pump HVAC System Terminal Block Labeling

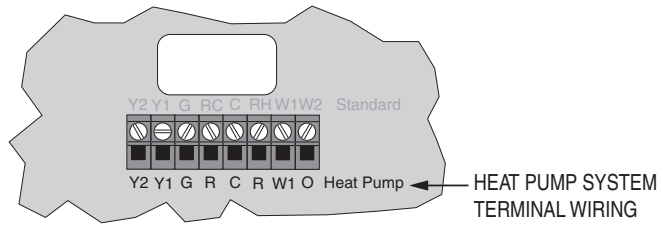
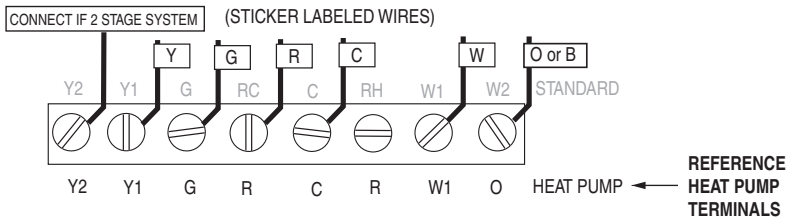

Figure 10. Heat Pump HVAC System Thermostat Terminal Block Connections



Connect the wires from the HVAC system to the corresponding terminals on the thermostat back terminal block. Use the table below as a guideline for connecting the wires.

Wire	Terminal
Y	Connect to the Y1 terminal
G	Connect to the G terminal
R	Connect to either R terminal
C	Connect to the C terminal. The C wire (24VAC common) Heat Pump systems typically have the C wire connected to the thermostat. If there is no C wire, batteries MUST be installed
W	Connect to the W1 terminal
O or B	Connect to the O terminal. Heat Pump setup must set changeover valve to correct O or B setting (See page 13).

NOTES: Ensure that the appropriate wires are screwed into the terminal blocks firmly. Gently pull on the wires to confirm the connection. Push all excess wiring back into the wall opening.

Mount the Thermostat

Install the thermostat body/front panel onto the wall mounted base by firmly pressing in place until it snaps all around the edges. The GC-TBZ48 is now ready to program.

Figure 11. Attaching Front Panel to Back Panel

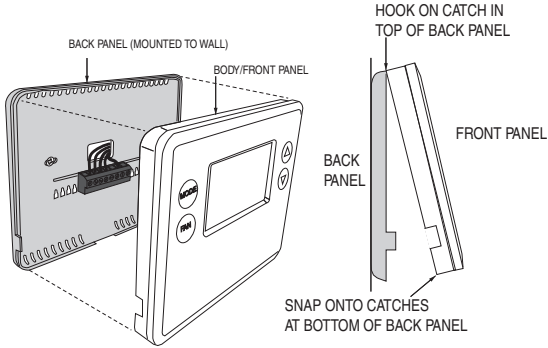

Battery Installation

If installing batteries, open the thermostat battery front panel, pry it off with fingernail at indents on bottom of case (See Figure 12). Install the four (4) type AA batteries and assemble as shown in Fig.13.

Figure 12. Opening Battery Case/Cover

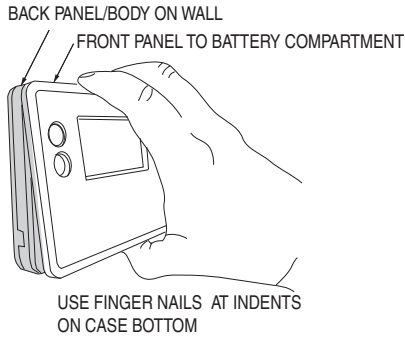
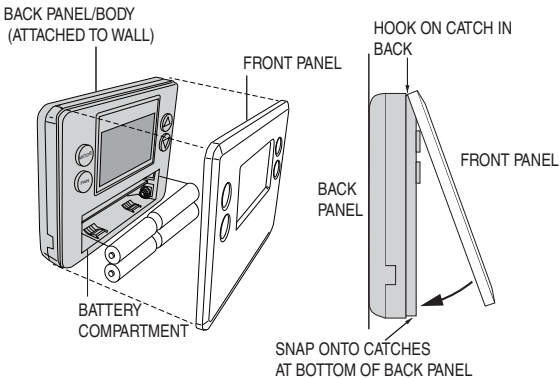

Figure 13. Battery Installation



Thermostat Setup Menus

The thermostat must be setup for the correct HVAC system type for proper operation.

Preset HVAC System settings

The thermostat is preset for the following typical HVAC system configuration:

- HVAC system type: Standard gas/electric
- HVAC fan type: Gas heat
- HVAC heating stages: one
- HVAC cooling stages: one

If the thermostat is installed on this type HVAC system, the System Setup does not need to be changed.

If installed on a Heat Pump HVAC system or any HVAC configuration other than the preset settings, change the settings in the SYSTEM setup menu to match the HVAC system.

NOTE: To conserve battery life, the thermostat backlight turns off after a short time of no activity. The first press of any button turns on the backlight (but does not initiate any action). Press the button again to initiate the action desired. If the backlight is already on, button presses work with the first press.

Wait Mode

The thermostat has a Minimum Off Time (MOT) delay after any heating or cooling cycle ends. This delay prevents rapid heating/cooling cycles and also provides “short cycle protection” for the system compressor. This delay may be noticeable when you change a setpoint and it does not respond immediately due to the MOT delay timer preventing the system from restarting. The MOT delay time can be adjusted in the Advanced Settings menu of the thermostat but there is a minimum of five minutes delay to assure compressor protection.

Minimum Run Time (MRT)

The thermostat has a Minimum Run Time delay after the start of any heating or cooling call. This minimum run time assures even heating and cooling cycles. The MRT will keep the system on, even if it reaches the setpoint room temperature, or you change the setpoint to a temperature that would satisfy the call, until the MRT expires. Changing the Mode to OFF will cancel the MRT and the system will turn off immediately. The MRT can be adjusted in the Advanced Settings menu of the thermostat.

NOTE: The MRT delays are shown by flashing heat or cool icons on the display.

Entering Menu Mode

To change the System setup, go to the thermostats Menu Mode and select **SYSTEM**. From there select the correct HVAC settings to match the installation type.

Press and hold the **FAN** button to enter the Menu Mode. **SETUP** is the first menu item displayed. Press the ▼ button to advance to the **SYSTEM** screen.

Figure 14. Menu Mode Setup

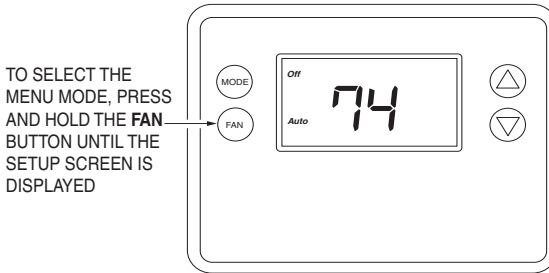

Menu Mode Navigation

When the Thermostat Menu Mode screen is displayed, press the ▲▼ buttons to scroll through the following menu items.

Figure 15. Menu Navigation

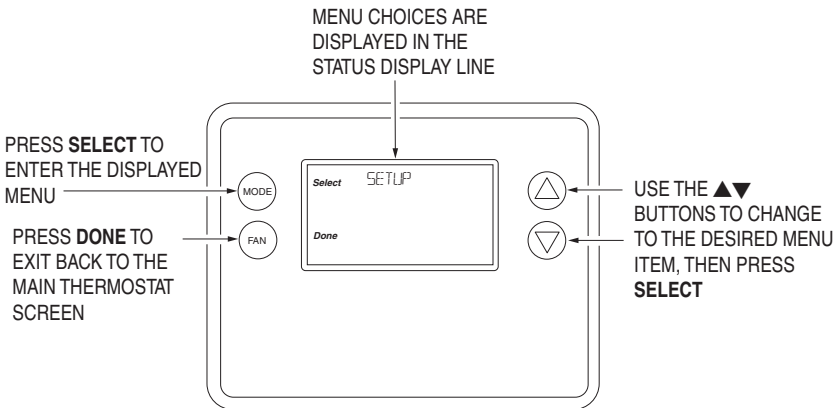

The following menu items are displayed in order.

- **SETUP** (user preference settings)
- **SYSTEM** (HVAC system setup)
- **Z-WAVE** (install/uninstall from Z-Wave network)
- **CLOCK** (set time and day)
- **INFO** (firmware versions and Z-Wave network information)

System Menu

The SYSTEM menu is used to setup the thermostat for the correct HVAC system type. The following setup options will be displayed in the text line:

- HVAC System Type: Standard Gas/Electric or Heat Pump
- Fan Type: Gas Heating or Electric Heating
- Changeover Valve Type (for Heat Pump Systems): Changeover with Cooling or with Heating.

To select options:

- Use the ▲▼ buttons to scroll to the desired setting.
- Press **SELECT** to change a setting. The current setting for that selection will be flashing.
- Change the option with the ▲▼ buttons.
- When the desired option has been selected, Press **SELECT** again to save it.
- Then press **DONE** to exit.

System Type

- For Standard Gas/Electric systems, select **STANDARD** This is the default setting.
- For Heat Pump systems, press the ▲▼ buttons to change to **HEAT PUMP**
- Press **SELECT** to set.
- Press **DONE** to exit.

Fan Type (For Standard HVAC systems only)

Fan type depends on the heating system type.

- For Gas heat: select **GAS**. This is the default setting.
- For Electric heat: press the ▲▼ buttons to change to **ELECTRIC**.
- Press **SELECT** to set.
- Press **DONE** to exit.

Changeover Type (For Heat Pump HVAC Systems Only)

The changeover (or reversing) valve is used to change from heating to cooling operation. The HVAC system is either a Changeover with Cooling type (O) or Changeover with Heating type (B). Most are changeover with cooling, which is the default setting.

- For Changeover with Cooling systems, select **WITH COOL**. This is the default setting.
- For Changeover with Heating systems, use the ▲▼ buttons to change to **WITH HEAT**.
- Press **Select** to set.
- Press **Done** to exit.

Not sure what type Changeover system? Check the existing thermostat connections to help determine this. If the original system had an orange wire connected to an "O" terminal, then this is a "changeover with cool" system. If there was a brown wire connected to a "B" terminal, then this is a "change over with heat" system. Set the Changeover setting accordingly.

NOTE: If heating comes on when cooling is expected or vice versa, switch the "Changeover Type" to the opposite setting.

Z-Wave Installation

Z-Wave controllers from various manufacturers may support the Z-Wave Thermostat General V2 Device class used by the Go Control Z-WAVE Thermostat. The following procedure will allow the thermostat to be added to a Z-Wave network.

NOTE: Before adding the thermostat to a Z-Wave Network, check that it does not already belong to one by viewing the Node ID (ZNID) located in the Thermostat Info screen. An uninstalled thermostat should show zeros for the Node ID (000). Consult your controller's user manual for details on removing a device from a Z-Wave network.

Figure 16. Z-Wave Menu Setup

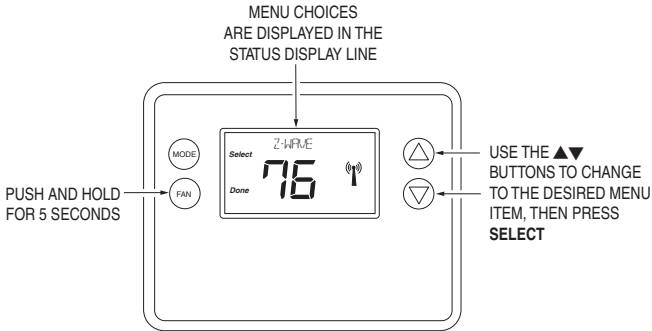

General Programming Procedure (for controllers supporting the thermostat device class):

1. Set your primary controller to include, add or install mode, to add the thermostat as a node on your network (see your controller's user manual for detailed instructions).
2. Press any button to take thermostat out of sleep mode.
3. Press and hold **FAN** button for 5 seconds. **SETUP** will be displayed in the status display line.
4. Scroll to "Z-Wave" using **▲▼** buttons. Press **SELECT**.
5. When prompted by your Z-Wave controller, Press the **YES** button in the Z-Wave Install screen.
6. Press **SELECT** (mode button) to add thermostat to network.
7. Display line should flash **WAIT** then **SUCCESS** if Z-Wave connection is made.
8. If Z-Wave does not connect to controller, **WAIT**, then **FAIL** will flash in status display line.
9. If thermostat fails to connect, repeat Steps three (3) thru (7) to re-try connecting.

Your controller will indicate the thermostat was successfully added to its network (see your controller's user manual for details). Also, you can check if the thermostat was successfully added to the network by checking the ZHID (Home ID) and ZNID (Node ID) located in the Thermostat Info screen.

For other specific tasks such as adding the thermostat to Scenes or Groups, or deleting the thermostat from an existing network, refer to the Z-Wave controller instructions.

Inclusion and Exclusion

Inclusion or exclusion is started by putting the controller into add node or remove node state and performing the General Programming Procedure outlined above. As part of the process, the thermostat sends a node information frame at normal power. Low power inclusion or low power exclusion is not possible.

CAUTION: Do not install batteries and temporarily power the thermostat from 24VAC to include onto a Z-Wave network. Shortened battery life may occur when 24VAC power is removed.

Clock Menu

Use the clock menu to set thermostat's internal clock.

Figure 17. Clock Setup

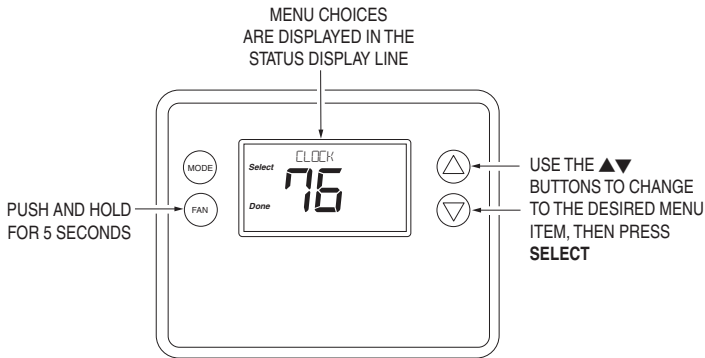

Setting the Clock

1. Press any button to take thermostat out of sleep mode.
2. Press **FAN** button for 5 seconds until, **SETUP** appears in status display line.
3. Use ▲▼ buttons to select **CLOCK** in status display line.
4. Press **SELECT**, **DAY** will be displayed
5. Press ▲▼ buttons, **TIME** will be displayed.
6. Use the ▲▼ buttons to select the current time.
7. Press **SELECT**, **FAN (Done)**, **FAN (Done)**.

INFO Menu

The INFO menu displays information about the thermostat. Use the ▲▼ buttons to scroll through the various items.

- MODEL GC-TBZ48
- VERSION Thermostat firmware version.
- ZWAVE Z-Wave firmware version.
- NODE ID Z-Wave Node ID.
- HOME ID Z-Wave Home ID.
- SYSTEM TYPE displays current System Type setting.
- If System Type = Standard, FAN TYPE displays current Fan Type setting.
- If System Type = Heat Pump, CHANGEVER TYPE displays current Change Over setting.

Advanced System Settings Menu

The Advanced System Settings Menu provides for addition system setup options. These settings can affect system operation and should only be changed by qualified HVAC installers.

To access the Advanced System Settings menu, first press and hold the **FAN** button to get into the Setup menu. While in the Setup Menu, press and hold both the **FAN** and **▼** buttons for 5 seconds.

- Use the **▲▼** buttons to scroll through the menu options to the desired setting.
- Press **SELECT (Mode)** button to change a setting. Once it begins to flash, use the **▲▼** buttons to select the desired setting.
- Press the **SELECT** button to accept the new setting (flashing will stop).

Feature	Description	Range	Default Setting
Test Mode	Test mode shortens the system built-in delays (like MOT and MRT) Y = Test mode on. Reduces all delays to 10 seconds for quicker system testing N = Test mode off. Normal system delays	Y or N	N
Aux Heat Enable (Heat Pump Systems only)	Enables the auxiliary heat operation. Typically the auxiliary heat will be heat-strips in a heat pump system.	Y or N	N
2nd Stage Heat Enable	Enables the second stage heat operation	Y or N	N
2nd Stage Cool Enable	Enables the second stage cool operation	Y or N	N
Minimum run time	Sets the Minimum Run Time (MRT) delay before a heating/cooling cycle can turn off. Sets heating/cooling cycle time. Prevents rapid on/off cycling.	1-9	3
Minimum Off time	Sets the Minimum Off Time (MOT) delay before another heating/cooling cycle can begin. Provides compressor short cycle protection. "Wait" is displayed on screen when active.	5-9 Minutes	5
Heat Setpoint Max.	Sets the maximum heating setpoint value. Will not ramp or accept setpoints higher than this maximum	55F to 96F (4C to 43C)	90F (32C)
Cool Setpoint Min.	Sets the maximum heating setpoint value	60F to 99F (6C-45C)	60F (15C)
Heat Blower Off Delay	Sets the system blower delay off time after a heat call ends (fan purge)	0 to 9 seconds	0 (off)
Cool Blower Off Delay	Sets the system blower delay off time after a cool call ends (fan purge)	0 to 9 seconds	0 (off)

Feature	Description	Range	Default Setting
Heat - Cool Delta	Sets the minimum separation between heating and cooling setpoints. NOTE: Attempts to lower cooling setpoint below the heating setpoint will PUSH the heating setpoint down to maintain this separation. The same applies to setting the heating setpoint above the cooling setpoint, it will PUSH the cooling setpoint up to maintain the setpoint delta separation	3 to 15 degrees	3F (1C)
Heating Stage 1 on Threshold	Sets the delta from setpoint that stage 1 heating starts	1 to 6 degrees	1
Heating Stage 1 Off Threshold	Sets the delta from setpoint that stage 1 heating stops. Stage 1 turns off at setpoint + Delta Stage 1.	0 to 5 degrees	0
Heating Stage 2 On Threshold	Sets the delta from setpoint that stage 2 heating starts	2 to 7 degrees	2
Heating Stage 2 Off Threshold	Sets the delay from setpoint that stage 2 heating stops. Stage 2 turns off at setpoint + Delta Stage 2.	0 to 6 degrees	0
Aux Heat On Threshold	Sets the delta from setpoint that stage 3 heating starts	3 to 8 degrees	3
Aux Heat Off Threshold	Sets the delta from setpoint that stage 3 heating stops. Stage 3 turns off at setpoint + Delta Stage 3	0 to 7 degrees	0
Cooling Stage 1 On Threshold	Sets the delta from setpoint that stage 1 cooling starts.	1 to 7 degrees	1
Cooling Stage 1 Off Threshold	Sets the delta from setpoint that stage 1 cooling stops. Stage 1 turns off at setpoint - Delta Stage 1	0 to 6 degrees	0
Cooling Stage 2 On Threshold	Sets the delta from setpoint that stage 2 cooling starts.	2 to 8 degrees	2
Cooling Stage 2 Off Threshold	Sets the delta from setpoint that stage 2 cooling stops. Stage 2 turns off at setpoint - Delta Stage 2.	0 to 7 degrees	0
Restore Defaults	Restores all settings to factory defaults. Press Yes to restore defaults Press No to exit and not restore defaults	Y or N	N

Thermostat Operation

Main Thermostat Screen

Figure 18. Main Screen

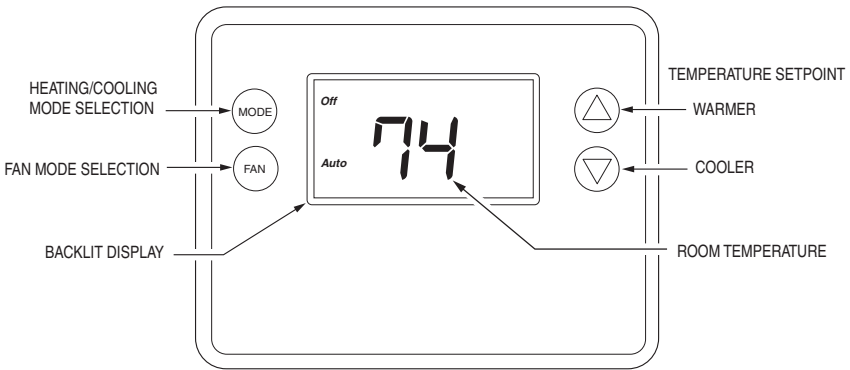

Backlight and Button Operation

The thermostat backlight is normally set to go out after 20 seconds of no button presses to conserve battery power. If the backlight is off, the first button press of any button will only turn on the backlight. Once the backlight is on, the buttons function normally.

Display

Figure 19. Display Screen System Operation Model

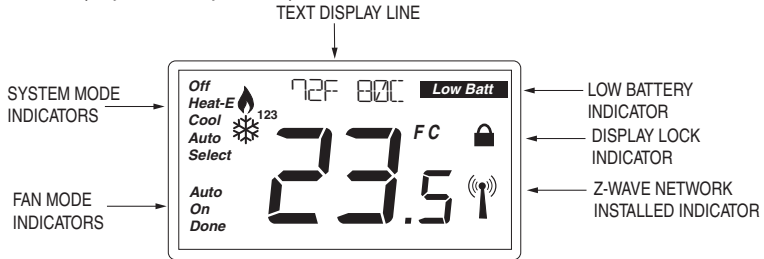

displayed > System is ON and heating



blinking > System is ON and heating. Minimum Run Time (MRT) delay is active



displayed > System is ON and cooling



blinking > System is ON and cooling. Minimum Run Time (MRT) delay is active

NOTE: Degrees C (Celsius) are shown in .5 degree increments. Degrees F (Fahrenheit) are shown in 1 degree increments

Staging Indicators

"1" = Stage 1 heating or cooling is ON

"2" = Stage 2 heating or cooling is ON

"3" = Stage 3 heating (Aux Heat) is ON

For Heat Pump systems only:

"Heat-E" = Emergency heat mode active

Setting the System Mode

Figure 20 Setting the System Mode

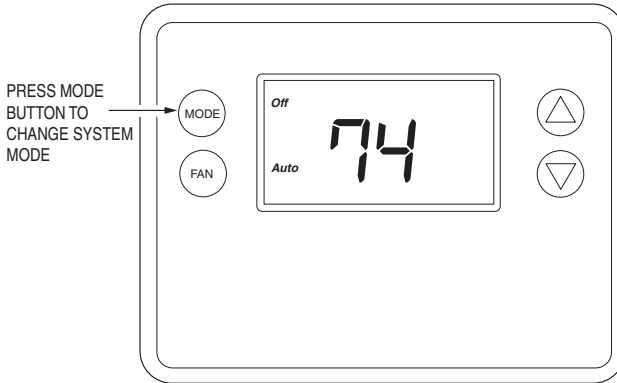

System Modes

- **Off:** System is off. No heating or cooling will come on. If system was on, it will turn off immediately.
- **Heat:** Only heating will occur.
- **Cool:** Only cooling will occur.
- **Auto:** Heating or cooling will come on according to the heating and cooling setpoints. The system will automatically switch between heating and cooling modes as needed to maintain the setpoints.

Special Heat Pump Mode: Emergency Heat

An additional system mode, “Heat-E” for Emergency Heat will be displayed if the HVAC System Type is set to Heat Pump. If there is a compressor failure with the Heat Pump system, setting the mode to Emergency Heat will allow the supplemental Aux Heat to come on first whenever there is a call for heating. It also disables the compressor output to prevent further damage to the HVAC system.

CAUTION! Emergency Heat should only be used for emergencies until the HVAC system can be repaired. Running the system in Emergency Heat mode is commonly the most expensive mode since only the electric heat strips are being used instead of the more efficient heat pump compressor.

Setting the Heating or Cooling Temperature Setpoint

To change the setpoint, press the ▲▼ buttons. The screen will switch to the setpoint change screen and show the current setpoint of the current heating or cooling mode. Adjust the setpoint temperature up or down with the ▲▼ buttons.

NOTE: When in the Setpoint Change screen, pressing the **MODE** button will switch the setpoint being displayed between the Heat and Cool setpoints.

Figure 21. Accessing Setpoints

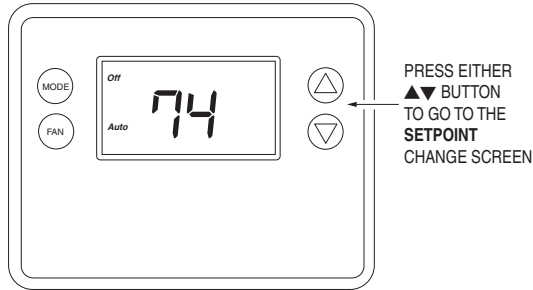
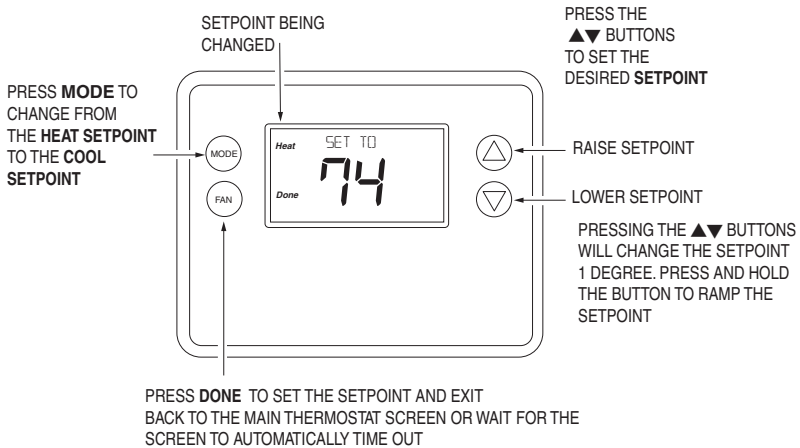

Figure 22. Setpoint Change Screen



Automatic Setpoint Push

The cooling setpoint cannot be set below the heating setpoint. The thermostat will “push” the heating setpoint lower if the cooling setpoint is set below the current heating setpoint. A 3 degree separation is maintained between the heating and cooling setpoints. The same is true for raising the heating setpoint above the cooling setpoint. The thermostat will “push” the cooling setpoint up to maintain the 3 degree separation.

Setting the Fan Mode

Figure 23. Fan Setting

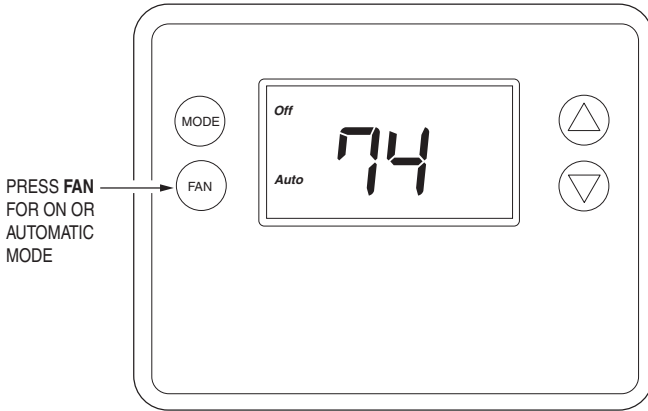

Fan Modes

Use the **FAN** button to select the HVAC system's fan mode.

- Auto: Fan automatically operated by the HVAC system (normal setting).
- On: Manual Fan mode. Fan stays on until mode is changed back to Auto, independent of the heating or cooling system operation.

User Customization

Figure 24. Selecting Menu Mode

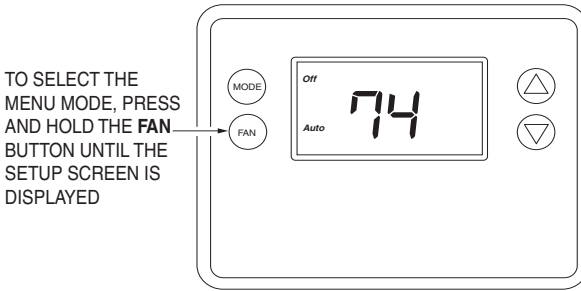
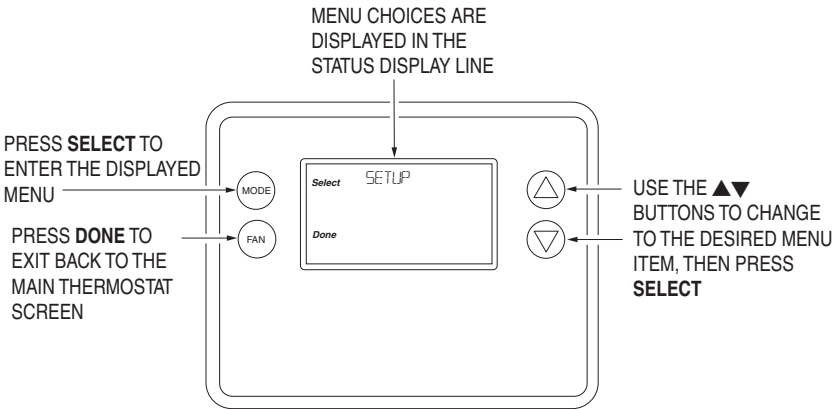

Figure 25. Menu Navigation



User preference settings.

- **FAHRENHEIT OR CELSIUS.** Select the temperature display mode.
- **BACKLIGHT TIMEOUT.** Sets the time from last button press that the backlight will turn OFF. Range: 10-30 seconds. Note: long backlight timeouts will reduce battery life.

Note: If the thermostat is powered from 24VAC, the backlight timeout can be set to "0" which will keep the backlight on continuously.

- **SENSOR CALIBRATION** Change the temperature calibration by +/- 7 degrees. Press the UP or DOWN arrow buttons to change to the desired display temperature.
- **STATUS LINE.** Sets Status Line to Setpoints or Clock mode.

Clock Menu

Use the clock menu to set thermostat's internal clock.

Figure 26. Clock Setup

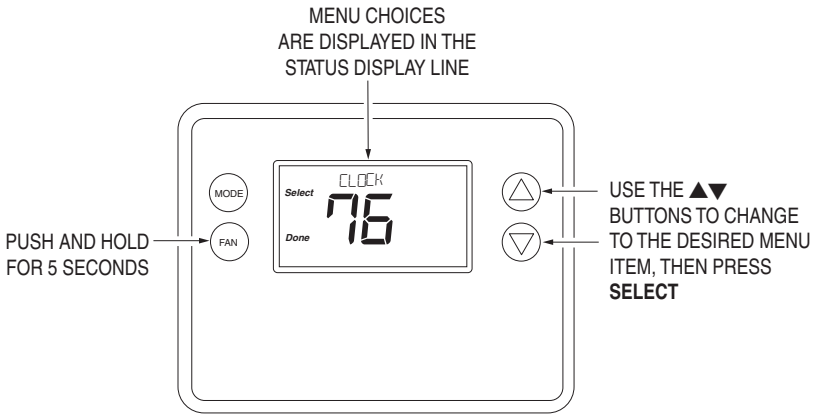

Setting the Clock

1. Press any button to take thermostat out of sleep mode.
2. Press **FAN** button for 5 seconds until, **SETUP** appears in status display line.
3. Use **▲▼** buttons to select **CLOCK** in status display line.
4. Press **SELECT**, **DAY** will be displayed
5. Press **▲▼** buttons, **TIME** will be displayed.
6. Use the **▲▼** buttons to select the current time.
7. Press **SELECT**, **DONE**, **DONE**.

INFO Menu

The INFO menu displays information about the thermostat. Use the **▲▼** buttons to scroll through the various items.

- MODEL NTBZ48
- VERSION Thermostat firmware version.
- ZWAVE Z-Wave firmware version.
- NODE ID Z-Wave Node ID.
- HOME ID Z-Wave Home ID.
- SYSTEM TYPE displays current System Type setting.
- If System Type = Standard, FAN TYPE displays current Fan Type setting.
- If System Type = Heat Pump, CHANGEOVER TYPE displays current Change Over setting.
- Battery xx% = Battery Level (If battery powered)

Specifications

Power	C-Wire Input: 20-30VAC Battery Power: 4 AA Batteries
Operating Temperature	32° to 120°F (0° to 49°C)
Storage Temperature	-40° to 140°F (-40° to 60°C)
Messaging Capability	7 character alpha numeric display, with message scroll
Set-point Accuracy	1° F (0.5°C), Calibrates to +/- 7°F
Ambient Temperature Display Accuracy	1° F (0.5°C)
Remote Control	Via Z-Wave
Standard Gas/Electric HVAC Systems	2-stage heating, 2-stage cooling
Heat Pump HVAC System	3-stage heating, 2-stage cooling
Thermostat Connections	Uses standard thermostat connections (C,RC,RH,W1,W2/O,Y1,Y2,G) - 18 AWG
Regulator	United States: FCC Compliant to CFR47, Part 15B Canada: Industry Canada RSS 210, Issue 8
Dimensions	5.75" (146mm) W, 4.5"(114.3mm) H, 1.00 (25.4mm) D
Screen Size	2.7" X 1.4" LCD w/white backlight (68.6mm X 35.6mm)
Buttons	4 mechanical buttons (Mode, Fan, Up Arrow, Down Arrow)
Certification	FCC Part 15, Industry Canada

Regulatory Information

FCC ID: WIBTZW011

This device complies with Part 15 of the FCC Rules. Operation is subject to the following two conditions: (1) This device may not cause harmful interference, and (2) This device must accept any interference received, including interference that may cause undesired operation.

This equipment has been tested and found to comply with the limits for Class B Digital Device, pursuant to Part 15 of the FCC Rules. These limits are designed to provide reasonable protection against harmful interference in a residential installation. This equipment generates and can radiate radio frequency energy and, if not installed and used in accordance with the instructions, may cause harmful interference to radio communications. However, there is no guarantee that interference will not occur in a particular installation. If this equipment does cause harmful interference to radio or television reception, which can be determined by turning the equipment off and on, the user is encouraged to try to correct the interference by one or more of the following measures.

- Reorient or relocate the receiving antenna
- Increase the separation between the equipment and receiver
- Connect the equipment into an outlet on a circuit different from that to which the receiver is connected
- Consult the dealer or an experienced radio/TV technician for help

Any changes or modifications not expressly approved by the party responsible for compliance could void the user's authority to operate the equipment.

Industry Canada Notices

IC: 9374A-TBZ48

This device complies with Industry Canada license-exempt RSS standard(s). Operation is subject to the following two conditions: (1) this device may not cause interference, and (2) this device must accept any interference, including interference that may cause undesired operation of the device.

Le présent appareil est conforme aux CNR d'Industrie Canada applicables aux appareils radio exempts de licence. L'exploitation est autorisée aux deux conditions suivantes : (1) l'appareil ne doit pas produire de brouillage, et (2) l'utilisateur de l'appareil doit accepter tout brouillage radioélectrique subi, même si le brouillage est susceptible d'en

compromettre le fonctionnement.

Limited Warranty

This Nortek Security & Control LLC product is warranted against defects in material and workmanship for one (1) year. This warranty extends only to wholesale customers who buy direct from Nortek Security & Control or through Nortek Security & Control normal distribution channels. Nortek Security & Control does not warrant this product to consumers. Consumers should inquire from their selling dealer as to the nature of the dealer's warranty, if any.

There are no obligations or liabilities on the part of Nortek Security & Control for consequential damages arising out of or in connection with use or performance of this product or other indirect damages with respect to loss of property, revenue, or profit, or cost of removal, installation, or reinstallation. All implied warranties for functionality, are valid only until the warranty expires. This Nortek Security & Control Warranty is in lieu of all other warranties express or implied.

GoControl™

Go Control

1950 Camino Vida Roble, Suite 150

Carlsbad, CA 92008 USA

For technical support in the USA and Canada:

Dial: 855-2GIG-TECH (855-244-4832)

Email : 2gigtechsupport@nortek.com

Visit website for technical support hours of operation

For technical support outside of the USA and Canada:

Contact your regional distributor

Visit www.2GIG.com or dealer.2gig.com technical support hours of operation

 **NORTEK**
SECURITY & CONTROL