

Luminaire Specifications List

Customer	Henan Sunac Quanjie Real Estate Co., Ltd.
Project Name	Central One Park
Contract Number	B377
Date (yyyy-mm-dd)	2019
Design Area	façade, interior (consulting) and landscape (consulting)
Design Stage	
Version	

Lighting Design Partnership International
Liang Dian Design Center (room A310), 94 Dongsishitiao, Dongcheng District, Beijing 100007
t: +86 10 52978528 / 9
f: +86 10 52978527
e: Enquiry@LDPinternational.com.cn
w: www.LDPinternational.com.cn

Project Name	Central One Park		
Contract Number	B377		
Date (yyyy-mm-dd)	2019		
Design Area	façade, interior (consulting) and landscape (consulting)		
Design Stage			
Version			

Luminaire code		L1	
Type of fixture	wall-wash	Lamp source	LED
Brand	/	Brand	
Product number	BK79-15	Product number	/
Wattage including electrical equipment	/	Wattage	24W/m
Angle adjustable	/	Optic beam angle	50°
Body material	High-strength aluminum	Color temperature	3000K
Reflector material	/	Lumen output	2000lm
Accessory number	Bolt installation	Type of lamp head	/
Installation type	As shown below	Color rendering	≥90
Protection rating	IP65	Lifetime	/
Dimensions (mm)	As shown below	Control type	
Voltage	24V DC	Type of electrical equipment	External LED professional transformer
Frequency (Hz)	50HZ		
Weight (kg)	/	Brand	/
Certification	CCC/CQC	Wattage	/
Remarks	/		
Installation location	The specific electrical equipment depends on the supporting lighting.		

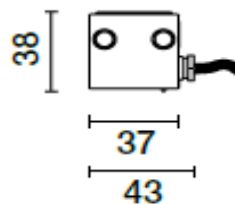
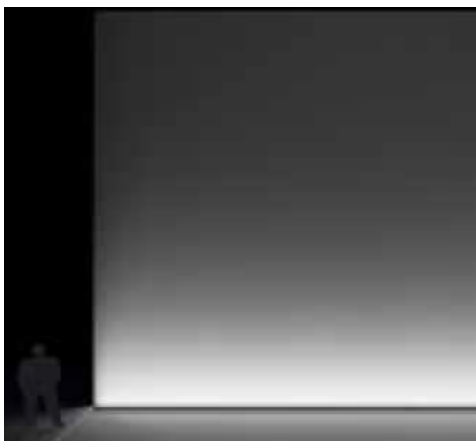
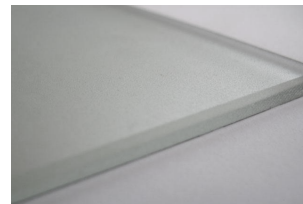

Manufacturer		Contact	
---------------------	--	----------------	--

Project Name	Central One Park		
Contract Number	B377		
Date (yyyy-mm-dd)	2019		
Design Area	façade, interior (consulting) and landscape (consulting)		
Design Stage			
Version			
Luminaire code	L2		
Type of fixture	linear light	Lamp source	LED
Brand	/	Brand	/
Product number	/	Product number	/
Wattage including electrical equipment	/	Wattage	15W/m
Angle adjustable	/	Optic beam angle	120°
Body material	Anodized aluminum	Color temperature	3000K
Reflector material	/	Lumen output	700lm
Accessory number	/	Type of lamp head	/
Installation type	As shown below	Color rendering	≥90
Protection rating	IP65	Lifetime	/
Dimensions (mm)	As shown below	Control type	/
Voltage	24V DC	Type of electrical	External LED professional transformer
Frequency (Hz)	50HZ		
Weight (kg)	/	Brand	/
Certification	CCC/CQC	Wattage	/
Remarks	The continuous splicing of the lamps shall not appear in the dark area.		
Installation location	The specific electrical equipment depends on the supporting lighting.		

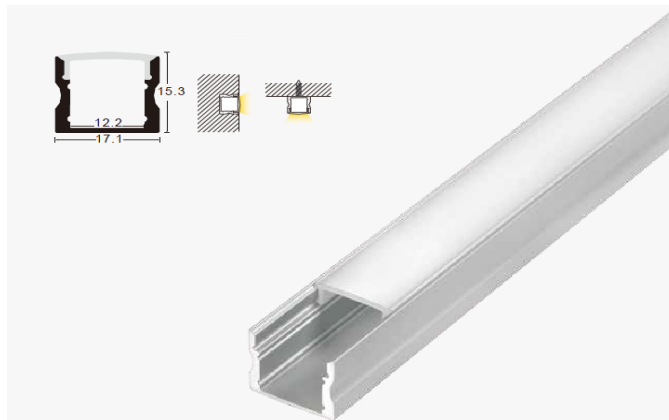

Manufacturer		Contact	
---------------------	--	----------------	--

Project Name	Central One Park		
Contract Number	B377		
Date (yyyy-mm-dd)	2019		
Design Area	façade, interior (consulting) and landscape (consulting)		
Design Stage			
Version			
Luminaire code	X1		
Type of fixture	Recessed light	Lamp source	LED
Brand	/	Brand	/
Product number	E071-13	Product number	/
Wattage including electrical equipment	/	Wattage	1.5W
Angle adjustable	/	Optic beam angle	24°
Body material	Die-cast aluminum lamp	Color temperature	3000K
Reflector material	/	Lumen output	110lm
Accessory number	/	Type of lamp head	/
Installation type	Floor flush mounting	Color rendering	≥90
Protection rating	IP66	Lifetime	3000h
Dimensions (mm)	As shown below	Control type	/
Voltage	24V	Type of electrical equipment	External LED professional transformer
Frequency (Hz)	50HZ		
Weight (kg)	/	Brand	/
Certification	CCC/CQC	Wattage	/
Remarks	/		
Installation location	The specific electrical equipment depends on the supporting lighting.		

Fixed

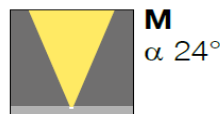
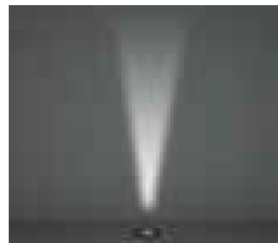
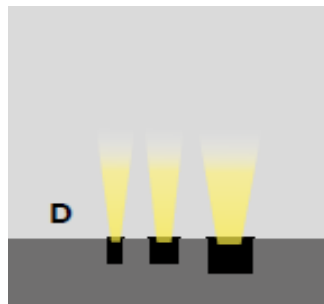
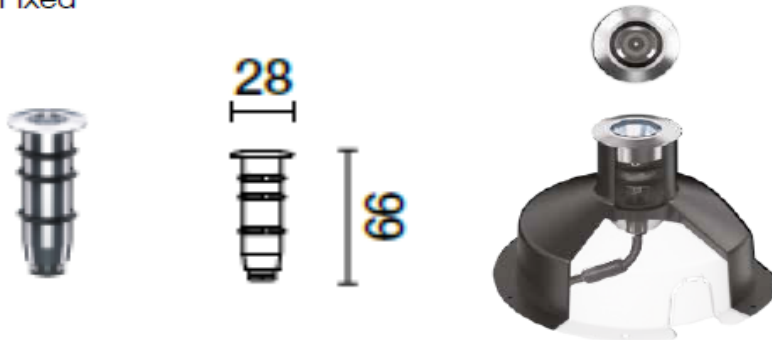

Manufacturer		Contact	
---------------------	--	----------------	--