



fire-parts.com

# Troubleshooting Guide

***\*For Authorized Gas Technicians Use Only\****

## Table of Contents

Introduction	3
Tools and Instruments	4
Intellifire Component Parts	5
Intellifire Basics	7
<b><i>Problem: The Ignitor makes Noise, but No Spark</i></b>	8
<b><i>Problem: Pilot won't Light, No Noise or Spark</i></b>	9
<b><i>Problem: Pilot Lights, but Continues to Spark</i></b>	10
<b><i>Problem: Pilot sparks, but Pilot will not light.</i></b>	12
<b><i>Problem: Pilot lights, stops sparking (flame rectification has occurred), and remains lit but burner will not turn on.</i></b>	13
<b>Problem: Burner Lights, but Burner will Cycle "Off" and "On"</b>	15
<b>FAQ: Wall Switch Installation</b>	16
<b>FAQ: Cabin-Kit and Cold Climate Features</b>	17
<b>FAQ: Ground Strap</b>	18
<b>FAQ: Gas Fuel Conversions</b>	19
Inlet and Manifold Pressure Specifications	20
Intellifire Conversion Components	21
Basic IPI Wiring Diagram	22
IPI Wiring With CABIN-KIT	23
IPI Wiring with power exhaust B-Vent ( <i>Not For PVK-80</i> )	24
IPI Wiring with PVK-80	25

## Introduction

The Intellifire system (Intermittent Pilot Ignition) is an electronic system, which uses an electrode to ignite the pilot gas. In turn the pilot flame lights the main burner gas. The term "intermittent" is used because the pilot burner flame is only present when the main burner is operating. *\*If a Cabin-Kit or DBK Kit is installed, the pilot can remain lit with out the burner.* When the main burner is off the pilot is also off. The Intellifire system ensures the pilot flame extends over the burner for immediate ignition and secondly conserves energy when the appliance is not in operation.

### Service Experience

This troubleshooting guide is for use by a QUALIFIED SERVICE TECHNICIAN ONLY. It is designed to help QUALIFIED SERVICE TECHNICIANS troubleshoot gas appliances. This troubleshooting guide is not to be used by the appliance owner or builders who are not familiar with gas appliances.

**WARNING: Do not attempt to service gas appliances which you are not qualified to service. Service attempted by UNQUALIFIED PERSONS could result in the risk of bodily injury and property damage.**

### Obligations of Service Professionals

Service technicians must be attentive to appropriate codes, understand and follow the manufacturer's installation and service instructions, and use the proper parts and materials when servicing or installing gas appliances. One of the most important tools you can bring to a service call is the installation manual for wiring diagrams, venting applications, clearances to combustibles and part reference. If you do not have a copy of the installation instructions before you go out on a service call, check with the customer to see if they have the original copy which was left with the appliance.

Note: Remember that unit designs and corresponding installation manuals change occasionally. Be sure you are referencing the current manual for the serial # and model # you are working on.

### Communicating with the Customer/Previous Service

Asking the customer a few simple questions can help you service the appliance in a careful and safe manner.

- Has the fireplace ever been serviced? Who? and When?
- Have you tried to operate the appliance before I arrived? How long ago?
- What are the symptoms, when does the problem occur?
- How long has the appliance been installed in your home?

## Tools and Instruments

To properly adjust, service or troubleshoot gas appliances, the service technician must have the proper tools and test equipment.

### Required Tools:

- Open-end wrenches: 3/8", 7/16", 9/16"
- Adjustable end wrenches: 8" and 10"
- 1/4" , 5/16" inch nut driver
- Straight screwdrivers (including small 1/8" blade for pressure check; also stubby straight)
- Phillips screwdrivers #1 and #2 (stubby Phillips)
- 3/16" hex key or set (T-handle needed in some cases)
- Electrical pliers
- Needle Nose Pliers
- Pipe wrenches: 8"-14"
- Tin snips
- Flashlight
- Numbered drill index
- Tubing cutter
- T-20 tamper resistant Torx bit  
*HHT Part # 810-225*
- Flaring tool
- Soft-bristled Tooth brush

- Soft 1" paint brush
- Electric drill: 1/4"-3/8"

### Required Testing Equipment:

- Multi-meter (must measure millivolts)
- Manometer
- LP or NG Gas sniffer or leak detection fluid
- 2 to 4, 12"-14" jumper wires
- "Flame Stick" lighter wand

### Miscellaneous:

- Pipe joint compound
- Smoke match
- Drop cloth (tarp)
- Glass cleaner/towels
- Vacuum
- Grate from wood burning fireplace to set hot logs on.

ALL TOOLS AND TEST EQUIPMENT SHOULD BE PROPERLY STORED AND MAINTAINED

# INTELLIFIRE Component Parts

## Valves

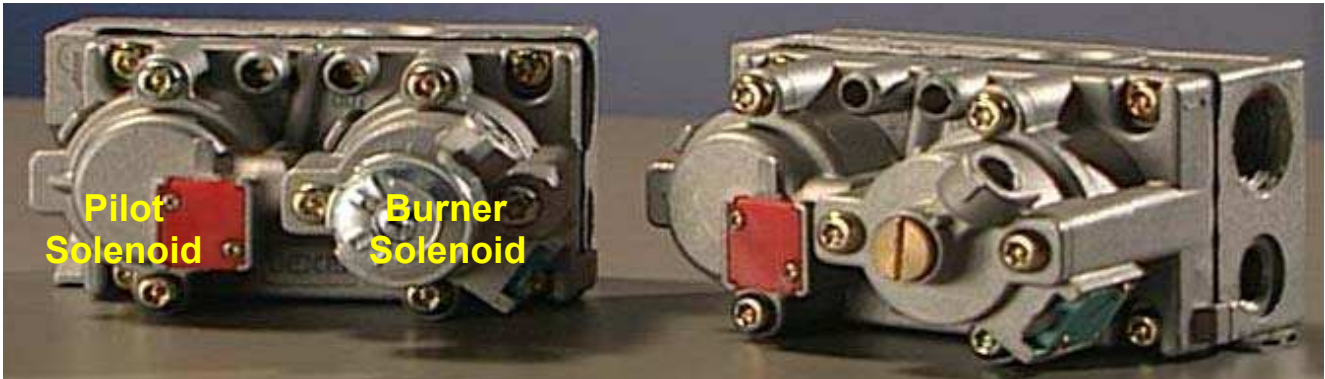

Variable 705-500 NG (705-501 LP)

Non-Variable 593-500 NG (593-501 LP)

## Module



593-592

## Transformer



593-593A

## Battery Pack

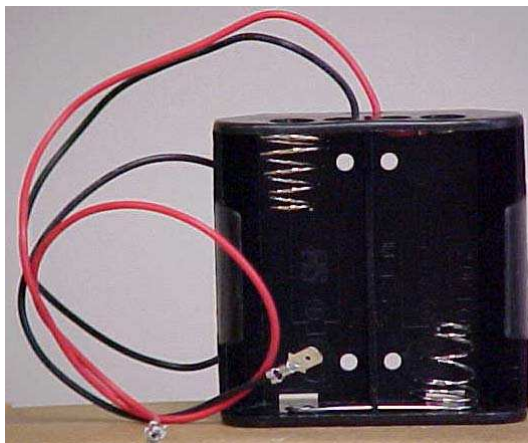

593-594A

## Wire Harness



593-590A

## INTELLIFIRE Component Parts (Continued)

### Pilot Assemblies

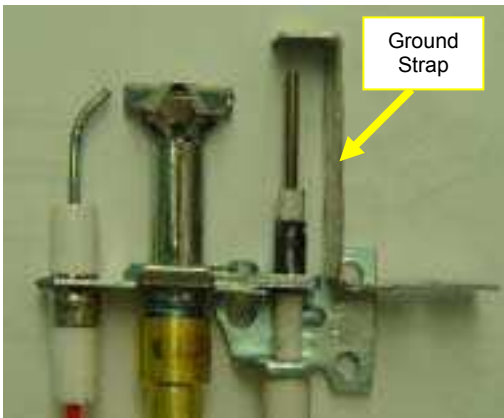

385-510A NG (11A LP)  
*(Shown w/o mounting bracket)*



593-510A NG (11A LP)  
*(Old Style, no longer used)*

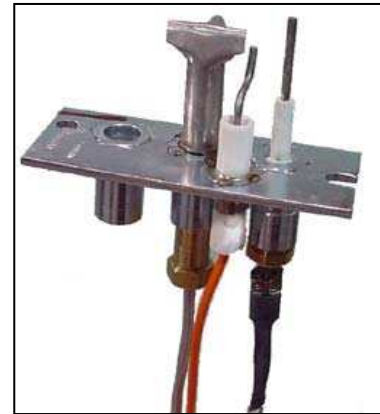

4021-025 NG (26) LP  
*Current Style (shown w/o Ground Strap)*

### Main Burner Solenoids/Regulators

fire-parts.com



NGK-DXF (ng) or LPK-DXF (lp)

FIXED NON-ADJUSTABLE SOLENOID

NGK-DXV (ng) or LPK-DXV (lp)

ADJUSTABLE REGULATOR SOLENOID

## Intermittent Pilot Basics

**A reliable multimeter is required to properly troubleshoot this system.**

When troubleshooting an Intellifire system, it is important to distinguish it from a standing pilot system. A standing pilot system is a thermal system; heat is used to generate Millivolts within the thermocouple and thermopile to open and close the gas valve. However, the Intellifire system is not a thermal system. The Intellifire system should be treated as an electrical circuit. When the fireplace is turned "ON", the pilot lights, and a rectified current passes through the pilot burner flame to the sensor rod, and then the module will engage the main burner. A glowing red sensor rod does not indicate that the system is working properly. Always verify that the sensor wire is not shorted to ground (fireplace chassis or pilot bracket) and is continuous from the sensor terminal on the module to the sensor rod by means of a multimeter set on ohms.

The intellifire system operates on an external power source:

- 120 VAC hard wired to the junction box where the 120VAC is stepped down to 3VAC via 3 volt transformer which delivers 3 volts AC to the Module. The 3VAC is converted by the module to DC power. **120 VAC is not to be connected to the module, valve, or ignition system at any time.**

OR

- Two "D" 1.5 Volt batteries

*When both the batteries and the transformer are installed, the Intellifire system will use the battery power before the 3VAC transformer unless a Cabin-Kit is installed.*

Other operational features:

- The Pilot will spark for 60 seconds. If flame rectification has not occurred within the 60 seconds, the system will lock out. To reset, **wait 5 minutes for gas to dissipate**, and then turn the main switch "Off", and then back "On".
- The main burner should never engage when the pilot is sparking.
- When the fireplace is turned off, both the pilot light and the main burner will shut down. *\*Note: If Cabin Kit or DBK Kit is installed the pilot will remain lit.*

**Flame Rectification:** Flame is a conductor of electricity and will preferentially carry an electric current from the sensor rod through the flame to ground in only one direction.

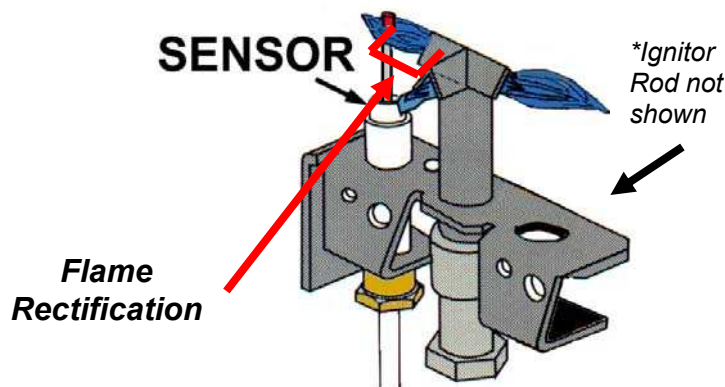

## Problem: The Ignitor/Module makes Noise, but No Spark

The problem may be:

1. Wiring
2. Loose connection
3. Ignitor Gap
4. Module

### Solution #1

Verify that the “S” wire (white) for the sensor and the “I” wire (orange) wire for the ignitor are connected to the correct terminals on the module and on the pilot assembly. If these wires were reversed at the module it may cause the system to make the noise of sparking but the spark may not be present at the pilot hood.

### Solution #2

Verify no loose connections or electrical shorts in the wiring from the module to the pilot assembly. The rod closest to the pilot hood should be the ignitor. Verify the connections underneath the pilot assembly are tight; also verify these connections are not grounding out to the metal chassis, pilot burner, pilot enclosure, mesh screen if present, or any other metal object. See *Continuity test on page 11*

### Solution #3

Verify gap of the igniter to the pilot hood. The gap should be approximately .17 or 1/8”.

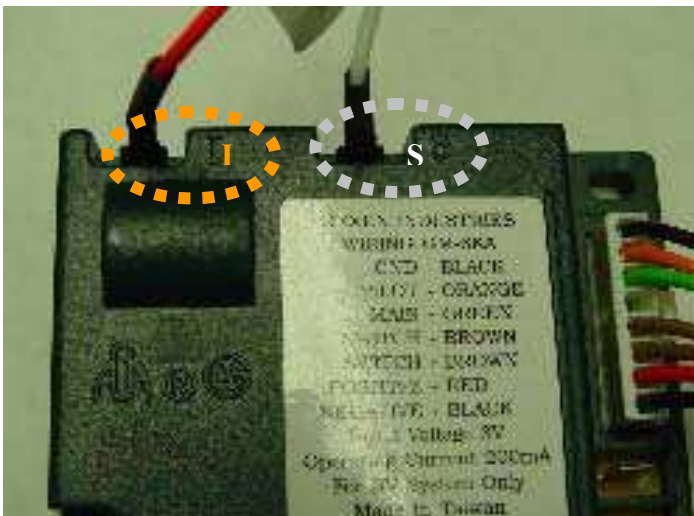

Solution #1

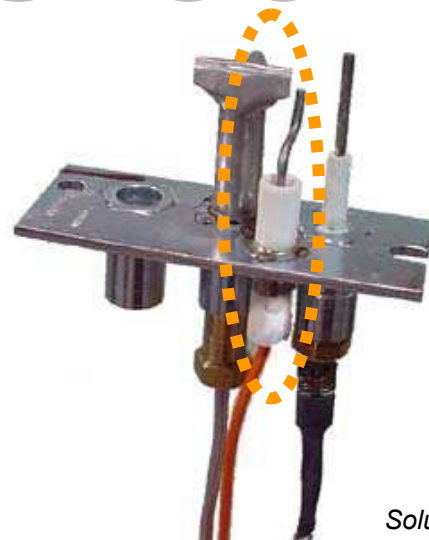

Solutions #2 & 3

### Solution #4 Verify Spark -- Module Spark Test

Turn the On/Off rocker switch or wall switch to the “Off” position. Remove the ignitor wire “I” from the module. Place the ON/OFF Rocker switch or wall switch in the “On” position. Hold a ground wire about “3/16” away from the “I” terminal on the module. If there is no spark at the “I” terminal the module must be replaced. If there is a spark at the “I” terminal, the module is fine. Next, inspect the pilot assembly for a shorted sparker wire or cracked insulator around the electrode. See *Continuity Test on Page 11*



## Problem: Pilot won't Light, No Noise or Spark

The problem may be:

1. Transformer
2. A shorted or loose connection in the wiring configuration or wiring harness
3. Improper wall switch wiring.
4. Module is not grounded
5. Faulty module

### Solution #1

Verify that the transformer is installed and plugged into the module. Check voltage of transformer under load at the spade connection on the module with the ON/OFF switch in the "ON" position. Acceptable readings of a good transformer are between 3.2 and 2.8 volts AC.



Red Lead from  
Multimeter

Black Lead from  
Multimeter

Solution #1

### Solution #2

Remove and reinstall the wiring harness that plugs into the module. Verify that there is a tight fit. Verify the pilot assembly wiring to the module. Remove and verify the continuity of each wire in the wiring harness. See *Continuity Test on Page 11*

### Solution #3

See *FAQs: Wall Switch on page 16*. Troubleshoot the system with the simplest On/Off switch.

### Solution #4

Verify the black ground wire from the module wire harness is grounded to the metal chassis of the fireplace.

### Solution #5

See *Solution #4 on page 8*. If no spark, replace module.

## Problem: Pilot Lights, but Continues to Spark and Main Burner will not Ignite

If the pilot continues to spark after the pilot flame has been lit, flame rectification has not occurred.

The problem may be:

1. A shorted or loose connection in the sensor rod
2. Poor flame rectification or contaminated sensor rod (see *ground strap on page 18*)
3. Module is not grounded
4. Damaged pilot assembly or dirty sensor rod
5. Module

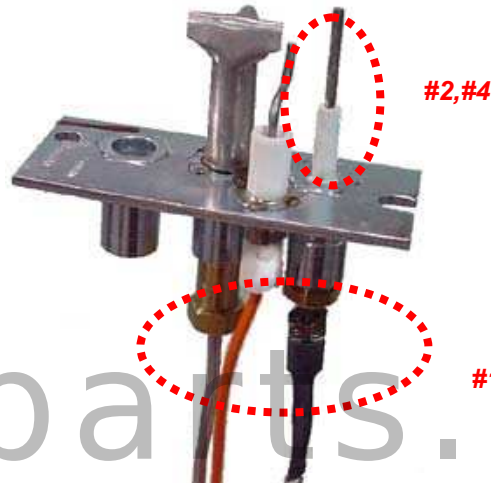

Solution #1

### Solution #1

Verify all connections to wiring diagram in manual. Verify the connections underneath the pilot assembly are tight; also verify these connections are not grounding out to the metal chassis, pilot burner, pilot enclosure or screen if present, or any other metal object.

### Solution #2

Verify that the flame is engulfing the sensor rod. If the pilot assembly does not have a ground strap, you may want to consider installing one. This will increase the flame rectification. Verify correct pilot orifice is installed and inlet gas specifications to page 10. *Remember, the flame carries the rectification current, not the gas. If the flame lifts from the pilot hood, the circuit is broken. A wrong orifice or too high of an inlet pressure can cause the pilot flame to lift.* The sensor rod may be contaminated. Clean the sensor rod with an emery cloth.

### Solution #3

Verify that that module is securely grounded to the metal chassis of the fireplace. Verify that the wire harness is firmly connected to the module.

### Solution #4

Verify that the ceramic insulator around the sensor rod is not crack, damaged, or loose. Verify the connection from the sensor rod to the white sensor wire. Clean the sensor rod with an emery cloth to remove any containment that may have accumulated on the sensor rod. Verify continuity with a multimeter with ohms set at lowest range. *See following page for instructions*

## Problem: Pilot Lights, but Continues to Spark and Main Burner will not Ignite (Continued)

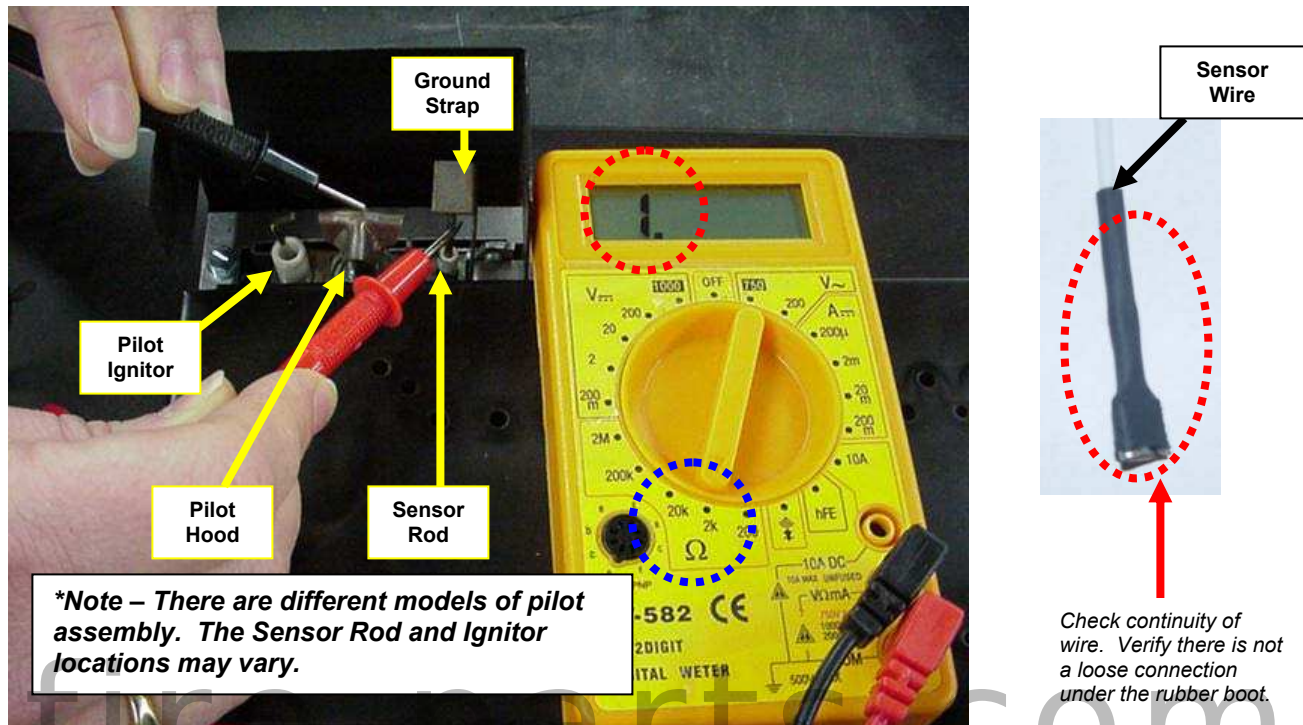

**Continuity Test:** Verify that the sensor wire (white wire) is not shorting out to the pilot bracket or another metal area of the fireplace.

1. Set Multimeter to “Ohms”
2. Place one lead on the sensor rod. Make sure sensor rod or the lead from your multimeter does not touch the ground strap or another metal part of the pilot assembly.
3. Place the other lead on the pilot hood, pilot base, or pilot bracket. Make sure this lead has a good connection to ground, paint may insulate and cause a false reading.
4. Some multimeters may have an audible “beep” to indicate continuity. The multimeter pictured above does not have an audible beep, so we read the LED display. The reading of “1.” is an infinite number, which indicates no continuity exists between the pilot hood and the sensor rod. Any other reading other than “1.” (such as .078 depending on the ohms setting) would indicate continuity. **There should not be any continuity between the sensor rod and the pilot hood, pilot base, or pilot bracket.**

If continuity is present, this would indicate that there is a short. At some point the sensor wire is shorted out to an area of the metal chassis of the fireplace. **A simple continuity test can be used to verify the integrity of a single wire or any wiring connection.** When a wire connection is insulated with a rubber boot, a continuity test is the only way to verify the connection because one can't visually see the bad connection (refer to above picture). Insulated connections are very common on the IntelliFire system; these connections need to be verified when troubleshooting.

### Solution #5

The final solution is to replace the module.

## Problem: Pilot sparks, but Pilot will not light.

The problem may be:

1. Gas supply
2. Spark gap
3. Module is not grounded
4. Module voltage output / Valve/Pilot solenoid ohms readings

### Solution #1

Verify that the incoming gas line ball valve is “open”. Verify that the inlet pressure reading is within acceptable limits, inlet pressure must not exceed 14” W.C. See Page 20

### Solution #2

Verify that the spark gap form the ignitor to the pilot hood is .17 or 1/8”.

### Solution #3

Verify module is securely grounded to the metal chassis of the fireplace.

### Solution #4

See Solution #4 on Page 14. Test the orange wire while pilot is sparking. Replace necessary component recommend in Solution #4 on Page 14



**Problem: Pilot lights, stops sparking, and pilot remains lit but burner will not turn on.**

If the pilot lights and stops sparking, but the burner doesn't engage, the problems may be:

1. Wiring/Connection
2. Wiring harness
3. Cabin-Kit installed incorrectly
4. Module or Valve/Valve regulator

**Solution #1**

Inspect all the wires; ensure good tight connections. Verify that all wiring is installed exactly as specified in the installation manual's wiring diagram. If you don't have the installation manual, refer to a generic wiring diagrams included in the back of this trouble shooting guide. Verify that the green male spade on the valve, (*see picture below*), is not bent, it should not touch the metal valve. This green connection is insulated from the valve by the green mounting plate.

**Solution #2**

Inspect the wiring harness, and verify that the harness is tightly connected to the module. Verify that you have 7 wires and they are in the correct order. *\*See Picture Figure Below*



Solution #2

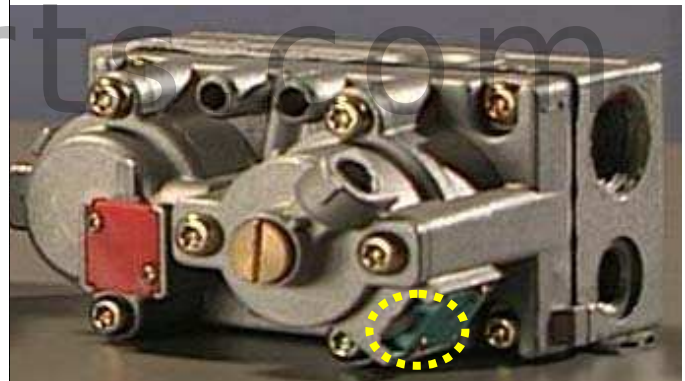

Solution #1

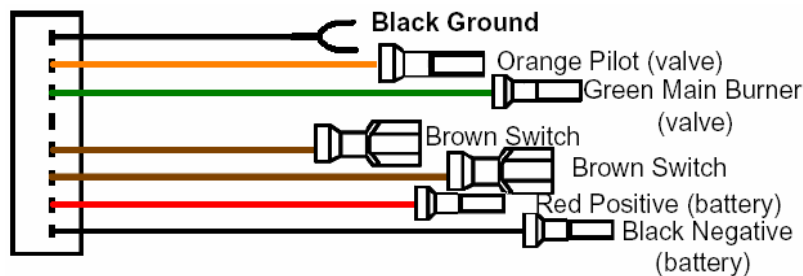

Wiring Harness

**Solution #3**

Verify installation of the Cabin-Kit; make sure the cold climate switch is wired correctly. *\*Refer to Cabin-Kit Wiring on Page 23.*

**Problem: Pilot lights and stops sparking and pilot remains lit but burner will not turn on. (Continued)**

**Solution #4**

Conduct the following test to verify if the problem is the Module or Valve/Valve solenoid:

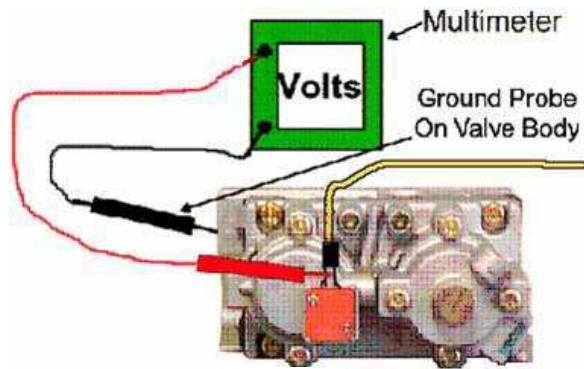
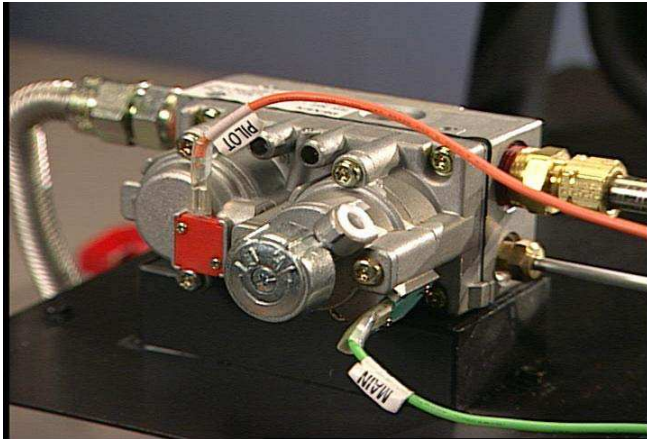

Fig. 1

To measure voltages, turn multimeter to “DC” place the red lead from the multimeter on the solenoid spade terminal you are checking, and touch the black lead to ground (valve body). See Figure 1.

Importantly, a “Zero” volts readings does not automatically indicate a bad module, there may be too little resistance in the valve solenoid. Check Green wire disconnected from the valve, the voltage output of a module should be between 2 and 3 Volts. See “Ohms Readings” below

**AC Voltage Readings**

When using the AC adapter (transformer) with the On/Off switch “On”, the orange wire that runs from the module to the pilot solenoid on the gas valve uses **0.98 volts** to open the pilot solenoid (*pilot is still sparking*). Upon proof of pilot (*flame rectification on the sensor probe on the pilot assembly, pilot is lit and is not sparking*) the orange wire voltage will drop to **0.46 volts** and the green wire from the module to the regulator solenoid is a minimum of **1.09 volts** during main burner operation.

**DC Voltage Readings (Batteries)**

*Actual voltages will vary depending upon battery voltage.* When using DC (battery pack) with the On/Off switch “On”, the orange wire from the module to the pilot solenoid on the gas valve uses **1.05 volts** to open the pilot solenoid (*pilot is still sparking*). Upon proof of pilot (*flame rectification on the sensor probe on the pilot assembly, pilot is lit and is not sparking*) the orange wire voltage drop to **0.49 volts** and the green wire from the module to the regulator solenoid is a minimum of **1.17 volts** during main burner operation.

**Ohms Readings**

With no wires attached to the valve, typical Ohms readings on a functioning valve are:

- Pilot solenoid is 37 Ohms
- Burner Solenoid is 55 Ohms

These Ohms readings will vary upon temperature

## **Problem: Burner Lights, but Burner will Cycle “Off” and “On”**

The problem may be attributed to:

1. Over-drafting or Over-firing (gas pressure too high)
2. Poor flame rectification
3. Remote, Wall switch, or Thermostat.
4. Low batteries or bad transformer
5. Cold Climate Start up

### **Solution #1**

Refer to the installation manual and verify if an exhaust restrictor is required. If the installation manual suggests a restrictor plate for a given installation, verify that the restrictor plate has been properly installed. Verify the burner orifice size to the orifice listed on the rating plate. If the fireplace is installed over 2,000 feet above Sea Level, verify that the fireplace has been de-rated accordingly. Check the manifold pressure to ensure the fireplace is at 3.5” W.C. on high for NG and 10” W.C. on high for LP. Proper manifold settings and orifice sizes are critical, the more fuel put into a fireplace means more oxygen is required for proper combustion. An over-drafting or over-firing fireplace can translate into an increase in air turbulence inside the firebox that can cause the pilot flame to blow out or pull away from the sensor rod, resulting in a cycling effect.

### **Solution #2**

Whenever the pilot is sparking, there is no flame rectification, and when there is no flame rectification, the main burner should never light. The problem could be a result of over-drafting (pulling the pilot flame off the sensor), Oxygen starvation (pilot flame shrinks) due to blockage in venting, gas supply problems, or improperly installed venting. Verify all wiring connections. Verify that the module is grounded. Verify that the sensor rod/wire is not grounding out to the pilot bracket or any piece of the metal fireplace chassis. A short in a wire may have appeared after the fireplace had been operating for a given period.

### **Solution #3**

Bypass the any optional accessories that are being used to turn the fireplace “On” and “Off”. Troubleshoot the system with the manual On/Off rocker switch. A bad wall switch, thermostat, or remote may be the root cause of the problem.

### **Solution #4**

Verify output under load of the transformer. See *Solution #1, Page 9*. If batteries are being used, verify output of the battery pack is at least 2.6 volts DC.

### **Solution #5**

The Cold Climate feature enables the pilot flame to remain lit even when the main burner flame is “Off”. In colder climates, a pilot light may lessen cold surface transfer through the glass when the fireplace is not in use. It may also reduce the amount of condensation that may appear on the glass. Additionally, a pilot light may help the main burner of the fireplace light more easily on those extra cold “Minnesota-type” winter mornings.

*\*For more a more detailed of the Cabin-Kit turn to page 17*

## FAQs: Wall Switch Installation

### Intellifire Installation

A much too frequent installation error occurs when an electrician has wired an ON/OFF switch (such as a wall switch) before the junction box of the fireplace. The theory behind this is that the ON/OFF rocker switch on the valve plate shall always remain in the "ON" position and controlling the 120 Volt supply to the junction box via the wall switch would control the burner flame. This is incorrect: an Intellifire system will not work properly with this type of wall switch wiring. It is designed to operate on a constant supply of 3 Volt AC (3 volt transformer) or 3 Volt DC (battery backup). The wall switch can then be used in conjunction with the "Wall Switch/Remote Control" leads coming off the back of the fireplaces ON/OFF rocker switch.

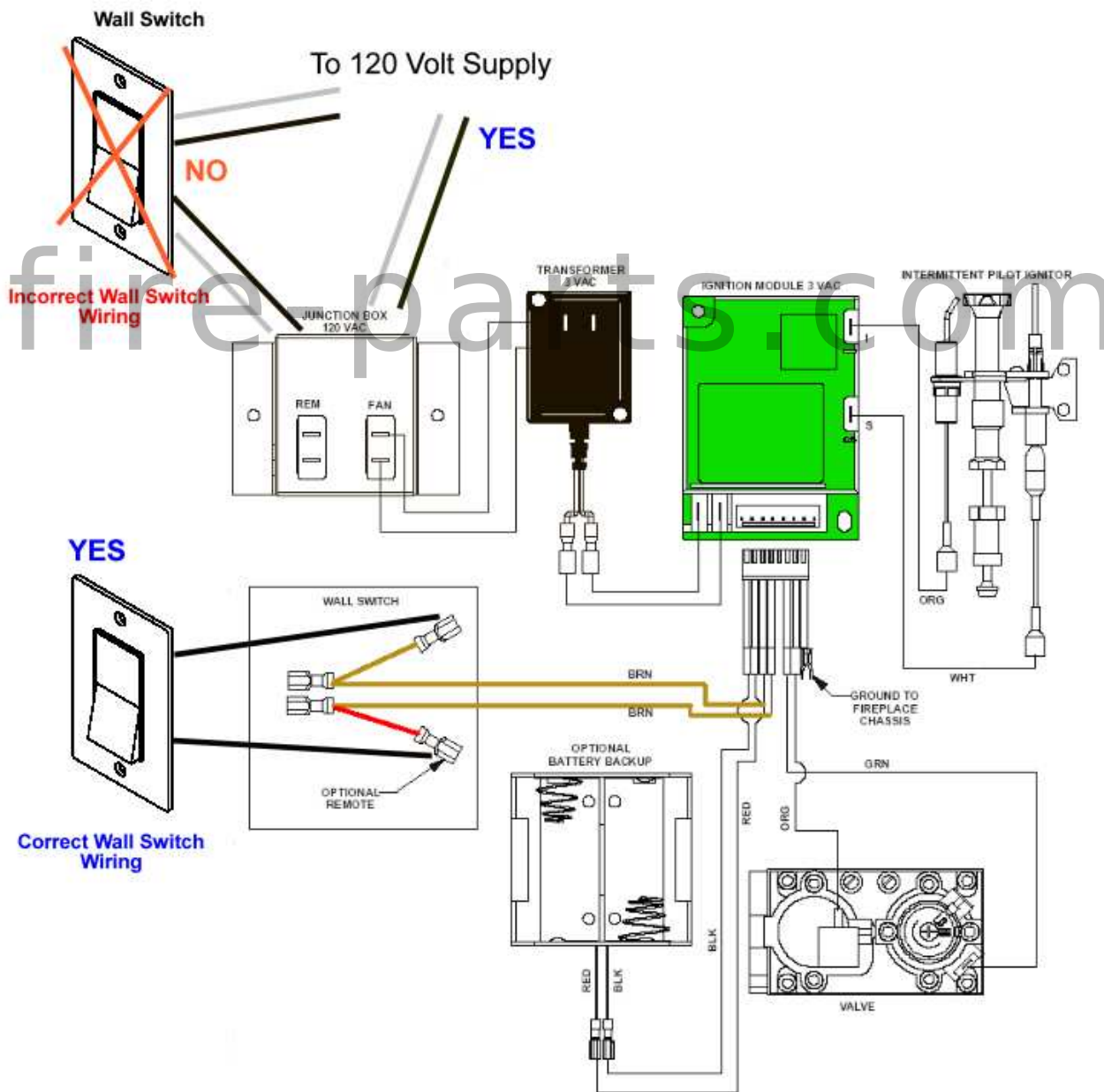



## FAQs: Cabin-Kit

### Cold Climate/Cabin-Kit

A new feature of the 6000TRXI-IPI is that it now comes standard with the Cabin-Kit. *The Cabin-Kit cannot be used in conjunction with the WSK-MLT. The WSK-MLT has some of the shared features of the Cabin-Kit.* The Cabin-Kit consists of a cold climate control switch and an automatic relay. The Cabin-Kit is also an available option for non-power draft assisted Intellifire (IPI) units.

The Cold Climate feature enables the pilot flame to remain lit even when the main burner flame is "Off". In colder climates, the pilot light may lessen cold surface transfer through the glass when the fireplace is not in use. It may also reduce the amount of condensation that may appear on the glass and may help the main burner of the fireplace light more easily on those extra cold "Minnesota-type" winter mornings.

As we all know, one of the best features of the Intellifire system is the standard battery backup which enables a homeowner to use their fireplace in the event of a power outage, with one catch: the batteries are to be installed only when a power outage occurs. This is due to the fact that when both the AC transformer and the DC battery backup are used in conjunction with each other, the Intellifire system will always use the DC voltage from the batteries first before the AC voltage from the transformer. Thus, the batteries will drain even with 120 Volts AC available.

The CABIN-KIT eliminates the need to worry about installing batteries during a power outage. It has a relay that will automatically sense a power outage (*no 120/no AC voltage from transformer*) and will automatically flip over to the DC voltage from the battery backup. With the CABIN-KIT, batteries can remain in the backup harness, without the worries of having premature battery drain.

*\*See Wiring Diagram on Page 23.*



Cold Climate Switch

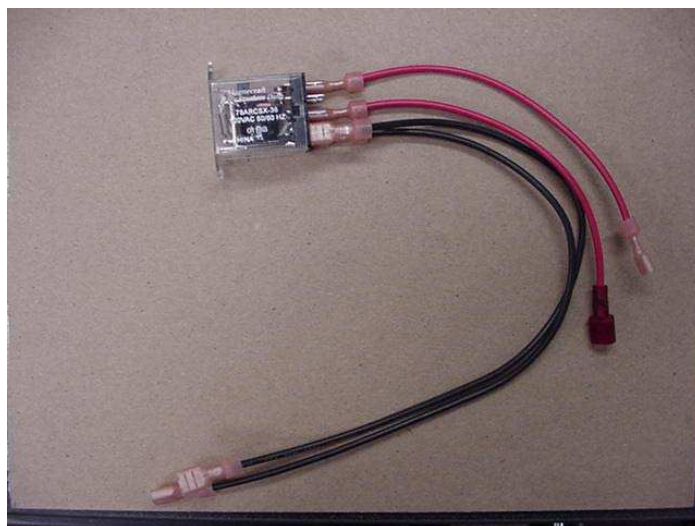

Relay Switch for Battery Pack

## FAQs: Ground Strap

### Intellifire cycling fireplace at startup

In recent reliability testing, we have found a small percentage of Intellifire systems cycling, as if the burner is being turned “on” and “off” intermittently. This is caused by occasional pilot instability during startup.

Although the occurrences of this problem are seldom, our engineers have developed a grounding strap (385-512) to greatly improve the flame rectification of the Intellifire system. In the near future, this ground strap will become a component of every Intellifire system.

If you would like more information regarding the Intellifire system or to order the ground strap (385-512), please contact Heat-N-Glo Technical Service. Model and serial number is required for all no-charge orders.

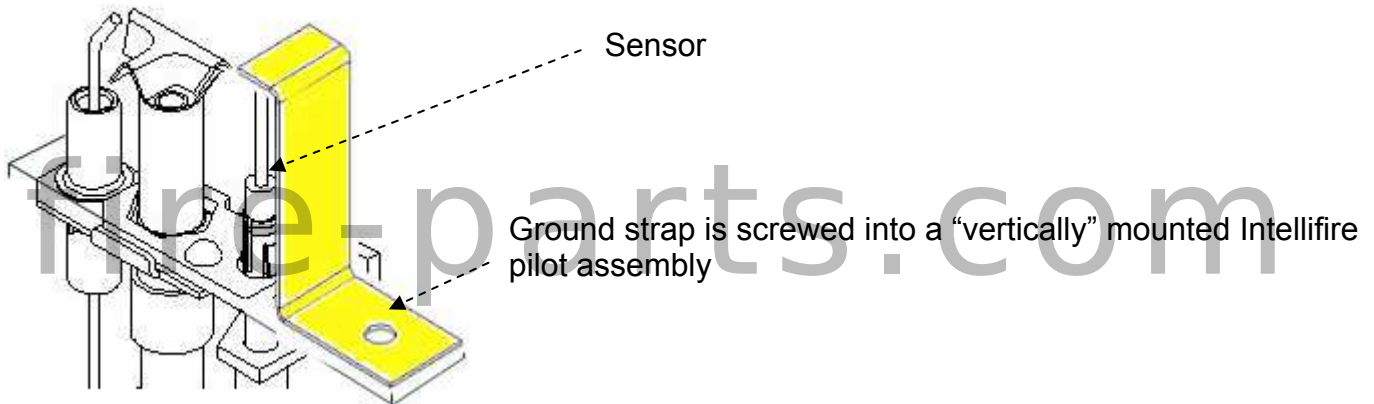

## FAQs: Gas Fuel Type Conversions

### Intellifire (IPI) Conversion Instructions

As with other gas ignition systems, such as DSI and Standing Pilot, IPI systems are field convertible provided the appropriate conversion kit is being used. Although it is possible to convert a unit without a conversion kit by simply ordering the necessary orifices, burner, regulator, or logs (if required), **only authorized Heat-N-Glo conversions kits are approved.** The conversion kit will not only ensure that all necessary correct components are being replaced to convert to another fuel type, but the kit will also include detailed instructions and conversion labels to certify the gas conversion to local building code. **To convert a fireplace without the Heat-N-Glo conversion kit will void the fireplace warranty.** Furthermore, only certified gas technicians are permitted to perform a conversion. Conversions are not to be completed by a non-gas certified homeowner or service person.

#### *Tips for converting a Fireplace*

1. Refer to the installation guide or Gas Matrix to get the correct conversion kit part number. A Serial Number is often required.
2. Use only the Heat-N-Glo conversion kit specifically designed for each fireplace. Do not combine conversion kits.
3. Read the instructions carefully, all conversions require the diaphragm or regulator gasket must be replaced.
4. Verify both inlet and manifold gas pressures; refer to conversion instructions for proper manifold pressure.
5. Upon completion of a conversion, for IPI systems verify that both the pilot burner and main burner shut off when power is removed to the module. For Standing pilot systems verify that the pilot burner and main burner shut off when the pilot knob is turned to "OFF".
6. Never use a component that is not in a conversion kit. Specifically, never use a material, i.e. RTV or silicone sealant on the regulator portion of the gas valve.
7. Upon completion of a gas conversion, verify all connections are leak-free with a soapy water solution, or a NG/LP gas detector. This should be done before and after an initial fire-up of a fireplace.

When performing a gas conversion, never install a damaged Regulator or Valve. **If a Valve or Regulator is dropped, or a technician suspect's damage or unauthorized modification to a valve component may have occurred, do not install that component.** Please contact Heat-N-Glo technical Service. Heat-N-Glo Tech we will issue an RMA (Return Merchandise Authorization) to have that Valve or Regulator returned the Heat-N-Glo for inspection. When the RMA is returned to Heat-N-Glo, the distributor's account will be credited the distributor purchase price.

## Inlet and Manifold Pressure Specifications

### INTELLIFIRE Inlet Gas Pressure Check

#### Inlet Gas Pressure Requirements

**NG** 4.5" - 7" W.C.

**LP** 11" - 14" W.C.

- Captive Slotted Screws Will Not Come Out of Towers.

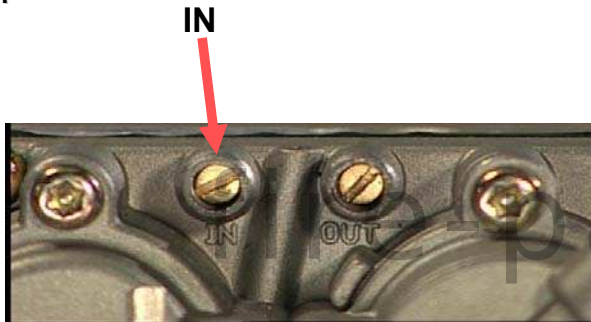

### INTELLIFIRE Manifold Gas Pressure Check

#### Manifold or Output Gas Pressure Requirements

**NG** 3.5" W.C.

**LP** 10" W.C.

- Be Sure to Tighten After Testing to Prevent Gas Leaks at Towers.

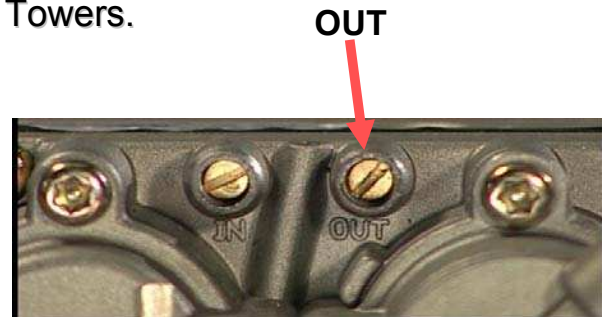

## Intellifire Conversion Components and Required Tools

### Conversion Components



### Required Tools



TR-20 Tamper Torx  
HHT # 810-225



fire-parts.com

### Conversion Kit will contain:

1. Instructions
2. Conversion Labels
3. Burner Orifice(s) – Styles may vary
4. Pilot Orifice – Styles may vary
5. Regulator/Solenoid
6. New Gasket
7. Burner, if required



Manometer or Magnehelic

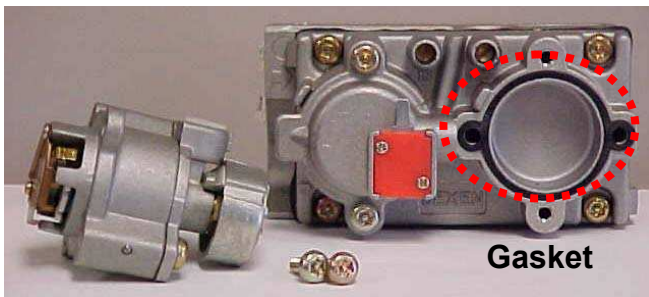

Leak Detection Fluid  
OR  
LP or NG Gas Detector

# Basic IPI Wiring Diagram

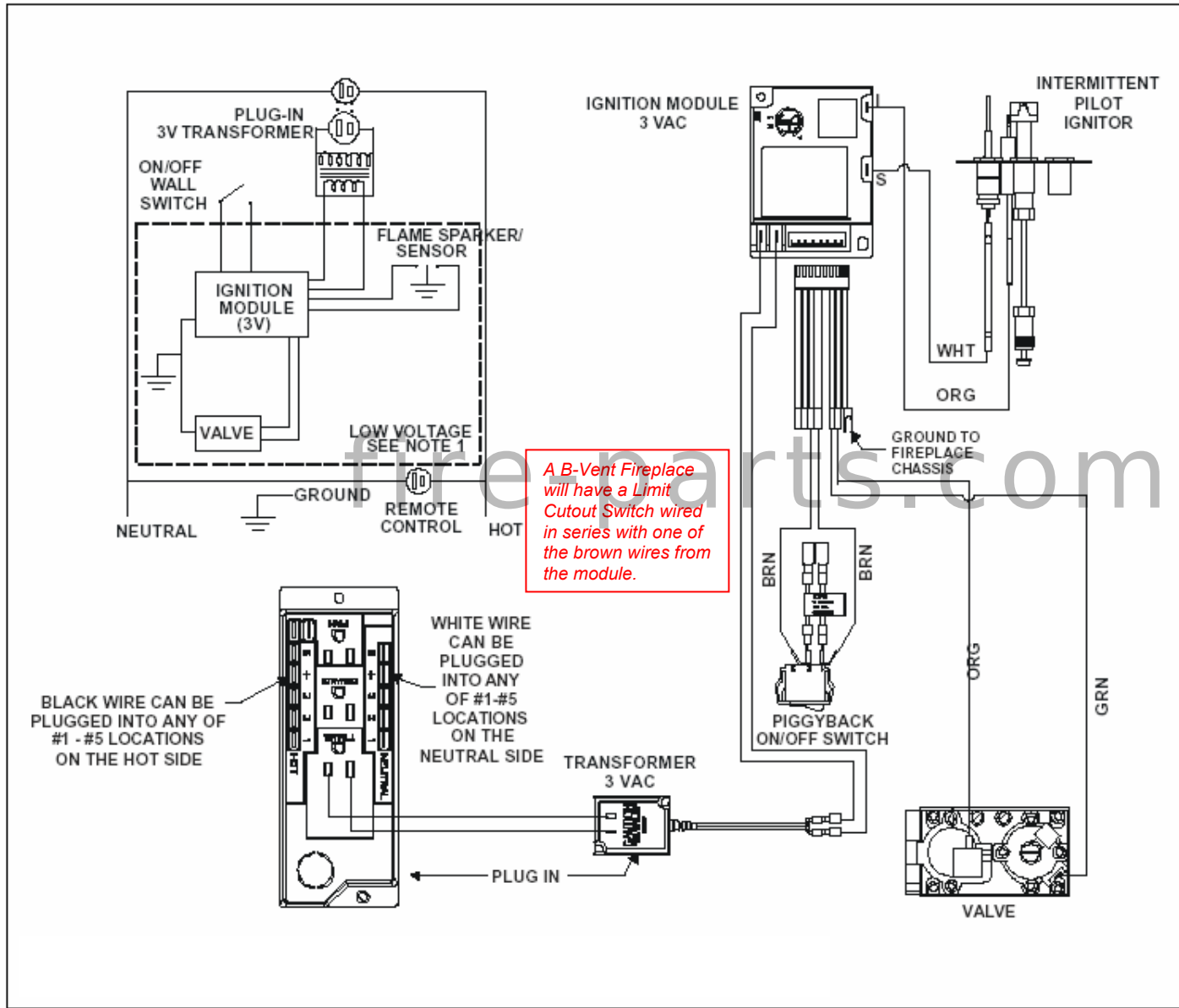

# IPI Wiring With CABIN-KIT

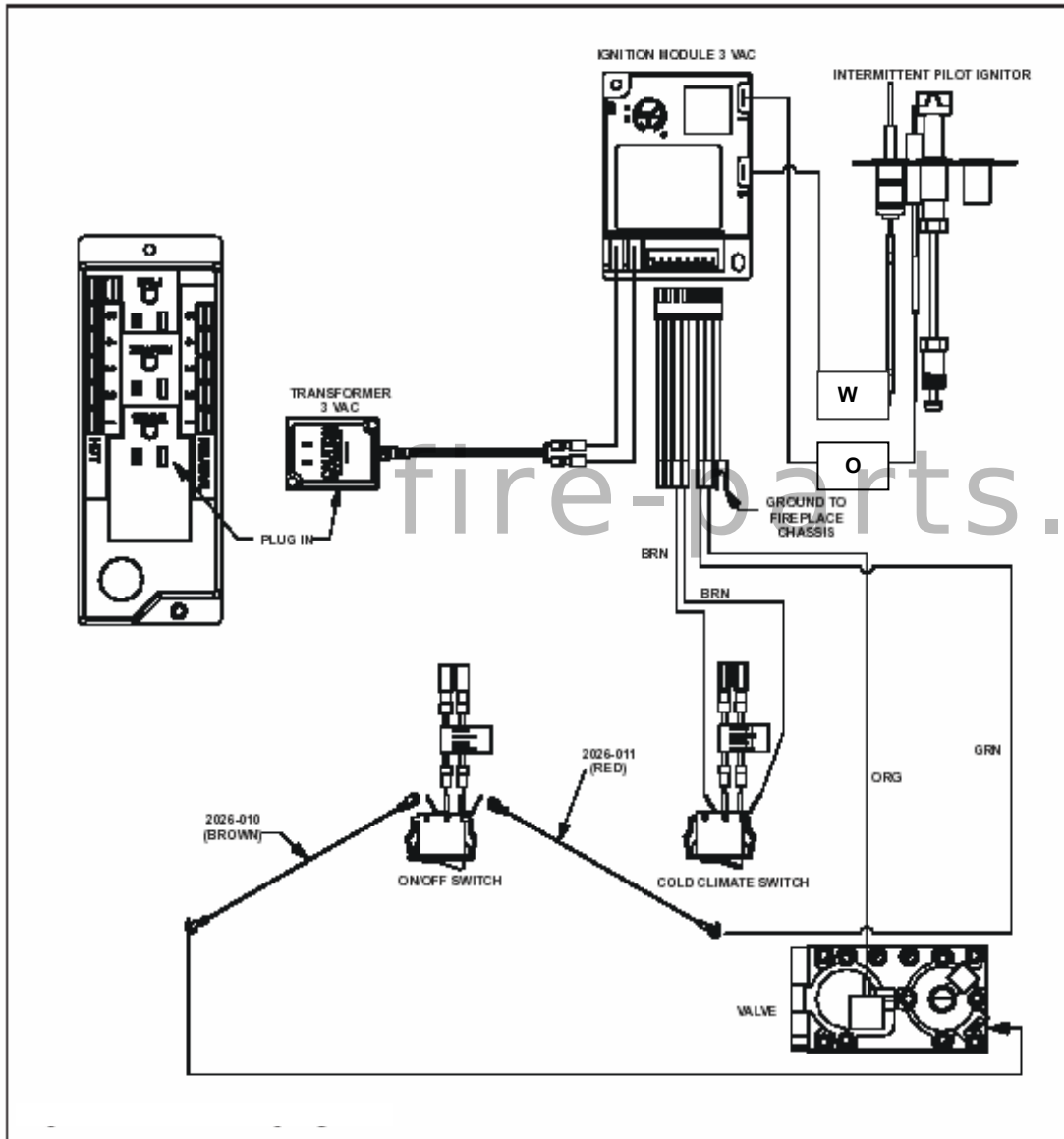

Cold Climate Switch Wiring

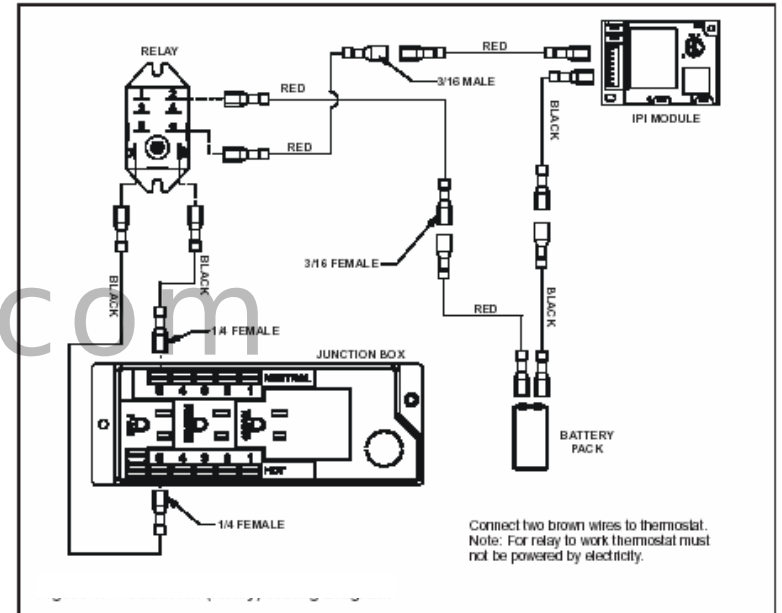

Relay Wiring

Connect two brown wires to thermostat.  
 Note: For relay to work thermostat must not be powered by electricity.

IPI Wiring with power exhaust B-Vent (NOT PVK-80)

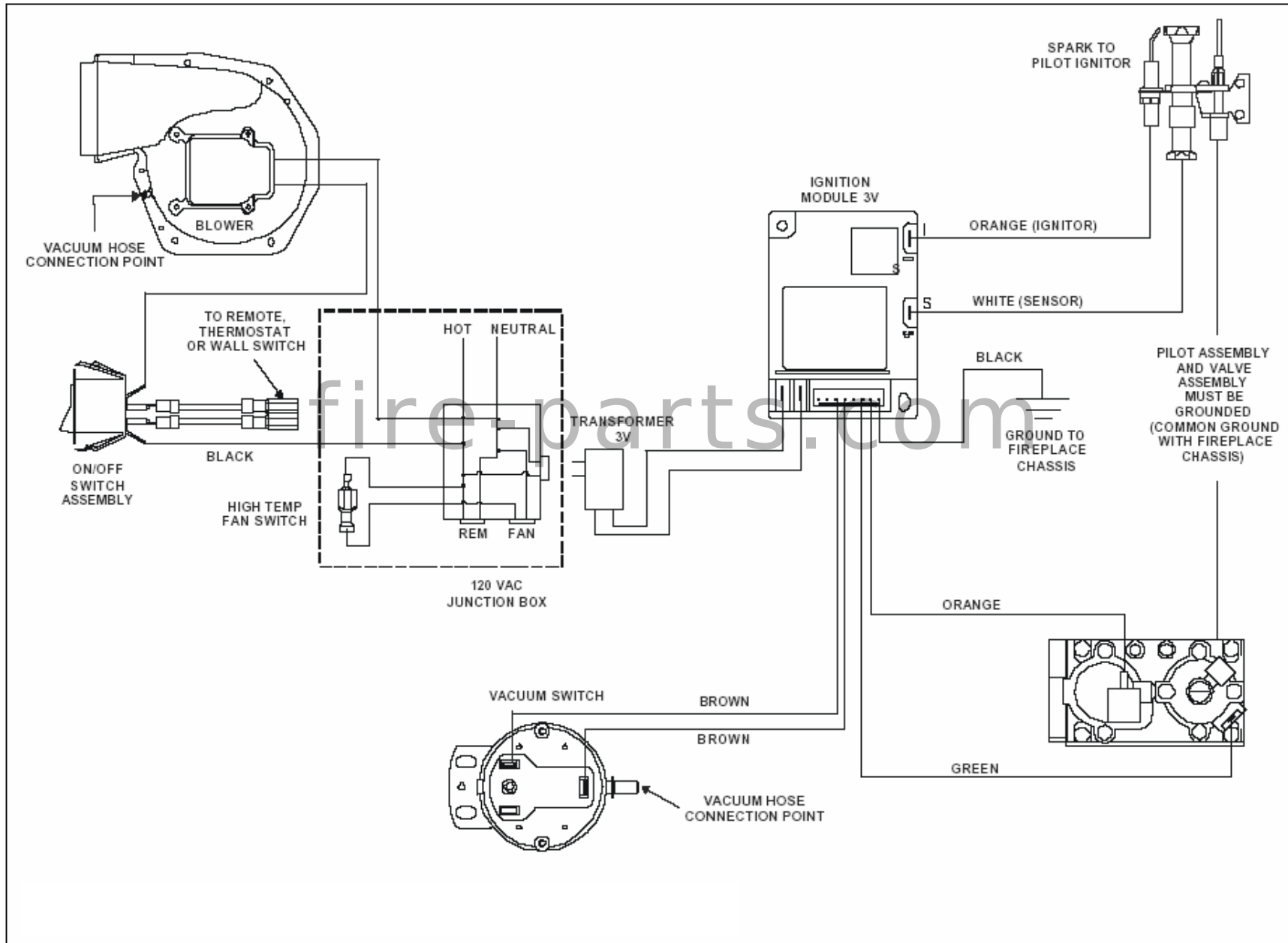



# IPI Wiring with PVK-80

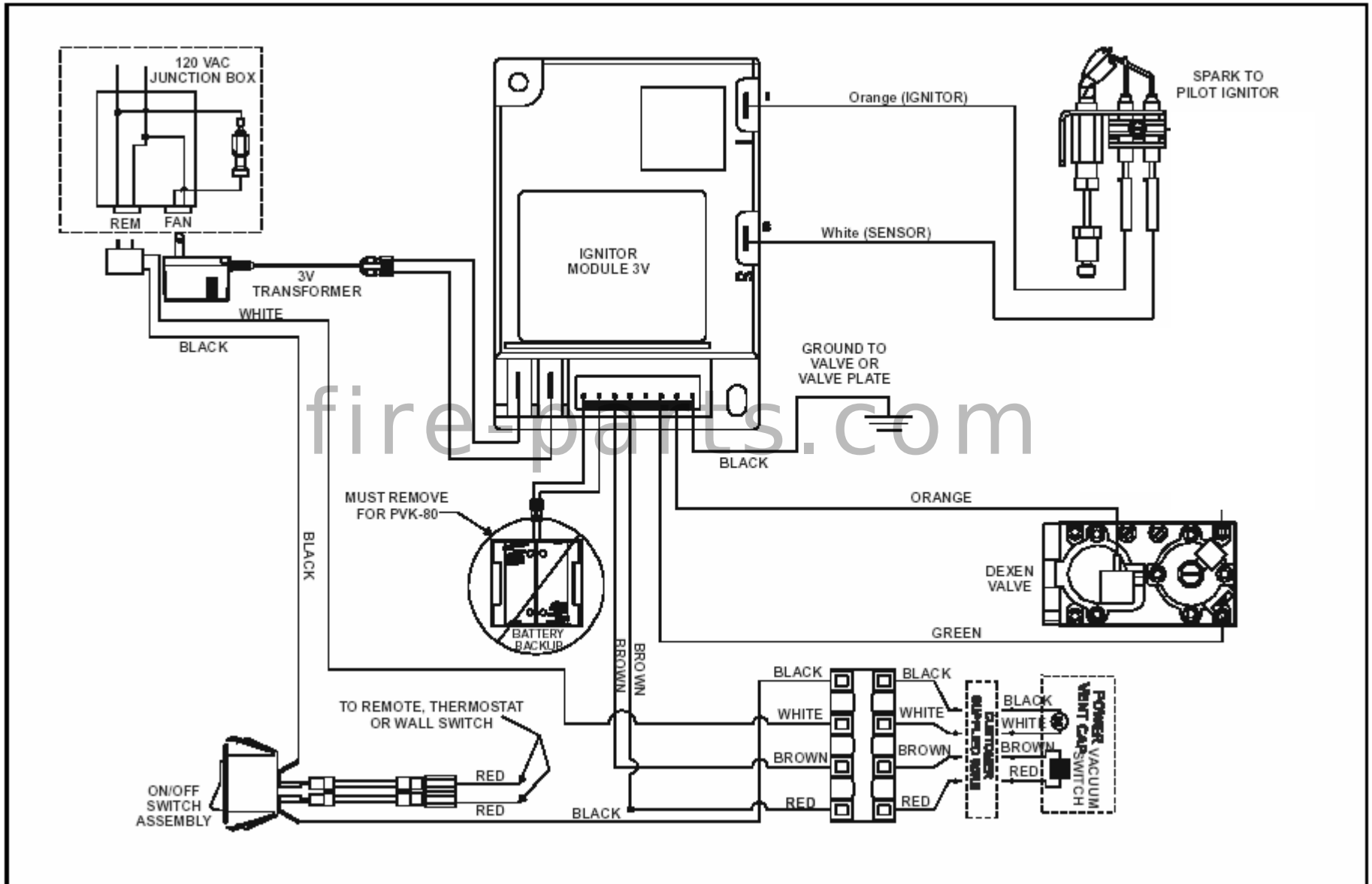

NOTES

fire-parts.com