



RCAF-3

INSTALLATION AND OPERATING INSTRUCTIONS

TWO-FUNCTION WIRELESS REMOTE CONTROL SYSTEM FOR ON/OFF-HI/LO OPERATION OF THE AF-2000 GAS CONTROL VALVE

IF YOU CANNOT READ OR UNDERSTAND THESE INSTALLATION INSTRUCTIONS DO NOT ATTEMPT TO INSTALL OR OPERATE

INTRODUCTION

This remote control system was developed to provide a safe, reliable, and user-friendly remote control system for use with the AF-2000 gas control valve used with some gas heating appliances. The system operates on radio frequencies (RF) within a 20' range using non-directional signals. The system operates on one of 255 security codes that are programmed into the transmitter at the factory; the remote receiver must learn the transmitter code prior to initial use.

Review THERMO SAFETY SECTION under RECEIVER section. This high temperature safety feature shuts down the appliance when a potentially unsafe condition exists.

TRANSMITTER

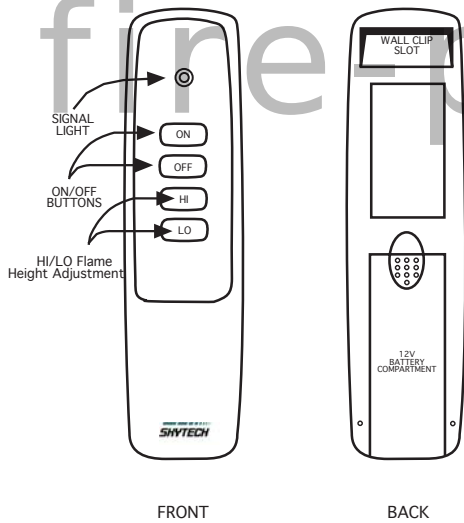

This remote control SYSTEM offers the user a battery-operated remote control to power a ON/OFF internal solenoid within the AF-2000 and a flame HI/LO solenoid or flame HI/LO DC motor drive within AF-2000 gas control valve such as those used with some decorative gas logs, gas fireplaces and other gas heating appliances.

Battery power from the receiver to operate the AF-2000 gas control valve. The circuit uses a pulse of 3 volts DC battery power to operate an internal solenoid (ON/OFF) or open/close and 3 volts DC battery power to operate a flame HI/LO solenoid or flame HI/LO DC motor drive. The SYSTEM is controlled by a battery operated remote transmitter.

The transmitter operates with a 12V battery (Included) made specifically for remote controls and electronic lighters. Before using the transmitter, install the 12 volt (A-23) battery in the battery compartment.

It is recommended that ALKALINE batteries always be used for longer battery life and maximum operational performance.

The transmitter has ON/OFF and HI/LO functions that are activated by pressing the button on the face of the transmitter. When a button on the transmitter is pressed, a signal light on the transmitter illuminates to verify that a signal is being sent. Upon initial use, there may be a delay of three seconds before the remote receiver will respond to the transmitter. This is part of the system's design. If the signal light does not illuminate, check the position of the transmitter's battery.

REMOTE RECEIVER

IMPORTANT

THE REMOTE RECEIVER SHOULD BE POSITIONED WHERE AMBIENT TEMPERATURES DO NOT EXCEED 130° F.

The remote receiver (right) operates on four 1.5V AA-size batteries. It is recommended that ALKALINE batteries be used for longer battery life and maximum microprocessor performance. IMPORTANT: New or fully charged batteries are essential to proper operation of the remote receiver..

NOTE: New batteries will provide a complete season of trouble free operation.

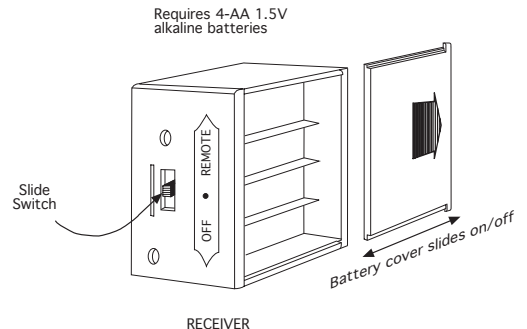

NOTE: The remote receiver will only respond to the transmitter when the 2-position slide button on the remote receiver is in the REMOTE position. The remote receiver houses the microprocessor that responds to commands from the transmitter to control system operation.

POWER SETTING – HI/LO FEATURE

The HI/LO flame control electronics in the remote control receiver has the capability of "powering" two different types of DC-powered components. If any operational problems are noted, contact Skytech Systems, Inc.

The RECEIVER HI/LO feature comes from the factory programmed to provide pulse DC voltage (3.0 VDC) to a 3 volt latching solenoid. When this RCAF-3 is used with a HI/LO DC motor drive the receiver must be changed from (HI/LO Pulse Power) to (HI/LO Continuous Power).

1. Set the receiver in the REMOTE position using the OFF/REMOTE switch on the front of the receiver.
2. Press and hold the learn button on the receiver there will be a beep when the button is first pressed the after holding the learn button down for 10 seconds there will be another beep this will signal that the power setting has been changed.

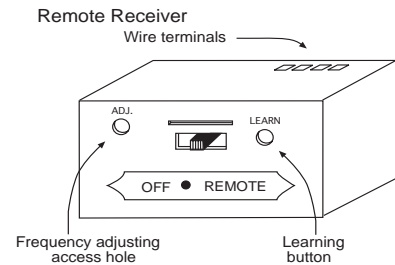

FUNCTIONS:

1. With the slide switch in the REMOTE position, the system will only operate if the remote receiver receives commands from the transmitter. Upon initial use or after an extended period of no use, the ON button may have to be pressed for up to three seconds. If the system does not respond to the transmitter on initial use, see **Matching Security Codes**.
2. With the slide in the OFF position, the system is off.
3. It is suggested that the slide switch be placed in the OFF position if you will be away from your home for an extended period of time. Placing the slide switch in the OFF position also functions as a safety "lock out" by both turning the system OFF and rendering the transmitter inoperative.

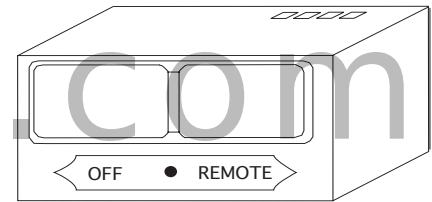

INSTALLATION INSTRUCTIONS

WARNING

DO NOT CONNECT REMOTE RECEIVER DIRECTLY TO 110-120VAC POWER. THIS WILL BURN OUT THE RECEIVER. FOLLOW INSTRUCTIONS FROM MANUFACTURER OF GAS VALVE FOR CORRECT WIRING PROCEDURES. IMPROPER INSTALLATION OF ELECTRIC COMPONENTS CAN CAUSE DAMAGE TO GAS VALVE AND REMOTE RECEIVER.

INSTALLATION

The remote receiver can be mounted on or near the fireplace hearth. PROTECTION FROM EXTREME HEAT IS VERY IMPORTANT. Like any piece of electronic equipment, the remote receiver should be kept away from temperatures exceeding 130° F inside the receiver case. Battery life is also significantly shortened if batteries are exposed to high temperatures.

WIRING INSTRUCTIONS

Install 4 AA-size 1.5 ALKALINE batteries in the RCAF-3. For best performance, batteries should be factory fresh when installed. Very little battery power is required to operate the AF-2000 gas control valve ON/OFF. Four new AA ALKALINE batteries should provide an output voltage of 6.0 to 6.2 volts. Be sure batteries are installed with the (+) and (-) ends facing the correct direction.

HEARTH INSTALLATION

The RCAF-3 is to be mounted on or near the fireplace hearth. PROTECTION FROM EXTREME HEAT IS VERY IMPORTANT. Like any piece of electronic equipment, the RCAF-3 remote receiver should be kept away from temperatures exceeding 130° F inside the switch case. Battery life is significantly shortened if batteries are exposed to high temperatures.

1. Connect the remote receiver by pushing in the (2) pin white plastic connector supplied on the end of the (Black) wires into the (2) pin connector on the AF-2000 gas control valve as shown in the figure to the right.
2. After connection to the AF-2000 gas control valve. Run the (2) (Black) wires to the location where the remote receiver will be located.
3. Connect the 1/4" female terminals to the 1/4" male terminals from the AF-2000 HI/LO Solenoid or the HI/LO DC motor drive (Match red to red and black to black). Run the (2) wires to the location where the remote receiver will be located.
4. Connect the (4) wires to the hearth switch as shown in the figure to the right.
5. Follow the Power setting instructions to change form (Pulse power) to (Continuous power)

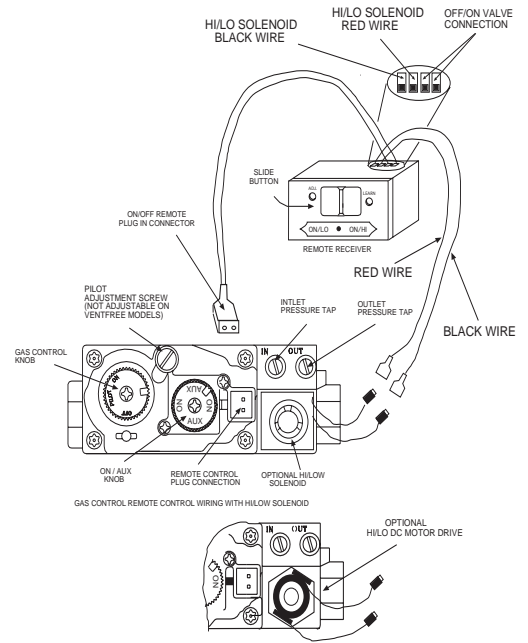

NOTE: When the remote receiver is hearth mounted a RS-1 shield is recommended.

THERMO-SAFETY FEATURE - RECEIVER (T/S - RX)

When the ambient temperature at the THERMISTOR, inside the receiver case reaches 130°F, the THERMISTOR will automatically send 2 pulses of power to the off terminal on the valve to shut the appliance system off and the RECEIVER will begin emitting a series of 2 "beeps" every 4 seconds. When the ambient temperature, at the RECEIVER drops between 120° F and 130° F, the user can reactivate the appliance by pushing either button on the transmitter. When any transmitter button is pressed, the THERMISTOR "resets" itself and the appliance will begin operating again. However, the "beeping" will continue, if the ambient temperature remains between 120° F and 130° F. This "beeping" alerts the user that the RECEIVER should be repositioned so the ambient temperature drops below 120° F.

When the temperature drops below 120° F, the "beeping" will cease, providing the user has "reset" the THERMISTOR by pushing either transmitter button to operate the appliance. Allow sufficient time for receiver to cool below 120° F, and then press transmitter button to stop beeping.

GENERAL INFORMATION

MATCHING SECURITY CODES

Each transmitter can use one of 255 unique security codes. It may be necessary to program (LEARN FUNCTION) the remote receiver to accept the transmitter security code upon initial use, if batteries are replaced, or if a replacement transmitter is purchased from your dealer or the factory. In order for the receiver to accept the transmitter security code, be sure the slide button on the receiver is in the REMOTE position; the receiver will NOT "LEARN" if the slide switch is in the OFF position. Press and release the LEARN button on the remote receiver to accept the transmitter security code and then pressing any button on the transmitter. A change in the beeping pattern, at the receiver, indicates the transmitter's code has been accepted into the receiver. When an existing receiver has accepted the new transmitter code, the new security code will replace the old one.

The microprocessor that controls the security code matching procedure is controlled by a timing function. If you are unsuccessful in matching the security code on the first attempt, wait 1 - 2 minutes before trying again--this delay allows the microprocessor to reset its timer circuitry--and try up to two or three more times.

TRANSMITTER WALL CLIP

The transmitter can be hung on a wall using the clip provided. If the clip is installed on a solid wood wall, drill 1/8" pilot holes and install with the screws provided. If it is installed on a plaster/wallboard wall, first drill two 1/4" holes into the wall. Then use a hammer to tap in the two plastic wall anchors flush with the wall; then install the screws provided.

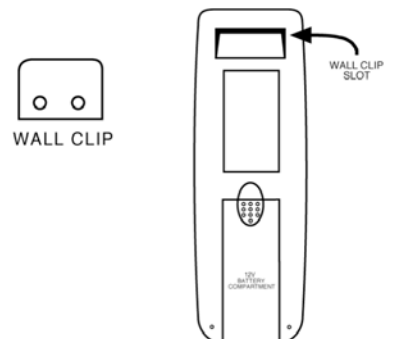

OPERATION

1. This remote control will operate the AF-2000 gas control valves ON/OFF and flame height HI/LO of the main burner.
2. When the ON button is depressed the transmitter sends a RF signal to the receiver. The receiver then sends a pulse of 3 volts of power to the internal solenoid. The internal solenoid then opens the gas flow to the main burner ON at HI flame.

PULSE POWER

3. When the LO button is depressed the transmitter sends a RF signal to the receiver. The receiver then sends a pulse of 3 volts of power to the HI/LO solenoid. The HI/LO solenoid then reduces the gas flow to the burner (LO flame).
4. When the HI button is depressed the transmitter sends a RF signal to the receiver. The receiver then sends a pulse of 3 volts of power to the HI/LO solenoid. The HI/LO solenoid then increases the gas flow to the burner (HI flame).

CONTINUOUS POWER

5. When the LO button is depressed the transmitter sends a RF signal to the receiver. The receiver then sends a continuous 3 volts of power to the HI/LO DC motor drive. The HI/LO DC motor drive then reduces the gas flow to the burner.
6. When the HI button is depressed the transmitter sends a RF signal to the receiver. The receiver then sends a continuous 3 volts of power to the HI/LO DC motor drive. The HI/LO DC motor drive then increases the gas flow to the burner.
7. When the OFF button is depressed the transmitter sends a RF signal to the receiver. The receiver then sends a pulse of 3 volts of power to the internal solenoid. The internal solenoid then closes the gas flow to the main burner OFF.
8. The remote control will only work with the hand held transmitter. The receiver slide switch is only for positive OFF or REMOTE operation.

NOTE: The RCAF-2 system will always default to HI flame after the system has been shut down. When the system is turned back ON the flame will come on at HI flame.

BATTERY LIFE

Life expectancy of the alkaline batteries in the RCAF-3 can be up to 12 months depending on use of the solenoid function. Check and replace all batteries annually. When the transmitter no longer operates the remote receiver from a distance (i.e., the transmitter's range has decreased) or the remote receiver does not function at all, the batteries should be checked. It is important that the remote receiver batteries are fully charged, providing combined output voltage of at least 5.0 volts. The transmitter should operate with as little as 9.0 volts battery power.

TROUBLE SHOOTING

If you encounter problems with your fireplace system, the problem may be with the appliance itself or it could be with the RCAF-3 remote system. Review the appliance manufacturer's operation manual to make sure all connections are properly made. Then check the operation of the remote in the following manner:

1. Make sure the batteries are correctly installed in the RCAF-3. One reversed battery will keep RCAF-2 from operating properly.
2. Check the (2) pin connector at the AF-2000 gas control valve that it is making good connection.
3. Check the ON / AUX knob on the AF-2000 to make sure that it is in the (AUX) position and not in (ON) position.
4. Check the 1/4" terminals on the HI/LO solenoid or DC motor drive for proper connection.
5. If the RCAF-3 is hearth mounted keep Hearth switch from temperatures exceeding 120° F. Battery life is shortened when ambient temperatures are above 120° F.

NOTE:

1. A receiver located in an area, where the ambient temperature inside the case exceeds 130° F, will cause the THERMO-SAFETY feature to cut in, requiring you to reposition the receiver to stop the warning beeps, and to "reset" the receiver's operation.
2. Due to handling and shipping of the unit, handling or dropping of the transmitter by the customer, and/or heat conditions at the receiver, some receivers may need an occasional frequency adjustment. This adjustment is made to improve the communication and operating distance between the transmitter and the receiver. Follow the steps below for making the adjustment.

FREQUENCY (DISTANCE) ADJUSTMENT PROCEDURE

RECEIVER ADJUSTMENT

1. To adjust at the receiver, use a small slotted screwdriver. Turn the adjustment (ADJ) screw counter-clockwise about 5° or maximum of 1/8 turn. This should correct the distance problem.
2. If that does not correct the problem, return adjustment screw to original position and then turn adjustment screw clockwise.

This adjustment is like tuning your radio. If you keep turning the adjustment screw, in either direction, you will go past the proper setting (tuning).

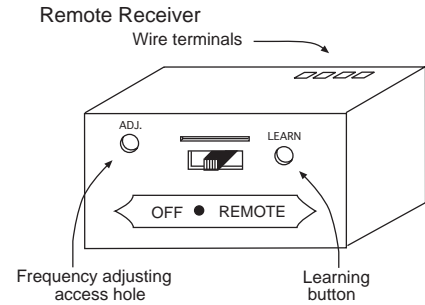

SPECIFICATIONS

BATTERIES: Transmitter 12V - (A23)

Remote Receiver 6V - 4 ea. AA 1.5 Alkaline

FCC ID No.'s: transmitter - K9L1002TX; receiver - K9L300IRX

Operating Frequency: 303.8 MHZ

Canadian ISC ID No.'s: transmitter - 2439 102 728; receiver - 2439 102 728A

FCC REQUIREMENTS

NOTE: THE MANUFACTURER IS NOT RESPONSIBLE FOR ANY RADIO OR TV INTERFERENCE CAUSED BY UNAUTHORIZED MODIFICATIONS TO THIS EQUIPMENT. SUCH MODIFICATIONS COULD VOID THE USER'S AUTHORITY TO OPERATE THE EQUIPMENT.

WARRANTY

All warranty information is listed on the warranty sheet packed with this product. If you did not receive this warranty sheet, please contact Skytech Systems, Inc. at the following:

9230 Conservation Way, Fort Wayne, IN 46809
(888) 672-8929 or (260) 459-1703

FOR TECHNICAL SERVICE, CALL:

U. S. INQUIRIES

888/672-8929 or
260/459-1703

WEBSITE: skytechsystem.com

CANADIAN INQUIRIES

877/472-3923

MANUFACTURED EXCLUSIVELY FOR SKYTECH II, INC.