



Contract #: MA065

STATE OF UTAH COOPERATIVE CONTRACT

1. CONTRACTING PARTIES: This contract is between the Utah Division of Purchasing and the following Contractor:

United Parcel Service

Name

55 Glenlake Pkwy, NE

Street Address

Atlanta

GA

30328

City

State

Zip

Vendor # VC0000121163 Commodity Code #: 91559, 96225 Legal Status of Contractor: For-Profit Corporation

Contact Name: Joseph Miller Phone Number: +1 240-818-9251 Email: josephmiller@ups.com

2. CONTRACT PORTFOLIO NAME: Small Package Delivery Services.
3. GENERAL PURPOSE OF CONTRACT: Freight and Moving.
4. PROCUREMENT: This contract is entered into as a result of the procurement process on 2022, Solicitation# CH21-36
5. CONTRACT PERIOD: Effective Date: Upon all parties' signature. Termination Date: Friday, November 27, 2026 unless terminated early or extended in accordance with the terms and conditions of this contract.
6. NASPO Valuepoint Administrative Fee (if any): One Quarter of One Percent (or 0.25%).
7. Prompt Payment Discount Details (if any): n/a.
8. ATTACHMENT A: Standard Terms and Conditions for Services
 ATTACHMENT B: Scope of Work
 ATTACHMENT C: UPS Rates
 ATTACHMENT D: Service Guide
 ATTACHMENT E: NASPO Value Point Solicitation Document
 ATTACHMENT F: UPS Response to Solicitation
- Any conflicts between Attachment A and the other Attachments will be resolved in favor of Attachment A.**
9. DOCUMENTS INCORPORATED INTO THIS CONTRACT BY REFERENCE BUT NOT ATTACHED:
- All other governmental laws, regulations, or actions applicable to the goods and/or services authorized by this contract.
 - Utah Procurement Code, Procurement Rules, and Contractor's response to solicitation #CH21-36.
10. Each person signing this Agreement represents and warrants that he/she is duly authorized and has legal capacity to execute and deliver this Agreement and bind the parties hereto. Each signatory represents and warrants to the other that the execution and delivery of the Agreement and the performance of each party's obligations hereunder have been duly authorized and that the Agreement is a valid and legal agreement binding on the parties and enforceable in accordance with its terms.

IN WITNESS WHEREOF, the parties sign and cause this contract to be executed. Notwithstanding verbal or other representations by the parties, the "Effective Date" of this Contract shall be the date provided within Section 5 above.

CONTRACTOR

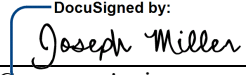
DocuSigned by:

 12/20/2021 | 9:25 AM EST
 Contractor's signature Date

Joseph Miller

Type or Print Name and Title

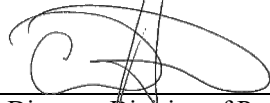
DIVISION OF PURCHASING

 12/21/2021
 Director, Division of Purchasing Date



ATTACHMENT A

NASPO VALUEPOINT MASTER AGREEMENT TERMS AND CONDITIONS

(Terms negotiated and agreed to by both parties: 1.1, 1.2, 1.8, 1.9, 1.10, 1.12, 1.13, 2.2, 2.3, III, 4.2, 4.3, 4.6, 4.7, 4.8, 5.2.1, 5.2.2, 5.3.2, 5.3.3, 5.4.4, 5.4.5, 5.5, 6.1, 6.1.1, 6.1.2, 7.3, 7.5.1, 7.5.5, 7.6.7, VIII, 9.3.1, 9.3.2, 9.4, 9.5, 10.1, 10.2, 10.3, 10.5, XI, 12.2, 13.6, 13.7, 14.2.1, 14.2.1.1, 14.2.4, 14.2.6, 14.3.2, 14.4, 14.6, 14.7, 14.8.2, 14.8.3, 14.9, 14.11.1, and 14.13)

I. Definitions

- 1.1 Acceptance** means acceptance of services as set forth in Section IX of this Master Agreement.
- 1.2 Contractor** means a party to this Master Agreement, whether a person or entity, that performs services under the terms set forth in this Master Agreement.
- 1.3 Embedded Software** means one or more software applications which permanently reside on a computing device.
- 1.4 Intellectual Property** means any and all patents, copyrights, service marks, trademarks, trade secrets, trade names, patentable inventions, or other similar proprietary rights, in tangible or intangible form, and all rights, title, and interest therein.
- 1.5 Lead State** means the State centrally administering any resulting Master Agreement(s) who is a party to this Master Agreement.
- 1.6 Master Agreement** means the underlying agreement executed by and between the Lead State, acting in cooperation with NASPO ValuePoint, and the Contractor, as now or hereafter amended.
- 1.7 NASPO ValuePoint** is a division of the National Association of State Procurement Officials ("NASPO"), a 501(c)(3) limited liability company. NASPO ValuePoint facilitates administration of the NASPO cooperative group contracting consortium of state chief procurement officials for the benefit of state departments, institutions, agencies, and political subdivisions and other eligible entities (i.e., colleges, school districts, counties, cities, some nonprofit organizations, etc.) for all states, the District of Columbia, and territories of the United States. NASPO ValuePoint is identified in the Master Agreement as the recipient of reports and may perform contract administration functions relating to collecting and receiving reports, as well as other contract administration functions as assigned by the Lead State.

- 1.8 Order or Purchase Order** means any purchase order, sales order, contract or other document used by a Purchasing Entity to order the Products. Unless expressly required by statute any terms or conditions expressed or incorporated on any Order or Purchase Order other than required by the Contractor's electronic ordering systems are deemed null and void unless expressly agreed by the Contractor in this Master Agreement, a Participating Addendum, or an amendment thereto. Notwithstanding any language contained in any Purchase Order to the contrary, fulfillment of an order shall not constitute Contractor's consent to additional terms and conditions expressed or incorporated on any Order or Purchase Order.
- 1.9 Participating Addendum** means a bilateral agreement negotiated between and executed by a Contractor and a Participating Entity incorporating this Master Agreement and any additional Participating Entity-specific language or other requirements (e.g., ordering procedures specific to the Participating Entity, entity-specific terms and conditions, etc.).
- 1.10 Participating Entity** means a state (as well as the District of Columbia and US territories), city, county, district, other political subdivision of a State, or an eligible nonprofit organization properly authorized to enter into a Participating Addendum, that has executed a Participating Addendum.
- 1.11 Participating State** means a state that has executed a Participating Addendum or has indicated an intent to execute a Participating Addendum.
- 1.12 Product or Products and Services** means small package transportation services by the Contractor pursuant to this Master Agreement. Contractor provides service-specific branded envelopes, bags and boxes at no cost. Any terms contained herein pertaining to goods shall have no effect. Contractor provides no-cost technology auxiliary solutions solely under the terms of use contained in its UPS Technology Agreement (UTA), provided concurrently with this Master Agreement to all Participating States, Participating Entities and Purchasing Entities.
- 1.13 Purchasing Entity** means a state (as well as the District of Columbia and US territories), city, county, district, other political subdivision of a State, or a nonprofit organization under the laws of some states if authorized by a Participating Addendum, that issues a Purchase Order against the Master Agreement and becomes contractually committed to the purchase.

II. Term of Master Agreement

- 2.1 Initial Term.** The initial term of this Master Agreement is for five (5) years.

The Master Agreement may be extended for a reasonable period of time, not to exceed 120 days, if in the judgment of the Lead State a follow-on, competitive procurement will be unavoidably delayed (despite good faith

efforts) beyond the planned date of execution of the follow-on master agreement. This subsection shall not be deemed to limit the authority of a Lead State under its state law otherwise to negotiate contract extensions.

- 2.2 Amendment Limitations.** Except as provided in a duly executed Participating Addendum, the terms of this Master Agreement will not be waived, altered, modified, supplemented, or amended in any manner whatsoever without prior written agreement of the Lead State and Contractor.
- 2.3 Amendment Term.** The term of the Master Agreement may be amended past the initial term and any additional periods created by duly executed mutually agreed amendment for a reasonable period, not to exceed 120 days, if in the judgment of the Lead State a follow-on competitive procurement will be unavoidably delayed (despite good faith efforts) beyond the planned date of execution of the follow-on master agreement. This subsection will not be deemed to limit the authority of a Lead State under its state law to otherwise negotiate contract extensions.

III. Order of Precedence

- 3.1 Order.** Any Order placed under this Master Agreement will consist of the following documents in descending order from highest precedence:
- 3.1.1** A Participating Entity's Participating Addendum ("PA");
 - 3.1.2** NASPO ValuePoint Master Agreement, including Attachment A, NASPO ValuePoint Master Agreement Terms and Conditions and Attachment C, Pricing;
 - 3.1.3** Contractor's Rate & Service Guide and Tariff/Terms & Conditions of Service in effect at the time of shipping, incorporated by reference and deemed attached as an exhibit to this Master Agreement at www.ups.com, wherein as applicable all non-Contractor parties to this Master Agreement are deemed Shippers;
 - 3.1.4** A Purchase Order issued against the Master Agreement;
 - 3.1.5** Attachment B, Scope of Work, to the NASPO ValuePoint Master Agreement;
 - 3.1.6** The Solicitation or, if separately executed after award, the Lead State's bilateral agreement that integrates applicable provisions;
 - 3.1.7** Contractor's response to the Solicitation, as revised and accepted by the Lead State.
- 3.2 Conflict.** These documents will be read to be consistent and complementary. Any conflict among these documents will be resolved by giving priority to these documents in the order listed above. Contractor terms and conditions that apply to this Master Agreement are only those that are expressly accepted by the Lead State and must be in writing and attached to this Master Agreement as an Exhibit or Attachment.

3.3 Participating Addenda. Participating Addenda will not be construed to diminish, modify, or otherwise derogate any provisions in this Master Agreement between the Lead State and Contractor. Participating Addenda will not include a term of agreement that exceeds the term of the Master Agreement.

3.4

IV. Participants and Scope

4.1 Requirement for a Participating Addendum. Contractor may not deliver Products under this Master Agreement until a Participating Addendum acceptable to the Participating Entity and Contractor is executed.

4.2 Applicability of Master Agreement. NASPO ValuePoint Master Agreement Terms and Conditions are applicable to any Order by a Participating Entity (and other Purchasing Entities covered by their Participating Addendum), except to the extent altered, modified, supplemented or amended by a Participating Addendum, subject to Section III. For the purposes of illustration and not limitation, this authority may apply to unique delivery and invoicing requirements, confidentiality requirements, defaults on Orders, governing law and venue relating to Orders by a Participating Entity, indemnification, and insurance requirements. Statutory or constitutional requirements relating to availability of funds may require specific language in some Participating Addenda in order to comply with applicable law. The expectation is that these alterations, modifications, supplements, or amendments will be addressed in the Participating Addendum or, an amendment hereto.

4.3 Authorized Use. Use of specific NASPO ValuePoint Master Agreements by Participating Entities and Purchasing Entities is subject to applicable state law and the approval of the respective State Chief Procurement Official. Issues of interpretation and eligibility for participation are solely within the authority of the respective State Chief Procurement Official, subject to the terms of the Participating Addendum and this Master Agreement. Contractor may on occasion require proof of the State Chief Procurement Official's approval, and in such cases the responsible Participating Entity shall cooperate in the successful provision of such proof prior to Contractor's performance or continued performance on behalf of any Participating Entity or Purchasing Entity in question. In order to access benefits of this contract, the Purchasing Entity must identify a Participating Addendum that authorizes the Purchasing Entity's use of the contract and request alignment with the contract. Contractor shall not be liable for any failure to align a Purchasing Entity's account to the contract if Contractor has a good faith basis for denying a request to align with the contract.

4.4 Obligated Entities. Obligations under this Master Agreement are limited to those Participating Entities who have signed a Participating Addendum and Purchasing Entities within the scope of those Participating Addenda.

States or other entities permitted to participate may use an informal competitive process to determine which Master Agreements to participate in through execution of a Participating Addendum. Participating Entities incur no financial obligations on behalf of other Purchasing Entities.

- 4.5 Notice of Participating Addendum.** Contractor shall email a fully executed PDF copy of each Participating Addendum to pa@naspovaluepoint.org to support documentation of participation and posting in appropriate databases.
- 4.6 Eligibility for a Participating Addendum.** Subject to Section 4.3, eligible entities who are not states may under some circumstances sign their own Participating Addendum, subject to the consent of the Chief Procurement Official of the state where the entity is located. Contractor shall coordinate requests for such participation through NASPO ValuePoint. Any permission to participate through execution of a Participating Addendum is not a determination that procurement authority exists; the entity must ensure that they have the requisite procurement authority to execute a Participating Addendum.
- 4.7 Prohibition on Resale.** Subject to any specific conditions included in the solicitation or Contractor's proposal as accepted by the Lead State, or as explicitly permitted in a Participating Addendum, Participating Entities and Purchasing Entities may not resell Products purchased under this Master Agreement. In the interest of reducing risk of fraud and unauthorized re-selling of Contractor's services, nothing in this contract shall obligate Contractor to continue service to any organization that has exhibited fraudulent behaviors. Purchasing Entities shall not allow third parties to benefit from this contract without the express written permission of Contractor. Shipping behavior that suggests a benefit to a third party without the Contractor's express permission shall be considered "Fraud". Contractor, in its sole discretion, can suspend or cancel any account for Fraud.
- 4.8 Individual Customers.** Except as may otherwise be agreed to by the Purchasing Entity and Contractor, each Purchasing Entity shall follow the terms and conditions of the Master Agreement and applicable Participating Addendum and will have the same rights and responsibilities for their purchases as the Lead State has in the Master Agreement and as the Participating Entity has in the Participating Addendum, including but not limited to any indemnity or right to recover any costs as such right is defined in the Master Agreement and applicable Participating Addendum for their purchases. Each Purchasing Entity will be responsible for its own charges, fees, and liabilities. The Contractor will apply the charges and invoice each Purchasing Entity individually. Personal or business use by employees, contractors or other individual persons or entities not involving official duties of a Participating State or Participating Entity is prohibited unless expressly and separately agreed by Contractor.

- 4.9 Release of Information.** Throughout the duration of this Master Agreement, Contractor must secure from the Lead State prior approval for the release of information that pertains to the potential work or activities covered by the Master Agreement. This limitation does not preclude publication about the award of the Master Agreement or marketing activities consistent with any proposed and accepted marketing plan.
- 4.10 No Representations.** The Contractor shall not make any representations of NASPO ValuePoint, the Lead State, any Participating Entity, or any Purchasing Entity's opinion or position as to the quality or effectiveness of the services that are the subject of this Master Agreement without prior written consent.

V. NASPO ValuePoint Provisions

- 5.1 Applicability.** NASPO ValuePoint is not a party to the Master Agreement. The terms set forth in Section V are for the benefit of NASPO ValuePoint as a third-party beneficiary of this Master Agreement.

5.2 Administrative Fees

5.2.1 NASPO ValuePoint Fee. Contractor shall pay to NASPO ValuePoint, or its assignee, a NASPO ValuePoint Administrative Fee of one-quarter of one percent (0.25% or 0.0025) no later than sixty (60) days following the end of each calendar quarter. The NASPO ValuePoint Administrative Fee must be submitted quarterly and is based on all sales of products and services under the Master Agreement (including base transportation, package-related charges and fees and fuel surcharges not to include unclassified, miscellaneous or other fees). The NASPO ValuePoint Administrative Fee is not negotiable. This fee is to be included as part of the pricing submitted with a vendor's response to the Lead State's solicitation.

5.2.2 State Imposed Fees. Some states may request an additional fee be paid directly to the state on purchases made by Purchasing Entities within that state. For all such requests, the fee rate or amount, payment method and schedule for such reports and payments will be incorporated into the applicable Participating Addendum as negotiated between Contractor and Participating Entity. Unless agreed to in writing by the state, Contractor may not adjust the Master Agreement pricing to include the state fee for purchases made by Purchasing Entities within the jurisdiction of the state. No such agreement will affect the NASPO ValuePoint Administrative Fee percentage or the prices paid by Purchasing Entities outside the jurisdiction of the state requesting the additional fee.

5.3 NASPO ValuePoint Summary and Detailed Usage Reports

- 5.3.1 Summary Sales Data.** The Contractor shall submit quarterly sales reports directly to NASPO ValuePoint using the NASPO ValuePoint Quarterly Sales/Administrative Fee Reporting Tool found at <http://calculator.naspovaluepoint.org>. All sales made under this Master Agreement must be reported as cumulative totals by state. Contractor must submit a report for each quarter, including quarters during which a Contractor has no sales, in which case this will be indicated in the Reporting Tool. Reports must be submitted no later than thirty (30) days following the end of the calendar quarter (as specified in the reporting tool).
- 5.3.2 Detailed Sales Data.** Contractor shall also report detailed sales data by: (1) account name, (2) Vendor Assigned Customer Number, (3) combined all sales, as clarified in Section 5.2.1, paid by Purchasing Entities, (4) volume, (5) state, (6) service description, (7) Quantity, and (8) Total Price. Reports are due on a quarterly basis and must be received by the Lead State and NASPO ValuePoint Cooperative Development Team no later than thirty (30) days after the end of the reporting period. Reports must be delivered to the Lead State and to the NASPO ValuePoint Cooperative Development Team electronically through a designated portal or other method as determined by the Lead State and NASPO ValuePoint. Detailed sales data reports must include sales information for all sales under Participating Addenda executed under this Master Agreement.
- 5.3.3 Reporting on Personal Use.** Personal use is prohibited unless expressly and separately agreed by Contractor.
- 5.3.4 Executive Summary.** Contractor shall provide the NASPO ValuePoint Cooperative Development Coordinator with an executive summary each quarter that includes, at a minimum, a list of states with an active Participating Addendum, states that Contractor is in negotiations with and any Participating Addendum roll out or implementation activities and issues. NASPO ValuePoint Cooperative Development Coordinator and Contractor will determine the format and content of the executive summary. The executive summary is due thirty (30) days after the conclusion of each calendar quarter.
- 5.3.5 Use of Data.** Timely submission of these reports is a material requirement of the Master Agreement. The recipient of the reports will have exclusive ownership of the media containing the reports. The Lead State and NASPO ValuePoint shall have a perpetual, irrevocable, non-exclusive, royalty free, transferable right to display, modify, copy, and otherwise use reports, data and information provided under this section.

5.4 NASPO ValuePoint Cooperative Program Marketing, Training, and Performance Review

5.4.1 Staff Education. Contractor shall work cooperatively with NASPO ValuePoint personnel. Contractor shall present plans to NASPO ValuePoint for the education of Contractor's contract administrator(s) and sales/marketing workforce regarding the Master Agreement contract, including the competitive nature of NASPO ValuePoint procurements, the master agreement and participating addendum process, and the manner in which eligible entities can participate in the Master Agreement.

5.4.2 Onboarding Plan. Upon request by NASPO ValuePoint, Contractor shall, as Participating Addendums are executed, provide plans to launch the program for the Participating Entity. Plans will include time frames to launch the agreement and confirmation that the Contractor's website has been updated to properly reflect the scope and terms of the Master Agreement as available to the Participating Entity and eligible Purchasing Entities.

5.4.3 Annual Contract Performance Review. Contractor shall participate in an annual contract performance review with the Lead State and NASPO ValuePoint, which may at the discretion of the Lead State be held in person and which may include a discussion of marketing action plans, target strategies, marketing materials, Contractor reporting, and timeliness of payment of administration fees.

5.4.4 Use of NASPO ValuePoint Logo. Unless otherwise agreed in this Master Agreement or a Participating Addendum, no party hereto shall use another's logos or branding in any public-facing forum until a separate agreement is executed.

5.4.5 Removed.

5.5 Removed.

VI. Pricing, Payment & Leasing

6.1 Pricing. In the interest of clarity, the terms "prices" and "rates" refer to the dollar amounts to be paid by Purchasing Entity for transportation services identified in the rate chart/sheet exhibit attached to this Master Agreement; the terms "charges" and "fees" refer to the dollar amounts to be paid by Purchasing Entity for assessorial services identified in Contractor's Rate & Service Guide which is subject to change and in effect at the time of shipping.

6.1.1 All prices and rates must be guaranteed for the first year following execution of the Master Agreement

6.1.2 Following the first year following execution of the Master Agreement, any request for a price or rate adjustment must be for

an equal guarantee period (one year) and must be made at least 60 days prior to the effective date of the proposed rate change..

6.1.3 Requests for a price or rate adjustment must include sufficient documentation supporting the request. Any adjustment or amendment to the Master Agreement will not be effective unless approved in writing by the Lead State.

6.1.4 No retroactive adjustments to prices or rates will be allowed.

6.2 Payment. Unless otherwise agreed upon in a Participating Addendum or Order, Payment after Acceptance will be made within thirty (30) days following the date the entire order is delivered or the date a correct invoice is received, whichever is later. After 45 days the Contractor may assess overdue account charges up to a maximum rate of one percent per month on the outstanding balance, unless a different late payment amount is specified in a Participating Addendum or Order, or otherwise prescribed by applicable law. Payments will be remitted in the manner specified in the Participating Addendum or Order. Payments may be made via a purchasing card with no additional charge.

6.3 Leasing or Alternative Financing Methods. The procurement and other applicable laws of some Purchasing Entities may permit the use of leasing or alternative financing methods for the acquisition of Products under this Master Agreement. Where the terms and conditions are not otherwise prescribed in an applicable Participating Addendum, the terms and conditions for leasing or alternative financing methods are subject to negotiation between the Contractor and Purchasing Entity.

VII. Ordering

7.1 Order Numbers. Master Agreement order and purchase order numbers must be clearly shown on all acknowledgments, packing slips, invoices, and on all correspondence.

7.2 Quotes. Purchasing Entities may define entity-specific or project-specific requirements and informally compete the requirement among companies having a Master Agreement on an “as needed” basis. This procedure may also be used when requirements are aggregated or other firm commitments may be made to achieve reductions in pricing. This procedure may be modified in Participating Addenda and adapted to the Purchasing Entity’s rules and policies. The Purchasing Entity may in its sole discretion determine which Master Agreement Contractors should be solicited for a quote. The Purchasing Entity may select the quote that it considers most advantageous, cost, and other factors considered.

7.3 Applicable Rules. Each Purchasing Entity will identify and utilize its own appropriate purchasing procedure and documentation. Contractor is expected to become familiar with the Purchasing Entities’ rules, policies, and procedures regarding the ordering of services contemplated by this Master Agreement. If in the reasonable discretion of either Contractor or

Purchasing Entity, the business rules, policies and/or procedures of the other are incompatible resulting in excessive inefficiencies, either party may terminate the Purchasing Entities service relationship otherwise with 60-days written notice.

7.4 Required Documentation. Contractor shall not begin work without a valid Purchase Order or other appropriate commitment document under the law of the Purchasing Entity.

7.5 Term of Purchase. Orders may be placed consistent with the terms of this Master Agreement and applicable Participating Addendum during the term of the Master Agreement and Participating Addendum.

7.5.1 Orders must be placed pursuant to this Master Agreement prior to the termination date thereof, and only shipments that have been tendered to Contractor as of the termination date will be delivered and processed pursuant to this Contract, including Attachment C, UPS Rates and Attachment D, UPS Rate and Service Guide and Tariff/Terms and Conditions of Service – United States, in effect at the time of shipping.

7.5.2 Notwithstanding the previous, Orders must also comply with the terms of the applicable Participating Addendum, which may further restrict the period during which Orders may be placed or delivered.

7.5.3 Financial obligations of Purchasing Entities payable after the current applicable fiscal year are contingent upon agency funds for that purpose being appropriated, budgeted, and otherwise made available.

7.5.4 Notwithstanding the expiration, cancellation or termination of this Master Agreement, Contractor shall perform in accordance with the terms of any Orders then outstanding at the time of such expiration or termination. Contractor shall not honor any Orders placed after the expiration, cancellation, or termination of this Master Agreement, or in any manner inconsistent with this Master Agreement's terms.

7.5.5 Orders for any separate indefinite quantity, task order, or other form of indefinite delivery order arrangement priced against this Master Agreement may not be placed after the expiration, cancellation or termination of this Master Agreement, notwithstanding the term of any such indefinite delivery order agreement.

7.6 Order Form Requirements. All Orders pursuant to this Master Agreement, at a minimum, must include:

7.6.1 The services or supplies being delivered;

7.6.2 A shipping address and other delivery requirements, if any;

7.6.3 A billing address;

- 7.6.4 Purchasing Entity contact information;
 - 7.6.5 Pricing consistent with this Master Agreement and applicable Participating Addendum and as may be adjusted by agreement of the Purchasing Entity and Contractor;
 - 7.6.6 A not-to-exceed total for the products or services being ordered; and
 - 7.6.7 The Master Agreement number or the applicable Participating Addendum number, provided the Participating Addendum references the Master Agreement number. Contractor will provide reference fields at the time of order. Inputs by Purchasing Entities in the reference fields will appear on invoices. Purchasing Entities are responsible for properly inputting the Master Agreement number and the Participating Addendum number at the time of order.
- 7.7 **Communication.** All communications concerning administration of Orders placed must be furnished solely to the authorized purchasing agent within the Purchasing Entity's purchasing office, or to such other individual identified in writing in the Order.
- 7.8 **Contract Provisions for Orders Utilizing Federal Funds.** Pursuant to Appendix II to 2 Code of Federal Regulations (CFR) Part 200, Contract Provisions for Non-Federal Entity Contracts Under Federal Awards, Orders funded with federal funds may have additional contractual requirements or certifications that must be satisfied at the time the Order is placed or upon delivery. These federal requirements may be proposed by Participating Entities in Participating Addenda and Purchasing Entities for incorporation in Orders placed under this Master Agreement.

VIII. Removed

IX. Inspection and Acceptance

- 9.1 **Laws and Regulations.** Any and all Products offered and furnished must comply fully with all applicable Federal, State, and local laws and regulations.
- 9.2 **Applicability.** Unless otherwise specified in the Master Agreement, Participating Addendum, or ordering document, the terms of this Section IX will apply. This section is not intended to limit rights and remedies under the applicable commercial code.
- 9.3 **Inspection.** All Products are subject to inspection at reasonable times and places before Acceptance. Contractor shall provide right of access to the Lead State, or to any other authorized agent or official of the Lead State or other Participating or Purchasing Entity, at reasonable times, to monitor and evaluate performance, compliance, and/or quality assurance requirements under this Master Agreement.

9.3.1 Removed.

9.3.2 Removed.

9.4 Failure to Conform. If any services do not conform to contract requirements, the Purchasing Entity may require the Contractor satisfy all applicable Contractor claims request processes and service guarantee terms as provided in Contractor's Rate & Service Guide and Tariff/Terms & Conditions of Service in effect at the time of shipping, and such shall provide the sole remedy for same.

9.5 **Removed**

X. Warranty

10.1 Applicability. Unless otherwise specified in the Master Agreement or Participating Addendum, the terms of this Section X will apply.

10.2 Warranty. Contractor's sole warranty obligations are provided in Contractor's Rate & Service Guide and Tariff/Terms & Conditions of Service in effect at the time of shipping.

10.3 Breach of Warranty. Contractor will satisfy breach of warranty matters in accordance with Contractor's Rate & Service Guide and Tariff/Terms & Conditions of Service in effect at the time of shipping.

10.4 Rights Reserved. The rights and remedies of the parties under this warranty are in addition to any other rights and remedies of the parties provided by law or equity, including, without limitation, actual damages, and, as applicable and awarded under the law, to a prevailing party, reasonable attorneys' fees and costs.

10.5 **Removed.**

XI. Removed

XII. Indemnification

12.1 General Indemnification. The Contractor shall defend, indemnify and hold harmless NASPO, NASPO ValuePoint, the Lead State, Participating Entities, and Purchasing Entities, along with their officers and employees, from and against third-party claims, damages or causes of action including reasonable attorneys' fees and related costs for any death, injury, or damage to tangible property arising from any act, error, or omission of the Contractor, its employees or subcontractors or volunteers, at any tier, relating to performance under this Master Agreement.

12.2 Intellectual Property Indemnification. Recognizing that this Master Agreement does not convey any interest or rights in any materials, goods, hardware, software or other property (personal or intellectual), the Contractor shall defend, indemnify and hold harmless NASPO, NASPO ValuePoint, the Lead State, Participating Entities, Purchasing Entities,

along with their officers and employees ("Indemnified Party"), from and against claims, damages or causes of action including reasonable attorneys' fees and related costs arising out of the claim that the Product or its use infringes Intellectual Property rights of another person or entity ("Intellectual Property Claim").

12.2.1 The Contractor's obligations under this section will not extend to any combination of the Product with any other product, system or method, unless the Product, system or method is:

12.2.1.1 provided by the Contractor or the Contractor's subsidiaries or affiliates;

12.2.1.2 specified by the Contractor to work with the Product;

12.2.1.3 reasonably required to use the Product in its intended manner, and the infringement could not have been avoided by substituting another reasonably available product, system or method capable of performing the same function; or

12.2.1.4 reasonably expected to be used in combination with the Product.

12.2.2 The Indemnified Party shall notify the Contractor within a reasonable time after receiving notice of an Intellectual Property Claim. Even if the Indemnified Party fails to provide reasonable notice, the Contractor shall not be relieved from its obligations unless the Contractor can demonstrate that it was prejudiced in defending the Intellectual Property Claim resulting in increased expenses or loss to the Contractor. If the Contractor promptly and reasonably investigates and defends any Intellectual Property Claim, it shall have control over the defense and settlement of the Intellectual Property Claim. However, the Indemnified Party must consent in writing for any money damages or obligations for which it may be responsible.

12.2.3 The Indemnified Party shall furnish, at the Contractor's reasonable request and expense, information and assistance necessary for such defense. If the Contractor fails to vigorously pursue the defense or settlement of the Intellectual Property Claim, the Indemnified Party may assume the defense or settlement of the Intellectual Property Claim and the Contractor shall be liable for all costs and expenses, including reasonable attorneys' fees and related costs, incurred by the Indemnified Party in the pursuit of the Intellectual Property Claim.

12.2.4 Unless otherwise set forth herein, Section 12.2 is not subject to any limitations of liability in this Master Agreement or in any other document executed in conjunction with this Master Agreement.

XIII. Insurance

- 13.1 Term.** Contractor shall, during the term of this Master Agreement, maintain in full force and effect, the insurance described in this section. A Participating Entity may negotiate alternative Insurance requirements in their Participating Addendum.
- 13.2 Class.** Contractor shall acquire such insurance from an insurance carrier or carriers licensed to conduct business in each Participating Entity's state and having a rating of A-, Class VII or better, in the most recently published edition of A.M. Best's Insurance Reports. Failure to buy and maintain the required insurance may result in this Master Agreement's termination or, at a Participating Entity's option, result in termination of its Participating Addendum.
- 13.3 Coverage.** Coverage must be written on an occurrence basis. The minimum acceptable limits will be as indicated below:
- 13.3.1** Contractor shall maintain Commercial General Liability insurance covering premises operations, independent contractors, products and completed operations, blanket contractual liability, personal injury (including death), advertising liability, and property damage, with a limit of not less than \$1 million per occurrence and \$2 million general aggregate;
- 13.3.2** Contractor must comply with any applicable State Workers Compensation or Employers Liability Insurance requirements.
- 13.4 Notice of Cancellation.** Contractor shall pay premiums on all insurance policies. Contractor shall provide notice to a Participating Entity who is a state within five (5) business days after Contractor is first aware of expiration, cancellation or nonrenewal of such policy or is first aware that cancellation is threatened or expiration, nonrenewal or expiration otherwise may occur.
- 13.5 Notice of Endorsement.** Prior to commencement of performance, Contractor shall provide to the Lead State a written endorsement to the Contractor's general liability insurance policy or other documentary evidence acceptable to the Lead State that (1) provides that written notice of cancellation will be delivered in accordance with the policy provisions, and (2) provides that the Contractor's liability insurance policy will be primary, with any liability insurance of any Participating State as secondary and noncontributory.
- 13.6 Participating Entities.** Contractor shall provide to Participating States and Participating Entities the same insurance obligations and upon request in the context of a Participating Addendum the same documentation as those specified in Section XIII, except the endorsement is provided to the applicable Participating State or Participating Entity.
- 13.7 Furnishing of Certificates.** Contractor shall furnish to the Lead State copies of certificates of all required insurance in a form sufficient to show

required coverage within thirty (30) calendar days of the execution of this Master Agreement and prior to performing any work. Copies of renewal certificates of all required insurance will be furnished within thirty (30) days after any renewal date to the Lead State. Contractor shall provide copies of certificates and renewal certificates to Participating Entities upon request in the context of a Participating Addendum. Failure to provide evidence of coverage may, at the sole option of the Lead State, or any Participating Entity, result in this Master Agreement's termination or the termination of any Participating Addendum.

- 13.8 Disclaimer.** Insurance coverage and limits will not limit Contractor's liability and obligations under this Master Agreement, any Participating Addendum, or any Purchase Order.

XIV. General Provisions

14.1 Records Administration and Audit

- 14.1.1** The Contractor shall maintain books, records, documents, and other evidence pertaining to this Master Agreement and Orders placed by Purchasing Entities under it to the extent and in such detail as will adequately reflect performance and administration of payments and fees. Contractor shall permit the Lead State, a Participating Entity, a Purchasing Entity, the federal government (including its grant awarding entities and the U.S. Comptroller General), and any other duly authorized agent of a governmental agency, to audit, inspect, examine, copy and/or transcribe Contractor's books, documents, papers and records directly pertinent to this Master Agreement or orders placed by a Purchasing Entity under it for the purpose of making audits, examinations, excerpts, and transcriptions. This right will survive for a period of six (6) years following termination of this Agreement or final payment for any order placed by a Purchasing Entity against this Master Agreement, whichever is later, or such longer period as is required by the Purchasing Entity's state statutes, to assure compliance with the terms hereof or to evaluate performance hereunder.
- 14.1.2** Without limiting any other remedy available to any governmental entity, the Contractor shall reimburse the applicable Lead State, Participating Entity, or Purchasing Entity for any overpayments inconsistent with the terms of the Master Agreement or Orders or underpayment of fees found as a result of the examination of the Contractor's records.
- 14.1.3** The rights and obligations herein exist in addition to any quality assurance obligation in the Master Agreement that requires the Contractor to self-audit contract obligations and that permits the Lead State to review compliance with those obligations.

14.2 Confidentiality, Non-Disclosure, and Injunctive Relief

14.2.1 Confidentiality. Contractor acknowledges that it and its employees or agents may, in the course of providing a Product under this Master Agreement, be exposed to or acquire information that is confidential to a Participating Entity or Purchasing Entity.

14.2.1.1 Any and all information of any form that is marked as confidential or would by its nature be deemed confidential obtained by Contractor or its employees or agents in the performance of this Master Agreement, including but not necessarily limited to (1) any Participating Entity's or Purchasing Entity's records, (2) personnel records, and (3) information concerning individuals, is confidential information of Participating Entity or Purchasing Entity ("Confidential Information"). Notwithstanding any term, condition or definition in conflict or to the contrary, Confidential Information in all instances shall not include data or information which is addressed in the Data Handling provision of Contractor's Tariff/Terms & Conditions of Service in effect at the time of shipping which shall solely control Contractor's use and disclosure of such data or information.

14.2.1.2 Any reports or other documents or items (including software) that result from the use of the Confidential Information by Contractor shall be treated in the same manner as the Confidential Information.

14.2.1.3 Confidential Information does not include information that (1) is or becomes (other than by disclosure by Contractor) publicly known; (2) is furnished by Purchasing Entity to others without restrictions similar to those imposed by this Master Agreement; (3) is rightfully in Contractor's possession without the obligation of nondisclosure prior to the time of its disclosure under this Master Agreement; (4) is obtained from a source other than Purchasing Entity without the obligation of confidentiality, (5) is disclosed with the written consent of Purchasing Entity; or (6) is independently developed by employees, agents or subcontractors of Contractor who can be shown to have had no access to the Confidential Information.

14.2.2 Non-Disclosure. Contractor shall hold Confidential Information in confidence, using at least the industry standard of

confidentiality, and shall not copy, reproduce, sell, assign, license, market, transfer or otherwise dispose of, give, or disclose Confidential Information to third parties or use Confidential Information for any purposes whatsoever other than what is necessary to the performance of Orders placed under this Master Agreement.

- 14.2.2.1** Contractor shall advise each of its employees and agents of their obligations to keep Confidential Information confidential. Contractor shall use commercially reasonable efforts to assist Purchasing Entity in identifying and preventing any unauthorized use or disclosure of any Confidential Information.
- 14.2.2.2** Without limiting the generality of the foregoing, Contractor shall advise Purchasing Entity, applicable Participating Entity, and the Lead State immediately if Contractor learns or has reason to believe that any person who has had access to Confidential Information has violated or intends to violate the terms of this Master Agreement, and Contractor shall at its expense cooperate with Purchasing Entity in seeking injunctive or other equitable relief in the name of Purchasing Entity or Contractor against any such person.
- 14.2.2.3** Except as directed by Purchasing Entity, Contractor will not at any time during or after the term of this Master Agreement disclose, directly or indirectly, any Confidential Information to any person, except in accordance with this Master Agreement, and that upon termination of this Master Agreement or at Purchasing Entity's request, Contractor shall turn over to Purchasing Entity all documents, papers, and other matter in Contractor's possession that embody Confidential Information.
- 14.2.2.4** Notwithstanding the foregoing, Contractor may keep one copy of such Confidential Information necessary for quality assurance, audits, and evidence of the performance of this Master Agreement.

14.2.3 Injunctive Relief. Contractor acknowledges that Contractor's breach of Section 14.2 would cause irreparable injury to the Purchasing Entity that cannot be inadequately compensated in monetary damages. Accordingly, Purchasing Entity may seek and obtain injunctive relief against the breach or threatened breach of the foregoing undertakings, in addition to any other legal remedies that may be available. Contractor acknowledges and agrees that the covenants contained herein are necessary

for the protection of the legitimate business interests of Purchasing Entity and are reasonable in scope and content.

14.2.4 Purchasing Entity Law. These provisions will be applicable only to extent they are not in conflict with the applicable public disclosure laws of any Purchasing Entity. If such conflict is disclosed or otherwise discovered, either party in its sole discretion may terminate the relevant Participating Addendum or service relationship otherwise with 60-days written notice to the other party.

14.2.5 NASPO ValuePoint. The rights granted to Purchasing Entities and Contractor's obligations under this section will also extend to NASPO ValuePoint's Confidential Information, including but not limited to Participating Addenda, Orders or transaction data relating to Orders under this Master Agreement that identify the entity/customer, Order dates, line-item descriptions and volumes, and prices/rates. This provision does not apply to disclosure to the Lead State, a Participating State, or any governmental entity exercising an audit, inspection, or examination pursuant to this Master Agreement. To the extent permitted by law, Contractor shall notify the Lead State of the identify of any entity seeking access to the Confidential Information described in this subsection.

14.2.6 Public Information. This Master Agreement and all related contract documents maintained by NASPO Value Point and the Lead State are subject to disclosure pursuant to the Lead State's public information laws.

14.3 Assignment/Subcontracts

14.3.1 Contractor shall not assign, sell, transfer, subcontract or sublet rights, or delegate responsibilities under this Master Agreement, in whole or in part, without the prior written approval of the Lead State.

14.3.2 Without impact to the rights and obligations of NASPO ValuePoint as a third-party intended beneficiary under the terms of this agreement, the Lead State reserves the right to assign any rights or duties, including written assignment of contract administration duties, to NASPO ValuePoint and other third parties, subject to the express consent of Contractor, which shall not be unreasonably withheld.

14.4 Changes in Contractor Representation. The Contractor must, within ten (10) calendar days, notify the Lead State in writing of any changes in the Contractor's key administrative personnel managing the Master Agreement. The Contractor shall propose replacement key personnel having substantially equal or better education, training, and experience as

was possessed by the key person proposed and evaluated in the Contractor's proposal.

- 14.5 Independent Contractor.** Contractor is an independent contractor. Contractor has no authorization, express or implied, to bind the Lead State, Participating States, other Participating Entities, or Purchasing Entities to any agreements, settlements, liability or understanding whatsoever, and shall not to hold itself out as agent except as expressly set forth herein or as expressly set forth in an applicable Participating Addendum or Order.
- 14.6 Cancellation.** Unless otherwise set forth herein, this Master Agreement may be canceled or terminated by either the Lead State or Contractor upon sixty (60) days' written notice prior to the effective date of the cancellation. Expiration, termination or cancellation of the Master Agreement may result in a concurrent cancellation or termination of any and all Participating Addenda. Further, either Contractor or Participating Entity may cancel or terminate a Participating Addendum upon sixty (60) days' written notice, unless otherwise limited or stated in the Participating Addendum. Cancellation or termination may be in whole or in part. Any cancellation under this provision will not affect the rights and obligations attending Orders outstanding at the time of cancellation, including any right of a Purchasing Entity to indemnification by the Contractor, rights of payment for Products delivered and accepted, rights attending any warranty or default in performance in association with any Order, and requirements for records administration and audit. The Lead State may exercise its right to not renew the Master Agreement if vendor fails to record or report revenue for three consecutive quarters, upon 60-calendar day written notice to the Contractor. Cancellation of the Master Agreement due to Contractor default may be immediate.
- 14.7 Force Majeure.** No party to this Master Agreement shall be held responsible for reasonable delay or default caused by fire, riot, unusually severe weather, pandemic, national, regional or state emergency or acts of government in response, other acts of God, or acts of war which are beyond that party's reasonable control.
- 14.8 Defaults and Remedies**
- 14.8.1** The occurrence of any of the following events will be an event of default under this Master Agreement:
- 14.8.1.1** Nonperformance of contractual requirements;
 - 14.8.1.2** A material breach of any term or condition of this Master Agreement;
 - 14.8.1.3** Any certification, representation or warranty by Contractor in response to the solicitation or in this Master Agreement that proves to be untrue or materially misleading;

- 14.8.1.4** Institution of proceedings under any bankruptcy, insolvency, reorganization or similar law, by or against Contractor, or the appointment of a receiver or similar officer for Contractor or any of its property, which is not vacated or fully stayed within thirty (30) calendar days after the institution or occurrence thereof; or
 - 14.8.1.5** Any default specified in another section of this Master Agreement.
- 14.8.2** Upon the occurrence of an event of default, the injured party shall issue a written notice of default, identifying the nature of the default, and providing a period of fifteen (15) calendar days in which defaulting party shall have an opportunity to cure the default. The injured party shall not be required to provide advance written notice or a cure period and may immediately terminate this Master Agreement in whole or in part if the injured party, in its sole discretion, determines that it is reasonably necessary to preserve safety or prevent further harm or disruption. Time allowed for cure will not diminish or eliminate defaulting party's liability for damages to the extent provided for under this Master Agreement.
- 14.8.3** If defaulting party is afforded an opportunity to cure and fails to cure the default within the period specified in the written notice of default, defaulting party shall be in breach of its obligations under this Master Agreement and the injured party shall have the right to exercise any or all of the following remedies:
 - 14.8.3.1** Any remedy provided by law;
 - 14.8.3.2** Termination of this Master Agreement and any related Participating Addenda or portions thereof;
 - 14.8.3.3** Suspension of Contractor from being able to respond to future bid solicitations;
 - 14.8.3.4** Suspension of Contractor's performance; and
 - 14.8.3.5** Withholding of payment until the default is remedied.
- 14.8.4** Unless otherwise specified in the Participating Addendum, in the event of a default under a Participating Addendum, a Participating Entity shall provide a written notice of default as described in this section and shall have all of the rights and remedies under this paragraph regarding its participation in the Master Agreement, in addition to those set forth in its Participating Addendum. Unless otherwise specified in an Order, a Purchasing Entity shall provide written notice of default as described in this section and have all of the rights and remedies under this paragraph and any applicable Participating Addendum with respect to an Order placed by the Purchasing

Entity. Nothing in these Master Agreement Terms and Conditions will be construed to limit the rights and remedies available to a Purchasing Entity under the applicable commercial code.

14.9 Waiver of Breach. Failure of an injured party to declare a default or enforce any rights and remedies will not operate as a waiver under this Master Agreement, any Participating Addendum, or any Purchase Order. Any waiver by a party must be in writing. Waiver by the Lead State or Participating Entity of any default, right or remedy under this Master Agreement or Participating Addendum, or by Purchasing Entity with respect to any Purchase Order, or breach of any terms or requirements of this Master Agreement, a Participating Addendum, or Purchase Order will not be construed or operate as a waiver of any subsequent default or breach of such term or requirement, or of any other term or requirement under this Master Agreement, any Participating Addendum, or any Purchase Order.

14.10 Debarment. The Contractor certifies that neither it nor its principals are presently debarred, suspended, proposed for debarment, declared ineligible, or voluntarily excluded from participation in public procurement or contracting by any governmental department or agency. This certification represents a recurring certification made at the time any Order is placed under this Master Agreement. If the Contractor cannot certify this statement, attach a written explanation for review by the Lead State.

14.11 No Waiver of Sovereign Immunity

14.11.1 In no event will this Master Agreement, any Participating Addendum or any contract or any Purchase Order issued thereunder, or any act of the Lead State, a Participating Entity, or a Purchasing Entity be a waiver of any form of defense or immunity, whether sovereign immunity, governmental immunity, immunity based on the Eleventh Amendment to the Constitution of the United States or otherwise, from any claim or from the jurisdiction of any court, as provided to such entity by law.

14.11.2 This section applies to a claim brought against the Participating Entities who are states only to the extent Congress has appropriately abrogated the state's sovereign immunity and is not consent by the state to be sued in federal court. This section is also not a waiver by the state of any form of immunity, including but not limited to sovereign immunity and immunity based on the Eleventh Amendment to the Constitution of the United States.

14.12 Governing Law and Venue

14.12.1 The procurement, evaluation, and award of the Master Agreement will be governed by and construed in accordance

with the laws of the Lead State sponsoring and administering the procurement. The construction and effect of the Master Agreement after award will be governed by the law of the state serving as Lead State. The construction and effect of any Participating Addendum or Order against the Master Agreement will be governed by and construed in accordance with the laws of the Participating Entity's or Purchasing Entity's state.

14.12.2 Unless otherwise specified in the RFP, the venue for any protest, claim, dispute or action relating to the procurement, evaluation, and award is in the state serving as Lead State. Venue for any claim, dispute or action concerning the terms of the Master Agreement will be in the state serving as Lead State. Venue for any claim, dispute, or action concerning any Order placed against the Master Agreement or the effect of a Participating Addendum will be in the Purchasing Entity's state.

14.12.3 If a claim is brought in a federal forum, then it must be brought and adjudicated solely and exclusively within the United States District Court for (in decreasing order of priority): the Lead State for claims relating to the procurement, evaluation, award, or contract performance or administration if the Lead State is a party; a Participating State if a named party; the state where the Participating Entity or Purchasing Entity is located if either is a named party.

14.13 Assignment of Antitrust Rights. Contractor irrevocably assigns to a Participating Entity who is a state its pro rata portion of any claim for relief or cause of action which the Contractor now has or which may accrue to the Contractor in the future by reason of any violation of state or federal antitrust laws (15 U.S.C. § 1-15 or a Participating Entity's state antitrust provisions), as now in effect and as may be amended from time to time, in connection with any goods or services provided in that state for the purpose of carrying out the Contractor's obligations under this Master Agreement or attached Participating Addendum.

Attachment B: Scope of Work

NASPO Small Package Delivery Services

1. Exclusion of Listed Charges:

Contractor certifies the following regarding the exclusion of listed charges:

- a. The Contractor shall not propose or apply pick-up charges or weekly service in addition to the contracted rates due to aggregate NASPO ValuePoint volume anticipated.
- b. The Contractor shall not require a minimum number of packages per trip, per day, per week or per month.

2. Carrier Pick-Up:

Contractor will pick-up packages directly from all requesting agencies and political subdivisions upon request. Contractor must bill each Authorized User for shipments the Authorized User tenders to the Carrier. Packages must be scanned when picked up at the location.

3. Money Back Guarantee

- a. Contractor's Money Back Guarantee is currently suspended except for Overnight services. Upon reinstatement of the Money Back Guarantee, the following conditions shall apply.
- b. Contractor must provide a 100% Money Back Guarantee. The Carrier shall fully refund or credit the Authorized User account for the packages that are not delivered or picked up in accordance with the guaranteed delivery service. Authorized User shall decide between a refund or a credit to their account. Packages that are delivered over 60 seconds after the guaranteed delivery time are considered late. The Authorized User shall request the refund or credit within 30 days of the scheduled delivery time. Carriers are encouraged to offer automatic refunds. If the late package meets one or more of the Carrier's exception criteria, as stated in the Service Guide, the Carrier is not obligated to issue a refund to the Authorized User.
- c. Carrier must provide clearly marked money back guaranteed zone based price sheets (schedules of rates and charges) for each service showing rates and charges by weight and zone for all contiguous 48 state domestic shipping. Separate rates in pages may be provided and clearly marked for Hawaii and Alaska and Puerto Rico services. Carriers offering pricing for intrastate ground services only must provide separate clearly marked zone based pricing for the designated state. Rates will be in dollars and cents per pound.
- d. Non-Money Back Guarantee: Contractor must propose a money back guarantee. If the Contractor opts to additionally propose a non-money back guarantee option, the Contractor must clearly delineate between the money back guarantee cost and the non-money back guarantee cost. (This portion of the Scope may be updated depending on the vendor's submission and their Money Back guarantee the Contractor provides.) The Money Back Guarantee shall only apply to Contractor's single pricing response/offering, and shall not apply to any multiple pricing response/offering.

4. Carrier Capabilities:

Contractor providing interstate services must serve every zip code in the United States or if providing interstate services in certain states only, offer services in every zip code in the states in which services are provided. The Contractor providing intrastate services shall serve every zip code within the boundaries of the Participating State requesting intra-state services as identified in this RFP.

5. Software:

Contractor shall provide a description of how the software is accessed in the solicitation response. Including, if an online application is available instead of or along with the software needed to run the shipping system. The Contractor shall maintain the software and website free of charge to the

Participating Users and Master Agreement. Customer must agree to Contractor's standard software license terms and conditions prior to utilizing any Contractor software.

6. Shipment of Materials:

- a. Describe the process for picking up dangerous, Hazardous or Otherwise Restricted Materials: Carrier shall be capable of shipping a variety of hazardous, dangers or other restricted types of materials. Contractor shall provide its policy for dangerous, hazardous, and restricted materials.
- b. Evidentiary Materials: Describe the process and tracking for evidentiary materials. Also, describe an instance and detail the approach taken when the Carrier's process needed to be modified for a participating state's laws, policies, or procedures. Alternatively, describe how Carrier would approach modifying their process for an Authorized User based on the user's laws, policies, or procedures. Note: Contractor must be able to provide services for shipments of evidentiary materials in compliance with any participating state's laws, policies or procedures.

7. Deliver as Addressed:

Contractor's standard delivery procedure is to perform an address correction and forward the package to the corrected address. In the event a correct address cannot be determined, any packages returned to senders due to an incorrect address shall be assessed a return fee.



Response to NASPO ValuePoint Utah Solicitation # CH21-36 April 26, 2021 Multi Carrier Rate Charts



© 2021 United Parcel Service of America, Inc. UPS, the UPS brandmark and the color brown are trademarks of United Parcel Service America, Inc. All rights reserved.

"UPS offers customized rate sheets identifying its firm offer of rates and prices for transportation rates and prices. The rates and prices identified in the rate sheets will be guaranteed for 12-month periods and increase only with approval by the Lead State. Other fees and charges that may impact an authorized user's invoice are identified in UPS's Rate and Service Guide and as described in UPS's Tariff/Terms and Conditions of Service, in effect at the time of shipping. These fees and charges are subject to change without notice. In accordance with the conditions of the solicitation, UPS has waived all pick-up charges, including on-call/on-demand, and capped fuel surcharges at 7%. Fuel surcharge information is posted on UPS's website, www.ups.com."

Product Name	Service Description	Guar-anteed	Time in Transit	Area Coverage
UPS Next Day Air Early	Guaranteed overnight, first of day service, as early as 8:00 A.M., to the 48 contiguous U.S. states and limited addresses in Anchorage, Alaska.	Yes	1 Business Day, as early as 8:00 A.M. depending on origin/destination	US 48 contiguous states and limited addresses in Anchorage, Alaska
UPS Next Day Air	Guaranteed next business day delivery by 10:30 a.m., 12:00 p.m. or end of day, depending on destination, to all 50 states and Puerto Rico. UPS Next Day Intra is the name for this service in Puerto Rico.	Yes	1 Business Day, 10:30 a.m. (some extended areas by noon and end of day)	US 50 states and Puerto Rico
UPS Next Day Air Saver	Guaranteed overnight afternoon delivery throughout the U.S. 48 contiguous states.	Yes	1 Business Day, 3:00 p.m. or 4:30 p.m. to commercial destinations where UPS Next Day Air delivery is committed by 10:30 a.m. or noon, respectively; residential by end of day	US 48 contiguous states
UPS 2nd Day Air A.M.	Guaranteed delivery, by the morning of the second business day, to commercial destinations in the U.S. 48 contiguous states and selected locations in Anchorage, Alaska.	Yes	2 Business Days, 10:30 a.m. (some extended areas by 12:00 p.m.)	US 48 contiguous states
UPS 2nd Day Air	Guaranteed delivery, by the end of the second business day, throughout the U.S. and Puerto Rico.	Yes	2 Business Days, End of Day	US 50 states and Puerto Rico
UPS 3 Day Select	Guaranteed delivery, by the end of the third business day, throughout the U.S. 48 contiguous states.	Yes	3 Business Days, End of Day	US 48 contiguous states
UPS Ground	Guaranteed, cost-effective, day-definite delivery typically within one to five business days to all 50 states and Puerto Rico. UPS Ground is an economical choice for all routine shipments.	Yes	1 to 5 Business Days, End of Day, depending on origin/destination	US 50 states and Puerto Rico
UPS Hundredweight Service	Guaranteed, reliable, cost-effective delivery for non-palletized, multiple package shipments sent to a single address on the same day. Time-definite or day-definite delivery within 1 to 5 business days depending on level of service. Ideal for scheduled pickup customers with frequent shipments of more than 100 pounds. Available with UPS Next Day Air®, UPS Next Day Air Saver®, UPS 2nd Day Air A.M.®, UPS 2nd Day Air®, UPS 3 Day Select®, and UPS Ground.	Yes	1-5 Business Days, Matches single package service offerings	Matches single package service offerings
UPS Worldwide Express	UPS Express is UPS's premium, time-committed small package express service, serving 121 countries worldwide. Time-definite delivery is guaranteed in 1-3 business days, typically by 10:30 a.m. or noon. In limited areas, the time commit is 2pm. For worldwide shipments to Europe, UPS has a competitive advantage of delivering by 10:30 a.m. in 29 cities, while DHL and FedEx express services have noon or EOD commitments in those cities.	Yes	1-3 Business Days, 10:30 a.m. or 12:00 p.m. (limited areas 2 p.m.)	All UPS origins to 121 countries
UPS Worldwide Express Saver	UPS Express Saver is UPS's day-definite small package express service. Whether worldwide, transborder or domestic, service is guaranteed by end-of-day in typically 1-3 business days.	Yes	1-3 Business Days, End of Day, depending on origin/destination	All UPS origins to all UPS destinations
UPS Expedited	UPS Expedited is a deferred, international small package service that is guaranteed in 2-5 business days by end of day (guarantee applicable to U.S. and Canada payors only).	Yes	2-5 Business Days, End of Day, depending on origin/destination	From 80 countries to more than 220 countries and territories
UPS Standard / Worldwide Standard	UPS Standard is a small package, "non-express", "deferred", day-definite, ground service available in North America and Europe.	Yes	1-8 Business Days, End of Day, depending on origin/destination	North America (between US, Canada and Mexico), Europe domestic, transborder, and worldwide lanes between Norway, Switzerland, and the EU
3 Day Select (Canada to US)	A guaranteed, day-definite service. Shipments are typically delivered by the end of the third business day. Service is only valid from Canada to the US 48 contiguous states.	Yes	3 Business Days, End of Day	Canada to US 48 contiguous states (Import Only)

UPS offers customized rate sheets identifying its firm offer of rates and prices for transportation rates and prices. The rates and prices identified in the rate sheets will be guaranteed for 12-month periods and increase only with approval by the Lead State. Other fees and charges that may impact an authorized user's invoice are identified in UPS's Rate and Service Guide and as described in UPS's Tariff/Terms and Conditions of Service, in effect at the time of shipping. These fees and charges are subject to change without notice. In accordance with the conditions of the solicitation, UPS has waived all pick-up charges, including on-call/on-demand, and capped fuel surcharges at 7%. Fuel surcharge information is posted on UPS's website, www.ups.com.

UPS® Domestic Air - Delivery. The following custom rates will apply to packages billed via Prepaid, Freight Collect, Third Party, Return Service and Return Service Third Party.

Residential Surcharges apply.

UPS offers customized rate sheets identifying its firm offer of rates and prices for transportation rates and prices. The rates and prices identified in the rate sheets will be guaranteed for 12-month periods and increase only with approval by the Lead State. Other fees and charges that may impact an authorized user's invoice are identified in UPS's Rate and Service Guide and as described in UPS's Tariff/Terms and Conditions of Service, in effect at the time of shipping. These fees and charges are subject to change without notice. In accordance with the conditions of the solicitation, UPS has waived all pick-up charges, including on-call/on-demand, and capped fuel surcharges at 7%. Fuel surcharge information is posted on UPS's website, www.ups.com.

<i>Value Added Services / Other Charges *</i>	<i>Type</i>
Automatic Daily On-Route Pickup	Percent off
Automatic Daily Pickup	Percent off
Day-Specific Pickup	Percent off
Residential Surcharge - On Call Pickup	Percent off
Returns Plus - 1 UPS Pickup Attempt Domestic	Percent off
Returns Plus - 3 UPS Pickup Attempts Domestic	Percent off
Smart Pickup	Percent off
UPS On-Call Pickup [®] - Future Day	Percent off
UPS On-Call Pickup [®] - Same Day	Percent off
UPS On-Call Pickup [®] Area Surcharge - Extended Residential	Percent off
UPS On-Call Pickup [®] Area Surcharge - Residential	Percent off
UPS On-Call Pickup [®] Remote Surcharge - Alaska	Percent off
UPS On-Call Pickup [®] Remote Surcharge - Hawaii	Percent off
1 UPS Pick up Attempt - International	List
3 UPS Pick up Attempt - International	List
Additional Handling - Domestic (Dimensions)	List
Additional Handling - Domestic (Non-corrugated)	List
Additional Handling - Domestic (Weight)	List
Additional Handling - International Import	List
Additional Handling - International Export	List
Address Corrections - (Maximum per Shipment)	List
Address Corrections - Air	List
Address Corrections - Ground	List
C.O.D.	List
Commercial Domestic Air Delivery Area Surcharge - Extended (per piece excluding CWT)	List
Commercial Domestic Air Delivery Area Surcharge (per piece excluding CWT)	List
Commercial Domestic Ground Delivery Area Surcharge - Extended (per piece excluding CW)	List
Commercial Domestic Ground Delivery Area Surcharge (per piece excluding CWT)	List
Delivery Area Surcharge - (Import services)	List
Delivery Area Surcharge - Domestic Hundredweight - Air Commercial	List
Delivery Area Surcharge - Domestic Hundredweight - Air Commercial - Extended	List
Delivery Area Surcharge - Domestic Hundredweight - Air Residential	List
Delivery Area Surcharge - Domestic Hundredweight - Air Residential - Extended	List
Delivery Area Surcharge - Domestic Hundredweight - Ground Commercial	List
Delivery Area Surcharge - Domestic Hundredweight - Ground Commercial - Extended	List
Delivery Area Surcharge - Domestic Hundredweight - Ground Residential	List
Delivery Area Surcharge - Domestic Hundredweight - Ground Residential - Extended	List
Delivery Area Surcharge - Extended (Import services)	List
Delivery Area Surcharge - UPS SurePost	List
Delivery Area Surcharge - UPS SurePost - Extended	List
Delivery Change Request - Change Delivery Location	List
Delivery Change Request - Deliver to Access Point	List
Delivery Change Request - Hold for Future Delivery	List
Delivery Change Request - Hold for Will Call	List
Delivery Intercept Reroute - Phone	List
Delivery Intercept Reroute - Web	List
Delivery Intercept Return to Sender - Phone	List
Delivery Intercept Return to Sender - Web	List
Delivery Reattempt - UPS Worldwide Express Freight	List
Direct Delivery	List
Domestic - Peak Surcharge - Additional Handling	List
Domestic - Peak Surcharge - Commercial	List
Domestic - Peak Surcharge - Large Package	List
Domestic - Peak Surcharge - OverMax	List
Domestic - Peak Surcharge - Residential - All other UPS [®] Air (Applies to: UPS 2nd Day Air A.M. [®] , UPS 2nd Day Air [®] , and UPS 3 Day Select [®])	List
Domestic - Peak Surcharge - Residential - UPS SurePost [®]	List
Domestic - Peak Surcharge - Residential - UPS [®] Ground	List

Domestic - Peak Surcharge - Residential - UPS® Next Day Air (Applies to: UPS Next Day Air® Early, UPS Next Day Air®, and UPS Next Day Air Saver®)	List
Domestic & Export Monthly Late Payment Charge	List
Domestic & Export Weekly Late Payment Charge	List
Domestic Delivery Confirmation	List
Domestic Delivery Confirmation - Adult Signature Required	List
Domestic Delivery Confirmation - Signature Required	List
Dry Ice	List
Electronic Export Informaton (per shipment)	List
Electronic Return Label - Domestic	List
Electronic Return Label - International	List
Export - Disbursement Fee	List
Export - Disbursement Fee Minimum	List
Export Duty and Tax Forwarding Surcharge	List
Export Large Package Surcharge - International	List
Extended Area Surcharge - (Export services)	List
Freight Collect Refusal - International	List
Hazardous Material - Domestic Air Services* and 3 Day Select - Accessible	List
Hazardous Material - Domestic Air Services* and 3 Day Select - Inaccessible	List
Hazardous Material - Domestic Ground	List
Import - Disbursement Fee	List
Import - Disbursement Fee Minimum	List
Import Duty and Tax Forwarding Surcharge	List
Import Large Package Surcharge - International	List
Import Late Payment Charge	List
International Dangerous Goods - International Air Services - Accessible	List
International Dangerous Goods - International Air Services - Inaccessible	List
International Dangerous Goods - Standard to/from Canada	List
International Dangerous Goods - Worldwide Express Freight - Accessible	List
International Dangerous Goods - Worldwide Express Freight - Inaccessible	List
International Delivery Confirmation - Signature Required	List
International Delivery Confirmaton - Adult Signature Required	List
Missing/Invalid Account # Change	List
National Large Package Surcharge - Domestic - Commercial	List
National Large Package Surcharge - Domestic - Residential	List
Next Day Air Early (greater than 150 lbs DW) Charge	List
Over Maximum Limits	List
Oversized Pallet Handling Surcharge	List
Print and Mail Return Label - Domestic	List
Print and Mail Return Label -- International	List
Print Return Label - Domestic	List
Print Return Label - International	List
Remote Area Surcharge - (Export services)	List
Remote Area Surcharge - Destination Alaska	List
Remote Area Surcharge - Destination Hawaii	List
Remote Area Surcharge Alaska - (Import services)	List
Remote Area Surcharge Hawaii - (Import services)	List
Residential Domestic Delivery Area Surcharge, Air	List
Residential Domestic Delivery Area Surcharge, Air - Extended	List
Residential Domestic Delivery Area Surcharge, Ground	List
Residential Domestic Delivery Area Surcharge, Ground - Extended	List
Residential Surcharge - Domestic Delivery of Air Services* and 3 Day Select	List
Residential Surcharge - Domestic Delivery of Ground Service	List
Residential Surcharge - Domestic Hundredweight	List
Residential Surcharge - Export Standard Service	List
Residential Surcharge - Import Standard Service	List
Residential Surcharge - U.S. Export International Air Services	List
Residential Surcharge - U.S. Import International Air Services	List
Saturday Air Processing Fee - Domestic	List
Saturday Delivery - Air	List
Saturday Delivery - Ground and 3 Day Select	List
Saturday Delivery - International	List
Saturday Delivery - UPS Worldwide Express Freight	List
Saturday Stop Charge - Domestic	List
Third Party Billing Service Fee - Domestic	List
Third Party Billing Service Fee - Export	List

Third Party Billing Service Fee - Import	List
--	------

*UPS offers customized rate sheets identifying its firm offer of rates and prices for transportation rates and prices. The rates and prices identified in the rate sheets will be guaranteed for 12-month periods and increase only with approval by the Lead State. Other fees and charges that may impact an authorized user's invoice are identified in UPS's Rate and Service Guide and as described in UPS's Tariff/Terms and Conditions of Service, in effect at the time of shipping. These fees and charges are subject to change without notice. In accordance with the conditions of the solicitation, UPS has waived all pick-up charges, including on-call/on-demand, and capped fuel surcharges at 7%. Fuel surcharge information is posted on UPS's website, www.ups.com.

UPS offers customized rate sheets identifying its firm offer of rates and prices for transportation rates and prices. The rates and prices identified in the rate sheets will be guaranteed for 12-month periods and increase only with approval by the Lead State. Other fees and charges that may impact an authorized user's invoice are identified in UPS's Rate and Service Guide and as described in UPS's Tariff/Terms and Conditions of Service, in effect at the time of shipping. These fees and charges are subject to change without notice. In accordance with the conditions of the solicitation, UPS has waived all pick-up charges, including on-call/on-demand, and capped fuel surcharges at 7%. Fuel surcharge information is posted on UPS's website, www.ups.com.

NASPO ValuePoint**UPS Next Day Air®***(Per Package Rates from 48 State Origin)***Daily Commercial Rates***

								AK, HI	PR	AK, HI +
Lbs.	Zone 102	Zone 103	Zone 104	Zone 105	Zone 106	Zone 107	Zone 108	Zone 124	Zone 125	Zone 126
Letter	\$8.17	\$10.74	\$13.52	\$15.00	\$16.26	\$17.38	\$17.84	\$18.87	\$18.87	\$18.87
1	\$8.18	\$10.75	\$13.53	\$15.01	\$16.27	\$17.39	\$17.85	\$18.88	\$18.88	\$18.88
2	\$8.28	\$11.74	\$15.25	\$16.59	\$18.43	\$19.17	\$19.93	\$21.05	\$21.05	\$21.05
3	\$9.34	\$12.44	\$16.88	\$18.41	\$20.41	\$21.07	\$21.79	\$23.02	\$23.02	\$23.02
4	\$10.04	\$13.02	\$18.31	\$20.15	\$22.30	\$22.93	\$23.83	\$25.14	\$25.14	\$25.14
5	\$10.16	\$13.59	\$20.00	\$22.02	\$24.18	\$24.86	\$25.74	\$27.59	\$27.59	\$27.59
6	\$11.17	\$14.35	\$21.67	\$23.78	\$26.16	\$26.60	\$27.74	\$29.67	\$29.67	\$29.67
7	\$11.67	\$15.07	\$23.15	\$25.52	\$28.04	\$28.64	\$29.60	\$31.51	\$31.51	\$31.51
8	\$11.93	\$15.81	\$24.63	\$27.18	\$29.94	\$30.67	\$31.53	\$33.18	\$33.18	\$33.18
9	\$12.05	\$16.40	\$26.04	\$28.91	\$31.82	\$32.64	\$33.54	\$35.45	\$35.45	\$35.45
10	\$12.06	\$16.41	\$27.25	\$30.42	\$33.67	\$34.52	\$35.57	\$37.43	\$37.43	\$37.43
11	\$13.22	\$18.02	\$28.67	\$32.12	\$35.57	\$36.59	\$37.46	\$39.71	\$39.71	\$39.71
12	\$13.73	\$18.73	\$30.20	\$33.56	\$37.27	\$38.62	\$39.50	\$41.37	\$41.37	\$41.37
13	\$13.95	\$19.48	\$31.66	\$35.08	\$38.79	\$40.64	\$41.37	\$43.37	\$43.37	\$43.37
14	\$14.53	\$20.19	\$33.28	\$36.59	\$40.30	\$42.39	\$43.40	\$45.47	\$45.47	\$45.47
15	\$14.84	\$20.92	\$34.42	\$38.07	\$41.79	\$43.78	\$45.06	\$47.16	\$47.16	\$47.16
16	\$15.26	\$21.64	\$36.06	\$39.50	\$43.16	\$44.93	\$46.18	\$48.37	\$48.37	\$48.37
17	\$15.92	\$22.36	\$37.12	\$40.73	\$44.14	\$45.94	\$47.21	\$49.44	\$49.44	\$49.44
18	\$16.44	\$23.07	\$38.22	\$41.61	\$45.16	\$46.95	\$48.47	\$50.65	\$50.65	\$50.65
19	\$16.81	\$23.69	\$39.11	\$42.46	\$46.17	\$47.98	\$49.75	\$52.30	\$52.30	\$52.30
20	\$16.92	\$24.21	\$40.13	\$43.53	\$47.16	\$49.12	\$50.87	\$53.38	\$53.38	\$53.38
21	\$17.67	\$24.93	\$40.97	\$44.60	\$48.15	\$50.10	\$52.23	\$54.58	\$54.58	\$54.58
22	\$18.18	\$25.49	\$41.97	\$45.62	\$49.16	\$51.26	\$53.39	\$55.83	\$55.83	\$55.83
23	\$18.56	\$26.01	\$43.00	\$46.75	\$50.27	\$52.35	\$54.65	\$57.36	\$57.36	\$57.36
24	\$18.98	\$26.48	\$44.09	\$47.95	\$51.64	\$53.50	\$55.77	\$58.41	\$58.41	\$58.41
25	\$19.29	\$26.85	\$45.25	\$48.90	\$53.03	\$54.80	\$56.91	\$60.22	\$60.22	\$60.22
26	\$19.83	\$27.66	\$46.49	\$50.13	\$54.40	\$56.20	\$58.09	\$61.14	\$61.14	\$61.14
27	\$20.24	\$28.16	\$47.64	\$51.57	\$55.91	\$57.42	\$59.20	\$62.84	\$62.84	\$62.84
28	\$20.73	\$28.77	\$48.88	\$53.03	\$57.03	\$58.53	\$60.43	\$63.93	\$63.93	\$63.93
29	\$21.11	\$29.27	\$50.15	\$54.14	\$58.27	\$59.84	\$61.75	\$65.31	\$65.31	\$65.31
30	\$21.15	\$29.49	\$51.14	\$55.40	\$59.41	\$60.99	\$62.13	\$66.89	\$66.89	\$66.89
31	\$21.91	\$30.33	\$52.23	\$56.66	\$60.66	\$62.25	\$64.27	\$68.27	\$68.27	\$68.27
32	\$22.54	\$31.05	\$53.39	\$57.93	\$61.88	\$63.46	\$65.48	\$69.82	\$69.82	\$69.82
33	\$23.05	\$31.83	\$54.40	\$59.16	\$63.14	\$64.89	\$66.97	\$71.39	\$71.39	\$71.39
34	\$23.56	\$32.33	\$55.64	\$60.40	\$64.52	\$66.27	\$68.32	\$73.05	\$73.05	\$73.05
35	\$24.31	\$32.92	\$56.91	\$61.69	\$65.74	\$67.66	\$69.70	\$74.48	\$74.48	\$74.48
36	\$24.88	\$33.44	\$58.12	\$62.92	\$67.03	\$69.17	\$71.05	\$76.02	\$76.02	\$76.02
37	\$24.91	\$34.41	\$59.27	\$64.22	\$68.36	\$70.72	\$72.57	\$77.42	\$77.42	\$77.42
38	\$25.30	\$34.98	\$60.30	\$65.32	\$69.67	\$72.36	\$73.95	\$79.22	\$79.22	\$79.22
39	\$26.09	\$35.57	\$61.45	\$66.57	\$71.01	\$73.87	\$75.41	\$80.80	\$80.80	\$80.80
40	\$26.35	\$36.15	\$62.55	\$67.80	\$72.29	\$75.27	\$76.93	\$82.51	\$82.51	\$82.51
41	\$26.98	\$36.87	\$63.68	\$69.12	\$73.64	\$76.49	\$78.38	\$84.24	\$84.24	\$84.24
42	\$27.38	\$37.61	\$64.92	\$70.33	\$75.13	\$78.29	\$80.00	\$85.95	\$85.95	\$85.95
43	\$28.10	\$38.32	\$66.19	\$71.59	\$76.50	\$79.55	\$81.63	\$87.67	\$87.67	\$87.67
44	\$28.73	\$39.09	\$67.35	\$72.86	\$77.88	\$80.95	\$83.35	\$88.83	\$88.83	\$88.83
45	\$29.35	\$39.94	\$68.53	\$74.09	\$79.40	\$82.35	\$84.69	\$90.28	\$90.28	\$90.28
46	\$29.94	\$40.80	\$69.71	\$75.39	\$80.91	\$83.77	\$86.17	\$91.98	\$91.98	\$91.98
47	\$30.41	\$41.63	\$70.97	\$76.47	\$82.40	\$84.95	\$87.54	\$93.22	\$93.22	\$93.22
48	\$30.64	\$42.46	\$71.98	\$77.76	\$83.87	\$86.51	\$89.21	\$94.92	\$94.92	\$94.92
49	\$31.18	\$43.44	\$72.97	\$78.95	\$85.32	\$87.90	\$90.78	\$96.32	\$96.32	\$96.32
50	\$31.19	\$43.90	\$72.99	\$78.96	\$85.37	\$89.00	\$90.81	\$97.72	\$97.72	\$97.72
51	\$32.54	\$45.27	\$75.22	\$81.49	\$88.50	\$90.91	\$94.24	\$99.40	\$99.40	\$99.40

52	\$33.03	\$46.23	\$76.37	\$82.74	\$90.01	\$92.44	\$96.08	\$101.14	\$101.14	\$101.14
53	\$33.71	\$46.99	\$77.51	\$84.11	\$91.60	\$93.91	\$97.72	\$102.80	\$102.80	\$102.80
54	\$34.23	\$47.94	\$78.73	\$85.28	\$92.97	\$95.75	\$99.59	\$104.96	\$104.96	\$104.96
55	\$34.73	\$48.80	\$80.29	\$86.41	\$94.40	\$97.35	\$101.05	\$106.50	\$106.50	\$106.50
56	\$35.38	\$49.75	\$81.78	\$87.53	\$95.87	\$99.13	\$102.68	\$108.68	\$108.68	\$108.68
57	\$36.04	\$50.61	\$83.27	\$88.68	\$97.25	\$100.77	\$104.43	\$110.41	\$110.41	\$110.41
58	\$36.84	\$51.40	\$84.76	\$89.91	\$98.72	\$102.58	\$106.28	\$112.37	\$112.37	\$112.37
59	\$37.37	\$52.27	\$86.26	\$91.29	\$100.23	\$104.19	\$108.12	\$114.29	\$114.29	\$114.29
60	\$38.11	\$53.10	\$87.65	\$92.51	\$101.86	\$105.95	\$109.46	\$116.40	\$116.40	\$116.40
61	\$38.77	\$54.12	\$89.15	\$94.17	\$103.49	\$107.58	\$109.47	\$118.49	\$118.49	\$118.49
62	\$39.69	\$55.07	\$90.53	\$95.92	\$105.08	\$109.38	\$113.57	\$120.79	\$120.79	\$120.79
63	\$40.35	\$56.17	\$92.05	\$97.32	\$106.87	\$111.28	\$115.47	\$123.08	\$123.08	\$123.08
64	\$41.12	\$57.24	\$93.57	\$98.98	\$108.59	\$113.17	\$117.28	\$125.13	\$125.13	\$125.13
65	\$41.79	\$58.36	\$94.93	\$100.57	\$110.35	\$115.17	\$118.93	\$127.13	\$127.13	\$127.13
66	\$42.56	\$59.42	\$96.45	\$102.21	\$112.12	\$117.08	\$121.04	\$129.46	\$129.46	\$129.46
67	\$42.80	\$60.54	\$97.82	\$103.99	\$113.99	\$119.11	\$123.12	\$131.31	\$131.31	\$131.31
68	\$44.09	\$61.62	\$99.30	\$105.72	\$115.69	\$120.84	\$125.13	\$133.34	\$133.34	\$133.34
69	\$44.93	\$62.70	\$100.81	\$107.48	\$117.46	\$120.87	\$127.23	\$135.19	\$135.19	\$135.19
70	\$45.27	\$63.21	\$100.82	\$109.13	\$117.49	\$120.89	\$128.95	\$137.20	\$137.20	\$137.20
71	\$46.37	\$64.99	\$103.72	\$110.85	\$121.10	\$126.15	\$131.30	\$139.06	\$139.06	\$139.06
72	\$46.95	\$66.12	\$103.74	\$112.68	\$122.31	\$128.07	\$131.32	\$141.54	\$141.54	\$141.54
73	\$47.24	\$67.32	\$106.68	\$114.39	\$122.34	\$129.81	\$133.61	\$143.98	\$143.98	\$143.98
74	\$47.25	\$68.37	\$108.07	\$116.17	\$124.37	\$131.62	\$136.03	\$146.38	\$146.38	\$146.38
75	\$47.27	\$68.99	\$108.08	\$116.18	\$126.93	\$133.39	\$138.26	\$148.49	\$148.49	\$148.49
76	\$49.89	\$70.70	\$110.96	\$119.51	\$129.48	\$135.13	\$140.47	\$150.83	\$150.83	\$150.83
77	\$50.24	\$71.78	\$111.48	\$121.16	\$129.97	\$136.91	\$142.37	\$152.96	\$152.96	\$152.96
78	\$50.26	\$72.21	\$111.49	\$122.68	\$130.41	\$137.03	\$144.17	\$155.05	\$155.05	\$155.05
79	\$50.27	\$73.20	\$111.51	\$124.28	\$131.62	\$138.80	\$145.10	\$157.19	\$157.19	\$157.19
80	\$50.31	\$74.03	\$113.04	\$125.80	\$133.47	\$142.20	\$146.24	\$159.34	\$159.34	\$159.34
81	\$53.69	\$75.35	\$114.54	\$125.83	\$135.25	\$143.83	\$148.71	\$161.51	\$161.51	\$161.51
82	\$54.01	\$77.01	\$117.92	\$129.08	\$136.33	\$145.87	\$151.51	\$163.54	\$163.54	\$163.54
83	\$55.16	\$77.97	\$117.95	\$130.57	\$142.10	\$145.89	\$152.84	\$165.88	\$165.88	\$165.88
84	\$55.20	\$78.82	\$119.77	\$130.62	\$142.76	\$148.54	\$154.83	\$168.21	\$168.21	\$168.21
85	\$55.21	\$79.78	\$121.60	\$133.68	\$142.80	\$151.16	\$156.47	\$169.32	\$169.32	\$169.32
86	\$57.01	\$80.01	\$125.32	\$135.25	\$143.58	\$152.93	\$158.96	\$172.37	\$172.37	\$172.37
87	\$57.03	\$81.72	\$126.45	\$136.83	\$145.66	\$154.33	\$160.52	\$174.39	\$174.39	\$174.39
88	\$57.05	\$81.94	\$128.47	\$138.32	\$150.65	\$156.07	\$162.77	\$176.06	\$176.06	\$176.06
89	\$57.06	\$81.95	\$130.06	\$139.98	\$152.33	\$157.93	\$163.99	\$177.76	\$177.76	\$177.76
90	\$57.10	\$81.97	\$131.64	\$141.48	\$154.25	\$159.95	\$165.82	\$179.64	\$179.64	\$179.64
91	\$60.39	\$85.50	\$132.97	\$143.09	\$155.58	\$161.10	\$167.39	\$181.95	\$181.95	\$181.95
92	\$60.40	\$85.63	\$134.87	\$144.77	\$155.70	\$163.57	\$169.44	\$183.01	\$183.01	\$183.01
93	\$60.42	\$86.59	\$136.35	\$144.78	\$155.71	\$165.36	\$171.93	\$186.18	\$186.18	\$186.18
94	\$60.43	\$87.48	\$137.96	\$147.91	\$155.75	\$167.08	\$172.85	\$188.62	\$188.62	\$188.62
95	\$60.46	\$87.49	\$139.50	\$147.94	\$158.68	\$168.87	\$174.65	\$190.45	\$190.45	\$190.45
96	\$64.00	\$89.01	\$140.84	\$151.00	\$164.31	\$170.78	\$176.27	\$192.51	\$192.51	\$192.51
97	\$64.59	\$89.01	\$142.29	\$151.91	\$164.34	\$172.52	\$179.26	\$194.35	\$194.35	\$194.35
98	\$64.60	\$89.01	\$143.79	\$151.91	\$164.35	\$173.88	\$181.17	\$195.82	\$195.82	\$195.82
99	\$65.27	\$89.01	\$144.79	\$151.91	\$164.37	\$174.46	\$181.58	\$195.82	\$195.82	\$195.82
100	\$65.27	\$89.01	\$144.79	\$151.91	\$167.34	\$174.46	\$181.58	\$195.82	\$195.82	\$195.82
101	\$65.93	\$89.90	\$146.24	\$153.43	\$169.01	\$176.21	\$183.40	\$197.78	\$197.78	\$197.78
102	\$66.58	\$90.79	\$147.69	\$154.95	\$170.69	\$177.95	\$185.21	\$199.74	\$199.74	\$199.74
103	\$67.23	\$91.68	\$149.13	\$156.47	\$172.36	\$179.70	\$187.03	\$201.70	\$201.70	\$201.70
104	\$67.89	\$92.57	\$150.58	\$157.99	\$174.03	\$181.44	\$188.85	\$203.66	\$203.66	\$203.66
105	\$68.54	\$93.46	\$152.03	\$159.51	\$175.71	\$183.18	\$190.66	\$205.62	\$205.62	\$205.62
106	\$69.19	\$94.35	\$153.48	\$161.03	\$177.38	\$184.93	\$192.48	\$207.57	\$207.57	\$207.57
107	\$69.84	\$95.24	\$154.93	\$162.55	\$179.05	\$186.67	\$194.29	\$209.53	\$209.53	\$209.53
108	\$70.50	\$96.13	\$156.37	\$164.06	\$180.73	\$188.42	\$196.11	\$211.49	\$211.49	\$211.49
109	\$71.15	\$97.02	\$157.82	\$165.58	\$182.40	\$190.16	\$197.92	\$213.45	\$213.45	\$213.45
110	\$71.80	\$97.91	\$159.27	\$167.10	\$184.07	\$191.91	\$199.74	\$215.41	\$215.41	\$215.41
111	\$72.45	\$98.80	\$160.72	\$168.62	\$185.75	\$193.65	\$201.56	\$217.36	\$217.36	\$217.36
112	\$73.11	\$99.69	\$162.17	\$170.14	\$187.42	\$195.40	\$203.37	\$219.32	\$219.32	\$219.32
113	\$73.76	\$100.58	\$163.61	\$171.66	\$189.09	\$197.14	\$205.19	\$221.28	\$221.28	\$221.28
114	\$74.41	\$101.47	\$165.06	\$173.18	\$190.77	\$198.89	\$207.00	\$223.24	\$223.24	\$223.24
115	\$75.07	\$102.36	\$166.51	\$174.70	\$192.44	\$200.63	\$208.82	\$225.20	\$225.20	\$225.20

116	\$75.72	\$103.25	\$167.96	\$176.22	\$194.12	\$202.38	\$210.64	\$227.16	\$227.16	\$227.16
117	\$76.37	\$104.14	\$169.41	\$177.74	\$195.79	\$204.12	\$212.45	\$229.11	\$229.11	\$229.11
118	\$77.02	\$105.03	\$170.85	\$179.26	\$197.46	\$205.86	\$214.27	\$231.07	\$231.07	\$231.07
119	\$77.68	\$105.92	\$172.30	\$180.78	\$199.14	\$207.61	\$216.08	\$233.03	\$233.03	\$233.03
120	\$78.33	\$106.81	\$173.75	\$182.29	\$200.81	\$209.35	\$217.90	\$234.99	\$234.99	\$234.99
121	\$78.98	\$107.70	\$175.20	\$183.81	\$202.48	\$211.10	\$219.71	\$236.95	\$236.95	\$236.95
122	\$79.64	\$108.59	\$176.65	\$185.33	\$204.16	\$212.84	\$221.53	\$238.91	\$238.91	\$238.91
123	\$80.29	\$109.48	\$178.09	\$186.85	\$205.83	\$214.59	\$223.35	\$240.86	\$240.86	\$240.86
124	\$80.94	\$110.37	\$179.54	\$188.37	\$207.50	\$216.33	\$225.16	\$242.82	\$242.82	\$242.82
125	\$81.59	\$111.26	\$180.99	\$189.89	\$209.18	\$218.08	\$226.98	\$244.78	\$244.78	\$244.78
126	\$82.25	\$112.15	\$182.44	\$191.41	\$210.85	\$219.82	\$228.79	\$246.74	\$246.74	\$246.74
127	\$82.90	\$113.04	\$183.88	\$192.93	\$212.52	\$221.57	\$230.61	\$248.70	\$248.70	\$248.70
128	\$83.55	\$113.93	\$185.33	\$194.45	\$214.20	\$223.31	\$232.43	\$250.65	\$250.65	\$250.65
129	\$84.20	\$114.82	\$186.78	\$195.97	\$215.87	\$225.06	\$234.24	\$252.61	\$252.61	\$252.61
130	\$84.86	\$115.71	\$188.23	\$197.49	\$217.54	\$226.80	\$236.06	\$254.57	\$254.57	\$254.57
131	\$85.51	\$116.60	\$189.68	\$199.00	\$219.22	\$228.54	\$237.87	\$256.53	\$256.53	\$256.53
132	\$86.16	\$117.49	\$191.12	\$200.52	\$220.89	\$230.29	\$239.69	\$258.49	\$258.49	\$258.49
133	\$86.82	\$118.38	\$192.57	\$202.04	\$222.56	\$232.03	\$241.50	\$260.45	\$260.45	\$260.45
134	\$87.47	\$119.27	\$194.02	\$203.56	\$224.24	\$233.78	\$243.32	\$262.40	\$262.40	\$262.40
135	\$88.12	\$120.16	\$195.47	\$205.08	\$225.91	\$235.52	\$245.14	\$264.36	\$264.36	\$264.36
136	\$88.77	\$121.05	\$196.92	\$206.60	\$227.58	\$237.27	\$246.95	\$266.32	\$266.32	\$266.32
137	\$89.43	\$121.95	\$198.36	\$208.12	\$229.26	\$239.01	\$248.77	\$268.28	\$268.28	\$268.28
138	\$90.08	\$122.84	\$199.81	\$209.64	\$230.93	\$240.76	\$250.58	\$270.24	\$270.24	\$270.24
139	\$90.73	\$123.73	\$201.26	\$211.16	\$232.60	\$242.50	\$252.40	\$272.20	\$272.20	\$272.20
140	\$91.38	\$124.62	\$202.71	\$212.68	\$234.28	\$244.25	\$254.22	\$274.15	\$274.15	\$274.15
141	\$92.04	\$125.51	\$204.16	\$214.20	\$235.95	\$245.99	\$256.03	\$276.11	\$276.11	\$276.11
142	\$92.69	\$126.40	\$205.60	\$215.72	\$237.62	\$247.74	\$257.85	\$278.07	\$278.07	\$278.07
143	\$93.34	\$127.29	\$207.05	\$217.23	\$239.30	\$249.48	\$259.66	\$280.03	\$280.03	\$280.03
144	\$94.00	\$128.18	\$208.50	\$218.75	\$240.97	\$251.22	\$261.48	\$281.99	\$281.99	\$281.99
145	\$94.65	\$129.07	\$209.95	\$220.27	\$242.64	\$252.97	\$263.29	\$283.94	\$283.94	\$283.94
146	\$95.30	\$129.96	\$211.40	\$221.79	\$244.32	\$254.71	\$265.11	\$285.90	\$285.90	\$285.90
147	\$95.95	\$130.85	\$212.84	\$223.31	\$245.99	\$256.46	\$266.93	\$287.86	\$287.86	\$287.86
148	\$96.61	\$131.74	\$214.29	\$224.83	\$247.66	\$258.20	\$268.74	\$289.82	\$289.82	\$289.82
149	\$97.26	\$132.63	\$215.74	\$226.35	\$249.34	\$259.95	\$270.56	\$291.78	\$291.78	\$291.78
150	\$97.91	\$133.52	\$217.19	\$227.87	\$251.01	\$261.69	\$272.37	\$293.74	\$293.74	\$293.74
Price/Lb.	\$0.65	\$0.88	\$1.44	\$1.51	\$1.66	\$1.73	\$1.80	\$1.95	\$1.95	\$1.95

Any fraction of a pound more than the weight shown in the rate chart is rounded up to the next listed weight.

*UPS offers customized rate sheets identifying its firm offer of rates and prices for transportation rates and prices. The rates and prices identified in the rate sheets will be guaranteed for 12-month periods and increase only with approval by the Lead State. Other fees and charges that may impact an authorized user's invoice are identified in UPS's Rate and Service Guide and as described in UPS's Tariff/Terms and Conditions of Service, in effect at the time of shipping. These fees and charges are subject to change without notice. In accordance with the conditions of the solicitation, UPS has waived all pick-up charges, including on-call/on-demand, and capped fuel surcharges at 7%. Fuel surcharge information is posted on UPS's website, www.ups.com.

NASPO ValuePoint**UPS Next Day Air Saver®****Daily Commercial Rates***

Lbs.	Zone 132	Zone 133	Zone 134	Zone 135	Zone 136	Zone 137	Zone 138
Letter	\$8.16	\$10.62	\$13.51	\$14.99	\$16.25	\$17.36	\$17.83
1	\$8.17	\$10.64	\$13.52	\$15.01	\$16.26	\$17.38	\$17.84
2	\$8.18	\$10.65	\$13.53	\$15.02	\$16.27	\$17.39	\$17.85
3	\$8.19	\$10.66	\$14.84	\$16.13	\$17.91	\$18.45	\$19.13
4	\$8.20	\$10.67	\$16.08	\$17.68	\$19.57	\$20.13	\$20.91
5	\$8.44	\$10.80	\$17.60	\$19.21	\$20.88	\$21.42	\$22.19
6	\$8.90	\$12.15	\$19.01	\$20.51	\$22.60	\$22.95	\$23.93
7	\$9.09	\$12.72	\$20.37	\$22.29	\$24.20	\$24.69	\$25.55
8	\$9.57	\$13.05	\$21.68	\$23.71	\$25.84	\$26.47	\$27.19
9	\$10.06	\$13.65	\$22.89	\$25.22	\$27.43	\$28.17	\$28.96
10	\$10.28	\$14.16	\$23.93	\$26.57	\$29.07	\$29.84	\$30.68
11	\$10.63	\$14.82	\$25.20	\$28.02	\$30.68	\$31.57	\$32.32
12	\$10.98	\$15.54	\$26.57	\$29.33	\$32.20	\$33.29	\$34.06
13	\$11.17	\$16.33	\$27.83	\$30.67	\$33.48	\$35.03	\$35.72
14	\$11.51	\$16.94	\$29.27	\$31.94	\$34.77	\$36.58	\$37.46
15	\$12.00	\$17.53	\$30.26	\$33.25	\$36.06	\$37.76	\$38.89
16	\$12.25	\$17.98	\$31.71	\$34.47	\$37.25	\$38.76	\$39.87
17	\$12.88	\$18.29	\$32.61	\$35.58	\$38.11	\$39.63	\$40.73
18	\$13.27	\$18.76	\$33.60	\$36.34	\$38.96	\$40.52	\$41.80
19	\$13.61	\$19.27	\$34.39	\$37.10	\$39.84	\$41.40	\$42.93
20	\$13.84	\$19.82	\$37.10	\$40.29	\$43.12	\$44.94	\$46.57
21	\$14.23	\$20.24	\$38.08	\$41.27	\$44.40	\$46.21	\$47.89
22	\$14.73	\$20.65	\$39.02	\$42.24	\$45.51	\$47.25	\$48.86
23	\$14.95	\$21.04	\$40.13	\$43.26	\$46.57	\$48.15	\$50.04
24	\$15.36	\$21.37	\$41.18	\$44.40	\$47.84	\$49.34	\$51.07
25	\$15.68	\$21.86	\$42.40	\$45.81	\$49.07	\$50.82	\$52.27
26	\$16.08	\$22.47	\$43.64	\$46.91	\$50.21	\$51.86	\$53.44
27	\$16.32	\$23.07	\$44.79	\$47.95	\$51.18	\$53.50	\$54.81
28	\$16.83	\$23.69	\$45.81	\$48.90	\$52.43	\$54.39	\$56.36
29	\$17.17	\$23.81	\$46.80	\$49.89	\$53.44	\$55.41	\$57.81
30	\$17.43	\$24.42	\$48.09	\$51.00	\$54.72	\$56.93	\$58.69
31	\$17.78	\$24.65	\$49.07	\$52.27	\$55.91	\$57.92	\$59.73
32	\$18.16	\$24.84	\$49.89	\$53.44	\$57.18	\$59.01	\$60.90
33	\$18.56	\$25.61	\$50.91	\$54.51	\$58.60	\$60.15	\$62.26
34	\$18.86	\$26.18	\$52.17	\$55.51	\$59.90	\$61.37	\$63.45
35	\$19.44	\$26.69	\$53.28	\$56.62	\$61.05	\$62.69	\$64.78
36	\$19.77	\$27.27	\$54.38	\$57.76	\$62.27	\$63.98	\$66.25
37	\$20.16	\$27.63	\$55.83	\$59.19	\$63.51	\$65.08	\$67.49
38	\$20.51	\$28.17	\$57.05	\$60.59	\$64.84	\$66.03	\$68.60
39	\$21.02	\$28.84	\$58.33	\$61.87	\$66.39	\$67.17	\$69.88
40	\$21.35	\$29.52	\$59.52	\$63.29	\$67.80	\$68.60	\$71.42
41	\$21.73	\$29.94	\$60.42	\$64.53	\$69.18	\$69.88	\$72.98
42	\$22.10	\$30.32	\$61.47	\$65.97	\$70.57	\$71.28	\$74.69
43	\$22.47	\$31.00	\$62.55	\$67.35	\$71.83	\$72.72	\$76.31
44	\$22.87	\$31.53	\$63.72	\$68.60	\$73.42	\$73.94	\$77.89
45	\$23.24	\$32.23	\$64.84	\$69.88	\$74.79	\$75.35	\$78.93
46	\$23.59	\$32.78	\$66.03	\$71.02	\$76.09	\$76.79	\$80.42
47	\$24.09	\$33.44	\$67.35	\$72.12	\$77.20	\$78.33	\$81.77
48	\$24.47	\$34.12	\$68.60	\$73.42	\$78.42	\$79.59	\$82.82
49	\$24.84	\$34.79	\$69.56	\$74.26	\$79.65	\$80.89	\$83.88
50	\$25.31	\$35.33	\$69.64	\$74.27	\$79.66	\$80.91	\$83.91
51	\$25.68	\$35.98	\$71.83	\$76.91	\$81.94	\$83.80	\$87.21
52	\$26.18	\$36.52	\$72.98	\$78.32	\$83.12	\$85.47	\$88.84
53	\$26.69	\$37.31	\$74.08	\$79.68	\$84.05	\$86.93	\$90.38

54	\$27.05	\$38.04	\$75.35	\$80.72	\$85.23	\$88.47	\$92.03
55	\$27.52	\$38.83	\$76.50	\$81.77	\$86.48	\$89.63	\$93.64
56	\$28.04	\$39.51	\$77.76	\$82.65	\$87.75	\$91.54	\$95.00
57	\$28.66	\$40.32	\$78.63	\$84.30	\$89.41	\$93.21	\$96.17
58	\$29.27	\$41.25	\$79.59	\$85.33	\$91.31	\$95.00	\$98.09
59	\$29.77	\$42.31	\$80.85	\$86.38	\$93.07	\$96.46	\$99.62
60	\$30.22	\$43.22	\$82.13	\$88.30	\$94.66	\$98.26	\$101.50
61	\$30.77	\$44.03	\$83.39	\$89.32	\$96.17	\$99.91	\$103.75
62	\$31.63	\$44.70	\$84.69	\$90.72	\$97.95	\$101.40	\$105.41
63	\$32.10	\$45.56	\$86.07	\$92.12	\$99.29	\$102.86	\$107.58
64	\$32.73	\$46.46	\$87.33	\$93.54	\$100.94	\$104.81	\$109.26
65	\$33.23	\$47.28	\$88.58	\$94.83	\$102.45	\$106.46	\$111.10
66	\$33.81	\$47.31	\$88.60	\$94.85	\$104.37	\$108.55	\$112.51
67	\$34.35	\$49.17	\$91.31	\$97.60	\$105.82	\$110.01	\$114.20
68	\$34.98	\$50.13	\$92.69	\$99.05	\$107.85	\$111.64	\$116.03
69	\$35.58	\$50.93	\$93.77	\$100.45	\$109.26	\$113.46	\$117.81
70	\$36.33	\$51.98	\$95.19	\$101.96	\$111.05	\$115.52	\$119.83
71	\$37.04	\$52.80	\$96.03	\$103.23	\$112.19	\$116.89	\$121.49
72	\$37.75	\$53.62	\$97.31	\$104.64	\$113.79	\$118.84	\$123.61
73	\$38.27	\$54.82	\$98.85	\$106.18	\$115.33	\$120.70	\$125.90
74	\$39.02	\$55.80	\$100.13	\$107.85	\$117.16	\$122.32	\$128.14
75	\$39.63	\$56.58	\$101.28	\$109.47	\$118.71	\$124.33	\$129.47
76	\$40.24	\$56.59	\$102.68	\$111.10	\$120.38	\$126.18	\$131.78
77	\$40.96	\$58.34	\$103.92	\$112.83	\$121.92	\$128.14	\$133.83
78	\$41.61	\$59.31	\$105.39	\$114.43	\$123.46	\$129.81	\$135.74
79	\$42.11	\$60.37	\$106.56	\$116.20	\$125.07	\$131.64	\$137.52
80	\$42.21	\$61.31	\$108.02	\$117.81	\$126.41	\$133.59	\$139.47
81	\$43.43	\$62.44	\$109.28	\$119.27	\$127.71	\$135.31	\$141.24
82	\$44.45	\$63.38	\$110.96	\$120.98	\$129.40	\$137.25	\$143.32
83	\$45.06	\$64.44	\$112.51	\$122.23	\$131.07	\$139.23	\$145.27
84	\$45.54	\$65.42	\$114.37	\$123.80	\$132.58	\$141.23	\$146.74
85	\$45.78	\$66.50	\$116.20	\$125.20	\$134.20	\$143.06	\$148.36
86	\$46.75	\$67.47	\$117.98	\$126.85	\$135.85	\$144.65	\$150.04
87	\$47.28	\$68.53	\$119.83	\$128.57	\$137.43	\$146.33	\$151.95
88	\$47.76	\$69.63	\$121.70	\$129.99	\$138.98	\$148.08	\$153.60
89	\$48.54	\$70.69	\$123.46	\$131.32	\$140.67	\$149.70	\$155.37
90	\$48.55	\$71.65	\$125.42	\$132.79	\$142.22	\$151.22	\$157.44
91	\$49.51	\$72.72	\$127.17	\$134.47	\$143.76	\$153.00	\$159.26
92	\$50.23	\$73.52	\$128.83	\$136.32	\$145.48	\$155.08	\$161.20
93	\$50.96	\$74.43	\$130.36	\$138.00	\$147.12	\$156.84	\$162.95
94	\$51.45	\$75.22	\$131.99	\$139.53	\$148.70	\$158.55	\$164.75
95	\$51.47	\$75.96	\$133.18	\$141.08	\$150.37	\$159.69	\$166.56
96	\$52.22	\$75.96	\$134.63	\$142.58	\$151.91	\$161.48	\$168.04
97	\$52.22	\$75.96	\$135.99	\$144.32	\$151.91	\$163.14	\$169.65
98	\$52.22	\$75.96	\$137.43	\$145.87	\$151.91	\$164.79	\$169.71
99	\$52.22	\$75.96	\$138.86	\$145.98	\$151.91	\$164.97	\$169.71
100	\$52.22	\$75.96	\$138.86	\$145.98	\$151.91	\$164.97	\$169.71
101	\$52.74	\$76.72	\$140.25	\$147.44	\$153.43	\$166.62	\$171.41
102	\$53.26	\$77.48	\$141.63	\$148.90	\$154.95	\$168.27	\$173.11
103	\$53.79	\$78.23	\$143.02	\$150.36	\$156.47	\$169.92	\$174.81
104	\$54.31	\$78.99	\$144.41	\$151.82	\$157.99	\$171.57	\$176.50
105	\$54.83	\$79.75	\$145.80	\$153.28	\$159.51	\$173.22	\$178.20
106	\$55.35	\$80.51	\$147.19	\$154.74	\$161.03	\$174.86	\$179.90
107	\$55.88	\$81.27	\$148.58	\$156.20	\$162.55	\$176.51	\$181.59
108	\$56.40	\$82.03	\$149.97	\$157.66	\$164.06	\$178.16	\$183.29
109	\$56.92	\$82.79	\$151.35	\$159.12	\$165.58	\$179.81	\$184.99
110	\$57.44	\$83.55	\$152.74	\$160.58	\$167.10	\$181.46	\$186.69
111	\$57.96	\$84.31	\$154.13	\$162.04	\$168.62	\$183.11	\$188.38
112	\$58.49	\$85.07	\$155.52	\$163.50	\$170.14	\$184.76	\$190.08
113	\$59.01	\$85.83	\$156.91	\$164.96	\$171.66	\$186.41	\$191.78
114	\$59.53	\$86.59	\$158.30	\$166.41	\$173.18	\$188.06	\$193.47
115	\$60.05	\$87.35	\$159.69	\$167.87	\$174.70	\$189.71	\$195.17
116	\$60.57	\$88.11	\$161.07	\$169.33	\$176.22	\$191.36	\$196.87
117	\$61.10	\$88.87	\$162.46	\$170.79	\$177.74	\$193.01	\$198.57
118	\$61.62	\$89.63	\$163.85	\$172.25	\$179.26	\$194.66	\$200.26
119	\$62.14	\$90.39	\$165.24	\$173.71	\$180.78	\$196.31	\$201.96

120	\$62.66	\$91.15	\$166.63	\$175.17	\$182.29	\$197.96	\$203.66
121	\$63.19	\$91.91	\$168.02	\$176.63	\$183.81	\$199.61	\$205.35
122	\$63.71	\$92.67	\$169.41	\$178.09	\$185.33	\$201.26	\$207.05
123	\$64.23	\$93.43	\$170.79	\$179.55	\$186.85	\$202.91	\$208.75
124	\$64.75	\$94.19	\$172.18	\$181.01	\$188.37	\$204.56	\$210.45
125	\$65.27	\$94.95	\$173.57	\$182.47	\$189.89	\$206.21	\$212.14
126	\$65.80	\$95.70	\$174.96	\$183.93	\$191.41	\$207.86	\$213.84
127	\$66.32	\$96.46	\$176.35	\$185.39	\$192.93	\$209.51	\$215.54
128	\$66.84	\$97.22	\$177.74	\$186.85	\$194.45	\$211.16	\$217.23
129	\$67.36	\$97.98	\$179.13	\$188.31	\$195.97	\$212.81	\$218.93
130	\$67.89	\$98.74	\$180.51	\$189.77	\$197.49	\$214.46	\$220.63
131	\$68.41	\$99.50	\$181.90	\$191.23	\$199.00	\$216.11	\$222.33
132	\$68.93	\$100.26	\$183.29	\$192.69	\$200.52	\$217.76	\$224.02
133	\$69.45	\$101.02	\$184.68	\$194.15	\$202.04	\$219.41	\$225.72
134	\$69.97	\$101.78	\$186.07	\$195.61	\$203.56	\$221.06	\$227.42
135	\$70.50	\$102.54	\$187.46	\$197.07	\$205.08	\$222.71	\$229.11
136	\$71.02	\$103.30	\$188.85	\$198.53	\$206.60	\$224.36	\$230.81
137	\$71.54	\$104.06	\$190.23	\$199.99	\$208.12	\$226.00	\$232.51
138	\$72.06	\$104.82	\$191.62	\$201.45	\$209.64	\$227.65	\$234.21
139	\$72.59	\$105.58	\$193.01	\$202.91	\$211.16	\$229.30	\$235.90
140	\$73.11	\$106.34	\$194.40	\$204.37	\$212.68	\$230.95	\$237.60
141	\$73.63	\$107.10	\$195.79	\$205.83	\$214.20	\$232.60	\$239.30
142	\$74.15	\$107.86	\$197.18	\$207.29	\$215.72	\$234.25	\$240.99
143	\$74.67	\$108.62	\$198.57	\$208.75	\$217.23	\$235.90	\$242.69
144	\$75.20	\$109.38	\$199.95	\$210.21	\$218.75	\$237.55	\$244.39
145	\$75.72	\$110.14	\$201.34	\$211.67	\$220.27	\$239.20	\$246.09
146	\$76.24	\$110.90	\$202.73	\$213.13	\$221.79	\$240.85	\$247.78
147	\$76.76	\$111.66	\$204.12	\$214.59	\$223.31	\$242.50	\$249.48
148	\$77.29	\$112.41	\$205.51	\$216.05	\$224.83	\$244.15	\$251.18
149	\$77.81	\$113.17	\$206.90	\$217.51	\$226.35	\$245.80	\$252.87
150	\$78.33	\$113.93	\$208.29	\$218.97	\$227.87	\$247.45	\$254.57
Price/Lb.	\$0.52	\$0.75	\$1.38	\$1.45	\$1.51	\$1.64	\$1.69

Any fraction of a pound more than the weight shown in the rate chart is rounded up to the next listed weight.

*UPS offers customized rate sheets identifying its firm offer of rates and prices for transportation rates and prices. The rates and prices identified in the rate sheets will be guaranteed for 12-month periods and increase only with approval by the Lead State. Other fees and charges that may impact an authorized user's invoice are identified in UPS's Rate and Service Guide and as described in UPS's Tariff/Terms and Conditions of Service, in effect at the time of shipping. These fees and charges are subject to change without notice. In accordance with the conditions of the solicitation, UPS has waived all pick-up charges, including on-call/on-demand, and capped fuel surcharges at 7%. Fuel surcharge information is posted on UPS's website, www.ups.com.

NASPO ValuePoint

UPS 2nd Day Air A.M.®

Daily Commercial Rates*

Lbs.	Zone 242	Zone 243	Zone 244	Zone 245	Zone 246	Zone 247	Zone 248
Letter*	\$8.14	\$8.15	\$8.15	\$8.15	\$8.15	\$8.43	\$16.17
1	\$8.16	\$8.16	\$8.16	\$8.16	\$8.49	\$8.87	\$16.18
2	\$8.17	\$8.17	\$8.17	\$8.17	\$9.38	\$10.23	\$16.19
3	\$8.18	\$8.18	\$8.18	\$8.18	\$10.76	\$11.87	\$16.20
4	\$8.19	\$8.19	\$8.19	\$9.30	\$12.45	\$13.53	\$16.22
5	\$8.20	\$8.20	\$8.20	\$10.30	\$13.90	\$14.99	\$16.23
6	\$8.22	\$8.22	\$8.41	\$11.26	\$15.48	\$16.72	\$17.39
7	\$8.23	\$8.23	\$9.11	\$12.32	\$17.39	\$18.54	\$19.13
8	\$8.24	\$8.24	\$9.76	\$13.38	\$19.21	\$20.41	\$21.01
9	\$8.25	\$8.52	\$10.53	\$14.37	\$20.91	\$22.36	\$23.11
10	\$8.26	\$9.07	\$11.32	\$15.37	\$22.30	\$24.34	\$24.97
11	\$8.27	\$9.53	\$11.87	\$16.43	\$24.09	\$26.11	\$27.05
12	\$8.49	\$10.08	\$12.47	\$17.36	\$25.93	\$27.97	\$28.90
13	\$9.07	\$10.62	\$12.96	\$18.42	\$27.64	\$29.31	\$30.58
14	\$9.47	\$11.17	\$13.77	\$19.49	\$29.31	\$30.88	\$31.93
15	\$9.83	\$11.45	\$14.50	\$20.21	\$30.88	\$32.23	\$33.43
16	\$10.08	\$11.82	\$15.08	\$20.89	\$32.23	\$33.90	\$34.79
17	\$10.43	\$12.19	\$15.71	\$21.85	\$33.67	\$35.68	\$36.45
18	\$10.74	\$12.57	\$16.37	\$22.64	\$35.07	\$37.27	\$38.63
19	\$11.17	\$12.92	\$16.83	\$23.56	\$36.36	\$39.01	\$39.89
20	\$11.55	\$13.49	\$17.47	\$24.63	\$37.62	\$40.32	\$41.29
21	\$12.12	\$14.03	\$18.11	\$25.45	\$39.01	\$41.67	\$43.22
22	\$12.45	\$14.66	\$18.61	\$26.16	\$40.28	\$43.25	\$44.83
23	\$12.79	\$14.99	\$19.27	\$26.95	\$41.67	\$44.66	\$46.49
24	\$13.05	\$15.58	\$19.86	\$27.95	\$43.20	\$46.43	\$48.15
25	\$13.49	\$16.06	\$20.28	\$28.96	\$44.61	\$48.08	\$49.82
26	\$13.90	\$16.45	\$21.01	\$29.88	\$46.14	\$49.72	\$51.18
27	\$14.35	\$16.97	\$21.60	\$30.93	\$47.70	\$51.39	\$52.79
28	\$14.79	\$17.54	\$22.00	\$31.69	\$48.88	\$52.71	\$54.08
29	\$15.20	\$17.81	\$22.72	\$32.41	\$50.24	\$54.08	\$55.65
30	\$15.49	\$18.34	\$23.51	\$33.47	\$51.59	\$55.48	\$57.09
31	\$15.94	\$18.89	\$24.14	\$34.23	\$52.79	\$56.73	\$58.57
32	\$16.18	\$19.33	\$24.86	\$35.05	\$54.32	\$58.27	\$60.03
33	\$16.62	\$19.80	\$25.47	\$35.77	\$55.78	\$59.65	\$61.51
34	\$17.15	\$20.21	\$26.04	\$37.08	\$57.51	\$61.07	\$63.04
35	\$17.52	\$20.83	\$26.60	\$37.78	\$60.42	\$62.20	\$64.56
36	\$17.74	\$21.29	\$27.12	\$38.57	\$61.64	\$63.34	\$65.97
37	\$18.09	\$21.61	\$27.80	\$39.56	\$62.91	\$64.43	\$66.81
38	\$18.42	\$21.93	\$28.51	\$40.34	\$64.18	\$65.36	\$67.95
39	\$18.98	\$22.49	\$28.97	\$41.15	\$65.70	\$66.52	\$69.20
40	\$19.49	\$23.07	\$29.63	\$42.11	\$67.13	\$67.95	\$70.71
41	\$19.99	\$23.62	\$30.03	\$42.87	\$68.48	\$69.20	\$72.25

42	\$20.28	\$24.23	\$30.64	\$43.73	\$69.86	\$70.56	\$73.94
43	\$20.73	\$24.71	\$31.07	\$44.47	\$71.11	\$71.99	\$75.55
44	\$21.09	\$25.05	\$31.78	\$45.28	\$72.69	\$73.21	\$77.25
45	\$21.60	\$25.62	\$32.23	\$45.91	\$74.02	\$74.59	\$78.65
46	\$21.83	\$25.93	\$32.89	\$46.62	\$75.33	\$76.05	\$79.90
47	\$22.30	\$26.45	\$33.49	\$47.26	\$76.43	\$77.56	\$81.12
48	\$22.72	\$27.05	\$34.06	\$47.97	\$77.62	\$78.78	\$82.28
49	\$23.18	\$27.70	\$34.65	\$48.80	\$78.84	\$80.06	\$83.05
50	\$23.53	\$28.06	\$35.19	\$49.59	\$78.85	\$80.07	\$83.07
51	\$23.85	\$28.33	\$35.77	\$50.32	\$81.12	\$82.95	\$86.34
52	\$24.14	\$28.79	\$36.45	\$51.53	\$82.28	\$84.64	\$87.98
53	\$24.58	\$29.37	\$36.92	\$52.30	\$83.22	\$86.46	\$89.77
54	\$24.93	\$29.86	\$37.48	\$53.09	\$84.37	\$88.37	\$91.46
55	\$25.42	\$30.33	\$37.97	\$54.08	\$85.59	\$89.62	\$93.03
56	\$25.81	\$30.77	\$38.51	\$54.95	\$86.86	\$91.53	\$94.67
57	\$26.11	\$31.27	\$39.11	\$55.72	\$88.54	\$93.20	\$95.94
58	\$26.60	\$31.78	\$39.85	\$56.65	\$90.38	\$94.95	\$97.70
59	\$26.95	\$32.16	\$40.61	\$57.64	\$92.17	\$96.45	\$99.32
60	\$27.19	\$32.44	\$41.24	\$58.46	\$93.71	\$98.24	\$100.96
61	\$27.70	\$32.89	\$41.78	\$59.21	\$95.37	\$99.89	\$102.71
62	\$28.19	\$33.52	\$42.29	\$60.18	\$97.05	\$101.40	\$104.63
63	\$28.66	\$34.06	\$42.82	\$61.01	\$98.71	\$102.86	\$106.49
64	\$29.17	\$34.60	\$43.29	\$61.81	\$100.40	\$104.81	\$108.36
65	\$29.58	\$35.08	\$43.96	\$62.72	\$101.91	\$106.43	\$109.96
66	\$30.00	\$35.40	\$44.60	\$63.74	\$103.57	\$108.36	\$111.39
67	\$30.22	\$36.08	\$45.28	\$64.78	\$105.09	\$109.96	\$113.04
68	\$30.61	\$36.45	\$45.91	\$65.90	\$106.78	\$111.52	\$114.90
69	\$31.09	\$36.92	\$46.53	\$67.10	\$108.63	\$113.04	\$116.62
70	\$31.58	\$37.50	\$47.26	\$68.27	\$110.43	\$114.57	\$118.62
71	\$31.98	\$38.05	\$47.90	\$69.19	\$111.10	\$115.69	\$120.30
72	\$32.36	\$38.71	\$48.54	\$70.25	\$112.70	\$117.66	\$122.37
73	\$32.68	\$39.06	\$49.19	\$71.42	\$114.17	\$119.50	\$124.60
74	\$33.16	\$39.53	\$49.85	\$72.36	\$115.99	\$121.10	\$126.86
75	\$33.60	\$40.16	\$50.44	\$73.36	\$117.58	\$123.08	\$128.16
76	\$33.95	\$40.64	\$51.06	\$74.20	\$119.18	\$124.92	\$130.44
77	\$34.57	\$41.17	\$51.67	\$75.15	\$120.71	\$126.86	\$132.73
78	\$34.89	\$41.48	\$52.41	\$76.23	\$122.21	\$128.51	\$135.09
79	\$35.31	\$42.00	\$53.11	\$77.33	\$123.82	\$130.31	\$137.10
80	\$35.85	\$42.49	\$53.86	\$78.31	\$125.19	\$132.27	\$138.31
81	\$36.15	\$43.00	\$54.47	\$78.47	\$126.45	\$133.96	\$140.51
82	\$36.54	\$43.53	\$55.07	\$80.35	\$128.12	\$135.89	\$142.26
83	\$36.83	\$44.00	\$55.80	\$81.04	\$129.77	\$137.81	\$144.13
84	\$37.30	\$44.60	\$56.27	\$81.75	\$131.27	\$139.83	\$145.74
85	\$37.75	\$45.19	\$56.88	\$83.05	\$132.88	\$141.63	\$147.52
86	\$38.24	\$45.28	\$57.55	\$84.03	\$134.49	\$143.37	\$149.30
87	\$38.57	\$46.11	\$58.17	\$85.00	\$136.03	\$145.40	\$150.93
88	\$38.88	\$46.67	\$58.88	\$85.75	\$137.56	\$147.03	\$152.65
89	\$39.32	\$47.00	\$59.44	\$86.57	\$139.25	\$148.67	\$154.53
90	\$39.96	\$47.44	\$60.03	\$87.48	\$140.78	\$150.29	\$156.18
91	\$40.55	\$48.05	\$60.18	\$88.61	\$142.31	\$152.03	\$157.93
92	\$41.05	\$48.56	\$61.24	\$89.53	\$144.01	\$153.69	\$159.69
93	\$41.36	\$48.66	\$61.95	\$90.20	\$145.65	\$155.26	\$161.48
94	\$41.73	\$48.66	\$62.03	\$90.20	\$147.21	\$157.06	\$163.12
95	\$42.11	\$48.66	\$63.27	\$90.20	\$148.86	\$158.62	\$164.96

96	\$42.39	\$48.66	\$63.80	\$90.20	\$150.55	\$160.33	\$166.59
97	\$42.82	\$48.66	\$64.09	\$90.20	\$151.91	\$162.04	\$168.33
98	\$43.20	\$48.66	\$64.09	\$90.20	\$151.91	\$163.70	\$168.53
99	\$43.58	\$48.66	\$64.09	\$90.20	\$151.91	\$163.78	\$168.53
100	\$43.91	\$48.66	\$64.09	\$90.20	\$151.91	\$163.78	\$168.53
101	\$44.35	\$49.15	\$64.73	\$91.10	\$153.43	\$165.42	\$170.21
102	\$44.79	\$49.63	\$65.37	\$92.00	\$154.95	\$167.06	\$171.90
103	\$45.23	\$50.12	\$66.01	\$92.90	\$156.47	\$168.69	\$173.58
104	\$45.67	\$50.61	\$66.65	\$93.81	\$157.99	\$170.33	\$175.27
105	\$46.11	\$51.09	\$67.29	\$94.71	\$159.51	\$171.97	\$176.95
106	\$46.55	\$51.58	\$67.93	\$95.61	\$161.03	\$173.61	\$178.64
107	\$46.99	\$52.07	\$68.57	\$96.51	\$162.55	\$175.24	\$180.32
108	\$47.43	\$52.55	\$69.21	\$97.41	\$164.06	\$176.88	\$182.01
109	\$47.86	\$53.04	\$69.86	\$98.32	\$165.58	\$178.52	\$183.69
110	\$48.30	\$53.53	\$70.50	\$99.22	\$167.10	\$180.16	\$185.38
111	\$48.74	\$54.01	\$71.14	\$100.12	\$168.62	\$181.80	\$187.07
112	\$49.18	\$54.50	\$71.78	\$101.02	\$170.14	\$183.43	\$188.75
113	\$49.62	\$54.99	\$72.42	\$101.92	\$171.66	\$185.07	\$190.44
114	\$50.06	\$55.47	\$73.06	\$102.83	\$173.18	\$186.71	\$192.12
115	\$50.50	\$55.96	\$73.70	\$103.73	\$174.70	\$188.35	\$193.81
116	\$50.94	\$56.44	\$74.34	\$104.63	\$176.22	\$189.98	\$195.49
117	\$51.38	\$56.93	\$74.98	\$105.53	\$177.74	\$191.62	\$197.18
118	\$51.82	\$57.42	\$75.62	\$106.43	\$179.26	\$193.26	\$198.86
119	\$52.26	\$57.90	\$76.26	\$107.34	\$180.78	\$194.90	\$200.55
120	\$52.69	\$58.39	\$76.91	\$108.24	\$182.29	\$196.54	\$202.23
121	\$53.13	\$58.88	\$77.55	\$109.14	\$183.81	\$198.17	\$203.92
122	\$53.57	\$59.36	\$78.19	\$110.04	\$185.33	\$199.81	\$205.60
123	\$54.01	\$59.85	\$78.83	\$110.94	\$186.85	\$201.45	\$207.29
124	\$54.45	\$60.34	\$79.47	\$111.85	\$188.37	\$203.09	\$208.97
125	\$54.89	\$60.82	\$80.11	\$112.75	\$189.89	\$204.73	\$210.66
126	\$55.33	\$61.31	\$80.75	\$113.65	\$191.41	\$206.36	\$212.34
127	\$55.77	\$61.80	\$81.39	\$114.55	\$192.93	\$208.00	\$214.03
128	\$56.21	\$62.28	\$82.03	\$115.45	\$194.45	\$209.64	\$215.72
129	\$56.65	\$62.77	\$82.67	\$116.36	\$195.97	\$211.28	\$217.40
130	\$57.09	\$63.26	\$83.31	\$117.26	\$197.49	\$212.91	\$219.09
131	\$57.52	\$63.74	\$83.96	\$118.16	\$199.00	\$214.55	\$220.77
132	\$57.96	\$64.23	\$84.60	\$119.06	\$200.52	\$216.19	\$222.46
133	\$58.40	\$64.72	\$85.24	\$119.96	\$202.04	\$217.83	\$224.14
134	\$58.84	\$65.20	\$85.88	\$120.87	\$203.56	\$219.47	\$225.83
135	\$59.28	\$65.69	\$86.52	\$121.77	\$205.08	\$221.10	\$227.51
136	\$59.72	\$66.18	\$87.16	\$122.67	\$206.60	\$222.74	\$229.20
137	\$60.16	\$66.66	\$87.80	\$123.57	\$208.12	\$224.38	\$230.88
138	\$60.60	\$67.15	\$88.44	\$124.47	\$209.64	\$226.02	\$232.57
139	\$61.04	\$67.64	\$89.08	\$125.37	\$211.16	\$227.65	\$234.25
140	\$61.48	\$68.12	\$89.72	\$126.28	\$212.68	\$229.29	\$235.94
141	\$61.92	\$68.61	\$90.36	\$127.18	\$214.20	\$230.93	\$237.62
142	\$62.36	\$69.10	\$91.00	\$128.08	\$215.72	\$232.57	\$239.31
143	\$62.79	\$69.58	\$91.65	\$128.98	\$217.23	\$234.21	\$240.99
144	\$63.23	\$70.07	\$92.29	\$129.88	\$218.75	\$235.84	\$242.68
145	\$63.67	\$70.56	\$92.93	\$130.79	\$220.27	\$237.48	\$244.36
146	\$64.11	\$71.04	\$93.57	\$131.69	\$221.79	\$239.12	\$246.05
147	\$64.55	\$71.53	\$94.21	\$132.59	\$223.31	\$240.76	\$247.74
148	\$64.99	\$72.02	\$94.85	\$133.49	\$224.83	\$242.39	\$249.42
149	\$65.43	\$72.50	\$95.49	\$134.39	\$226.35	\$244.03	\$251.11

150	\$65.87	\$72.99	\$96.13	\$135.30	\$227.87	\$245.67	\$252.79
Price/Lb.	\$0.44	\$0.48	\$0.64	\$0.90	\$1.51	\$1.63	\$1.67

Any fraction of a pound more than the weight shown in the rate chart is rounded up to the next listed weight.

*UPS offers customized rate sheets identifying its firm offer of rates and prices for transportation rates and prices. The rates and prices identified in the rate sheets will be guaranteed for 12-month periods and increase only with approval by the Lead State. Other fees and charges that may impact an authorized user's invoice are identified in UPS's Rate and Service Guide and as described in UPS's Tariff/Terms and Conditions of Service, in effect at the time of shipping. These fees and charges are subject to change without notice. In accordance with the conditions of the solicitation, UPS has waived all pick-up charges, including on-call/on-demand, and capped fuel surcharges at 7%. Fuel surcharge information is posted on UPS's website, www.ups.com.

NASPO ValuePoint**UPS 2nd Day Air®***(Per Package Rates from 48 State Origin)***Daily Commercial Rates***

								AK, HI	PR	AK, HI +
Lbs.	Zone 202	Zone 203	Zone 204	Zone 205	Zone 206	Zone 207	Zone 208	Zone 224	Zone 225	Zone 226
Letter*	\$8.13	\$8.14	\$8.14	\$8.14	\$8.14	\$8.42	\$16.16	\$16.17	\$16.17	\$16.17
1	\$8.15	\$8.15	\$8.15	\$8.15	\$8.15	\$8.44	\$16.17	\$16.18	\$16.18	\$16.18
2	\$8.16	\$8.16	\$8.16	\$8.16	\$8.16	\$9.74	\$16.18	\$16.19	\$16.19	\$16.19
3	\$8.17	\$8.17	\$8.17	\$8.17	\$10.28	\$11.14	\$16.19	\$16.20	\$16.20	\$16.20
4	\$8.18	\$8.18	\$8.18	\$8.84	\$11.84	\$12.73	\$16.20	\$17.71	\$17.71	\$17.71
5	\$8.19	\$8.19	\$8.19	\$9.81	\$13.22	\$14.08	\$16.22	\$19.19	\$19.19	\$19.19
6	\$8.20	\$8.20	\$8.20	\$10.71	\$14.72	\$15.76	\$16.56	\$20.37	\$20.37	\$20.37
7	\$8.22	\$8.22	\$8.68	\$11.75	\$16.56	\$17.65	\$18.18	\$21.27	\$21.27	\$21.27
8	\$8.23	\$8.23	\$9.27	\$12.76	\$18.27	\$19.48	\$20.02	\$22.36	\$22.36	\$22.36
9	\$8.24	\$8.24	\$10.00	\$13.70	\$19.91	\$21.29	\$21.99	\$23.96	\$23.96	\$23.96
10	\$8.25	\$8.62	\$10.75	\$14.63	\$21.24	\$23.02	\$23.80	\$25.92	\$25.92	\$25.92
11	\$8.26	\$9.09	\$11.30	\$15.63	\$22.94	\$24.63	\$25.65	\$27.44	\$27.44	\$27.44
12	\$8.27	\$9.60	\$11.90	\$16.51	\$24.66	\$26.25	\$27.17	\$28.46	\$28.46	\$28.46
13	\$8.62	\$10.10	\$12.34	\$17.53	\$26.25	\$27.52	\$28.72	\$29.42	\$29.42	\$29.42
14	\$9.04	\$10.62	\$13.11	\$18.55	\$27.52	\$28.96	\$30.06	\$30.57	\$30.57	\$30.57
15	\$9.36	\$10.91	\$13.80	\$19.23	\$28.96	\$30.24	\$31.41	\$31.93	\$31.93	\$31.93
16	\$9.60	\$11.26	\$14.36	\$19.87	\$30.24	\$31.79	\$32.78	\$33.28	\$33.28	\$33.28
17	\$9.92	\$11.58	\$14.97	\$20.82	\$31.62	\$33.48	\$34.30	\$34.88	\$34.88	\$34.88
18	\$10.24	\$11.97	\$15.56	\$21.56	\$33.39	\$34.95	\$36.33	\$36.87	\$36.87	\$36.87
19	\$10.62	\$12.32	\$16.01	\$22.42	\$34.62	\$36.80	\$38.00	\$38.62	\$38.62	\$38.62
20	\$11.00	\$12.85	\$16.62	\$23.49	\$35.85	\$38.35	\$39.33	\$39.95	\$39.95	\$39.95
21	\$11.52	\$13.35	\$17.24	\$24.25	\$37.16	\$39.66	\$41.15	\$41.78	\$41.78	\$41.78
22	\$11.89	\$13.96	\$17.73	\$24.93	\$38.33	\$41.19	\$42.70	\$43.39	\$43.39	\$43.39
23	\$12.19	\$14.29	\$18.36	\$25.65	\$39.66	\$42.54	\$44.30	\$44.98	\$44.98	\$44.98
24	\$12.45	\$14.85	\$18.89	\$26.61	\$41.15	\$44.22	\$45.85	\$46.59	\$46.59	\$46.59
25	\$12.85	\$15.27	\$19.32	\$27.56	\$42.49	\$45.81	\$47.44	\$48.20	\$48.20	\$48.20
26	\$13.22	\$15.65	\$20.02	\$28.46	\$43.92	\$47.33	\$48.69	\$49.49	\$49.49	\$49.49
27	\$13.67	\$16.15	\$20.54	\$29.46	\$45.42	\$48.69	\$50.26	\$51.10	\$51.10	\$51.10
28	\$14.08	\$16.73	\$20.96	\$30.17	\$46.57	\$50.17	\$51.50	\$52.71	\$52.71	\$52.71
29	\$14.50	\$16.98	\$21.65	\$30.88	\$47.89	\$51.48	\$53.00	\$54.05	\$54.05	\$54.05
30	\$14.75	\$17.45	\$22.38	\$31.85	\$49.13	\$52.86	\$54.38	\$55.73	\$55.73	\$55.73
31	\$15.18	\$18.03	\$22.99	\$32.59	\$50.26	\$54.02	\$55.78	\$57.12	\$57.12	\$57.12
32	\$15.40	\$18.42	\$23.67	\$33.37	\$51.71	\$55.47	\$57.17	\$58.96	\$58.96	\$58.96
33	\$15.86	\$18.86	\$24.27	\$34.06	\$53.11	\$56.80	\$58.57	\$60.57	\$60.57	\$60.57
34	\$16.33	\$19.23	\$24.80	\$35.30	\$54.75	\$58.17	\$60.04	\$62.13	\$62.13	\$62.13
35	\$16.71	\$19.81	\$25.35	\$35.98	\$56.35	\$59.65	\$61.51	\$63.79	\$63.79	\$63.79
36	\$16.90	\$20.27	\$25.83	\$36.73	\$57.89	\$61.51	\$63.08	\$65.26	\$65.26	\$65.26
37	\$17.20	\$20.57	\$26.49	\$37.65	\$59.46	\$63.16	\$64.75	\$66.96	\$66.96	\$66.96
38	\$17.53	\$20.90	\$27.15	\$38.43	\$60.99	\$64.82	\$66.52	\$68.48	\$68.48	\$68.48
39	\$18.08	\$21.41	\$27.59	\$39.19	\$62.34	\$66.52	\$68.27	\$70.13	\$70.13	\$70.13
40	\$18.55	\$21.97	\$28.23	\$40.08	\$63.81	\$67.91	\$69.80	\$71.46	\$71.46	\$71.46
41	\$19.04	\$22.48	\$28.59	\$40.84	\$65.17	\$69.16	\$71.66	\$73.06	\$73.06	\$73.06
42	\$19.32	\$23.06	\$29.16	\$41.66	\$66.53	\$70.54	\$73.44	\$74.79	\$74.79	\$74.79
43	\$19.75	\$23.56	\$29.58	\$42.33	\$67.65	\$71.78	\$74.92	\$76.12	\$76.12	\$76.12
44	\$20.10	\$23.84	\$30.26	\$43.11	\$69.01	\$73.19	\$76.44	\$77.65	\$77.65	\$77.65
45	\$20.54	\$24.42	\$30.70	\$43.73	\$70.37	\$74.57	\$77.58	\$78.80	\$78.80	\$78.80
46	\$20.80	\$24.66	\$31.34	\$44.40	\$71.72	\$75.80	\$79.47	\$80.69	\$80.69	\$80.69
47	\$21.24	\$25.17	\$31.88	\$45.00	\$73.06	\$76.05	\$80.96	\$82.25	\$82.25	\$82.25
48	\$21.65	\$25.79	\$32.44	\$45.69	\$74.52	\$78.75	\$82.26	\$83.63	\$83.63	\$83.63
49	\$22.04	\$26.37	\$32.99	\$46.46	\$75.60	\$79.75	\$82.97	\$85.20	\$85.20	\$85.20
50	\$22.41	\$26.72	\$33.53	\$47.25	\$76.95	\$80.05	\$83.05	\$86.57	\$86.57	\$86.57
51	\$22.72	\$26.99	\$34.06	\$47.95	\$78.50	\$82.83	\$86.17	\$88.07	\$88.07	\$88.07
52	\$22.99	\$27.43	\$34.69	\$49.07	\$79.68	\$84.60	\$87.88	\$89.63	\$89.63	\$89.63
53	\$23.42	\$27.97	\$35.15	\$49.82	\$80.96	\$86.23	\$89.31	\$90.73	\$90.73	\$90.73

54	\$23.74	\$28.42	\$35.70	\$50.56	\$82.04	\$87.97	\$90.65	\$92.05	\$92.05	\$92.05
55	\$24.22	\$28.90	\$36.14	\$51.50	\$83.52	\$89.60	\$92.01	\$93.46	\$93.46	\$93.46
56	\$24.56	\$29.29	\$36.67	\$52.31	\$84.62	\$91.00	\$93.63	\$95.12	\$95.12	\$95.12
57	\$24.90	\$29.77	\$37.25	\$53.05	\$85.93	\$92.52	\$95.40	\$96.87	\$96.87	\$96.87
58	\$25.35	\$30.26	\$37.97	\$53.95	\$87.49	\$94.15	\$96.83	\$98.35	\$98.35	\$98.35
59	\$25.65	\$30.62	\$38.68	\$54.90	\$88.90	\$95.69	\$98.37	\$99.94	\$99.94	\$99.94
60	\$25.90	\$30.90	\$39.28	\$55.66	\$90.04	\$97.28	\$99.62	\$101.19	\$101.19	\$101.19
61	\$26.37	\$31.34	\$39.78	\$56.37	\$91.38	\$98.40	\$101.26	\$102.83	\$102.83	\$102.83
62	\$26.85	\$31.90	\$40.27	\$57.28	\$92.69	\$100.06	\$102.98	\$104.62	\$104.62	\$104.62
63	\$27.31	\$32.44	\$40.79	\$58.11	\$94.04	\$101.73	\$104.95	\$106.61	\$106.61	\$106.61
64	\$27.78	\$32.96	\$41.25	\$58.87	\$95.40	\$103.38	\$106.36	\$108.04	\$108.04	\$108.04
65	\$28.17	\$33.43	\$41.86	\$59.74	\$96.83	\$105.07	\$108.26	\$110.01	\$110.01	\$110.01
66	\$28.58	\$33.72	\$42.46	\$60.71	\$98.37	\$106.43	\$110.09	\$114.46	\$114.46	\$114.46
67	\$28.78	\$34.39	\$43.11	\$61.71	\$99.62	\$107.98	\$111.73	\$113.48	\$113.48	\$113.48
68	\$29.15	\$34.69	\$43.73	\$62.75	\$101.26	\$109.42	\$113.14	\$114.92	\$114.92	\$114.92
69	\$29.60	\$35.15	\$44.34	\$63.92	\$102.61	\$110.91	\$115.06	\$116.88	\$116.88	\$116.88
70	\$30.07	\$35.72	\$45.00	\$65.00	\$104.19	\$112.27	\$116.36	\$118.21	\$118.21	\$118.21
71	\$30.44	\$36.21	\$45.59	\$65.90	\$105.75	\$113.57	\$117.93	\$119.81	\$119.81	\$119.81
72	\$30.86	\$36.85	\$46.20	\$66.90	\$107.32	\$115.22	\$119.64	\$121.51	\$121.51	\$121.51
73	\$31.13	\$37.19	\$46.82	\$68.05	\$108.69	\$116.78	\$121.02	\$122.92	\$122.92	\$122.92
74	\$31.57	\$37.61	\$47.46	\$68.91	\$110.36	\$118.57	\$122.88	\$124.84	\$124.84	\$124.84
75	\$32.00	\$38.23	\$48.03	\$69.86	\$111.41	\$120.18	\$124.47	\$126.48	\$126.48	\$126.48
76	\$32.33	\$38.70	\$48.62	\$70.67	\$111.41	\$121.90	\$125.84	\$127.80	\$127.80	\$127.80
77	\$32.92	\$39.21	\$49.21	\$71.59	\$114.09	\$123.33	\$127.42	\$129.41	\$129.41	\$129.41
78	\$33.22	\$39.52	\$49.91	\$72.60	\$115.77	\$124.91	\$127.42	\$130.42	\$130.42	\$130.42
79	\$33.60	\$40.00	\$50.61	\$73.64	\$117.23	\$126.31	\$130.57	\$132.58	\$132.58	\$132.58
80	\$34.13	\$40.47	\$51.31	\$74.58	\$118.41	\$127.89	\$132.13	\$134.24	\$134.24	\$134.24
81	\$34.43	\$40.92	\$51.90	\$74.75	\$119.64	\$129.30	\$132.48	\$135.62	\$135.62	\$135.62
82	\$34.81	\$41.44	\$52.46	\$76.53	\$121.02	\$131.07	\$135.30	\$137.42	\$137.42	\$137.42
83	\$35.07	\$41.91	\$53.12	\$77.14	\$122.44	\$132.80	\$136.86	\$139.02	\$139.02	\$139.02
84	\$35.52	\$42.46	\$53.60	\$77.83	\$123.80	\$134.47	\$138.20	\$140.38	\$140.38	\$140.38
85	\$35.96	\$43.05	\$54.14	\$79.10	\$125.16	\$135.75	\$139.74	\$141.92	\$141.92	\$141.92
86	\$36.45	\$43.11	\$54.80	\$80.04	\$126.40	\$137.12	\$141.40	\$143.59	\$143.59	\$143.59
87	\$36.73	\$43.91	\$55.39	\$80.95	\$127.84	\$138.37	\$142.75	\$144.96	\$144.96	\$144.96
88	\$37.05	\$44.46	\$56.08	\$81.68	\$129.20	\$140.01	\$144.32	\$146.60	\$146.60	\$146.60
89	\$37.44	\$44.75	\$56.61	\$82.45	\$130.57	\$141.61	\$146.12	\$148.38	\$148.38	\$148.38
90	\$38.07	\$45.19	\$57.17	\$83.29	\$132.13	\$142.96	\$147.70	\$150.03	\$150.03	\$150.03
91	\$38.63	\$45.79	\$57.28	\$84.26	\$133.49	\$144.78	\$149.28	\$151.63	\$151.63	\$151.63
92	\$39.07	\$46.23	\$58.34	\$84.26	\$134.87	\$146.36	\$150.83	\$153.19	\$153.19	\$153.19
93	\$39.38	\$46.29	\$59.01	\$84.26	\$136.33	\$147.70	\$152.30	\$154.65	\$154.65	\$154.65
94	\$39.71	\$46.29	\$59.09	\$84.26	\$137.69	\$149.13	\$152.51	\$156.41	\$156.41	\$156.41
95	\$40.08	\$46.29	\$59.34	\$84.26	\$139.12	\$150.63	\$155.26	\$157.72	\$157.72	\$157.72
96	\$40.35	\$46.29	\$59.34	\$84.26	\$140.25	\$152.30	\$156.94	\$159.40	\$159.40	\$159.40
97	\$40.35	\$46.29	\$59.34	\$84.26	\$141.61	\$153.54	\$158.43	\$160.91	\$160.91	\$160.91
98	\$40.35	\$46.29	\$59.34	\$84.26	\$142.96	\$154.29	\$158.66	\$162.27	\$162.27	\$162.27
99	\$40.35	\$46.29	\$59.34	\$84.26	\$143.60	\$154.29	\$158.77	\$162.59	\$162.59	\$162.59
100	\$40.35	\$46.29	\$59.34	\$84.26	\$143.60	\$154.29	\$160.22	\$162.59	\$162.59	\$162.59
101	\$40.76	\$46.75	\$59.93	\$85.11	\$145.04	\$155.83	\$161.82	\$164.22	\$164.22	\$164.22
102	\$41.16	\$47.21	\$60.53	\$85.95	\$146.48	\$157.37	\$163.42	\$165.85	\$165.85	\$165.85
103	\$41.56	\$47.67	\$61.12	\$86.79	\$147.91	\$158.91	\$165.03	\$167.47	\$167.47	\$167.47
104	\$41.97	\$48.14	\$61.71	\$87.63	\$149.35	\$160.46	\$166.63	\$169.10	\$169.10	\$169.10
105	\$42.37	\$48.60	\$62.31	\$88.48	\$150.78	\$162.00	\$168.23	\$170.72	\$170.72	\$170.72
106	\$42.77	\$49.06	\$62.90	\$89.32	\$152.22	\$163.54	\$169.83	\$172.35	\$172.35	\$172.35
107	\$43.18	\$49.53	\$63.49	\$90.16	\$153.66	\$165.09	\$171.44	\$173.97	\$173.97	\$173.97
108	\$43.58	\$49.99	\$64.09	\$91.00	\$155.09	\$166.63	\$173.04	\$175.60	\$175.60	\$175.60
109	\$43.98	\$50.45	\$64.68	\$91.85	\$156.53	\$168.17	\$174.64	\$177.23	\$177.23	\$177.23
110	\$44.39	\$50.91	\$65.27	\$92.69	\$157.96	\$169.71	\$176.24	\$178.85	\$178.85	\$178.85
111	\$44.79	\$51.38	\$65.87	\$93.53	\$159.40	\$171.26	\$177.84	\$180.48	\$180.48	\$180.48
112	\$45.19	\$51.84	\$66.46	\$94.38	\$160.84	\$172.80	\$179.45	\$182.10	\$182.10	\$182.10
113	\$45.60	\$52.30	\$67.05	\$95.22	\$162.27	\$174.34	\$181.05	\$183.73	\$183.73	\$183.73
114	\$46.00	\$52.77	\$67.65	\$96.06	\$163.71	\$175.89	\$182.65	\$185.36	\$185.36	\$185.36
115	\$46.40	\$53.23	\$68.24	\$96.90	\$165.14	\$177.43	\$184.25	\$186.98	\$186.98	\$186.98
116	\$46.81	\$53.69	\$68.84	\$97.75	\$166.58	\$178.97	\$185.85	\$188.61	\$188.61	\$188.61
117	\$47.21	\$54.15	\$69.43	\$98.59	\$168.02	\$180.51	\$187.46	\$190.23	\$190.23	\$190.23
118	\$47.61	\$54.62	\$70.02	\$99.43	\$169.45	\$182.06	\$189.06	\$191.86	\$191.86	\$191.86
119	\$48.02	\$55.08	\$70.62	\$100.27	\$170.89	\$183.60	\$190.66	\$193.49	\$193.49	\$193.49

120	\$48.42	\$55.54	\$71.21	\$101.12	\$172.33	\$185.14	\$192.26	\$195.11	\$195.11	\$195.11
121	\$48.83	\$56.01	\$71.80	\$101.96	\$173.76	\$186.69	\$193.87	\$196.74	\$196.74	\$196.74
122	\$49.23	\$56.47	\$72.40	\$102.80	\$175.20	\$188.23	\$195.47	\$198.36	\$198.36	\$198.36
123	\$49.63	\$56.93	\$72.99	\$103.64	\$176.63	\$189.77	\$197.07	\$199.99	\$199.99	\$199.99
124	\$50.04	\$57.39	\$73.58	\$104.49	\$178.07	\$191.31	\$198.67	\$201.62	\$201.62	\$201.62
125	\$50.44	\$57.86	\$74.18	\$105.33	\$179.51	\$192.86	\$200.27	\$203.24	\$203.24	\$203.24
126	\$50.84	\$58.32	\$74.77	\$106.17	\$180.94	\$194.40	\$201.88	\$204.87	\$204.87	\$204.87
127	\$51.25	\$58.78	\$75.36	\$107.01	\$182.38	\$195.94	\$203.48	\$206.49	\$206.49	\$206.49
128	\$51.65	\$59.25	\$75.96	\$107.86	\$183.81	\$197.49	\$205.08	\$208.12	\$208.12	\$208.12
129	\$52.05	\$59.71	\$76.55	\$108.70	\$185.25	\$199.03	\$206.68	\$209.75	\$209.75	\$209.75
130	\$52.46	\$60.17	\$77.14	\$109.54	\$186.69	\$200.57	\$208.29	\$211.37	\$211.37	\$211.37
131	\$52.86	\$60.63	\$77.74	\$110.39	\$188.12	\$202.11	\$209.89	\$213.00	\$213.00	\$213.00
132	\$53.26	\$61.10	\$78.33	\$111.23	\$189.56	\$203.66	\$211.49	\$214.62	\$214.62	\$214.62
133	\$53.67	\$61.56	\$78.92	\$112.07	\$190.99	\$205.20	\$213.09	\$216.25	\$216.25	\$216.25
134	\$54.07	\$62.02	\$79.52	\$112.91	\$192.43	\$206.74	\$214.69	\$217.88	\$217.88	\$217.88
135	\$54.47	\$62.49	\$80.11	\$113.76	\$193.87	\$208.29	\$216.30	\$219.50	\$219.50	\$219.50
136	\$54.88	\$62.95	\$80.70	\$114.60	\$195.30	\$209.83	\$217.90	\$221.13	\$221.13	\$221.13
137	\$55.28	\$63.41	\$81.30	\$115.44	\$196.74	\$211.37	\$219.50	\$222.75	\$222.75	\$222.75
138	\$55.69	\$63.87	\$81.89	\$116.28	\$198.17	\$212.91	\$221.10	\$224.38	\$224.38	\$224.38
139	\$56.09	\$64.34	\$82.48	\$117.13	\$199.61	\$214.46	\$222.71	\$226.00	\$226.00	\$226.00
140	\$56.49	\$64.80	\$83.08	\$117.97	\$201.05	\$216.00	\$224.31	\$227.63	\$227.63	\$227.63
141	\$56.90	\$65.26	\$83.67	\$118.81	\$202.48	\$217.54	\$225.91	\$229.26	\$229.26	\$229.26
142	\$57.30	\$65.73	\$84.26	\$119.65	\$203.92	\$219.09	\$227.51	\$230.88	\$230.88	\$230.88
143	\$57.70	\$66.19	\$84.86	\$120.50	\$205.35	\$220.63	\$229.11	\$232.51	\$232.51	\$232.51
144	\$58.11	\$66.65	\$85.45	\$121.34	\$206.79	\$222.17	\$230.72	\$234.13	\$234.13	\$234.13
145	\$58.51	\$67.11	\$86.04	\$122.18	\$208.23	\$223.71	\$232.32	\$235.76	\$235.76	\$235.76
146	\$58.91	\$67.58	\$86.64	\$123.03	\$209.66	\$225.26	\$233.92	\$237.39	\$237.39	\$237.39
147	\$59.32	\$68.04	\$87.23	\$123.87	\$211.10	\$226.80	\$235.52	\$239.01	\$239.01	\$239.01
148	\$59.72	\$68.50	\$87.82	\$124.71	\$212.53	\$228.34	\$237.13	\$240.64	\$240.64	\$240.64
149	\$60.12	\$68.97	\$88.42	\$125.55	\$213.97	\$229.89	\$238.73	\$242.26	\$242.26	\$242.26
150	\$60.53	\$69.43	\$89.01	\$126.40	\$215.41	\$231.43	\$240.33	\$243.89	\$243.89	\$243.89
Price/Lb.	\$0.40	\$0.46	\$0.59	\$0.84	\$1.43	\$1.53	\$1.59	\$1.62	\$1.62	\$1.62

Any fraction of a pound more than the weight shown in the rate chart is rounded up to the next listed weight.

*UPS offers customized rate sheets identifying its firm offer of rates and prices for transportation rates and prices. The rates and prices identified in the rate sheets will be guaranteed for 12-month periods and increase only with approval by the Lead State. Other fees and charges that may impact an authorized user's invoice are identified in UPS's Rate and Service Guide and as described in UPS's Tariff/Terms and Conditions of Service, in effect at the time of shipping. These fees and charges are subject to change without notice. In accordance with the conditions of the solicitation, UPS has waived all pick-up charges, including on-call/on-demand, and capped fuel surcharges at 7%. Fuel surcharge information is posted on UPS's website, www.ups.com.

NASPO ValuePoint**UPS 3 Day Select®****Daily Commercial Rates***

Lbs.	Zone 302	Zone 303	Zone 304	Zone 305	Zone 306	Zone 307	Zone 308
1	\$6.27	\$6.27	\$6.27	\$6.41	\$6.76	\$7.14	\$7.92
2	\$6.27	\$6.27	\$6.27	\$6.62	\$7.74	\$8.36	\$9.20
3	\$6.27	\$6.27	\$6.37	\$7.23	\$8.88	\$9.35	\$10.43
4	\$6.27	\$6.27	\$6.62	\$8.43	\$9.84	\$10.63	\$11.93
5	\$6.27	\$6.33	\$6.98	\$9.33	\$11.17	\$11.75	\$13.38
6	\$6.33	\$6.62	\$7.61	\$10.19	\$12.44	\$13.08	\$15.10
7	\$6.62	\$6.76	\$8.24	\$11.16	\$13.83	\$14.75	\$16.59
8	\$6.62	\$7.38	\$8.81	\$12.11	\$15.14	\$16.16	\$18.22
9	\$6.62	\$7.73	\$9.51	\$13.01	\$16.48	\$17.71	\$19.82
10	\$6.97	\$8.18	\$10.23	\$13.91	\$17.42	\$19.01	\$21.43
11	\$7.26	\$8.62	\$10.71	\$14.86	\$18.56	\$20.39	\$22.81
12	\$7.69	\$9.13	\$11.31	\$15.67	\$19.81	\$21.72	\$24.18
13	\$8.18	\$9.60	\$11.74	\$16.66	\$20.94	\$22.85	\$25.54
14	\$8.57	\$10.08	\$12.45	\$17.65	\$21.99	\$24.07	\$26.82
15	\$8.88	\$10.37	\$13.08	\$18.27	\$23.20	\$25.09	\$28.04
16	\$9.13	\$10.68	\$13.64	\$18.87	\$24.14	\$26.32	\$29.27
17	\$9.41	\$11.04	\$14.24	\$19.76	\$25.05	\$27.66	\$30.80
18	\$9.74	\$11.37	\$14.79	\$20.47	\$25.88	\$28.97	\$32.42
19	\$10.08	\$11.68	\$15.21	\$21.32	\$26.79	\$30.24	\$33.60
20	\$10.47	\$12.21	\$15.78	\$22.30	\$27.77	\$31.44	\$34.95
21	\$10.97	\$12.71	\$16.39	\$23.02	\$28.51	\$32.61	\$36.10
22	\$11.29	\$13.27	\$16.84	\$23.69	\$29.58	\$33.72	\$37.42
23	\$11.57	\$13.58	\$17.43	\$24.40	\$30.51	\$34.82	\$38.69
24	\$11.84	\$14.09	\$17.99	\$25.28	\$31.65	\$35.97	\$40.01
25	\$12.21	\$14.53	\$18.36	\$26.16	\$32.61	\$37.27	\$41.25
26	\$12.56	\$14.89	\$19.01	\$27.02	\$33.69	\$38.46	\$42.48
27	\$12.97	\$15.35	\$19.52	\$28.00	\$34.92	\$39.83	\$43.85
28	\$13.36	\$15.89	\$19.93	\$28.66	\$36.07	\$41.09	\$45.18
29	\$13.74	\$16.13	\$20.56	\$29.33	\$37.08	\$42.23	\$46.63
30	\$14.02	\$16.58	\$21.26	\$30.26	\$38.29	\$43.37	\$47.96
31	\$14.38	\$17.10	\$21.84	\$30.95	\$39.47	\$44.65	\$49.32
32	\$14.63	\$17.49	\$22.47	\$31.70	\$40.45	\$45.88	\$50.70
33	\$15.03	\$17.91	\$23.05	\$32.34	\$41.57	\$47.03	\$51.99
34	\$15.52	\$18.27	\$23.56	\$33.53	\$42.71	\$48.23	\$53.56
35	\$15.88	\$18.82	\$24.08	\$34.19	\$43.69	\$49.40	\$54.82
36	\$16.06	\$19.26	\$24.52	\$34.90	\$44.81	\$50.44	\$56.11
37	\$16.37	\$19.55	\$25.15	\$35.79	\$45.74	\$51.45	\$57.36
38	\$16.66	\$19.83	\$25.80	\$36.51	\$46.69	\$52.41	\$58.46
39	\$17.15	\$20.34	\$26.20	\$37.22	\$47.76	\$53.43	\$59.61
40	\$17.65	\$20.89	\$26.80	\$38.08	\$48.84	\$54.45	\$60.67
41	\$18.09	\$21.35	\$27.17	\$38.77	\$49.63	\$55.58	\$61.99
42	\$18.36	\$21.92	\$27.71	\$39.58	\$50.74	\$56.74	\$63.30
43	\$18.75	\$22.37	\$28.12	\$40.24	\$51.69	\$57.99	\$64.74
44	\$19.10	\$22.66	\$28.73	\$40.95	\$52.77	\$59.22	\$66.14
45	\$19.52	\$23.19	\$29.15	\$41.54	\$53.76	\$60.46	\$67.48
46	\$19.75	\$23.45	\$29.75	\$42.19	\$54.82	\$61.64	\$69.05
47	\$20.18	\$23.90	\$30.29	\$42.76	\$56.11	\$62.90	\$70.54
48	\$20.56	\$24.48	\$30.82	\$43.38	\$57.45	\$64.09	\$71.92
49	\$20.95	\$25.07	\$31.36	\$44.13	\$58.78	\$65.48	\$73.38
50	\$21.29	\$25.39	\$31.85	\$44.86	\$59.92	\$66.79	\$74.73
51	\$21.61	\$25.64	\$32.34	\$45.51	\$60.98	\$68.11	\$75.87

52	\$21.84	\$26.05	\$32.97	\$46.62	\$61.88	\$69.38	\$77.07
53	\$22.26	\$26.57	\$33.43	\$47.32	\$62.97	\$70.69	\$78.54
54	\$22.54	\$27.00	\$33.91	\$48.03	\$63.93	\$71.99	\$79.86
55	\$22.99	\$27.44	\$34.35	\$48.91	\$64.91	\$73.35	\$81.33
56	\$23.33	\$27.83	\$34.84	\$49.70	\$65.82	\$74.73	\$82.85
57	\$23.64	\$28.27	\$35.40	\$50.43	\$66.94	\$76.02	\$84.31
58	\$24.08	\$28.73	\$36.04	\$51.26	\$68.05	\$77.46	\$85.59
59	\$24.40	\$29.08	\$36.73	\$52.17	\$69.20	\$78.83	\$87.24
60	\$24.58	\$29.36	\$37.31	\$52.90	\$70.43	\$80.04	\$88.80
61	\$25.07	\$29.75	\$37.80	\$53.56	\$71.62	\$81.36	\$90.25
62	\$25.49	\$30.31	\$38.24	\$54.43	\$72.85	\$82.73	\$91.78
63	\$25.94	\$30.82	\$38.74	\$55.19	\$74.01	\$84.05	\$93.21
64	\$26.39	\$31.31	\$39.20	\$55.92	\$75.33	\$85.44	\$94.73
65	\$26.76	\$31.74	\$39.75	\$56.75	\$76.53	\$86.78	\$96.08
66	\$27.13	\$32.01	\$40.34	\$57.66	\$77.62	\$88.07	\$97.65
67	\$27.36	\$32.65	\$40.95	\$58.59	\$78.85	\$89.43	\$99.19
68	\$27.69	\$32.97	\$41.54	\$59.63	\$79.92	\$90.76	\$100.70
69	\$28.14	\$33.43	\$42.11	\$60.69	\$81.05	\$92.06	\$102.22
70	\$28.58	\$33.92	\$42.76	\$61.77	\$82.19	\$93.30	\$103.73
71	\$28.95	\$34.41	\$43.28	\$62.59	\$83.12	\$94.46	\$105.09
72	\$29.29	\$35.02	\$43.89	\$63.57	\$84.31	\$95.75	\$106.52
73	\$29.56	\$35.34	\$44.49	\$64.62	\$85.44	\$97.12	\$107.95
74	\$30.00	\$35.75	\$45.10	\$65.46	\$86.54	\$98.35	\$109.34
75	\$30.39	\$36.35	\$45.64	\$66.37	\$87.63	\$99.48	\$110.85
76	\$30.73	\$36.76	\$46.18	\$67.13	\$88.75	\$100.62	\$112.06
77	\$31.27	\$37.24	\$46.74	\$68.00	\$89.90	\$101.83	\$113.51
78	\$31.55	\$37.52	\$47.43	\$68.97	\$90.91	\$103.15	\$114.94
79	\$31.91	\$38.03	\$48.05	\$69.95	\$92.05	\$104.49	\$116.20
80	\$32.44	\$38.46	\$48.73	\$70.84	\$93.21	\$105.65	\$117.66
81	\$32.73	\$38.89	\$49.31	\$71.00	\$94.34	\$106.91	\$118.89
82	\$33.08	\$39.37	\$49.83	\$72.68	\$95.43	\$108.32	\$120.43
83	\$33.30	\$39.83	\$50.49	\$73.31	\$96.55	\$109.42	\$121.89
84	\$33.75	\$40.34	\$50.91	\$73.95	\$97.71	\$110.78	\$123.07
85	\$34.16	\$40.87	\$51.44	\$75.15	\$98.75	\$111.80	\$124.52
86	\$34.61	\$40.95	\$52.05	\$76.05	\$99.93	\$112.94	\$125.96
87	\$34.90	\$41.72	\$52.64	\$76.91	\$101.03	\$114.05	\$127.10
88	\$35.14	\$42.23	\$53.30	\$77.58	\$101.92	\$115.32	\$128.57
89	\$35.58	\$42.49	\$53.77	\$78.32	\$103.07	\$116.66	\$129.97
90	\$36.14	\$42.94	\$54.33	\$78.33	\$104.21	\$117.92	\$131.40
91	\$36.68	\$43.47	\$54.43	\$78.33	\$105.34	\$119.22	\$132.88
92	\$37.15	\$43.91	\$55.42	\$78.33	\$106.36	\$120.51	\$134.34
93	\$37.42	\$44.54	\$56.07	\$78.33	\$107.42	\$121.68	\$135.55
94	\$37.74	\$44.61	\$56.12	\$78.33	\$108.58	\$122.87	\$137.08
95	\$38.08	\$44.67	\$57.20	\$78.33	\$109.66	\$124.20	\$138.28
96	\$38.33	\$45.45	\$57.71	\$78.33	\$110.75	\$125.37	\$139.74
97	\$38.74	\$45.50	\$58.26	\$78.33	\$112.04	\$126.55	\$141.14
98	\$39.07	\$45.59	\$58.60	\$78.33	\$112.75	\$127.65	\$142.32
99	\$39.40	\$45.64	\$58.84	\$78.33	\$112.75	\$128.86	\$143.49
100	\$40.35	\$52.22	\$64.09	\$78.33	\$112.75	\$130.55	\$145.98
101	\$40.76	\$52.74	\$64.73	\$79.11	\$113.87	\$131.85	\$147.44
102	\$41.16	\$53.26	\$65.37	\$79.90	\$115.00	\$133.16	\$148.90
103	\$41.56	\$53.79	\$66.01	\$80.68	\$116.13	\$134.47	\$150.36
104	\$41.97	\$54.31	\$66.65	\$81.46	\$117.26	\$135.77	\$151.82
105	\$42.37	\$54.83	\$67.29	\$82.25	\$118.38	\$137.08	\$153.28
106	\$42.77	\$55.35	\$67.93	\$83.03	\$119.51	\$138.38	\$154.74
107	\$43.18	\$55.88	\$68.57	\$83.81	\$120.64	\$139.69	\$156.20
108	\$43.58	\$56.40	\$69.21	\$84.60	\$121.77	\$140.99	\$157.66
109	\$43.98	\$56.92	\$69.86	\$85.38	\$122.89	\$142.30	\$159.12
110	\$44.39	\$57.44	\$70.50	\$86.16	\$124.02	\$143.60	\$160.58
111	\$44.79	\$57.96	\$71.14	\$86.95	\$125.15	\$144.91	\$162.04
112	\$45.19	\$58.49	\$71.78	\$87.73	\$126.28	\$146.22	\$163.50
113	\$45.60	\$59.01	\$72.42	\$88.51	\$127.40	\$147.52	\$164.96
114	\$46.00	\$59.53	\$73.06	\$89.30	\$128.53	\$148.83	\$166.41
115	\$46.40	\$60.05	\$73.70	\$90.08	\$129.66	\$150.13	\$167.87

116	\$46.81	\$60.57	\$74.34	\$90.86	\$130.79	\$151.44	\$169.33
117	\$47.21	\$61.10	\$74.98	\$91.65	\$131.91	\$152.74	\$170.79
118	\$47.61	\$61.62	\$75.62	\$92.43	\$133.04	\$154.05	\$172.25
119	\$48.02	\$62.14	\$76.26	\$93.21	\$134.17	\$155.35	\$173.71
120	\$48.42	\$62.66	\$76.91	\$94.00	\$135.30	\$156.66	\$175.17
121	\$48.83	\$63.19	\$77.55	\$94.78	\$136.42	\$157.96	\$176.63
122	\$49.23	\$63.71	\$78.19	\$95.56	\$137.55	\$159.27	\$178.09
123	\$49.63	\$64.23	\$78.83	\$96.35	\$138.68	\$160.58	\$179.55
124	\$50.04	\$64.75	\$79.47	\$97.13	\$139.81	\$161.88	\$181.01
125	\$50.44	\$65.27	\$80.11	\$97.91	\$140.93	\$163.19	\$182.47
126	\$50.84	\$65.80	\$80.75	\$98.70	\$142.06	\$164.49	\$183.93
127	\$51.25	\$66.32	\$81.39	\$99.48	\$143.19	\$165.80	\$185.39
128	\$51.65	\$66.84	\$82.03	\$100.26	\$144.32	\$167.10	\$186.85
129	\$52.05	\$67.36	\$82.67	\$101.05	\$145.44	\$168.41	\$188.31
130	\$52.46	\$67.89	\$83.31	\$101.83	\$146.57	\$169.71	\$189.77
131	\$52.86	\$68.41	\$83.96	\$102.61	\$147.70	\$171.02	\$191.23
132	\$53.26	\$68.93	\$84.60	\$103.40	\$148.83	\$172.33	\$192.69
133	\$53.67	\$69.45	\$85.24	\$104.18	\$149.95	\$173.63	\$194.15
134	\$54.07	\$69.97	\$85.88	\$104.96	\$151.08	\$174.94	\$195.61
135	\$54.47	\$70.50	\$86.52	\$105.75	\$152.21	\$176.24	\$197.07
136	\$54.88	\$71.02	\$87.16	\$106.53	\$153.34	\$177.55	\$198.53
137	\$55.28	\$71.54	\$87.80	\$107.31	\$154.46	\$178.85	\$199.99
138	\$55.69	\$72.06	\$88.44	\$108.09	\$155.59	\$180.16	\$201.45
139	\$56.09	\$72.59	\$89.08	\$108.88	\$156.72	\$181.46	\$202.91
140	\$56.49	\$73.11	\$89.72	\$109.66	\$157.85	\$182.77	\$204.37
141	\$56.90	\$73.63	\$90.36	\$110.44	\$158.97	\$184.07	\$205.83
142	\$57.30	\$74.15	\$91.00	\$111.23	\$160.10	\$185.38	\$207.29
143	\$57.70	\$74.67	\$91.65	\$112.01	\$161.23	\$186.69	\$208.75
144	\$58.11	\$75.20	\$92.29	\$112.79	\$162.36	\$187.99	\$210.21
145	\$58.51	\$75.72	\$92.93	\$113.58	\$163.48	\$189.30	\$211.67
146	\$58.91	\$76.24	\$93.57	\$114.36	\$164.61	\$190.60	\$213.13
147	\$59.32	\$76.76	\$94.21	\$115.14	\$165.74	\$191.91	\$214.59
148	\$59.72	\$77.29	\$94.85	\$115.93	\$166.87	\$193.21	\$216.05
149	\$60.12	\$77.81	\$95.49	\$116.71	\$167.99	\$194.52	\$217.51
150	\$60.53	\$78.33	\$96.13	\$117.49	\$169.12	\$195.82	\$218.97
Price/Lb.	\$0.40	\$0.52	\$0.64	\$0.78	\$1.12	\$1.30	\$1.45

Any fraction of a pound more than the weight shown in the rate chart is rounded up to the next listed weight.

*UPS offers customized rate sheets identifying its firm offer of rates and prices for transportation rates and prices. The rates and prices identified in the rate sheets will be guaranteed for 12-month periods and increase only with approval by the Lead State. Other fees and charges that may impact an authorized user's invoice are identified in UPS's Rate and Service Guide and as described in UPS's Tariff/Terms and Conditions of Service, in effect at the time of shipping. These fees and charges are subject to change without notice. In accordance with the conditions of the solicitation, UPS has waived all pick-up charges, including on-call/on-demand, and capped fuel surcharges at 7%. Fuel surcharge information is posted on UPS's website, www.ups.com.

NASPO ValuePoint**UPS® Ground****Daily Commercial Rates***

								AK, HI Zone 44	PR Zone 45	AK, HI + Zone 46
Lbs.	Zone 2	Zone 3	Zone 4	Zone 5	Zone 6	Zone 7	Zone 8			
1	\$5.27	\$5.29	\$5.76	\$6.02	\$6.23	\$6.30	\$6.40	\$19.02	\$19.56	\$25.06
2	\$6.08	\$6.09	\$6.59	\$6.73	\$7.02	\$7.29	\$7.41	\$21.16	\$21.90	\$27.19
3	\$6.41	\$6.42	\$6.94	\$7.23	\$7.53	\$7.78	\$8.16	\$22.99	\$24.95	\$28.95
4	\$6.45	\$6.46	\$7.16	\$7.63	\$7.84	\$8.35	\$8.74	\$25.25	\$26.59	\$31.41
5	\$6.75	\$6.76	\$7.41	\$7.97	\$8.31	\$8.73	\$9.32	\$27.37	\$28.87	\$33.41
6	\$6.83	\$6.84	\$7.48	\$8.08	\$8.38	\$8.83	\$9.36	\$29.54	\$30.72	\$34.69
7	\$7.00	\$7.01	\$7.68	\$8.34	\$8.54	\$9.07	\$9.71	\$31.54	\$33.11	\$36.47
8	\$7.06	\$7.26	\$7.96	\$8.58	\$8.88	\$9.44	\$10.14	\$32.58	\$34.83	\$38.25
9	\$7.12	\$7.36	\$8.06	\$8.65	\$9.07	\$9.83	\$10.68	\$34.88	\$37.25	\$40.53
10	\$7.18	\$7.44	\$8.14	\$8.89	\$9.17	\$10.30	\$11.38	\$37.06	\$40.44	\$42.71
11	\$7.28	\$7.58	\$8.30	\$8.93	\$9.47	\$11.14	\$12.11	\$38.96	\$42.81	\$44.63
12	\$7.40	\$7.90	\$8.39	\$9.05	\$9.80	\$11.59	\$12.68	\$40.63	\$44.38	\$46.28
13	\$7.44	\$7.94	\$8.48	\$9.23	\$10.11	\$12.41	\$13.38	\$42.31	\$45.99	\$47.94
14	\$7.71	\$8.15	\$8.57	\$9.46	\$10.69	\$13.18	\$14.39	\$44.06	\$47.78	\$49.67
15	\$7.71	\$8.33	\$8.69	\$9.79	\$11.29	\$13.60	\$15.14	\$45.69	\$49.95	\$51.26
16	\$7.91	\$8.57	\$8.85	\$9.96	\$11.65	\$14.30	\$15.71	\$47.73	\$52.04	\$53.30
17	\$7.97	\$8.74	\$8.95	\$10.24	\$12.14	\$15.03	\$16.04	\$49.76	\$54.53	\$54.99
18	\$8.05	\$8.87	\$9.04	\$10.73	\$12.78	\$15.48	\$17.14	\$51.82	\$57.77	\$57.03
19	\$8.25	\$9.27	\$9.50	\$11.20	\$13.11	\$15.91	\$17.73	\$53.86	\$59.63	\$59.06
20	\$8.31	\$9.35	\$9.55	\$11.64	\$13.56	\$16.49	\$18.55	\$55.66	\$61.81	\$60.83
21	\$8.61	\$9.71	\$10.05	\$11.77	\$14.11	\$17.12	\$19.12	\$56.94	\$64.64	\$62.10
22	\$8.64	\$9.81	\$10.33	\$12.21	\$14.68	\$17.75	\$19.95	\$58.72	\$67.10	\$63.88
23	\$8.67	\$10.00	\$10.66	\$12.56	\$15.39	\$18.34	\$20.74	\$60.50	\$69.56	\$65.65
24	\$8.90	\$10.40	\$11.11	\$13.08	\$15.97	\$18.78	\$21.93	\$62.48	\$72.10	\$67.63
25	\$9.01	\$10.52	\$11.24	\$13.33	\$16.27	\$19.60	\$22.36	\$64.42	\$74.61	\$69.58
26	\$9.44	\$10.88	\$11.71	\$13.88	\$16.86	\$20.41	\$23.28	\$66.45	\$76.53	\$71.76
27	\$9.67	\$11.14	\$11.83	\$14.11	\$17.52	\$20.78	\$23.67	\$68.29	\$79.05	\$73.64
28	\$9.93	\$11.40	\$12.49	\$15.02	\$18.39	\$21.71	\$24.81	\$70.13	\$81.62	\$75.49
29	\$9.96	\$11.62	\$12.72	\$15.08	\$18.92	\$22.41	\$25.23	\$71.84	\$83.64	\$77.00
30	\$10.15	\$11.90	\$13.21	\$15.67	\$19.20	\$22.52	\$26.29	\$73.56	\$86.27	\$78.75
31	\$10.50	\$12.19	\$13.38	\$15.75	\$19.62	\$23.17	\$27.18	\$73.58	\$88.41	\$78.80
32	\$10.51	\$12.19	\$13.38	\$15.76	\$19.81	\$23.19	\$27.73	\$74.19	\$91.23	\$79.35
33	\$10.57	\$12.38	\$13.98	\$16.50	\$20.85	\$23.95	\$28.21	\$75.74	\$93.64	\$80.93
34	\$10.64	\$12.65	\$14.43	\$17.08	\$21.10	\$24.67	\$29.57	\$77.43	\$96.15	\$82.59
35	\$10.83	\$13.32	\$14.76	\$17.49	\$21.41	\$25.31	\$30.06	\$79.35	\$98.72	\$84.50
36	\$11.00	\$13.33	\$15.02	\$18.09	\$22.31	\$26.17	\$30.94	\$81.05	\$101.06	\$86.37
37	\$11.15	\$13.50	\$15.32	\$18.49	\$22.41	\$27.01	\$31.25	\$82.90	\$103.62	\$88.26
38	\$11.33	\$13.71	\$15.66	\$18.93	\$22.92	\$27.37	\$31.83	\$84.89	\$106.04	\$90.25
39	\$11.71	\$14.25	\$16.17	\$19.34	\$23.74	\$28.19	\$32.48	\$86.72	\$108.53	\$91.93
40	\$11.72	\$14.31	\$16.22	\$19.37	\$23.99	\$28.19	\$32.71	\$88.58	\$110.73	\$93.74
41	\$11.87	\$14.78	\$16.66	\$20.03	\$24.76	\$29.07	\$33.72	\$90.09	\$113.12	\$95.44
42	\$11.94	\$14.97	\$17.30	\$20.10	\$25.11	\$29.55	\$33.89	\$91.79	\$115.69	\$97.13
43	\$12.21	\$15.18	\$17.33	\$21.12	\$26.22	\$30.62	\$34.81	\$93.66	\$117.92	\$99.01
44	\$12.39	\$15.42	\$17.77	\$21.49	\$26.44	\$31.28	\$35.18	\$95.01	\$120.20	\$100.91
45	\$12.40	\$15.42	\$17.77	\$21.50	\$26.63	\$32.20	\$35.43	\$96.84	\$121.99	\$102.76
46	\$12.67	\$15.58	\$18.34	\$22.11	\$27.33	\$32.54	\$36.36	\$98.70	\$124.94	\$104.64
47	\$12.72	\$15.78	\$18.64	\$22.27	\$27.70	\$33.18	\$36.95	\$100.60	\$127.32	\$106.53
48	\$12.73	\$15.81	\$18.81	\$22.87	\$28.11	\$33.48	\$37.53	\$102.32	\$129.50	\$108.28
49	\$12.74	\$15.84	\$18.87	\$22.87	\$28.32	\$34.07	\$37.75	\$104.07	\$131.92	\$110.06
50	\$12.74	\$15.87	\$18.87	\$22.90	\$28.33	\$34.15	\$37.96	\$105.82	\$131.97	\$111.82
51	\$12.78	\$15.90	\$18.92	\$22.94	\$28.36	\$34.19	\$38.40	\$107.57	\$136.42	\$114.63
52	\$12.78	\$15.93	\$18.93	\$22.95	\$28.37	\$34.20	\$38.41	\$107.79	\$136.71	\$114.84
53	\$12.79	\$15.96	\$18.93	\$22.98	\$28.37	\$34.21	\$38.78	\$109.41	\$138.74	\$116.48

54	\$12.79	\$15.99	\$18.97	\$23.12	\$28.38	\$34.21	\$38.81	\$110.96	\$140.46	\$118.24
55	\$12.80	\$16.01	\$18.98	\$23.24	\$28.41	\$34.22	\$38.84	\$112.45	\$144.70	\$120.02
56	\$12.81	\$16.04	\$19.00	\$23.24	\$28.41	\$34.25	\$39.28	\$113.97	\$145.13	\$121.76
57	\$13.03	\$16.09	\$19.05	\$23.94	\$28.44	\$34.28	\$39.68	\$115.54	\$147.76	\$123.65
58	\$13.04	\$16.10	\$19.07	\$23.97	\$28.45	\$34.30	\$40.39	\$117.06	\$150.23	\$125.40
59	\$13.15	\$16.11	\$19.31	\$23.97	\$28.87	\$34.33	\$40.68	\$118.84	\$152.26	\$127.26
60	\$13.41	\$16.73	\$19.63	\$24.81	\$29.14	\$34.49	\$40.94	\$120.69	\$154.13	\$129.14
61	\$13.42	\$16.78	\$19.66	\$24.88	\$29.40	\$34.69	\$41.19	\$122.18	\$156.89	\$130.68
62	\$13.97	\$17.97	\$20.15	\$25.59	\$29.59	\$35.22	\$41.45	\$124.19	\$160.16	\$132.72
63	\$13.97	\$17.98	\$20.35	\$25.60	\$29.79	\$35.29	\$41.70	\$126.22	\$162.77	\$134.81
64	\$14.35	\$18.16	\$20.68	\$25.63	\$30.28	\$35.52	\$42.34	\$128.32	\$164.84	\$136.97
65	\$14.50	\$18.64	\$20.69	\$25.66	\$30.54	\$35.60	\$42.41	\$130.42	\$167.70	\$139.14
66	\$14.71	\$18.65	\$20.69	\$25.67	\$30.56	\$35.71	\$42.59	\$132.43	\$170.58	\$141.20
67	\$14.71	\$18.68	\$20.72	\$25.70	\$30.80	\$35.89	\$42.62	\$134.44	\$171.18	\$143.29
68	\$14.88	\$19.18	\$21.94	\$26.23	\$30.97	\$36.10	\$42.65	\$136.38	\$175.69	\$145.26
69	\$15.04	\$19.18	\$21.95	\$26.44	\$31.14	\$36.13	\$42.82	\$138.37	\$178.21	\$147.30
70	\$15.12	\$19.45	\$22.42	\$27.43	\$31.76	\$36.15	\$43.19	\$141.27	\$180.36	\$149.11
71	\$15.15	\$19.49	\$22.82	\$27.48	\$32.32	\$37.10	\$43.28	\$143.72	\$180.87	\$152.05
72	\$15.59	\$19.49	\$23.30	\$27.48	\$32.55	\$38.32	\$43.58	\$145.86	\$181.29	\$154.23
73	\$15.68	\$19.69	\$23.30	\$27.89	\$32.60	\$38.33	\$43.66	\$148.00	\$183.20	\$156.41
74	\$16.25	\$19.69	\$23.31	\$27.90	\$33.41	\$38.75	\$43.75	\$149.42	\$192.32	\$156.91
75	\$17.02	\$19.89	\$23.31	\$28.38	\$33.72	\$39.14	\$43.77	\$151.11	\$192.88	\$158.03
76	\$18.16	\$20.99	\$23.46	\$28.82	\$34.15	\$39.78	\$43.80	\$152.98	\$192.96	\$159.92
77	\$18.87	\$21.30	\$23.95	\$28.95	\$34.35	\$40.54	\$43.82	\$154.24	\$193.58	\$160.85
78	\$18.89	\$22.10	\$24.66	\$29.26	\$34.56	\$41.22	\$43.85	\$155.07	\$194.21	\$162.02
79	\$19.92	\$22.81	\$25.04	\$29.72	\$35.28	\$41.86	\$44.50	\$155.10	\$199.62	\$162.47
80	\$20.28	\$23.46	\$25.39	\$30.43	\$35.88	\$42.04	\$44.84	\$156.71	\$201.60	\$163.31
81	\$20.77	\$23.65	\$26.00	\$30.63	\$36.34	\$42.68	\$45.41	\$158.02	\$201.88	\$164.14
82	\$21.44	\$24.41	\$27.09	\$31.21	\$36.43	\$43.78	\$45.41	\$158.81	\$204.42	\$164.90
83	\$21.66	\$24.46	\$27.18	\$31.42	\$36.88	\$43.80	\$45.42	\$160.55	\$206.66	\$165.53
84	\$22.51	\$25.26	\$27.97	\$31.72	\$37.44	\$44.32	\$45.77	\$162.40	\$209.03	\$167.39
85	\$22.90	\$25.43	\$27.99	\$32.23	\$38.02	\$44.80	\$46.27	\$164.29	\$211.46	\$169.27
86	\$23.97	\$26.59	\$29.09	\$32.84	\$38.47	\$45.63	\$47.24	\$166.02	\$213.69	\$171.01
87	\$24.23	\$26.61	\$29.09	\$32.85	\$38.98	\$45.67	\$47.31	\$167.88	\$216.09	\$172.86
88	\$25.47	\$27.46	\$30.29	\$33.90	\$39.49	\$46.15	\$48.29	\$169.74	\$218.47	\$174.73
89	\$26.36	\$27.97	\$30.60	\$34.01	\$39.97	\$46.62	\$49.29	\$171.51	\$220.74	\$176.50
90	\$27.71	\$29.18	\$31.62	\$35.01	\$40.54	\$47.26	\$49.80	\$173.28	\$222.99	\$178.94
91	\$27.72	\$29.18	\$31.62	\$35.07	\$40.63	\$47.27	\$49.80	\$175.13	\$224.23	\$180.08
92	\$28.60	\$29.45	\$31.79	\$35.07	\$41.11	\$47.27	\$49.91	\$176.80	\$226.20	\$181.76
93	\$28.97	\$30.02	\$32.71	\$35.40	\$41.48	\$47.28	\$50.43	\$178.51	\$226.27	\$183.49
94	\$29.12	\$30.52	\$32.86	\$35.86	\$41.96	\$47.28	\$50.95	\$180.18	\$231.92	\$185.17
95	\$29.80	\$31.08	\$33.08	\$36.35	\$42.25	\$47.45	\$51.50	\$181.95	\$233.96	\$186.94
96	\$30.75	\$31.29	\$34.29	\$37.10	\$42.49	\$47.78	\$52.48	\$183.62	\$235.06	\$188.58
97	\$31.46	\$32.21	\$34.79	\$37.29	\$42.95	\$48.13	\$53.03	\$185.37	\$235.25	\$190.33
98	\$31.88	\$32.41	\$34.80	\$37.73	\$43.43	\$48.14	\$53.05	\$186.99	\$235.39	\$191.99
99	\$32.58	\$32.93	\$36.11	\$38.20	\$43.94	\$48.62	\$53.57	\$188.77	\$235.56	\$193.74
100	\$32.86	\$33.19	\$36.14	\$38.82	\$44.47	\$49.11	\$54.10	\$190.52	\$245.19	\$195.50
101	\$33.14	\$33.48	\$36.17	\$38.82	\$44.48	\$49.12	\$54.13	\$190.55	\$247.44	\$195.52
102	\$33.17	\$33.50	\$36.31	\$38.98	\$44.59	\$49.12	\$54.16	\$190.58	\$249.73	\$195.58
103	\$33.97	\$34.31	\$36.87	\$39.21	\$45.04	\$49.61	\$54.39	\$191.44	\$251.97	\$195.61
104	\$34.17	\$34.48	\$37.06	\$39.62	\$45.18	\$49.76	\$54.71	\$191.92	\$254.36	\$196.29
105	\$35.06	\$35.35	\$37.83	\$40.44	\$45.88	\$50.53	\$55.72	\$194.09	\$256.62	\$198.00
106	\$35.30	\$35.52	\$37.90	\$40.45	\$45.89	\$50.56	\$55.72	\$195.89	\$258.98	\$199.79
107	\$35.82	\$36.07	\$38.72	\$41.25	\$46.30	\$50.93	\$56.69	\$197.70	\$261.39	\$201.60
108	\$36.33	\$36.58	\$38.78	\$41.27	\$46.72	\$51.38	\$56.70	\$198.86	\$263.76	\$203.21
109	\$36.72	\$37.09	\$39.20	\$41.67	\$47.13	\$51.82	\$57.19	\$200.61	\$266.03	\$204.96
110	\$37.67	\$37.99	\$40.03	\$42.07	\$47.99	\$52.80	\$58.25	\$202.90	\$268.27	\$206.77
111	\$37.72	\$38.04	\$40.88	\$42.89	\$48.02	\$53.16	\$58.94	\$205.21	\$271.33	\$209.59
112	\$38.50	\$38.84	\$40.92	\$42.89	\$48.40	\$53.17	\$58.95	\$207.53	\$274.39	\$212.44
113	\$38.53	\$38.87	\$41.37	\$43.29	\$48.84	\$53.61	\$60.02	\$209.32	\$276.77	\$214.23
114	\$38.94	\$39.68	\$42.13	\$44.13	\$49.66	\$54.51	\$60.42	\$211.15	\$279.17	\$216.06
115	\$39.37	\$40.13	\$42.13	\$44.25	\$49.67	\$54.51	\$60.42	\$212.95	\$281.56	\$217.87
116	\$39.78	\$40.26	\$43.06	\$44.45	\$49.99	\$55.72	\$60.79	\$214.27	\$283.31	\$219.60
117	\$40.17	\$40.70	\$43.17	\$45.27	\$50.40	\$55.75	\$61.77	\$215.47	\$285.57	\$221.30
118	\$40.60	\$41.52	\$43.21	\$45.41	\$50.81	\$55.78	\$62.32	\$217.69	\$287.82	\$223.02

119	\$41.16	\$41.57	\$44.07	\$45.66	\$51.25	\$56.16	\$63.07	\$220.83	\$292.00	\$227.32
120	\$42.14	\$42.57	\$44.45	\$46.41	\$51.66	\$56.90	\$63.34	\$222.11	\$294.39	\$229.15
121	\$42.17	\$42.59	\$44.56	\$46.41	\$51.99	\$56.91	\$63.42	\$224.14	\$296.35	\$231.10
122	\$42.55	\$43.39	\$45.00	\$46.83	\$52.40	\$57.82	\$63.95	\$226.04	\$298.87	\$233.01
123	\$43.00	\$43.44	\$46.35	\$47.66	\$52.81	\$58.51	\$64.90	\$227.96	\$301.41	\$234.94
124	\$43.32	\$43.87	\$46.40	\$47.69	\$53.24	\$58.52	\$65.27	\$229.86	\$303.93	\$236.87
125	\$43.44	\$43.87	\$46.41	\$48.07	\$53.65	\$58.68	\$65.42	\$231.78	\$306.45	\$238.81
126	\$44.29	\$44.74	\$47.77	\$48.39	\$53.97	\$59.43	\$66.94	\$232.66	\$308.35	\$240.72
127	\$44.64	\$45.06	\$47.78	\$48.80	\$54.37	\$59.44	\$66.95	\$235.12	\$310.87	\$242.64
128	\$44.64	\$45.07	\$48.24	\$49.23	\$55.20	\$60.51	\$67.95	\$236.46	\$313.41	\$244.56
129	\$45.62	\$46.08	\$48.60	\$49.53	\$55.21	\$60.51	\$67.95	\$238.36	\$315.92	\$246.51
130	\$45.64	\$46.10	\$49.05	\$49.91	\$55.61	\$61.31	\$69.52	\$242.58	\$318.44	\$250.81
131	\$45.91	\$46.38	\$49.77	\$50.37	\$55.91	\$61.32	\$69.53	\$243.44	\$321.86	\$252.79
132	\$46.80	\$47.28	\$49.78	\$50.78	\$56.33	\$61.47	\$69.70	\$244.76	\$324.41	\$254.74
133	\$46.88	\$47.35	\$49.99	\$51.19	\$56.60	\$61.75	\$69.77	\$249.18	\$326.93	\$258.66
134	\$47.24	\$47.72	\$50.48	\$51.50	\$57.03	\$62.17	\$69.85	\$249.80	\$329.47	\$258.70
135	\$48.17	\$48.66	\$51.05	\$52.05	\$58.08	\$63.24	\$70.84	\$250.48	\$331.98	\$260.56
136	\$48.48	\$49.24	\$51.85	\$52.37	\$58.11	\$63.27	\$70.87	\$252.38	\$334.51	\$262.50
137	\$48.84	\$49.24	\$52.72	\$53.26	\$58.29	\$63.49	\$71.34	\$254.31	\$337.06	\$264.47
138	\$49.28	\$50.02	\$53.38	\$53.69	\$59.46	\$64.62	\$72.63	\$256.21	\$339.57	\$266.43
139	\$49.73	\$50.52	\$53.39	\$53.70	\$59.50	\$64.63	\$72.63	\$258.12	\$342.11	\$268.35
140	\$50.18	\$50.67	\$53.59	\$54.13	\$59.81	\$64.90	\$73.20	\$259.92	\$344.48	\$270.20
141	\$50.62	\$51.00	\$54.01	\$54.56	\$60.13	\$65.23	\$73.21	\$261.84	\$346.21	\$272.04
142	\$51.26	\$51.94	\$54.41	\$55.30	\$60.58	\$66.13	\$74.01	\$263.06	\$348.66	\$273.92
143	\$51.27	\$51.95	\$54.89	\$55.44	\$61.04	\$66.13	\$74.19	\$264.84	\$351.00	\$275.74
144	\$52.22	\$53.43	\$55.92	\$56.48	\$61.50	\$67.04	\$74.99	\$266.66	\$353.41	\$277.60
145	\$52.39	\$53.96	\$56.11	\$56.68	\$62.42	\$67.74	\$75.66	\$269.19	\$355.91	\$279.55
146	\$52.40	\$53.99	\$56.48	\$56.92	\$62.43	\$67.92	\$75.69	\$270.46	\$358.45	\$281.51
147	\$53.12	\$54.02	\$56.94	\$57.22	\$62.87	\$67.95	\$76.01	\$272.35	\$360.95	\$283.44
148	\$53.77	\$54.38	\$57.11	\$57.68	\$63.95	\$68.38	\$77.61	\$277.57	\$363.50	\$288.14
149	\$53.88	\$54.86	\$57.40	\$57.99	\$63.96	\$68.65	\$77.64	\$278.16	\$367.76	\$290.11
150	\$53.89	\$55.37	\$59.07	\$60.06	\$64.28	\$69.30	\$78.07	\$280.09	\$370.31	\$294.86
Price/Lb.	\$0.36	\$0.37	\$0.39	\$0.40	\$0.43	\$0.46	\$0.52	\$1.85	\$2.45	\$1.95

Any fraction of a pound more than the weight shown in the rate chart is rounded up to the next listed weight.

*UPS offers customized rate sheets identifying its firm offer of rates and prices for transportation rates and prices. The rates and prices identified in the rate sheets will be guaranteed for 12-month periods and increase only with approval by the Lead State. Other fees and charges that may impact an authorized user's invoice are identified in UPS's Rate and Service Guide and as described in UPS's Tariff/Terms and Conditions of Service, in effect at the time of shipping. These fees and charges are subject to change without notice. In accordance with the conditions of the solicitation, UPS has waived all pick-up charges, including on-call/on-demand, and capped fuel surcharges at 7%. Fuel surcharge information is posted on UPS's website, www.ups.com.

NASPO ValuePoint

UPS Hundredweight Service®

UPS Next Day Air® - Daily Rates per Pound - 2021

ORIGIN 48 STATES

Tier	Minimum Weight per Pkg (lbs)	Weight	Zone 102	Zone 103	Zone 104	Zone 105	Zone 106	Zone 107	Zone 108	Zone 124	Zone 125	Zone 126
01	20	100 to 499lbs.	1.24	1.73	2.61	2.98	3.12	3.65	3.77	4.02	3.46	4.34
		500 to 999lbs.	1.24	1.73	2.61	2.98	3.12	3.65	3.77	4.02	3.46	4.34
		1000lbs. or more	1.24	1.73	2.61	2.98	3.12	3.65	3.77	4.02	3.46	4.34
02	20	100 to 499lbs.	1.31	1.79	2.78	3.13	3.26	3.79	3.93	4.22	3.61	4.54
		500 to 999lbs.	1.31	1.79	2.78	3.13	3.26	3.79	3.93	4.22	3.61	4.54
		1000lbs. or more	1.31	1.79	2.78	3.13	3.26	3.79	3.93	4.22	3.61	4.54
03	18	100 to 499lbs.	1.34	1.85	2.99	3.35	3.51	4.06	4.20	4.50	3.85	4.88
		500 to 999lbs.	1.34	1.85	2.99	3.35	3.51	4.06	4.20	4.50	3.85	4.88
		1000lbs. or more	1.34	1.85	2.99	3.35	3.51	4.06	4.20	4.50	3.85	4.88
04	18	100 to 499lbs.	1.37	1.89	3.16	3.56	3.72	4.37	4.50	4.78	3.99	5.16
		500 to 999lbs.	1.37	1.89	3.16	3.56	3.72	4.37	4.50	4.78	3.99	5.16
		1000lbs. or more	1.37	1.89	3.16	3.56	3.72	4.37	4.50	4.78	3.99	5.16
05	18	100 to 499lbs.	1.41	1.93	3.32	3.74	3.93	4.59	4.74	5.14	4.15	5.54
		500 to 999lbs.	1.41	1.93	3.32	3.74	3.93	4.59	4.74	5.14	4.15	5.54
		1000lbs. or more	1.41	1.93	3.32	3.74	3.93	4.59	4.74	5.14	4.15	5.54
06	18	100 to 499lbs.	1.43	1.99	3.52	3.93	4.05	4.82	5.06	5.60	4.35	5.73
		500 to 999lbs.	1.43	1.99	3.52	3.93	4.05	4.82	5.06	5.60	4.35	5.73
		1000lbs. or more	1.43	1.99	3.52	3.93	4.05	4.82	5.06	5.60	4.35	5.73
07	18	100 to 499lbs.	1.46	2.05	3.67	4.08	4.16	4.99	5.21	5.98	4.47	6.10
		500 to 999lbs.	1.46	2.05	3.67	4.08	4.16	4.99	5.21	5.98	4.47	6.10
		1000lbs. or more	1.46	2.05	3.67	4.08	4.16	4.99	5.21	5.98	4.47	6.10

Shipment minimum 100 pounds.

UPS Next Day Air Saver® - Daily Rates per Pound - 2021

ORIGIN 48 STATES

Tier	Minimum Weight per Pkg (lbs)	Weight	Zone 132	Zone 133	Zone 134	Zone 135	Zone 136	Zone 137	Zone 138
01	20	100 to 499lbs.	1.06	1.60	2.55	2.86	2.91	3.50	3.63
		500 to 999lbs.	1.06	1.60	2.55	2.86	2.91	3.50	3.63
		1000lbs. or more	1.06	1.60	2.55	2.86	2.91	3.50	3.63
02	20	100 to 499lbs.	1.15	1.65	2.73	3.02	3.09	3.66	3.85
		500 to 999lbs.	1.15	1.65	2.73	3.02	3.09	3.66	3.85
		1000lbs. or more	1.15	1.65	2.73	3.02	3.09	3.66	3.85
03	18	100 to 499lbs.	1.20	1.72	2.83	3.21	3.32	3.95	4.13
		500 to 999lbs.	1.20	1.72	2.83	3.21	3.32	3.95	4.13
		1000lbs. or more	1.20	1.72	2.83	3.21	3.32	3.95	4.13
04	18	100 to 499lbs.	1.25	1.76	3.04	3.45	3.53	4.12	4.32
		500 to 999lbs.	1.25	1.76	3.04	3.45	3.53	4.12	4.32
		1000lbs. or more	1.25	1.76	3.04	3.45	3.53	4.12	4.32
05	18	100 to 499lbs.	1.28	1.81	3.21	3.59	3.68	4.32	4.58
		500 to 999lbs.	1.28	1.81	3.21	3.59	3.68	4.32	4.58
		1000lbs. or more	1.28	1.81	3.21	3.59	3.68	4.32	4.58
06	18	100 to 499lbs.	1.31	1.92	3.36	3.76	3.94	4.65	4.85
		500 to 999lbs.	1.31	1.92	3.36	3.76	3.94	4.65	4.85
		1000lbs. or more	1.31	1.92	3.36	3.76	3.94	4.65	4.85
07	18	100 to 499lbs.	1.38	1.99	3.58	3.99	4.07	4.89	5.10
		500 to 999lbs.	1.38	1.99	3.58	3.99	4.07	4.89	5.10
		1000lbs. or more	1.38	1.99	3.58	3.99	4.07	4.89	5.10

Shipment minimum 100 pounds.

UPS 2nd Day Air A.M.® - Daily Rates per Pound - 2021

ORIGIN 48 STATES

Tier	Minimum Weight per Pkg (lbs)	Weight	Zone 242	Zone 243	Zone 244	Zone 245	Zone 246	Zone 247	Zone 248
01	20	100 to 499lbs.	0.75	0.91	1.19	1.66	2.68	3.16	3.35
		500 to 999lbs.	0.75	0.91	1.19	1.66	2.68	3.16	3.35
		1000lbs. or more	0.75	0.91	1.19	1.66	2.68	3.16	3.35
02	20	100 to 499lbs.	0.79	0.94	1.24	1.76	2.84	3.35	3.54
		500 to 999lbs.	0.79	0.94	1.24	1.76	2.84	3.35	3.54
		1000lbs. or more	0.79	0.94	1.24	1.76	2.84	3.35	3.54
03	18	100 to 499lbs.	0.84	1.00	1.32	1.88	3.11	3.55	3.74
		500 to 999lbs.	0.84	1.00	1.32	1.88	3.11	3.55	3.74
		1000lbs. or more	0.84	1.00	1.32	1.88	3.11	3.55	3.74
04	18	100 to 499lbs.	0.88	1.06	1.41	2.01	3.33	3.67	3.86
		500 to 999lbs.	0.88	1.06	1.41	2.01	3.33	3.67	3.86
		1000lbs. or more	0.88	1.06	1.41	2.01	3.33	3.67	3.86
05	18	100 to 499lbs.	0.93	1.14	1.49	2.12	3.53	3.89	4.04
		500 to 999lbs.	0.93	1.14	1.49	2.12	3.53	3.89	4.04
		1000lbs. or more	0.93	1.14	1.49	2.12	3.53	3.89	4.04
06	18	100 to 499lbs.	0.99	1.19	1.58	2.29	3.78	4.12	4.30
		500 to 999lbs.	0.99	1.19	1.58	2.29	3.78	4.12	4.30
		1000lbs. or more	0.99	1.19	1.58	2.29	3.78	4.12	4.30
07	18	100 to 499lbs.	1.06	1.28	1.66	2.46	4.00	4.30	4.51
		500 to 999lbs.	1.06	1.28	1.66	2.46	4.00	4.30	4.51
		1000lbs. or more	1.06	1.28	1.66	2.46	4.00	4.30	4.51

Shipment minimum 100 pounds.

UPS 2nd Day Air® - Daily Rates per Pound - 2021

ORIGIN 48 STATES

Tier	Minimum Weight per Pkg (lbs)	Weight	Zone 102	Zone 103	Zone 104	Zone 105	Zone 106	Zone 107	Zone 108	Zone 124	Zone 125	Zone 126
------	------------------------------	--------	----------	----------	----------	----------	----------	----------	----------	----------	----------	----------

94	\$212.55	\$232.71	\$241.65	\$411.11	\$337.50	\$490.96	\$592.43	\$540.79	\$628.21	\$728.77	\$744.30	\$401.27	\$551.74	\$491.67	\$400.89	\$317.50	\$488.12
96	\$214.24	\$233.43	\$242.60	\$413.62	\$347.08	\$501.21	\$598.84	\$545.21	\$629.16	\$787.89	\$782.15	\$409.08	\$555.26	\$504.88	\$409.00	\$331.33	\$496.50
98	\$215.02	\$234.46	\$243.65	\$414.58	\$354.35	\$502.15	\$601.73	\$546.16	\$630.11	\$814.37	\$786.55	\$410.04	\$556.21	\$507.93	\$411.82	\$333.35	\$505.37
100	\$218.11	\$236.49	\$244.70	\$415.58	\$370.68	\$503.24	\$602.74	\$575.66	\$674.33	\$839.82	\$906.29	\$411.10	\$557.16	\$508.98	\$415.59	\$353.89	\$507.19
105	\$228.14	\$247.29	\$254.32	\$436.01	\$396.94	\$529.40	\$628.99	\$599.02	\$708.05	\$881.81	\$950.71	\$430.39	\$580.61	\$536.06	\$436.00	\$373.42	\$527.09
110	\$239.00	\$259.06	\$266.37	\$456.77	\$415.84	\$554.32	\$658.94	\$627.54	\$741.76	\$923.80	\$995.94	\$450.88	\$608.27	\$561.59	\$456.41	\$391.19	\$531.34
115	\$249.87	\$270.84	\$278.23	\$477.53	\$434.74	\$579.40	\$688.89	\$656.06	\$775.48	\$965.79	\$1,040.22	\$471.37	\$635.91	\$587.11	\$476.74	\$408.97	\$548.13
120	\$260.73	\$282.62	\$290.32	\$498.29	\$453.64	\$604.60	\$718.85	\$684.59	\$809.19	\$1,007.78	\$1,084.41	\$491.87	\$663.56	\$612.64	\$497.03	\$426.76	\$570.02
125	\$271.59	\$294.39	\$302.11	\$519.06	\$472.54	\$629.55	\$748.80	\$713.12	\$842.91	\$1,049.77	\$1,128.53	\$512.36	\$691.21	\$638.17	\$517.68	\$444.53	\$592.05
130	\$282.06	\$306.16	\$316.14	\$539.82	\$491.45	\$654.43	\$778.75	\$741.64	\$876.62	\$1,091.76	\$1,173.62	\$532.85	\$718.85	\$663.70	\$538.36	\$462.32	\$608.04
135	\$292.90	\$317.94	\$328.24	\$560.58	\$510.35	\$679.55	\$808.70	\$770.17	\$910.34	\$1,133.76	\$1,217.65	\$553.35	\$746.50	\$689.22	\$561.50	\$480.10	\$623.53
140	\$303.70	\$329.71	\$340.37	\$581.34	\$529.25	\$704.09	\$838.65	\$798.69	\$944.06	\$1,175.75	\$1,262.71	\$573.84	\$774.15	\$714.75	\$582.28	\$497.88	\$643.99
145	\$314.30	\$341.49	\$352.52	\$602.10	\$548.15	\$728.89	\$868.61	\$827.21	\$977.77	\$1,217.73	\$1,306.60	\$594.34	\$801.80	\$740.27	\$603.07	\$515.66	\$664.66
150	\$325.05	\$353.26	\$364.65	\$622.86	\$567.05	\$757.22	\$898.56	\$855.74	\$1,011.49	\$1,259.72	\$1,351.62	\$614.83	\$829.44	\$765.80	\$623.86	\$533.44	\$685.20

Shipments of More Than 150 Pounds* (non-pallet)

Minimum	\$325.05	\$353.26	\$364.65	\$622.86	\$567.05	\$757.22	\$898.56	\$855.74	\$1,011.49	\$1,259.72	\$1,351.62	\$614.83	\$829.44	\$765.80	\$623.86	\$533.44	\$685.20
---------	----------	----------	----------	----------	----------	----------	----------	----------	------------	------------	------------	----------	----------	----------	----------	----------	----------

Any fraction of a pound more than the weight shown in the rate chart is rounded up to the next listed weight.

*UPS offers customized rate sheets identifying its firm offer of rates and prices for transportation rates and prices. The rates and prices identified in the rate sheets will be guaranteed for 12-month periods and increase only with approval by the Lead State. Other fees and charges that may impact an authorized user's invoice are identified in UPS's Rate and Service Guide and as described in UPS's Tariff/Terms and Conditions of Service, in effect at the time of shipping. These fees and charges are subject to change without notice. In accordance with the conditions of the solicitation, UPS has waived all pick-up charges, including on-call/on-demand, and capped fuel surcharges at 7%. Fuel surcharge information is posted on UPS's website, www.ups.com.

105	\$317.44	\$344.08	\$353.16	\$605.47	\$543.15	\$735.16	\$865.74	\$831.84	\$977.43	\$1,216.11	\$1,320.21	\$591.80	\$802.30	\$736.39	\$599.53	\$515.99	\$710.84
110	\$332.55	\$360.47	\$369.90	\$634.29	\$569.01	\$769.76	\$906.96	\$871.45	\$1,023.97	\$1,274.02	\$1,383.02	\$619.98	\$840.51	\$771.46	\$627.59	\$540.56	\$716.56
115	\$347.67	\$376.85	\$386.37	\$663.13	\$594.87	\$804.60	\$948.19	\$911.05	\$1,070.52	\$1,331.93	\$1,444.52	\$648.16	\$878.72	\$806.52	\$655.54	\$565.13	\$739.21
120	\$362.78	\$393.24	\$403.15	\$691.96	\$620.73	\$839.58	\$989.42	\$950.67	\$1,117.06	\$1,389.84	\$1,505.88	\$676.34	\$916.92	\$841.59	\$683.44	\$589.70	\$768.73
125	\$377.90	\$409.62	\$419.53	\$720.79	\$646.60	\$874.23	\$1,030.64	\$990.28	\$1,163.60	\$1,447.75	\$1,567.14	\$704.51	\$955.13	\$876.65	\$711.83	\$614.27	\$798.45
130	\$392.46	\$426.00	\$435.99	\$749.62	\$672.46	\$908.79	\$1,071.87	\$1,029.89	\$1,210.15	\$1,505.66	\$1,629.77	\$732.70	\$993.33	\$911.72	\$740.27	\$638.84	\$820.01
135	\$407.54	\$442.39	\$452.68	\$778.45	\$698.33	\$943.66	\$1,113.10	\$1,069.50	\$1,256.69	\$1,563.57	\$1,690.91	\$760.88	\$1,031.53	\$946.78	\$772.09	\$663.41	\$840.90
140	\$422.58	\$458.77	\$469.41	\$807.28	\$724.19	\$977.74	\$1,154.32	\$1,109.11	\$1,303.24	\$1,621.48	\$1,753.48	\$789.05	\$1,069.74	\$981.85	\$800.67	\$687.98	\$868.48
145	\$437.32	\$475.15	\$486.16	\$836.12	\$750.05	\$1,012.18	\$1,195.54	\$1,148.72	\$1,349.78	\$1,679.39	\$1,814.43	\$817.24	\$1,107.94	\$1,016.91	\$829.25	\$712.55	\$896.36
150	\$452.28	\$491.54	\$502.89	\$864.95	\$775.92	\$1,051.52	\$1,236.77	\$1,188.33	\$1,396.32	\$1,737.29	\$1,876.94	\$845.42	\$1,146.14	\$1,051.98	\$857.83	\$737.12	\$924.06

Shipments of More Than 150 Pounds*

Price Per Lb	Zones																
	481	482	484	401	402	403	404	405	406	407	408	409	411	412	413	420	421
	\$3.02	\$3.28	\$3.35	\$5.77	\$5.18	\$7.01	\$8.25	\$7.92	\$9.31	\$11.59	\$12.51	\$5.64	\$7.64	\$7.01	\$5.72	\$4.92	\$6.16
Minimum	\$452.28	\$491.54	\$502.89	\$864.95	\$775.92	\$1,051.52	\$1,236.77	\$1,188.33	\$1,396.32	\$1,737.29	\$1,876.94	\$845.42	\$1,146.14	\$1,051.98	\$857.83	\$737.12	\$924.06

Any fraction of a pound more than the weight shown in the rate chart is rounded up to the next listed weight.

*UPS offers customized rate sheets identifying its firm offer of rates and prices for transportation rates and prices. The rates and prices identified in the rate sheets will be guaranteed for 12-month periods and increase only with approval by the Lead State. Other fees and charges that may impact an authorized user's invoice are identified in UPS's Rate and Service Guide and as described in UPS's Tariff/Terms and Conditions of Service, in effect at the time of shipping. These fees and charges are subject to change without notice. In accordance with the conditions of the solicitation, UPS has waived all pick-up charges, including on-call/on-demand, and capped fuel surcharges at 7%. Fuel surcharge information is posted on UPS's website, www.ups.com.

Price Per Lb	\$2.51	\$2.57	\$2.49	\$3.83	\$3.50	\$4.56	\$5.23	\$4.67	\$6.46	\$7.67	\$7.34	\$4.42	\$5.74	\$4.12	\$4.13	\$3.44	\$5.57
Minimum	\$375.61	\$385.17	\$373.63	\$573.84	\$524.56	\$683.58	\$783.15	\$700.06	\$969.07	\$1,160.50	\$1,099.94	\$662.87	\$860.79	\$617.87	\$618.46	\$515.12	\$834.63

Any fraction of a pound more than the weight shown in the rate chart is rounded up to the next listed weight.

*UPS offers customized rate sheets identifying its firm offer of rates and prices for transportation rates and prices. The rates and prices identified in the rate sheets will be guaranteed for 12-month periods and increase only with approval by the Lead State. Other fees and charges that may impact an authorized user's invoice are identified in UPS's Rate and Service Guide and as described in UPS's Tariff/Terms and Conditions of Service, in effect at the time of shipping. These fees and charges are subject to change without notice. In accordance with the conditions of the solicitation, UPS has waived all pick-up charges, including on-call/on-demand, and capped fuel surcharges at 7%. Fuel surcharge information is posted on UPS's website, www.ups.com.

NASPO ValuePoint

UPS Standard to Canada[®] - Export

The rates shown are for shipments originating in the United States.

Package*

	Zones					
	51	52	53	54	55	56
1	\$14.77	\$14.95	\$15.14	\$23.45	\$23.78	\$24.06
2	\$15.98	\$16.16	\$16.37	\$24.66	\$25.01	\$25.30
3	\$16.48	\$16.67	\$16.94	\$25.85	\$26.22	\$26.53
4	\$17.65	\$17.86	\$18.08	\$27.25	\$27.63	\$27.96
5	\$18.71	\$18.93	\$19.18	\$27.64	\$27.99	\$28.37
6	\$19.67	\$19.90	\$20.15	\$28.95	\$29.35	\$29.70
7	\$20.57	\$20.81	\$21.08	\$29.40	\$29.82	\$30.17
8	\$21.51	\$21.76	\$22.04	\$30.46	\$30.88	\$31.26
9	\$22.40	\$22.66	\$22.95	\$30.86	\$31.30	\$31.66
10	\$23.34	\$23.61	\$23.91	\$31.86	\$32.31	\$32.70
11	\$23.73	\$24.10	\$24.41	\$33.09	\$33.57	\$33.96
12	\$24.52	\$24.93	\$25.25	\$34.01	\$34.48	\$34.89
13	\$25.50	\$25.93	\$26.26	\$34.85	\$35.59	\$36.02
14	\$25.87	\$26.30	\$26.63	\$35.27	\$35.99	\$36.42
15	\$26.24	\$26.68	\$27.11	\$35.76	\$36.35	\$36.78
16	\$27.11	\$27.57	\$28.02	\$36.99	\$37.51	\$38.13
17	\$27.83	\$28.29	\$28.72	\$38.03	\$38.56	\$39.27
18	\$28.83	\$29.31	\$29.71	\$39.17	\$39.72	\$40.34
19	\$29.73	\$30.22	\$30.63	\$40.30	\$40.87	\$41.57
20	\$30.46	\$30.97	\$31.48	\$41.40	\$41.99	\$42.64
21	\$31.37	\$31.72	\$32.46	\$42.53	\$43.14	\$43.65
22	\$32.30	\$32.68	\$33.43	\$43.77	\$44.39	\$44.96
23	\$33.09	\$33.49	\$34.14	\$44.87	\$45.49	\$46.04
24	\$33.95	\$34.35	\$34.95	\$45.94	\$46.60	\$47.17
25	\$34.61	\$35.02	\$35.55	\$47.05	\$47.72	\$48.28
26	\$35.43	\$35.84	\$36.43	\$48.36	\$49.04	\$49.62
27	\$36.42	\$36.85	\$37.41	\$49.54	\$50.24	\$50.83
28	\$37.30	\$37.73	\$38.30	\$50.77	\$51.47	\$52.09
29	\$38.17	\$38.60	\$39.24	\$51.94	\$52.68	\$53.29
30	\$39.02	\$39.48	\$40.20	\$53.12	\$53.88	\$54.52
31	\$39.64	\$40.23	\$41.13	\$54.30	\$55.17	\$55.82
32	\$40.50	\$41.09	\$41.97	\$55.50	\$56.40	\$57.07
33	\$41.50	\$42.12	\$42.95	\$56.70	\$57.60	\$58.29
34	\$42.29	\$42.90	\$43.74	\$57.88	\$58.80	\$59.50
35	\$43.11	\$43.73	\$44.87	\$58.65	\$59.60	\$60.65
36	\$43.88	\$44.52	\$45.41	\$60.01	\$60.99	\$61.70
37	\$44.88	\$45.54	\$46.42	\$61.23	\$62.21	\$62.95
38	\$45.69	\$46.36	\$47.38	\$62.28	\$63.28	\$64.11
39	\$46.73	\$47.42	\$48.27	\$63.28	\$64.29	\$65.06
40	\$47.52	\$48.21	\$49.22	\$64.49	\$65.54	\$66.32
41	\$48.34	\$49.05	\$50.00	\$65.59	\$66.65	\$67.44
42	\$49.11	\$49.83	\$50.83	\$66.56	\$67.64	\$68.43
43	\$50.03	\$50.76	\$51.76	\$67.69	\$68.79	\$69.60
44	\$50.66	\$51.41	\$52.36	\$68.56	\$69.67	\$70.49
45	\$51.62	\$52.38	\$53.34	\$69.84	\$70.96	\$71.80
46	\$52.45	\$53.22	\$54.31	\$70.83	\$71.98	\$72.83
47	\$53.26	\$54.04	\$55.14	\$71.93	\$73.08	\$73.96
48	\$53.96	\$54.75	\$55.90	\$73.01	\$74.19	\$75.06
49	\$54.86	\$55.66	\$56.68	\$74.02	\$75.22	\$76.11
50	\$55.77	\$56.58	\$57.65	\$75.21	\$76.41	\$77.32

	Zones					
	51	52	53	54	55	56
52	\$57.47	\$58.31	\$59.36	\$76.78	\$78.01	\$79.68
54	\$59.06	\$59.93	\$61.01	\$78.26	\$79.52	\$81.36
56	\$60.44	\$61.33	\$62.44	\$79.88	\$81.22	\$83.66
58	\$64.57	\$66.75	\$68.47	\$81.50	\$83.38	\$85.84
60	\$65.91	\$67.63	\$69.15	\$82.93	\$84.86	\$87.55
62	\$66.66	\$68.31	\$69.83	\$84.73	\$86.71	\$89.81
64	\$67.34	\$68.98	\$70.51	\$86.30	\$87.73	\$91.07
66	\$68.02	\$69.66	\$71.19	\$87.71	\$89.64	\$93.07
68	\$68.70	\$70.34	\$71.86	\$89.28	\$90.71	\$95.24
70	\$69.38	\$71.01	\$72.54	\$91.07	\$92.54	\$96.77
72	\$70.06	\$71.69	\$73.22	\$93.15	\$94.04	\$99.96
74	\$70.74	\$72.37	\$73.90	\$94.91	\$95.82	\$102.63
76	\$71.42	\$73.04	\$74.57	\$97.12	\$98.04	\$105.32
78	\$72.10	\$73.72	\$75.25	\$97.80	\$98.79	\$107.17
80	\$72.78	\$74.39	\$75.92	\$100.00	\$100.96	\$109.75
82	\$73.46	\$75.07	\$76.61	\$101.85	\$102.82	\$111.89
84	\$74.14	\$75.75	\$77.28	\$103.67	\$104.65	\$113.98
86	\$74.82	\$76.43	\$77.96	\$105.99	\$107.00	\$116.00
88	\$75.50	\$77.11	\$78.64	\$107.74	\$108.76	\$118.17
90	\$76.17	\$77.78	\$79.31	\$109.46	\$110.50	\$120.16
92	\$76.85	\$78.46	\$79.99	\$111.51	\$112.58	\$122.33
94	\$77.53	\$79.14	\$80.67	\$113.27	\$114.36	\$124.32
96	\$78.22	\$79.82	\$81.80	\$115.18	\$116.28	\$126.36
98	\$78.90	\$80.49	\$83.46	\$117.19	\$118.31	\$128.31
100	\$79.58	\$81.17	\$85.16	\$118.86	\$120.00	\$130.49
105	\$80.26	\$81.85	\$86.84	\$119.55	\$121.24	\$134.21
110	\$80.91	\$82.85	\$89.95	\$121.74	\$126.41	\$139.54
115	\$81.57	\$86.39	\$93.62	\$126.53	\$131.77	\$145.25
120	\$83.59	\$89.17	\$97.83	\$131.32	\$136.87	\$150.83
125	\$85.54	\$92.56	\$101.50	\$136.11	\$142.15	\$156.29
130	\$87.30	\$94.96	\$105.53	\$140.95	\$146.75	\$161.12
135	\$89.18	\$97.67	\$109.34	\$144.80	\$149.91	\$165.58
140	\$91.03	\$99.81	\$112.60	\$149.44	\$154.49	\$170.83
145	\$92.77	\$102.22	\$115.70	\$155.98	\$158.77	\$174.53
150	\$94.68	\$104.39	\$118.95	\$159.18	\$162.05	\$176.79

Multiple-Package Shipments of More Than 150 Pounds*

	Zones					
	51	52	53	54	55	56
Multiple-Package Shipments of 151 to 199 Pounds						
Price Per L	\$0.63	\$0.70	\$0.80	\$1.07	\$1.09	\$1.18
Minimum	\$94.68	\$104.39	\$118.95	\$159.18	\$162.05	\$176.79
Multiple-Package Shipments of 200 to 499 Pounds						
Price Per L	\$0.63	\$0.67	\$0.75	\$1.00	\$1.05	\$1.14
Minimum	\$126.30	\$139.32	\$158.85	\$212.24	\$216.14	\$235.67
Multiple-Package Shipments of 500 Pounds or More						
Price Per L	\$0.53	\$0.63	\$0.73	\$0.93	\$0.97	\$1.11
Minimum	\$313.44	\$333.03	\$375.47	\$499.54	\$522.39	\$568.10

Any fraction of a pound more than the weight shown in the rate chart is rounded up to the next listed weight.

*UPS offers customized rate sheets identifying its firm offer of rates and prices for transportation rates and prices. The rates and prices identified in the rate sheets will be guaranteed for 12-month periods and increase only with approval by the Lead State. Other fees and charges that may impact an authorized user's invoice are identified in UPS's Rate and Service Guide and as described in UPS's Tariff/Terms and Conditions of Service, in effect at the time of shipping. These fees and charges are subject to change without notice. In accordance with the conditions of the solicitation, UPS has waived all pick-up charges, including on-call/on-demand, and capped fuel surcharges at 7%. Fuel surcharge information is posted on UPS's website, www.ups.com.

NASPO ValuePoint

UPS Standard to Mexico® - Export

The rates shown are for shipments originating in the United States.

Package*

Table with 8 columns (32-38) and 50 rows of shipping rates for various zones.

Table with 8 columns (32-38) and 50 rows of shipping rates for various zones.

Multiple-Package Shipments of More Than 150 Pounds*

Summary table for multiple-package shipments with price per lb and minimum values for zones 32-38.

Any fraction of a pound more than the weight shown in the rate chart is rounded up to the next listed weight.

*UPS offers customized rate sheets identifying its firm offer of rates and prices for transportation rates and prices. The rates and prices identified in the rate sheets will be guaranteed for 12-month periods and increase only with approval by the Lead State. Other fees and charges that may impact an authorized user's invoice are identified in UPS's Rate and Service Guide and as described in UPS's Tariff/Terms and Conditions of Service, in effect at the time of shipping. These fees and charges are subject to change without notice. In accordance with the conditions of the solicitation, UPS has waived all pick-up charges, including on-call/on-demand, and capped fuel surcharges at 7%. Fuel surcharge information is posted on UPS's website, www.ups.com.

86	\$567.36	\$538.90	\$977.83	\$1,017.21	\$1,282.48	\$1,503.47	\$2,208.32	\$1,195.37	\$1,457.97	\$2,173.15	\$1,166.99	\$1,268.76	\$1,470.87	\$1,166.99	\$949.81	\$1,059.75
88	\$575.17	\$539.50	\$1,001.85	\$1,035.45	\$1,300.05	\$1,504.11	\$2,247.89	\$1,201.04	\$1,488.45	\$2,176.98	\$1,167.58	\$1,283.90	\$1,501.05	\$1,167.58	\$966.82	\$1,079.37
90	\$582.44	\$545.32	\$1,027.40	\$1,036.96	\$1,301.82	\$1,513.36	\$2,302.21	\$1,213.17	\$1,512.26	\$2,234.85	\$1,190.93	\$1,308.95	\$1,550.42	\$1,190.93	\$968.25	\$1,095.41
92	\$591.20	\$556.23	\$1,035.86	\$1,046.75	\$1,302.35	\$1,526.09	\$2,331.46	\$1,248.85	\$1,513.74	\$2,244.58	\$1,229.19	\$1,343.95	\$1,558.93	\$1,229.19	\$977.39	\$1,111.21
94	\$599.27	\$558.13	\$1,041.98	\$1,059.69	\$1,302.97	\$1,538.18	\$2,343.80	\$1,261.22	\$1,547.72	\$2,249.15	\$1,243.26	\$1,353.20	\$1,572.60	\$1,243.26	\$994.66	\$1,127.50
96	\$607.10	\$576.25	\$1,054.72	\$1,073.66	\$1,307.37	\$1,547.59	\$2,387.75	\$1,273.69	\$1,578.83	\$2,353.52	\$1,245.74	\$1,368.33	\$1,587.83	\$1,245.74	\$1,002.51	\$1,148.00
98	\$616.81	\$581.57	\$1,074.62	\$1,082.82	\$1,309.33	\$1,548.86	\$2,434.16	\$1,275.15	\$1,598.90	\$2,362.21	\$1,259.25	\$1,378.79	\$1,608.29	\$1,259.25	\$1,038.47	\$1,166.38
100	\$626.63	\$609.36	\$1,104.36	\$1,172.76	\$1,371.17	\$1,549.31	\$2,467.64	\$1,310.46	\$1,631.33	\$2,364.32	\$1,289.76	\$1,420.74	\$1,616.95	\$1,289.76	\$1,055.30	\$1,185.33
105	\$655.48	\$659.13	\$1,159.65	\$1,228.36	\$1,440.25	\$1,665.57	\$2,595.56	\$1,373.26	\$1,716.85	\$2,481.87	\$1,375.19	\$1,492.13	\$1,705.30	\$1,375.19	\$1,130.60	\$1,234.39
110	\$684.96	\$690.52	\$1,214.87	\$1,286.86	\$1,507.30	\$1,744.88	\$2,714.05	\$1,438.47	\$1,795.99	\$2,597.49	\$1,427.07	\$1,559.50	\$1,786.50	\$1,427.07	\$1,210.14	\$1,282.59
115	\$717.44	\$721.91	\$1,270.08	\$1,345.34	\$1,575.30	\$1,824.18	\$2,834.27	\$1,502.93	\$1,857.66	\$2,713.35	\$1,506.13	\$1,628.81	\$1,867.71	\$1,506.13	\$1,261.60	\$1,337.06
120	\$745.31	\$753.29	\$1,325.30	\$1,403.83	\$1,640.17	\$1,891.67	\$2,956.72	\$1,567.38	\$1,919.69	\$2,828.64	\$1,563.70	\$1,708.12	\$1,948.66	\$1,563.70	\$1,316.39	\$1,394.36
125	\$773.10	\$784.67	\$1,380.52	\$1,462.32	\$1,706.01	\$1,970.05	\$3,082.81	\$1,630.45	\$1,982.48	\$2,945.68	\$1,627.70	\$1,791.19	\$2,028.96	\$1,627.70	\$1,370.93	\$1,447.51
130	\$800.63	\$816.07	\$1,435.73	\$1,520.80	\$1,782.71	\$2,044.80	\$3,203.85	\$1,695.66	\$2,044.15	\$3,062.25	\$1,688.03	\$1,856.63	\$2,096.69	\$1,688.03	\$1,425.58	\$1,499.02
135	\$829.39	\$847.44	\$1,490.96	\$1,579.29	\$1,846.61	\$2,120.29	\$3,325.55	\$1,759.61	\$2,105.33	\$3,179.31	\$1,744.97	\$1,924.73	\$2,155.04	\$1,744.97	\$1,480.26	\$1,552.28
140	\$856.30	\$878.83	\$1,546.17	\$1,637.79	\$1,909.32	\$2,196.29	\$3,447.12	\$1,824.33	\$2,183.71	\$3,295.40	\$1,806.20	\$1,986.34	\$2,219.82	\$1,806.20	\$1,534.57	\$1,606.16
145	\$884.61	\$910.21	\$1,601.39	\$1,696.28	\$1,974.30	\$2,273.16	\$3,567.69	\$1,889.91	\$2,245.25	\$3,411.63	\$1,869.10	\$2,048.09	\$2,291.00	\$1,869.10	\$1,589.35	\$1,658.65
150	\$928.49	\$937.67	\$1,656.61	\$1,754.78	\$2,037.99	\$2,348.28	\$3,688.38	\$1,955.37	\$2,307.05	\$3,524.89	\$1,921.94	\$2,117.89	\$2,362.32	\$1,921.94	\$1,635.29	\$1,713.27

Shipments of More Than 150 Pounds* (non-pallet)

	Zones															
	91	94	951	952	953	954	955	956	957	958	959	961	962	963	970	971
Price Per L	\$6.19	\$6.26	\$11.05	\$11.70	\$13.59	\$15.66	\$24.60	\$13.04	\$15.38	\$23.51	\$12.82	\$14.12	\$15.75	\$12.82	\$10.91	\$11.43
Minimum	\$928.49	\$937.67	\$1,656.61	\$1,754.78	\$2,037.99	\$2,348.28	\$3,688.38	\$1,955.37	\$2,307.05	\$3,524.89	\$1,921.94	\$2,117.89	\$2,362.32	\$1,921.94	\$1,635.29	\$1,713.27

Any fraction of a pound more than the weight shown in the rate chart is rounded up to the next listed weight.

*UPS offers customized rate sheets identifying its firm offer of rates and prices for transportation rates and prices. The rates and prices identified in the rate sheets will be guaranteed for 12-month periods and increase only with approval by the Lead State. Other fees and charges that may impact an authorized user's invoice are identified in UPS's Rate and Service Guide and as described in UPS's Tariff/Terms and Conditions of Service, in effect at the time of shipping. These fees and charges are subject to change without notice. In accordance with the conditions of the solicitation, UPS has waived all pick-up charges, including on-call/on-demand, and capped fuel surcharges at 7%. Fuel surcharge information is posted on UPS's website, www.ups.com.

88	\$282.59	\$267.09	\$497.54	\$508.48	\$645.92	\$735.73	\$1,075.96	\$590.93	\$723.86	\$1,075.64	\$563.36	\$608.34	\$698.28	\$563.36	\$475.46	\$507.89
90	\$287.52	\$270.94	\$507.27	\$508.97	\$646.80	\$742.70	\$1,101.90	\$596.90	\$735.53	\$1,104.24	\$570.17	\$624.78	\$719.53	\$570.17	\$476.05	\$515.46
92	\$292.66	\$276.35	\$514.42	\$512.16	\$647.06	\$746.95	\$1,115.34	\$614.46	\$736.21	\$1,109.04	\$587.99	\$629.98	\$728.74	\$587.99	\$480.67	\$522.71
94	\$297.29	\$277.30	\$517.47	\$518.21	\$647.37	\$751.44	\$1,116.49	\$620.54	\$752.77	\$1,111.30	\$595.54	\$640.68	\$733.24	\$595.54	\$488.82	\$530.59
96	\$302.32	\$286.30	\$523.79	\$527.12	\$649.55	\$756.07	\$1,139.06	\$626.67	\$767.91	\$1,160.43	\$597.06	\$645.63	\$743.19	\$597.06	\$492.88	\$540.12
98	\$307.13	\$288.94	\$533.68	\$529.51	\$650.53	\$757.11	\$1,169.41	\$627.39	\$777.67	\$1,163.30	\$611.66	\$646.31	\$751.22	\$611.66	\$503.97	\$548.79
100	\$311.77	\$302.22	\$548.44	\$573.50	\$681.24	\$764.62	\$1,191.88	\$642.23	\$793.47	\$1,165.45	\$625.14	\$682.08	\$762.93	\$625.14	\$513.64	\$557.72
105	\$325.54	\$320.98	\$575.88	\$602.18	\$715.58	\$802.74	\$1,251.48	\$670.25	\$834.96	\$1,223.35	\$657.31	\$716.40	\$794.17	\$657.31	\$550.14	\$580.76
110	\$339.48	\$336.27	\$603.30	\$630.86	\$748.88	\$839.76	\$1,311.07	\$702.11	\$873.52	\$1,280.39	\$681.79	\$748.63	\$830.80	\$681.79	\$589.04	\$603.43
115	\$353.84	\$351.55	\$630.72	\$659.53	\$782.67	\$877.71	\$1,370.67	\$733.51	\$903.50	\$1,337.49	\$718.14	\$781.93	\$864.07	\$718.14	\$614.59	\$629.04
120	\$367.63	\$365.68	\$658.14	\$688.20	\$814.90	\$908.72	\$1,430.26	\$765.05	\$933.75	\$1,394.34	\$742.04	\$820.03	\$897.04	\$742.04	\$641.11	\$656.08
125	\$381.26	\$378.35	\$685.56	\$716.88	\$847.62	\$946.36	\$1,489.85	\$795.82	\$964.23	\$1,452.05	\$772.33	\$859.79	\$934.65	\$772.33	\$665.49	\$681.15
130	\$394.97	\$391.91	\$712.98	\$745.55	\$885.72	\$979.28	\$1,549.45	\$827.49	\$994.28	\$1,509.52	\$800.98	\$891.31	\$963.82	\$800.98	\$690.54	\$705.41
135	\$409.04	\$406.20	\$740.41	\$774.23	\$917.47	\$1,015.32	\$1,609.04	\$858.84	\$1,023.95	\$1,567.24	\$828.03	\$924.02	\$992.67	\$828.03	\$715.05	\$730.42
140	\$422.40	\$421.06	\$767.83	\$802.90	\$948.62	\$1,051.77	\$1,668.64	\$890.44	\$1,062.16	\$1,624.45	\$856.96	\$953.59	\$1,021.45	\$856.96	\$741.38	\$755.90
145	\$436.32	\$435.98	\$795.25	\$831.58	\$980.92	\$1,088.55	\$1,728.23	\$922.36	\$1,092.08	\$1,681.68	\$886.95	\$983.22	\$1,054.26	\$886.95	\$766.32	\$780.42
150	\$449.95	\$448.32	\$822.66	\$860.25	\$1,012.56	\$1,124.57	\$1,787.82	\$954.41	\$1,122.11	\$1,737.49	\$916.37	\$1,016.75	\$1,088.98	\$916.37	\$789.22	\$806.16

Shipments of More Than 150 Pounds*

	Zones															
	491	494	451	452	453	454	455	456	457	458	459	461	462	463	470	471
Price Per L	\$3.00	\$2.99	\$5.49	\$5.74	\$6.75	\$7.50	\$11.92	\$6.37	\$7.48	\$11.58	\$6.11	\$6.78	\$7.26	\$6.11	\$5.26	\$5.38
Minimum	\$449.95	\$448.32	\$822.66	\$860.25	\$1,012.56	\$1,124.57	\$1,787.82	\$954.41	\$1,122.11	\$1,737.49	\$916.37	\$1,016.75	\$1,088.98	\$916.37	\$789.22	\$806.16

Any fraction of a pound more than the weight shown in the rate chart is rounded up to the next listed weight.

*UPS offers customized rate sheets identifying its firm offer of rates and prices for transportation rates and prices. The rates and prices identified in the rate sheets will be guaranteed for 12-month periods and increase only with approval by the Lead State. Other fees and charges that may impact an authorized user's invoice are identified in UPS's Rate and Service Guide and as described in UPS's Tariff/Terms and Conditions of Service, in effect at the time of shipping. These fees and charges are subject to change without notice. In accordance with the conditions of the solicitation, UPS has waived all pick-up charges, including on-call/on-demand, and capped fuel surcharges at 7%. Fuel surcharge information is posted on UPS's website, www.ups.com.

150	\$719.33	\$759.39	\$1,276.30	\$1,373.52	\$1,623.21	\$1,864.16	\$1,616.41	\$1,684.88	\$1,482.98	\$3,241.52	\$1,375.63	\$1,357.78	\$1,842.52	\$1,375.63	\$1,241.95	\$1,299.83
-----	----------	----------	------------	------------	------------	------------	------------	------------	------------	------------	------------	------------	------------	------------	------------	------------

Shipments of More Than 150 Pounds*

	Zones															
	61	64	651 / 681	652 / 682	653 / 683	654 / 684	655 / 685	656 / 686	657 / 687	658 / 688	659 / 689	661 / 691	662 / 692	663 / 693	670	671
Price Per L	\$4.80	\$5.07	\$8.51	\$9.16	\$10.83	\$12.43	\$10.78	\$11.24	\$9.89	\$21.62	\$9.17	\$9.05	\$12.29	\$9.17	\$8.28	\$8.67
Minimum	\$719.33	\$759.39	\$1,276.30	\$1,373.52	\$1,623.21	\$1,864.16	\$1,616.41	\$1,684.88	\$1,482.98	\$3,241.52	\$1,375.63	\$1,357.78	\$1,842.52	\$1,375.63	\$1,241.95	\$1,299.83

Any fraction of a pound over the weight shown takes the next higher rate.

*UPS offers customized rate sheets identifying its firm offer of rates and prices for transportation rates and prices. The rates and prices identified in the rate sheets will be guaranteed for 12-month periods and increase only with approval by the Lead State. Other fees and charges that may impact an authorized user's invoice are identified in UPS's Rate and Service Guide and as described in UPS's Tariff/Terms and Conditions of Service, in effect at the time of shipping. These fees and charges are subject to change without notice. In accordance with the conditions of the solicitation, UPS has waived all pick-up charges, including on-call/on-demand, and capped fuel surcharges at 7%. Fuel surcharge information is posted on UPS's website, www.ups.com.

NASPO ValuePoint

UPS Standard® from Canada - Import

Packages*

	Zones		
	376	378	380
1	\$17.41	\$17.72	\$18.29
2	\$18.29	\$18.53	\$19.45
3	\$18.99	\$19.37	\$20.58
4	\$19.45	\$20.34	\$21.91
5	\$20.22	\$21.27	\$22.87
6	\$20.79	\$21.66	\$24.00
7	\$21.35	\$22.31	\$25.13
8	\$22.02	\$23.27	\$26.30
9	\$22.48	\$24.20	\$27.42
10	\$23.19	\$25.10	\$28.63
11	\$23.27	\$25.61	\$29.36
12	\$23.71	\$26.57	\$30.52
13	\$24.09	\$27.55	\$31.56
14	\$24.32	\$28.35	\$32.70
15	\$24.60	\$29.23	\$33.81
16	\$25.19	\$29.96	\$34.79
17	\$25.87	\$30.72	\$35.99
18	\$26.57	\$31.53	\$36.96
19	\$27.04	\$32.29	\$38.12
20	\$27.45	\$32.90	\$39.29
21	\$28.89	\$34.65	\$41.28
22	\$29.22	\$35.10	\$42.31
23	\$29.91	\$36.05	\$43.42
24	\$30.38	\$36.67	\$44.45
25	\$30.90	\$37.38	\$45.60
26	\$31.49	\$38.08	\$46.75
27	\$32.03	\$38.94	\$47.78
28	\$33.35	\$40.27	\$49.69
29	\$33.42	\$40.47	\$50.04
30	\$34.21	\$41.52	\$51.41
31	\$34.70	\$41.83	\$52.54
32	\$35.54	\$42.66	\$53.68
33	\$35.99	\$43.40	\$54.79
34	\$37.14	\$44.61	\$56.48
35	\$37.42	\$44.73	\$56.97
36	\$38.04	\$45.63	\$58.21
37	\$38.71	\$46.75	\$59.17
38	\$39.41	\$47.83	\$60.37
39	\$40.34	\$49.45	\$62.15
40	\$40.69	\$49.97	\$62.59
41	\$41.38	\$50.97	\$63.72
42	\$42.71	\$52.87	\$66.07
43	\$43.11	\$53.61	\$66.65
44	\$43.40	\$54.11	\$67.10
45	\$44.32	\$55.74	\$68.57
46	\$44.63	\$56.09	\$69.24
47	\$45.18	\$57.09	\$70.20
48	\$46.37	\$58.77	\$72.12
49	\$46.54	\$59.07	\$72.32
50	\$47.28	\$60.01	\$73.07

	Zones		
	376	378	380
52	\$48.69	\$62.12	\$75.45
54	\$50.14	\$64.35	\$77.83
56	\$51.66	\$66.33	\$80.23
58	\$53.09	\$68.36	\$82.49
60	\$54.58	\$70.39	\$84.68
62	\$56.03	\$72.28	\$86.94
64	\$57.60	\$74.24	\$89.12
66	\$59.08	\$76.04	\$91.56
68	\$61.50	\$79.43	\$95.63
70	\$63.04	\$81.17	\$97.64
72	\$64.43	\$83.11	\$100.12
74	\$65.55	\$84.36	\$101.94
76	\$67.00	\$86.17	\$104.47
78	\$68.43	\$88.27	\$107.11
80	\$68.97	\$89.02	\$108.11
82	\$69.84	\$90.35	\$109.92
84	\$72.27	\$93.57	\$113.89
86	\$72.47	\$93.78	\$114.47
88	\$74.75	\$96.00	\$117.52
90	\$75.07	\$97.12	\$119.01
92	\$76.28	\$98.61	\$121.38
94	\$77.69	\$99.98	\$123.65
96	\$79.28	\$101.50	\$125.84
98	\$81.39	\$104.63	\$130.17
100	\$81.47	\$104.68	\$130.28
105	\$83.28	\$106.24	\$133.76
110	\$85.67	\$108.15	\$137.03
115	\$87.87	\$110.04	\$140.28
120	\$90.05	\$111.82	\$143.63
125	\$92.08	\$113.63	\$147.01
130	\$94.11	\$115.49	\$150.29
135	\$96.20	\$117.62	\$153.59
140	\$98.11	\$119.41	\$157.01
145	\$100.21	\$121.26	\$160.19
150	\$102.08	\$123.04	\$163.55

Multiple-Package Shipments of More Than 150 Pounds*

	Zones		
	376	378	380
Price Per L	\$0.68	\$0.82	\$1.09
Minimum	\$102.08	\$123.04	\$163.55

Any fraction of a pound more than the weight shown in the rate chart is rounded up to the next listed weight.

*UPS offers customized rate sheets identifying its firm offer of rates and prices for transportation rates and prices. The rates and prices identified in the rate sheets will be guaranteed for 12-month periods and increase only with approval by the Lead State. Other fees and charges that may impact an authorized user's invoice are identified in UPS's Rate and Service Guide and as described in UPS's Tariff/Terms and Conditions of Service, in effect at the time of shipping. These fees and charges are subject to change without notice. In accordance with the conditions of the solicitation, UPS has waived all pick-up charges, including on-call/on-demand, and capped fuel surcharges at 7%. Fuel surcharge information is posted on UPS's website, www.ups.com.

2021 UPS Rate & Service Guide

Daily Rates

Updated April 5, 2021



This is the current UPS Rate & Service Guide at the time of submission. The Rate & Service Guide is subject to change without notice. The UPS Rate & Service Guide, in effect at the time of shipping, and the UPS Tariff/Terms and Conditions of Service, in effect at the time of shipping must be incorporated by reference into the resulting contract if UPS is awarded.,

Essential Contacts

Support

UPS Customer Service

[ups.com](https://www.ups.com)

1-800-PICK-UPS® (1-800-742-5877)

1-800-877-1548 En Español

1-800-782-7892 International

1-800-811-1648 Billing

1-800-554-9964 Hazardous Materials

1-800-833-0056 Hearing Impaired – TTY/TDD

customer.service@ups.com

International Shipping

[ups.com/international](https://www.ups.com/international)

1-800-782-7892

Zone Charts

View or download at [ups.com/rates](https://www.ups.com/rates)

WorldShip® Technical Support

[ups.com/worldshipsupport](https://www.ups.com/worldshipsupport)

1-888-553-1118

UPS Package Design and Test Lab

1-877-877-7229

UPS CampusShip® Support

Help Desk: 1-877-289-6418 (United States)

[campusship.ups.com/techsupport](https://www.campusship.ups.com/techsupport)

UPS® Ground Time in Transit

[ups.com/maps](https://www.ups.com/maps)

Freight Services

UPS offers multiple options for shipments over 150 pounds. For more information on these services, go to pages 4-6.

Air Freight Services

[ups-scs.com/airfreight](https://www.ups-scs.com/airfreight)

1-800-443-6379

Ocean Freight Services

[ups-scs.com/ocean](https://www.ups-scs.com/ocean)

1-800-443-6379

UPS Express Critical®

[upsexpresscritical.com](https://www.upsexpresscritical.com)

1-800-714-8779

UPS Freight® – LTL (Less-Than-Truckload)

[upsfreight.com](https://www.upsfreight.com)

1-800-333-7400

UPS Trade Direct®

[ups.com/tradedirect](https://www.ups.com/tradedirect)

1-800-742-5727

UPS Worldwide Express Freight® Services

[UPS Worldwide Express Freight](https://www.ups.com) at [ups.com](https://www.ups.com)

1-800-782-7892

UPS Worldwide Expedited® Ground Freight

[UPS Worldwide Expedited Ground Freight](https://www.ups.com) at [ups.com](https://www.ups.com)

1-800-443-6379

Coyote Logistics® – Truckload and Intermodal

[coyote.com](https://www.coyote.com)

1-877-626-9683

UPS Solutions

Visit [ups.com/services](https://www.ups.com/services) to view the full portfolio of UPS services.

The UPS Store®

[theupsstore.com](https://www.theupsstore.com)

1-800-789-4623

UPS Capital®

[upscapital.com](https://www.upscapital.com)

1-877-263-8772

Parcel Pro®

[parcelpro.com](https://www.parcelpro.com)

1-888-683-2300

Coyote® Collaborative Transportation Management

[coyote.com](https://www.coyote.com)

1-877-626-9683

UPS Mail Innovations®

[upsmailinnovations.com](https://www.upsmailinnovations.com)

1-800-500-2224

UPS Supply Chain Solutions®

[ups-scs.com](https://www.ups-scs.com)

1-800-742-5727

Stay on top of the latest UPS news, announcements and critical updates via e-mail at [ups.com/subscribe](https://www.ups.com/subscribe).

2021 Updates

Updates to this guide are as follows:

April 5	■ Service Restrictions
	Tobacco and Vaping Products update..... page 9
	■ Other Charges
	Additional Handling description update..... page 122

[ups.com](https://www.ups.com)

How To Use This Guide

Find what you need to ship your packages – from services and rates to packaging and payment – in the following pages. For your convenience, the “UPS® Rate and Service Guide” is divided into four sections that cover each of the primary steps involved in preparing and processing a shipment. At the beginning of each section, further detail as to what is covered in that section is provided. Essential information regarding the general terms and conditions of service governing UPS and its affiliates in the transportation of packages and UPS Worldwide Express Freight® Midday and UPS Worldwide Express Freight® pallets in the United States is provided in the “UPS Tariff/Terms and Conditions of Service – United States” available at [ups.com/terms](https://www.ups.com/terms).

Section 1

CHOOSING A SERVICE

PAGES [3-9](#)

Determine the service that best meets your needs for domestic, export and import shipping. Also, learn about certain service restrictions that may apply.

Section 2

PREPARING A SHIPMENT

PAGES [10-24](#)

Information about how you package a shipment, determine the rate and get the shipment to UPS is provided.

Section 3

DETERMINING THE RATE

PAGES [25-138](#)

Determine the rates and zones for domestic, export and import shipments. Also, learn about value-added services that are available.

Section 4

TRACKING AND PAYMENT

PAGES [139-144](#)

Convenient and up-to-the-minute ways to track shipments are reviewed, as well as an explanation of the UPS invoice, its presentation and various billing and payment options.

Table of Contents

In this “UPS® Rate and Service Guide,” you will find the combined 2021 UPS Package Daily and Standard List Rates for the 48 contiguous states, referred to as “Daily Rates,” effective April 5, 2021 (unless otherwise noted). Daily Rates apply to UPS account holders who received Daily Rates prior to July 11, 2016, to shippers who establish a six-digit UPS account on or after July 11, 2016, or as UPS may otherwise agree in writing. You will also find service and rate information for UPS Freight® services, including Air Freight and Less-Than-Truckload. The most current version of this Guide can be downloaded at ups.com/rates.

Choosing a Service		Determining the Rate <i>(continued)</i>	
UPS® Services	4	Export <i>(continued)</i>	
Service Restrictions	7	UPS Worldwide Saver®	82
Preparing a Shipment		UPS Worldwide Expedited®	85
Special Packaging Needs	11	UPS® Standard	
Packaging Guidelines	13	To Canada	88
Determine the Weight and Size	16	To Mexico	91
Shipping Solutions	21	Import	94
Pickup and Drop-off Availability	23	Shipment Pricing	94
Determining the Rate		UPS Worldwide Express Plus	95
Determine the Rate	26	UPS Worldwide Express NA1®	95
Determine the Rate and Zone	27	UPS Worldwide Express	95
West and East State Classifications	28	UPS Worldwide Express Freight Midday	98
Export	29	UPS Worldwide Express Freight	99
Worldwide Zone Chart	29	UPS Worldwide Saver	100
Canada Zone Chart	33	UPS Worldwide Expedited	103
UPS® Standard Zone Chart (to Mexico)	38	UPS 3 Day Select® from Canada	106
Import	39	UPS® Standard	
Worldwide Zone Chart	39	From Canada	107
UPS 3 Day Select® and		From Mexico	109
UPS® Standard Zone Chart (from Canada)	42	Value-Added Services	112
UPS® Standard Zone Chart (from Mexico)	43	Package	114
Domestic	44	UPS Returns®	119
UPS Next Day Air® Early	44	Freight	126
UPS Next Day Air®	48	Air Freight	128
UPS Next Day Air Saver®	52	UPS Freight® LTL (Less-Than-Truckload)	130
UPS 2nd Day Air A.M.®	56	UPS Worldwide Expedited® Ground Freight	132
UPS 2nd Day Air®	60	Other Charges	113
UPS 3 Day Select	64	Package	122
UPS® Ground	68	Freight	127
UPS® Simple Rate	72	Air Freight	129
UPS Next Day Air® Freight	74	UPS Freight LTL (Less-Than-Truckload)	131
UPS 2nd Day Air® Freight	74	UPS Worldwide Expedited Ground Freight	133
UPS 3 Day Freight®	74	Customs Brokerage	134
UPS Next Day Air® Freight NGS	75	Tracking and Payment	
UPS 2nd Day Air® Freight NGS	75	Track Your Shipment	140
UPS 3 Day Freight® NGS	75	Reviewing Your Invoice	142
Export	76	Index	145
Shipment Pricing	76		
UPS Worldwide Express Plus®	77		
UPS Worldwide Express®	77		
UPS Worldwide Express Freight® Midday	80		
UPS Worldwide Express Freight®	81		

How To Use This Guide

Section 1

CHOOSING A SERVICE

Determine the service that best meets your needs for domestic, export and import shipping. Also, learn about certain service restrictions that may apply.

- Overview of UPS® services. Pages [4-6](#)
 - Review service restrictions for domestic, export and import shipments. Pages [7-9](#)
-

Section 2

PREPARING A SHIPMENT

PAGES [10-24](#)

Section 3

DETERMINING THE RATE

PAGES [25-136](#)

Section 4

TRACKING AND PAYMENT

PAGES [139-144](#)

UPS® Services



United States – Package

	Same Day	1 Day	2 Days	3 Days	Within 5 Days	Page
UPS Express Critical®	●					*
UPS Next Day Air® Early		●				44
UPS Next Day Air®		●				48
UPS Next Day Air Saver®		●				52
UPS 2nd Day Air A.M.®			●			56
UPS 2nd Day Air®			●			60
UPS 3 Day Select®				●		64
UPS® Ground					●	68
UPS® Simple Rate		●	●	●	●	72
UPS® Ground with Freight Pricing					●	6



International – Package and Freight

	Best Available Flight	1-3 Days	2-5 Days	Within 3 Days	3-5 Days	Day-Definite	Export Page	Import Page
UPS Express Critical	●						*	*
UPS Worldwide Express Plus®		●					77	95
UPS Worldwide Express NA1®		●					N/A	95
UPS Worldwide Express®		●					77	95
UPS Worldwide Express Freight® Midday		●					80	98
UPS Worldwide Express Freight®		●					81	99
UPS Worldwide Saver®		●					82	100
UPS Worldwide Expedited®			●				85	103
UPS 3 Day Select® from Canada				●			N/A	106
UPS® Standard to/from Canada						●	88	107
UPS® Standard to/from Mexico						●	91	109
UPS® Air Freight Premium Direct		●					**	**
UPS Air Freight Direct®		●					**	**
UPS Air Freight Consolidated®					●		**	**

*Visit upsexpresscritical.com or call 1-800-714-8779 for rates and information.

**Call 1-800-443-6379 for rates and additional information.

Notes:

- Some shipments to and from certain locations may require additional time in transit. For guarantee details, service availability and time commitments, visit ups.com for packages and ups-scs.com (or call 1-800-443-6379) for Air Freight.
- Visit ups.com/holidays for time in transit changes effective during the holiday season.

UPS® Services

North American Freight

	Same Day	1 Day	2 Days	2-3 Days	3-5 Days	Within 3-4 Days	Day-Definite	Page
UPS Express Critical®	●							*
UPS Next Day Air® Freight		●						74
UPS Next Day Air® Freight NGS		●						75
UPS 2nd Day Air® Freight			●					74
UPS 2nd Day Air® Freight NGS			●					75
UPS Worldwide Expedited® Air Freight (U.S.-Mexico)				●				**
UPS Worldwide Expedited® Ground Freight (U.S.-Mexico)					●			**
UPS Worldwide Expedited® Truckload (U.S.-Mexico)					●			**
UPS 3 Day Freight®						●		74
UPS 3 Day Freight® NGS						●		75
Coyote Logistics® Truckload and Intermodal							●	6
Coyote® Collaborative Transportation Management							●	6
UPS Freight® LTL (Less-Than-Truckload)							●	6
UPS Freight® LTL Guaranteed							●	6
UPS Freight® LTL Guaranteed A.M.							●	6
UPS Freight® LTL Urgent							●	6
UPS Freight® Dedicated Contract Carriage							●	6
UPS Freight® Trade Show Services							●	6
UPS Freight® Temperature Protection Services							●	6
UPS® Standard LTL (U.S.-Mexico)							●	***
UPS® Standard Truckload (U.S.-Mexico)							●	***

*Visit upsexpresscritical.com or call 1-800-714-8779 for rates and information.

**Delivery is guaranteed when UPS is the customs broker. Call 1-800-443-6379 for rates and additional information.

***Call 1-800-333-7400 for UPS Standard LTL or 1-888-682-4652 for UPS Standard Truckload rates and additional information.



Ocean Freight

Full-Container Load (FCL) NVOCC Service	Multiple sailings weekly <ul style="list-style-type: none"> • Dedicated service in all major global ports and markets • Door-to-door service available; customs clearance optional
Less-Than-Container Load (LCL) NVOCC Service	Weekly fixed-day sailings <ul style="list-style-type: none"> • Service in all major global ports and markets • Customs clearance optional
UPS Preferred® Multimodal Freight Services†	Better balance of speed and cost via: <ul style="list-style-type: none"> • UPS Preferred LCL to North America • UPS Preferred FCL and LCL between China and Europe • UPS Preferred Sea/Air from Asia
Ocean Freight Forwarding	Carrier booking, document processing, load coordination and container yard management
Project Cargo Management	Specialized multimodal transport for breakbulk with document processing <ul style="list-style-type: none"> • Service in all major global ports and markets • Customized single-project solutions • Charter vehicles/vessels available

†UPS Preferred Multimodal Freight Services subject to applicable tariff rules.

Notes:

- UPS Freight® Services are governed by the UPS Freight Rules Tariff for Less-Than-Truckload transportation. For full details and updates, refer to upsfreight.com/tariff.
- Some shipments to and from certain locations may require additional time in transit. For guarantee details, service availability and time commitments, visit ups.com for packages and ups-scs.com (or call 1-800-443-6379) for Air Freight and UPS Worldwide Expedited Ground Freight.
- Visit ups.com/holidays for time in transit changes effective during the holiday season.
- Ocean Freight services are provided pursuant to the “UPS Supply Chain Solutions® (Ocean Freight Forwarding) Terms and Conditions” and the “Non-Vessel Operating Common Carrier (NVOCC) Terms and Conditions,” each available at ups-scs.com/terms. Services listed above are available in most major markets. Please refer to the Terms and Conditions for more details.



UPS® Services

Service	Delivered By	Destinations	Other Information
UPS FREIGHT® SERVICES			
LTL (Less-Than-Truckload)*	<ul style="list-style-type: none"> – End of scheduled business day – Backed by day-definite, on-time guarantee at no additional charge in the 48 contiguous states, and to and from Canada 	<ul style="list-style-type: none"> – All 50 states, Canada, Mexico, Puerto Rico, U.S. Virgin Islands and Guam 	<ul style="list-style-type: none"> – Regional, interregional and long-haul LTL services – More than 35,000 one- and two-day lanes nationwide – No Fee Guarantee applies to current UPS Freight Tariff customers only
LTL Guaranteed*	<ul style="list-style-type: none"> – End of scheduled business day 	<ul style="list-style-type: none"> – Direct service points in the 48 contiguous states and between the 48 contiguous states and Canada or Mexico 	<ul style="list-style-type: none"> – Guaranteed service available for customers with contracts and/or pricing other than the current UPS Freight Tariff
LTL Guaranteed A.M.*	<ul style="list-style-type: none"> – 12:00 p.m. of scheduled business day 	<ul style="list-style-type: none"> – Select destination points in the 48 contiguous states 	<ul style="list-style-type: none"> – Guaranteed service with up-charge applied to existing LTL pricing provisions
LTL Urgent	<ul style="list-style-type: none"> – Guaranteed capabilities for shipments that require faster delivery than standard LTL service or specific time-definite delivery 	<ul style="list-style-type: none"> – All 50 states, Canada, Mexico, Puerto Rico, U.S. Virgin Islands and Guam 	<ul style="list-style-type: none"> – Customized solutions for unique LTL transportation needs – Call 1-800-644-0900 for rates and to schedule service
Trade Show Services	<p>Our Trade Show specialists help you select package and freight shipping solutions for your exhibit and supporting materials to and from the show:</p> <ul style="list-style-type: none"> – Advance warehousing, round-the-clock tracking and on-time performance guarantee** provide peace of mind for your trade show shipping – On-site UPS Trade Show representatives to assist with return shipping needs – Customs Brokerage and Air Freight services available when exhibiting internationally – Call 1-800-988-9889 to speak to a trade show specialist about your show 		
Temperature Protection Services	<ul style="list-style-type: none"> – Seasonal protection (October through April) for commodities with a freeze point of 32 degrees Fahrenheit or lower – Refrigerated unit service available – Call 1-800-644-0900 for fees and more information 		
Dedicated Contract Carriage	<ul style="list-style-type: none"> – Secure the capacity and rigorous service levels of your own customized private fleet with the peace of mind and operational efficiencies of being managed by experts at UPS with exclusive use of dedicated equipment, drivers, systems and management domiciled on-site. – Highly customized and engineered dedicated fleet solutions to meet unique client needs for automotive parts, retail, perishables, medical and any industry where rigorous delivery service levels are required. – Send an e-mail to dedicatedtruckload@ups.com to request information. 		
UPS CAPITAL® SERVICES			
Insurance Services	<p>Protect your in-transit freight shipments as well as warehoused goods against loss or damage with higher coverage limits than standard, non-insurance declared value programs.</p> <ul style="list-style-type: none"> – Worldwide coverage for package and freight shipments regardless of mode and carrier – Coverage options for unique commodities, including wine and other time- and temperature-sensitive goods – Coverage and advanced risk mitigation protocols for jewelry, loose stones and watches through Parcel Pro® – Call 1-877-263-8772 or visit upscapital.com 		
Payments	<p>Accept payments securely and easily with UPS Capital® Merchant Services.</p> <ul style="list-style-type: none"> – Multiple payment options – Next-business-day funding <p>– Call 1-877-263-8772 or visit upscapital.com</p>		
COYOTE LOGISTICS®			
Truckload and Intermodal	<ul style="list-style-type: none"> – Coyote Logistics, a UPS company, provides truckload and intermodal brokerage and transportation management services across a wide range of industries. – Services include asset utilization, dry van, temperature-controlled and open-deck, using a network of more than 50,000 carriers. Areas of service include North America and Europe. – Our intermodal solution is a cost-efficient option for long-haul moves and will help you reduce your carbon footprint. You'll benefit from transparent technology, including real-time visibility, tracking updates and access to load details on all of your shipments. – Call 1-877-626-9683 or visit coyote.com to request a quote or for more information. 		
Collaborative Transportation Management	<ul style="list-style-type: none"> – Coyote's Collaborative Transportation Management program offers comprehensive solutions for supply chain planning and optimization, transportation management and strategic sourcing of capacity. – Shippers can leverage advanced analytics and custom reporting on a web-based Collaborative Transportation Management portal, driven by Coyote's constantly evolving, proprietary technology. – Send an e-mail to managementsolutions@coyote.com for more information. 		
MULTIPLE-PACKAGE SHIPMENTS			
These offerings are ideal for multiple-package shipments where a pallet is not required. Each package has its own shipping label and unique tracking number.			
UPS® Ground with Freight Pricing	<ul style="list-style-type: none"> – Guaranteed day-definite UPS® Ground delivery within one to five business days in the 48 contiguous states for shipments over 150 pounds. – With UPS Ground with Freight Pricing, customers have the ability to rate and ship UPS Ground service using LTL shipment characteristics, such as Freight Class. Visit ups.com/gfp for more information about shipment eligibility and rates. 		
UPS Hundredweight Service®	<ul style="list-style-type: none"> – Contractual service for shipments with two or more packages going to the same destination on the same business day and having a minimum shipment weight of 100 pounds for Air Services and 200 pounds for UPS Ground. – Available with UPS Next Day Air®, UPS Next Day Air Saver®, UPS 2nd Day Air A.M.®, UPS 2nd Day Air®, UPS 3 Day Select® and UPS Ground shipments. – Guaranteed day-definite delivery within one to five business days in all 50 states and Puerto Rico. 		

*Contact 1-800-333-7400 for all your UPS Freight® LTL (Less-Than-Truckload) needs.

**For inbound trade show shipments only.

Notes:

– UPS Freight Services are governed by the UPS Freight Rules Tariff for Less-Than-Truckload transportation. For full details and updates, refer to upsfreight.com/tariff.

– Visit ups.com/holidays for time in transit changes effective during the holiday season.

Domestic, Export and Import Service Restrictions

PACKAGE

Hazardous Materials and International Dangerous Goods

UPS will accept domestic Air Dangerous Goods shipments prepared under D.O.T. 49 C.F.R. or the International Air Transport Association (IATA) regulation sets. The domestic Hazardous Materials and International Dangerous Goods (IDG) functionality is integrated into the current version of WorldShip® software. Contact the Hazardous Materials Support Center at 1-800-554-9964 for more information.

Select Hazardous Materials, as defined and regulated under Title 49 of the Code of Federal Regulations (49 C.F.R.), and Dangerous Goods, as defined under the International Civil Aviation Organization (ICAO) and published in the IATA “Dangerous Goods Regulations,” are accepted for transportation only as a contractual service domestically within and between all 50 states and Puerto Rico, and internationally within or between defined service areas. Effective April 3, 2017, a separate contract is required to ship Cargo Aircraft Only (CAO) quantities for classes 1-8 (contact the Hazardous Materials Support Center at 1-800-554-9964 for more information).

Setting Up Service for Hazardous Materials and Dangerous Goods

To receive Hazardous Materials or Dangerous Goods service, including UPS® Standard to Canada, the shipper must have a Scheduled Pickup account and agree to the provisions set forth in the online “UPS Dangerous Goods Agreement Checklist” or an approved prior domestic or international agreement or have these same provisions incorporated into their existing customized contract.

Location Restrictions for Ground and Air Services

UPS does not accept hazardous materials, including Consumer Commodities, Limited Quantities (Ltd Qty) and combustibles, via UPS® Ground service to and from Alaska; Hawaii; Puerto Rico; Avalon, CA; Catalina Island, CA; Beaver Island, MI; Mackinac Island, MI (winter only); the Bass Islands, OH; Kelleys Island, OH; and San Juan Islands, WA. Many products that are not regulated or do not

require shipping papers via UPS Ground are fully regulated when transported via aircraft. Hazardous Materials are accepted for transportation via UPS Air Services to and from Alaska, Hawaii, Puerto Rico and Catalina Island only in passenger aircraft quantities without an additional contract granting access to Cargo Aircraft Only (CAO) quantities for classes 1-8 (contact the Hazardous Materials Support Center at 1-800-554-9964 for more information). Shipments must be prepared according to the requirements set forth in either Title 49 of the Code of Federal Regulations (49 C.F.R.) or in the IATA regulations and the “UPS Guide for Shipping Ground and Air Hazardous Materials” at ups.com/hazmat.

UPS 3 Day Select®

When preparing Hazardous Materials packages for UPS 3 Day Select shipping, packages must be prepared in accordance with the applicable air regulations. Many products that are not regulated or do not require shipping papers via UPS Ground are fully regulated when transported via aircraft. Hazardous Materials are accepted for transportation in UPS 3 Day Select shipments only in passenger aircraft quantities without an additional contract granting access to Cargo Aircraft Only (CAO) quantities for classes 1-8 (contact the Hazardous Materials Support Center at 1-800-554-9964 for more information). Shipments must be prepared according to the requirements set forth in either Title 49 of the Code of Federal Regulations (49 C.F.R.) or in the IATA regulations and the “UPS Guide for Shipping Ground and Air Hazardous Materials,” available at ups.com/hazmat.

Limited Quantities (Ltd Qty)

Ltd Qty shipments prepared under HM-215K are accepted for transportation without Hazardous Materials shipping papers and without a contract, only within the 48 contiguous states via UPS Ground, UPS Ground with Freight Pricing and UPS Hundredweight Service® shipping for UPS Ground shipments, and via UPS Standard to Canada and UPS Ground Intra-Alaska

and Intra-Oahu services, when properly classified, packaged and marked, provided the shipper has reviewed the service restrictions with a UPS representative.

UPS Ground, UPS Ground with Freight Pricing and UPS Hundredweight Service shipping for UPS Ground shipments are not available for Ltd Qty shipments to and from Avalon, CA; Catalina Island, CA; Beaver Island, MI; Mackinac Island, MI (winter only); the Bass Islands, OH; Kelleys Island, OH; and San Juan Islands, WA.

Ltd Qty (HM-215K) packages shipped via UPS domestic Air Services and UPS 3 Day Select shipping within the U.S. and Puerto Rico, and Consumer Commodity and Ltd Qty shipments to IDG destinations, are accepted for transportation on a contractual basis only.

UPS Express Critical®

UPS Express Critical service accepts Hazardous Materials and International Dangerous Goods shipments via ground transportation or air charter service only (certain restrictions apply).

Dry Ice

UPS accepts most non-Dangerous Goods shipments containing dry ice within the U.S. without requiring the shipper to enter into the UPS Dangerous Goods Agreement. Refer to page 123 for more information. International dry ice shipping is available on a contractual basis only.

International Dangerous Goods (IDG)

UPS accepts IDGs on a contract basis only. The “UPS Guide for Shipping International Dangerous Goods” should always be used in conjunction with the most current IATA “Dangerous Goods Regulations.” UPS only transports Dangerous Goods to and from IDG countries and territories. The Dangerous Goods Service handling charge applies to all packages and palletized shipments that require a “Shipper’s Declaration for Dangerous Goods.” Refer to page 123 for fees.

Notes:

- UPS Worldwide Express Freight® Midday and UPS Worldwide Express Freight services are included unless otherwise noted.
- Hazardous Materials are not accepted for transportation using UPS® Simple Rate, UPS Ground with Freight Pricing or UPS Worldwide Expedited Ground Freight.
- For shipping Dangerous Goods and Hazardous Materials via Air Freight, refer to the “UPS Air Freight Terms and Conditions of Contract for UPS Air Freight Services in the United States, Canada and International” at ups-scs.com/terms or call 1-800-443-6379 for more information.
- UPS Freight® Services are governed by the UPS Freight Rules Tariff for Less-Than-Truckload transportation. For full details and updates, refer to upsfreight.com/tariff.
- For additional service restrictions, refer to the “UPS Tariff/Terms and Conditions of Service – United States” available at ups.com/terms.

Domestic, Export and Import Service Restrictions

PACKAGE

Prohibited and Restricted Goods

Alcoholic Beverages

Packages containing alcoholic beverages (beer, wine or spirits) are accepted for transportation only on a contractual basis. Shippers must be licensed and authorized under applicable law to ship alcoholic beverages.

Alcoholic beverages are accepted for transportation only to certain states. To receive service for packages containing alcoholic beverages, the shipper must enter into, and agree to, the provisions set forth in the approved UPS agreement for the transportation of alcoholic beverages shipments. Shipments containing alcoholic beverages can be delivered to an alternate address via UPS Delivery Intercept® service or redirected to a UPS Access Point® Location via the UPS My Choice® tool.

C.O.D.

Collect on Delivery (C.O.D.) service is not available for UPS Express Critical® or international services except for U.S. imports from Canada. C.O.D. service is not available for UPS Worldwide Express Freight MIDDAY and UPS Worldwide Express Freight services. C.O.D. service is also not available when using a UPS 3 Day Select® or a UPS® Ground shipping document.

Firearms, Ammunition and Weapons

Firearms, ammunition and weapons (including inert and replica explosive weapons) will be accepted for transportation only according to the "UPS Tariff/Terms and Conditions of Service – United States" available at [ups.com/terms](https://www.ups.com/terms).

Jewelry, Unset Precious Stones and Industrial Diamonds

International jewelry shipments, and shipments of unset precious stones or industrial diamonds, are subject to maximum declared value restrictions that vary by destination as set forth at [ups.com/jewelry](https://www.ups.com/jewelry).

Maximum Length

The maximum length per domestic, export or import package is 108 inches. There are no maximum length restrictions for UPS Express Critical packages.

Maximum Size

The maximum size per domestic, export or import package is 165 inches in length plus girth [(2 x width) + (2 x height)] combined. The maximum size per UPS® Simple Rate package is 1,728 cubic inches. For irregularly shaped packages, refer to page 17 for instructions. UPS Worldwide Express Freight MIDDAY and UPS Worldwide Express Freight pallets are subject to maximum size restrictions (which vary by origin and destination) as set forth at [ups.com/assets/resources/media/wwef_max_dim.pdf](https://www.ups.com/assets/resources/media/wwef_max_dim.pdf). Prior approval is required to ship UPS Worldwide Express Freight MIDDAY and UPS Worldwide Express Freight shipments exceeding maximum size and weight restrictions. There are no maximum size restrictions for UPS Express Critical packages.

Maximum Declared Values

Shippers are prohibited from shipping, and UPS does not accept for transportation, packages having a value of more than \$50,000.00 except for a package eligible for the Enhanced Maximum Declared Value of \$70,000.00 per package, as set forth in the "UPS Tariff/Terms and Conditions of Service – United States" available at [ups.com/terms](https://www.ups.com/terms). A package is eligible only if it is a domestic UPS Next Day Air® delivery service shipment, is tendered pursuant to shipper's scheduled pickup service, is processed for shipment using a UPS Shipping System (declarations of value on paper source documents are not eligible) and does not contain hazardous materials or a perishable commodity. For UPS Worldwide Express Freight MIDDAY and UPS Worldwide Express Freight services, UPS does not accept for transportation pallets having a value of more than

\$100,000.00 per pallet. Additionally, more restrictive value limits apply for certain packages and pallets.

Refer to the "UPS Tariff/Terms and Conditions of Service – United States" available at [ups.com/terms](https://www.ups.com/terms) for more information on maximum allowable values and liability limitations.

Maximum Weight

For domestic package shipments, the maximum actual weight per package is 150 pounds. The maximum actual weight per UPS Simple Rate package is 50 pounds.

For international shipments, the maximum weight of a package may vary by destination or origin. UPS Worldwide Express Freight MIDDAY and UPS Worldwide Express Freight pallets are subject to maximum weight restrictions (which vary by origin and destination) as set forth at [ups.com/assets/resources/media/wwef_max_dim.pdf](https://www.ups.com/assets/resources/media/wwef_max_dim.pdf). Prior approval is required to ship UPS Worldwide Express Freight MIDDAY and UPS Worldwide Express Freight shipments exceeding maximum size or weight restrictions. There are no maximum weight restrictions for UPS Express Critical packages. Call the UPS International Customer Service Center at 1-800-782-7892 for more information.

Maximum Weight for a Hazardous Materials and International Dangerous Goods Package

The maximum weight for a Hazardous Materials and International Dangerous Goods package is 70 pounds, unless further restricted by the regulations set forth in 49 C.F.R. or IATA regulations. Maximum weight for a non-Hazardous Materials package shipment containing dry ice is 150 pounds. Consult the "UPS Guide for Shipping Ground and Air Hazardous Materials" at [ups.com/hazmat](https://www.ups.com/hazmat) or call the Hazardous Materials Support Center at 1-800-554-9964 for more information.

Notes:

- UPS Worldwide Express Freight® MIDDAY and UPS Worldwide Express Freight® services are included unless otherwise noted.
- For Air Freight or UPS Worldwide Expedited® Ground Freight service restrictions, refer to [ups-scs.com/terms](https://www.ups.com/terms).
- UPS Freight® Services are governed by the UPS Freight Rules Tariff for Less-Than-Truckload transportation. For full details and updates, refer to [upsfreight.com/tariff](https://www.upsfreight.com/tariff).
- For additional service restrictions, refer to the "UPS Tariff/Terms and Conditions of Service – United States" available at [ups.com/terms](https://www.ups.com/terms).

Domestic, Export and Import Service Restrictions

PACKAGE

Prohibited and Restricted Goods (continued)

Restricted and Prohibited Articles (Export and Import)

It is the shipper's responsibility to comply with current government regulations or laws applicable in each country.

Shipments are subject to inspection and possible delay by customs officials or representatives of other government agencies. Certain countries and territories have additional prohibited or restricted articles. For more information, call the UPS International Customer Service Center at 1-800-782-7892.

The following items are restricted for international shipping. They may be shipped into the U.S., and to countries and territories outside the U.S., only where service is allowed on a contractual basis:

- Alcoholic beverages
- Animal products, non-domesticated (e.g., mother of pearl inlay, snakeskin watch bands)
- Articles of high/unusual value
- Biological substances, Category B and exempt human or animal specimens
- Dangerous goods
- Firearms and weapons (including inert and replica explosive weapons)
- Furs
- Gold or other precious metals
- Live animals*
- Perishables
- Personal effects**
- Plants
- Seeds
- Tobacco and Vaping Products

The following items are not accepted for transportation by UPS into the U.S. or to countries and territories outside the U.S.:

- Ammunition (except as expressly provided in the "UPS Tariff/Terms and Conditions of Service – United States" available at [ups.com/terms](https://www.ups.com/terms).)
- Bank bills, notes or currency (other than coin)
- Corpses, cremated or disinterred remains

- Fireworks
- Hazardous waste
- Ivory
- Marijuana, including marijuana intended for medicinal use
- Postage stamps
- Shark fins
- Shipments prohibited by law

Tobacco and Vaping Products

Shipments containing tobacco products ("Tobacco Product Shipments") are accepted for transportation only from shippers who are licensed and authorized to ship tobacco products pursuant to applicable laws. UPS does not provide service to any person or entity listed in the Bureau of Alcohol, Tobacco, Firearms and Explosives PACT Act – Non-Compliant List.

The term "Tobacco Products" is defined at [ups.com/tobacco](https://www.ups.com/tobacco). Shippers should consult [ups.com/tobacco](https://www.ups.com/tobacco) for the current definition of tobacco products, as the definition may change periodically. At present, and without limiting the complete definition posted at [ups.com/tobacco](https://www.ups.com/tobacco), the term "Tobacco Products" includes any product made or derived from tobacco that is intended for human consumption, including any component, part or accessory of a tobacco product; the term includes, without limitation, e-cigarettes, e-hookah, e-cigars, vape pens, advanced refillable personal vaporizers and electronic pipes.

UPS prohibits the shipment of Cigarettes or Little Cigars (as those terms are defined at [ups.com/tobacco](https://www.ups.com/tobacco)) to consumers. UPS also prohibits the shipment of all Vaping Products (as the term is defined at [ups.com/tobacco](https://www.ups.com/tobacco)) throughout its U.S. domestic network, including import and export, regardless of nicotine content and destination state. To make other Tobacco Product Shipments, the shipper must sign, agree to and comply with the provisions set forth in an approved UPS agreement for

the transportation of Tobacco Products. Shippers and receivers must comply with all applicable federal, state, provincial or local laws or regulations, and all Tobacco Product Shipments must conform to the terms, conditions, restrictions and prohibitions set forth at [ups.com/tobacco](https://www.ups.com/tobacco) at the time of shipping. It is the responsibility of the shipper to ensure that a shipment tendered to UPS, including a Tobacco Product Shipment, does not violate any federal, state, provincial or local laws or regulations applicable to the shipment.

All shipments, including shipments containing Tobacco Products, will be accepted for transportation only according to the "UPS Tariff/Terms and Conditions of Service – United States" available at [ups.com/terms](https://www.ups.com/terms).

Tobacco Products may not be shipped from a UPS Drop Box, UPS Customer Center, UPS Alliance Location (Staples), locations of The UPS Store®, any UPS Authorized Shipping Outlet or UPS Access Point® location. Please visit [ups.com/tobacco](https://www.ups.com/tobacco) for more information.

UPS Returns®

UPS Returns Services are not provided via UPS Next Day Air Saver® or UPS 2nd Day Air A.M.® service levels. UPS Returns Service options for UPS® Simple Rate are limited to UPS Print Return Label Service only. Hazardous Materials or Dangerous Goods packages, pallets requiring shipping papers and packages containing firearms cannot be retrieved via UPS Returns Services. Biological substances and dry ice can be retrieved via UPS Returns Services. No other restricted or prohibited articles may be retrieved with UPS Returns Services. Refer to [ups.com/terms](https://www.ups.com/terms) for value limits on UPS Returns Services shipments. Multiple-piece shipments are not available for UPS Returns Services shipped within the 50 states and Puerto Rico.

Notes:

- UPS Worldwide Express Freight® Midday and UPS Worldwide Express Freight® services are included unless otherwise noted.
- For Air Freight or UPS Worldwide Expedited® Ground Freight service restrictions, refer to [ups.com/terms](https://www.ups.com/terms).
- UPS Freight® Services are governed by the UPS Freight Rules Tariff for Less-Than-Truckload transportation. For full details and updates, refer to [upsfreight.com/tariff](https://www.upsfreight.com/tariff).
- For additional service restrictions, refer to the "UPS Tariff/Terms and Conditions of Service – United States" available at [ups.com/terms](https://www.ups.com/terms).
- *Select live animals may be shipped only pursuant to the restrictions and conditions set forth at [ups.com/animals](https://www.ups.com/animals).
- **Limited shipping of personal effects is available at The UPS Store and any UPS Customer Center.

How To Use This Guide

Section 1 CHOOSING A SERVICE

PAGES [3-9](#)

Section 2

PREPARING A SHIPMENT

Information about how you package a shipment, determine the rate and get the shipment to UPS are provided.

- Review tips for special packaging. Pages [11-15](#)
 - Determine the weight and size. Pages [16-20](#)
 - Select automated or manual processing options, including online shipping solutions, shipping documents and the UPS Waybill. Pages [21-22](#)
 - Arrange for a UPS pickup or drop-off at a variety of locations that accept UPS packages. Pages [23-24](#)
-

Section 3 DETERMINING THE RATE

PAGES [25-136](#)

Section 4 TRACKING AND PAYMENT

PAGES [139-144](#)

Special Packaging Needs

PACKAGE

If you ship the following items, consider their special packaging needs.

Batteries

A variety of batteries are regulated as hazardous materials by the U.S. Department of Transportation (DOT) and International Air Transport Association (IATA). For assistance in determining whether or not your battery shipment is regulated, please call the DOT's Hazardous Materials Info-line at 1-800-467-4922. Batteries requiring shipping papers may only be tendered by contract hazmat shippers. (See the "UPS Guide for Shipping Ground and Air Hazardous Materials" at [ups.com/hazmat](https://www.ups.com/hazmat).) Any device with batteries installed must have its on/off switch protected from being activated or have the batteries removed with the terminals protected. Simple devices like flashlights or rechargeable drills can generate a dangerous amount of heat if accidentally activated. Electronic items sent for repair, such as computers and cell phones, should be sent without batteries. For additional information regarding the shipment of batteries, please go to [ups.com](https://www.ups.com) and enter "Batteries" in the search field. For current lithium battery regulations, please refer to [ups.com/batteries](https://www.ups.com/batteries).



Bundled or Strapped Boxes

Only same-sized boxes may be strapped together. Use a minimum of four crisscrossed bands, two in each direction. An address label must be placed on each box. When strapping boxes together, each box must be strong enough to hold the total weight of the strapped bundle. For example, if two 15-pound boxes are banded together into a 30-pound package, both components should be in boxes with at least a 30-pound weight capacity. An Additional Handling charge may apply. Refer to page [122](#) for more information.



Electronic Media

To ship electronic media that contain sensitive personal information (such as personal financial or health information), we recommend that you do not use an envelope, letter packaging, UPS Express® Envelope, UPS Express® Envelope – Reusable, UPS Express® Pak or UPS Express® Pad Pak. UPS provides special packaging, the UPS Express® Hard Pak – Secure, which is designed to help you ship sensitive electronic media. Call 1-800-PICK-UPS® (1-800-742-5877) or your sales representative for more information. You can also ship electronic media containing sensitive personal information by packaging it with a duplicate shipping label in an inner container that can be securely sealed. Place the inner container in a new outer corrugated box. Seal all flaps securely. Prior to packaging, mark the electronic media with identifiable information, such as your company name, reference number or your UPS shipping number. Additionally, the shipper should retain a copy of the data and secure the data on the electronic media through encryption or other technological means.



Fabric and Wallpaper

Rolled goods travel best when shipped in corrugated boxes. If a fabric or wallpaper roll is shipped in a bag, UPS recommends a bag with a minimum thickness of six mils. Make sure the bag is tightly wrapped and taped against the roll to reduce the risk of tearing. A tail on an item shipped in a bag must be compressed to the body of the item using tape. Place the address label on a flat surface of the item being shipped. Place duplicate address labels inside cores or between top layers of material. An Additional Handling charge may apply. Refer to page [122](#) for more information.



If you have highly sensitive or confidential material, UPS Express Critical® shipping offers a same-day service to handle your specialized needs. To get more information, please call 1-800-714-8779 or speak with your sales representative.

Special Packaging Needs

PACKAGE

Irregularly Shaped Items and Bare Metals

Tape the address label on a flat surface of the item being shipped. Cover the label with clear tape. Do not use “flying tags” attached by string or metal. Blunt all sharp or protruding edges with taped-on, corrugated cardboard pieces. Protect the surface of the item as needed. An Additional Handling charge will apply. Refer to page [122](#) for more information.

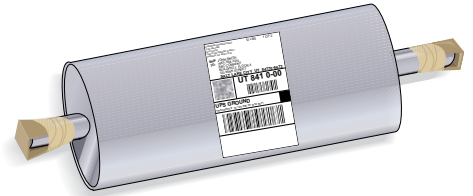

Large and/or Heavy Packages

Packaging materials need to be evaluated carefully for packages weighing more than 70 pounds.

A UPS Heavy Package sticker is required whenever you ship packages weighing more than 70 pounds. Place the sticker to the right of the address label and write the package's weight in the white box. It also helps to highlight every side of your package with Heavy Package highlight tape. This sends a warning to those who risk lifting your package, both your employees and ours. Customers with a UPS account can request supplies, free of charge. [Order Supplies and Forms](#) by visiting [ups.com](#). Refer to page [122](#) for fees.



Tires

Apply a wide band of pressure-sensitive tape through the center and completely around the body of the tire so that the tape is attached to itself. Attach your address label to the tape band where it covers the tread. Cover the entire label with clear tape. An Additional Handling charge will apply. Refer to page [122](#) for more information.



Packaging Assistance

Packaging Advisor

The Packaging Advisor is an online tool that takes the guesswork out of packing and helps you determine just what you need by walking you through industry guidelines. Depending on your entries, the Packaging Advisor will provide guidelines about exterior carton, interior cushioning, product placement, closure and shipping label placement. Visit [ups.com/packaging](#).

UPS Package Design and Test Lab

The UPS Package Design and Test Lab helps customers find effective, sustainable and cost-efficient packaging for products. Packaging engineers evaluate the current or proposed package, conduct a variety of industry-accepted tests and prepare a written report that recommends modifications to improve performance, economy and efficient use of materials. The UPS Package Design and Test Lab also monitors the latest developments in package-testing research worldwide. And the UPS Package Design and Test Lab can assist in finding environmentally friendly packaging solutions that provide adequate product protection. Contact the UPS Package Design and Test Lab at 1-877-877-7229 for more details and pricing information.

Packing Services

Have your items organized and expertly packed at your nearest location of The UPS Store®. Many locations of The UPS Store also offer custom handling and packaging for large items – from blanket wrap to custom cartons and crating. Regardless of the size and shape of your items, locations of The UPS Store can handle your shipping needs, including LTL shipments. With the Pack & Ship Guarantee, participating locations will pack your item, ship via UPS, and if that item is damaged or lost in transit, you'll be reimbursed. Visit [theupsstore.com/guarantee](#) for details. For more information on all the services available at The UPS Store or to find a location near you, please visit [theupsstore.com](#).

Packaging Guidelines

UPS WORLDWIDE EXPRESS FREIGHT® MIDDAY, UPS WORLDWIDE EXPRESS FREIGHT®, UPS WORLDWIDE EXPEDITED® GROUND FREIGHT, AIR FREIGHT AND LESS-THAN-TRUCKLOAD

Preparing Your Freight Shipment

UPS Worldwide Express Freight Midday and UPS Worldwide Express Freight (“UPS Worldwide Express Freight Services”)

UPS Worldwide Express Freight Services are for palletized shipments. Pre-authorization is required for all pallets exceeding maximum size or weight restrictions (which vary by origin and destination) as set forth at [ups.com/assets/resources/media/wwef_max_dim.pdf](https://www.ups.com/assets/resources/media/wwef_max_dim.pdf). For UPS Worldwide Express Freight Services, scheduling a pickup or drop-off is required on all shipments through WorldShip®, [ups.com](https://www.ups.com) shipping and UPS CampusShip® systems, a UPS Ready® solution, UPS® Developer Kit, [ups.com](https://www.ups.com) or by calling 1-800-782-7892.

Air Freight, LTL and UPS Worldwide Expedited Ground Freight

Air Freight, LTL and UPS Worldwide Expedited Ground Freight shipments can include combinations of palletized items or boxes that are too large to ship using other UPS services. They can also include multiple non-palletized pieces. UPS will accept freight shipments of any weight. However, minimum weight charges apply. Pre-authorization is required for Air Freight and UPS Worldwide Expedited Ground Freight shipments that exceed 120 inches in length, 84 inches in width, 76 inches in height or 5,000 pounds in weight.

Palletized Freight

Palletizing freight helps multiple-piece shipments remain together and provides increased protection from damage. Each pallet, including its contents, is considered one piece.

Non-Palletized Freight

Loose items, such as boxes or containers that have not been secured to a pallet, are considered non-palletized freight. Each loose item is considered one piece and can be shipped via Air Freight, LTL or UPS Worldwide Expedited Ground Freight services.

Palletizing Your Shipment

Pallets are portable rigid platforms used to consolidate shipments and allow for ease of freight movement. Quality pallets are commonly made of either wood or plastic and can weigh between 20 and 70 pounds. Pallets should be large enough to accommodate the shipment without

overhang. Anything overhanging the pallet edges may be damaged from punctures, abrasions and compression.

UPS Worldwide Express Freight Midday and UPS Worldwide Express Freight shipments must be palletized, stackable, able to be lifted by forklift

and shrink-wrapped or banded to the pallet. For Air Freight or UPS Worldwide Expedited Ground Freight shipments, if your non-palletized shipment does not meet the minimum billable weight per piece, consider palletizing prior to UPS pickup.

Step-by-Step

The following are basic step-by-step instructions for palletizing your freight shipments.

1. Select Pallets.

- Choose pallets large enough to prevent overhang of shipment pieces
- Pallets must be sturdy enough to support the load
 - Select pallets with closely spaced pallet deck boards
 - Never exceed the rated capacity of your pallet
- Do not select pallets with broken boards or protruding nail heads

Palletizing Your Shipment

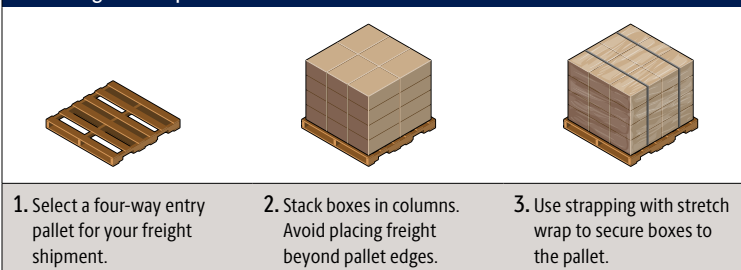

1. Select a four-way entry pallet for your freight shipment.

2. Stack boxes in columns. Avoid placing freight beyond pallet edges.

3. Use strapping with stretch wrap to secure boxes to the pallet.

- Pallets with four-way forklift entry are preferred as they help to improve handling and reduce damage to the shipment

2. Stack Boxes on Pallet.

For shipments that contain boxes or stackable pieces:

- Ensure cartons are new and of proper strength to withstand stacking

Many of The UPS Store® locations can handle LTL freight packaging and shipping for you. Visit theupsstore.com for more information.

Packaging Guidelines

UPS WORLDWIDE EXPRESS FREIGHT® MIDDAY, UPS WORLDWIDE EXPRESS FREIGHT®, UPS WORLDWIDE EXPEDITED® GROUND FREIGHT, AIR FREIGHT AND LESS-THAN-TRUCKLOAD

Step-by-Step (continued)

- Securely close, staple and/or seal cartons
- Protect product from internal vibration with proper amounts of dunnage within cartons; no void areas/spaces between product or on top of carton
- Remove old labels from shipping cartons and product
- Affix labels, with complete address information for the shipper and the consignee, to each piece
- Align boxes in columns, corner to corner, for the greatest stacking strength
- Avoid interlocking or rotating layer patterns
- Do not align corners over the spaces between pallet deck boards
- Boxes should not extend past the pallet edges
- Do not pyramid the boxes; keep the top layer flat to prevent damage from top loads
- Use a slip sheet under the load and every third layer when possible to

help distribute the weight evenly and protect the bottom layer

3. Secure Shipment to Pallet.

- Use a minimum of 60 gauge stretch wrap, five revolutions recommended; tie to pallet and across top to prevent shifting
- For Air Freight, LTL and UPS Worldwide Expedited Ground Freight, label all handling units with shipper/consignee information and PRO Numbers (at minimum all four vertical sides, interior and exterior of the stretch wrapping); use markers if having adhesion issues
- To ensure stability, corner boards and banding are recommended
- Use three-way locking – nailed corners (not staples) on crates; angle board must extend from the deck board to the top of the pallet load
- Insert layers of cardboard between layers of freight to absorb vibration; distribute the weight evenly

4. Label Shipment.

- For UPS Worldwide Express Freight Midday and UPS Worldwide Express Freight shipments, apply labels to each side of the pallet and on top of the pallet. Each label should have telephone numbers and complete address information, including postal code of the shipper and the consignee
- For Air Freight and UPS Worldwide Expedited Ground Freight, label each pallet with telephone numbers and complete address information, including postal code of the shipper and the consignee
- Ensure information on the Bill of Lading (BOL) matches the shipment
- Indicate in proper location on the BOL and check contract/tariff for liability limits if excess declared value is needed
- Do not pyramid, ship or accept prohibited items or freight that overhangs the pallet

Protecting Your Palletized Shipment from Damage

Solution	Description
Corner/Edge Boards	<ul style="list-style-type: none"> – Increase vertical stacking strength, prevent damage to corner edges and stabilize the load. – Should extend to the full height and length of the load and should be used on all corners.
Strapping or Banding	<ul style="list-style-type: none"> – Prevents pieces from getting lost or separated from the load. – Should be drawn tightly to the load, possibly requiring running it underneath the top deck boards of the pallet.
Stretch Wrapping	<ul style="list-style-type: none"> – Use as an effective way to keep all pieces of a shipment together. – Should first be applied around the pallet and continued upward around the load. – Must be tight to prevent load shifting. – Capture the pallet when wrapping bottom layer. – Designed to stabilize the load, not to secure it to the pallet. – Strapping or banding should be used in conjunction with stretch wrap to secure the load to the pallet.
Top/Bottom Load Protector	<ul style="list-style-type: none"> – Layers of corrugated fiberboard or heavy paperboard. – Use to help evenly distribute the weight of shipments that can be stacked upon one another.

For any additional assistance with freight packaging, contact the UPS Package Design and Test Lab at freight_testing@ups-psi.com or call 1-877-877-7229.

Packaging Guidelines

UPS WORLDWIDE EXPEDITED® GROUND FREIGHT, AIR FREIGHT AND LESS-THAN-TRUCKLOAD

Preparing Non-Palletized Freight

If you do not plan to secure your shipment to pallets, follow the steps below.

1. Ship freight in corrugated boxes (avoid reusing boxes), crates or shipping containers.
2. Use a container strong enough to support the weight of contents.

3. Use at least two inches of appropriate cushioning material to protect internal items from each other and the corners, sides, top and bottom of containers. Appropriate cushioning material would include corrugated fiberboard, multiple layers of folded newspaper, styrofoam sheets, packing blankets, etc.

4. Reinforce edges to protect from bending.

5. Securely seal closures and seams with reinforced tape.

6. Label each piece with telephone numbers and complete address information, including postal code of the shipper and the consignee.

Preparing for Pickup

Your freight pickup request is initiated when you Create a Shipment for freight using [ups.com](https://www.ups.com), WorldShip® or MyFreight shipping tools.

Some Air Freight and UPS Worldwide Expedited Ground Freight shipment pickup requests require pre-authorization.

Pickups for UPS Freight® LTL shipments can be requested using [ups.com](https://www.ups.com), [upsfreight.com](https://www.upsfreight.com) or WorldShip.

How to Label

Each piece of palletized or non-palletized freight must be clearly marked with telephone numbers and complete address information, including postal code of the shipper and the consignee. Indicate on freight labels if any pieces require C.O.D. service.

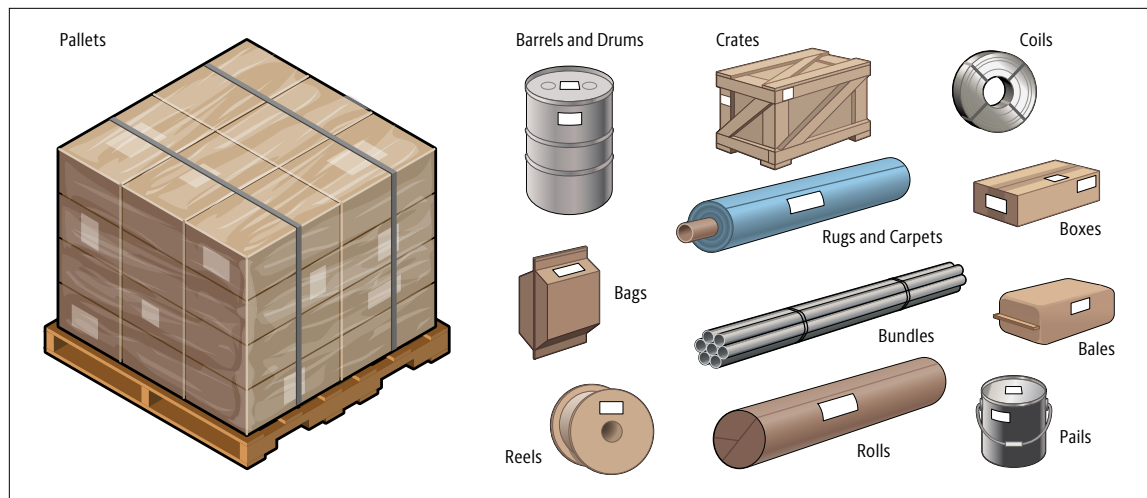

Note: UPS Worldwide Express Freight Services do not accept non-palletized freight shipments.

Determine the Weight and Size

PACKAGE

For All Domestic and International Shipments

The Determine the Weight and Size information on this page and the next page are for package shipments only. For information on how to determine the weight and size for UPS Worldwide Express Freight® Midday and UPS Worldwide Express Freight® shipments refer to page 18. For information on how to determine the weight and size for UPS® Simple Rate shipments, refer to page 72.

Shipping rates are based on package weight and size (explained below and on the following page) and origin-to-destination distance (refer to page 27 for Domestic, Export and Import).

Billable weight is the weight used to calculate the rate. For domestic and international services, the billable weight will be the greater of the dimensional weight compared to the actual weight.

How to determine billable weight.

1. Determine actual weight.

Actual weight is the package weight rounded up to the next whole pound.

Use a scale to determine the weight of the package. Round any fraction of a pound to the next whole pound for UPS Express® Envelopes (letters) over eight ounces and all other packages.

2. Determine dimensional weight.

Dimensional weight reflects package density, which is the amount of space a package occupies in relation to its actual weight. Dimensional weight may apply to all UPS domestic and international package services.

Determine the package dimensions in inches. For each dimension, measure at the longest point, rounding each measurement to the nearest whole number (for example, 1.00 to 1.49 will be considered 1, and 1.50 to 1.99 will be considered 2). The minimum measurement for each dimension is 1 inch.

Multiply the package length (longest side of the package) by the width by the height. The result is the cubic size in inches.

Divide the cubic size in inches by 139 to determine the dimensional weight in pounds. Increase any fraction to the next whole pound.

3. Determine billable weight.

Compare the package's actual weight to its dimensional weight. The greater of the two is the billable weight and should be used to calculate the rate.

For multiple-package shipments eligible for shipment pricing, total the billable weight of all packages in the shipment.

Notes:

- Shipment pricing is not available for a service unless specifically noted.
- For information on how to determine the rate applicable to UPS® Ground with Freight Pricing, see page 6 and visit ups.com/gfp.
- For information on how to determine the rate applicable to UPS Simple Rate shipments, see pages 72-73 and visit ups.com/simplerate.

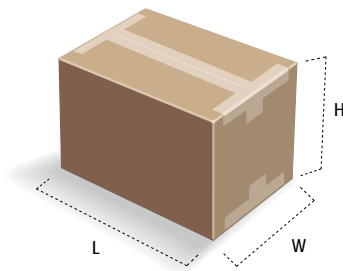

Dimensional Weight Calculation

$$\left[\begin{array}{l} \text{Dimensional Weight} \\ \text{in Pounds} \end{array} \right] = \frac{L \times W \times H}{139}$$

L = Length in inches

W = Width in inches

H = Height in inches

Determine the Weight and Size

PACKAGE

For All Domestic and International Shipments (continued)

Additional Information on Determining Weight and Size.

– **Letter rates** apply for domestic and international documents, correspondence and electronic media shipments that do not exceed eight ounces sent in a UPS Express® Envelope. Domestic Letters greater than eight ounces will be billed by weight (rounded up to the next whole pound). Export Letters greater than eight ounces and up to two pounds will be billed at UPS Express® Pak rates. Export Letters greater than two pounds and import Letters greater than eight ounces will be billed by weight (rounded up to the next whole pound).

– **UPS Express Pak rates** apply for export shipments that weigh two pounds or less, do not exceed \$100.00 in customs value and UPS Express Pak is selected at the time of shipping.

– Irregularly Shaped Packages:

If the package has a bulge or is irregularly shaped, measure the length, width and height of the package at its extreme points, which may include the bulge or irregular aspects of the package.

Treat the irregularly shaped package as if it were in a regular rectangular box. Measure the length, width and height of the package from its extreme points.

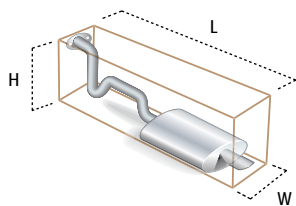

– Items Shipped in Bags:

Shape – When multiple items are shipped in a flexible container (e.g., burlap or plastic bag), the package measurements will be determined when the exterior is at rest. As this shape will differ from placement to placement, cubic size or package measurements will be made at the sole discretion of UPS.

Tails – A tail on an item shipped in a bag should be measured for the amount of space it takes up in a reasonably compressed fashion. Any tail that is created by placing an item in a bag must be compressed and taped to the body of the item.

– Packages that exceed UPS weight and size limits are not accepted for transportation. If found in the UPS system, they are subject to an Over Maximum Limits charge. UPS reserves the right in its sole and unlimited discretion to return such packages to the shipper at the shipper's expense. Refer to page 124 for more information. For Maximum Weight service restrictions, refer to page 8. For shipments over 150 pounds other than UPS Worldwide Express Freight® services, refer to pages 74-75 for Air Freight, page 6 for UPS Freight® Less-Than-Truckload or Coyote Logistics® Truckload and page 5 for UPS Worldwide Expedited® Ground Freight for more information.

– **A Large Package Surcharge** may apply to domestic and international shipments.

For domestic shipments, a package is considered a "Large Package" when its length (longest side of the package)

plus girth [(2 x width) + (2 x height)] combined exceeds 130 inches or its length exceeds 96 inches.

For international shipments, a package is considered a "Large Package" when its length (longest side of the package) plus girth [(2 x width) + (2 x height)] combined exceeds 130 inches.

Large Packages are subject to a minimum billable weight of 90 pounds. An Additional Handling charge will not be assessed when a Large Package Surcharge is applied.

– Shippers are responsible for providing accurate and complete shipment information on the shipping document or in the automated processing system used, including service selected, number, weight and dimensions of packages. UPS reserves the right to audit any package and/or invoice to verify service selection, package dimensions or weight and applicability of any charges. As part of that audit, UPS may weigh and measure any package tendered to UPS using any method UPS deems appropriate, including, but not limited to, multi-dimensional measuring devices. If any aspect of the shipment information provided by the shipper is incomplete or incorrect as determined by UPS in its sole and unlimited discretion, UPS may in its sole and unlimited discretion adjust charges at any time.

Follow the instructions on this page and the previous page to determine the billable weight for your package shipments. Refer to page 18 for UPS Worldwide Express Freight Services.

Notes:

- Size limits indicated by a box manufacturer may not reflect exterior dimensions of a package, including where a package may have bulges or otherwise may not be uniform across each plane, and should not be used as a substitute for actual length, width and height measurements in determining dimensional weight.
- Improper packaging may result in the alteration of a package's dimensions during transit which can affect the package's dimensional weight and result in a shipping charge correction.

WorldShip®, ups.com shipping, UPS CampusShip®, UPS Ready®, UPS marketplace shipping solutions and applications available in the UPS® Developer Kit will automatically calculate dimensional weight when you enter the package weight and dimensions.

To Destinations Worldwide

Determine the Weight and Size

UPS WORLDWIDE EXPRESS FREIGHT® MIDDAY AND UPS WORLDWIDE EXPRESS FREIGHT®

For International Palletized Shipments

Shipping rates are based on the shipment weight, including the weight of the pallet, and size and origin-to-destination distance (refer to page 27 for Export and Import).

Billable weight is the weight used to calculate the rate. The billable weight will be the greater of the dimensional weight as compared to the actual weight.

How to determine billable weight.

1. Determine actual weight.

Actual weight is the weight of the items on the pallet and the weight of the pallet, rounded up to the next whole pound.

Use a scale to determine the weight. Round any fraction of a pound to the next whole pound.

2. Determine dimensional weight.

Dimensional weight reflects pallet density, which is the amount of space a pallet occupies in relation to its actual weight. Dimensional weight may apply to all UPS Worldwide Express Freight Midday or UPS Worldwide Express Freight shipments.

Determine the pallet dimensions in inches. For each dimension, measure at the longest point, rounding each measurement to the nearest whole number (for example, 1.00 to 1.49 will be considered 1, and 1.50 to 1.99 will be considered 2). The minimum measurement for each dimension is 1 inch.

Multiply the pallet length by the width and by the height. The result is the cubic size in inches.

For export and import shipments, divide the cubic size in inches by 139 to determine the dimensional weight. Increase any fraction to the next whole pound.

3. Determine billable weight.

Compare the pallet's actual weight to its dimensional weight. The greater of the two is the billable weight and should be used to calculate the rate.

Additional Information on Determining Size and Weight.

– Pallets that exceed maximum size or weight restrictions (which vary by origin and destination) as set forth at [ups.com/assets/resources/media/wwef_max_dim.pdf](https://www.ups.com/assets/resources/media/wwef_max_dim.pdf) require prior approval, and are subject to an Oversize Pallet Handling Surcharge. Refer to page 124 for more information.

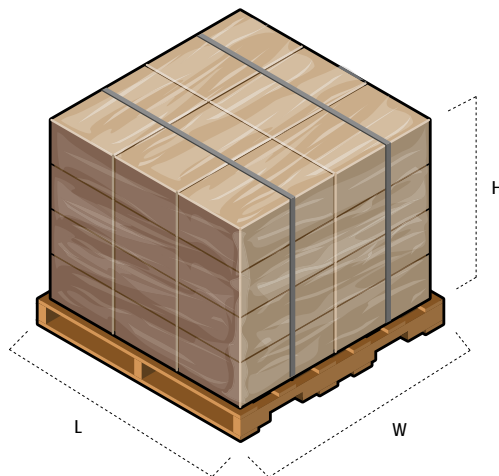

U.S. Export and Import

$$\left[\begin{array}{l} \text{Dimensional Weight} \\ \text{in Pounds} \end{array} \right] = \frac{L \times W \times H}{139}$$

L = Length in inches

W = Width in inches

H = Height in inches

Billable Weight Calculation

Customer has a shipment with 3 pallets weighing 600 pounds, 800 pounds and 1,000 pounds. All pallets are the same size with the following dimensions: 48 in. x 40 in. x 60 in.

1. Determine actual weight.

Actual Weight = 600 lbs. + 800 lbs. + 1,000 lbs. = 2,400 lbs.

2. Determine dimensional weight.

Pallet Dimensional Weight = $\frac{48 \text{ in.} \times 40 \text{ in.} \times 60 \text{ in.}}{139} = 829 \text{ lbs.}$

Shipment Dimensional Weight = 829 lbs. + 829 lbs. + 1,000 lbs. = 2,658 lbs.

3. Determine billable weight.

Shipment Billable Weight = 2,658 lbs.

To Destinations Worldwide

Determine the Weight and Size

AIR FREIGHT AND UPS WORLDWIDE EXPEDITED® GROUND FREIGHT

How to Determine Billable Weight*

Compare the freight shipment's minimum billable weight, actual weight and dimensional weight. The greatest of the three is the billable weight and should be used to calculate the rate.

1. Determine minimum billable shipment weight.*

- Minimum billable weight for loose items is the greater of minimum weight per shipment multiplied by the minimum weight per piece as set forth in the table below.

Service	Minimum Weight per Piece	Minimum Weight per Shipment
UPS Next Day Air® Freight	20 Pounds	151 Pounds
UPS Next Day Air® Freight NGS		
UPS 2nd Day Air® Freight		
UPS 2nd Day Air® Freight NGS		
UPS 3 Day Freight®		
UPS 3 Day Freight® NGS		
UPS Worldwide Expedited Ground Freight	N/A	551 Pounds

*The minimum billable shipment weight applies to all Air Freight services within and between the U.S., Canada and Puerto Rico. For UPS Worldwide Expedited Ground Freight, use minimum weight per shipment as defined above. For UPS Air Freight Direct® and UPS Air Freight Consolidated® services, a minimum shipment dollar amount is applied. Refer to the "UPS Air Freight Terms and Conditions of Contract for UPS Air Freight Services in the United States, Canada and International" at [ups-scs.com/terms](https://www.ups.com/terms) for more information or call 1-800-443-6379.

2. Determine actual weight and round up any fraction of a pound or kilo to the next whole pound or kilo.

3. Determine dimensional weight.

For each dimension, measure at the longest point, rounding each measurement to the nearest whole number. The minimum measurement for each dimension is 1 inch. Multiply the shipment length by the width by the height. The result is the cubic size. Divide the cubic size by the dimensional weight factor located in the matrix below to determine the dimensional weight.

Service	Origin	Destination	Dimensional Weight Factor (Inches/Pounds)	Dimensional Weight Factor (Centimeters/Kilos)
UPS® Air Freight Premium Direct	All	All	139	5,000
UPS Air Freight Direct UPS Air Freight Consolidated	All	All	166	6,000
UPS Next Day Air Freight UPS Next Day Air Freight NGS UPS 2nd Day Air Freight UPS 2nd Day Air Freight NGS UPS 3 Day Freight UPS 3 Day Freight NGS	PR, CA and U.S.	PR, CA and U.S.	139	5,000
UPS Worldwide Expedited® Air Freight	U.S.	MX	139	5,000
	MX	U.S.		
UPS Worldwide Expedited Ground Freight	U.S.	MX		
	MX	U.S.		

To convert metric measurements into pounds, multiply the result by 2.20462. To convert imperial measurements into kilos, multiply the result by 0.453592. Increase any fraction to the next whole pound or kilo.

The chart on the next page provides examples of billable weight calculations for Air Freight shipments.

To Destinations Worldwide

Determine the Weight and Size

AIR FREIGHT

Examples on How to Determine Billable Weight for Air Freight Shipments*

Freight Billable Weight: Minimum Billable Shipment Weight – Within and between the U.S., Canada and Puerto Rico											
Number of Pieces	Type	Length Each	Width Each	Height Each	Weight Each	Min. Billable Weight	Actual Weight	Dimensional Weight @ 139	Billable Weight		
5	Loose items	10"	10"	10"	20 lbs.	151 lbs.	100 lbs.	36 lbs.	151 lbs.		
Freight Billable Weight: Minimum Billable Weight Per Piece – Within and between the U.S., Canada and Puerto Rico**											
Number of Pieces	Type	Length Each	Width Each	Height Each	Weight Each	Min. Billable Weight	Actual Weight	Dimensional Weight @ 139	Billable Weight		
20	Loose items	10"	10"	10"	15 lbs.	20 lbs.	300 lbs.	144 lbs.	400 lbs.		
Freight Billable Weight: Actual Weight											
Number of Pieces	Type	Length Each	Width Each	Height Each	Weight Each	Min. Billable Weight	Actual Weight	Dimensional Weight @ 166	Dimensional Weight @ 139	Billable Weight	
20	Loose items	10"	10"	10"	25 lbs.	151 lbs.	500 lbs.	121 lbs.	144 lbs.	500 lbs.	
Freight Billable Weight: Dimensional Weight											
Number of Pieces	Type	Length Each	Width Each	Height Each	Weight Each	Min. Billable Weight	Actual Weight	Dimensional Weight @ 166	Dimensional Weight @ 139	Billable Weight	
2	Loose items	30"	25"	20"	70 lbs.	151 lbs.	140 lbs.	181 lbs.	216 lbs.	216 lbs.	
Freight Billable Weight: Using a Pallet***											
Number of Pieces	Type	Length Each	Width Each	Height Each	Shipment Weight	Pallet Weight	Min. Billable Weight	Actual Weight	Dimensional Weight @ 166	Dimensional Weight @ 139	Billable Weight
1	Pallet	35"	35"	35"	315 lbs.	40 lbs.	151 lbs.	355 lbs.	259 lbs.	309 lbs.	355 lbs.

*The minimum billable shipment weight applies to all Air Freight services within and between the U.S., Canada and Puerto Rico. For UPS Air Freight Direct® and UPS Air Freight Consolidated® services, a minimum shipment dollar amount is applied. Refer to the "UPS Air Freight Terms and Conditions of Contract for UPS Air Freight Services in the United States, Canada and International" at [ups.com/terms](https://www.ups.com/terms) for more information or call 1-800-443-6379.

**The minimum billable weight of 20 pounds per loose piece applies to Air Freight within and between the U.S., Canada and Puerto Rico only. If your non-palletized shipment does not meet the minimum weight of 20 pounds per piece, consider palletizing. Palletizing will ensure your shipment does not fall below the per-piece minimum billable charge.

***Pallet billable weight is equal to the shipment weight (315 pounds) plus the weight of a pallet (approximately 40 pounds).

Note: Each pallet with its secured contents is entered as one piece.

Shipping Solutions

Solution	Shipping Environment	Features and Benefits
AUTOMATED PROCESSING		
WorldShip® ups.com/worldship	Centralized Shipping (shipping room, warehouse)*	Full-featured Windows®-based software for Scheduled Pickup customers with high-volume shipping needs: <ul style="list-style-type: none"> – Process UPS package and freight shipments using a single application to obtain a rate quote, schedule pickups, process paperless trade documentation and track shipments. – Choose from several options for inputting shipment data, ranging from manual entry to fully automated, hands-free shipping. – Streamline shipment processing by customizing default settings to match your shipping preferences. – Connect WorldShip software to your accounting and customer service systems for seamless cross-functional communication. – Create custom labels with your company logo or promotional information.
ups.com shipping	Decentralized Shipping (distributed employees, front office, administrative staff, etc.)*	Print UPS labels from your PC via a secure online environment: <ul style="list-style-type: none"> – Web-based shipping system allows anyone in your company to ship from anywhere. – Process UPS package and freight shipments using a single application to obtain a rate quote, schedule pickups, process paperless trade documentation and track shipments. – One-step shipping with shipping preferences and the UPS address book. – View history, track and reprint your Air Freight and UPS Worldwide Expedited® Ground Freight waybill from one page. – Export your history to integrate with other systems. – No software or setup required. – Ship using a UPS account or a credit card or debit card or PayPal® account. – Complete a shipment without registering at ups.com.
UPS CampusShip®	Decentralized Shipping with Centralized Control (distributed employees, front office, administrative staff, etc., with administrator controls)*	Gain control and reporting of your employees' shipping activities in a secure environment, controlled by an administrator: <ul style="list-style-type: none"> – A customized web-based shipping system allows anyone in your company to ship or track from anywhere, but gives complete visibility and control to the shipping decision-maker. – Process UPS package and freight shipments using a single application to obtain a rate quote, schedule pickups, process paperless trade documentation and track shipments. – View history, track and reprint your Air Freight and UPS Worldwide Expedited Ground Freight waybill from one page. – Export your history to integrate with other systems. – No software required. – Visit ups.com/campusship, contact your local representative or call 1-800-PICK-UPS® (1-800-742-5877).
UPS marketplace shipping**	Decentralized Shipping solution powered by ups.com shipping (individual and small to medium businesses that sell on marketplaces)	A secure web-based shipping solution to easily view and ship all your online store orders from one location: <ul style="list-style-type: none"> – Automatically imports online orders from Marketplaces or direct web stores to UPS marketplace shipping. – Simplified shipment processing (Amazon support limited to Professional sellers only). – Ability to sequentially process multiple shipments and combine orders from same buyer and marketplace. – Automatically uploads tracking information back to the online store after processing. – For more information on UPS marketplace shipping visit ups.com.
MyFreight ups-scs.com	Decentralized Air Freight and UPS Worldwide Expedited Ground Freight Shipping (occasional)	A web-based Air Freight and UPS Worldwide Expedited Ground Freight shipping system: <ul style="list-style-type: none"> – A one-stop source to book shipments, request a pickup, create export documents and track shipments. – Perform online shipment initiation, rate quotes, tracking and event notification. – Track shipments using shipment or account numbers.
My LTL Freight upsfreight.com/forms	Decentralized LTL Shipping	Secure website for LTL shipping: <ul style="list-style-type: none"> – Create an electronic Bill of Lading, get account-specific negotiated rates and view shipping images. – Enables you to schedule a pickup, request delivery and pickup notifications and track a shipment.
Coyote Logistics® coyote.com	Truckload and Intermodal Freight Management Portal	Provides direct access for customers to create, view, track and settle their own loads, and for carriers to find, accept and update loads. <ul style="list-style-type: none"> – Network map includes filters to provide a focused, filtered view and ability to hover over lane to see lane information. – Streamlined accounting features allows for uploading paperwork, viewing invoices and checking accounting status. – Customizable load board allows users to add or remove columns to view the most valuable information. – Call 1-877-626-9683 or coyote.com/technology for more information.

*Applies to all UPS services except UPS Express Critical®, Truckload, Intermodal, Ocean Freight shipping. UPS® Simple Rate shipments may not be available through all UPS shipping systems.

**UPS marketplace shipping is not sponsored or endorsed by participating third-party marketplaces. Your use of the third-party marketplace remains subject to any applicable policies and terms and conditions of that third-party marketplace.

Notes:

- Hazardous Materials requiring shipping papers and International Dangerous Goods requiring a "Shipper's Declaration for Dangerous Goods" are not accepted through the UPS CampusShip shipping system.
- For Air Freight and UPS Worldwide Expedited Ground Freight services accessed through UPS CampusShip or ups.com shipping systems, a UPS call center or UPS Customer Center, a valid UPS six-character account number or a nine-digit UPS Supply Chain Solutions® account number is required for all shipments.
- The UPS Ready Program allows third-party business and shipping applications to integrate UPS technology, providing customers access to UPS products and services through out-of-the-box integrated solutions.

Shipping Solutions

Solution	Shipping Environment	Features and Benefits
AUTOMATED PROCESSING (continued)		
UPS® Mobile App for Android® and iOS® Devices*	Decentralized Mobile Package Shipping (distributed employees, professionals on the road)	<p>Supports shipments originating from 83 countries and territories. Create shipments when you are on the go:</p> <ul style="list-style-type: none"> – Process package shipments using supported smartphones. – Same login as ups.com. – Access to ups.com shipping optimized for mobile users. – Use the stored information from your UPS address book, shipping and payment preferences. – Shipping label options include: e-mail a shipping label, print from phone and mobile barcode. – Use your UPS account, credit card, debit card or electronic payment method. – Visit ups.com/mobile to learn more or to download the app.
Coyote Logistics® CoyoteHOWL® Mobile App for Shippers	Mobile Truckload and Intermodal Shipping	<p>CoyoteHOWL® mobile app is an internally developed, constantly evolving customer support tool that allows shippers to easily connect with their Coyote reps and access shipments, documents and business trends right from their mobile phones. It offers ability to receive load updates via push notifications and provides shippers free, on-the-go visibility 24/7. Visit noexcuses.coyote.com/CoyoteHOWL to learn more.</p>
UPS® Developer Kit	Integrated Enterprise and e-Commerce Applications**	<ul style="list-style-type: none"> – Suite of Application Programming Interfaces or APIs that provides your programmers and integrators flexibility when integrating UPS shipping functionality directly into your business systems and websites. APIs improve efficiencies through automation of business processes: <ul style="list-style-type: none"> • Utilizes XML and web services technologies. • Gives you access to as many UPS services as you choose. – Other UPS Developer Kit APIs include: Address Validation, Locator (and Plug In), Pickup, Quantum View®, Rating, Tracking (Signature Tracking®), Time in Transit and UPS TradeAbility®.
UPS Smart Label®	Provided by WorldShip®, ups.com shipping, UPS CampusShip® shipping systems, the UPS® Developer Kit and UPS Ready® solutions.	<p>UPS Smart Label data includes barcodes and routing codes that help ensure accurate routing and prompt delivery of your shipments. In addition, the use of UPS Smart Label technology allows for fast access to tracking and delivery information. We also offer printers for UPS Smart Label thermal printing. UPS account holders can rent a thermal label printer for \$3.00 per week by calling 1-800-PICK-UPS® (1-800-742-5877).</p>
Solution Features and Benefits		
MANUAL PROCESSING – PACKAGE		
Air Shipping Documents (ASDs)		<ul style="list-style-type: none"> – Available for UPS Next Day Air® Early, UPS Next Day Air®, UPS Next Day Air Saver®, UPS 2nd Day Air A.M.® and UPS 2nd Day Air® services. May also be used for UPS Worldwide Express® service. Does not apply to UPS® Simple Rate shipments. – To request an ASD, visit “Order Supplies” from the left side of the ups.com homepage. – For Saturday Delivery, each UPS Express® Envelope or package must bear a Saturday Delivery routing label.
UPS 3 Day Select® and UPS® Ground Shipping Documents		<ul style="list-style-type: none"> – Attach the completed form to the package and schedule a pickup via ups.com. – A \$5.00 per-package shipping document processing (S.D.P.) fee applies whenever a shipping document is used for UPS 3 Day Select or UPS Ground shipments. – To request a shipping document, visit “Order Supplies” at ups.com. – Does not apply to UPS® Simple Rate shipments.
UPS Worldwide Services Waybill		<ul style="list-style-type: none"> – Designed for international shipments: <ul style="list-style-type: none"> • Detailed information fields to fully address your shipment. • Various billing options to specify how payment of charges is handled. • Shipment-level detail enables shipment pricing and shipment tracking. • With proper authorization, U.S. Electronic Export Information (E.E.I.) will be filed electronically by UPS on your behalf. Refer to page 116 for fees. – When you use a UPS Worldwide Services Waybill for UPS Worldwide Express Freight® Midday or UPS Worldwide Express Freight® shipments, use one per shipment. <ul style="list-style-type: none"> • Packages within the pallet do not require an address label or UPS Worldwide Services Tracking Label. • For all shipments, call 1-800-782-7892 or go to ups.com to schedule pickup or drop-off. – When you use a UPS Worldwide Services Waybill for multiple-package or multiple-pallet shipments to the same recipient, only the lead package or pallet requires a waybill. <ul style="list-style-type: none"> • Each additional package or pallet must have an address label and a UPS Worldwide Services Tracking Label. • Detailed preparation instructions are printed on the reverse side of the waybill. – To request a UPS Worldwide Services Waybill, visit ups.com.
MANUAL PROCESSING – LTL		
Bill of Lading		<ul style="list-style-type: none"> – The Bill of Lading, usually prepared by the shipper, serves as a contract and provides all the information that UPS needs to transport the shipment. You can use ups.com shipping, WorldShip, UPS CampusShip or My LTL Freight shipping tools to process LTL shipments and quickly create an electronic Bill of Lading.

*Not available for UPS Worldwide Express Freight Services or UPS Simple Rate.

**Applies to all UPS services except UPS Express Critical®, Truckload, Intermodal, Ocean Freight or UPS Simple Rate shipments.

Note: Hazardous Materials and Dangerous Goods service is not available when using manual documentation (Air Freight and LTL are supported).

Pickup and Drop-off Availability

Arrange for a UPS Pickup

Method	Description
PACKAGE	
Scheduled Pickup*	<ul style="list-style-type: none"> – UPS offers the greatest number of reliable and convenient pickup options: <ul style="list-style-type: none"> • Daily Pickup • Daily On-Route Pickup • UPS Smart Pickup® service • Day-Specific Pickup – Refer to page 120 (domestic shipments). – Not available for UPS Worldwide Express Freight® Services.
UPS On-Call Pickup®	<ul style="list-style-type: none"> – With one pickup request, UPS will pick up all of your packages – Air, International, UPS 3 Day Select® and Ground services. – Schedule a same-day or future-day pickup. – UPS On-Call Pickup service gives you the convenience of having your shipment picked up at your home or office by scheduling a pickup via ups.com. – Fees are applied per pickup request regardless of the number of packages being picked up. – Refer to page 118 for domestic and export shipment fees. <p>UPS Worldwide Express Freight® Midday and UPS Worldwide Express Freight</p> <ul style="list-style-type: none"> – Pickup or drop-off must be scheduled for each UPS Worldwide Express Freight Midday or UPS Worldwide Express Freight shipment via WorldShip® or UPS CampusShip® shipping systems, ups.com shipping, a UPS Ready® solution, UPS® Developer Kit, ups.com or by calling 1-800-782-7892. – UPS Worldwide Express Freight Midday and UPS Worldwide Express Freight pickups cannot be combined with Air, International or UPS 3 Day Select services package pickup. – No additional fees are applied for pickup requests.
AIR FREIGHT AND UPS WORLDWIDE EXPEDITED® GROUND FREIGHT	
UPS Supply Chain Solutions® Call Centers	<ul style="list-style-type: none"> – Call 1-800-443-6379 to schedule a pickup.
UPS FREIGHT® SERVICES	
UPS Freight® LTL	<ul style="list-style-type: none"> – UPS Freight LTL 1-800-333-7400 – LTL Guaranteed 1-800-333-7400 – LTL Guaranteed A.M. 1-800-333-7400 – LTL Urgent 1-800-644-0900 – UPS® Standard LTL 1-800-333-7400 – Trade Show 1-800-988-9889 – Temperature Protection 1-800-644-0900
Pickup Notifications for LTL	<ul style="list-style-type: none"> – UPS Freight LTL pickups scheduled via WorldShip shipping system, ups.com and upsfreight.com include the option to receive Pickup Notifications at no additional cost. Pickup Notifications provide near real-time visibility of the status of a scheduled pickup, providing vital supply chain information to the pickup scheduler and shipper. – Available for direct point service areas within the 48 contiguous states. – When scheduling a pickup, users can choose up to five e-mail addresses to receive notifications for any and all of the following: <ul style="list-style-type: none"> • Pickup Scheduled • Driver en Route • Pickup Completed • Pickup Exception
COYOTE LOGISTICS®	
Truckload and Intermodal	<ul style="list-style-type: none"> Call 1-877-626-9683 or visit coyote.com.

*Service for Hazardous Materials and International Dangerous Goods requiring shipping papers or "Shipper's Declaration for Dangerous Goods" is offered on a contractual basis. Only customers with a Scheduled Pickup account are eligible for these services. Such shipments may not be tendered to a Third-Party Retailer or UPS Access Point® location. Please consult the Hazardous Materials Support Center at 1-800-554-9964 for specific regulatory and service level requirements.

Pickup and Drop-off Availability

Find Locations for Package, UPS Worldwide Express Freight® Midday and UPS Worldwide Express Freight® Shipments

Location	Description
UPS Access Point® (in select areas only)	<p>UPS Access Point locations are independently owned businesses or locations, including local businesses, participating The UPS Store® locations and lockers, that offer package pickup and, where available, drop-off of pre-paid UPS packages.</p> <ul style="list-style-type: none"> – After a first unsuccessful delivery attempt to a consumer's home address, UPS may deliver eligible packages to a nearby UPS Access Point location for the consumer to pick up. – Hours of operation vary by location (many UPS Access Point locations offer evening and weekend hours; visit ups.com for specific details). – Receiving packages: A government-issued photo ID will be required to collect the package. <p>Ship to a UPS Access Point Location Service:</p> <ul style="list-style-type: none"> – Available to all shippers with a valid UPS small package account number. – Available with all UPS small package shipping services* and most value-added services. – Shippers can integrate a UPS Locator into their e-commerce platforms, allowing their customers to select the UPS Access Point delivery location that is most convenient for them. – Only shippers with an approved UPS agreement for transportation of wine/beer/tobacco may ship wine/beer/tobacco to a UPS Access Point location, subject to limitations set forth at ups.com/wine, ups.com/beer and ups.com/tobacco. – For more information and restrictions, go to: ups.com/media/en/ShiptoUPSAccessPointlocation_US_EN.pdf. <p>Additional Service Options for Shipment to a UPS Access Point Location:</p> <ul style="list-style-type: none"> – Deliver to Addressee Only – For added security, the shipment may only be picked up by the person identified on the shipping label (pickup by any third party is not permitted). – Package Release Code – For combined flexibility and security, enter a four- to six-digit numerical code when preparing a shipment and provide the code to the person you want to pick it up. The code is known only to you and the person you provide it to. <p>UPS Access Point Location Restrictions:</p> <ul style="list-style-type: none"> – Packages delivered to a UPS Access Point locker must not exceed 22 inches by 21 inches by 16 inches. Drop-off packages at a UPS Access Point locker are subject to the same dimensional requirement and cannot exceed 44 pounds in weight. – All other packages cannot exceed 44 pounds in weight and the longest side must not exceed 38 inches, and the package must not exceed 130 inches in length plus girth combined. Drop-off packages at The UPS Store locations are subject to the maximum size and weight restrictions set forth in the "UPS Tariff/Terms and Conditions of Service – United States" available at ups.com/terms. For a broader set of shipping solutions, visit your local The UPS Store. – Packages may not have a value of \$5,000.00 or more if delivered or shipped to a UPS Access Point location or a value of \$1,000.00 or more if dropped off as pre-paid UPS packages. – Packages containing restricted or prohibited articles (e.g., hazardous materials requiring shipping papers, firearms, ammunition or weapons). Same restrictions apply to delivered packages, except for ammunition that meets requirements for Limited Quantity (Ltd Qty) packages and all other UPS requirements for ammunition shipments. – Except in limited circumstances, packages requiring an adult signature are not permitted. – Shipper instructions may restrict eligibility.
The UPS Store®**	<ul style="list-style-type: none"> – Offers domestic and international shipping as well as packing services and packaging supplies. – Accepts UPS® Simple Rate shipments with a prepaid label. – More than 4,800 staffed locations. – Full portfolio of business services: packing services, packaging supplies, copying, printing, document finishing, mailbox services and office supplies. – International shipping expertise. – For details on the Pack & Ship Guarantee, visit theupsstore.com/guarantee. – Visit theupsstore.com to find a location.
UPS Drop Box	<ul style="list-style-type: none"> – Use for all domestic and international packages. – Offers latest possible pickup times. – Approximately 36,182 locations. – Ground and Air packages shipped using UPS Returns® and UPS Import Control® services are accepted in any UPS Drop Box. – Packages and UPS Express® Envelopes with a value of more than \$500.00 cannot be shipped via a UPS Drop Box. – Maximum acceptable size for each UPS Drop Box package is 16" x 13" x 3". UPS Simple Rate shipments with a prepaid label are accepted. – Hazardous Materials/Dangerous Goods, including, but not limited to, Ltd Qty shipments prepared under HM-215K, are not accepted in any UPS Drop Box. – Self-service locations available 24 hours a day, seven days a week for your convenience.
UPS Customer Center	<ul style="list-style-type: none"> – UPS-staffed customer shipping locations. – More than 1,000 locations. – Accepts UPS Simple Rate shipments with a prepaid label. – Offers UPS domestic and international shipping as well as packaging supplies and packing services. – Hold for Pickup services available.
UPS Worldwide Express Freight® Center	<ul style="list-style-type: none"> – UPS-staffed locations where shippers may tender international UPS Worldwide Express Freight Midday and UPS Worldwide Express Freight pallets to UPS for transportation and a consignee or other recipient may receive pallets. – UPS Worldwide Express Freight Midday and UPS Worldwide Express Freight shipments must be international, stackable, secured on a pallet and compliant with UPS packaging guidelines. – Pickup or drop-off must be scheduled for each UPS Worldwide Express Freight Midday or UPS Worldwide Express Freight shipment using WorldShip® or UPS CampusShip® shipping systems, ups.com shipping, a UPS Ready® solution, UPS® Developer Kit, ups.com or by calling 1-800-782-7892. – Hours of operation may vary by location. – Only UPS Worldwide Express Freight Midday and UPS Worldwide Express Freight shipments are accepted at these centers.
UPS Alliance Location (Staples)	<ul style="list-style-type: none"> – Offers exclusive access to UPS® services. – More than 1,000 Staples® locations. – Offers UPS domestic and international shipping. – Accepts UPS Simple Rate shipments with a prepaid label.
UPS Authorized Shipping Outlet	<ul style="list-style-type: none"> – Third-party pack-and-ship retailers that offer UPS domestic and international shipping. – Accepts UPS Simple Rate shipments with a prepaid label. – More than 3,400 locations. – Certain restrictions apply; refer to the "UPS Tariff/Terms and Conditions of Service – United States" available at ups.com/terms for more information.

*Not available for UPS Worldwide Express Freight Services.

**The UPS Store locations are independently owned and operated by licensed franchisees of The UPS Store, Inc., a subsidiary of United Parcel Service, Inc.

Notes:

– Visit "Locations" at [ups.com](https://www.ups.com).

– UPS Worldwide Express Freight Midday and UPS Worldwide Express Freight shipments are only accepted at UPS Worldwide Express Freight Centers.

How To Use This Guide

Section 1 CHOOSING A SERVICE

PAGES [3-9](#)

Section 2 PREPARING A SHIPMENT

PAGES [10-24](#)

Section 3

DETERMINING THE RATE

Determine the rates and zones for domestic, export and import shipments. Also, learn about value-added services that are available.

- Review the steps on how to determine the rates for your shipments. Pages [26-27](#)
- Domestic, Export and Import – Determine the zone destination or origin for your shipment. Pages [28-43](#)
- Domestic – Determine the UPS service rate for your domestic shipment. Pages [44-73](#)
- Export – Determine the UPS service rate for your export shipment. Pages [76-93](#)
- Import – Determine the UPS service rate for your import shipment. Pages [94-111](#)
- Value-added services, other charges and customs brokerage services for domestic, export and import. Pages [112-138](#)

Section 4 TRACKING AND PAYMENT

PAGES [139-144](#)

Domestic, Export and Import

Determine the Rate

All UPS rates are per package for domestic services and per shipment for international services, unless otherwise noted. The following information applies to the rate charts that appear on pages 44-71 for domestic and pages 77-109 for export and import. (Refer to pages 72-73 for UPS® Simple Rate shipments.)

Domestic, Export and Import

- Visit ups.com for guarantee details, service availability, delivery time commitments or to request a pickup.
- Dimensional weight may apply. Refer to pages 16-17 for more information.
- For large or heavy packages, additional charges may apply. Refer to pages 16-17 for large packages and page 12 for heavy packages.
- A Heavy Package sticker is required for any package weighing more than 70 pounds.
- UPS Worldwide Express Freight® services are available for shipments over 150 pounds that are palletized. See pages 80-81 or 98-99 for more information. For additional freight services refer to ups.com/freight.
- Rates do not include a fuel surcharge. For current fuel surcharge rates, visit ups.com/fuelsurcharge. Fuel surcharges do not apply to UPS Simple Rate shipments.
- Peak Surcharges apply to certain packages tendered during Peak Periods. See ups.com/peaksurcharges for details.

Domestic

- For each UPS Next Day Air® Early package with a weight of more than 150 pounds, multiply the weight by the price per pound and add \$30.00. For all other UPS domestic services with a weight of more than 150 pounds, multiply the weight by the price per pound.
- The Letter rate applies only to documents, correspondence and electronic media shipments that do not exceed eight ounces sent in a UPS Express® Envelope. UPS Express Envelopes exceeding eight ounces are subject

to the rate corresponding to the weight of the UPS Express Envelope. UPS Express Envelopes are not recommended for shipments of electronic media containing sensitive personal information.

- Shipments of Hazardous Materials using UPS 3 Day Select® service must be prepared in accordance with the appropriate Air Dangerous Goods requirements. Hazardous Materials contract service is available with a Scheduled Pickup.
- UPS does not accept Hazardous Materials [including but not limited to Limited Quantity (Ltd Qty) and combustibles] in UPS® Ground service destined to and from Alaska; Hawaii; Puerto Rico; Avalon, CA; Catalina Island, CA; Beaver Island, MI; Mackinac Island, MI (winter only); the Bass Islands, OH; Kelleys Island, OH; and San Juan Islands, WA.

Export and Import

- Delivery times may vary by origin and destination postal code.
- The rates shown on pages 77-111 are for shipments originating in the U.S. (export) or destined to the U.S. (import) and billed to a U.S. UPS account number.
- Any fraction of a pound more than the weight shown in the rate chart is rounded up to the next listed weight.
- To determine the rate for international multiple-package shipments, refer to page 76 for export and page 94 for import.
- For UPS Worldwide Express Freight® Middy and UPS Worldwide Express Freight shipments, additional charges may apply to larger pallets. Refer to page 124 for more information. Shipments exceeding maximum size or weight restrictions require prior authorization.
- All UPS Worldwide Express Freight Middy and UPS Worldwide Express Freight shipments require a scheduled pickup or drop-off using WorldShip® or UPS CampusShip® shipping systems, ups.com shipping, a UPS Ready®

solution, UPS® Developer Kit, ups.com or by calling 1-800-782-7892.

- When using a UPS® 10 KG Box or UPS® 25 KG Box, shipments that exceed the maximum weights (10 KG/22 pounds and 25 KG/55 pounds) will be charged the regular UPS Worldwide Express Plus®, UPS Worldwide Express® or UPS Worldwide Saver® rate. Available only when the shipper is paying the shipping charges.

Export

- UPS Express® Pak rates will apply to Letters weighing more than eight ounces, but less than two pounds. UPS Express Pak rates also apply when all the following are met:
 - The shipment weighs two pounds or less. Shipments above two pounds are rated by weight;
 - UPS Express Pak is selected at the time of shipping; and
 - The customs value of the shipment is less than \$100.00.
- The Letter rate applies only to documents, correspondence and electronic media shipments of no commercial value that do not exceed eight ounces sent in a UPS Express Envelope. UPS Express Envelopes containing items other than those listed above or exceeding eight ounces up to two pounds are subject to the UPS Express Pak rate. Shipments greater than two pounds are subject to the rate corresponding to the weight. UPS Express Envelopes are not recommended for shipments of electronic media containing sensitive personal information.

Import

The Letter rate applies only to documents, correspondence and electronic media shipments of no commercial value that do not exceed eight ounces sent in a UPS Express Envelope. Shipments greater than eight ounces are subject to the rate corresponding to the weight. UPS Express Envelopes are not recommended for shipments of electronic media containing sensitive personal information.

Domestic, Export and Import

Determine the Rate and Zone

PACKAGE AND AIR FREIGHT

Determine the Rate

To determine the rate for domestic, export and import packages, including UPS Worldwide Express Freight® Midday, UPS Worldwide Express Freight® and Air Freight shipments, follow the steps below:

	Domestic	Export	Import	Air Freight
1. Choose service	page 4	page 4	page 4	page 5
2. Compute billable weight	pages 16-17	pages 16-18	pages 16-18	pages 19-20
3. Look up shipping zone	page 27	pages 27-38	pages 27-28 , pages 39-43	page 27

4. Calculate the rate: Use WorldShip® or UPS CampusShip® shipping systems, ups.com shipping, the UPS® App (package only), the UPS® Developer Kit, a UPS Ready® solution or the “Calculate Time and Cost” application on ups.com/ctc to see the rate for your shipment.*

OR

Follow the steps in the table below to use the rate charts in this guide:

	Domestic	Export	Import	Air Freight
1. Go to applicable rates for service option selected	pages 44-73	pages 77-93	pages 94-111	pages 74-75
2. Match billable weight to appropriate zone	page 27	pages 28-38	pages 28 , 39-43	pages 74-75
3. Additional charges may apply**	pages 112-125	pages 112-125	pages 112-125	pages 126-129

*Rates provided through UPS's shipping systems are estimates only, and other shipping charges, surcharges and value-added service charges may apply based on your shipper characteristics and the characteristics of, and services requested for, shipments actually tendered to UPS.

**Including, but not limited to, surcharges if special options or value-added services are selected. Other surcharges, including surcharges imposed by carriers, also may apply for Air Freight. Contact your local UPS Supply Chain Solutions® service center for details (refer to ups-scs.com/returns/UPS_GFF_Global%20Directory.pdf).

Determine the Zone

Domestic (including Puerto Rico)

Use your UPS Zone Chart to determine the destination zone for the domestic package or Air Freight service option you've selected.

View or download your UPS Zone Chart at ups.com/rates.

Export and Import

To find the destination zone that matches the service option you've selected refer to the chart below.

Origin/Destination	Export	Import
48 Contiguous States	pages 28-32	pages 28 , 39-41
Canada	pages 28 , 33-37	page 42
Mexico	page 38	page 43

An Extended Area Surcharge may apply to certain destinations or origins within a country. Extended Area origins are subject to change.

For the most current information, refer to ups.com/rates or call 1-800-782-7892.

Notes:

- Not applicable for UPS Express Critical®, UPS Worldwide Expedited® Ground Freight, LTL, Truckload, Intermodal, Ocean Freight, UPS Air Freight Direct®, UPS Air Freight Consolidated® or UPS® Simple Rate services.
- For information regarding pricing for UPS® Ground with Freight Pricing service, refer to page [6](#) and visit ups.com/gfp.
- For information regarding pricing for UPS Simple Rate, refer to pages [72-73](#) and visit ups.com/simplerate.

West and East State Classifications

UPS WORLDWIDE EXPEDITED® AND UPS® STANDARD TO CANADA



Use the map above to:

- Determine West and East origin state classifications for UPS Worldwide Expedited shipments.
- Identify state abbreviations for UPS Standard to Canada shipments.

Export

Worldwide Zone Chart

Destination	Zones						Destination	Zones							
	UPS Worldwide Express Plus®	UPS Worldwide Express®	UPS Worldwide Express Freight® Midday	UPS Worldwide Express Freight®	UPS Worldwide Saver®	UPS Worldwide Expedited®		UPS Worldwide Express Plus®	UPS Worldwide Express®	UPS Worldwide Express Freight® Midday	UPS Worldwide Express Freight®	UPS Worldwide Saver®	UPS Worldwide Expedited®		
						WEST	EAST						WEST	EAST	
Afghanistan/AF					408	638	608	Bulgaria/BG	907	907			407	637	607
Aland Islands/AX					403	633	603	Burkina Faso/BF					408	638	608
Albania/AL	908	908			408	638	608	Burundi/BI					408	638	608
Algeria/DZ		908			408	638	608	Cambodia/KH		908			408	638	608
American Samoa/AS		908			408	638	608	Cameroon/CM					408	638	608
Andorra/AD		903			403	633	603	Canada/CA							
Angola/AO					408	638	608	<i>For Canada's zone chart, refer to pages 33 to 37.</i>							
Anguilla/At†					402	632	602	Canary Islands (Spain)/ES					403	633	603
Antigua and Barbuda/AG†					402	632	602	Cape Verde/CV					408	638	608
Argentina/AR†		906		406	406	636	606	Cayman Islands/KY†					402	632	602
Armenia/AM	908	908			408	638	608	Central African Republic/CF					408	638	608
Aruba/AW†		902			402	632	602	Chad/TD					408	638	608
Australia/AU	904	904	404	404	404	634	604	Channel Islands Guernsey/GG, Jersey/JE					403	633	603
Austria/AT	903	903	403	403	403	633	603	Chile/CL†		906	406	406	406	636	606
Azerbaijan/AZ					408	638	608	China, People's Republic of/CN	912	912		412	412	642	612
Azores (Portugal)/PT					403	633	603	Colombia/CO†		906		406	406	636	606
Bahamas/BS†		902			402	632	602	Comoros/KM					408	638	608
Bahrain/BH	905	905		405	405	635	605	Congo, Democratic Republic of/CD					408	638	608
Bangladesh/BD		911		411	411	641	611	Congo, Republic of/CG					408	638	608
Barbados/BB†		902			402	632	602	Cook Islands/CK					408	638	608
Belarus/BY	908	908			408	638	608	Costa Rica/CR†		906	406	406	406	636	606
Belgium/BE	901	901	401	401	401	631	601	Côte d'Ivoire (Ivory Coast)/CI					408	638	608
Belize/BZ†					406	636	606	Croatia/HR		908			408	638	608
Benin/BJ					408	638	608	Curaçao/CW†		902			402	632	602
Bermuda/BM†		902			402	632	602	Cyprus/CY	905	905			405	635	605
Bhutan/BT		911			411	641	611	Czech Republic/CZ	907	907	407	407	407	637	607
Bolivia/BO†		906			406	636	606	Denmark/DK	903	903	403	403	403	633	603
Bonaire/BQ†					402	632	602	Djibouti/DJ					408	638	608
Bosnia/BA	908	908			408	638	608	Dominica/DM†					402	632	602
Botswana/BW					408	638	608	Dominican Republic/DO†		902		402	402	632	602
Brazil/BR†	906	906		406	406	636	606	East Timor (Timor-Leste)/TL					408	638	608
British Virgin Islands/VG†					402	632	602	Ecuador/EC†		906		406	406	636	606
Brunei/BN		905			405	635	605	Egypt/EG		905			405	635	605

†For shipments from Dade or Broward County, Florida, to South America, use zone:

- 921 for UPS Worldwide Express
- 421 for UPS Worldwide Express Freight Midday
- 421 for UPS Worldwide Express Freight
- 421 for UPS Worldwide Saver
- 621 for UPS Worldwide Expedited

For shipments from Dade or Broward County, Florida, to the Caribbean, use zone:

- 920 for UPS Worldwide Express
- 420 for UPS Worldwide Express Freight Midday
- 420 for UPS Worldwide Express Freight
- 420 for UPS Worldwide Saver
- 620 for UPS Worldwide Expedited

Export

Worldwide Zone Chart

Destination	Zones						Destination	Zones							
	UPS Worldwide Express Plus®	UPS Worldwide Express®	UPS Worldwide Express Freight® Midday	UPS Worldwide Express Freight®	UPS Worldwide Saver®	UPS Worldwide Expedited®		UPS Worldwide Express Plus®	UPS Worldwide Express®	UPS Worldwide Express Freight® Midday	UPS Worldwide Express Freight®	UPS Worldwide Saver®	UPS Worldwide Expedited®		
						WEST							EAST	WEST	EAST
El Salvador/SV†				406	406	636	606	Hong Kong/HK	909	909	409	409	409	639	609
England (United Kingdom)/GB	901	901	401	401	401	631	601	Hungary/HU	907	907	407	407	407	637	607
Equatorial Guinea/GQ					408	638	608	Iceland/IS		903			403	633	603
Eritrea/ER					408	638	608	India/IN	911	911	411	411	411	641	611
Estonia/EE		907			407	637	607	Indonesia/ID	904	904		404	404	634	604
Ethiopia/ET					408	638	608	Iraq/IQ					408	638	608
Faeroe Islands (Denmark)/FO					403	633	603	Ireland, Republic of/IE	901	901	401	401	401	631	601
Fiji/FJ		908			408	638	608	Israel/IL		905	405	405	405	635	605
Finland/FI	903	903	403	403	403	633	603	Italy/IT	901	901	401	401	401	631	601
France/FR	901	901	401	401	401	631	601	Ivory Coast (Côte d'Ivoire)/CI					408	638	608
French Guiana/GF†		907			406	636	606	Jamaica/JM†		902			402	632	602
French Polynesia/PF					408	638	608	Japan/JP	913	913	413	413	413	643	613
Gabon/GA					408	638	608	Jersey/JE		903			403	633	603
Gambia/GM		908			408	638	608	Jordan/JO		905			405	635	605
Georgia/GE	908	908			408	638	608	Kazakhstan/KZ		908			408	638	608
Germany/DE	901	901	401	401	401	631	601	Kenya/KE		908			408	638	608
Ghana/GH					408	638	608	Kiribati/KI					408	638	608
Gibraltar/GI					408	638	608	Korea, South/KR	913	913	413	413	413	643	613
Great Britain (United Kingdom)/GB	901	901	401	401	401	631	601	Kosovo/KV	908	908			408	638	608
Greece/GR		903	403	403	403	633	603	Kosrae (Micronesia, Federated States of)/FM					408	638	608
Greenland (Denmark)/GL					403	633	603	Kuwait/KW	905	905		405	405	635	605
Grenada/GD†					402	632	602	Kyrgyzstan/KG		908			408	638	608
Guadeloupe/GP†		902			402	632	602	Laos/LA		908			408	638	608
Guam/GU		904			404	634	604	Latvia/LV		907			407	637	607
Guatemala/GT†		906		406	406	636	606	Lebanon/LB		905		405	405	635	605
Guernsey/GG		903			403	633	603	Lesotho/LS					408	638	608
Guinea/GN					408	638	608	Liberia/LR					408	638	608
Guinea-Bissau/GW					408	638	608	Libya/LY					408	638	608
Guyana/GY†					406	636	606	Liechtenstein/LI		903		403	403	633	603
Haiti/HT†					402	632	602	Lithuania/LT		907			407	637	607
Holland (Netherlands)/NL	901	901	401	401	401	631	601	Luxembourg/LU	901	901		401	401	631	601
Honduras/HN†		906		406	406	636	606	Macau/MO		904			404	634	604

†For shipments from Dade or Broward County, Florida, to South America, use zone:

- 921 for UPS Worldwide Express
- 421 for UPS Worldwide Express Freight Midday
- 421 for UPS Worldwide Express Freight
- 421 for UPS Worldwide Saver
- 621 for UPS Worldwide Expedited

†For shipments from Dade or Broward County, Florida, to the Caribbean, use zone:

- 920 for UPS Worldwide Express
- 420 for UPS Worldwide Express Freight Midday
- 420 for UPS Worldwide Express Freight
- 420 for UPS Worldwide Saver
- 620 for UPS Worldwide Expedited

Export

Worldwide Zone Chart

Destination	Zones						Destination	Zones									
	UPS Worldwide Express Plus®	UPS Worldwide Express®	UPS Worldwide Express Freight® Midday	UPS Worldwide Express Freight®	UPS Worldwide Saver®	UPS Worldwide Expedited®		WEST	EAST	UPS Worldwide Express Plus®	UPS Worldwide Express®	UPS Worldwide Express Freight® Midday	UPS Worldwide Express Freight®	UPS Worldwide Saver®	UPS Worldwide Expedited®	WEST	EAST
Macedonia (FYROM)/MK	908	908			408	638	608	Niger/NE		908			408	638	608		
Madagascar/MG		908			408	638	608	Nigeria/NG	908	908		408	408	638	608		
Madeira (Portugal)/PT					403	633	603	Norfolk Island/NF					408	638	608		
Malawi/MW		908			408	638	608	Northern Ireland (United Kingdom)/GB	901	901		401	401	631	601		
Malaysia/MY		904	404	404	404	634	604	Northern Mariana Islands/MP					408	638	608		
Maldives/MV		908			408	638	608	Norway/NO	903	903		403	403	633	603		
Mali/ML					408	638	608	Oman/OM		905		405	405	635	605		
Malta/MT		908		408	408	638	608	Pakistan/PK		911		411	411	641	611		
Marshall Islands/MH					408	638	608	Palau/PW					408	638	608		
Martinique/MQ†					402	632	602	Panama/PA†		906		406	406	636	606		
Mauritania/MR		908			408	638	608	Papua New Guinea/PG		908			408	638	608		
Mauritius/MU		908			408	638	608	Paraguay/PY†					406	636	606		
Mayotte/YT					408	638	608	Peru/PE†		906			406	636	606		
Mexico/MX	84	84	484	484	484	74	74	Philippines/PH		904		404	404	634	604		
Micronesia (Federated States of)/FM		908			408	638	608	Poland/PL	907	907	407	407	407	637	607		
Moldova/MD	908	908			408	638	608	Ponape (Micronesia, Federated States of)/FM					408	638	608		
Monaco/MC		901		401	401	631	601	Portugal/PT	903	903	403	403	403	633	603		
Mongolia/MN					408	638	608	Puerto Rico/PR									
Montenegro/ME	908	908			408	638	608	<i>Refer to the UPS domestic rates beginning on page 44.</i>									
Montserrat/MS†					402	632	602	Qatar/QA	905	905		405	405	635	605		
Morocco/MA		908		408	408	638	608	Réunion/RE		908			408	638	608		
Mozambique/MZ					408	638	608	Romania/RO	907	907			407	637	607		
Myanmar/MM		911			411	641	611	Rota (Northern Mariana Islands)/MP					408	638	608		
Namibia/NA		908			408	638	608	Russia/RU	907	907			407	637	607		
Nepal/NP		911			411	641	611	Rwanda/RW					408	638	608		
Netherlands (Holland)/NL	901	901	401	401	401	631	601	Saba/BQ†					402	632	602		
Netherlands Antilles/AN† <i>Refer to Bonaire, St. Eustatius, Saba, Curaçao, St. Martin or St. Maarten for zone information.</i>								Saipan (Northern Mariana Islands)/MP		908			408	638	608		
New Caledonia/NC		908			408	638	608	Samoa/WS		908			408	638	608		
New Zealand/NZ		904		404	404	634	604	San Marino/SM				401	401	631	601		
Nicaragua/NI†				406	406	636	606	Saudi Arabia/SA	905	905		405	405	635	605		
								Scotland (United Kingdom)/GB	901	901	401	401	401	631	601		

†For shipments from Dade or Broward County, Florida, to South America, use zone:

- 921 for UPS Worldwide Express
- 421 for UPS Worldwide Express Freight Midday
- 421 for UPS Worldwide Express Freight
- 421 for UPS Worldwide Saver
- 621 for UPS Worldwide Expedited

For shipments from Dade or Broward County, Florida, to the Caribbean, use zone:

- 920 for UPS Worldwide Express
- 420 for UPS Worldwide Express Freight Midday
- 420 for UPS Worldwide Express Freight
- 420 for UPS Worldwide Saver
- 620 for UPS Worldwide Expedited

Export

Worldwide Zone Chart

Destination	Zones						Destination	Zones									
	UPS Worldwide Express Plus®	UPS Worldwide Express®	UPS Worldwide Express Freight® Midday	UPS Worldwide Express Freight®	UPS Worldwide Saver®	UPS Worldwide Expedited®		WEST	EAST	UPS Worldwide Express Plus®	UPS Worldwide Express®	UPS Worldwide Express Freight® Midday	UPS Worldwide Express Freight®	UPS Worldwide Saver®	UPS Worldwide Expedited®	WEST	EAST
Senegal/SN		908			408	638	608	Tinian (Northern Mariana Islands)/MP					408	638	608		
Serbia/RS	908	908			408	638	608	Togo/TG					408	638	608		
Seychelles/SC					408	638	608	Tonga/TO					408	638	608		
Sierra Leone/SL					408	638	608	Tortola (British Virgin Islands)/VG†					402	632	602		
Singapore/SG	909	909		409	409	639	609	Trinidad and Tobago/TT†		902			402	632	602		
Slovakia/SK	907	907		407	407	637	607	Truk (Micronesia, Federated States of)/FM					408	638	608		
Slovenia/SI	907	907		407	407	637	607	Tunisia/TN		908		408	408	638	608		
Solomon Islands/SB		908			408	638	608	Turkey/TR	905	905	405	405	405	635	605		
South Africa/ZA	907	907		407	407	637	607	Turkmenistan/TM					408	638	608		
Spain/ES	903	903	403	403	403	633	603	Turks and Caicos Islands/TC†					402	632	602		
Sri Lanka/LK		911		411	411	641	611	Tuvalu/TV					408	638	608		
St. Barthélemy/BL†					402	632	602	Uganda/UG					408	638	608		
St. Christopher (St. Kitts and Nevis)/KN†					402	632	602	Ukraine/UA	908	908			408	638	608		
St. Croix (U.S. Virgin Islands)/VI†					402	632	602	Union Island (St. Vincent and the Grenadines)/VC†					402	632	602		
St. Eustatius/BQ†					402	632	602	United Arab Emirates/AE	905	905	405	405	405	635	605		
St. John (U.S. Virgin Islands)/VI†					402	632	602	United Kingdom/GB	901	901	401	401	401	631	601		
St. Kitts and Nevis/KN†		902			402	632	602	Uruguay/UY†					406	636	606		
St. Lucia/LC†		902			402	632	602	U.S. Virgin Islands/VI†					402	632	602		
St. Maarten/SX†					402	632	602	Uzbekistan/UZ					408	638	608		
St. Martin/SX†					402	632	602	Vanuatu/VU		908			408	638	608		
St. Thomas (U.S. Virgin Islands)/VI†					402	632	602	Vatican City (Italy)/VA	901	901		401	401	631	601		
St. Vincent and the Grenadines/VC†					402	632	602	Venezuela/VE†					406	636	606		
Suriname/SR†		906			406	636	606	Vietnam/VN	904	904		404	404	634	604		
Swaziland/SZ					408	638	608	Virgin Gorda (British Virgin Islands)/VG†					402	632	602		
Sweden/SE	903	903	403	403	403	633	603	Wales (United Kingdom)/GB	901	901		401	401	631	601		
Switzerland/CH	903	903	403	403	403	633	603	Wallis and Futuna Islands/WF		908			408	638	608		
Tahiti (French Polynesia)/PF		908			408	638	608	Yap (Micronesia, Federated States of)/FM					408	638	608		
Taiwan/TW	909	909	409	409	409	639	609	Zaire (Congo, Democratic Republic of)/CD					408	638	608		
Tajikistan/TJ					408	638	608	Zambia/ZM					408	638	608		
Tanzania/TZ					408	638	608	Zimbabwe/ZW					408	638	608		
Thailand/TH	904	904	404	404	404	634	604										
Timor-Leste (East Timor)/TL					408	638	608										

†For shipments from Dade or Broward County, Florida, to South America, use zone:

- 921 for UPS Worldwide Express
- 421 for UPS Worldwide Express Freight Midday
- 421 for UPS Worldwide Express Freight
- 421 for UPS Worldwide Saver
- 621 for UPS Worldwide Expedited

†For shipments from Dade or Broward County, Florida, to the Caribbean, use zone:

- 920 for UPS Worldwide Express
- 420 for UPS Worldwide Express Freight Midday
- 420 for UPS Worldwide Express Freight
- 420 for UPS Worldwide Saver
- 620 for UPS Worldwide Expedited

Export

Canada Zone Chart

Destination Postal Code Range	UPS Worldwide Express Plus® and UPS Worldwide Express®*	UPS Worldwide Express Freight® Midday and UPS Worldwide Express Freight®	UPS Worldwide Saver®	UPS Worldwide Expedited®	UPS® Standard to Canada by Origin State									
					CT, DC, DE, MA, MD, ME, NH, NJ, NY, PA, RI, VT, WV	AZ, CA, NV, UT	IL, IN, KY	IA, MN, WI	MI, OH	CO, MT, WY	ID, OR, WA	ND, NE, SD	NM, TX	AL, AR, FL, GA, KS, LA, MO, MS, NC, OK, SC, TN, VA
Newfoundland														
A0A - A0Z		481	481	71	54	56	55	55	54	56	56	55	56	55
A1A - A1N	82	482	482	72	54	56	55	55	54	56	56	55	56	55
A1P - A9Z		481	481	71	54	56	55	55	54	56	56	55	56	55
Nova Scotia														
B0A - B2T	81	481	481	71	54	56	55	55	54	56	56	55	56	55
B2V - B3B		482	482	72	54	56	55	55	54	56	56	55	56	55
B3C - B3G		481	481	71	54	56	55	55	54	56	56	55	56	55
B3H - B4B		482	482	72	54	56	55	55	54	56	56	55	56	55
B4C - B9Z		481	481	71	54	56	55	55	54	56	56	55	56	55
Prince Edward Island														
C0A - C0Z		481	481	71	54	56	55	55	54	56	56	55	56	55
C1A - C1E		482	482	72	54	56	55	55	54	56	56	55	56	55
C1G - C9Z		481	481	71	54	56	55	55	54	56	56	55	56	55
New Brunswick														
E0A - E0Z		481	481	71	54	56	55	55	54	56	56	55	56	55
E1A - E1G	82	482	482	72	54	56	55	55	54	56	56	55	56	55
E1H - E2G	81	481	481	71	54	56	55	55	54	56	56	55	56	55
E2H - E2S		482	482	72	54	56	55	55	54	56	56	55	56	55
E2T - E2Z		481	481	71	54	56	55	55	54	56	56	55	56	55
E3A - E3E		482	482	72	54	56	55	55	54	56	56	55	56	55
E3G - E9Z		481	481	71	54	56	55	55	54	56	56	55	56	55
Quebec														
G0A		482	482	72	51	53	52	52	51	53	53	52	53	52
G0B - G0J		481	481	71	54	56	55	55	54	56	56	55	56	55
G0K - G0L		482	482	72	54	56	55	55	54	56	56	55	56	55
G0M - G0S		482	482	72	51	53	52	52	51	53	53	52	53	52
G0T - G0W		481	481	71	54	56	55	55	54	56	56	55	56	55
G0X - G0Z		482	482	72	51	53	52	52	51	53	53	52	53	52
G1A - G3A	81	481	481	71	51	53	52	52	51	53	53	52	53	52
G3B - G3K		482	482	72	51	53	52	52	51	53	53	52	53	52
G3L - G4P		482	482	72	54	56	55	55	54	56	56	55	56	55
G4R - G4S		481	481	71	54	56	55	55	54	56	56	55	56	55
G4T - G4V		482	482	72	54	56	55	55	54	56	56	55	56	55

*To determine whether UPS Worldwide Express Plus and UPS Worldwide Express Services are available to your destination postal code, refer to [ups.com](https://www.ups.com) or call 1-800-782-7892.

Export

Canada Zone Chart

Destination Postal Code Range	UPS Worldwide Express Plus® and UPS Worldwide Express®*	UPS Worldwide Express Freight® Midday and UPS Worldwide Express Freight®	UPS Worldwide Saver®	UPS Worldwide Expedited®	UPS® Standard to Canada by Origin State									
					CT, DC, DE, MA, MD, ME, NH, NJ, NY, PA, RI, VT, WV	AZ, CA, NV, UT	IL, IN, KY	IA, MN, WI	MI, OH	CO, MT, WY	ID, OR, WA	ND, NE, SD	NM, TX	AL, AR, FL, GA, KS, LA, MO, MS, NC, OK, SC, TN, VA
Quebec (cont.)														
G4W - G4Z		481	481	71	54	56	55	55	54	56	56	55	56	55
G5A		482	482	72	51	53	52	52	51	53	53	52	53	52
G5B - G5T		481	481	71	54	56	55	55	54	56	56	55	56	55
G5V - G6A		482	482	72	51	53	52	52	51	53	53	52	53	52
G6B		481	481	71	51	53	52	52	51	53	53	52	53	52
G6C - G6J		482	482	72	51	53	52	52	51	53	53	52	53	52
G6K		481	481	71	51	53	52	52	51	53	53	52	53	52
G6L - G6T		482	482	72	51	53	52	52	51	53	53	52	53	52
G6V - G6Z		481	481	71	51	53	52	52	51	53	53	52	53	52
G7A		481	481	71	54	56	55	55	54	56	56	55	56	55
G7B - G8P		481	481	71	54	56	55	55	54	56	56	55	56	55
G8R - G8S		482	482	72	54	56	55	55	54	56	56	55	56	55
G8T - G9Z		482	482	72	51	53	52	52	51	53	53	52	53	52
H0A - H0L		481	481	71	51	53	52	52	51	53	53	52	53	52
H0M		481	481	71	54	56	55	55	54	56	56	55	56	55
H0N - H9Z	81	481	481	71	51	53	52	52	51	53	53	52	53	52
J0A - J0L		482	482	72	51	53	52	52	51	53	53	52	53	52
J0M		481	481	71	54	56	55	55	54	56	56	55	56	55
J0N - J0V		482	482	72	51	53	52	52	51	53	53	52	53	52
J0W - J0Z		481	481	71	54	56	55	55	54	56	56	55	56	55
J1A - J3C	82	482	482	72	51	53	52	52	51	53	53	52	53	52
J3E		481	481	71	51	53	52	52	51	53	53	52	53	52
J3G - J3S		482	482	72	51	53	52	52	51	53	53	52	53	52
J3T - J3V		481	481	71	51	53	52	52	51	53	53	52	53	52
J3W - J3X		482	482	72	51	53	52	52	51	53	53	52	53	52
J3Y - J5R	81	481	481	71	51	53	52	52	51	53	53	52	53	52
J5S - J5X		482	482	72	51	53	52	52	51	53	53	52	53	52
J5Y - J7H	81	481	481	71	51	53	52	52	51	53	53	52	53	52
J7J - J7N	82	482	482	72	51	53	52	52	51	53	53	52	53	52
J7P - J7W	81	481	481	71	51	53	52	52	51	53	53	52	53	52
J7X - J8N	82	482	482	72	51	53	52	52	51	53	53	52	53	52
J8P - J9C	81	481	481	71	51	53	52	52	51	53	53	52	53	52
J9E		482	482	72	54	56	55	55	54	56	56	55	56	55
J9G - J9J		482	482	72	51	53	52	52	51	53	53	52	53	52
J9K - J9Z		481	481	71	54	56	55	55	54	56	56	55	56	55

*To determine whether UPS Worldwide Express Plus and UPS Worldwide Express Services are available to your destination postal code, refer to [ups.com](https://www.ups.com) or call 1-800-782-7892.

Export

Canada Zone Chart

Destination Postal Code Range	UPS Worldwide Express Plus® and UPS Worldwide Express®*	UPS Worldwide Express Freight® Midday and UPS Worldwide Express Freight®	UPS Worldwide Saver®	UPS Worldwide Expedited®	UPS® Standard to Canada by Origin State									
					CT, DC, DE, MA, MD, ME, NH, NJ, NY, PA, RI, VT, WV	AZ, CA, NV, UT	IL, IN, KY	IA, MN, WI	MI, OH	CO, MT, WY	ID, OR, WA	ND, NE, SD	NM, TX	AL, AR, FL, GA, KS, LA, MO, MS, NC, OK, SC, TN, VA
Ontario														
K0A - K0H		482	482	72	51	53	51	52	51	53	53	52	53	52
K0J		481	481	71	54	56	54	55	54	56	56	55	56	55
K0K - K0Z		482	482	72	51	53	51	52	51	53	53	52	53	52
K1A - K4A	81	481	481	71	51	53	51	52	51	53	53	52	53	52
K4B - K7T	82	482	482	72	51	53	51	52	51	53	53	52	53	52
K7V - K8H		482	482	72	54	56	54	55	54	56	56	55	56	55
K8J - L1E	82	482	482	72	51	53	51	52	51	53	53	52	53	52
L1F - L1Z	81	481	481	71	51	53	51	52	51	53	53	52	53	52
L2A - L2C		482	482	72	51	53	51	52	51	53	53	52	53	52
L2E - L2W	81	481	481	71	51	53	51	52	51	53	53	52	53	52
L2X - L3N		482	482	72	51	53	51	52	51	53	53	52	53	52
L3P - L3T	81	481	481	71	51	53	51	52	51	53	53	52	53	52
L3V - L3W		482	482	72	51	53	51	52	51	53	53	52	53	52
L3X - L4L	81	481	481	71	51	53	51	52	51	53	53	52	53	52
L4M - L4R	82	482	482	72	51	53	51	52	51	53	53	52	53	52
L4S - L9T	81	481	481	71	51	53	51	52	51	53	53	52	53	52
L9V - L9Z		482	482	72	51	53	51	52	51	53	53	52	53	52
M0A - M9Z	81	481	481	71	51	53	51	52	51	53	53	52	53	52
N0A - N1A	82	482	482	72	51	53	51	52	51	53	53	52	53	52
N1B - N2Y	81	481	481	71	51	53	51	52	51	53	53	52	53	52
N2Z		482	482	72	51	53	51	52	51	53	53	52	53	52
N3A - N3V	81	481	481	71	51	53	51	52	51	53	53	52	53	52
N3W - N5T	82	482	482	72	51	53	51	52	51	53	53	52	53	52
N5V - N6N	81	481	481	71	51	53	51	52	51	53	53	52	53	52
N6P - N8M		482	482	72	51	53	51	52	51	53	53	52	53	52
N8N - N9K	81	481	481	71	51	53	51	52	51	53	53	52	53	52
N9L - N9Z		482	482	72	51	53	51	52	51	53	53	52	53	52
P0A - P0Z		481	481	71	54	56	54	55	54	56	56	55	56	55
P1A - P2M		482	482	72	54	56	54	55	54	56	56	55	56	55
P2N		481	481	71	54	56	54	55	54	56	56	55	56	55
P2P - P3K		482	482	72	54	56	54	55	54	56	56	55	56	55
P3L		481	481	71	54	56	54	55	54	56	56	55	56	55
P3M		482	482	72	54	56	54	55	54	56	56	55	56	55
P3N - P3P		481	481	71	54	56	54	55	54	56	56	55	56	55

*To determine whether UPS Worldwide Express Plus and UPS Worldwide Express Services are available to your destination postal code, refer to [ups.com](https://www.ups.com) or call 1-800-782-7892.

Export

Canada Zone Chart

Destination Postal Code Range	UPS Worldwide Express Plus® and UPS Worldwide Express®*	UPS Worldwide Express Freight® Midday and UPS Worldwide Express Freight®	UPS Worldwide Saver®	UPS Worldwide Expedited®	UPS® Standard to Canada by Origin State									
					CT, DC, DE, MA, MD, ME, NH, NJ, NY, PA, RI, VT, WV	AZ, CA, NV, UT	IL, IN, KY	IA, MN, WI	MI, OH	CO, MT, WY	ID, OR, WA	ND, NE, SD	NM, TX	AL, AR, FL, GA, KS, LA, MO, MS, NC, OK, SC, TN, VA
Ontario (cont.)														
P3R - P4M	82	482	482	72	54	56	54	55	54	56	56	55	56	55
P4N - P4R		481	481	71	54	56	54	55	54	56	56	55	56	55
P4S - P4Z		482	482	72	54	56	54	55	54	56	56	55	56	55
P5A		481	481	71	54	56	54	55	54	56	56	55	56	55
P5B - P5M		482	482	72	54	56	54	55	54	56	56	55	56	55
P5N		481	481	71	54	56	54	55	54	56	56	55	56	55
P5P - P8M		482	482	72	54	56	54	55	54	56	56	55	56	55
P8N		481	481	71	54	56	54	55	54	56	56	55	56	55
P8P - P8S		482	482	72	54	56	54	55	54	56	56	55	56	55
P8T		481	481	71	54	56	54	55	54	56	56	55	56	55
P8V - P8Z		482	482	72	54	56	54	55	54	56	56	55	56	55
P9A		481	481	71	54	56	54	55	54	56	56	55	56	55
P9B - P9M		482	482	72	54	56	54	55	54	56	56	55	56	55
P9N		481	481	71	54	56	54	55	54	56	56	55	56	55
P9P - P9Z		482	482	72	54	56	54	55	54	56	56	55	56	55
Manitoba														
R0A - R2B		481	481	71	55	56	54	54	54	55	55	54	55	55
R2C - R4A	81	481	481	71	52	53	51	51	51	52	52	51	52	52
R4B - R9Z		481	481	71	55	56	54	54	54	55	55	54	55	55
Saskatchewan														
S0A - S0Z		481	481	71	55	56	54	54	54	55	55	54	55	55
S1A - S3M		482	482	72	55	56	54	54	54	55	55	54	55	55
S3N		481	481	71	55	56	54	54	54	55	55	54	55	55
S3P - S3Z		482	482	72	55	56	54	54	54	55	55	54	55	55
S4A		481	481	71	55	56	54	54	54	55	55	54	55	55
S4B - S4G		482	482	72	55	56	54	54	54	55	55	54	55	55
S4H		481	481	71	55	56	54	54	54	55	55	54	55	55
S4J - S4M		482	482	72	55	56	54	54	54	55	55	54	55	55
S4N - S4Z		482	482	72	52	53	51	51	51	52	52	51	52	52
S5A - S7G		481	481	71	55	56	54	54	54	55	55	54	55	55
S7H - S7V		481	481	71	52	53	51	51	51	52	52	51	52	52
S7W - S9Z		481	481	71	55	56	54	54	54	55	55	54	55	55

*To determine whether UPS Worldwide Express Plus and UPS Worldwide Express Services are available to your destination postal code, refer to [ups.com](https://www.ups.com) or call 1-800-782-7892.

Export

Canada Zone Chart

Destination Postal Code Range	UPS Worldwide Express Plus® and UPS Worldwide Express®*	UPS Worldwide Express Freight® Midday and UPS Worldwide Express Freight®	UPS Worldwide Saver®	UPS Worldwide Expedited®	UPS® Standard to Canada by Origin State									
					CT, DC, DE, MA, MD, ME, NH, NJ, NY, PA, RI, VT, WV	AZ, CA, NV, UT	IL, IN, KY	IA, MN, WI	MI, OH	CO, MT, WY	ID, OR, WA	ND, NE, SD	NM, TX	AL, AR, FL, GA, KS, LA, MO, MS, NC, OK, SC, TN, VA
Alberta														
T0A - T0B		481	481	71	56	55	56	56	56	55	54	55	56	56
T0C			482	482	72	53	52	53	53	53	52	51	52	53
T0E - T1W			481	481	71	56	55	56	56	56	55	54	55	56
T1X			481	481	71	56	55	56	56	56	55	54	55	56
T1Y - T3Z	81		481	481	71	53	52	53	53	53	52	51	52	53
T4A - T4Z	82		482	482	72	53	52	53	53	53	52	51	52	53
T5A - T6V			481	481	71	53	52	53	53	53	52	51	52	53
T6W - T6X			481	481	71	56	55	56	56	56	55	54	55	56
T6Y - T7W			481	481	71	56	55	56	56	56	55	54	55	56
T7X - T8N			482	482	72	53	52	53	53	53	52	51	52	53
T8P - T8Z			481	481	71	56	55	56	56	56	55	54	55	56
T9A - T9E			482	482	72	53	52	53	53	53	52	51	52	53
T9G - T9Z			481	481	71	56	55	56	56	56	55	54	55	56
British Columbia														
V0A - V0L			481	481	71	56	55	56	56	56	55	54	55	56
V0M			481	481	71	53	52	53	53	53	52	51	52	53
V0N - V1L			481	481	71	56	55	56	56	56	55	54	55	56
V1M			481	481	71	53	52	53	53	53	52	51	52	53
V1N - V2R			481	481	71	56	55	56	56	56	55	54	55	56
V2S - V2V			481	481	71	56	55	56	56	56	55	54	55	56
V2W - V3E	81		481	481	71	53	52	53	53	53	52	51	52	53
V3G			481	481	71	56	55	56	56	56	55	54	55	56
V3H - V7Z	81		481	481	71	53	52	53	53	53	52	51	52	53
V8A - V8K			481	481	71	56	55	56	56	56	55	54	55	56
V8L - V9E	82		482	482	72	53	52	53	53	53	52	51	52	53
V9G - V9Z			481	481	71	56	55	56	56	56	55	54	55	56
Nunavut														
X0A - X0C			481	481		-	-	-	-	-	-	-	-	-
Northwest Territories														
X0E - X9Z			481	481		-	-	-	-	-	-	-	-	-
Yukon														
Y0A - Y9Z			481	481		-	-	-	-	-	-	-	-	-

*To determine whether UPS Worldwide Express Plus and UPS Worldwide Express Services are available to your destination postal code, refer to [ups.com](https://www.ups.com) or call 1-800-782-7892.

Note: UPS Standard is not available to Nunavut, the Northwest Territories or Yukon.

Export

UPS® Standard Zone Chart

SHIPMENTS TO MEXICO

U.S. Origin ZIP Code	Standard Zone
00400-00599	37
01000-03999	37
04000-04999	38
05000-08999	37
10000-14699	37
14700-14799	36
14800-14999	37
15000-16899	36
16900-17299	37
17300-17499	36
17500-19999	37
20000-21799	36
21800-21999	37
22000-28699	36
28700-28999	35
29000-29599	36
29600-29699	35
29700-29799	36
29800-29899	35
29900-29999	36
30000-31299	35
31300-31499	36
31500-32699	35
32700-33499	36
33500-33899	35
33900-33999	36
34100-34199	36
34200-34699	35
34700-34999	36
35000-36499	35
36500-36699	34
36700-36899	35
36900-36999	34
37000-37599	35
37600-37699	36
37700-38699	35
38700-38799	34
38800-38899	35
38900-39699	34
39700-40999	35
41000-41299	36

U.S. Origin ZIP Code	Standard Zone
41300-41499	35
41500-41899	36
42000-42799	35
43000-45999	36
46000-46299	35
46300-46899	36
46900-46999	35
47000-47099	36
47100-47299	35
47300-47399	36
47400-47999	35
48000-49999	36
50000-52099	35
52100-52199	36
52200-52899	35
53000-53799	36
53800-53899	35
53900-56099	36
56100-56199	35
56200-56799	36
57000-57199	35
57200-57299	36
57300-57399	35
57400-59399	36
59400-59699	37
59700-59799	36
59800-59999	37
60000-60899	36
60900-60999	35
61000-61199	36
61200-64799	35
64800-64899	34
64900-65599	35
65600-65999	34
66000-66699	35
66700-66799	34
66800-66999	35
67000-67399	34
67400-67799	35
67800-67999	34
68000-69399	35

U.S. Origin ZIP Code	Standard Zone
70000-70599	34
70600-70699	33
70700-72299	34
72300-72499	35
72500-73299	34
73300-73399	32
73400-74999	34
75000-75499	33
75500-75599	34
75600-76499	33
76500-76599	32
76600-77799	33
77800-78499	32
78500-78599	33
78600-78999	32
79000-79499	34
79500-79799	33
79800-79999	34
80000-82099	35
82100-82199	36
82200-82399	35
82400-83499	36
83500-83599	37
83600-83799	36
83800-83899	37
84000-84499	36
84500-84599	35
84600-84799	36
85000-86399	35
86400-86499	36
86500-87599	35
87700-88599	34
88900-93899	36
93900-96099	37
96100-96199	36
97000-97899	37
97900-97999	36
98000-98699	37
98800-99499	37

Import

Worldwide Zone Chart

Origin	Zones						Origin	Zones							
	UPS Worldwide Express Plus®	UPS Worldwide Express®	UPS Worldwide Express Freight® Midday	UPS Worldwide Express Freight®	UPS Worldwide Saver®	UPS Worldwide Expedited®		UPS Worldwide Express Plus®	UPS Worldwide Express®	UPS Worldwide Express Freight® Midday	UPS Worldwide Express Freight®	UPS Worldwide Saver®	UPS Worldwide Expedited®		
						WEST	EAST						WEST	EAST	
Afghanistan/AF	958	958			458			Canada/CA							
Aland Islands/AX	953	953			453			For UPS 3 Day Select® and UPS® Standard zones, refer to page 42.	91	91	491	491	491	61	61
Albania/AL	958	958			458			Canary Islands (Spain)/ES	953	953			453		
Algeria/DZ	958	958			458			Cape Verde/CV	958	958			458		
American Samoa/AS	958	958			458			Cayman Islands/KY†	952	952			452		
Angola/AO	958	958			458			Chad/TD	958	958			458		
Anguilla/AI†	952	952			452			Channel Islands Guernsey/GG, Jersey/JE	953	953			453	683	653
Antigua and Barbuda/AG†	952	952			452			Chile/CL†	956	956	456	456	456	686	656
Argentina/AR†	956	956	456	456	456	686	656	China, People's Republic of/CN	962	962	462	462	462	692	662
Armenia/AM	958	958			458			Colombia/CO†	956	956	456	456	456	686	656
Aruba/AW†	952	952			452			Comoros/KM	958	958			458		
Australia/AU	954	954	454	454	454	684	654	Congo, Democratic Republic of/CD	958	958			458		
Austria/AT	953	953	453	453	453	683	653	Congo, Republic of/CG	958	958			458		
Azerbaijan/AZ	958	958			458			Costa Rica/CR†	956	956	456	456	456	686	656
Azores (Portugal)/PT	953	953			453	683	653	Côte d'Ivoire (Ivory Coast)/CI	958	958			458		
Bahamas/BS†	952	952			452			Croatia/HR	958	958			458		
Bahrain/BH	955	955	455	455	455	685	655	Curaçao/CW†	952	952			452		
Bangladesh/BD	961	961	461	461	461			Cyprus/CY	955	955			455		
Barbados/BB†	952	952			452			Czech Republic/CZ	957	957	457	457	457	687	657
Belarus/BY	958	958			458			Denmark/DK	953	953	453	453	453	683	653
Belgium*/BE	951	951	451	451	451	681	651	Djibouti/DJ	958	958			458		
Benin/BJ	958	958			458			Dominica/DM†	952	952			452		
Bermuda/BM†	952	952			452			Dominican Republic/DO†	952	952	452	452	452	682	652
Bhutan/BT	961	961			461			Ecuador/EC†	956	956	456	456	456	686	656
Bolivia/BO†	956	956			456			Egypt/EG	955	955			455	685	655
Bonaire/BQ†	952	952			452			El Salvador/SV†	956	956	456	456	456	686	656
Bosnia/BA	958	958			458			England (United Kingdom)*/GB	951	951	451	451	451	681	651
Botswana/BW	958	958			458			Eritrea/ER	958	958			458		
Brazil/BR†	956	956	456	456	456	686	656	Estonia/EE	957	957			457	687	657
British Virgin Islands/VG†	952	952			452			Ethiopia/ET	958	958			458		
Brunei/BN	955	955			455			Fiji/FJ	958	958			458		
Bulgaria/BG	957	957	457	457	457	687	657	Finland/FI	953	953	453	453	453	683	653
Burkina Faso/BF	958	958			458			France/FR	951	951	451	451	451	681	651
Burundi/BI	958	958			458			French Polynesia/PF	958	958			458		
Cambodia/KH	958	958			458			Gabon/GA	958	958			458		
Cameroon/CM	958	958			458			Gambia/GM	958	958			458		
								Georgia/GE	958	958			458		
								Germany*/DE	951	951	451	451	451	681	651

*UPS Worldwide Express NAI® service is available from this country.

†For shipments from South America to Dade or Broward County, Florida, use zone:
 – 971 for UPS Worldwide Express
 – 471 for UPS Worldwide Express Freight Midday
 – 471 for UPS Worldwide Express Freight
 – 471 for UPS Worldwide Saver
 – 671 for UPS Worldwide Expedited

For shipments from the Caribbean to Dade or Broward County, Florida, use zone:
 – 970 for UPS Worldwide Express
 – 470 for UPS Worldwide Express Freight Midday
 – 470 for UPS Worldwide Express Freight
 – 470 for UPS Worldwide Saver
 – 670 for UPS Worldwide Expedited

Import

Worldwide Zone Chart

Origin	Zones						UPS Worldwide Expedited*	WEST	EAST	Origin	Zones						UPS Worldwide Expedited*	WEST	EAST
	UPS Worldwide Express Plus®	UPS Worldwide Express®	UPS Worldwide Express Freight® Midday	UPS Worldwide Express Freight®	UPS Worldwide Saver®	UPS Worldwide Express Freight®					UPS Worldwide Express Plus®	UPS Worldwide Express®	UPS Worldwide Express Freight® Midday	UPS Worldwide Express Freight®	UPS Worldwide Saver®	UPS Worldwide Express Freight®			
Ghana/GH	958	958			458				Liberia/LR	958	958			458					
Gibraltar/GI	958	958			458				Libya/LY	958	958			458					
Great Britain (United Kingdom)*/GB	951	951	451	451	451	681	651		Liechtenstein/LI	953	953	453	453	453	683	653			
Greece/GR	953	953	453	453	453	683	653		Lithuania/LT	957	957	457	457	457	687	657			
Grenada/GD†	952	952			452				Luxembourg/LU	951	951	451	451	451	681	651			
Guadeloupe/GP†	952	952			452				Macau/MO	954	954			454	684	654			
Guam/GU	954	954			454				Macedonia (FYROM)/MK	958	958			458					
Guatemala/GT†	956	956	456	456	456	686	656		Madagascar/MG	958	958			458					
Guernsey/GG	953	953			453	683	653		Madeira (Portugal)/PT	953	953			453	683	653			
Guinea/GN	958	958			458				Malawi/MW	958	958			458					
Guinea-Bissau/GW	958	958			458				Malaysia/MY	954	954	454	454	454	684	654			
Guyana/GY†	956	956			456				Maldives/MV	958	958			458	688	658			
Haiti/HT†	952	952			452	682	652		Mali/ML	958	958			458					
Holland (Netherlands)/NL	951	951	451	451	451	681	651		Malta/MT	958	958	458	458	458					
Honduras/HN†	956	956	456	456	456	686	656		Martinique/MQ†	952	952			452					
Hong Kong/HK	959	959	459	459	459	689	659		Mauritania/MR	958	958			458					
Hungary/HU	957	957	457	457	457	687	657		Mauritius/MU	958	958			458					
Iceland/IS	958	958			458				Mayotte/YT	958	958			458					
India/IN	961	961	461	461	461	691	661		Mexico/MX	94	94	494	494	494	64	64			
Indonesia/ID	954	954	454	454	454	684	654		<i>For UPS® Standard zones, refer to page 43.</i>										
Iraq/IQ	958	958			458	688	658		Moldova/MD	958	958			458					
Ireland, Republic of/IE	951	951	451	451	451	681	651		Monaco/MC	951	951	451	451	451	681	651			
Israel/IL	955	955	455	455	455	685	655		Mongolia/MN	958	958			458					
Italy/IT	951	951	451	451	451	681	651		Montenegro/ME	958	958			458					
Ivory Coast (Côte d'Ivoire)/CI	958	958			458				Montserrat/MS†	952	952			452					
Jamaica/JM†	952	952			452				Morocco/MA	958	958	458	458	458	688	658			
Japan/JP	963	963	463	463	463	693	663		Mozambique/MZ	958	958			458					
Jersey/JE	953	953			453	683	653		Myanmar/MM	961	961			461	691	661			
Jordan/JO	955	955			455				Namibia/NA	958	958			458					
Kazakhstan/KZ	958	958			458	688	658		Nepal/NP	961	961			461					
Kenya/KE	958	958			458	688	658		Netherlands (Holland)*/NL	951	951	451	451	451	681	651			
Korea, South/KR	959	959	459	459	459	689	659		Netherlands Antilles/AN†										
Kosovo/KV	958	958			458				<i>Refer to Bonaire, St. Eustatius, Saba, Curaçao, St. Martin or St. Maarten for zone information.</i>										
Kuwait/KW	955	955			455	685	655		New Caledonia/NC	958	958			458					
Kyrgyzstan/KG	958	958			458				New Zealand/NZ	954	954	454	454	454	684	654			
Laos/LA	958	958			458				Nicaragua/NI†	956	956	456	456	456	686	656			
Latvia/LV	957	957	457	457	457	687	657		Niger/NE	958	958			458					
Lesotho/LS	958	958			458				Nigeria/NG	958	958		458	458	688	658			

*UPS Worldwide Express NA1® service is available from this country.

†For shipments from South America to Dade or Broward County, Florida, use zone:
 – 971 for UPS Worldwide Express
 – 471 for UPS Worldwide Express Freight Midday
 – 471 for UPS Worldwide Express Freight
 – 471 for UPS Worldwide Saver
 – 671 for UPS Worldwide Expedited

For shipments from the Caribbean to Dade or Broward County, Florida, use zone:
 – 970 for UPS Worldwide Express
 – 470 for UPS Worldwide Express Freight Midday
 – 470 for UPS Worldwide Express Freight
 – 470 for UPS Worldwide Saver
 – 670 for UPS Worldwide Expedited

Import

Worldwide Zone Chart

Origin	Zones						Origin	Zones							
	UPS Worldwide Express Plus®	UPS Worldwide Express®	UPS Worldwide Express Freight® Middy	UPS Worldwide Express Freight®	UPS Worldwide Saver®	UPS Worldwide Expedited®		UPS Worldwide Express Plus®	UPS Worldwide Express®	UPS Worldwide Express Freight® Middy	UPS Worldwide Express Freight®	UPS Worldwide Saver®	UPS Worldwide Expedited®		
						WEST	EAST						WEST	EAST	
Northern Ireland (United Kingdom)/GB	951	951	451	451	451	681	651	St. Lucia/LC†	952	952			452	682	652
Northern Mariana Islands/MP	958	958			458			St. Maarten/SX†	952	952			452		
Norway/NO	953	953	453	453	453	683	653	St. Martin/SX†	952	952			452		
Oman/OM	955	955		455	455	685	655	St. Thomas (U.S. Virgin Islands)/VI†	952	952			452		
Pakistan/PK	961	961	461	461	461	691	661	St. Vincent and the Grenadines/VC†	952	952			452		
Panama/PA†	956	956	456	456	456	686	656	Suriname/SR†	956	956			456		
Paraguay/PY†	956	956			456			Swaziland/SZ	958	958			458		
Peru/PE†	956	956			456	686	656	Sweden/SE	953	953	453	453	453	683	653
Philippines/PH	959	959	459	459	459	689	659	Switzerland/CH	953	953	453	453	453	683	653
Poland/PL	957	957	457	457	457	687	657	Taiwan/TW	954	954	454	454	454	684	654
Portugal/PT	953	953	453	453	453	683	653	Tajikistan/TJ	958	958			458		
Qatar/QA	955	955	455	455	455	685	655	Tanzania/TZ	958	958			458		
Réunion/RE	958	958			458			Thailand/TH	954	954	454	454	454	684	654
Romania/RO	957	957	457	457	457	687	657	Tinian (Northern Mariana Islands)/MP	958	958			458		
Rota (Northern Mariana Islands)/MP	958	958			458			Togo/TG	958	958			458		
Russia/RU	957	957		457	457	687	657	Tortola (British Virgin Islands)/VG†	952	952			452		
Rwanda/RW	958	958			458			Trinidad and Tobago/TT†	952	952			452		
Saba/BQ†	952	952			452			Tunisia/TN	958	958	458	458	458		
Saipan (Northern Mariana Islands)/MP	958	958			458			Turkey/TR	955	955	455	455	455	685	655
Samoa/WS	958	958			458			Turkmenistan/TM	958	958			458		
San Marino/SM	951	951	451	451	451	681	651	Turks and Caicos Islands/TC†	952	952			452		
Saudi Arabia/SA	955	955	455	455	455	685	655	Uganda/UG	958	958			458		
Scotland (United Kingdom)/GB	951	951	451	451	451	681	651	Ukraine/UA	958	958			458		
Senegal/SN	958	958			458			Union Island (St. Vincent and the Grenadines)/VC†	952	952			452		
Serbia/RS	958	958	458	458	458			United Arab Emirates/AE	955	955	455	455	455	685	655
Seychelles/SC	958	958			458			United Kingdom*/GB	951	951	451	451	451	681	651
Sierra Leone/SL	958	958			458			Uruguay/UY†	956	956			456		
Singapore/SG	954	954	454	454	454	684	654	U.S. Virgin Islands/VI†	952	952			452		
Slovakia/SK	957	957	457	457	457	687	657	Uzbekistan/UZ	958	958			458		
Slovenia/SI	957	957		457	457	687	657	Vatican City (Italy)/VA	951	951	451	451	451	681	651
South Africa/ZA	957	957	457	457	457	687	657	Venezuela/VE†	956	956			456	686	656
Spain/ES	953	953	453	453	453	683	653	Vietnam/VN	954	954	454	454	454	684	654
Sri Lanka/LK	961	961	461	461	461			Virgin Gorda (British Virgin Islands)/VG†	952	952			452		
St. Barthélemy/BL†	952	952			452			Wales (United Kingdom)/GB	951	951	451	451	451	681	651
St. Christopher (St. Kitts and Nevis)/KN†	952	952			452			Zambia/ZM	958	958			458		
St. Croix (U.S. Virgin Islands)/VI†	952	952			452			Zimbabwe/ZW	958	958			458		
St. Eustatius/BQ†	952	952			452										
St. John (U.S. Virgin Islands)/VI†	952	952			452										
St. Kitts and Nevis/KN†	952	952			452	682	652								

*UPS Worldwide Express NA1® service is available from this country.

†For shipments from South America to Dade or Broward County, Florida, use zone:
 – 971 for UPS Worldwide Express
 – 471 for UPS Worldwide Express Freight Middy
 – 471 for UPS Worldwide Express Freight
 – 471 for UPS Worldwide Saver
 – 671 for UPS Worldwide Expedited

For shipments from the Caribbean to Dade or Broward County, Florida, use zone:
 – 970 for UPS Worldwide Express
 – 470 for UPS Worldwide Express Freight Middy
 – 470 for UPS Worldwide Express Freight
 – 470 for UPS Worldwide Saver
 – 670 for UPS Worldwide Expedited

Import

UPS 3 Day Select® and UPS® Standard Zone Chart

SHIPMENTS FROM CANADA

Destination State	Origin Province					
	Alberta British Columbia		Manitoba Saskatchewan		New Brunswick Newfoundland Nova Scotia Ontario Prince Edward Island Quebec	
	3 Day Zone	Standard Zone	3 Day Zone	Standard Zone	3 Day Zone	Standard Zone
Alabama	477	380	477	380	476	378
Alaska	—	—	—	—	—	—
Arizona	476	378	476	378	477	380
Arkansas	477	380	476	378	476	378
California	476	378	477	380	477	380
Colorado	476	378	476	378	477	380
Connecticut	477	380	476	378	475	376
Delaware	477	380	476	378	475	376
District of Columbia	477	380	476	378	475	376
Florida	477	380	477	380	476	378
Georgia	477	380	477	380	476	378
Hawaii	—	—	—	—	—	—
Idaho	475	376	476	378	477	380
Illinois	477	380	476	378	476	378
Indiana	477	380	476	378	476	378
Iowa	477	380	475	376	476	378
Kansas	477	380	476	378	476	378
Kentucky	477	380	476	378	476	378
Louisiana	477	380	477	380	476	378
Maine	477	380	476	378	475	376
Maryland	477	380	476	378	475	376
Massachusetts	477	380	476	378	475	376
Michigan	477	380	476	378	475	376
Minnesota	477	380	475	376	476	378
Mississippi	477	380	477	380	476	378
Missouri	477	380	476	378	476	378
Montana	475	376	475	376	477	380
Nebraska	476	378	475	376	476	378
Nevada	476	378	476	378	477	380
New Hampshire	477	380	476	378	475	376
New Jersey	477	380	476	378	475	376
New Mexico	476	378	476	378	477	380
New York	477	380	476	378	475	376
North Carolina	477	380	477	380	476	378
North Dakota	476	378	475	376	476	378
Ohio	477	380	476	378	475	376
Oklahoma	477	380	476	378	476	378
Oregon	475	376	476	378	477	380
Pennsylvania	477	380	476	378	475	376
Rhode Island	477	380	476	378	475	376
South Carolina	477	380	477	380	476	378
South Dakota	476	378	475	376	476	378
Tennessee	477	380	476	378	476	378
Texas	477	380	477	380	477	380
Utah	476	378	476	378	477	380
Vermont	477	380	476	378	475	376
Virginia	477	380	476	378	476	378
Washington	475	376	476	378	477	380
West Virginia	477	380	476	378	475	376
Wisconsin	477	380	475	376	476	378
Wyoming	476	378	475	376	477	380

Import

UPS® Standard Zone Chart

SHIPMENTS FROM MEXICO

Destination ZIP Code	Standard Zone
00400-00599	367
01000-03999	367
04000-04999	368
05000-08999	367
10000-14699	367
14700-14799	366
14800-14999	367
15000-16899	366
16900-17299	367
17300-17499	366
17500-19999	367
20000-21799	366
21800-21999	367
22000-28699	366
28700-28999	365
29000-29599	366
29600-29699	365
29700-29799	366
29800-29899	365
29900-29999	366
30000-31299	365
31300-31499	366
31500-32699	365
32700-33499	366
33500-33899	365
33900-33999	366
34100-34199	366
34200-34699	365
34700-34999	366
35000-36499	365
36500-36699	364
36700-36899	365
36900-36999	364
37000-37599	365
37600-37699	366
37700-38699	365
38700-38799	364
38800-38899	365
38900-39699	364
39700-40999	365
41000-41299	366

Destination ZIP Code	Standard Zone
41300-41499	365
41500-41899	366
42000-42799	365
43000-45999	366
46000-46299	365
46300-46899	366
46900-46999	365
47000-47099	366
47100-47299	365
47300-47399	366
47400-47999	365
48000-49999	366
50000-52099	365
52100-52199	366
52200-52899	365
53000-53799	366
53800-53899	365
53900-56099	366
56100-56199	365
56200-56799	366
57000-57199	365
57200-57299	366
57300-57399	365
57400-59399	366
59400-59699	367
59700-59799	366
59800-59999	367
60000-60899	366
60900-60999	365
61000-61199	366
61200-64799	365
64800-64899	364
64900-65599	365
65600-65999	364
66000-66699	365
66700-66799	364
66800-66999	365
67000-67399	364
67400-67799	365
67800-67999	364
68000-69399	365

Destination ZIP Code	Standard Zone
70000-70599	364
70600-70699	363
70700-72299	364
72300-72499	365
72500-73299	364
73300-73399	362
73400-74999	364
75000-75499	363
75500-75599	364
75600-76499	363
76500-76599	362
76600-77799	363
77800-78499	362
78500-78599	363
78600-78999	362
79000-79499	364
79500-79799	363
79800-79999	364
80000-82099	365
82100-82199	366
82200-82399	365
82400-83499	366
83500-83599	367
83600-83799	366
83800-83899	367
84000-84499	366
84500-84599	365
84600-84799	366
85000-86399	365
86400-86499	366
86500-87599	365
87700-88599	364
88900-93899	366
93900-96099	367
96100-96199	366
97000-97899	367
97900-97999	366
98000-98699	367
98800-99499	367

Domestic

UPS Next Day Air[®] Early

Guaranteed on-time overnight delivery on business days by 8:00 a.m. to major cities in the 48 contiguous states and by 8:30 a.m., 9:00 a.m. or 9:30 a.m. to most other cities in the U.S., including Anchorage, Alaska. Additional extended delivery locations are guaranteed up to 2:00 p.m. Optional Saturday Delivery and pickup available in select locations.

Zones	102	103	104	105	106	107	108	124*
Letter**	\$56.59	\$62.30	\$71.56	\$74.92	\$75.82	\$80.89	\$83.21	\$92.14
1 Lbs.	62.09	77.51	92.72	100.26	103.98	114.01	116.30	123.72
2	62.51	77.79	98.49	105.44	107.69	117.47	126.44	132.85
3	65.47	83.00	105.85	116.22	122.72	131.80	135.41	140.83
4	68.71	84.14	114.84	124.41	127.85	140.57	144.72	155.50
5	69.02	84.44	116.61	125.25	128.74	141.98	145.21	165.83
6	74.72	90.09	127.40	141.41	146.53	158.56	164.10	175.66
7	75.31	93.23	131.76	146.88	151.32	164.18	173.26	185.30
8	75.50	93.56	135.63	151.42	157.04	172.12	177.72	194.69
9	75.70	94.00	139.98	151.88	157.62	172.92	178.20	205.34
10	76.11	94.82	141.19	152.96	159.38	174.30	179.47	215.61
11	84.16	106.31	165.58	186.07	193.99	201.89	205.35	227.62
12	85.44	108.84	168.64	193.37	201.47	205.49	209.02	237.25
13	85.64	109.61	171.35	198.66	202.21	221.08	224.93	247.59
14	86.77	110.60	177.54	199.04	202.43	222.64	226.50	248.64
15	86.99	111.07	179.68	200.11	203.52	223.62	227.51	264.35
16	90.67	120.77	190.65	220.12	225.08	243.22	247.49	273.63
17	94.05	121.75	199.63	222.89	227.33	245.18	249.50	279.03
18	94.56	122.25	200.65	223.10	227.55	245.38	249.69	285.20
19	94.98	122.44	200.84	223.25	227.75	245.59	249.90	293.68
20	95.31	122.85	200.89	224.25	228.35	246.21	250.13	298.86
21	98.18	127.09	215.99	229.94	240.47	258.11	271.74	305.05
22	101.28	132.48	221.56	237.58	241.95	269.86	280.94	311.22
23	101.69	133.02	227.25	246.75	259.05	282.97	288.06	318.86
24	103.59	133.46	230.08	255.51	260.77	287.75	293.26	324.32
25	103.97	133.87	236.92	256.39	265.26	288.80	293.93	333.59
26	108.50	142.11	248.91	272.02	283.92	295.24	307.06	338.19
27	108.80	142.95	253.89	273.12	289.42	301.71	319.47	344.60
28	110.45	143.34	259.91	280.26	290.47	307.75	326.65	350.48
29	110.86	143.91	265.15	280.99	291.00	314.81	328.21	355.58
30	111.21	144.13	265.68	283.19	291.87	316.06	328.26	361.48
31	114.47	147.34	275.70	294.50	313.60	326.78	339.83	367.44
32	116.72	150.15	280.90	296.07	316.39	328.22	343.25	373.85
33	118.80	156.92	285.48	312.07	321.86	344.75	356.91	381.61
34	120.71	157.59	290.43	315.20	322.38	352.42	358.88	386.49
35	122.64	157.98	291.45	315.50	322.89	355.42	361.95	387.29

*Zone 124 includes metro Alaska.

**The Letter rate applies only to documents, correspondence and electronic media shipments that do not exceed eight ounces sent in a UPS Express[®] Envelope.

Note: For additional information, refer to page [26](#).

Domestic

UPS Next Day Air[®] Early

Zones	102	103	104	105	106	107	108	124*
36 Lbs.	\$126.49	\$160.49	\$301.30	\$321.26	\$333.15	\$359.47	\$368.99	\$403.16
37	127.15	169.23	308.14	339.35	347.82	371.08	380.50	411.16
38	127.48	170.11	311.96	340.51	353.02	372.17	381.66	418.21
39	127.86	170.48	316.86	340.70	353.54	380.79	387.92	425.81
40	128.11	170.86	317.35	341.68	354.45	381.66	388.70	433.75
41	132.45	177.56	327.33	350.66	372.40	386.65	404.26	441.70
42	133.94	178.22	331.13	355.55	374.19	387.97	411.29	450.05
43	136.74	180.60	338.84	364.27	380.46	404.20	432.48	458.53
44	139.13	188.50	343.99	371.71	386.58	410.28	434.74	467.81
45	143.64	194.65	348.01	376.86	387.21	417.69	435.39	474.73
46	146.33	195.27	353.17	384.52	398.63	422.11	451.29	482.47
47	148.02	197.70	353.75	385.90	401.12	423.27	453.52	489.76
48	149.35	198.03	354.51	389.92	401.50	430.41	454.07	498.37
49	149.40	198.24	354.61	390.02	401.71	430.64	454.30	501.00
50	149.46	199.18	354.87	390.47	403.18	431.51	455.53	506.57
51	162.45	216.14	376.45	420.70	428.65	461.31	475.54	525.72
52	164.49	225.89	401.23	428.35	443.25	478.16	500.10	551.86
53	165.93	226.88	403.71	437.20	444.70	499.71	509.80	554.47
54	166.35	227.29	404.11	441.03	445.13	501.86	510.77	568.58
55	166.85	230.71	406.81	442.04	446.15	501.91	511.17	574.00
56	176.77	241.95	407.22	449.19	457.58	501.96	511.57	576.28
57	178.03	244.08	407.93	450.31	459.53	502.52	511.97	581.65
58	178.46	244.97	408.38	450.71	468.32	503.79	513.27	601.36
59	178.87	245.40	417.38	457.05	469.21	505.92	538.90	603.34
60	179.30	245.82	418.28	457.69	470.11	536.40	541.47	616.96
61	187.08	253.43	433.89	470.07	487.94	547.10	557.45	627.08
62	188.89	260.35	440.04	475.53	489.81	554.49	570.15	628.11
63	189.34	261.06	443.73	476.16	491.93	561.97	572.61	628.92
64	197.33	268.38	444.13	488.67	506.22	571.58	592.69	644.92
65	198.13	269.99	447.70	493.69	509.22	579.98	599.02	646.52
66	198.56	270.66	465.09	508.13	523.91	580.82	600.19	647.48
67	200.18	283.75	466.82	512.81	525.38	581.22	600.59	666.39
68	204.01	285.22	467.22	519.07	525.81	581.62	603.90	668.28
69	204.42	285.65	467.67	520.37	526.62	582.02	614.86	669.65
70	204.85	286.07	468.07	522.11	527.04	583.20	615.96	690.62
71	209.84	286.49	469.50	523.00	527.96	606.55	618.09	706.23
72	210.99	294.03	497.82	539.55	544.65	631.65	660.49	712.73
73	211.42	299.54	500.65	541.20	546.32	634.16	664.74	714.11
74	211.85	300.10	501.09	541.62	546.74	634.56	665.20	741.77
75	212.70	300.95	501.89	542.46	547.58	635.37	666.00	744.54

*Zone 124 includes metro Alaska.

Note: For additional information, refer to page [26](#).

Domestic

UPS Next Day Air[®] Early

Zones	102	103	104	105	106	107	108	124*
76 Lbs.	\$222.12	\$308.48	\$504.42	\$546.83	\$552.00	\$651.36	\$666.80	\$751.67
77	223.07	317.80	506.36	563.37	573.13	652.96	667.60	755.93
78	223.92	318.73	523.83	570.51	587.30	659.94	668.40	762.42
79	224.76	319.57	525.58	578.57	595.55	670.75	677.17	800.18
80	225.61	320.43	526.38	580.32	597.16	673.41	679.86	804.39
81	234.36	324.19	541.08	614.02	627.23	689.66	697.01	805.39
82	235.24	325.05	543.78	617.39	630.24	691.28	698.72	806.28
83	236.10	325.90	544.61	618.22	631.07	692.13	699.58	807.16
84	236.94	326.76	545.45	619.06	631.93	705.60	713.63	807.96
85	237.80	327.61	546.28	619.89	632.73	705.65	715.17	816.67
86	247.07	344.53	547.75	627.33	633.87	707.84	716.03	817.85
87	248.21	349.56	566.33	630.35	636.57	708.88	717.11	841.36
88	249.06	350.41	568.20	631.18	638.12	711.46	720.58	857.96
89	249.91	351.25	590.37	651.76	669.00	758.43	789.96	859.63
90	250.76	352.10	612.13	655.39	676.99	789.28	804.36	861.40
91	260.85	363.98	614.33	656.21	677.81	792.37	805.79	862.19
92	261.87	365.18	615.13	657.01	678.95	793.23	806.73	862.98
93	262.76	365.99	615.93	657.81	679.77	794.07	807.65	863.77
94	263.56	366.81	616.73	658.61	680.59	795.22	808.59	864.57
95	270.84	367.62	617.53	663.12	681.44	796.06	809.52	865.36
96	271.64	371.84	618.33	667.36	686.44	798.51	810.34	866.15
97	272.73	372.67	619.30	672.61	693.22	799.34	811.39	867.83
98	273.60	373.47	638.69	674.54	706.36	801.17	813.26	901.49
99	275.62	374.30	648.06	709.65	731.08	837.78	850.49	934.98
100	277.26	375.42	655.19	725.89	740.03	875.22	912.00	1,034.85
101	279.73	378.89	661.46	732.86	747.14	883.45	920.82	1,044.90
102	282.20	382.35	667.71	739.82	754.24	891.90	929.64	1,054.95
103	284.68	385.80	673.96	746.77	761.33	900.35	938.46	1,065.00
104	287.15	389.25	680.20	753.73	768.45	908.80	947.28	1,075.05
105	289.84	392.70	686.45	760.70	775.54	917.25	956.10	1,085.10
106	292.08	396.16	692.71	767.65	782.63	925.70	964.92	1,095.15
107	294.56	399.61	698.97	774.61	789.75	934.15	973.74	1,105.19
108	297.03	403.06	705.22	781.57	796.84	942.60	982.56	1,115.24
109	299.50	406.51	711.47	788.53	803.94	951.05	991.38	1,125.29
110	301.99	409.97	717.72	795.49	811.05	959.50	1,000.20	1,135.34
111	304.47	413.42	723.96	802.45	818.14	967.95	1,009.02	1,145.39
112	306.94	416.88	730.22	809.40	825.24	976.40	1,017.84	1,155.44
113	308.87	420.33	736.48	816.37	832.35	984.85	1,026.66	1,163.81
114	311.88	423.80	742.73	823.33	839.45	993.30	1,035.48	1,173.85
115	314.36	427.25	748.98	830.28	846.54	1,001.75	1,044.30	1,185.58

*Zone 124 includes metro Alaska.

Note: For additional information, refer to page [26](#).

Domestic

UPS Next Day Air[®] Early

Zones	102	103	104	105	106	107	108	124*
116 Lbs.	\$316.82	\$430.70	\$755.23	\$837.24	\$853.64	\$1,010.20	\$1,053.12	\$1,195.63
117	319.29	434.15	761.48	844.21	860.75	1,018.65	1,061.94	1,205.68
118	321.21	437.61	767.73	851.16	867.84	1,027.10	1,070.76	1,215.73
119	324.24	441.06	773.99	858.12	874.95	1,035.55	1,079.58	1,224.01
120	326.71	444.51	780.24	865.08	882.05	1,044.00	1,088.40	1,235.82
121	329.18	447.96	786.49	872.04	889.14	1,052.45	1,097.22	1,245.87
122	331.65	451.42	792.74	879.00	896.25	1,060.90	1,106.04	1,255.92
123	334.13	454.88	798.99	885.96	903.35	1,069.35	1,114.86	1,265.97
124	336.60	458.33	805.25	892.91	910.45	1,077.80	1,123.68	1,274.19
125	339.07	461.79	811.51	899.86	917.55	1,086.25	1,132.50	1,284.22
126	341.54	465.24	817.75	906.84	924.65	1,094.70	1,141.32	1,294.25
127	343.41	468.69	824.00	913.79	931.75	1,103.15	1,150.14	1,304.29
128	345.88	472.14	830.25	920.74	938.84	1,111.60	1,158.96	1,314.31
129	348.96	475.61	836.50	927.71	945.96	1,120.05	1,167.78	1,324.33
130	351.43	479.06	842.76	934.67	953.05	1,128.50	1,176.60	1,334.38
131	353.28	482.51	849.01	941.62	960.14	1,136.95	1,185.42	1,344.41
132	355.75	485.96	855.27	948.59	967.25	1,145.40	1,194.24	1,354.43
133	358.22	489.42	861.51	955.54	974.35	1,153.85	1,203.06	1,364.49
134	360.68	492.88	867.76	962.50	981.45	1,162.30	1,211.88	1,374.53
135	363.80	496.33	874.01	969.47	988.55	1,170.75	1,220.70	1,384.54
136	365.62	499.78	880.27	976.42	995.65	1,179.20	1,229.52	1,394.60
137	368.09	503.24	886.52	983.37	1,002.75	1,187.65	1,238.34	1,404.63
138	371.21	506.69	892.78	990.35	1,009.85	1,196.10	1,247.16	1,414.66
139	373.03	510.14	899.03	997.30	1,016.96	1,204.55	1,255.98	1,424.68
140	375.51	513.59	905.27	1,004.25	1,024.05	1,213.00	1,264.80	1,434.72
141	378.63	517.05	911.52	1,011.22	1,031.15	1,221.45	1,273.62	1,444.76
142	381.10	520.50	917.78	1,018.18	1,038.26	1,229.90	1,282.44	1,454.79
143	382.90	523.96	924.03	1,025.13	1,045.35	1,238.35	1,291.26	1,464.82
144	385.38	527.41	930.29	1,032.10	1,052.46	1,246.80	1,300.08	1,474.86
145	387.84	530.88	936.54	1,039.05	1,059.55	1,255.25	1,308.90	1,484.89
146	390.31	534.33	942.79	1,046.01	1,066.65	1,263.70	1,317.72	1,494.92
147	392.77	537.78	949.03	1,052.98	1,073.76	1,272.15	1,326.54	1,504.97
148	395.25	541.23	955.29	1,059.93	1,080.85	1,280.60	1,335.36	1,514.99
149	398.41	544.69	961.54	1,066.88	1,087.96	1,289.05	1,344.18	1,525.03
150	400.88	548.14	967.79	1,073.86	1,095.06	1,297.50	1,353.00	1,535.06
More Than 150 Pounds**								
Price Per Pound	\$2.47	\$3.45	\$6.25	\$6.96	\$7.10	\$8.45	\$8.82	\$10.03

*Zone 124 includes metro Alaska.

**For each UPS Next Day Air Early package with a weight of more than 150 pounds, multiply the weight by the price per pound and add \$30.00.

Note: For additional information, refer to page [26](#).

Domestic

UPS Next Day Air®

Guaranteed on-time delivery to all 50 states and Puerto Rico by 10:30 a.m., 12:00 p.m. or end of next business day, depending on destination, with some limitations to Alaska and Hawaii. Optional Saturday Delivery and pickup available.

Zones	102	103	104	105	106	107	108	124*	125*	126*
Letter**	\$26.59	\$32.30	\$41.56	\$44.92	\$45.82	\$50.89	\$53.21	\$62.14	\$45.00	\$67.76
1 Lbs.	32.09	47.51	62.72	70.26	73.98	84.01	86.30	93.72	72.77	93.77
2	32.51	47.79	68.49	75.44	77.69	87.47	96.44	102.85	79.45	102.95
3	35.47	53.00	75.85	86.22	92.72	101.80	105.41	110.83	88.54	127.10
4	38.71	54.14	84.84	94.41	97.85	110.57	114.72	125.50	96.72	142.74
5	39.02	54.44	86.61	95.25	98.74	111.98	115.21	135.83	104.75	152.96
6	44.72	60.09	97.40	111.41	116.53	128.56	134.10	145.66	112.32	163.68
7	45.31	63.23	101.76	116.88	121.32	134.18	143.26	155.30	120.35	174.41
8	45.50	63.56	105.63	121.42	127.04	142.12	147.72	164.69	126.92	182.60
9	45.70	64.00	109.98	121.88	127.62	142.92	148.20	175.34	135.04	192.59
10	46.11	64.82	111.19	122.96	129.38	144.30	149.47	185.61	143.73	193.88
11	54.16	76.31	135.58	156.07	163.99	171.89	175.35	197.62	151.86	219.36
12	55.44	78.84	138.64	163.37	171.47	175.49	179.02	207.25	159.24	224.16
13	55.64	79.61	141.35	168.66	172.21	191.08	194.93	217.59	166.35	230.26
14	56.77	80.60	147.54	169.04	172.43	192.64	196.50	218.64	173.88	230.87
15	56.99	81.07	149.68	170.11	173.52	193.62	197.51	234.35	180.04	242.22
16	60.67	90.77	160.65	190.12	195.08	213.22	217.49	243.63	187.06	252.48
17	64.05	91.75	169.63	192.89	197.33	215.18	219.50	249.03	191.20	259.43
18	64.56	92.25	170.65	193.10	197.55	215.38	219.69	255.20	196.10	269.44
19	64.98	92.44	170.84	193.25	197.75	215.59	219.90	263.68	202.62	276.49
20	65.31	92.85	170.89	194.25	198.35	216.21	220.13	268.86	206.60	294.05
21	68.18	97.09	185.99	199.94	210.47	228.11	241.74	275.05	211.30	301.81
22	71.28	102.48	191.56	207.58	211.95	239.86	250.94	281.22	216.09	308.50
23	71.69	103.02	197.25	216.75	229.05	252.97	258.06	288.86	221.96	313.52
24	73.59	103.46	200.08	225.51	230.77	257.75	263.26	294.32	226.15	319.31
25	73.97	103.87	206.92	226.39	235.26	258.80	263.93	303.59	233.22	321.18
26	78.50	112.11	218.91	242.02	253.92	265.24	277.06	308.19	236.75	331.06
27	78.80	112.95	223.89	243.12	259.42	271.71	289.47	314.60	241.80	336.44
28	80.45	113.34	229.91	250.26	260.47	277.75	296.65	320.48	246.30	343.40
29	80.86	113.91	235.15	250.99	261.00	284.81	298.21	325.58	250.13	350.95
30	81.21	114.13	235.68	253.19	261.87	286.06	298.26	331.48	254.62	352.25
31	84.47	117.34	245.70	264.50	283.60	296.78	309.83	337.44	259.23	363.44
32	86.72	120.15	250.90	266.07	286.39	298.22	313.25	343.85	264.07	370.99
33	88.80	126.92	255.48	282.07	291.86	314.75	326.91	351.61	270.09	378.75
34	90.71	127.59	260.43	285.20	292.38	322.42	328.88	356.49	275.58	385.73
35	92.64	127.98	261.45	285.50	292.89	325.42	331.95	357.29	281.20	393.12

*Zone 124 is metro Alaska and Hawaii, zone 125 is Puerto Rico and zone 126 is remote Alaska and Hawaii. Zone 126 for remote Hawaii is not delivered the next business day. Delivery to this zone requires an additional day.

**The Letter rate applies only to documents, correspondence and electronic media shipments that do not exceed eight ounces sent in a UPS Express® Envelope.

Note: For additional information, refer to page 26.

Domestic

UPS Next Day Air[®]

Zones	102	103	104	105	106	107	108	124*	125*	126*
36 Lbs.	\$96.49	\$130.49	\$271.30	\$291.26	\$303.15	\$329.47	\$338.99	\$373.16	\$286.64	\$401.62
37	97.15	139.23	278.14	309.35	317.82	341.08	350.50	381.16	292.91	407.93
38	97.48	140.11	281.96	310.51	323.02	342.17	351.66	388.21	298.22	414.20
39	97.86	140.48	286.86	310.70	323.54	350.79	357.92	395.81	304.02	414.85
40	98.11	140.86	287.35	311.68	324.45	351.66	358.70	403.75	310.18	415.98
41	102.45	147.56	297.33	320.66	342.40	356.65	374.26	411.70	316.29	438.29
42	103.94	148.22	301.13	325.55	344.19	357.97	381.29	420.05	322.71	440.53
43	106.74	150.60	308.84	334.27	350.46	374.20	402.48	428.53	329.27	441.51
44	109.13	158.50	313.99	341.71	356.58	380.28	404.74	437.81	336.38	461.09
45	113.64	164.65	318.01	346.86	357.21	387.69	405.39	444.73	341.75	463.37
46	116.33	165.27	323.17	354.52	368.63	392.11	421.29	452.47	347.65	476.29
47	118.02	167.70	323.75	355.90	371.12	393.27	423.52	459.76	353.15	477.59
48	119.35	168.03	324.51	359.92	371.50	400.41	424.07	468.37	359.72	477.97
49	119.40	168.24	324.61	360.02	371.71	400.64	424.30	471.00	366.19	480.43
50	119.46	169.18	324.87	360.47	373.18	401.51	425.53	476.57	366.29	486.10
51	132.45	186.14	346.45	390.70	398.65	431.31	445.54	495.72	380.07	515.90
52	134.49	195.89	371.23	398.35	413.25	448.16	470.10	521.86	387.75	532.29
53	135.93	196.88	373.71	407.20	414.70	469.71	479.80	524.47	394.26	534.97
54	136.35	197.29	374.11	411.03	415.13	471.86	480.77	538.58	401.64	549.35
55	136.85	200.71	376.81	412.04	416.15	471.91	481.17	544.00	407.89	554.89
56	146.77	211.95	377.22	419.19	427.58	471.96	481.57	546.28	414.36	557.21
57	148.03	214.08	377.93	420.31	429.53	472.52	481.97	551.65	421.23	562.69
58	148.46	214.97	378.38	420.71	438.32	473.79	483.27	571.36	428.65	582.80
59	148.87	215.40	387.38	427.05	439.21	475.92	508.90	573.34	430.47	584.82
60	149.30	215.82	388.28	427.69	440.11	506.40	511.47	586.96	441.48	598.71
61	157.08	223.43	403.89	440.07	457.94	517.10	527.45	597.08	451.22	609.03
62	158.89	230.35	410.04	445.53	459.81	524.49	540.15	598.11	458.26	610.08
63	159.34	231.06	413.73	446.16	461.93	531.97	542.61	598.92	465.77	610.91
64	167.33	238.38	414.13	458.67	476.22	541.58	562.69	614.92	473.24	627.21
65	168.13	239.99	417.70	463.69	479.22	549.98	569.02	616.52	473.39	628.86
66	168.56	240.66	435.09	478.13	493.91	550.82	570.19	617.48	481.74	653.30
67	170.18	253.75	436.82	482.81	495.38	551.22	570.59	636.39	496.63	655.74
68	174.01	255.22	437.22	489.07	495.81	551.62	573.90	638.28	497.89	656.13
69	174.42	255.65	437.67	490.37	496.62	552.02	584.86	639.65	513.34	660.28
70	174.85	256.07	438.07	492.11	497.04	553.20	585.96	660.62	520.21	674.56
71	179.84	256.49	439.50	493.00	497.96	576.55	588.09	676.23	529.71	689.94
72	180.99	264.03	467.82	509.55	514.65	601.65	630.49	682.73	529.86	696.39
73	181.42	269.54	470.65	511.20	516.32	604.16	634.74	684.11	538.85	697.81
74	181.85	270.10	471.09	511.62	516.74	604.56	635.20	711.77	539.05	726.00
75	182.70	270.95	471.89	512.46	517.58	605.37	636.00	714.54	539.15	728.83

*Zone 124 is metro Alaska and Hawaii, zone 125 is Puerto Rico, and zone 126 is remote Alaska and Hawaii. Zone 126 for remote Hawaii is not delivered the next business day. Delivery to this zone requires an additional day.

Note: For additional information, refer to page [26](#).

Domestic

UPS Next Day Air®

Zones	102	103	104	105	106	107	108	124*	125*	126*
76 Lbs.	\$192.12	\$278.48	\$474.42	\$516.83	\$522.00	\$621.36	\$636.80	\$721.67	\$561.52	\$736.10
77	193.07	287.80	476.36	533.37	543.13	622.96	637.60	725.93	574.24	754.84
78	193.92	288.73	493.83	540.51	557.30	629.94	638.40	732.42	581.73	785.98
79	194.76	289.57	495.58	548.57	565.55	640.75	647.17	770.18	583.49	789.09
80	195.61	290.43	496.38	550.32	567.16	643.41	649.86	774.39	596.77	789.89
81	204.36	294.19	511.08	584.02	597.23	659.66	667.01	775.39	596.92	790.91
82	205.24	295.05	513.78	587.39	600.24	661.28	668.72	776.28	606.92	791.82
83	206.10	295.90	514.61	588.22	601.07	662.13	669.58	777.16	607.07	792.72
84	206.94	296.76	515.45	589.06	601.93	675.60	683.63	777.96	613.07	793.96
85	207.80	297.61	516.28	589.89	602.73	675.65	685.17	786.67	613.18	818.62
86	217.07	314.53	517.75	597.33	603.87	677.84	686.03	787.85	613.33	824.60
87	218.21	319.56	536.33	600.35	606.57	678.88	687.11	811.36	641.26	827.60
88	219.06	320.41	538.20	601.18	608.12	681.46	690.58	827.96	641.36	844.52
89	219.91	321.25	560.37	621.76	639.00	728.43	759.96	829.63	661.81	846.24
90	220.76	322.10	582.13	625.39	646.99	759.28	774.36	831.40	661.96	848.04
91	230.85	333.98	584.33	626.21	647.81	762.37	775.79	832.19	678.89	848.84
92	231.87	335.18	585.13	627.01	648.95	763.23	776.73	832.98	686.30	855.65
93	232.76	335.99	585.93	627.81	649.77	764.07	777.65	833.77	686.50	858.47
94	233.56	336.81	586.73	628.61	650.59	765.22	778.59	834.57	686.55	858.84
95	240.84	337.62	587.53	633.12	651.44	766.06	779.52	835.36	688.97	859.47
96	241.64	341.84	588.33	637.36	656.44	768.51	780.34	836.15	691.45	904.44
97	242.73	342.67	589.30	642.61	663.22	769.34	781.39	837.83	707.51	909.03
98	243.60	343.47	608.69	644.54	676.36	771.17	783.26	871.49	707.61	910.02
99	245.62	344.30	618.06	679.65	701.08	807.78	820.49	904.98	717.31	923.09
100	247.26	345.42	625.19	695.89	710.03	845.22	882.00	1,004.85	766.59	1,025.64
101	249.73	348.89	631.46	702.86	717.14	853.45	890.82	1,014.90	774.26	1,035.90
102	252.20	352.35	637.71	709.82	724.24	861.90	899.64	1,024.95	781.93	1,046.16
103	254.68	355.80	643.96	716.77	731.33	870.35	908.46	1,035.00	789.60	1,056.41
104	257.15	359.25	650.20	723.73	738.45	878.80	917.28	1,045.05	797.26	1,066.67
105	259.84	362.70	656.45	730.70	745.54	887.25	926.10	1,055.10	804.93	1,076.93
106	262.08	366.16	662.71	737.65	752.63	895.70	934.92	1,065.15	812.60	1,087.18
107	264.56	369.61	668.97	744.61	759.75	904.15	943.74	1,075.19	820.26	1,097.44
108	267.03	373.06	675.22	751.57	766.84	912.60	952.56	1,085.24	827.92	1,107.70
109	269.50	376.51	681.47	758.53	773.94	921.05	961.38	1,095.29	835.59	1,117.95
110	271.99	379.97	687.72	765.49	781.05	929.50	970.20	1,105.34	843.26	1,128.21
111	274.47	383.42	693.96	772.45	788.14	937.95	979.02	1,115.39	850.93	1,138.47
112	276.94	386.88	700.22	779.40	795.24	946.40	987.84	1,125.44	858.59	1,148.72
113	278.87	390.33	706.48	786.37	802.35	954.85	996.66	1,133.81	866.25	1,158.98
114	281.88	393.80	712.73	793.33	809.45	963.30	1,005.48	1,143.85	873.93	1,169.23
115	284.36	397.25	718.98	800.28	816.54	971.75	1,014.30	1,155.58	881.58	1,179.49

*Zone 124 is metro Alaska and Hawaii, zone 125 is Puerto Rico, and zone 126 is remote Alaska and Hawaii. Zone 126 for remote Hawaii is not delivered the next business day. Delivery to this zone requires an additional day.

Note: For additional information, refer to page [26](#).

Domestic

UPS Next Day Air[®]

Zones	102	103	104	105	106	107	108	124*	125*	126*
116 Lbs.	\$286.82	\$400.70	\$725.23	\$807.24	\$823.64	\$980.20	\$1,023.12	\$1,165.63	\$889.25	\$1,189.75
117	289.29	404.15	731.48	814.21	830.75	988.65	1,031.94	1,175.68	896.92	1,200.00
118	291.21	407.61	737.73	821.16	837.84	997.10	1,040.76	1,185.73	904.58	1,210.26
119	294.24	411.06	743.99	828.12	844.95	1,005.55	1,049.58	1,194.01	912.26	1,220.52
120	296.71	414.51	750.24	835.08	852.05	1,014.00	1,058.40	1,205.82	919.91	1,230.77
121	299.18	417.96	756.49	842.04	859.14	1,022.45	1,067.22	1,215.87	927.58	1,241.03
122	301.65	421.42	762.74	849.00	866.25	1,030.90	1,076.04	1,225.92	935.25	1,251.29
123	304.13	424.88	768.99	855.96	873.35	1,039.35	1,084.86	1,235.97	942.92	1,261.54
124	306.60	428.33	775.25	862.91	880.45	1,047.80	1,093.68	1,244.19	950.58	1,271.80
125	309.07	431.79	781.51	869.86	887.55	1,056.25	1,102.50	1,254.22	958.26	1,282.05
126	311.54	435.24	787.75	876.84	894.65	1,064.70	1,111.32	1,264.25	965.91	1,292.31
127	313.41	438.69	794.00	883.79	901.75	1,073.15	1,120.14	1,274.29	973.57	1,302.57
128	315.88	442.14	800.25	890.74	908.84	1,081.60	1,128.96	1,284.31	981.25	1,312.82
129	318.96	445.61	806.50	897.71	915.96	1,090.05	1,137.78	1,294.33	988.90	1,323.08
130	321.43	449.06	812.76	904.67	923.05	1,098.50	1,146.60	1,304.38	996.58	1,333.34
131	323.28	452.51	819.01	911.62	930.14	1,106.95	1,155.42	1,314.41	1,004.24	1,343.59
132	325.75	455.96	825.27	918.59	937.25	1,115.40	1,164.24	1,324.43	1,011.90	1,353.85
133	328.22	459.42	831.51	925.54	944.35	1,123.85	1,173.06	1,334.49	1,019.58	1,364.11
134	330.68	462.88	837.76	932.50	951.45	1,132.30	1,181.88	1,344.53	1,027.23	1,374.36
135	333.80	466.33	844.01	939.47	958.55	1,140.75	1,190.70	1,354.54	1,034.90	1,384.62
136	335.62	469.78	850.27	946.42	965.65	1,149.20	1,199.52	1,364.60	1,042.57	1,394.88
137	338.09	473.24	856.52	953.37	972.75	1,157.65	1,208.34	1,374.63	1,050.24	1,405.13
138	341.21	476.69	862.78	960.35	979.85	1,166.10	1,217.16	1,384.66	1,057.91	1,415.39
139	343.03	480.14	869.03	967.30	986.96	1,174.55	1,225.98	1,394.68	1,065.57	1,425.64
140	345.51	483.59	875.27	974.25	994.05	1,183.00	1,234.80	1,404.72	1,073.23	1,435.90
141	348.63	487.05	881.52	981.22	1,001.15	1,191.45	1,243.62	1,414.76	1,080.91	1,446.16
142	351.10	490.50	887.78	988.18	1,008.26	1,199.90	1,252.44	1,424.79	1,088.57	1,456.41
143	352.90	493.96	894.03	995.13	1,015.35	1,208.35	1,261.26	1,434.82	1,096.22	1,466.67
144	355.38	497.41	900.29	1,002.10	1,022.46	1,216.80	1,270.08	1,444.86	1,103.90	1,476.93
145	357.84	500.88	906.54	1,009.05	1,029.55	1,225.25	1,278.90	1,454.89	1,111.56	1,487.18
146	360.31	504.33	912.79	1,016.01	1,036.65	1,233.70	1,287.72	1,464.92	1,119.24	1,497.44
147	362.77	507.78	919.03	1,022.98	1,043.76	1,242.15	1,296.54	1,474.97	1,126.90	1,507.70
148	365.25	511.23	925.29	1,029.93	1,050.85	1,250.60	1,305.36	1,484.99	1,134.56	1,517.95
149	368.41	514.69	931.54	1,036.88	1,057.96	1,259.05	1,314.18	1,495.03	1,142.23	1,528.21
150	370.88	518.14	937.79	1,043.86	1,065.06	1,267.50	1,323.00	1,505.06	1,149.90	1,538.46
More Than 150 Pounds**										
Price Per Pound	\$2.47	\$3.45	\$6.25	\$6.96	\$7.10	\$8.45	\$8.82	\$10.03	\$7.67	\$10.26

*Zone 124 is metro Alaska and Hawaii, zone 125 is Puerto Rico, and zone 126 is remote Alaska and Hawaii. Zone 126 for remote Hawaii is not delivered the next business day. Delivery to this zone requires an additional day.

**For each UPS Next Day Air package with a weight of more than 150 pounds, multiply the weight by the price per pound.

Note: For additional information, refer to page [26](#).

Domestic

UPS Next Day Air Saver[®]

Guaranteed on-time delivery to commercial destinations within the 48 contiguous states and select locations in Alaska and Hawaii by 3:00 p.m. or 4:30 p.m. the next business day where UPS Next Day Air[®] delivery is committed by 10:30 a.m. or 12:00 p.m., respectively. Shipments to residential locations within the UPS Next Day Air Saver area are delivered by end of day. Not available to destinations where UPS Next Day Air service is committed by end of day. Optional Saturday pickup available. Saturday Delivery is not available.

Zones	132	133	134	135	136	137	138
Letter*	\$26.07	\$31.66	\$39.44	\$42.76	\$43.61	\$47.80	\$49.98
1 Lbs.	29.35	40.63	54.90	61.02	66.13	72.19	75.78
2	31.29	42.79	63.13	68.85	76.13	82.32	87.84
3	34.01	45.70	70.02	76.33	82.09	90.89	96.03
4	36.69	48.45	75.85	83.58	92.21	98.73	105.14
5	37.33	48.87	80.69	90.88	95.17	101.75	107.48
6	39.80	55.14	89.76	97.83	106.56	113.67	119.75
7	40.69	57.53	96.06	105.28	114.15	121.03	127.96
8	42.82	59.17	101.44	112.10	121.83	129.61	135.96
9	44.28	61.73	108.12	119.27	125.56	138.18	144.76
10	44.51	63.54	110.08	122.34	128.08	141.34	147.99
11	47.95	67.55	120.69	136.33	146.11	156.31	161.05
12	49.79	70.39	127.33	142.56	153.27	165.00	169.64
13	50.34	73.92	133.39	149.17	159.48	173.55	177.82
14	51.78	76.80	140.18	153.96	165.64	181.12	186.63
15	53.77	79.47	144.45	160.16	170.37	187.12	193.63
16	54.91	80.75	152.01	167.71	177.49	191.99	198.55
17	56.63	83.44	156.33	171.42	181.59	196.35	202.80
18	59.41	83.78	161.03	174.98	185.59	200.56	208.22
19	61.01	87.34	164.87	178.66	189.77	205.06	213.58
20	62.14	89.93	170.07	187.40	192.85	211.73	216.57
21	63.82	91.66	180.23	193.56	206.25	221.61	233.94
22	66.06	93.60	184.88	203.51	207.79	235.15	243.65
23	67.19	95.39	190.01	208.63	215.10	238.98	244.85
24	68.86	96.99	192.20	211.30	219.17	240.79	247.81
25	69.79	99.00	194.34	211.97	220.13	243.61	248.77
26	69.99	101.97	205.57	225.34	238.77	250.07	261.91
27	73.17	104.61	211.02	229.22	243.84	256.56	274.31
28	73.49	107.33	217.11	235.76	245.62	262.58	281.48
29	74.91	109.34	222.42	237.13	245.84	270.58	283.05
30	78.32	110.54	222.95	239.34	246.98	271.82	283.61
31	79.77	111.80	232.54	250.72	266.32	281.63	294.72
32	81.43	113.73	237.60	251.86	271.60	283.06	299.71
33	83.23	116.00	242.46	262.77	276.71	297.94	312.25
34	84.67	118.60	247.97	267.49	277.24	304.44	314.80
35	87.09	120.94	248.53	271.83	277.76	310.28	319.92

*The Letter rate applies only to documents, correspondence and electronic media shipments that do not exceed eight ounces sent in a UPS Express[®] Envelope.

Note: For additional information, refer to page [26](#).

Domestic

UPS Next Day Air Saver®

Zones	132	133	134	135	136	137	138
36 Lbs.	\$87.63	\$123.54	\$258.92	\$277.61	\$288.02	\$315.05	\$327.04
37	87.83	126.44	265.31	285.22	302.77	322.40	335.84
38	89.38	127.73	269.71	292.04	307.88	327.02	336.84
39	91.65	128.02	274.67	297.05	308.40	332.81	342.76
40	95.80	133.87	275.18	297.55	309.30	336.51	343.55
41	97.45	135.60	285.30	305.56	327.26	341.50	359.11
42	99.26	137.62	290.35	310.46	329.05	342.82	370.30
43	100.91	140.55	296.88	319.19	335.30	360.26	383.70
44	102.65	144.15	302.08	328.33	341.44	366.35	390.53
45	104.32	147.59	306.90	331.73	342.06	372.53	391.84
46	105.89	150.10	312.07	341.19	354.64	376.95	407.10
47	108.16	152.51	312.59	342.60	356.71	378.10	409.27
48	109.75	154.69	312.82	345.36	356.91	385.25	410.43
49	111.42	157.76	313.02	345.64	357.13	385.99	410.48
50	113.61	160.07	313.87	347.19	358.32	387.63	410.67
51	116.36	164.93	327.58	379.46	387.50	420.45	434.83
52	118.69	167.41	351.47	387.20	402.25	429.52	459.64
53	120.85	170.91	356.87	395.13	403.72	438.82	468.05
54	122.44	174.29	362.72	397.88	404.15	448.68	472.74
55	124.46	177.92	365.47	398.89	405.18	455.06	473.14
56	127.10	180.98	365.85	408.25	416.72	461.43	473.19
57	129.84	184.81	366.57	409.38	418.69	462.08	473.94
58	131.25	189.05	367.03	409.78	427.57	463.36	475.18
59	131.64	193.91	376.12	416.19	428.47	464.70	498.82
60	132.01	196.30	377.03	416.83	429.38	491.29	501.42
61	135.96	201.93	392.80	429.34	447.38	507.11	520.11
62	138.44	204.82	399.01	434.86	449.27	514.57	532.99
63	140.89	208.87	402.73	435.50	451.41	522.12	533.04
64	146.17	209.75	403.14	448.13	465.86	531.83	553.15
65	150.60	216.23	406.76	453.19	468.88	540.31	562.30
66	153.31	216.90	424.31	467.79	483.72	541.16	563.49
67	154.79	225.47	426.06	469.25	485.21	541.57	563.54
68	156.27	229.64	426.49	475.23	485.64	541.97	564.47
69	156.32	232.50	426.94	478.78	486.45	542.37	576.93
70	162.90	235.92	427.34	479.36	486.88	543.57	579.49
71	166.01	239.67	428.77	480.26	487.80	567.15	581.65
72	166.41	243.39	457.38	496.88	504.67	590.20	610.11
73	167.13	248.86	460.24	498.55	506.36	594.96	624.63
74	167.80	249.42	460.69	498.97	506.78	595.44	626.39
75	177.33	255.60	461.48	499.83	507.63	596.25	627.19

Note: For additional information, refer to page [26](#).

Domestic

UPS Next Day Air Saver[®]

Zones	132	133	134	135	136	137	138
76 Lbs.	\$178.29	\$256.47	\$464.03	\$507.36	\$512.75	\$613.74	\$629.62
77	181.19	259.89	465.99	518.29	534.41	615.73	630.85
78	182.11	269.11	483.64	531.73	548.92	620.92	631.69
79	182.92	270.29	485.41	539.99	557.39	634.22	640.88
80	183.79	278.45	486.22	541.78	559.05	636.94	643.63
81	184.60	283.17	501.07	576.33	589.86	653.55	660.40
82	196.87	287.73	503.79	579.78	592.95	655.21	662.09
83	198.11	290.11	504.62	580.64	593.81	656.07	662.95
84	198.91	290.94	505.47	581.49	594.69	667.05	676.86
85	199.72	293.16	506.31	582.34	595.51	667.10	678.38
86	204.06	300.53	507.79	590.44	596.68	672.19	679.23
87	205.07	302.77	526.57	592.92	599.43	673.25	680.30
88	205.90	307.50	528.46	593.77	600.95	674.73	683.74
89	212.68	311.99	550.85	614.77	630.26	721.21	752.43
90	215.64	312.46	571.59	618.46	640.77	751.76	766.69
91	216.51	312.94	573.68	619.28	641.59	754.82	768.10
92	223.47	322.76	574.57	620.10	642.52	755.67	769.03
93	225.78	323.74	576.64	620.92	643.33	756.50	769.95
94	226.65	332.25	577.45	621.74	644.14	757.64	770.88
95	227.52	333.09	578.26	623.60	644.99	758.47	771.80
96	228.33	333.27	579.07	630.99	649.94	759.30	772.61
97	229.13	333.68	580.05	634.05	656.65	760.13	773.65
98	230.69	338.38	599.63	638.15	669.73	762.58	775.50
99	231.50	339.08	609.10	669.98	694.13	799.84	812.36
100	232.30	339.13	610.04	681.80	697.81	836.28	872.64
101	234.64	341.75	616.16	688.60	702.23	844.65	881.37
102	236.95	345.13	622.26	695.43	709.17	853.01	890.10
103	239.27	348.51	628.35	702.25	716.13	861.37	898.82
104	241.60	351.90	634.45	709.07	723.09	869.74	907.55
105	243.92	355.28	640.55	715.88	730.04	878.10	916.28
106	246.24	358.66	646.65	722.71	737.00	886.46	925.00
107	248.57	362.04	652.75	729.52	743.95	894.82	933.73
108	250.89	365.42	658.86	736.33	750.90	903.19	942.46
109	253.21	368.81	664.96	743.16	757.84	911.55	951.18
110	255.53	372.20	671.06	749.97	764.81	919.91	959.91
111	257.86	375.58	677.15	756.79	771.76	928.28	968.64
112	260.18	378.96	683.25	763.60	778.70	936.64	977.36
113	262.50	382.34	689.35	770.43	785.67	945.00	986.09
114	264.83	385.72	695.45	777.24	792.61	953.36	994.81
115	267.15	389.11	701.56	784.05	799.57	961.73	1,003.54

Note: For additional information, refer to page [26](#).

Domestic

UPS Next Day Air Saver[®]

Zones	132	133	134	135	136	137	138
116 Lbs.	\$269.47	\$392.50	\$707.66	\$790.88	\$806.51	\$970.09	\$1,012.27
117	271.80	395.89	713.76	797.70	813.48	978.45	1,020.99
118	274.12	399.27	719.86	804.51	820.43	986.82	1,029.72
119	276.44	402.65	725.96	811.33	827.37	995.18	1,038.45
120	278.76	406.03	732.05	818.15	834.33	1,003.54	1,047.17
121	281.09	409.41	738.15	824.96	841.28	1,011.90	1,055.90
122	283.41	412.80	744.26	831.79	848.23	1,020.27	1,064.63
123	285.73	416.18	750.36	838.59	855.18	1,028.63	1,073.35
124	288.06	419.56	756.46	845.41	862.14	1,036.99	1,082.08
125	290.38	422.94	762.56	852.24	869.09	1,045.35	1,090.80
126	292.70	426.33	768.66	859.05	876.05	1,053.72	1,099.53
127	295.03	429.71	774.76	865.88	883.00	1,062.08	1,108.26
128	297.35	433.09	780.86	872.69	889.95	1,070.44	1,116.98
129	299.67	436.49	786.96	879.51	896.91	1,078.81	1,125.71
130	301.99	439.87	793.06	886.34	903.85	1,087.17	1,134.44
131	304.32	443.25	799.17	893.15	910.80	1,095.53	1,143.16
132	306.64	446.63	805.27	899.96	917.76	1,103.89	1,151.89
133	308.96	450.01	811.36	906.78	924.71	1,112.26	1,160.62
134	311.29	453.40	817.46	913.59	931.65	1,120.62	1,169.34
135	313.61	456.79	823.56	920.42	938.63	1,128.98	1,178.07
136	315.93	460.17	829.67	927.24	945.58	1,137.35	1,186.80
137	318.26	463.55	835.76	934.04	952.52	1,145.71	1,195.52
138	320.58	466.93	841.86	940.87	959.48	1,154.07	1,204.25
139	322.90	470.31	847.97	947.70	966.43	1,162.43	1,212.97
140	325.22	473.69	854.07	954.50	973.38	1,170.80	1,221.70
141	327.55	477.08	860.17	961.32	980.33	1,179.16	1,230.43
142	329.87	480.47	866.26	968.14	987.28	1,187.52	1,239.15
143	332.19	483.86	872.37	974.96	994.24	1,195.89	1,247.88
144	334.52	487.24	878.47	981.78	1,001.19	1,204.25	1,256.61
145	336.84	490.62	884.57	988.59	1,008.15	1,212.61	1,265.33
146	339.16	494.00	890.66	995.40	1,015.10	1,220.97	1,274.06
147	341.49	497.39	896.77	1,002.23	1,022.06	1,229.34	1,282.79
148	343.81	500.77	902.87	1,009.05	1,029.00	1,237.70	1,291.51
149	346.13	504.15	908.97	1,015.86	1,035.95	1,246.06	1,300.24
150	348.45	507.53	915.08	1,021.11	1,042.92	1,254.42	1,308.96
More Than 150 Pounds*							
Price Per Pound	\$2.32	\$3.38	\$6.10	\$6.81	\$6.95	\$8.36	\$8.73

*For each UPS Next Day Air Saver package with a weight of more than 150 pounds, multiply the weight by the price per pound.

Note: For additional information, refer to page [26](#).

Domestic

UPS 2nd Day Air A.M.^{®*}

Guaranteed on-time delivery by 10:30 a.m. or 12:00 p.m. on the second business day to metropolitan commercial destinations in the 48 contiguous states and limited addresses in Alaska and Hawaii where UPS Next Day Air[®] delivery is committed by 10:30 a.m. or 12:00 p.m., respectively. Not available to destinations where UPS Next Day Air service is committed by end of day. Also not available to residential destinations. Optional Saturday pickup available. Saturday Delivery is not available.

Zones	242	243	244	245	246	247	248
Letter**	\$20.57	\$21.39	\$22.34	\$25.86	\$31.77	\$35.45	\$36.19
1 Lbs.	21.71	22.61	24.54	29.43	36.16	38.60	39.43
2	22.09	23.06	24.76	31.35	40.01	44.47	46.79
3	22.45	23.81	26.22	34.54	45.96	51.50	54.64
4	23.13	24.62	28.40	40.21	52.91	59.87	61.94
5	23.81	25.45	31.55	44.47	58.90	66.35	70.31
6	24.84	26.40	34.38	48.57	66.30	73.67	77.00
7	25.90	29.84	37.30	52.75	73.19	81.82	84.43
8	26.93	32.29	39.89	57.54	81.27	90.17	93.33
9	28.37	34.78	43.11	61.77	89.73	96.59	101.96
10	29.71	35.96	46.27	65.98	93.60	105.06	109.51
11	31.04	37.00	47.08	67.30	96.88	109.65	111.87
12	33.70	41.18	51.05	75.19	110.91	123.02	127.71
13	34.99	42.48	52.00	78.62	115.95	126.34	132.19
14	36.71	44.35	56.45	83.53	123.03	135.76	138.58
15	39.28	46.66	59.20	86.76	131.72	141.41	146.84
16	40.82	48.22	61.79	89.58	137.50	148.66	153.05
17	41.44	49.65	64.47	95.64	141.07	156.61	159.43
18	44.08	52.43	66.79	98.94	149.64	163.49	167.08
19	44.50	52.71	68.45	102.99	155.14	171.03	175.71
20	44.73	54.95	71.08	105.51	157.68	173.67	178.94
21	49.12	56.81	73.75	110.91	166.35	182.97	190.08
22	49.69	58.22	78.32	114.01	171.79	185.78	196.98
23	51.68	62.92	81.15	117.26	177.98	196.20	205.08
24	53.82	63.76	83.35	121.82	181.02	203.90	212.41
25	54.32	65.09	84.11	126.02	190.46	211.04	219.01
26	55.98	66.87	88.49	130.13	196.94	217.47	224.85
27	56.90	69.83	91.55	134.74	203.62	225.65	231.23
28	58.29	70.60	92.29	137.91	208.84	231.45	237.72
29	61.26	70.81	94.23	141.22	210.49	236.37	242.18
30	62.58	74.36	95.68	145.57	216.23	240.49	245.30
31	63.55	76.81	98.24	148.82	225.36	248.94	257.52
32	63.74	81.21	101.04	149.60	231.96	253.40	259.32
33	66.30	81.87	107.34	155.68	238.16	259.69	264.90
34	68.37	81.99	108.14	158.15	245.36	267.19	278.02
35	69.75	82.96	108.30	160.47	248.09	268.90	279.72

*Visit [ups.com/holidays](https://www.ups.com/holidays) for time in transit changes effective during the holiday season.

**The Letter rate applies only to documents, correspondence and electronic media shipments that do not exceed eight ounces sent in a UPS Express[®] Envelope.

Note: For additional information, refer to page [26](#).

Domestic

UPS 2nd Day Air A.M.^{®*}

Zones	242	243	244	245	246	247	248
36 Lbs.	\$72.07	\$86.47	\$110.56	\$164.53	\$254.73	\$277.40	\$291.81
37	72.31	87.49	111.74	167.01	261.64	283.60	294.68
38	74.16	88.71	115.93	167.18	273.36	290.06	295.88
39	77.10	90.07	116.36	170.70	280.00	302.62	314.50
40	77.45	92.43	120.85	183.02	286.35	307.29	321.97
41	81.08	95.70	122.26	184.44	292.83	321.21	330.64
42	83.31	99.82	125.77	190.32	293.54	329.12	338.96
43	84.66	100.24	129.05	193.51	301.88	335.25	346.03
44	85.57	101.30	133.88	196.94	312.07	340.91	352.83
45	85.80	103.70	137.88	199.70	317.78	347.30	358.09
46	86.04	108.66	141.19	202.73	322.75	354.25	368.17
47	89.56	109.85	141.60	205.56	323.34	358.35	373.13
48	91.34	109.94	145.57	208.58	335.23	364.48	373.18
49	91.80	113.46	146.72	211.20	341.02	364.53	374.15
50	92.76	119.53	149.96	215.68	346.85	374.49	380.92
51	98.04	120.94	151.20	220.26	365.62	387.22	410.46
52	102.69	125.15	154.61	221.04	370.53	393.98	410.51
53	103.35	125.60	162.54	221.56	371.03	400.89	410.56
54	103.80	128.41	163.33	231.72	371.48	404.32	415.99
55	104.23	128.81	163.73	232.75	371.88	412.64	416.77
56	105.97	129.20	164.13	233.38	372.28	415.66	419.82
57	107.40	129.60	164.52	244.81	372.83	420.38	424.59
58	107.87	130.48	164.92	245.96	373.23	425.34	436.84
59	110.37	133.25	168.49	246.44	377.51	429.49	436.89
60	111.07	137.95	169.18	255.78	391.83	441.26	446.77
61	111.47	138.68	169.59	256.73	393.60	442.20	458.35
62	111.86	139.13	173.24	257.23	395.72	446.62	459.51
63	114.82	144.06	177.27	267.21	438.09	456.47	461.04
64	118.78	145.70	180.24	268.22	442.33	470.17	491.86
65	119.18	146.14	184.76	268.61	454.43	497.29	513.77
66	119.57	149.34	188.73	272.66	455.64	499.99	515.97
67	120.59	150.57	189.17	273.10	456.09	500.39	516.07
68	120.70	151.70	189.62	273.56	456.50	500.91	516.17
69	122.49	152.16	190.11	273.99	461.16	502.27	521.69
70	123.73	160.14	196.40	274.44	461.62	516.38	522.55
71	126.54	162.55	199.02	277.66	474.73	523.02	528.33
72	129.37	162.95	204.77	279.02	475.95	532.84	538.19
73	130.55	163.35	207.68	281.36	480.92	533.83	539.18
74	131.13	163.75	208.13	281.82	481.42	545.05	550.52
75	131.18	164.78	208.93	282.73	482.22	547.07	552.56

*Visit [ups.com/holidays](https://www.ups.com/holidays) for time in transit changes effective during the holiday season.

Note: For additional information, refer to page 26.

Domestic

UPS 2nd Day Air A.M.^{®*}

Zones	242	243	244	245	246	247	248
76 Lbs.	\$140.46	\$165.58	\$209.73	\$287.40	\$483.02	\$547.87	\$562.86
77	141.40	166.38	210.53	299.32	483.82	548.71	563.89
78	142.29	167.25	211.33	301.33	494.43	549.78	565.14
79	143.18	168.12	212.69	324.18	514.88	565.42	589.94
80	143.98	170.69	213.33	326.47	516.93	598.60	604.61
81	144.78	171.57	213.73	327.27	519.01	601.52	618.90
82	145.85	183.85	227.07	333.93	554.82	614.18	620.33
83	149.36	186.18	228.41	334.84	562.70	619.12	630.01
84	151.23	186.98	229.21	335.75	570.09	619.92	630.98
85	153.56	187.78	230.59	342.71	571.58	621.01	631.78
86	154.37	188.58	231.46	343.93	571.92	621.82	632.58
87	154.88	189.45	232.54	364.09	572.24	622.63	633.38
88	156.34	190.41	233.34	366.12	572.89	626.23	634.18
89	157.14	191.21	234.14	367.02	576.64	628.32	635.62
90	157.45	195.73	234.94	367.92	577.55	638.71	664.42
91	158.04	196.53	235.81	368.81	578.46	655.70	667.32
92	159.92	197.33	249.18	369.25	579.36	671.10	680.30
93	160.82	198.13	250.52	369.68	580.27	672.45	681.61
94	162.69	198.93	257.70	370.13	581.18	673.39	682.55
95	163.50	200.17	258.50	370.57	591.96	676.69	683.47
96	164.31	200.97	259.30	373.36	627.83	680.87	687.70
97	165.12	201.95	260.10	373.41	631.40	682.84	689.69
98	165.93	202.75	260.90	373.46	632.58	698.63	713.50
99	169.98	203.55	261.96	375.38	657.07	720.07	729.04
100	181.00	216.84	283.00	419.00	681.31	731.00	764.67
101	182.81	219.01	285.83	423.19	688.13	738.31	772.34
102	184.62	221.18	288.66	427.38	694.94	745.62	779.97
103	186.43	223.35	291.49	431.57	701.74	752.93	787.61
104	188.24	225.51	294.32	435.76	708.57	760.24	795.26
105	190.05	227.67	297.15	439.95	715.37	767.55	802.91
106	191.86	229.85	299.98	444.14	722.19	774.86	810.56
107	193.67	232.02	302.81	448.33	729.02	782.17	818.20
108	195.48	234.18	305.64	452.52	735.81	789.48	825.85
109	197.29	236.35	308.47	456.71	742.63	796.79	833.49
110	199.10	238.53	311.30	460.90	749.44	804.10	841.14
111	200.91	240.69	314.13	465.09	756.27	811.41	848.79
112	202.72	242.86	316.96	469.28	763.06	818.72	856.43
113	204.53	245.04	319.79	473.47	769.88	826.03	864.07
114	206.34	247.20	322.62	477.66	776.68	833.34	871.72
115	208.15	249.37	325.45	481.85	783.51	840.65	879.37

*Visit [ups.com/holidays](https://www.ups.com/holidays) for time in transit changes effective during the holiday season.

Note: For additional information, refer to page 26.

Domestic

UPS 2nd Day Air A.M.^{®*}

Zones	242	243	244	245	246	247	248
116 Lbs.	\$209.96	\$251.54	\$328.28	\$486.04	\$790.32	\$847.96	\$887.03
117	211.77	253.71	331.11	490.23	797.12	855.27	894.68
118	213.58	255.87	333.94	494.42	803.95	862.58	902.31
119	215.39	258.03	336.77	498.61	810.76	869.89	909.96
120	217.20	260.20	339.60	502.80	817.58	877.20	917.61
121	219.01	262.38	342.43	506.99	824.38	884.51	925.26
122	220.82	264.54	345.26	511.18	831.21	891.82	932.91
123	222.63	266.71	348.09	515.37	838.00	899.13	940.55
124	224.44	268.89	350.92	519.56	844.82	906.44	948.19
125	226.25	271.05	353.75	523.75	851.64	913.75	955.84
126	228.06	273.22	356.58	527.94	858.45	921.06	963.48
127	229.87	275.39	359.41	532.13	865.26	928.37	971.12
128	231.68	277.56	362.24	536.32	872.07	935.68	978.77
129	233.49	279.73	365.07	540.51	878.90	942.99	986.42
130	235.30	281.90	367.90	544.70	885.70	950.30	994.07
131	237.11	284.07	370.73	548.89	892.51	957.61	1,001.72
132	238.92	286.23	373.56	553.08	899.32	964.92	1,009.38
133	240.73	288.39	376.39	557.27	906.14	972.23	1,017.03
134	242.54	290.56	379.22	561.46	912.95	979.54	1,024.66
135	244.35	292.74	382.05	565.65	919.76	986.85	1,032.30
136	246.16	294.90	384.88	569.84	926.58	994.16	1,039.95
137	247.97	297.07	387.71	574.03	933.40	1,001.47	1,047.60
138	249.78	299.24	390.54	578.22	940.21	1,008.78	1,055.24
139	251.59	301.41	393.37	582.41	947.01	1,016.09	1,062.89
140	253.40	303.58	396.20	586.60	953.83	1,023.40	1,070.54
141	255.21	305.75	399.03	590.79	960.64	1,030.71	1,078.19
142	257.02	307.92	401.86	594.98	967.46	1,038.02	1,085.84
143	258.83	310.09	404.69	599.17	974.27	1,045.33	1,093.49
144	260.64	312.26	407.52	603.36	981.08	1,052.64	1,101.11
145	262.45	314.42	410.35	607.55	987.89	1,059.98	1,108.76
146	264.26	316.59	413.18	611.74	994.72	1,067.26	1,116.41
147	266.07	318.75	416.01	615.93	1,001.53	1,074.57	1,124.07
148	267.88	320.92	418.84	620.12	1,008.34	1,081.88	1,131.72
149	269.69	323.10	421.67	624.31	1,015.14	1,089.19	1,139.36
150	271.50	325.26	424.50	628.50	1,021.96	1,096.50	1,147.01
More Than 150 Pounds**							
Price Per Pound	\$1.81	\$2.17	\$2.83	\$4.19	\$6.81	\$7.31	\$7.65

*Visit [ups.com/holidays](https://www.ups.com/holidays) for time in transit changes effective during the holiday season.

**For each UPS 2nd Day Air A.M. package with a weight of more than 150 pounds, multiply the weight by the price per pound.

Note: For additional information, refer to page [26](#).

Domestic

UPS 2nd Day Air^{®*}

Guaranteed delivery to all 50 states and Puerto Rico with some limitations in Alaska and Hawaii by the end of the second business day. Optional Saturday Delivery and pickup available.

Zones	202	203	204	205	206	207	208	224**	225**	226**
Letter***	\$20.12	\$20.98	\$21.88	\$25.16	\$30.63	\$32.67	\$33.34	\$48.27	\$42.67	\$57.96
1 Lbs.	20.24	21.10	22.00	25.41	30.94	33.00	33.67	48.76	43.72	59.29
2	20.86	22.02	22.86	27.38	34.82	38.63	40.63	54.43	48.96	72.50
3	21.20	22.69	24.19	30.21	40.02	44.77	46.61	62.11	55.77	75.75
4	21.84	23.48	26.19	35.20	46.15	51.01	52.95	66.17	59.45	79.16
5	22.50	24.24	28.48	39.03	51.54	56.72	60.11	71.78	64.55	82.24
6	23.48	25.23	31.03	42.62	57.18	63.02	65.82	80.71	68.68	87.05
7	24.47	27.54	33.65	46.57	64.32	69.69	72.37	82.12	74.02	91.27
8	25.44	30.03	35.99	50.81	71.03	76.77	79.65	91.50	77.86	96.10
9	26.74	31.36	38.89	54.54	77.13	84.17	87.32	93.01	83.26	101.68
10	26.96	33.44	41.87	58.27	82.65	91.57	94.55	106.22	90.40	108.49
11	29.34	35.26	43.80	62.30	89.03	98.30	102.36	108.20	95.71	112.86
12	30.89	37.33	46.22	65.81	95.93	105.43	108.33	110.50	99.21	113.38
13	33.06	39.26	48.01	69.76	102.18	110.56	115.83	120.82	102.81	123.08
14	34.71	41.30	51.12	73.78	108.42	116.16	120.98	125.55	106.82	127.81
15	36.02	42.25	53.61	76.62	114.17	121.30	126.47	131.34	111.67	133.59
16	36.87	43.64	55.83	79.12	118.96	127.52	131.83	136.73	116.32	138.99
17	38.00	44.94	58.10	82.91	124.32	134.33	137.96	143.26	121.89	145.52
18	39.28	46.43	60.37	85.78	129.46	140.26	144.62	147.52	129.14	149.46
19	40.83	47.70	62.00	89.29	134.12	146.71	150.88	156.74	133.30	158.99
20	42.24	49.76	64.40	93.45	138.90	151.75	156.51	162.29	138.17	164.54
21	44.21	51.69	66.82	96.60	139.45	156.96	161.87	165.11	144.49	165.25
22	45.57	54.18	68.66	99.32	148.52	162.95	168.15	171.50	150.00	176.23
23	46.69	55.38	71.13	102.15	153.89	168.31	173.91	177.39	155.50	177.54
24	47.76	57.57	73.40	106.12	159.49	172.29	175.74	179.27	161.17	183.63
25	49.31	59.22	74.79	109.76	164.69	181.05	188.62	196.05	166.79	198.31
26	50.78	60.85	77.56	113.36	170.28	187.27	193.82	201.16	171.08	203.94
27	52.40	62.63	79.54	117.36	176.05	193.57	199.90	207.67	176.71	209.96
28	54.09	64.68	81.37	120.16	180.56	198.55	204.74	214.34	182.46	217.71
29	55.48	65.88	83.78	123.01	185.40	203.53	210.83	219.74	186.96	224.07
30	55.70	67.67	86.67	127.03	190.49	209.02	216.18	226.72	192.85	230.03
31	55.92	69.94	89.01	129.88	194.84	213.56	221.97	232.28	197.62	237.24
32	56.16	71.49	91.55	133.04	200.56	219.49	227.32	239.59	203.93	243.37
33	60.81	73.36	94.10	135.87	205.93	224.54	233.10	240.97	209.32	250.15
34	62.70	74.71	96.07	140.63	212.16	230.12	238.84	244.96	214.94	251.50
35	63.98	76.98	98.14	143.40	218.54	235.89	242.28	245.45	220.67	251.78

*Visit [ups.com/holidays](https://www.ups.com/holidays) for time in transit changes effective during the holiday season.

**Zone 224 is metro Alaska and Hawaii, zone 225 is Puerto Rico and zone 226 is remote Alaska and Hawaii.

***The Letter rate applies only to documents, correspondence and electronic media shipments that do not exceed eight ounces sent in a UPS Express[®] Envelope.

Note: For additional information, refer to page [26](#).

Domestic

UPS 2nd Day Air^{®*}

Zones	202	203	204	205	206	207	208	224**	225**	226**
36 Lbs.	\$64.97	\$78.67	\$100.17	\$146.35	\$224.41	\$243.34	\$248.54	\$251.72	\$225.92	\$257.22
37	66.18	79.80	102.59	150.14	230.50	249.81	257.60	272.25	231.64	274.07
38	67.29	81.02	105.19	153.17	236.38	256.30	264.63	275.78	237.05	276.04
39	69.42	83.15	106.96	156.22	242.09	263.13	271.51	285.22	242.61	290.93
40	69.64	85.35	109.53	159.73	247.59	269.57	277.51	290.91	247.53	298.07
41	73.02	87.42	110.79	162.67	253.18	276.61	285.00	297.28	252.88	300.82
42	74.22	89.55	113.05	166.11	258.61	283.42	292.17	304.10	258.61	307.55
43	75.76	91.40	114.77	168.87	264.70	288.69	298.26	309.72	263.60	315.29
44	77.04	92.53	117.37	171.87	269.85	293.60	304.14	315.88	268.71	320.75
45	77.39	94.80	119.08	174.28	274.77	299.09	308.66	320.47	272.70	326.98
46	79.78	95.86	121.47	176.04	279.41	303.91	316.15	322.89	279.31	327.73
47	80.02	96.08	123.49	176.57	279.92	304.40	319.16	323.18	284.62	327.96
48	81.70	99.94	125.71	177.08	289.93	313.86	321.74	328.05	289.49	328.18
49	81.92	100.34	125.94	177.19	294.86	314.84	322.01	328.46	294.90	328.74
50	82.14	100.56	129.88	177.31	299.91	316.15	322.48	328.93	295.01	329.21
51	82.89	101.00	132.75	183.03	314.34	325.02	331.53	338.14	304.96	340.39
52	88.75	106.42	137.02	193.09	319.12	344.74	356.31	360.15	305.60	362.42
53	90.52	108.57	138.96	194.51	319.60	350.77	358.75	362.36	310.16	364.62
54	91.81	109.88	141.12	194.97	320.30	352.20	359.20	362.81	313.99	368.23
55	93.49	110.32	142.35	195.41	334.01	352.64	359.65	363.26	323.47	371.37
56	94.25	110.76	142.80	195.97	335.40	353.07	360.11	363.72	324.43	371.43
57	94.69	115.54	147.18	207.05	346.32	360.20	367.37	371.06	330.31	378.31
58	95.13	116.02	147.62	208.16	352.89	360.93	368.11	371.79	335.83	378.44
59	95.57	116.71	152.73	208.62	358.24	365.41	372.73	380.15	340.37	382.41
60	96.01	117.15	153.59	214.44	360.15	373.52	381.00	388.57	344.55	390.84
61	96.44	117.59	154.04	215.02	365.26	376.59	384.13	391.19	350.71	393.45
62	96.88	118.03	154.48	215.48	366.06	377.28	384.84	392.10	362.11	394.35
63	97.32	118.47	154.93	219.93	381.89	390.73	398.55	406.45	368.26	408.72
64	103.43	120.79	155.37	220.38	384.39	392.09	399.94	407.89	368.48	410.16
65	107.31	123.98	155.81	226.23	384.81	392.51	400.37	408.34	374.90	410.60
66	107.75	124.42	157.55	226.82	385.47	393.19	401.06	409.02	381.31	411.30
67	108.19	126.91	157.94	227.28	385.90	393.62	401.50	409.49	382.65	412.71
68	108.63	127.94	162.35	227.72	386.33	394.06	401.94	409.98	392.75	412.76
69	109.07	130.77	162.80	228.71	387.64	395.40	403.31	411.39	398.38	412.81
70	109.51	142.53	168.49	248.11	404.66	421.00	429.43	437.99	403.20	440.24
71	116.15	144.45	168.60	250.06	405.97	425.20	433.72	442.33	404.33	444.60
72	116.82	144.89	168.70	250.50	417.00	425.64	434.15	442.79	405.28	445.05
73	117.22	145.33	169.48	254.62	417.71	426.07	434.60	443.25	409.52	445.50
74	117.62	145.77	169.92	255.07	418.30	426.67	435.20	443.91	431.10	445.55
75	118.43	146.66	170.80	260.21	429.87	438.48	447.25	456.16	431.18	458.42

*Visit [ups.com/holidays](https://www.ups.com/holidays) for time in transit changes effective during the holiday season.

**Zone 224 is metro Alaska and Hawaii, zone 225 is Puerto Rico and zone 226 is remote Alaska and Hawaii.

Note: For additional information, refer to page [26](#).

Domestic

UPS 2nd Day Air^{®*}

Zones	202	203	204	205	206	207	208	224**	225**	226**
76 Lbs.	\$120.68	\$147.54	\$171.67	\$262.08	\$436.60	\$445.33	\$454.24	\$463.28	\$431.35	\$465.55
77	121.56	148.42	175.17	262.97	445.59	459.05	468.23	477.30	432.74	479.54
78	122.44	149.30	178.55	275.59	446.82	462.64	501.56	509.78	434.15	512.05
79	123.33	150.18	179.43	276.86	449.21	495.00	504.90	514.96	450.56	517.22
80	124.21	151.06	180.31	277.75	473.65	498.42	508.40	518.46	450.66	523.06
81	128.51	151.86	181.19	278.65	476.11	499.28	509.27	519.39	451.30	524.80
82	129.78	152.65	183.89	279.55	477.01	500.14	510.15	520.29	471.15	524.99
83	131.52	155.04	184.77	280.44	484.52	501.00	511.02	521.19	474.73	525.89
84	132.40	155.92	187.53	281.34	489.72	509.45	519.65	529.99	474.91	532.26
85	138.51	159.47	195.17	292.85	490.62	510.31	520.54	530.90	478.15	533.49
86	139.40	164.39	196.13	294.00	491.52	511.12	521.35	532.03	478.53	534.27
87	140.28	166.39	197.01	294.89	492.42	514.56	524.86	535.32	484.12	537.58
88	141.16	167.78	197.89	295.79	493.31	518.55	528.92	539.40	492.98	541.66
89	142.03	167.95	198.77	296.69	499.40	519.41	529.80	540.30	493.46	542.57
90	142.91	168.00	199.65	297.59	504.59	520.28	530.69	541.21	500.84	543.48
91	143.79	168.79	200.52	298.48	505.48	521.14	531.57	542.11	501.26	544.38
92	144.67	169.67	201.40	299.38	506.38	522.00	532.45	543.10	505.66	544.43
93	145.55	170.55	203.76	300.27	507.28	522.85	533.32	543.99	505.82	544.48
94	146.44	171.43	203.90	301.17	508.17	523.73	534.21	544.90	522.89	545.34
95	147.32	172.31	204.64	302.07	509.73	528.38	538.95	549.74	523.00	550.19
96	149.79	173.11	209.88	307.41	518.86	529.24	539.83	550.64	525.46	551.09
97	150.60	174.08	214.95	308.31	529.76	540.37	551.18	562.21	525.89	562.67
98	151.40	174.96	215.83	309.21	542.17	553.02	564.03	569.67	526.20	582.80
99	152.20	175.84	220.92	327.21	546.03	572.17	596.03	607.91	526.58	612.81
100	153.00	191.00	245.00	346.00	555.59	629.09	655.61	668.83	566.04	676.30
101	154.53	192.91	247.45	349.46	563.36	640.34	660.54	674.68	571.69	683.04
102	156.06	194.82	249.90	352.92	567.33	646.68	667.08	681.36	577.35	689.77
103	157.59	196.73	252.35	356.38	572.89	653.02	673.62	688.04	583.02	696.52
104	159.12	198.64	254.80	359.84	577.20	659.36	680.16	694.72	588.68	703.25
105	160.65	200.55	257.25	363.30	584.03	665.70	686.70	701.40	594.33	710.00
106	162.18	202.46	259.70	366.76	589.59	672.04	693.24	708.08	599.98	716.74
107	163.71	204.37	262.15	370.22	593.85	678.38	699.78	714.76	605.66	723.48
108	165.24	206.28	264.60	373.68	599.40	684.72	706.32	721.44	611.32	730.22
109	166.77	208.19	267.05	377.14	604.95	691.06	712.86	728.12	616.98	736.96
110	168.30	210.10	269.50	380.60	611.82	697.40	719.40	734.80	622.64	743.70
111	169.83	212.01	271.95	384.06	616.05	703.74	725.94	741.48	628.30	750.44
112	171.36	213.92	274.40	387.52	622.95	710.08	732.48	748.16	633.97	757.18
113	172.89	215.83	276.85	390.98	627.15	716.42	739.02	754.84	639.61	763.92
114	174.42	217.74	279.30	394.44	632.70	722.76	745.56	761.52	645.27	770.66
115	175.95	219.65	281.75	397.90	638.25	729.10	752.10	768.20	650.94	777.40

*Visit [ups.com/holidays](https://www.ups.com/holidays) for time in transit changes effective during the holiday season.

**Zone 224 is metro Alaska and Hawaii, zone 225 is Puerto Rico and zone 226 is remote Alaska and Hawaii.

Note: For additional information, refer to page [26](#).

Domestic

UPS 2nd Day Air^{®*}

Zones	202	203	204	205	206	207	208	224**	225**	226**
116 Lbs.	\$177.48	\$221.56	\$284.20	\$401.36	\$645.20	\$735.44	\$758.64	\$774.88	\$656.62	\$784.14
117	179.01	223.47	286.65	404.82	649.35	741.78	765.18	781.56	662.25	790.88
118	180.54	225.38	289.10	408.28	654.90	748.12	771.72	788.24	667.92	797.62
119	182.07	227.29	291.55	411.74	660.45	754.46	778.26	794.92	673.59	804.36
120	183.60	229.20	294.00	415.20	666.00	760.80	784.80	801.60	679.22	811.10
121	185.13	231.11	296.45	418.66	671.55	767.14	791.34	808.28	684.90	817.84
122	186.66	233.02	298.90	422.12	677.10	773.48	797.88	814.96	690.57	824.58
123	188.19	234.93	301.35	425.58	682.65	779.82	804.42	821.64	696.23	831.32
124	189.72	236.84	303.80	429.04	689.70	786.16	810.96	828.32	701.87	838.07
125	191.25	238.75	306.25	432.50	693.75	792.50	817.50	835.00	707.55	844.80
126	192.78	240.66	308.70	435.96	700.83	798.84	824.04	841.68	713.21	851.55
127	194.31	242.57	311.15	439.42	704.85	805.18	830.58	848.36	718.87	858.28
128	195.84	244.48	313.60	442.88	710.40	811.52	837.12	855.04	724.52	865.02
129	197.37	246.39	316.05	446.34	715.95	817.86	843.66	861.72	730.17	871.76
130	198.90	248.30	318.50	449.80	721.50	824.20	850.20	868.40	735.85	878.50
131	200.43	250.21	320.95	453.26	730.69	830.54	856.74	875.08	741.51	885.24
132	201.96	252.12	323.40	456.72	734.19	836.88	863.28	881.76	747.16	891.98
133	203.49	254.03	325.85	460.18	738.15	843.22	869.82	888.44	752.83	898.73
134	205.02	255.94	328.30	463.64	743.70	849.56	876.36	895.12	758.49	905.46
135	206.55	257.85	330.75	467.10	749.25	855.90	882.90	901.80	764.16	912.21
136	208.08	259.76	333.20	470.56	754.80	862.24	889.44	908.48	769.82	918.94
137	209.61	261.67	335.65	474.02	760.35	868.58	895.98	915.16	775.47	925.69
138	211.14	263.58	338.10	477.48	767.55	874.92	902.52	921.84	781.12	932.42
139	212.67	265.49	340.55	480.94	771.45	881.26	909.06	928.52	786.78	939.17
140	214.20	267.40	343.00	484.40	777.00	887.60	915.60	935.20	792.45	945.90
141	215.73	269.31	345.45	487.86	782.55	893.94	922.14	941.88	798.10	952.64
142	217.26	271.22	347.90	491.32	788.10	900.28	928.68	948.56	803.77	959.39
143	218.79	273.13	350.35	494.78	793.65	906.62	935.22	955.24	809.43	966.12
144	220.32	275.04	352.80	498.24	799.20	912.96	941.76	961.92	815.10	972.87
145	221.85	276.95	355.25	501.70	804.75	919.30	948.30	968.60	820.75	979.60
146	223.38	278.86	357.70	505.16	810.30	925.64	954.84	975.28	826.41	986.35
147	224.91	280.77	360.15	508.62	815.85	931.98	961.38	981.96	832.07	993.08
148	226.44	282.68	362.60	512.08	823.17	938.32	967.92	988.64	837.73	999.83
149	227.97	284.59	365.05	515.54	828.74	944.66	974.46	995.32	843.40	1,006.56
150	229.50	286.50	367.50	519.00	832.50	951.00	981.00	1,002.00	849.05	1,013.31
More Than 150 Pounds***										
Price Per Pound	\$1.53	\$1.91	\$2.45	\$3.46	\$5.55	\$6.34	\$6.54	\$6.68	\$5.66	\$6.76

*Visit [ups.com/holidays](https://www.ups.com/holidays) for time in transit changes effective during the holiday season.

**Zone 224 is metro Alaska and Hawaii, zone 225 is Puerto Rico and zone 226 is remote Alaska and Hawaii.

***For each UPS 2nd Day Air package with a weight of more than 150 pounds, multiply the weight by the price per pound.

Note: For additional information, refer to page [26](#).

Domestic

UPS 3 Day Select^{®*}

Guaranteed delivery by the end of the third business day to the 48 contiguous states. Saturday Delivery and pickup available in select areas.

Zones	302	303	304	305	306	307	308
1 Lbs.	\$12.35	\$14.30	\$15.32	\$18.38	\$22.75	\$25.01	\$27.11
2	12.49	15.16	16.65	20.30	25.16	28.03	31.86
3	13.97	15.93	18.20	22.59	29.31	31.35	36.34
4	15.35	17.60	18.98	25.31	30.99	35.52	40.24
5	16.30	18.88	20.73	27.66	34.57	39.25	44.42
6	17.20	20.36	22.82	30.21	39.69	43.57	48.10
7	17.84	22.02	24.75	32.18	42.98	49.21	52.93
8	18.72	23.76	26.74	34.48	46.18	52.85	57.63
9	19.82	24.83	28.41	35.14	47.74	56.23	62.01
10	20.72	25.60	28.99	37.31	50.20	60.52	66.47
11	21.95	26.29	31.60	39.07	55.40	63.75	70.47
12	23.08	29.01	32.92	43.05	58.99	66.88	74.74
13	24.39	30.32	33.49	43.42	59.92	67.59	79.43
14	24.98	32.17	35.79	45.34	62.85	70.99	83.50
15	25.97	32.33	37.15	46.27	66.29	77.80	88.26
16	26.61	33.44	38.53	49.62	69.11	81.81	91.91
17	26.66	33.55	40.05	50.16	71.63	81.86	96.17
18	27.71	34.10	41.49	52.39	74.37	89.04	99.41
19	28.36	35.14	42.89	54.30	76.75	91.07	102.91
20	29.10	35.65	43.49	56.44	79.49	91.31	106.60
21	30.37	38.71	45.10	58.51	81.17	97.54	110.29
22	31.28	39.19	46.22	60.11	84.87	97.99	114.35
23	32.10	40.19	49.26	61.61	87.34	106.05	118.15
24	32.26	41.27	50.43	63.82	90.34	106.85	121.87
25	33.46	41.97	52.24	66.04	92.73	113.47	125.91
26	35.70	44.31	53.88	68.01	95.52	117.37	129.68
27	36.80	45.32	55.83	71.87	99.30	121.49	134.12
28	37.96	45.78	57.20	72.02	102.59	125.15	138.01
29	38.01	45.95	58.79	73.85	105.52	128.92	142.86
30	38.63	46.65	59.15	76.18	109.03	129.00	146.46
31	40.63	50.68	61.97	79.73	114.45	136.22	150.51
32	40.68	50.73	62.28	79.93	115.08	136.27	151.00
33	41.41	51.05	65.01	82.32	118.57	136.32	151.05
34	42.17	52.09	65.20	84.02	121.44	140.13	162.07
35	42.94	54.29	66.98	86.11	124.09	141.77	166.65

*Visit [ups.com/holidays](https://www.ups.com/holidays) for time in transit changes effective during the holiday season.

Notes:

- For additional information, refer to page 26.
- Shipments of Hazardous Materials using UPS 3 Day Select service must be prepared in accordance with the appropriate Air Dangerous Goods requirements. Hazardous Materials contract service is available with a Scheduled Pickup.

Domestic

UPS 3 Day Select^{®*}

Zones	302	303	304	305	306	307	308
36 Lbs.	\$44.57	\$55.67	\$69.57	\$88.13	\$127.60	\$146.69	\$170.49
37	45.20	56.05	69.88	90.39	130.19	149.64	170.97
38	45.56	56.55	71.77	92.61	132.93	151.81	171.51
39	46.84	57.01	73.19	94.41	135.98	159.82	181.08
40	47.22	57.10	73.91	95.20	139.02	160.32	184.23
41	49.74	61.54	75.81	98.44	141.42	160.84	188.15
42	50.53	63.25	78.59	101.18	144.49	164.14	192.14
43	51.57	64.83	80.09	102.99	147.41	167.79	196.73
44	52.02	65.59	82.05	105.20	150.14	171.32	196.78
45	52.69	66.33	83.57	107.28	152.70	174.44	197.69
46	53.29	67.27	87.07	111.13	157.34	181.48	209.37
47	53.47	67.39	87.55	111.57	159.36	181.64	210.61
48	53.56	68.63	87.90	115.42	163.73	193.33	217.59
49	53.94	69.62	89.32	115.82	165.05	196.62	219.05
50	54.11	69.88	89.71	115.92	165.89	198.39	219.41
51	58.75	70.11	92.43	119.82	173.62	198.92	229.90
52	59.78	74.85	92.97	121.84	176.38	198.97	232.26
53	60.50	76.89	94.54	123.30	179.35	203.84	238.04
54	61.27	77.56	96.51	125.59	182.03	207.84	242.32
55	61.68	79.05	97.89	127.84	184.93	211.75	242.37
56	62.55	79.33	99.34	129.80	185.05	215.55	242.78
57	62.82	80.01	101.06	131.74	187.54	221.85	243.79
58	63.24	80.71	102.30	133.83	191.57	223.73	247.82
59	63.51	81.49	103.84	135.66	193.76	227.45	252.28
60	65.62	84.35	104.46	135.84	197.48	228.76	256.85
61	65.67	85.64	106.86	140.58	201.43	235.02	261.16
62	65.72	87.48	108.25	142.53	205.07	239.08	265.16
63	66.99	88.51	109.64	144.55	207.99	242.93	269.54
64	67.98	90.40	110.82	146.93	212.16	247.55	273.85
65	68.35	91.57	111.08	147.52	215.52	250.44	280.36
66	70.51	93.27	113.74	150.65	217.89	254.56	286.23
67	70.58	93.32	115.31	152.93	221.12	258.49	286.92
68	70.67	93.89	118.29	154.87	224.29	262.15	299.18
69	71.00	94.97	119.38	156.57	226.30	263.31	304.59
70	71.76	95.29	119.50	157.94	226.50	266.14	304.64
71	73.14	97.58	122.12	160.34	235.76	272.86	308.28
72	75.36	98.94	123.62	162.46	235.90	276.66	309.41
73	77.70	100.54	125.74	164.49	238.73	279.46	310.47
74	78.36	101.55	127.42	167.01	242.67	281.11	314.03
75	78.74	101.68	128.95	169.10	244.89	281.23	315.04

*Visit [ups.com/holidays](https://www.ups.com/holidays) for time in transit changes effective during the holiday season.

Notes:

- For additional information, refer to page 26.
- Shipments of Hazardous Materials using UPS 3 Day Select service must be prepared in accordance with the appropriate Air Dangerous Goods requirements. Hazardous Materials contract service is available with a Scheduled Pickup.

Domestic

UPS 3 Day Select^{®*}

Zones	302	303	304	305	306	307	308
76 Lbs.	\$79.24	\$101.96	\$129.52	\$171.67	\$249.09	\$291.89	\$337.46
77	82.51	102.63	131.35	173.64	252.20	295.60	337.51
78	82.56	102.87	132.67	174.94	252.32	300.58	337.56
79	83.45	104.26	132.86	175.91	253.18	301.81	337.61
80	83.50	105.58	134.31	176.04	253.30	302.87	337.66
81	83.90	107.24	135.06	177.79	253.64	303.59	339.59
82	84.57	109.19	137.20	180.79	269.15	312.87	343.45
83	85.83	110.39	137.90	182.86	269.42	313.78	347.57
84	86.73	116.20	139.85	185.21	269.75	314.49	350.90
85	87.12	116.25	142.95	189.28	278.42	322.86	356.32
86	91.07	117.70	146.01	191.05	282.53	326.05	360.84
87	92.14	122.88	147.93	192.51	283.80	333.33	364.84
88	92.21	124.54	148.71	195.13	284.07	333.46	368.37
89	92.26	126.33	150.17	197.14	288.13	337.69	371.88
90	92.33	128.09	155.18	199.80	292.13	339.07	375.67
91	99.11	128.97	156.17	201.56	292.24	340.77	381.86
92	99.34	129.02	157.53	204.23	293.77	341.94	386.32
93	99.53	130.40	159.67	205.66	293.96	351.29	390.57
94	99.69	131.57	161.41	210.44	300.45	353.24	395.40
95	99.81	132.18	162.49	214.42	303.04	357.83	419.02
96	100.01	132.87	162.54	218.40	305.43	358.02	421.30
97	100.45	133.95	163.89	221.12	309.06	365.15	428.10
98	101.00	134.06	167.25	222.01	309.26	370.49	431.45
99	107.55	135.29	169.40	229.83	324.14	381.57	436.33
100	107.60	138.64	175.13	235.72	338.26	401.54	449.15
101	108.08	140.03	177.96	238.62	342.58	405.61	454.23
102	109.49	141.40	180.92	240.45	344.98	409.61	458.65
103	110.90	142.18	182.64	243.37	348.51	413.47	463.21
104	111.63	142.84	184.34	245.05	351.78	417.55	467.56
105	113.04	143.51	186.06	248.26	355.10	421.56	472.26
106	113.81	144.04	188.03	249.87	358.49	426.79	476.67
107	114.89	145.06	189.27	252.10	361.95	429.70	481.11
108	115.91	146.95	191.47	254.66	365.42	433.58	485.65
109	117.28	148.54	193.80	257.62	369.71	437.66	490.22
110	117.85	149.51	195.09	260.00	373.05	441.65	494.64
111	118.94	150.89	196.67	261.63	375.46	445.59	499.12
112	120.02	152.27	198.64	263.93	378.85	449.67	503.55
113	120.46	153.53	200.36	266.24	382.12	453.59	508.10
114	122.68	154.90	202.79	269.50	385.57	457.68	512.73
115	123.78	156.30	203.85	271.80	390.13	461.70	517.01

*Visit [ups.com/holidays](https://www.ups.com/holidays) for time in transit changes effective during the holiday season.

Notes:

- For additional information, refer to page 26.
- Shipments of Hazardous Materials using UPS 3 Day Select service must be prepared in accordance with the appropriate Air Dangerous Goods requirements. Hazardous Materials contract service is available with a Scheduled Pickup.

Domestic UPS 3 Day Select^{®*}

Zones	302	303	304	305	306	307	308
116 Lbs.	\$124.81	\$158.15	\$205.65	\$274.20	\$392.35	\$465.69	\$521.69
117	125.91	158.93	207.42	275.78	395.75	469.76	526.18
118	126.63	160.26	209.05	278.94	399.01	473.63	530.47
119	126.85	161.77	209.48	279.36	403.68	477.79	535.09
120	127.42	163.15	212.80	282.94	405.92	481.78	539.50
121	129.29	163.88	213.99	285.17	409.25	485.79	544.07
122	129.39	165.79	214.68	286.26	413.82	489.87	548.56
123	129.80	166.70	217.46	289.92	415.97	493.86	553.06
124	133.06	168.08	219.17	292.21	419.44	497.74	557.53
125	133.17	169.32	221.02	294.52	422.70	501.88	561.95
126	133.76	170.70	222.72	297.09	426.15	505.88	566.52
127	133.90	172.08	222.98	297.76	428.40	508.51	571.07
128	134.60	173.41	224.23	301.10	432.88	513.98	575.49
129	135.51	174.85	226.92	302.05	436.41	517.84	580.04
130	136.34	176.60	227.68	306.35	439.60	521.90	584.53
131	137.41	177.42	227.79	306.77	443.13	525.92	589.04
132	138.85	178.92	231.25	310.36	446.52	530.06	591.88
133	139.66	180.31	231.86	312.64	449.78	534.05	597.86
134	140.89	182.00	233.09	314.63	453.30	537.93	602.43
135	141.71	182.86	233.67	316.10	456.49	542.00	605.39
136	142.74	183.49	235.97	318.32	460.02	546.01	609.65
137	143.69	185.70	237.00	318.44	463.42	550.08	615.96
138	144.79	186.88	238.77	320.15	466.68	554.15	620.58
139	145.88	188.32	240.68	322.44	470.27	557.96	624.93
140	146.96	189.71	242.32	324.81	473.45	562.03	627.69
141	147.85	191.57	243.95	327.03	476.98	566.03	633.84
142	148.95	191.69	245.77	328.34	480.18	570.12	638.46
143	150.16	192.99	247.42	331.76	483.57	574.12	642.95
144	151.25	194.37	249.06	333.98	487.11	578.04	647.45
145	152.28	194.53	251.02	336.22	490.35	582.13	651.87
146	153.23	194.71	252.73	338.65	492.49	586.15	656.55
147	154.32	199.75	255.09	340.94	495.66	590.21	660.91
148	155.41	199.86	256.08	343.25	500.55	595.90	667.36
149	156.44	199.97	257.84	344.76	502.55	598.00	669.87
150	157.45	200.72	259.55	346.97	507.26	602.23	674.37
More Than 150 Pounds**							
Price Per Pound	\$1.05	\$1.34	\$1.73	\$2.31	\$3.38	\$4.01	\$4.50

*Visit [ups.com/holidays](https://www.ups.com/holidays) for time in transit changes effective during the holiday season.

**For each UPS 3 Day Select package with a weight of more than 150 pounds, multiply the weight by the price per pound.

Notes:

- For additional information, refer to page 26.
- Shipments of Hazardous Materials using UPS 3 Day Select service must be prepared in accordance with the appropriate Air Dangerous Goods requirements. Hazardous Materials contract service is available with a Scheduled Pickup.

Domestic UPS® Ground*

Guaranteed day-definite delivery typically in one to five business days to all 50 states and Puerto Rico. Refer to UPS Ground Time in Transit maps at [ups.com/maps](https://www.ups.com/maps) to determine scheduled delivery. Saturday Delivery and pickup available in select areas.

Zones	2	3	4	5	6	7	8	44**	45**	46**
1 Lbs.	\$8.76	\$9.09	\$9.91	\$10.35	\$10.71	\$10.83	\$11.01	\$32.71	\$33.63	\$43.09
2	9.42	10.48	11.33	11.58	12.08	12.54	12.75	36.39	37.66	46.76
3	9.90	11.04	11.94	12.43	12.94	13.38	14.03	39.54	42.90	49.79
4	10.19	11.11	12.32	13.12	13.48	14.36	15.03	43.42	45.73	54.01
5	10.46	11.62	12.75	13.70	14.29	15.02	16.02	47.07	49.65	57.45
6	10.65	11.77	12.87	13.90	14.41	15.19	16.09	50.79	52.83	59.66
7	11.25	12.05	13.21	14.34	14.68	15.60	16.70	54.23	56.94	62.71
8	11.58	12.49	13.68	14.75	15.27	16.23	17.43	56.03	59.89	65.77
9	11.76	12.66	13.86	14.88	15.59	16.90	18.36	59.98	64.05	69.70
10	11.92	12.79	14.00	15.29	15.77	17.71	19.57	63.72	69.54	73.44
11	12.52	13.04	14.28	15.35	16.28	19.16	20.83	66.99	73.62	76.74
12	12.73	13.59	14.42	15.57	16.85	19.93	21.80	69.86	76.32	79.58
13	12.79	13.65	14.59	15.87	17.38	21.34	23.00	72.76	79.08	82.43
14	13.25	14.02	14.74	16.26	18.39	22.66	24.74	75.77	82.17	85.41
15	13.26	14.32	14.95	16.83	19.41	23.38	26.04	78.56	85.90	88.15
16	13.60	14.73	15.22	17.12	20.04	24.59	27.02	82.07	89.48	91.66
17	13.70	15.03	15.39	17.60	20.88	25.85	27.58	85.57	93.76	94.56
18	13.84	15.26	15.55	18.45	21.98	26.62	29.47	89.11	99.34	98.06
19	14.19	15.94	16.33	19.26	22.54	27.35	30.48	92.62	102.54	101.55
20	14.29	16.07	16.42	20.01	23.31	28.36	31.89	95.72	106.28	104.60
21	14.81	16.70	17.29	20.24	24.27	29.44	32.87	97.91	111.15	106.79
22	14.85	16.87	17.76	20.99	25.25	30.52	34.31	100.98	115.38	109.85
23	14.91	17.19	18.33	21.59	26.46	31.54	35.66	104.03	119.62	112.89
24	15.31	17.89	19.10	22.49	27.46	32.30	37.71	107.44	123.98	116.29
25	15.49	18.09	19.32	22.93	27.97	33.70	38.45	110.77	128.30	119.64
26	16.23	18.71	20.13	23.87	28.99	35.09	40.03	114.27	131.60	123.40
27	16.63	19.15	20.34	24.26	30.13	35.73	40.71	117.43	135.93	126.63
28	17.08	19.61	21.48	25.83	31.62	37.33	42.66	120.60	140.35	129.81
29	17.12	19.99	21.88	25.93	32.53	38.54	43.39	123.54	143.82	132.41
30	17.45	20.47	22.72	26.95	33.02	38.73	45.20	126.50	148.35	135.42
31	18.06	20.96	23.00	27.09	33.74	39.85	46.73	126.52	152.02	135.50
32	18.07	20.97	23.01	27.10	34.06	39.88	47.68	127.57	156.87	136.45
33	18.18	21.28	24.04	28.38	35.86	41.19	48.51	130.24	161.02	139.17
34	18.29	21.76	24.81	29.37	36.28	42.43	50.84	133.15	165.34	142.02
35	18.63	22.91	25.38	30.08	36.82	43.52	51.69	136.45	169.75	145.31

*Visit [ups.com/holidays](https://www.ups.com/holidays) for time in transit changes effective during the holiday season.

**Zone 44 is metro Alaska and Hawaii, zone 45 is Puerto Rico and zone 46 is remote Alaska and Hawaii.

Notes:

– For additional information, refer to page 26.

– UPS does not accept Hazardous Materials (including but not limited to Ltd Qty and combustibles) in UPS Ground services destined to and from Alaska; Hawaii; Puerto Rico; Avalon, CA; Catalina Island, CA; Beaver Island, MI; Mackinac Island, MI (winter only); The Bass Islands, OH; Kelleys Island, OH; and San Juan Islands, WA.

Domestic UPS® Ground*

Zones	2	3	4	5	6	7	8	44**	45**	46**
36 Lbs.	\$18.91	\$22.92	\$25.83	\$31.11	\$38.37	\$45.00	\$53.21	\$139.37	\$173.78	\$148.52
37	19.18	23.22	26.34	31.79	38.54	46.45	53.73	142.56	178.18	151.77
38	19.48	23.58	26.93	32.56	39.42	47.07	54.73	145.98	182.35	155.19
39	20.13	24.50	27.81	33.25	40.82	48.47	55.86	149.12	186.62	158.08
40	20.15	24.60	27.90	33.31	41.26	48.48	56.25	152.32	190.41	161.19
41	20.41	25.41	28.64	34.45	42.57	49.98	57.99	154.92	194.52	164.11
42	20.53	25.74	29.75	34.56	43.17	50.82	58.28	157.84	198.93	167.03
43	21.00	26.11	29.80	36.31	45.08	52.66	59.86	161.06	202.77	170.25
44	21.30	26.51	30.55	36.96	45.47	53.79	60.49	163.37	206.70	173.52
45	21.32	26.52	30.56	36.97	45.79	55.37	60.92	166.52	209.77	176.70
46	21.79	26.79	31.54	38.02	46.99	55.96	62.53	169.73	214.85	179.94
47	21.88	27.14	32.05	38.30	47.63	57.05	63.53	172.99	218.94	183.18
48	21.89	27.19	32.35	39.32	48.34	57.57	64.54	175.94	222.68	186.19
49	21.90	27.24	32.44	39.33	48.70	58.58	64.92	178.96	226.85	189.25
50	21.91	27.29	32.45	39.38	48.71	58.73	65.28	181.97	226.93	192.28
51	21.97	27.34	32.53	39.45	48.77	58.80	66.04	184.97	234.58	197.12
52	21.98	27.39	32.55	39.46	48.78	58.81	66.05	185.35	235.08	197.48
53	21.99	27.44	32.56	39.51	48.79	58.82	66.69	188.14	238.58	200.30
54	22.00	27.49	32.62	39.76	48.80	58.83	66.74	190.81	241.53	203.32
55	22.01	27.53	32.63	39.96	48.85	58.84	66.79	193.37	248.82	206.38
56	22.02	27.58	32.68	39.97	48.86	58.89	67.54	195.98	249.56	209.38
57	22.41	27.67	32.75	41.17	48.91	58.94	68.23	198.68	254.08	212.62
58	22.42	27.68	32.80	41.21	48.92	58.99	69.46	201.29	258.33	215.63
59	22.61	27.70	33.20	41.22	49.65	59.04	69.96	204.35	261.82	218.84
60	23.06	28.77	33.76	42.66	50.10	59.31	70.40	207.54	265.04	222.06
61	23.07	28.86	33.80	42.79	50.55	59.65	70.83	210.09	269.78	224.71
62	24.02	30.90	34.65	44.01	50.88	60.57	71.27	213.55	275.40	228.23
63	24.03	30.91	34.99	44.02	51.23	60.68	71.70	217.04	279.90	231.81
64	24.67	31.22	35.56	44.07	52.07	61.08	72.80	220.65	283.45	235.53
65	24.94	32.06	35.57	44.12	52.52	61.22	72.93	224.26	288.38	239.27
66	25.29	32.07	35.58	44.14	52.55	61.41	73.24	227.73	293.32	242.81
67	25.30	32.12	35.63	44.19	52.97	61.71	73.29	231.18	294.35	246.39
68	25.59	32.98	37.73	45.10	53.25	62.07	73.34	234.52	302.12	249.79
69	25.87	32.99	37.74	45.46	53.54	62.12	73.64	237.93	306.45	253.29
70	26.00	33.44	38.56	47.16	54.61	62.17	74.27	242.93	310.15	256.41
71	26.06	33.51	39.24	47.25	55.58	63.79	74.42	247.14	311.02	261.47
72	26.80	33.52	40.06	47.26	55.98	65.90	74.94	250.82	311.75	265.21
73	26.97	33.85	40.07	47.96	56.05	65.91	75.08	254.49	315.02	268.96
74	27.95	33.86	40.08	47.97	57.45	66.63	75.24	256.94	330.71	269.82
75	29.26	34.20	40.09	48.81	57.99	67.31	75.26	259.85	331.68	271.75

*Visit [ups.com/holidays](https://www.ups.com/holidays) for time in transit changes effective during the holiday season.

**Zone 44 is metro Alaska and Hawaii, zone 45 is Puerto Rico and zone 46 is remote Alaska and Hawaii.

Notes:

- For additional information, refer to page 26.
- UPS does not accept Hazardous Materials (including but not limited to Ltd Qty and combustibles) in UPS Ground services destined to and from Alaska; Hawaii; Puerto Rico; Avalon, CA; Catalina Island, CA; Beaver Island, MI; Mackinac Island, MI (winter only); the Bass Islands, OH; Kelleys Island, OH; and San Juan Islands, WA.

Domestic UPS® Ground*

Zones	2	3	4	5	6	7	8	44**	45**	46**
76 Lbs.	\$31.22	\$36.10	\$40.34	\$49.56	\$58.73	\$68.41	\$75.31	\$263.06	\$331.81	\$275.00
77	32.45	36.63	41.19	49.78	59.07	69.71	75.36	265.22	332.88	276.59
78	32.48	38.01	42.41	50.31	59.43	70.88	75.41	266.65	333.96	278.60
79	34.26	39.22	43.05	51.10	60.67	71.98	76.52	266.70	343.26	279.38
80	34.87	40.34	43.66	52.32	61.69	72.29	77.10	269.48	346.66	280.82
81	35.71	40.67	44.71	52.67	62.49	73.40	78.08	271.73	347.15	282.26
82	36.87	41.98	46.58	53.67	62.65	75.29	78.09	273.09	351.51	283.56
83	37.24	42.06	46.74	54.03	63.42	75.31	78.10	276.08	355.36	284.65
84	38.71	43.44	48.10	54.55	64.38	76.21	78.70	279.26	359.45	287.84
85	39.38	43.73	48.13	55.42	65.37	77.04	79.56	282.51	363.62	291.07
86	41.21	45.73	50.02	56.47	66.16	78.47	81.23	285.48	367.46	294.07
87	41.66	45.75	50.03	56.48	67.03	78.54	81.36	288.69	371.58	297.25
88	43.80	47.22	52.09	58.30	67.90	79.35	83.03	291.88	375.67	300.47
89	45.33	48.09	52.62	58.49	68.74	80.17	84.76	294.93	379.58	303.51
90	47.65	50.17	54.37	60.21	69.72	81.27	85.63	297.96	383.45	307.70
91	47.66	50.18	54.38	60.30	69.87	81.28	85.64	301.15	385.58	309.66
92	49.18	50.64	54.66	60.31	70.70	81.29	85.83	304.02	388.97	312.55
93	49.82	51.62	56.24	60.87	71.33	81.30	86.71	306.97	389.09	315.53
94	50.07	52.48	56.50	61.67	72.16	81.31	87.61	309.83	398.80	318.42
95	51.24	53.45	56.89	62.50	72.65	81.60	88.55	312.88	402.31	321.45
96	52.88	53.80	58.97	63.80	73.06	82.16	90.25	315.75	404.20	324.28
97	54.10	55.38	59.83	64.12	73.85	82.77	91.19	318.76	404.53	327.28
98	54.82	55.74	59.84	64.88	74.68	82.78	91.23	321.54	404.77	330.14
99	56.02	56.62	62.09	65.69	75.55	83.61	92.12	324.60	405.06	333.15
100	56.50	57.07	62.14	66.75	76.47	84.45	93.03	327.61	421.62	336.17
101	56.99	57.57	62.19	66.76	76.48	84.46	93.08	327.66	425.49	336.22
102	57.03	57.61	62.44	67.03	76.67	84.47	93.13	327.71	429.43	336.32
103	58.41	59.00	63.40	67.42	77.45	85.31	93.53	329.20	433.29	336.37
104	58.76	59.29	63.72	68.13	77.69	85.57	94.08	330.02	437.40	337.54
105	60.29	60.78	65.06	69.54	78.89	86.89	95.81	333.75	441.28	340.47
106	60.70	61.08	65.18	69.55	78.91	86.94	95.82	336.84	445.34	343.56
107	61.60	62.02	66.58	70.93	79.61	87.58	97.49	339.96	449.48	346.66
108	62.48	62.91	66.68	70.96	80.34	88.35	97.50	341.96	453.55	349.43
109	63.14	63.78	67.41	71.66	81.05	89.10	98.35	344.96	457.46	352.45
110	64.77	65.33	68.83	72.35	82.53	90.79	100.16	348.91	461.31	355.55
111	64.87	65.41	70.29	73.75	82.58	91.42	101.36	352.88	466.57	360.41
112	66.20	66.78	70.36	73.76	83.23	91.43	101.37	356.87	471.83	365.31
113	66.26	66.84	71.14	74.44	83.98	92.18	103.21	359.95	475.93	368.39
114	66.96	68.23	72.44	75.89	85.40	93.73	103.89	363.09	480.06	371.53
115	67.70	69.00	72.45	76.09	85.41	93.74	103.90	366.18	484.16	374.64

*Visit [ups.com/holidays](https://www.ups.com/holidays) for time in transit changes effective during the holiday season.

**Zone 44 is metro Alaska and Hawaii, zone 45 is Puerto Rico and zone 46 is remote Alaska and Hawaii.

Notes:

– For additional information, refer to page 26.

– UPS does not accept Hazardous Materials (including but not limited to Ltd Qty and combustibles) in UPS Ground services destined to and from Alaska; Hawaii; Puerto Rico; Avalon, CA; Catalina Island, CA; Beaver Island, MI; Mackinac Island, MI (winter only); the Bass Islands, OH; Kelleys Island, OH; and San Juan Islands, WA.

Domestic UPS® Ground*

Zones	2	3	4	5	6	7	8	44**	45**	46**
116 Lbs.	\$68.40	\$69.23	\$74.04	\$76.44	\$85.97	\$95.82	\$104.54	\$368.46	\$487.17	\$377.62
117	69.08	69.99	74.23	77.85	86.66	95.87	106.22	370.51	491.06	380.55
118	69.81	71.39	74.31	78.08	87.37	95.92	107.16	374.33	494.93	383.50
119	70.77	71.48	75.79	78.52	88.12	96.58	108.45	379.73	502.11	390.89
120	72.47	73.20	76.43	79.80	88.83	97.85	108.92	381.94	506.23	394.04
121	72.51	73.24	76.63	79.81	89.40	97.86	109.06	385.42	509.59	397.40
122	73.16	74.62	77.38	80.52	90.10	99.42	109.96	388.69	513.93	400.68
123	73.94	74.69	79.70	81.95	90.81	100.62	111.60	391.99	518.30	404.00
124	74.49	75.43	79.79	82.00	91.55	100.63	112.23	395.26	522.63	407.32
125	74.69	75.44	79.80	82.66	92.25	100.91	112.50	398.57	526.97	410.65
126	76.16	76.93	82.14	83.21	92.80	102.20	115.11	400.08	530.23	413.93
127	76.76	77.49	82.16	83.92	93.50	102.21	115.12	404.30	534.57	417.24
128	76.77	77.50	82.96	84.65	94.92	104.05	116.84	406.61	538.93	420.54
129	78.45	79.24	83.58	85.17	94.93	104.06	116.85	409.88	543.25	423.89
130	78.48	79.27	84.34	85.83	95.63	105.42	119.55	417.13	547.59	431.29
131	78.95	79.75	85.59	86.62	96.14	105.44	119.56	418.62	553.47	434.69
132	80.47	81.30	85.60	87.32	96.86	105.71	119.85	420.88	557.84	438.04
133	80.62	81.43	85.96	88.02	97.33	106.18	119.98	428.48	562.18	444.79
134	81.23	82.05	86.80	88.56	98.07	106.91	120.11	429.55	566.55	444.85
135	82.83	83.67	87.78	89.51	99.87	108.74	121.82	430.72	570.86	448.06
136	83.37	84.67	89.16	90.06	99.92	108.79	121.86	433.99	575.21	451.39
137	83.98	84.68	90.66	91.58	100.23	109.17	122.67	437.30	579.60	454.78
138	84.74	86.01	91.79	92.32	102.25	111.12	124.89	440.57	583.91	458.14
139	85.51	86.88	91.80	92.34	102.31	111.13	124.90	443.85	588.28	461.44
140	86.28	87.13	92.15	93.08	102.84	111.60	125.87	446.95	592.36	464.63
141	87.04	87.70	92.88	93.82	103.40	112.16	125.89	450.25	595.34	467.79
142	88.15	89.32	93.56	95.10	104.17	113.71	127.26	452.36	599.54	471.03
143	88.16	89.33	94.39	95.33	104.96	113.72	127.57	455.42	603.58	474.16
144	89.79	91.88	96.16	97.13	105.76	115.28	128.95	458.54	607.72	477.35
145	90.09	92.79	96.49	97.46	107.33	116.49	130.11	462.90	612.02	480.70
146	90.10	92.84	97.13	97.88	107.35	116.80	130.16	465.08	616.38	484.07
147	91.35	92.89	97.91	98.40	108.11	116.85	130.70	468.33	620.69	487.39
148	92.47	93.51	98.20	99.19	109.97	117.59	133.46	477.30	625.06	495.48
149	92.65	94.33	98.71	99.71	109.98	118.05	133.51	478.32	632.40	498.86
150	92.66	95.21	101.57	103.28	110.53	119.16	134.24	481.64	636.77	507.04
More Than 150 Pounds***										
Price Per Pound	\$0.62	\$0.64	\$0.68	\$0.70	\$0.74	\$0.80	\$0.90	\$3.24	\$4.29	\$3.41

*Visit [ups.com/holidays](https://www.ups.com/holidays) for time in transit changes effective during the holiday season.

**Zone 44 is metro Alaska and Hawaii, zone 45 is Puerto Rico and zone 46 is remote Alaska and Hawaii.

***For each UPS Ground package with a weight of more than 150 pounds, multiply the weight by the price per pound.

Notes:

- For additional information, refer to page 26.
- UPS does not accept Hazardous Materials (including but not limited to Ltd Qty and combustibles) in UPS Ground services destined to and from Alaska; Hawaii; Puerto Rico; Avalon, CA; Catalina Island, CA; Beaver Island, MI; Mackinac Island, MI (winter only); the Bass Islands, OH; Kelleys Island, OH; and San Juan Islands, WA.

Domestic UPS® Simple Rate

Notes:

- Size limits indicated by a box manufacturer may not reflect exterior dimensions of a package and should not be used as a substitute for actual length, width and height measurements in determining cubic inches.
- Packaging must meet all standard UPS packaging guidelines. Refer to page 17 for applicable information on measuring the length, width and height of irregularly shaped packages and items shipped in bags.
- UPS Simple Rate is limited to single-piece, prepaid, small package shipments. UPS Returns® Service options for UPS Simple Rate are limited to UPS Print Return Label Service only.
- UPS Simple Rate is not available for use with UPS Hundredweight Service®, Hazardous Materials shipments, third-party payor or freight collect shipments.
- UPS Express® packaging can be used with UPS Simple Rate for UPS Next Day Air Saver and UPS 2nd Day Air shipments.

Preparing a UPS Simple Rate Shipment

UPS Simple Rate offers flat rate pricing between the U.S. 50 states. The applicable rate is determined by package size and service option. Certain standard surcharges do not apply. Separate UPS Simple Rate pricing applies to shipments originating in or destined to Alaska and Hawaii.

Maximum Weight and Size

The maximum actual weight per UPS Simple Rate package is 50 pounds. The maximum size per UPS Simple Rate package is 1,728 cubic inches.

Service Options

Choose from four service options: UPS Next Day Air Saver®, UPS 2nd Day Air®, UPS 3 Day Select® and UPS® Ground. UPS 3 Day Select and UPS Next Day Air Saver are not available for UPS Simple Rate shipments destined to Alaska and Hawaii.

Determining the UPS Simple Rate Package Size

Follow the steps below to determine the package's UPS Simple Rate size.

1. Package the item in a box or poly mailer.

UPS Simple Rate is designed to be used with the shipper's own box or poly mailer.

2. Measure the package dimensions in inches.

For each dimension, measure at the longest point, rounding each measurement to the nearest whole number (for example, 1.00 to 1.49 will be considered 1, and 1.50 to 1.99 will be considered 2). The minimum measurement for each dimension is 1 inch.

3. Calculate the package size in cubic inches.

Multiply the package length (longest side of the package) by the width by the height. The result is the size in cubic inches.

4. Determine the package's UPS Simple Rate size.

Determine the UPS Simple Rate size, according to the package's size in cubic inches, using the chart below.

Shipping a UPS Simple Rate Package

Prepare and process UPS Simple Rate shipments at ups.com/simplerate or through another UPS automated shipping system, where available. Shippers do not need to open an account or enter into a contract to use UPS Simple Rate.

Pickup and Drop-off Availability

All standard pickup and drop-off options are available for use with UPS Simple Rate shipments. Refer to pages 23-24 for details.

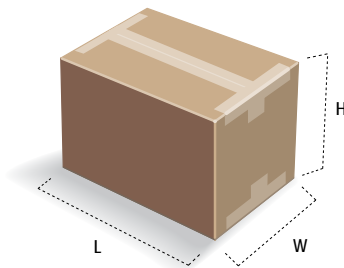

Length (L) x Width (W) x Height (H) = Cubic Inches

Cubic Inches	UPS Simple Rate Size
1-100	Extra Small
101-250	Small
251-650	Medium
651-1,050	Large
1,051-1,728	Extra Large

Domestic

UPS® Simple Rate

To determine the rate for a UPS Simple Rate shipment, refer to the applicable chart below:

UPS Simple Rate for Shipments Between the 48 Contiguous States

UPS Simple Rate Size	UPS® Ground	UPS 3 Day Select®	UPS 2nd Day Air®	UPS Next Day Air Saver®
Extra Small	\$8.80	\$14.65	\$17.70	\$25.75
Small	11.50	17.70	21.10	32.75
Medium	13.90	25.20	27.00	36.80
Large	18.40	33.75	48.15	55.15
Extra Large	22.85	42.40	62.40	71.40

UPS Simple Rate for Shipments from the 48 Contiguous States to Metro Alaska and Hawaii

UPS Simple Rate Size	UPS Ground	UPS 2nd Day Air
Extra Small	\$31.80	\$35.15
Small	34.20	37.70
Medium	42.25	46.10
Large	54.90	59.05
Extra Large	67.70	71.90



UPS Simple Rate for Shipments from the 48 Contiguous States to Remote Alaska and Hawaii

UPS Simple Rate Size	UPS Ground	UPS 2nd Day Air
Extra Small	\$41.70	\$65.35
Small	43.85	70.65
Medium	52.35	79.60
Large	64.10	92.55
Extra Large	77.85	109.85

Common Box Dimensions by UPS Simple Rate Size

UPS Simple Rate Size	Extra Small	Small	Medium	Large	Extra Large
Cubic Inch Range	1-100	101-250	251-650	651-1,050	1,051-1,728
Common Box Dimensions	8 x 6 x 2 6 x 4 x 4 11 x 9 x 1 4 x 4 x 4	8 x 6 x 5 12 x 9 x 2 9 x 7 x 3 6 x 6 x 6	13 x 11 x 2 12 x 9 x 6 13 x 12 x 4 8 x 8 x 8	12 x 12 x 7 15 x 11 x 6 14 x 10 x 7 10 x 10 x 10	16 x 12 x 9 12 x 10 x 9 18 x 12 x 6 12 x 12 x 12

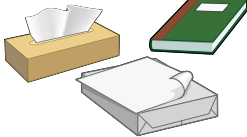
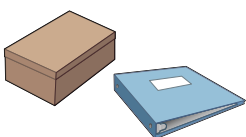
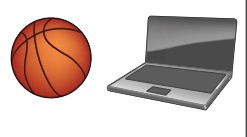
Example Products by UPS Simple Rate Size

Extra Small	Small	Medium	Large	Extra Large
1-100 Cubic Inches	101-250	251-650	651-1,050	1,051-1,728
 <p>Accessories Small Electronics T-shirt / Coffee Mug</p>	 <p>Hardcover Book Tissue Box Ream of Paper</p>	 <p>Shoebox Three-Inch Three-Ring Binder</p>	 <p>Regulation Basketball 14-Inch Laptop</p>	 <p>Small Appliances Tennis Racket</p>

Notes:

- The following surcharges do not apply to UPS Simple Rate shipments: Residential Surcharge, Delivery Area Surcharge, Delivery Area Surcharge Extended and fuel surcharges. Fees for other charges and value-added services set forth on pages 112-125 apply to UPS Simple Rate shipments.
- To determine which ZIP Codes are included in metro Alaska and Hawaii and remote Alaska and Hawaii, enter your origin ZIP Code and download a zone chart at: [ups.com/us/en/shipping/daily-rates.page](https://www.ups.com/us/en/shipping/daily-rates.page).
- The common box dimensions and example products listed below are provided by way of example only. All UPS Simple Rate shipments must conform to the terms, conditions, restrictions and prohibitions applicable to UPS Simple Rate.

Originating Within the U.S. 48 Contiguous States

Air Freight

Weight Breaks (Lbs.)	Destination U.S. 48							Destination			Destination Canada	
								AK/HI Metro	PR	AK/HI Extended		

UPS Next Day Air® Freight												
Guaranteed next-business-day delivery by 12:00 p.m. or 5:00 p.m., depending on destination, to most major metropolitan areas within and between the 48 contiguous states, Puerto Rico and Canada (excluding intra-Canada). For UPS zone information, refer to the 48 Contiguous States Zone Charts at ups.com/rates for UPS Next Day Air® service.										For UPS zone information, refer to pages 33-37 for UPS Worldwide Express® service.		
Zones	102	103	104	105	106	107	108	125		81	82	
151-499	\$1.51	\$2.51	\$4.55	\$6.42	\$6.52	\$7.99	\$8.82	For Next Business Day Service to AK/HI Metro, UPS Next Day Air® Freight NGS is available.	\$7.25	For Next Business Day Service to AK/HI Extended, UPS Next Day Air Freight NGS is available.	\$6.22	\$6.60
500-999	1.45	2.40	3.95	6.00	6.11	7.97	8.65		7.22		6.19	6.58
1,000-1,999	1.40	2.28	3.66	5.76	6.01	7.94	8.33		6.77		5.80	6.17
2,000 or More	1.31	2.23	3.30	4.92	5.74	7.61	7.80		6.75		5.78	6.15
Minimum Charge	150.18	249.56	375.57	472.77	502.78	524.37	585.58		1,089.38		624.07	683.59

UPS 2nd Day Air® Freight												
Guaranteed delivery by 12:00 p.m. or 5:00 p.m. on the second business day, depending on destination, to most major metropolitan areas within and between the 48 contiguous states, Puerto Rico and Canada (excluding intra-Canada). For UPS zone information, refer to the 48 Contiguous States Zone Charts at ups.com/rates for UPS 2nd Day Air® service.										For UPS zone information, refer to pages 33-37 for UPS Worldwide Expedited® service.		
Zones	202	203	204	205	206	207	208	225		71	72	
151-499	\$1.46	\$2.42	\$3.05	\$3.18	\$4.73	\$6.33	\$7.43	For Second Business Day Service to AK/HI Metro, UPS 2nd Day Air® Freight NGS is available.	\$5.17	For Second Business Day Service to AK/HI Extended, UPS 2nd Day Air Freight NGS is available.	\$4.46	\$4.67
500-999	1.42	2.27	2.86	3.11	4.59	6.11	6.98		5.15		4.44	4.66
1,000-1,999	1.29	2.22	2.73	3.07	4.45	6.04	6.76		4.81		4.12	4.32
2,000 or More	1.24	2.08	2.70	2.76	4.00	5.22	6.00		4.79		4.10	4.31
Minimum Charge	145.43	235.88	292.16	356.92	402.18	481.60	520.78		721.52		482.91	511.07

UPS 3 Day Freight®															
Guaranteed day-definite delivery within three to four business days by 5:00 p.m. to most major metropolitan areas within and between the 48 contiguous states and Canada. For UPS zone information, refer to the 48 Contiguous States Zone Charts at ups.com/rates for UPS 3 Day Select® service.										For UPS zone information, refer to pages 33-37 for UPS® Standard to Canada.					
Zones	302	303	304	305	306	307	308			51	52	53	54	55	56
151-499	\$1.23	\$2.13	\$2.61	\$2.85	\$4.06	\$5.09	\$5.89	For Services to AK/HI Metro, UPS Next Day Air Freight NGS and UPS 2nd Day Air Freight NGS are available.	For Services to AK/HI Extended, UPS Next Day Air Freight NGS and UPS 2nd Day Air Freight NGS are available.	\$1.79	\$2.29	\$2.67	\$3.28	\$3.64	\$4.02
500-999	1.11	1.99	2.57	2.77	3.79	4.96	5.78			1.76	2.25	2.63	3.20	3.53	3.92
1,000-1,999	1.08	1.86	2.37	2.69	3.69	4.67	5.68			1.71	2.15	2.55	3.11	3.41	3.78
2,000 or More	0.98	1.82	2.36	2.53	3.50	4.62	5.49			1.65	2.07	2.43	2.98	3.31	3.64
Minimum Charge	127.97	128.96	152.87	162.87	184.48	210.53	237.33			236.53	302.18	355.24	434.09	478.18	530.24

For guarantee details, service availability, delivery time commitments, to request a pickup or to view the "UPS Air Freight Terms and Conditions of Contract for UPS Air Freight Services in the United States, Canada and International," visit [ups.com/terms](https://www.ups.com/terms).

Notes:

- Door-to-door delivery for shipments of more than 150 pounds.
- All of the rates above are per pound and minimum charges are per shipment unless otherwise specified.
- A.M., P.M., B1, B2 and B3 points are defined by the current version of UPS Supply Chain Solutions® Quick Zip program, available at forwarding.ups-scs.com/quickzip. UPS Supply Chain Solutions service points are subject to change without prior notice.

Originating Within the U.S. 48 Contiguous States Air Freight

Weight Breaks (Lbs.)	Destination U.S. 48			Destination			Destination Canada	
				AK/HI Metro	PR	AK/HI Extended		

UPS Next Day Air® Freight NGS												
Delivery the next business day by 12:00 p.m. or 5:00 p.m., depending on destination to most areas within and between all 50 states, Puerto Rico and Canada. For UPS zone information, refer to the 48 Contiguous States Zone Charts at ups.com/rates for UPS Next Day Air® service.											For UPS zone information, refer to pages 33-37 for UPS Worldwide Express® service.	
Zones	102	103	104	105	106	107	108	124	125	126	81	82
151-499	\$1.49	\$2.39	\$4.29	\$6.08	\$6.17	\$7.56	\$8.35	\$9.14	\$6.85	\$9.59	\$5.88	\$6.25
500-999	1.43	2.27	3.74	5.69	5.79	7.55	8.19	8.86	6.81	9.27	5.85	6.22
1,000-1,999	1.37	2.16	3.60	5.66	5.68	7.53	7.88	8.51	6.40	9.21	5.49	5.85
2,000 or More	1.29	2.12	3.24	4.82	5.63	7.19	7.37	8.41	6.35	9.03	5.45	5.82
Minimum Charge	137.26	235.95	355.09	446.98	475.34	495.75	553.63	1,045.41	1,029.94	1,145.28	590.02	646.30

UPS 2nd Day Air® Freight NGS												
Delivery by 12:00 p.m. or 5:00 p.m. on the second business day, depending on destination to major areas within and between the 50 states, Puerto Rico and Canada. For UPS zone information, refer to the 48 Contiguous States Zone Charts at ups.com/rates for UPS 2nd Day Air® service.											For UPS zone information, refer to pages 33-37 for UPS Worldwide Expedited® service.	
Zones	202	203	204	205	206	207	208	224	225	226	71	72
151-499	\$1.35	\$2.24	\$2.83	\$2.96	\$4.42	\$5.93	\$6.96	\$7.91	\$5.13	\$8.49	\$4.20	\$4.40
500-999	1.31	2.11	2.66	2.90	4.29	5.72	6.53	7.83	5.10	8.31	4.17	4.38
1,000-1,999	1.18	2.06	2.54	2.85	4.16	5.65	6.33	7.44	4.75	8.18	3.89	4.07
2,000 or More	1.14	1.91	2.51	2.57	3.74	4.90	5.62	7.12	4.72	8.15	3.85	4.05
Minimum Charge	136.97	222.14	275.15	336.15	378.77	453.57	490.47	908.59	679.55	962.47	454.82	481.33

UPS 3 Day Freight® NGS																	
Day-definite delivery within three to four business days by 5:00 p.m. to most areas within and between the 48 contiguous states and Canada. For UPS zone information, refer to the 48 Contiguous States Zone Charts at ups.com/rates for UPS 3 Day Select® service.											For UPS zone information, refer to pages 33-37 for UPS® Standard to Canada.						
Zones	302	303	304	305	306	307	308	For Services to AK and HI, UPS Next Day Air Freight NGS and UPS 2nd Day Air Freight NGS are available.				51	52	53	54	55	56
151-499	\$1.15	\$2.00	\$2.46	\$2.68	\$3.84	\$4.80	\$5.55					\$1.69	\$2.18	\$2.52	\$3.11	\$3.45	\$3.82
500-999	1.03	1.86	2.41	2.60	3.58	4.69	5.46					1.67	2.15	2.50	3.04	3.35	3.72
1,000-1,999	0.99	1.75	2.22	2.53	3.48	4.40	5.36					1.63	2.03	2.43	2.97	3.24	3.59
2,000 or More	0.94	1.69	2.21	2.39	3.30	4.36	5.17					1.57	1.98	2.31	2.83	3.13	3.45
Minimum Charge	121.21	122.15	144.79	154.27	174.75	199.42	224.79	224.03	286.22	336.48	411.15	452.92	502.24				

For service availability, delivery time commitments, to request a pickup or to view the "UPS Air Freight Terms and Conditions of Contract for UPS Air Freight Services in the United States, Canada and International," visit [ups-scs.com/terms](https://www.ups-scs.com/terms).

Notes:

- Door-to-door delivery for shipments of more than 150 pounds.
- All of the rates above are per pound and minimum charges are per shipment unless otherwise specified.
- A.M., P.M., B1, B2 and B3 points are defined by the current version of UPS Supply Chain Solutions® Quick Zip program, available at forwarding.ups-scs.com/quickzip. UPS Supply Chain Solutions service points are subject to change without prior notice.

Export Shipment Pricing

UPS Worldwide Express Plus[®], UPS Worldwide Express[®], UPS Worldwide Express Freight[®] Midday, UPS Worldwide Express Freight[®], UPS Worldwide Saver[®], UPS Worldwide Expedited[®] and UPS[®] Standard

Shipment pricing is advantageous because rates are based on the total weight of a shipment, not the sum of the rates for each package in a shipment.

What Qualifies

1. The shipment consists of multiple packages, using the same service, shipped on the same day to a single consignee.
2. For shipments processed with WorldShip[®] or UPS CampusShip[®] shipping systems, [ups.com](https://www.ups.com) shipping, the UPS[®] Developer Kit or a UPS Ready[®] solution that supports full international service, or a UPS Worldwide Services Waybill. **Note:** For shipments processed with UPS Developer Kit – Shipping API, in order to obtain the best rate, customers are responsible for aggregating shipments for shipment pricing prior to requesting labels (UPS Developer Kit – Shipping API does not run End of Day).

What Does Not Qualify

Shipment pricing does not apply to UPS Express[®] Envelopes, UPS Express[®] Paks, the UPS[®] 10 KG Box, the UPS[®] 25 KG Box or packages recorded in a UPS Shipping Record book; they are each considered separate shipments.

Rates

Rates are based on the total billable weight of all packages in the shipment. Compare each package's actual weight to its dimensional weight. The greater of the two is the billable weight and should be used to calculate the rate. For multiple-package shipments, total the billable weight of all packages in the shipment. Refer to pages 16-17 for instructions on calculating dimensional and billable weight.

If the payer of the shipping charges is located in the origin country, the shipment will be charged the export rate (Origin Country Export Rates). When the payer of the shipping charges is located in the destination country,

the shipment will be charged the import rate (Destination Country Import Rates). If the destination country does not have import rates, the shipment will be charged the export rate (Origin Country Export Rates). When the payer of the shipping charges is located in a third country (neither origin nor destination country), the shipment will be charged the Origin Country Export Rates, except as otherwise agreed to by UPS and the contracting party.

For shipments weighing 150 pounds or less, locate the rate for the total weight of the shipment on the appropriate rate chart.

For shipments weighing more than 150 pounds, multiply the total weight (rounded to the next whole pound) by the appropriate price per pound. The amount billed will be the result of this calculation or the minimum rate shown, whichever is greater.

For a multiple-package UPS Standard shipment, the minimum charge will be based on an average weight of 15 pounds per package.

Customs Brokerage

For UPS Worldwide Express Plus, UPS Worldwide Express, UPS Worldwide

Express Freight Midday, UPS Worldwide Express Freight, UPS Worldwide Saver, UPS Worldwide Expedited and UPS[®] Standard to Mexico, rates include routine, in-house, customs clearance by UPS Supply Chain Solutions. Additional charges will apply if customs clearance is performed by customs brokerage offices other than those designated by UPS for clearing the services listed above.

Customs clearance for the services listed is provided by the UPS Supply Chain Solutions customs brokerage offices designated by UPS for handling package customs clearance. Other UPS Supply Chain Solutions customs brokerage offices charge fees for clearance of packages and freight.

For UPS[®] Standard to Canada, charges for customs clearance are not included in the rate. UPS will provide Customs Brokerage Services, unless otherwise specified by the importer. Customs brokerage charges, duties and taxes will be billed to the importer, unless otherwise indicated by the shipper. Canada brokerage rates are available at [ups.com/ca/en/shipping/zones-and-rates/customs-clearance.page](https://www.ups.com/ca/en/shipping/zones-and-rates/customs-clearance.page).

Useful Information – International Shipping

Import/Export Support

Information on international shipping and trade

Visit [ups.com/international](https://www.ups.com/international)

Shipping Forms

Import/export documents

Visit [ups.com/intl_forms](https://www.ups.com/intl_forms)

UPS Paperless[®] Invoice

Send Commercial Invoices and other customs documents electronically, saving time and paper

Visit [ups.com/paperlessinvoice](https://www.ups.com/paperlessinvoice)

UPS TradeAbility[®] Services

Harmonizer, landed cost and compliance tools

Visit [ups.com/tradeability](https://www.ups.com/tradeability)

International Customer Service

Assistance with international shipments

Call 1-800-782-7892

Export

UPS Worldwide Express®

UPS Worldwide Express Plus®

Guaranteed delivery by 8:30 a.m., 9:00 a.m. or 11:00 a.m. to major cities in 59 countries and territories. Delivery is guaranteed on the next business day to Canada, on the second business day to Europe and Latin America and on the second or third business day to Asia. Rates include door-to-door delivery with routine, in-house customs clearance by UPS Supply Chain Solutions®. Add \$40.00 to the appropriate UPS Worldwide Express rate for each UPS Worldwide Express Plus shipment.

UPS Worldwide Express

Guaranteed delivery by 10:30 a.m., 12:00 p.m. or 2:00 p.m. to 140 countries and territories. Delivery is guaranteed on the next business day to Canada and for documents to Mexico, the second business day to Europe and Latin America and the second or third business day to Asia. Rates include door-to-door delivery with routine, in-house customs clearance by UPS Supply Chain Solutions.

Zones	81	82	84	901	902	903	904	905	906	907	908	909	911	912	913	920	921
Letter*	\$49.02	\$50.48	\$53.14	\$66.99	\$62.02	\$73.20	\$78.93	\$77.53	\$99.51	\$140.40	\$149.90	\$64.48	\$78.38	\$74.67	\$65.78	\$58.25	\$71.02
Pak 1 Lbs.**	81.32	84.95	72.70	90.77	81.42	102.07	106.28	101.68	116.12	159.83	156.99	85.28	104.33	100.16	87.89	77.23	87.36
Pak 2 Lbs.**	89.28	93.59	76.33	95.93	90.44	104.83	115.71	108.43	155.79	189.64	187.38	93.13	121.47	110.00	97.21	87.59	117.02
10 KG Box†	160.51	180.68	194.97	248.86	250.78	287.58	309.01	307.67	416.60	402.78	417.69	247.20	302.25	290.55	259.94	218.91	318.30
25 KG Box†	252.27	280.82	307.83	372.55	378.38	439.95	520.09	548.05	697.00	773.97	739.42	384.20	472.97	478.39	415.89	372.32	551.22
1 Lbs.	92.97	101.32	93.63	113.82	108.23	135.15	123.08	118.11	146.03	182.02	189.95	104.90	127.92	121.57	109.21	102.81	110.58
2	102.26	111.76	105.60	129.29	116.76	159.46	150.35	137.02	175.63	207.33	209.57	119.26	144.92	139.67	125.66	109.30	134.41
3	114.63	122.03	117.46	150.20	127.95	177.77	172.70	158.97	205.45	249.90	238.32	141.06	161.64	157.31	144.01	121.56	144.60
4	126.49	134.32	132.02	174.52	143.72	202.11	200.45	181.19	242.03	291.73	283.25	164.00	177.70	177.46	167.67	136.53	163.13
5	141.33	161.83	150.47	203.63	162.10	219.02	226.06	215.35	266.26	323.77	317.86	198.97	215.55	215.42	210.99	153.99	182.36
6	146.01	169.49	168.82	216.35	176.01	236.66	247.41	226.79	300.81	343.04	338.11	210.65	236.66	235.44	221.48	167.22	212.35
7	149.05	173.59	179.81	228.81	188.45	259.44	269.30	246.86	334.15	368.92	377.23	223.45	257.58	260.35	233.46	180.77	235.71
8	153.42	176.09	188.96	238.84	199.35	277.64	290.04	274.92	397.79	386.73	403.91	234.29	283.94	275.17	240.38	191.22	257.94
9	154.52	179.88	190.39	239.86	200.38	283.49	294.99	279.23	404.10	393.62	419.40	235.40	292.35	277.70	243.24	194.06	287.93
10	155.58	180.99	193.93	241.37	203.68	286.20	304.87	280.31	405.46	395.28	427.69	236.80	293.73	278.64	244.36	197.26	302.32
11	159.23	183.12	200.09	243.71	213.48	289.25	308.38	291.40	421.29	401.84	428.68	245.17	298.64	286.92	250.20	202.81	318.08
12	161.10	185.09	206.85	251.53	222.38	293.56	314.18	296.48	424.38	414.32	444.51	252.29	308.67	293.00	254.81	211.26	341.00
13	197.32	231.28	244.44	291.88	233.61	340.33	382.61	352.53	514.28	491.39	535.02	308.47	353.72	360.34	303.62	221.93	356.19
14	212.28	243.32	271.21	326.02	244.01	375.85	433.24	382.80	553.04	552.52	594.95	331.98	428.77	401.67	324.48	231.82	370.62
15	220.52	251.51	290.27	337.24	270.83	398.94	462.81	441.36	581.79	598.99	602.48	344.01	439.45	421.39	342.43	257.29	392.02
16	228.72	257.93	291.31	349.78	286.71	413.62	481.48	448.19	650.74	682.65	653.90	357.78	456.63	443.32	359.74	273.71	410.71
17	235.30	265.48	292.41	356.38	288.69	415.27	495.68	449.17	655.97	691.00	697.68	369.81	458.61	454.03	360.67	275.58	426.03
18	239.68	266.58	293.52	357.36	290.48	416.38	497.08	450.15	678.93	711.98	735.10	371.74	459.60	455.15	361.74	277.31	436.25
19	240.72	269.30	294.62	358.34	309.83	417.42	498.15	451.13	688.02	749.65	737.11	372.87	460.58	456.26	362.83	295.78	454.91
20	241.74	270.39	295.72	359.32	321.36	418.48	499.20	452.12	689.39	758.26	740.72	373.98	461.57	457.30	363.94	306.78	469.53
21	242.77	271.48	296.79	360.29	324.99	419.53	500.26	452.20	690.42	759.31	741.71	375.02	462.55	458.38	372.65	310.25	476.55
22	243.80	272.54	297.86	361.27	326.14	420.55	501.32	453.18	691.43	760.34	742.70	376.06	463.54	459.47	381.78	311.35	490.64
23	244.84	273.60	298.93	362.25	331.81	421.58	502.38	454.16	692.46	761.74	750.85	377.10	464.52	460.56	391.72	316.76	501.54
24	247.12	276.05	302.07	367.77	334.30	423.84	504.76	474.29	711.36	762.72	791.15	378.93	474.94	461.55	393.21	319.13	516.50
25	249.37	278.43	306.03	372.03	341.52	435.11	512.83	484.22	720.64	766.81	809.17	386.84	484.80	471.10	397.83	326.03	533.02

*The Letter rate applies only to documents, correspondence and electronic media shipments of no commercial value that do not exceed eight ounces sent in a UPS Express® Envelope.

**UPS Express® Pak rates apply to shipments weighing two pounds or less, with a customs value of less than \$100.00 and UPS Express Pak is selected at the time of shipping.

†Shipments exceeding the maximum weights (10 KG/22 pounds and 25 KG/55 pounds) will be charged the regular UPS Worldwide Express Plus or UPS Worldwide Express rate. Available only when the shipper is paying the shipping charges.

Note: For additional information, refer to page 26.

Export

UPS Worldwide Express®

Zones	81	82	84	901	902	903	904	905	906	907	908	909	911	912	913	920	921
26 Lbs.	\$303.87	\$347.99	\$353.97	\$482.20	\$369.20	\$574.02	\$652.92	\$580.87	\$854.18	\$921.40	\$829.43	\$490.42	\$594.56	\$600.37	\$465.14	\$352.45	\$550.42
27	323.52	363.02	395.89	519.14	376.77	595.96	677.49	622.47	919.52	1,044.10	1,027.86	517.81	657.01	637.29	516.28	359.68	557.72
28	334.71	377.90	415.56	534.06	377.94	598.17	702.56	626.80	926.05	1,091.66	1,053.49	533.00	663.33	648.92	527.90	360.79	571.81
29	340.94	382.38	417.55	544.03	379.12	601.46	722.67	679.49	967.69	1,119.38	1,056.06	534.25	665.33	680.20	528.90	361.92	585.88
30	347.67	385.74	418.65	555.45	387.93	634.62	725.55	696.19	975.30	1,125.16	1,058.52	538.77	667.78	683.92	545.98	370.33	598.81
31	356.00	399.39	419.76	567.21	401.15	641.72	767.75	702.74	977.59	1,126.34	1,062.48	557.07	716.85	706.25	568.69	377.37	614.46
32	363.34	406.05	420.74	570.28	418.78	645.19	790.90	703.72	982.32	1,128.92	1,063.90	588.46	744.21	721.30	580.75	393.96	628.56
33	370.70	414.20	443.90	600.69	427.85	656.19	809.00	719.68	1,055.08	1,146.78	1,120.01	600.00	746.95	724.18	600.02	402.49	642.33
34	378.05	420.87	447.46	608.55	443.56	657.36	826.53	736.62	1,062.38	1,152.92	1,125.62	609.77	750.09	745.86	609.45	417.27	655.83
35	384.27	427.54	448.49	629.39	445.47	676.65	844.63	738.53	1,125.39	1,227.45	1,126.81	611.03	813.23	754.73	610.58	419.07	676.74
36	384.94	430.46	449.66	645.05	483.21	679.30	858.22	739.51	1,165.75	1,234.64	1,150.74	612.20	819.54	804.76	623.65	454.57	683.26
37	397.29	442.23	450.77	647.59	510.14	681.97	890.11	740.50	1,183.46	1,236.14	1,172.94	648.76	820.52	816.27	648.64	479.91	698.24
38	402.41	448.32	451.89	649.28	512.86	703.16	917.46	769.40	1,197.88	1,237.28	1,175.17	660.09	826.05	819.91	660.38	482.46	712.16
39	409.73	454.25	459.69	685.60	523.37	712.23	936.66	783.23	1,198.86	1,238.40	1,185.85	672.47	827.40	854.33	672.43	492.35	725.51
40	417.10	461.83	460.80	699.01	524.53	745.14	938.30	784.64	1,199.85	1,239.56	1,236.16	674.27	828.53	855.67	681.53	493.44	740.30
41	424.47	464.70	465.39	711.03	534.51	748.45	956.35	812.25	1,200.84	1,240.82	1,317.39	694.23	872.00	858.32	683.09	510.26	755.39
42	431.25	474.92	485.37	720.34	536.76	752.56	974.55	828.43	1,218.53	1,242.01	1,338.93	705.19	891.70	897.15	705.30	512.41	769.76
43	436.93	483.72	497.49	734.73	537.92	798.56	992.59	830.26	1,226.72	1,324.55	1,387.73	716.72	929.24	909.56	717.20	513.52	796.67
44	443.17	491.13	501.43	744.47	547.46	842.78	1,011.09	866.80	1,227.71	1,358.05	1,392.62	727.60	941.61	927.90	727.49	522.63	802.64
45	449.95	497.09	504.90	755.90	549.32	864.02	1,029.31	933.87	1,228.69	1,362.20	1,398.95	739.17	943.31	947.11	739.10	524.40	825.28
46	455.05	507.97	523.42	767.75	586.24	871.38	1,052.00	940.57	1,229.68	1,445.29	1,525.47	746.86	977.34	955.59	746.78	559.66	840.56
47	461.83	513.06	532.17	781.12	589.94	878.58	1,065.54	992.09	1,230.68	1,508.73	1,538.19	759.04	980.78	968.85	759.40	563.18	857.92
48	468.03	522.49	539.14	792.79	591.12	905.21	1,083.74	997.25	1,242.90	1,515.10	1,539.47	770.57	981.76	984.50	769.14	564.31	875.32
49	473.14	527.72	541.31	804.07	613.61	907.90	1,101.36	1,013.35	1,246.93	1,585.73	1,540.58	782.75	982.75	985.78	782.56	585.77	892.55
50	479.94	535.37	546.05	805.13	615.89	910.05	1,118.07	1,016.49	1,268.14	1,592.81	1,541.70	793.83	984.94	987.13	793.71	587.95	910.35
52	491.62	545.85	549.08	829.63	658.11	955.22	1,161.88	1,077.51	1,430.94	1,597.97	1,594.11	807.77	1,063.55	995.45	807.76	628.24	919.32
54	499.18	552.53	576.59	847.45	665.77	976.00	1,183.90	1,084.21	1,440.59	1,601.42	1,599.84	821.77	1,109.59	1,046.19	819.30	635.58	949.21
56	509.29	563.12	587.14	873.89	693.06	994.01	1,226.51	1,087.45	1,507.78	1,678.40	1,612.98	847.40	1,124.88	1,083.76	846.18	661.62	977.49
58	519.97	573.57	598.49	900.35	720.34	1,003.87	1,270.03	1,090.67	1,565.69	1,767.37	1,626.10	873.03	1,140.16	1,121.19	874.77	687.66	1,008.80
60	535.94	586.37	601.52	930.05	723.84	1,077.13	1,324.36	1,095.85	1,578.69	1,824.46	1,708.84	906.79	1,262.22	1,207.37	907.20	691.01	1,039.27
62	546.11	597.25	615.02	941.22	765.56	1,093.29	1,367.70	1,141.34	1,581.91	1,831.36	1,712.96	930.55	1,266.19	1,231.08	937.05	730.82	1,070.74
64	556.34	606.11	618.05	982.22	770.13	1,096.69	1,411.67	1,204.69	1,585.15	1,834.81	1,746.66	954.30	1,269.54	1,270.34	957.30	735.19	1,104.86
66	563.71	615.99	628.19	1,007.21	776.07	1,100.11	1,445.82	1,209.29	1,663.04	1,838.24	1,750.24	978.04	1,331.92	1,283.43	976.21	740.86	1,134.53
68	574.87	626.43	656.43	1,033.05	828.58	1,160.03	1,460.92	1,283.09	1,805.67	1,841.27	1,905.57	1,001.77	1,335.35	1,293.89	1,012.65	790.99	1,174.28
70	586.34	638.01	666.18	1,057.57	832.10	1,176.53	1,530.84	1,298.00	1,818.72	1,867.27	1,922.39	1,025.48	1,338.37	1,330.25	1,028.79	794.35	1,205.06

Note: For additional information, refer to page 26.

Export

UPS Worldwide Express®

Zones	81	82	84	901	902	903	904	905	906	907	908	909	911	912	913	920	921
72 Lbs.	\$592.56	\$641.64	\$669.60	\$1,080.17	\$864.07	\$1,227.91	\$1,570.40	\$1,371.97	\$1,821.74	\$1,909.67	\$1,968.87	\$1,032.89	\$1,393.10	\$1,350.73	\$1,037.46	\$824.87	\$1,238.29
74	600.54	657.07	672.63	1,104.36	867.69	1,272.73	1,600.45	1,380.65	1,827.16	1,982.93	2,016.44	1,071.03	1,427.66	1,373.65	1,050.06	828.32	1,272.50
76	616.91	667.38	675.66	1,107.57	931.06	1,284.52	1,607.55	1,478.18	1,957.67	2,047.35	2,019.86	1,094.74	1,467.45	1,420.10	1,098.01	875.88	1,303.85
78	622.56	676.07	692.89	1,138.65	937.71	1,288.82	1,648.69	1,481.42	1,961.08	2,055.96	2,033.01	1,118.48	1,471.49	1,506.58	1,121.97	882.13	1,337.70
80	629.87	684.51	699.28	1,155.29	943.57	1,351.88	1,663.36	1,509.78	1,982.68	2,065.40	2,051.27	1,142.17	1,474.52	1,535.46	1,148.26	887.64	1,361.06
82	636.29	692.92	726.44	1,189.88	947.06	1,355.29	1,666.59	1,513.02	1,985.71	2,068.96	2,089.77	1,145.43	1,478.58	1,549.88	1,151.76	890.93	1,367.20
84	642.04	701.20	733.61	1,215.50	1,011.78	1,358.70	1,747.22	1,516.24	1,988.73	2,105.60	2,092.81	1,148.69	1,557.11	1,552.96	1,169.02	951.81	1,400.74
86	649.24	707.40	737.24	1,234.40	1,018.88	1,361.71	1,777.27	1,544.66	1,991.76	2,124.33	2,217.96	1,203.92	1,562.22	1,556.03	1,203.51	958.49	1,428.72
88	656.43	719.99	740.68	1,258.31	1,022.70	1,401.81	1,807.14	1,547.89	1,994.79	2,174.00	2,299.61	1,206.97	1,656.22	1,559.11	1,223.68	962.08	1,460.61
90	663.64	726.34	758.39	1,267.08	1,037.89	1,459.63	1,836.90	1,632.24	1,997.82	2,177.03	2,363.89	1,238.84	1,673.53	1,562.18	1,243.97	976.37	1,494.27
92	670.80	734.15	767.78	1,284.45	1,059.97	1,468.54	1,867.10	1,655.25	2,000.84	2,191.29	2,370.70	1,257.39	1,676.73	1,565.26	1,264.10	997.15	1,527.27
94	678.00	742.31	770.81	1,311.36	1,076.56	1,566.05	1,889.74	1,725.02	2,003.87	2,324.63	2,374.15	1,279.98	1,759.94	1,568.34	1,278.76	1,012.75	1,557.01
96	683.38	744.58	773.84	1,319.36	1,107.10	1,598.75	1,910.16	1,739.12	2,006.90	2,513.20	2,494.89	1,304.89	1,771.18	1,610.47	1,304.61	1,056.87	1,583.73
98	685.87	747.87	777.19	1,322.43	1,130.29	1,601.76	1,919.40	1,742.13	2,009.93	2,597.66	2,508.92	1,307.94	1,774.20	1,620.18	1,313.63	1,063.31	1,612.03
100	695.73	754.35	780.53	1,325.60	1,182.39	1,605.24	1,922.60	1,836.23	2,150.97	2,678.85	2,890.88	1,311.31	1,777.23	1,623.53	1,325.66	1,128.84	1,617.83
105	727.72	788.81	811.23	1,390.77	1,266.16	1,688.67	2,006.34	1,910.75	2,258.52	2,812.79	3,032.56	1,372.84	1,852.03	1,709.92	1,390.76	1,191.12	1,681.32
110	762.37	826.36	849.67	1,456.99	1,326.44	1,768.15	2,101.89	2,001.73	2,366.07	2,946.73	3,176.83	1,438.20	1,940.24	1,791.36	1,455.86	1,247.83	1,694.85
115	797.03	863.92	887.51	1,523.23	1,386.73	1,848.18	2,197.43	2,092.71	2,473.62	3,080.67	3,318.09	1,503.58	2,028.43	1,872.77	1,520.71	1,304.54	1,748.43
120	831.68	901.49	926.05	1,589.44	1,447.02	1,928.54	2,292.98	2,183.71	2,581.15	3,214.62	3,459.04	1,568.96	2,116.61	1,954.20	1,585.43	1,361.26	1,818.25
125	866.33	939.04	963.67	1,655.68	1,507.31	2,008.13	2,388.51	2,274.70	2,688.71	3,348.56	3,599.77	1,634.31	2,204.81	2,035.62	1,651.29	1,417.97	1,888.53
130	899.71	976.60	1,008.42	1,721.90	1,567.61	2,087.51	2,484.04	2,365.68	2,796.25	3,482.50	3,743.61	1,699.69	2,292.99	2,117.05	1,717.27	1,474.70	1,939.52
135	934.29	1,014.16	1,047.02	1,788.12	1,627.90	2,167.62	2,579.59	2,456.67	2,903.80	3,616.45	3,884.06	1,765.06	2,381.18	2,198.47	1,791.07	1,531.42	1,988.93
140	968.75	1,051.72	1,085.72	1,854.35	1,688.19	2,245.90	2,675.12	2,547.66	3,011.36	3,750.39	4,027.77	1,830.43	2,469.39	2,279.89	1,857.36	1,588.13	2,054.18
145	1,002.55	1,089.28	1,124.46	1,920.58	1,748.48	2,325.00	2,770.67	2,638.64	3,118.89	3,884.32	4,167.79	1,895.81	2,557.57	2,361.31	1,923.66	1,644.85	2,120.12
150	1,036.83	1,126.84	1,163.16	1,986.81	1,808.77	2,415.36	2,866.21	2,729.62	3,226.45	4,018.26	4,311.38	1,961.19	2,645.75	2,442.75	1,989.97	1,701.57	2,185.64

Determining the Rate

Shipments of More Than 150 Pounds (non-pallet)

Zones	81	82	84	901	902	903	904	905	906	907	908	909	911	912	913	920	921
Price Per Pound	\$6.92	\$7.52	\$7.76	\$13.25	\$12.06	\$16.11	\$19.11	\$18.20	\$21.51	\$26.79	\$28.75	\$13.08	\$17.64	\$16.29	\$13.27	\$11.35	\$14.58
Minimum Rate	1,036.83	1,126.84	1,163.16	1,986.81	1,808.77	2,415.36	2,866.21	2,729.62	3,226.45	4,018.26	4,311.38	1,961.19	2,645.75	2,442.75	1,989.97	1,701.57	2,185.64

Note: For additional information, refer to page 26.

Export

UPS Worldwide Express Freight® Midday

Guaranteed delivery by 12:00 p.m. or 2:00 p.m. to 39 countries and territories. Delivery is guaranteed on the next business day to Canada, the second business day to Europe and Latin America and within two to three business days to Asia. Rates include door-to-door and non door-to-door delivery with routine, in-house customs clearance by UPS Supply Chain Solutions® for palletized shipments of more than 150 pounds.

Door-to-Door

Zones	481	482	484	401	402	403	404	405
151-999 Lbs. (Price per Lb.)	\$7.69	\$8.18	\$8.40	\$15.41	\$12.65	\$15.88	\$22.39	\$19.73
1,000 Lbs. or More (Price per Lb.)	7.15	7.65	7.86	14.41	11.71	14.85	20.94	18.44
Minimum Rate	1,161.19	1,235.18	1,268.40	2,326.91	1,910.15	2,397.88	3,380.89	2,979.23

Zones	406	407	408	409	411	412	413	420	421
151-999 Lbs. (Price per Lb.)	\$23.53	\$29.57	\$32.34	\$13.80	\$17.04	\$17.81	\$14.30	\$12.65	\$16.12
1,000 Lbs. or More (Price per Lb.)	21.88	27.35	30.24	12.90	15.84	16.66	13.37	11.71	14.99
Minimum Rate	3,553.03	4,465.07	4,883.34	2,083.80	2,573.04	2,689.31	2,159.30	1,910.15	2,434.12

Non Door-to-Door: Drop-off, Hold at Location,
Drop-off and Hold at Location

Zones	481	482	484	401	402	403	404	405
151-999 Lbs. (Price per Lb.)	\$6.87	\$7.35	\$7.59	\$14.54	\$11.85	\$15.08	\$21.51	\$18.93
1,000 Lbs. or More (Price per Lb.)	6.33	6.82	7.05	13.54	10.91	14.04	20.06	17.64
Minimum Rate	1,037.37	1,109.85	1,146.09	2,195.54	1,789.35	2,277.08	3,248.01	2,858.43

Zones	406	407	408	409	411	412	413	420	421
151-999 Lbs. (Price per Lb.)	\$22.75	\$28.76	\$31.53	\$12.96	\$16.24	\$16.97	\$13.48	\$11.85	\$15.32
1,000 Lbs. or More (Price per Lb.)	21.10	26.54	29.43	12.06	15.04	15.82	12.55	10.91	14.19
Minimum Rate	3,435.25	4,342.76	4,761.03	1,956.96	2,452.24	2,562.47	2,035.48	1,789.35	2,313.32

Notes:

- Door-to-door refers to shipments picked up and delivered to addresses designated by the shipper.
- Drop-off refers to shipments that are dropped off at a UPS Worldwide Express Freight Center and delivered to a designated address.
- Hold at Location refers to shipments picked up at a designated address and held at a UPS Worldwide Express Freight Center for pickup.
- Drop-off and Hold at Location refers to shipments that are dropped off and held at a UPS Worldwide Express Freight Center for pickup.
- For UPS Worldwide Express Freight Midday shipments, additional charges may apply to larger pallets. Pallets exceeding maximum size or weight restrictions (which vary by origin and destination) as set forth at [ups.com/assets/resources/media/wwef_max_dim.pdf](https://www.ups.com/assets/resources/media/wwef_max_dim.pdf) require prior authorization. Refer to page [124](#) for more information.
- For additional information, refer to page [26](#).

Export

UPS Worldwide Express Freight®

Guaranteed delivery by end of day to 76 countries and territories. Delivery is guaranteed on the next business day to Canada, the second business day to Europe and Latin America and within two to three business days to Asia. Rates include door-to-door and non door-to-door delivery with routine, in-house customs clearance by UPS Supply Chain Solutions for palletized shipments of more than 150 pounds.

Door-to-Door

Zones	481	482	484	401	402	403	404	405
151-999 Lbs. (Price per Lb.)	\$6.52	\$6.93	\$7.30	\$12.33	\$11.00	\$13.81	\$17.91	\$17.16
1,000 Lbs. or More (Price per Lb.)	6.06	6.48	6.83	11.53	10.18	12.91	16.75	16.04
Minimum Rate	984.52	1,046.43	1,102.30	1,861.83	1,661.00	2,085.31	2,704.41	2,591.16

Zones	406	407	408	409	411	412	413	420	421
151-999 Lbs. (Price per Lb.)	\$21.01	\$25.71	\$28.12	\$11.50	\$14.82	\$14.84	\$12.12	\$11.00	\$14.02
1,000 Lbs. or More (Price per Lb.)	19.54	23.78	26.29	10.75	13.78	13.88	11.33	10.18	13.04
Minimum Rate	3,172.51	3,882.21	4,246.12	1,736.50	2,237.82	2,240.84	1,830.12	1,661.00	2,117.02

Non Door-to-Door: Drop-off, Hold at Location,
Drop-off and Hold at Location

Zones	481	482	484	401	402	403	404	405
151-999 Lbs. (Price per Lb.)	\$5.82	\$6.23	\$6.60	\$11.63	\$10.30	\$13.11	\$17.21	\$16.46
1,000 Lbs. or More (Price per Lb.)	5.36	5.78	6.13	10.83	9.48	12.21	16.05	15.34
Minimum Rate	878.82	940.73	996.60	1,756.13	1,555.30	1,979.61	2,598.71	2,485.46

Zones	406	407	408	409	411	412	413	420	421
151-999 Lbs. (Price per Lb.)	\$20.31	\$25.01	\$27.42	\$10.80	\$14.12	\$14.14	\$11.42	\$10.30	\$13.32
1,000 Lbs. or More (Price per Lb.)	18.84	23.08	25.59	10.05	13.08	13.18	10.63	9.48	12.34
Minimum Rate	3,066.81	3,776.51	4,140.42	1,630.80	2,132.12	2,135.14	1,724.42	1,555.30	2,011.32

Notes:

- Door-to-door refers to shipments picked up and delivered to addresses designated by the shipper.
- Drop-off refers to shipments that are dropped off at a UPS Worldwide Express Freight Center and delivered to a designated address.
- Hold at Location refers to shipments picked up at a designated address and held at a UPS Worldwide Express Freight Center for pickup.
- Drop-off and Hold at Location refers to shipments that are dropped off and held at a UPS Worldwide Express Freight Center for pickup.
- For UPS Worldwide Express Freight shipments, additional charges may apply to larger pallets. Pallets exceeding maximum size or weight restrictions (which vary by origin and destination) as set forth at [ups.com/media/en/wwef_max_dim.pdf](https://www.ups.com/media/en/wwef_max_dim.pdf) require prior authorization. Refer to page 124 for more information.
- For additional information, refer to page 26.

Export

UPS Worldwide Saver®

Guaranteed delivery by end of business day to more than 220 countries and territories. Delivery is guaranteed on the next business day to Canada and for documents to Mexico, the second business day to Europe and Latin America and within two to three business days to Asia. Rates include door-to-door delivery with routine, in-house customs clearance by UPS Supply Chain Solutions.

Zones	481	482	484	401	402	403	404	405	406	407	408	409	411	412	413	420	421
Letter*	\$48.27	\$49.73	\$51.84	\$66.24	\$59.52	\$72.11	\$77.15	\$76.15	\$97.55	\$138.05	\$146.96	\$63.15	\$77.22	\$73.20	\$62.94	\$56.55	\$68.28
Pak 1 Lbs.**	80.51	83.69	70.92	90.02	78.92	100.56	103.89	99.88	113.84	156.69	153.16	83.52	102.28	98.19	84.10	74.98	84.00
Pak 2 Lbs.**	88.39	92.20	74.46	95.16	87.80	103.28	113.10	106.51	152.73	185.92	183.70	91.21	118.85	107.42	93.02	83.41	112.51
10 KG Box†	154.33	173.73	187.47	239.28	241.13	276.51	297.12	295.83	400.57	387.28	401.62	237.69	290.62	279.37	249.94	210.49	306.05
25 KG Box†	242.56	270.01	295.99	358.22	363.82	423.02	500.08	526.97	670.19	744.20	710.98	369.42	454.77	459.99	399.89	358.00	530.01
1 Lbs.	92.04	99.82	92.70	112.91	105.07	133.15	120.66	116.02	143.73	178.97	186.22	102.84	125.41	119.18	106.54	99.81	104.32
2	101.24	110.10	104.24	127.04	113.35	157.10	147.40	134.59	172.86	203.86	205.46	116.92	142.77	136.57	122.59	107.68	129.24
3	112.91	120.22	115.95	147.25	124.22	175.14	169.31	155.54	202.21	245.72	233.64	137.86	159.25	153.57	140.49	118.01	139.03
4	124.35	132.15	130.32	171.11	139.53	199.12	196.31	177.10	236.30	286.85	277.69	159.82	175.07	172.28	163.58	132.55	156.85
5	138.95	157.58	148.53	199.64	157.37	215.78	221.41	210.51	262.06	318.35	311.62	193.92	209.30	208.96	206.85	149.50	175.34
6	143.54	164.42	164.24	211.32	170.88	233.16	242.31	221.68	296.07	337.30	331.48	206.51	230.69	228.39	217.13	162.34	204.18
7	147.23	168.38	175.36	223.49	182.96	255.60	263.75	241.31	328.88	362.75	369.83	219.06	249.25	252.55	228.88	173.81	226.64
8	151.90	173.48	186.53	233.29	193.54	273.53	284.06	270.05	391.52	380.26	395.99	228.91	274.65	266.93	235.66	183.86	248.01
9	152.99	177.22	187.94	234.36	194.54	279.30	289.20	274.29	397.73	389.72	411.17	229.92	288.02	269.39	238.47	184.81	276.85
10	154.03	178.31	191.44	238.32	197.74	281.97	298.89	275.35	399.07	391.36	419.30	232.15	289.38	271.76	239.56	187.86	290.69
11	157.65	181.66	197.52	241.77	207.26	284.97	302.33	286.24	414.65	397.86	420.27	240.36	292.78	281.29	244.09	196.90	305.84
12	159.50	183.62	204.19	249.53	215.90	289.22	308.01	292.96	417.69	410.21	435.79	247.34	302.61	286.97	248.59	205.10	327.88
13	195.36	227.86	241.30	284.81	226.80	335.30	375.10	346.29	506.18	476.66	524.52	298.07	346.78	349.55	296.21	215.46	342.49
14	210.17	239.72	267.72	323.43	236.90	370.29	424.74	376.03	544.33	543.28	583.28	324.51	422.43	392.25	316.56	225.06	356.36
15	218.33	247.79	286.54	334.56	262.94	393.04	453.73	433.55	572.62	588.97	590.66	336.27	430.83	411.51	334.07	249.79	376.94
16	226.45	255.88	288.42	346.31	279.71	409.52	472.03	442.87	640.49	671.23	641.07	349.73	447.67	432.92	349.94	265.73	394.91
17	232.97	263.37	289.51	353.55	281.64	411.15	485.96	443.84	645.63	679.44	684.00	361.49	451.83	444.69	351.87	267.55	409.64
18	237.77	264.46	290.61	354.52	283.39	412.25	487.33	444.81	668.23	700.07	720.68	364.45	452.80	445.78	352.91	269.23	419.47
19	238.80	267.16	291.70	355.49	302.27	413.28	488.38	445.78	677.18	737.11	722.65	365.55	453.77	446.87	353.98	287.16	437.41
20	239.82	268.24	292.79	356.46	313.52	414.33	489.41	446.75	678.53	745.58	726.19	366.64	454.74	447.89	355.06	297.84	451.47
21	240.84	269.32	293.85	357.43	317.06	415.37	490.45	447.72	679.54	746.61	727.16	367.66	455.71	448.95	363.56	301.21	458.22
22	241.86	270.37	294.91	358.40	318.18	416.38	491.49	448.69	680.54	747.63	728.13	368.68	456.68	450.01	372.46	302.28	471.76
23	242.89	271.42	295.97	359.37	323.71	417.40	492.52	449.66	681.55	749.00	736.12	369.70	457.65	451.08	382.16	307.53	482.25
24	245.15	273.85	299.07	364.85	326.14	419.64	494.86	469.59	700.15	749.97	783.31	371.50	467.92	452.05	383.61	309.83	496.63
25	247.39	276.22	303.00	368.34	333.19	430.80	502.77	478.47	709.29	753.99	801.15	379.25	475.29	461.41	388.12	316.53	512.51

*The Letter rate applies only to documents, correspondence and electronic media shipments of no commercial value that do not exceed eight ounces sent in a UPS Express® Envelope.

**UPS Express® Pak rates apply to shipments weighing two pounds or less, with a customs value of less than \$100.00 and UPS Express Pak is selected at the time of shipping.

†Shipments exceeding the maximum weights (10 KG/22 pounds and 25 KG/55 pounds) will be charged the regular UPS Worldwide Saver rate. Available only when the shipper is paying the shipping charges.

Note: For additional information, refer to page 26.

Export

UPS Worldwide Saver®

Zones	481	482	484	401	402	403	404	405	406	407	408	409	411	412	413	420	421
26 Lbs.	\$301.11	\$343.52	\$350.46	\$478.37	\$360.19	\$568.33	\$640.74	\$573.98	\$840.72	\$905.99	\$821.21	\$479.39	\$585.77	\$581.75	\$453.79	\$342.18	\$529.25
27	320.64	355.29	391.97	514.00	367.58	590.05	664.85	615.08	905.03	1,026.64	1,007.70	506.16	647.30	617.52	502.21	349.20	536.26
28	331.84	373.05	411.44	528.77	368.72	592.24	689.46	619.36	911.46	1,073.41	1,032.83	521.01	653.52	628.79	513.52	350.28	549.81
29	338.04	377.47	413.41	538.64	369.87	595.50	709.19	671.43	952.45	1,100.66	1,035.35	522.23	655.49	659.10	514.49	351.37	563.34
30	344.66	382.67	414.50	549.95	378.46	628.33	712.02	687.93	959.94	1,106.35	1,037.76	526.65	657.91	662.71	531.10	359.54	575.77
31	352.86	394.26	415.60	561.59	391.36	635.36	753.43	694.40	962.19	1,107.51	1,041.64	544.54	706.25	684.35	553.20	371.79	590.82
32	360.21	400.83	416.57	564.63	408.56	638.80	776.15	695.37	966.85	1,110.04	1,043.03	575.22	733.21	698.93	564.93	388.13	604.38
33	367.54	408.88	439.50	594.74	417.41	649.69	793.91	711.14	1,038.46	1,135.42	1,098.04	586.51	735.91	701.72	583.67	396.54	617.62
34	374.86	415.46	443.02	602.52	432.74	650.85	811.11	727.88	1,045.64	1,141.50	1,103.54	596.06	739.00	722.73	592.85	411.10	630.60
35	380.91	422.05	444.04	623.15	434.60	669.95	828.88	729.77	1,107.66	1,206.93	1,104.71	597.29	801.21	731.32	593.94	412.87	650.71
36	381.88	427.04	445.20	638.66	471.42	672.57	842.21	730.74	1,147.39	1,214.00	1,128.17	598.43	807.42	779.80	606.66	447.85	656.98
37	393.72	436.55	446.30	641.17	497.69	675.21	873.51	731.71	1,164.82	1,215.47	1,149.94	634.17	808.39	790.95	630.97	472.81	671.38
38	399.02	442.56	447.41	642.85	500.35	696.19	900.35	760.27	1,179.01	1,216.59	1,152.12	645.24	813.84	794.48	642.39	475.33	684.76
39	406.07	448.42	455.13	672.15	510.60	705.17	919.19	773.94	1,179.98	1,217.69	1,162.59	657.35	815.17	827.83	654.11	485.07	697.60
40	413.42	455.90	456.23	685.30	511.73	737.76	920.80	775.33	1,180.95	1,218.83	1,211.92	661.04	816.28	829.13	662.96	486.14	711.82
41	420.75	458.73	460.78	697.08	521.47	741.03	938.51	802.61	1,181.92	1,220.07	1,291.55	678.62	859.11	831.70	664.48	495.39	726.33
42	427.51	468.82	480.56	706.21	523.66	745.10	956.37	818.60	1,199.34	1,221.24	1,312.67	689.33	878.52	869.33	686.08	497.48	740.15
43	432.98	477.51	489.17	720.32	524.80	790.65	974.08	820.41	1,207.40	1,302.40	1,360.51	700.60	915.50	881.35	697.66	498.56	766.02
44	439.31	484.82	493.04	729.87	534.10	834.43	992.23	856.52	1,208.37	1,335.34	1,365.31	711.24	927.69	899.12	707.67	507.40	771.76
45	445.94	490.71	499.90	741.07	535.92	855.46	1,010.11	922.79	1,209.34	1,339.42	1,371.51	722.55	929.36	917.74	718.96	509.12	793.53
46	451.11	501.45	514.67	752.69	571.94	862.75	1,032.38	929.41	1,210.31	1,421.13	1,495.55	730.06	962.89	925.95	726.43	543.35	808.23
47	457.72	506.47	523.27	765.80	575.55	869.88	1,045.67	980.32	1,211.29	1,483.51	1,508.02	741.97	966.28	938.80	738.71	546.77	824.92
48	463.91	515.78	530.12	777.24	576.70	896.24	1,063.53	985.42	1,223.32	1,489.77	1,509.28	753.24	967.25	953.97	748.19	547.87	841.65
49	469.08	520.94	535.95	788.30	598.64	898.91	1,080.82	1,001.33	1,233.36	1,559.22	1,510.37	765.15	968.22	955.21	761.24	568.70	858.22
50	475.85	528.49	536.92	789.34	600.86	901.03	1,097.22	1,004.43	1,254.34	1,566.18	1,511.47	775.98	970.38	956.52	772.09	570.82	875.33
52	487.71	538.84	539.90	821.41	642.05	945.76	1,140.21	1,066.84	1,415.37	1,571.25	1,562.85	789.60	1,047.83	964.58	785.75	609.94	883.96
54	495.21	545.43	566.95	839.05	649.53	966.33	1,161.82	1,073.47	1,424.91	1,574.65	1,568.47	803.29	1,093.19	1,013.75	796.98	617.06	912.70
56	505.24	555.89	577.32	865.23	676.15	984.16	1,203.64	1,076.68	1,491.37	1,650.34	1,581.35	828.34	1,108.25	1,050.15	823.13	642.34	939.89
58	515.84	566.20	588.48	891.43	702.77	993.93	1,246.34	1,079.87	1,533.88	1,737.82	1,594.21	853.40	1,123.31	1,086.42	850.94	667.63	970.00
60	531.22	578.84	591.46	920.84	706.18	1,066.46	1,299.66	1,085.00	1,561.51	1,793.96	1,675.33	886.40	1,243.56	1,169.93	882.49	670.88	999.29
62	541.28	589.58	608.93	931.90	746.88	1,082.46	1,342.19	1,130.03	1,564.69	1,800.74	1,679.37	909.62	1,247.47	1,192.90	918.67	709.53	1,029.55
64	551.36	598.33	611.93	972.49	751.34	1,085.83	1,385.34	1,192.76	1,567.90	1,804.13	1,712.41	932.84	1,250.77	1,230.94	938.52	713.77	1,062.36
66	558.69	608.08	621.97	997.23	757.14	1,089.21	1,418.86	1,197.31	1,644.94	1,807.51	1,715.92	956.05	1,312.23	1,243.63	957.06	719.28	1,090.89
68	570.30	618.39	645.45	1,022.82	808.37	1,148.54	1,429.89	1,270.38	1,777.23	1,810.49	1,868.20	979.24	1,315.61	1,253.76	985.06	767.95	1,129.11
70	581.29	629.82	655.04	1,047.09	811.80	1,164.88	1,502.29	1,285.14	1,790.07	1,836.05	1,884.69	1,002.42	1,318.59	1,289.00	1,008.61	771.21	1,158.71

Note: For additional information, refer to page 26.

Export

UPS Worldwide Saver®

Zones	481	482	484	401	402	403	404	405	406	407	408	409	411	412	413	420	421
72 Lbs.	\$587.19	\$633.40	\$658.40	\$1,069.47	\$842.99	\$1,215.75	\$1,541.11	\$1,358.38	\$1,793.05	\$1,877.74	\$1,930.26	\$1,009.66	\$1,372.51	\$1,308.84	\$1,017.11	\$800.84	\$1,190.66
74	595.16	648.63	661.38	1,093.42	846.52	1,260.12	1,570.60	1,366.98	1,798.38	1,949.78	1,976.90	1,046.95	1,406.56	1,341.45	1,029.47	804.19	1,223.55
76	611.35	658.81	664.36	1,096.60	908.35	1,271.80	1,577.57	1,463.54	1,926.84	2,013.12	1,980.25	1,070.12	1,445.76	1,376.06	1,076.48	862.93	1,253.70
78	616.96	667.39	686.02	1,127.37	914.83	1,276.05	1,617.94	1,466.75	1,930.19	2,021.59	1,993.14	1,093.33	1,449.74	1,459.86	1,099.97	869.09	1,286.25
80	624.15	675.72	692.35	1,146.12	920.55	1,338.49	1,632.34	1,494.83	1,951.45	2,030.87	2,011.04	1,116.49	1,452.72	1,487.84	1,125.74	874.52	1,308.71
82	630.62	684.02	714.29	1,178.09	923.96	1,341.87	1,635.51	1,498.03	1,954.43	2,034.37	2,048.79	1,119.67	1,456.72	1,501.82	1,129.17	877.76	1,314.61
84	636.38	692.20	721.34	1,203.46	987.10	1,345.24	1,714.64	1,501.22	1,957.41	2,070.40	2,051.77	1,122.86	1,534.09	1,504.80	1,137.17	937.74	1,346.86
86	643.42	698.32	724.91	1,222.17	994.02	1,348.22	1,744.13	1,529.36	1,960.39	2,088.82	2,174.47	1,176.85	1,539.13	1,507.78	1,179.91	944.32	1,373.76
88	650.61	710.75	728.29	1,245.85	997.75	1,387.93	1,773.44	1,532.56	1,963.37	2,137.65	2,254.51	1,179.83	1,631.74	1,510.76	1,199.68	947.86	1,404.43
90	657.81	717.01	745.71	1,254.53	1,012.57	1,445.17	1,802.64	1,616.07	1,966.35	2,140.63	2,317.53	1,210.98	1,648.79	1,513.74	1,219.57	961.94	1,436.79
92	664.72	724.72	754.94	1,271.73	1,034.11	1,454.00	1,832.28	1,619.05	1,969.33	2,154.66	2,324.21	1,229.12	1,651.95	1,516.72	1,239.31	982.41	1,468.52
94	671.91	732.78	757.92	1,298.37	1,050.30	1,550.54	1,854.50	1,707.94	1,972.31	2,285.77	2,327.59	1,251.20	1,733.93	1,519.70	1,253.68	997.78	1,497.12
96	677.31	738.67	760.90	1,308.88	1,080.09	1,582.92	1,874.54	1,721.90	1,975.29	2,471.18	2,445.97	1,275.55	1,745.00	1,577.34	1,279.02	1,026.08	1,522.81
98	680.42	741.93	764.19	1,311.93	1,102.72	1,585.90	1,883.61	1,724.88	1,978.27	2,554.23	2,459.72	1,278.53	1,747.98	1,586.85	1,287.87	1,047.59	1,550.02
100	690.20	748.36	767.48	1,315.07	1,170.68	1,589.34	1,886.75	1,818.04	2,117.09	2,634.07	2,862.25	1,281.82	1,750.96	1,590.13	1,299.66	1,112.15	1,555.60
105	721.94	782.54	803.19	1,377.00	1,235.27	1,671.95	1,968.93	1,891.83	2,222.95	2,765.77	3,002.53	1,345.92	1,824.66	1,674.75	1,363.49	1,173.51	1,616.65
110	756.31	819.80	841.25	1,442.56	1,294.08	1,750.64	2,062.69	1,981.91	2,328.80	2,897.47	3,145.37	1,410.00	1,911.56	1,754.51	1,427.31	1,229.38	1,629.66
115	790.70	857.06	878.72	1,508.14	1,352.90	1,829.88	2,156.45	2,071.99	2,434.66	3,029.17	3,285.23	1,474.09	1,998.45	1,834.25	1,490.89	1,285.26	1,681.18
120	825.07	894.33	916.88	1,573.70	1,411.72	1,909.44	2,250.22	2,162.08	2,540.50	3,160.88	3,424.79	1,538.19	2,085.33	1,914.00	1,554.34	1,341.14	1,748.31
125	859.45	931.58	954.12	1,639.28	1,470.54	1,988.24	2,343.97	2,252.17	2,646.36	3,292.58	3,564.12	1,602.26	2,172.22	1,993.75	1,618.91	1,397.01	1,815.89
130	892.56	968.84	991.56	1,704.85	1,529.37	2,066.84	2,437.72	2,342.25	2,752.21	3,424.28	3,706.54	1,666.36	2,259.10	2,073.50	1,683.59	1,452.90	1,864.92
135	926.87	1,006.11	1,029.51	1,770.41	1,588.19	2,146.15	2,531.49	2,432.34	2,858.07	3,555.99	3,845.60	1,730.45	2,345.99	2,153.25	1,755.95	1,508.78	1,912.43
140	961.06	1,043.37	1,067.57	1,835.99	1,647.01	2,223.66	2,625.24	2,522.43	2,963.93	3,687.69	3,987.89	1,794.53	2,432.89	2,232.99	1,820.94	1,564.66	1,975.17
145	994.59	1,080.63	1,105.66	1,901.56	1,705.83	2,301.98	2,719.00	2,612.51	3,069.77	3,819.39	4,126.52	1,858.63	2,519.77	2,312.74	1,885.94	1,620.54	2,038.57
150	1,028.60	1,117.89	1,143.71	1,967.13	1,764.65	2,391.44	2,812.76	2,702.59	3,175.63	3,951.09	4,268.69	1,922.73	2,606.65	2,392.50	1,950.95	1,676.42	2,101.57

Shipments of More Than 150 Pounds

Zones	481	482	484	401	402	403	404	405	406	407	408	409	411	412	413	420	421
Price Per Pound	\$6.86	\$7.46	\$7.63	\$13.12	\$11.77	\$15.95	\$18.76	\$18.02	\$21.18	\$26.35	\$28.46	\$12.82	\$17.38	\$15.95	\$13.01	\$11.18	\$14.02
Minimum Rate	1,028.60	1,117.89	1,143.71	1,967.13	1,764.65	2,391.44	2,812.76	2,702.59	3,175.63	3,951.09	4,268.69	1,922.73	2,606.65	2,392.50	1,950.95	1,676.42	2,101.57

Note: For additional information, refer to page [26](#).

Export

UPS Worldwide Expedited®

Guaranteed delivery by end of business day to more than 220 countries and territories. Delivery is guaranteed in two business days to Canada, three business days to Mexico, three to four business days to Europe and four to five business days to Asia and Latin America. Rates include door-to-door delivery with routine, in-house customs clearance by UPS Supply Chain Solutions.

Zones	71	72	74	601/631	602/632	603/633	604/634	605/635	606/636	607/637	608/638	609/639	611/641	612/642	613/643	620	621
1 Lbs.	\$86.91	\$93.49	\$82.27	\$103.96	\$89.08	\$117.04	\$114.42	\$109.05	\$135.65	\$126.30	\$114.42	\$96.60	\$113.55	\$111.22	\$97.22	\$85.58	\$94.49
2	93.46	102.72	91.52	121.44	102.35	136.74	140.68	127.48	162.18	158.09	148.08	109.79	126.54	129.22	115.23	98.85	116.39
3	100.65	112.04	104.70	142.02	114.27	153.80	158.95	144.51	183.09	189.32	167.73	131.41	149.95	146.09	131.34	110.77	130.06
4	107.37	122.04	110.44	160.51	126.08	169.65	175.20	163.59	213.72	236.00	214.35	147.62	158.87	160.78	148.22	122.58	145.61
5	122.43	141.24	128.31	190.32	137.74	201.16	200.36	188.61	235.01	266.10	242.79	177.73	179.79	181.29	174.65	134.24	157.52
6	126.81	144.80	134.78	202.73	153.86	213.78	217.26	206.34	274.84	299.24	281.92	191.69	197.74	197.51	188.44	150.36	188.79
7	131.77	150.39	150.11	213.43	164.73	229.95	239.02	224.48	297.26	332.20	295.22	196.06	218.73	221.32	192.29	161.23	196.37
8	137.83	155.47	162.47	218.59	168.99	250.37	255.85	241.76	338.34	341.79	329.86	204.16	239.55	229.79	197.59	165.49	224.69
9	139.10	163.06	163.24	225.95	177.06	256.74	273.48	255.26	365.41	376.27	378.76	207.58	258.25	242.44	222.63	173.56	239.31
10	143.33	165.79	166.30	228.05	180.46	260.42	274.34	256.03	370.66	377.04	379.82	220.88	266.83	260.00	224.70	176.96	254.48
11	146.66	168.15	185.30	230.38	187.22	262.72	277.83	259.89	385.48	377.81	390.36	224.72	274.61	263.97	227.97	183.72	259.07
12	148.20	170.98	186.07	232.41	192.63	266.31	283.16	262.35	392.45	382.77	394.41	225.49	281.11	264.74	231.97	189.13	273.27
13	159.70	196.08	196.55	261.64	203.88	300.44	352.37	306.79	457.28	417.57	429.72	250.78	298.31	315.12	273.92	200.38	297.88
14	165.16	202.19	197.39	280.73	210.77	330.45	375.13	334.98	488.22	479.16	509.45	252.97	343.45	326.58	277.55	207.27	311.64
15	170.60	212.82	203.48	286.40	225.16	335.40	391.10	355.43	500.15	541.06	510.22	269.58	391.55	334.05	281.30	221.66	313.90
16	178.58	217.61	206.01	312.81	236.03	350.91	415.80	385.03	520.32	556.88	510.99	287.71	400.98	360.10	284.98	232.53	334.04
17	179.97	218.48	216.46	314.25	241.82	358.47	426.42	390.21	544.94	569.66	511.76	302.17	407.35	374.90	291.73	238.32	355.78
18	184.71	223.59	221.16	319.06	251.57	364.62	429.80	401.09	581.42	593.14	560.95	304.15	420.93	380.41	315.84	248.07	366.76
19	189.40	229.10	242.12	320.18	259.96	381.12	453.74	423.43	602.65	620.79	572.15	320.21	428.08	392.83	329.02	256.46	378.47
20	194.12	234.57	249.43	325.48	268.40	383.17	455.72	424.82	604.63	656.24	606.07	331.45	428.86	421.17	329.29	264.90	390.84
21	214.48	254.21	250.20	339.99	278.16	386.94	463.44	426.49	629.54	697.11	681.97	340.26	429.64	423.23	329.31	274.66	403.41
22	219.56	254.98	251.38	340.76	286.74	387.71	464.31	427.26	641.71	700.76	690.57	341.03	430.42	425.13	349.00	283.24	414.94
23	224.03	256.32	257.44	341.53	292.41	388.51	466.44	428.03	642.48	715.88	698.74	341.80	431.19	426.06	355.57	288.91	419.40
24	232.70	257.15	265.82	346.90	295.36	394.94	469.38	430.25	648.07	716.65	699.51	342.57	438.10	429.04	358.04	291.86	426.58
25	233.47	261.68	266.62	349.22	299.05	405.13	473.48	434.89	651.81	723.56	721.81	349.32	442.30	433.30	359.31	295.55	444.17
26	257.06	288.41	277.14	448.24	318.81	518.32	582.78	521.64	713.45	797.52	747.83	429.18	550.65	523.16	408.66	315.31	461.26
27	262.16	313.86	277.99	459.78	332.17	540.27	611.61	531.91	732.26	812.54	822.36	457.22	595.26	553.11	416.87	328.67	461.40
28	271.97	316.19	285.60	471.70	333.04	551.20	636.85	583.63	744.36	857.94	823.13	457.99	616.53	556.65	418.86	329.54	478.09
29	276.10	317.17	293.50	481.73	337.10	565.58	667.78	604.29	782.91	916.86	841.03	464.63	619.05	620.88	447.70	333.60	494.63
30	276.97	329.12	303.41	482.60	342.42	578.78	673.36	605.94	789.09	921.35	841.95	465.40	619.88	621.94	475.67	338.92	506.66
31	282.43	330.34	307.28	492.84	353.79	597.27	706.73	621.03	839.75	922.22	857.42	472.44	633.71	634.61	485.19	350.29	522.34
32	288.54	343.53	308.05	493.61	367.00	598.14	709.23	627.09	856.80	923.10	858.26	489.45	636.69	635.49	511.39	363.50	536.69
33	294.64	349.71	308.82	494.38	373.91	605.67	721.69	634.58	864.17	942.91	859.09	491.03	671.13	654.79	519.77	370.41	543.36
34	300.75	350.60	311.76	495.70	379.83	607.43	735.46	636.15	865.79	955.95	859.92	534.02	694.93	656.72	520.24	376.33	550.48
35	306.89	356.04	312.60	496.59	386.72	614.50	755.20	637.20	868.03	959.17	860.74	543.94	708.09	658.97	523.21	383.22	564.76

Note: For additional information, refer to page 26.

Export

UPS Worldwide Expedited®

Zones	71	72	74	601/631	602/632	603/633	604/634	605/635	606/636	607/637	608/638	609/639	611/641	612/642	613/643	620	621
36 Lbs.	\$312.98	\$362.34	\$314.29	\$497.44	\$392.71	\$626.91	\$777.27	\$638.05	\$869.07	\$973.04	\$861.57	\$544.90	\$720.36	\$703.64	\$558.04	\$389.21	\$568.48
37	319.03	369.22	320.14	498.32	398.65	630.82	779.48	638.87	876.38	1,002.66	862.38	553.92	721.46	739.88	560.15	395.15	582.24
38	325.16	376.08	320.98	510.54	405.48	645.77	805.22	650.24	932.35	1,028.02	920.58	577.43	728.41	753.80	580.43	401.98	596.87
39	331.28	382.93	323.99	544.05	412.72	657.90	827.80	696.98	952.18	1,028.79	927.01	579.75	729.44	756.78	584.61	409.22	606.17
40	337.42	393.31	324.83	546.38	419.92	688.95	830.83	735.56	960.95	1,060.78	928.81	580.63	732.15	759.26	586.11	416.42	611.29
41	343.54	394.37	325.67	557.16	425.48	691.00	851.90	742.64	961.87	1,076.19	941.08	595.59	770.75	779.90	600.68	419.10	620.72
42	349.72	400.06	326.64	558.77	429.75	692.73	854.01	751.35	968.30	1,170.20	1,013.05	597.22	785.12	782.00	603.70	423.30	632.30
43	355.87	407.48	329.01	566.95	435.67	732.21	881.79	762.35	975.98	1,200.99	1,088.25	612.26	843.48	784.02	614.64	429.14	645.47
44	362.04	413.17	331.34	590.16	441.15	767.97	893.86	773.27	1,001.04	1,217.32	1,096.24	613.03	844.25	824.07	617.06	434.53	657.01
45	368.24	418.92	344.48	592.48	446.64	769.94	911.23	801.04	1,004.80	1,219.73	1,129.89	613.80	845.02	842.87	639.18	439.94	670.78
46	374.38	424.08	349.29	595.27	453.04	770.83	912.97	810.81	1,006.84	1,221.80	1,157.16	614.57	845.79	844.77	642.77	446.25	683.99
47	384.59	430.35	350.06	596.14	467.74	789.07	913.86	811.65	1,020.64	1,272.61	1,159.14	618.43	879.61	845.85	650.24	460.72	697.84
48	385.62	440.23	350.83	596.91	471.33	802.83	925.44	817.96	1,073.56	1,329.91	1,161.22	619.20	882.31	853.50	653.95	464.26	712.32
49	390.13	441.26	353.22	600.15	472.15	803.71	953.58	853.64	1,106.23	1,340.60	1,202.76	645.68	908.57	854.39	656.19	465.07	726.01
50	395.21	446.96	354.06	608.99	475.95	805.15	956.40	857.65	1,107.23	1,346.40	1,206.92	649.63	909.34	855.27	657.11	468.81	740.77
52	413.00	462.97	361.20	617.80	493.83	820.64	980.20	885.56	1,146.72	1,349.30	1,285.13	660.73	910.63	868.72	682.00	486.43	756.06
54	416.82	468.60	364.33	638.23	499.87	833.09	1,000.55	886.85	1,161.09	1,406.16	1,286.42	662.02	950.81	870.01	690.46	492.38	783.38
56	426.46	479.14	376.76	654.60	511.38	842.99	1,026.46	968.51	1,162.47	1,413.75	1,287.71	700.09	952.24	875.76	706.97	503.71	811.63
58	436.11	489.67	379.50	679.83	522.47	853.55	1,052.43	982.91	1,163.84	1,415.24	1,289.00	716.85	960.01	878.26	725.29	514.64	840.07
60	445.91	513.31	380.91	702.05	532.13	864.50	1,054.59	995.03	1,165.22	1,416.72	1,290.29	728.30	980.55	891.28	749.88	524.15	868.47
62	456.02	522.70	392.70	703.50	543.58	884.42	1,073.05	1,007.73	1,174.43	1,418.17	1,291.58	746.15	981.84	893.00	770.18	535.43	897.05
64	474.98	528.10	396.75	704.97	560.96	891.07	1,080.33	1,009.07	1,175.81	1,487.05	1,311.28	747.44	1,023.25	897.20	776.47	552.55	924.69
66	480.76	533.25	403.53	708.26	567.18	972.49	1,087.84	1,010.36	1,177.19	1,497.12	1,312.57	778.53	1,037.38	901.44	793.20	558.67	952.29
68	486.27	542.95	410.33	733.52	578.57	973.98	1,095.32	1,011.65	1,197.55	1,498.50	1,343.67	779.82	1,047.66	905.69	804.99	569.89	980.74
70	487.56	552.94	417.02	753.90	590.14	975.46	1,102.83	1,049.83	1,238.94	1,499.89	1,373.20	785.56	1,050.83	909.93	816.66	581.28	1,008.65
72	501.98	562.79	423.82	782.81	602.35	977.11	1,110.29	1,059.24	1,284.53	1,501.26	1,374.49	798.74	1,153.45	912.29	828.28	593.31	1,036.50
74	523.36	576.54	430.59	784.34	613.13	978.59	1,117.78	1,060.53	1,285.82	1,502.64	1,424.69	816.14	1,154.74	918.40	839.90	603.94	1,064.41
76	529.66	578.48	437.31	785.89	624.59	980.08	1,125.27	1,061.82	1,287.11	1,504.02	1,476.46	868.36	1,161.88	922.70	851.55	615.22	1,092.52
78	533.97	579.82	444.10	787.18	635.15	1,025.52	1,132.74	1,091.69	1,288.40	1,505.39	1,481.85	882.21	1,163.38	923.99	863.15	625.62	1,120.37
80	538.31	581.16	454.59	790.61	644.51	1,026.81	1,140.25	1,093.05	1,382.71	1,511.96	1,483.35	896.07	1,164.88	928.86	874.77	634.84	1,147.56
82	542.63	582.50	463.69	792.73	661.55	1,028.10	1,147.75	1,108.06	1,384.00	1,523.60	1,484.78	898.51	1,168.91	930.15	886.40	651.62	1,169.84
84	546.96	583.84	465.11	794.02	663.24	1,029.39	1,155.24	1,109.35	1,385.29	1,631.73	1,486.07	899.80	1,170.40	931.44	898.02	653.29	1,191.76
86	551.17	585.18	483.47	806.48	672.59	1,030.68	1,162.71	1,123.01	1,386.58	1,633.02	1,490.84	937.65	1,171.91	932.73	909.62	662.50	1,201.68
88	552.46	586.52	494.82	826.70	682.02	1,031.97	1,167.24	1,124.35	1,387.87	1,634.31	1,492.22	943.81	1,231.49	934.02	921.28	671.79	1,231.48
90	553.75	587.86	496.25	836.95	698.59	1,033.26	1,168.53	1,125.99	1,389.16	1,646.96	1,496.15	945.10	1,246.63	935.31	923.98	688.11	1,258.60

Note: For additional information, refer to page 26.

Export

UPS Worldwide Expedited[®]

Zones	71	72	74	601/631	602/632	603/633	604/634	605/635	606/636	607/637	608/638	609/639	611/641	612/642	613/643	620	621
92 Lbs.	\$559.40	\$589.19	\$501.04	\$849.33	\$700.71	\$1,034.55	\$1,169.82	\$1,139.00	\$1,390.45	\$1,658.96	\$1,580.49	\$946.39	\$1,252.86	\$936.60	\$933.10	\$690.20	\$1,285.64
94	562.77	590.53	502.63	862.29	713.69	1,035.84	1,171.11	1,140.29	1,391.74	1,660.37	1,592.70	947.68	1,254.23	937.89	933.90	702.99	1,312.55
96	564.56	591.87	513.51	869.15	719.47	1,037.13	1,172.40	1,141.75	1,393.03	1,661.89	1,595.23	953.96	1,255.54	939.18	938.13	708.68	1,327.19
98	565.97	593.21	530.68	870.51	728.90	1,038.42	1,178.65	1,144.62	1,394.32	1,663.34	1,596.52	955.26	1,256.91	940.47	940.57	717.97	1,329.00
100	567.37	594.55	575.09	876.23	806.33	1,039.71	1,180.03	1,159.57	1,418.06	1,748.74	1,662.47	956.57	1,358.61	941.76	959.58	794.24	1,389.62
105	593.78	608.89	590.67	909.09	829.25	1,080.65	1,238.06	1,217.49	1,531.95	1,818.78	1,738.84	1,047.90	1,413.73	976.75	978.57	814.33	1,436.21
110	622.07	637.89	618.79	952.27	868.74	1,132.11	1,297.01	1,275.29	1,604.90	1,905.38	1,821.64	1,097.81	1,481.05	1,023.26	1,025.28	853.10	1,446.65
115	650.34	666.89	646.91	995.64	908.23	1,183.57	1,355.97	1,323.65	1,677.85	1,991.99	1,904.44	1,147.69	1,548.38	1,069.78	1,073.76	891.88	1,508.07
120	678.62	695.87	675.04	1,038.80	947.71	1,235.03	1,414.92	1,378.78	1,750.80	2,078.59	1,987.24	1,197.60	1,615.69	1,116.28	1,119.25	930.65	1,568.66
125	706.89	724.87	703.17	1,082.17	987.20	1,286.49	1,473.88	1,449.39	1,823.75	2,165.19	2,070.04	1,247.50	1,683.02	1,162.80	1,163.96	969.43	1,617.43
130	735.17	753.87	731.30	1,125.33	1,026.69	1,337.95	1,532.83	1,473.51	1,896.70	2,251.81	2,152.86	1,297.40	1,750.34	1,209.31	1,212.95	1,008.21	1,666.23
135	763.45	782.85	759.42	1,168.71	1,066.18	1,389.41	1,591.79	1,513.95	1,969.65	2,338.42	2,235.66	1,347.29	1,764.24	1,255.83	1,257.69	1,046.99	1,712.08
140	791.72	811.85	787.55	1,211.86	1,105.67	1,440.87	1,650.74	1,559.54	2,042.60	2,425.03	2,318.45	1,397.20	1,820.63	1,302.33	1,303.14	1,085.77	1,770.59
145	820.00	840.85	815.68	1,254.82	1,145.15	1,490.20	1,709.70	1,571.38	2,115.55	2,511.63	2,401.25	1,447.09	1,882.40	1,348.85	1,352.34	1,124.53	1,828.14
150	848.27	869.85	843.80	1,295.94	1,184.65	1,543.77	1,768.64	1,580.99	2,188.50	2,598.23	2,484.05	1,497.00	1,943.96	1,395.36	1,396.70	1,163.32	1,884.89

Shipments of More Than 150 Pounds

Zones	71	72	74	601/631	602/632	603/633	604/634	605/635	606/636	607/637	608/638	609/639	611/641	612/642	613/643	620	621
Price Per Pound	\$5.66	\$5.80	\$5.63	\$8.64	\$7.90	\$10.30	\$11.80	\$10.54	\$14.59	\$17.33	\$16.57	\$9.98	\$12.96	\$9.31	\$9.32	\$7.76	\$12.57
Minimum Rate	848.27	869.85	843.80	1,295.94	1,184.65	1,543.77	1,768.64	1,580.99	2,188.50	2,598.23	2,484.05	1,497.00	1,943.96	1,395.36	1,396.70	1,163.32	1,884.89

Note: For additional information, refer to page [26](#).

Export

UPS® Standard to Canada*

Guaranteed delivery to all Canadian provinces by end of day within two to seven business days. Rates include door-to-door delivery. Customs clearance is not included. For rates, see [ups.com/cacustomsclearance](https://www.ups.com/cacustomsclearance). UPS will provide Customs Brokerage Services by UPS Supply Chain Solutions unless a different broker is specified. Customs Brokerage charges will be billed to the importer unless otherwise indicated by the shipper.

Zones	51	52	53	54	55	56
1 Lbs.	\$22.58	\$22.85	\$23.14	\$35.84	\$36.34	\$36.77
2	24.42	24.70	25.02	37.69	38.22	38.67
3	25.19	25.47	25.89	39.51	40.07	40.55
4	26.97	27.29	27.64	41.65	42.23	42.73
5	28.60	28.93	29.31	42.24	42.78	43.36
6	30.06	30.41	30.80	44.24	44.86	45.39
7	31.44	31.81	32.21	44.94	45.57	46.11
8	32.88	33.26	33.69	46.55	47.20	47.77
9	34.24	34.64	35.07	47.17	47.83	48.39
10	35.67	36.08	36.54	48.70	49.38	49.97
11	36.27	36.84	37.31	50.58	51.30	51.90
12	37.47	38.10	38.59	51.98	52.70	53.33
13	38.97	39.63	40.13	53.27	54.39	55.05
14	39.54	40.20	40.70	53.90	55.01	55.66
15	40.10	40.77	41.43	54.65	55.56	56.21
16	41.43	42.13	42.83	56.54	57.33	58.28
17	42.53	43.24	43.90	58.13	58.94	60.02
18	44.06	44.79	45.40	59.86	60.71	61.65
19	45.44	46.19	46.82	61.60	62.46	63.53
20	46.56	47.33	48.11	63.28	64.17	65.17
21	47.94	48.48	49.61	65.00	65.93	66.72
22	49.37	49.95	51.10	66.90	67.84	68.72
23	50.58	51.18	52.18	68.57	69.53	70.36
24	51.89	52.50	53.42	70.22	71.22	72.09
25	52.90	53.52	54.34	71.91	72.93	73.79
26	54.15	54.77	55.68	73.91	74.95	75.84
27	55.67	56.32	57.17	75.71	76.78	77.68
28	57.00	57.67	58.53	77.59	78.67	79.61
29	58.33	59.00	59.97	79.38	80.51	81.45
30	59.64	60.34	61.44	81.19	82.34	83.32
31	60.59	61.48	62.86	82.99	84.32	85.31
32	61.90	62.80	64.15	84.83	86.20	87.22
33	63.43	64.37	65.65	86.65	88.04	89.09
34	64.63	65.57	66.85	88.46	89.87	90.94
35	65.88	66.84	68.58	89.64	91.09	92.70

*Visit [ups.com/holidays](https://www.ups.com/holidays) for time in transit changes effective during the holiday season.

Notes:

- For additional information, refer to pages 26 and 76.
- For a multiple-package shipment, the minimum charge will be based on an average weight of 15 pounds per package.

Export

UPS® Standard to Canada*

Zones	51	52	53	54	55	56
36 Lbs.	\$67.07	\$68.04	\$69.40	\$91.72	\$93.21	\$94.30
37	68.59	69.60	70.95	93.58	95.08	96.21
38	69.83	70.86	72.42	95.19	96.71	97.99
39	71.42	72.47	73.78	96.72	98.26	99.43
40	72.62	73.68	75.22	98.57	100.17	101.36
41	73.88	74.97	76.42	100.25	101.86	103.07
42	75.06	76.16	77.69	101.73	103.38	104.59
43	76.46	77.58	79.11	103.46	105.13	106.37
44	77.43	78.57	80.03	104.79	106.48	107.74
45	78.89	80.05	81.52	106.74	108.45	109.74
46	80.16	81.34	83.00	108.26	110.01	111.31
47	81.40	82.59	84.28	109.93	111.69	113.03
48	82.47	83.67	85.44	111.59	113.39	114.72
49	83.85	85.07	86.62	113.13	114.96	116.33
50	85.24	86.47	88.11	114.94	116.78	118.17
52	87.83	89.12	90.72	117.35	119.23	121.78
54	90.27	91.60	93.25	119.61	121.54	124.34
56	92.38	93.73	95.43	122.08	124.13	127.86
58	98.69	102.02	104.65	124.56	127.43	131.19
60	100.73	103.36	105.69	126.75	129.69	133.80
62	101.88	104.40	106.73	129.50	132.52	137.26
64	102.92	105.43	107.76	131.90	134.08	139.19
66	103.96	106.47	108.80	134.05	137.00	142.25
68	105.00	107.50	109.83	136.45	138.63	145.56
70	106.04	108.53	110.87	139.19	141.44	147.90
72	107.07	109.56	111.90	142.37	143.73	152.77
74	108.11	110.60	112.94	145.06	146.44	156.86
76	109.15	111.63	113.97	148.43	149.84	160.97
78	110.19	112.67	115.01	149.48	150.99	163.79
80	111.23	113.70	116.04	152.84	154.30	167.73
82	112.27	114.74	117.08	155.67	157.15	171.00
84	113.31	115.77	118.11	158.44	159.94	174.20
86	114.35	116.81	119.15	161.99	163.53	177.29
88	115.39	117.85	120.19	164.67	166.23	180.61
90	116.42	118.88	121.22	167.29	168.89	183.64

*Visit [ups.com/holidays](https://www.ups.com/holidays) for time in transit changes effective during the holiday season.

Note: For additional information, refer to pages [26](#) and [76](#).

Export

UPS® Standard to Canada*

Zones	51	52	53	54	55	56
92 Lbs.	\$117.46	\$119.92	\$122.26	\$170.43	\$172.06	\$186.97
94	118.50	120.95	123.29	173.12	174.78	190.00
96	119.54	121.99	125.02	176.03	177.71	193.13
98	120.58	123.02	127.55	179.11	180.82	196.11
100	121.62	124.06	130.15	181.66	183.40	199.43
105	122.66	125.09	132.72	182.71	185.29	205.12
110	123.66	126.63	137.48	186.06	193.20	213.26
115	124.66	132.04	143.08	193.38	201.39	222.00
120	127.75	136.28	149.52	200.70	209.19	230.52
125	130.73	141.47	155.13	208.03	217.26	238.87
130	133.42	145.13	161.28	215.42	224.29	246.25
135	136.30	149.27	167.11	221.30	229.11	253.06
140	139.12	152.55	172.09	228.39	236.12	261.09
145	141.79	156.23	176.83	238.39	242.65	266.75
150	144.71	159.55	181.79	243.29	247.67	270.19

Shipments of More Than 150 Pounds

Zones	51	52	53	54	55	56
Shipments of 151 to 199 Pounds						
Price Per Pound	\$0.97	\$1.07	\$1.22	\$1.63	\$1.66	\$1.81
Minimum Rate	144.71	159.55	181.79	243.29	247.67	270.19
Shipments of 200 to 499 Pounds						
Price Per Pound	\$0.96	\$1.02	\$1.15	\$1.53	\$1.60	\$1.74
Minimum Rate	193.03	212.93	242.78	324.37	330.34	360.19
Shipments of 500 Pounds or More						
Price Per Pound	\$0.81	\$0.96	\$1.12	\$1.42	\$1.49	\$1.69
Minimum Rate	479.04	508.98	573.85	763.47	798.40	868.26

*Visit [ups.com/holidays](https://www.ups.com/holidays) for time in transit changes effective during the holiday season.

Note: For additional information, refer to pages [26](#) and [76](#).

Export

UPS® Standard to Mexico*

Guaranteed delivery to all of Mexico by end of day within four to eight business days. Rates include routine, in-house, customs clearance. Customs clearance by UPS Supply Chain Solutions is required.**

Zones	32	33	34	35	36	37	38
1 Lbs.	\$54.98	\$55.40	\$56.68	\$57.17	\$57.65	\$57.90	\$58.03
2	58.65	59.72	60.22	61.12	61.23	61.64	61.74
3	62.85	64.44	64.77	65.17	65.28	66.28	66.35
4	66.20	66.52	66.94	67.34	67.64	69.66	69.85
5	66.53	68.04	68.49	69.67	70.64	72.14	72.26
6	70.65	70.85	71.24	72.55	75.02	75.03	75.04
7	72.17	72.42	72.88	74.12	75.08	76.99	77.21
8	72.37	73.91	74.16	75.62	76.68	81.36	81.70
9	75.00	76.69	76.78	77.24	79.24	82.48	84.68
10	76.99	78.63	78.75	79.23	81.16	84.34	86.60
11	80.62	80.78	81.02	82.67	84.99	88.29	90.48
12	81.42	83.19	83.33	83.73	85.65	88.70	91.00
13	83.60	85.36	85.57	86.00	87.87	90.91	93.23
14	87.38	87.60	87.87	88.16	89.98	94.95	95.72
15	87.91	89.96	90.18	91.63	92.75	96.02	98.87
16	88.43	90.57	90.95	92.23	93.77	99.11	100.21
17	90.58	92.89	93.18	94.71	96.69	101.31	103.33
18	91.46	94.17	94.41	95.22	98.23	101.90	105.27
19	91.67	94.48	94.89	95.71	98.50	102.23	105.83
20	92.55	94.65	95.06	99.03	100.23	104.02	107.92
21	97.65	99.18	99.49	99.70	103.34	107.28	111.32
22	100.61	102.30	102.79	105.38	106.63	110.81	115.13
23	103.04	104.82	105.35	108.06	109.63	113.79	118.36
24	105.53	107.23	108.10	110.85	112.47	117.00	121.64
25	105.75	107.65	108.43	113.26	115.02	119.54	124.67
26	110.17	112.30	113.16	115.68	117.43	124.31	127.78
27	112.21	114.40	114.95	115.91	119.92	124.97	130.56
28	113.56	116.57	117.62	120.35	126.04	128.88	133.57
29	113.73	117.64	119.61	120.50	126.44	130.11	136.86
30	114.07	118.26	120.37	120.80	127.06	130.72	137.72
31	114.27	118.71	120.43	120.95	127.38	131.23	138.11
32	114.88	118.85	121.27	121.81	127.97	133.45	140.48
33	116.98	121.25	123.72	125.89	130.72	136.26	143.61
34	118.70	121.41	125.67	126.59	132.96	138.65	146.28
35	120.70	126.03	127.81	128.76	135.34	141.20	149.02

*Visit [ups.com/holidays](https://www.ups.com/holidays) for time in transit changes effective during the holiday season.

**In cases where the shipment cannot be imported, the shipment will be automatically returned to the exporter.

Notes:

- For additional information, refer to pages [26](#) and [76](#).
- For a multiple-package shipment, the minimum charge will be based on an average weight of 15 pounds per package.

Export

UPS® Standard to Mexico*

Zones	32	33	34	35	36	37	38
36 Lbs.	\$122.79	\$128.13	\$130.30	\$133.73	\$137.91	\$143.87	\$151.94
37	128.58	131.58	133.96	137.22	140.85	146.36	153.66
38	132.12	135.10	137.44	139.74	144.36	149.88	157.21
39	133.41	136.66	138.08	140.25	146.64	152.15	159.44
40	133.63	137.58	138.75	142.13	148.29	153.89	161.24
41	135.92	141.85	143.97	144.37	150.73	156.37	163.74
42	138.19	143.36	144.36	146.61	152.96	158.56	165.70
43	139.50	143.76	144.76	150.79	154.31	159.86	167.12
44	141.62	145.54	148.59	151.85	155.11	160.71	168.05
45	142.49	146.78	148.96	152.24	155.60	161.21	168.57
46	144.86	146.96	150.07	152.40	156.63	162.27	169.49
47	147.06	150.03	152.42	152.72	158.89	164.50	171.72
48	147.20	151.42	153.62	154.90	161.09	166.72	173.98
49	148.82	151.79	154.00	156.97	163.23	168.78	176.00
50	150.42	153.38	155.64	158.68	164.79	170.43	177.61
52	153.89	156.39	159.81	161.72	168.61	173.18	180.39
54	158.72	161.80	165.71	167.22	173.97	175.73	181.04
56	163.15	165.31	170.52	171.12	179.23	179.94	186.71
58	164.79	167.23	171.47	173.17	181.76	184.25	191.01
60	168.48	171.16	173.70	177.20	182.59	188.20	195.04
62	172.06	174.87	177.35	180.79	187.83	191.78	198.61
64	178.18	180.49	181.17	184.47	190.81	198.27	204.26
66	178.56	181.27	183.98	188.02	191.46	201.72	207.73
68	181.83	184.73	187.44	191.45	194.76	204.99	211.15
70	185.58	188.23	193.01	195.03	198.19	208.56	214.58
72	189.11	191.73	194.70	198.45	201.75	211.99	217.89
74	193.65	198.86	199.42	202.00	204.95	215.43	221.30
76	194.60	199.30	200.17	205.27	208.32	220.02	225.18
78	196.65	199.40	206.66	208.84	213.43	222.05	227.25
80	198.34	201.09	207.77	209.29	215.27	223.86	229.10

*Visit [ups.com/holidays](https://www.ups.com/holidays) for time in transit changes effective during the holiday season.

Note: For additional information, refer to pages [26](#) and [76](#).

Export

UPS® Standard to Mexico*

Zones	32	33	34	35	36	37	38
82 Lbs.	\$200.59	\$203.20	\$208.73	\$211.23	\$217.16	\$225.79	\$230.87
84	203.86	206.60	209.18	214.52	220.41	228.79	234.02
86	207.30	213.16	215.26	218.70	223.66	232.16	237.24
88	210.50	213.32	215.85	220.80	226.74	235.18	240.21
90	213.79	216.56	219.20	224.04	229.92	238.70	243.30
92	216.26	224.25	224.51	226.59	232.21	241.02	245.80
94	219.89	225.48	227.91	229.76	235.35	244.10	248.89
96	222.86	225.78	228.32	232.33	237.67	246.41	251.18
98	225.83	227.83	230.95	234.70	239.89	248.56	253.58
100	229.30	230.68	234.23	237.49	242.65	251.36	256.43
105	238.03	239.74	242.78	245.89	250.84	259.47	264.46
110	247.55	248.95	251.31	254.28	259.17	268.00	273.26
115	254.64	256.21	258.82	261.41	266.44	275.37	280.62
120	261.95	263.62	266.17	268.46	273.78	282.88	288.23
125	269.48	270.96	273.78	275.59	280.90	290.03	295.47
130	276.75	278.54	281.33	282.92	288.06	297.35	302.81
135	284.04	286.24	289.07	290.06	295.28	304.51	309.86
140	291.57	294.10	296.91	297.71	302.79	311.71	317.34
145	299.60	302.36	305.40	305.59	310.59	319.48	325.27
150	307.38	310.72	313.81	314.89	318.56	327.27	333.11

Shipments of More Than 150 Pounds

Zones	32	33	34	35	36	37	38
Shipments of 151 to 199 Pounds							
Price Per Pound	\$2.05	\$2.08	\$2.10	\$2.10	\$2.13	\$2.19	\$2.23
Minimum Rate	307.38	310.72	313.81	314.89	318.56	327.27	333.11
Shipments of 200 Pounds or More							
Price Per Pound	\$1.99	\$2.02	\$2.04	\$2.04	\$2.07	\$2.12	\$2.16
Minimum Rate	407.95	413.92	417.90	417.90	423.87	435.81	443.77

*Visit [ups.com/holidays](https://www.ups.com/holidays) for time in transit changes effective during the holiday season.

Note: For additional information, refer to pages [26](#) and [76](#).

Import Shipment Pricing

UPS Worldwide Express Plus®, UPS Worldwide Express NA1®, UPS Worldwide Express®, UPS Worldwide Express Freight® Midday, UPS Worldwide Express Freight®, UPS Worldwide Saver®, UPS Worldwide Expedited®, UPS 3 Day Select® from Canada and UPS® Standard

Shipment pricing is advantageous because rates are based on the total weight of a shipment, not the sum of the rates for each package in a shipment.

What Qualifies

1. The shipment consists of multiple packages, using the same service, shipped on the same day to a single consignee.
2. For shipments processed with WorldShip® or UPS CampusShip® shipping systems, [ups.com](https://www.ups.com) shipping, the UPS® Developer Kit or a UPS Ready® solution that supports full international service or a UPS Worldwide Services Waybill. **Note:** For shipments processed with UPS Developer Kit – Shipping API, in order to obtain the best rate, customers are responsible for aggregating shipments for shipment pricing prior to requesting labels (UPS Developer Kit – Shipping API does not run End of Day).

What Does Not Qualify

Shipment pricing does not apply to UPS Express® Envelopes, the UPS® 10 KG Box or the UPS® 25 KG Box; they are each considered separate shipments.

Rates

Rates are based on the total billable weight of all packages in the shipment. Compare each package's actual weight to its dimensional weight. The greater of the two is the billable weight and should be used to calculate the rate. For multiple-package shipments, total the billable weight of all packages in the shipment. Refer to pages [16-17](#) for instructions on calculating dimensional weight.

If the payer of the shipping charges is located in the origin country, the shipment will be charged the export rate (Origin Country Export Rates). When

the payer of the shipping charges is located in the destination country, the shipment will be charged the import rate (Destination Country Import Rates). If the destination country does not have import rates, the shipment will be charged the export rate (Origin Country Export Rates). When the payer of the shipping charges is located in a third country (neither origin nor destination country), the shipment will be charged the Origin Country Export Rates, except as otherwise agreed to by UPS and the contracting party.

Unless otherwise specified at the time of shipping, shipping charges are billed to the shipper. In the event of non-payment by consignee or third party, the charges are billed to the shipper. Refer to page [114](#) for more information on billing options.

For shipments weighing 150 pounds or less, locate the rate for the total weight of the shipment on the appropriate rate chart.

To determine the rate for a shipment weighing more than 150 pounds, multiply the total weight (rounded to the next whole pound) by the appropriate price per pound as shown under the shipment weight designations above 150 pounds. The amount billed will be the result of this calculation or the minimum rate shown, whichever is greater.

For a multiple-package UPS Standard shipment, the minimum charge will be based on an average weight of 15 pounds per package.

All rates for UPS international services, except UPS® Standard from Canada, include routine, in-house, customs brokerage. For more information on customs brokerage for import shipments, refer to pages [134-136](#).

Useful Information – International Shipping

Import/Export Support Information on international shipping and trade	Visit ups.com/international
Shipping Forms Import/export documents	Visit ups.com/intl_forms
UPS Paperless® Invoice Send Commercial Invoices and other customs documents electronically, saving time and paper	Visit ups.com/paperlessinvoice
UPS TradeAbility® Services Harmonizer, landed cost and compliance tools	Visit ups.com/tradeability
International Customer Service Assistance with international shipments	Call 1-800-782-7892
UPS Import Control® Services Take control of your imports	Visit UPS Import Control®

Import

UPS Worldwide Express®

UPS Worldwide Express Plus®

Guaranteed delivery as early as 8:00 a.m. or 8:30 a.m. on the next business day from Canada and one to two business days from Asia, Europe and Latin America. Delivery from all valid UPS origins. Rates include door-to-door delivery with routine, in-house customs clearance by UPS Supply Chain Solutions® Add \$40.00 to the appropriate UPS Worldwide Express rate for each UPS Worldwide Express Plus shipment.

UPS Worldwide Express NA1®

Overnight delivery to the U.S., Canada and Latin America from select cities in Germany, the United Kingdom and the Netherlands. Guaranteed delivery by 10:30 a.m. or 12 p.m. where UPS Worldwide Express service is available or end of day if UPS Worldwide Saver® is the only available service to the destination postal code. UPS Worldwide Express rates apply, which include door-to-door delivery with routine, in-house customs clearance by UPS Supply Chain Solutions. Service requires an early pickup at origin.

UPS Worldwide Express

Guaranteed delivery as early as 10:30 a.m., 12:00 p.m. or 2:00 p.m. from all valid UPS origins. Delivery is guaranteed on the next business day from Canada and Mexico and one to two business days from Asia, Europe and Latin America. Rates include door-to-door delivery with routine, in-house customs clearance by UPS Supply Chain Solutions.

Letter/Document

Zones	91	94	951	952	953	954	955	956	957	958	959	961	962	963	970	971
Letter*	\$56.32	\$56.52	\$97.48	\$82.31	\$104.80	\$78.98	\$113.42	\$79.44	\$97.20	\$106.53	\$81.44	\$91.04	\$70.61	\$81.44	\$77.44	\$74.58
1 Lbs.	82.11	60.73	113.49	91.62	135.21	99.49	133.39	90.46	122.64	133.92	102.96	99.10	87.95	103.07	89.61	89.44
2	83.65	61.37	116.32	94.47	137.51	105.54	168.73	114.11	146.71	169.24	107.86	120.80	96.48	115.83	92.09	112.83
3	113.57	85.77	172.47	146.95	200.82	157.70	279.46	167.08	212.19	266.36	162.72	165.27	156.38	162.72	137.20	147.61
4	124.84	92.81	194.47	161.83	222.76	178.03	322.03	192.02	236.97	320.16	184.33	187.76	180.35	184.33	155.67	169.50
5	136.20	100.39	217.36	176.72	244.70	198.89	364.57	220.06	269.85	349.87	201.20	218.73	198.12	201.20	167.77	190.78
6	150.89	106.85	234.81	193.80	270.20	217.48	405.29	244.06	294.43	390.74	217.88	236.93	219.39	217.88	185.93	206.44
7	158.20	115.00	249.55	208.50	291.34	236.31	447.15	265.32	320.66	437.18	236.37	261.01	240.12	236.37	201.03	226.30
8	169.18	118.72	265.58	222.94	310.00	255.98	496.06	289.60	346.21	483.95	255.34	278.19	259.42	255.34	213.97	242.30
9	179.67	124.66	277.71	237.43	331.65	275.68	527.44	311.24	368.21	525.60	275.14	299.97	279.08	275.14	228.08	262.01
10	190.46	129.24	285.60	251.91	351.54	283.05	548.94	323.52	394.85	571.04	284.40	316.89	292.04	284.40	242.14	265.93

Non-document

Zones	91	94	951	952	953	954	955	956	957	958	959	961	962	963	970	971
1 Lbs.	\$95.78	\$71.02	\$163.23	\$114.60	\$176.53	\$133.73	\$200.79	\$126.26	\$169.58	\$189.30	\$135.39	\$146.63	\$125.03	\$135.39	\$106.73	\$114.04
2	108.41	79.60	186.25	137.34	201.81	156.75	240.26	151.47	197.67	227.94	154.49	171.93	144.23	155.74	128.37	132.28
3	120.87	88.96	204.39	153.38	222.68	181.17	291.32	174.09	236.41	283.02	180.04	194.14	163.93	180.04	143.14	151.10
4	132.58	96.24	228.83	169.22	255.27	207.15	335.91	200.27	272.28	326.17	198.64	216.21	183.28	198.64	158.18	171.00
5	144.30	104.11	248.29	185.34	275.74	228.53	380.29	227.46	299.85	362.47	216.89	238.48	201.25	216.89	172.93	193.67
6	156.53	110.82	264.47	199.16	293.39	251.71	422.74	251.57	324.64	402.93	235.12	256.20	221.89	235.12	190.48	209.77
7	164.02	118.72	279.30	214.40	311.06	275.03	466.41	276.57	349.43	453.28	250.43	275.21	242.40	250.43	201.14	229.36
8	175.11	123.13	293.88	230.12	335.01	297.58	517.42	298.52	375.05	493.08	267.37	303.09	262.88	267.37	215.29	245.71
9	185.96	129.27	306.99	244.27	356.54	317.51	550.16	321.03	399.75	539.81	287.07	322.16	283.41	287.07	231.61	265.30
10	197.49	133.62	313.62	259.58	379.25	319.70	563.26	333.52	426.98	592.08	296.37	334.50	301.28	296.37	243.52	269.24

*The Letter rate applies only to documents, correspondence and electronic media shipments of no commercial value that do not exceed eight ounces sent in a UPS Express® Envelope.

Note: For additional information, refer to page 26.

Import

UPS Worldwide Express®

Non-document

Zones	91	94	951	952	953	954	955	956	957	958	959	961	962	963	970	971
11 Lbs.	\$208.83	\$137.15	\$314.29	\$261.51	\$388.63	\$322.00	\$574.83	\$336.57	\$450.22	\$593.76	\$297.04	\$346.60	\$302.86	\$297.04	\$245.18	\$272.71
12	213.75	137.45	316.72	263.45	393.24	330.38	581.83	339.40	465.49	602.52	299.94	349.72	313.16	304.32	253.50	274.88
13	224.89	156.01	363.49	302.20	452.29	389.99	700.19	394.07	500.34	689.21	350.57	393.04	361.85	350.57	283.00	311.12
14	237.42	162.57	376.99	316.27	463.80	411.43	733.72	410.99	524.21	707.04	371.88	410.44	388.95	371.88	292.87	329.87
15	245.67	166.17	389.10	330.35	482.77	433.92	766.51	435.48	547.55	741.00	387.04	429.53	409.03	387.04	308.77	346.02
16	252.54	174.08	402.63	343.85	502.55	448.12	795.25	450.11	574.07	783.43	398.70	436.91	434.01	398.70	321.35	366.11
17	261.46	179.65	414.77	357.29	522.36	468.00	826.57	457.43	597.40	808.56	414.17	452.98	440.21	414.17	334.03	379.38
18	268.88	188.23	426.92	370.79	542.16	484.52	853.14	474.97	619.65	837.17	421.93	472.08	472.93	421.93	343.30	397.44
19	276.59	189.71	439.08	384.28	574.88	502.72	888.64	487.21	643.55	862.22	439.02	486.84	492.96	439.02	355.60	412.21
20	285.08	193.65	449.61	397.76	581.77	516.09	911.06	499.44	660.60	871.18	447.62	504.15	514.88	447.62	368.16	428.37
21	290.49	199.13	457.05	411.10	615.41	521.20	911.46	505.36	689.13	919.29	456.82	506.61	532.46	456.82	383.87	435.13
22	297.62	203.19	460.89	421.70	621.38	521.66	913.04	508.91	712.18	933.59	457.09	509.10	539.06	457.09	393.88	436.83
23	304.67	203.59	461.14	422.30	635.45	522.22	916.23	513.27	729.66	934.16	479.67	519.85	539.40	479.67	394.32	448.08
24	308.78	203.84	461.39	423.01	636.86	525.39	916.58	513.78	752.31	934.78	479.94	521.71	541.62	479.94	404.37	460.85
25	310.44	205.77	464.35	425.35	641.96	539.74	923.49	517.21	762.03	956.07	483.60	525.38	554.33	485.41	406.15	463.37
26	323.54	229.83	521.07	468.15	697.46	622.65	1,061.67	563.59	799.30	1,026.59	516.97	589.20	618.28	516.97	437.13	497.25
27	328.94	240.69	534.89	489.31	716.50	669.49	1,084.90	599.63	820.82	1,062.62	527.70	606.43	640.81	527.70	457.39	530.07
28	336.08	247.07	546.77	502.23	752.44	675.32	1,108.10	613.49	841.38	1,071.45	538.35	619.16	656.90	538.35	469.42	542.80
29	342.43	253.48	556.62	515.11	771.81	693.30	1,140.91	635.13	859.95	1,118.81	554.74	633.08	680.62	554.74	481.32	555.56
30	349.05	255.04	568.44	528.04	773.76	704.96	1,162.76	648.40	878.12	1,136.39	566.81	646.26	691.55	566.81	493.35	567.76
31	355.55	262.81	580.23	539.78	786.26	720.52	1,182.77	654.94	894.15	1,142.10	578.69	660.59	694.39	578.69	504.44	579.41
32	361.82	268.59	589.93	551.53	817.29	727.33	1,208.87	677.67	907.90	1,143.88	584.22	677.10	721.23	584.22	515.43	591.63
33	367.06	270.74	597.47	553.39	822.71	762.84	1,231.92	690.37	921.37	1,179.09	595.23	688.13	731.77	595.23	517.15	601.50
34	372.36	275.96	607.15	574.34	824.32	766.84	1,247.21	694.51	933.80	1,211.22	607.75	699.00	753.77	607.75	536.76	613.57
35	377.59	284.11	618.16	579.16	856.26	787.26	1,270.37	707.80	944.77	1,256.20	616.59	707.85	776.59	616.59	541.13	623.44
36	382.85	288.89	628.61	598.49	865.78	811.56	1,293.56	721.16	955.84	1,262.45	621.68	725.93	793.08	621.68	559.33	637.16
37	388.96	294.81	638.45	610.24	866.77	829.26	1,319.51	734.44	966.54	1,269.16	632.56	738.67	795.47	632.56	570.32	649.63
38	389.58	300.32	648.20	621.54	885.88	854.52	1,339.92	749.20	978.41	1,290.35	661.35	752.73	810.33	661.35	580.76	660.47
39	398.60	305.70	657.87	625.61	887.80	872.84	1,368.65	762.55	989.63	1,308.22	685.89	772.29	832.99	685.89	584.62	672.14
40	403.84	310.89	667.57	634.11	900.49	890.38	1,390.82	782.01	1,000.46	1,340.46	696.88	786.48	840.01	696.88	592.62	683.52
41	408.60	313.77	677.06	656.37	932.82	908.28	1,411.19	795.43	1,021.71	1,362.92	713.05	796.25	858.12	713.05	612.87	694.61
42	413.41	321.62	686.49	668.43	944.52	921.43	1,433.39	814.24	1,032.66	1,389.31	728.71	808.07	869.74	728.71	624.67	706.16
43	421.67	327.11	695.93	669.28	952.69	961.19	1,456.34	823.04	1,044.94	1,405.87	737.01	821.49	884.59	737.01	624.94	717.68
44	423.04	332.33	705.36	688.48	953.50	970.42	1,475.52	835.74	1,055.48	1,414.43	762.17	834.61	887.21	762.17	643.81	728.35
45	427.88	338.26	714.88	690.05	957.56	971.74	1,500.81	840.41	1,067.50	1,442.68	767.81	848.37	939.49	767.81	644.32	740.02
46	432.69	343.33	724.32	701.69	987.59	997.87	1,531.12	862.97	1,088.09	1,490.79	768.30	855.62	946.22	768.30	657.96	749.88
47	437.52	348.84	731.10	725.72	994.06	1,010.57	1,560.23	866.85	1,100.37	1,495.60	768.63	868.42	947.44	768.63	682.78	760.32
48	442.32	350.10	743.21	731.55	995.43	1,039.71	1,582.62	880.08	1,111.98	1,497.83	769.45	893.16	971.25	769.45	684.44	772.51
49	444.60	358.16	744.41	747.30	1,022.71	1,051.65	1,606.00	893.28	1,122.82	1,542.25	785.52	895.53	973.64	785.52	694.46	781.84
50	445.20	363.10	745.63	753.01	1,025.44	1,069.53	1,627.05	906.51	1,135.11	1,614.22	797.29	910.97	988.52	797.29	696.41	793.76

Note: For additional information, refer to page [26](#).

Import

UPS Worldwide Express Freight® Midday

Guaranteed delivery by 12:00 p.m. or 2:00 p.m. from 81 countries and territories. Delivery is guaranteed on the next business day to Canada, the second business day to Europe and Latin America, and within two to three business days to Asia. Rates include door-to-door and non door-to-door delivery with routine, in-house customs clearance by UPS Supply Chain Solutions® for palletized shipments of more than 150 pounds.

Door-to-Door

Zones	491	494	451	452	453	454	455
151-999 Lbs. (Price per Lb.)	\$7.87	\$8.20	\$14.44	\$15.10	\$17.77	\$19.73	\$28.75
1,000 Lbs. or More (Price per Lb.)	7.48	7.90	13.91	14.54	17.12	18.99	27.03
Minimum Rate	1,188.37	1,238.20	2,180.44	2,280.10	2,683.27	2,979.23	4,341.25

Zones	456	457	458	459	461	462	463	470	471
151-999 Lbs. (Price per Lb.)	\$16.05	\$18.87	\$29.21	\$16.75	\$17.84	\$19.90	\$16.75	\$14.13	\$15.11
1,000 Lbs. or More (Price per Lb.)	15.61	17.39	27.51	16.10	17.32	18.89	16.14	13.58	14.52
Minimum Rate	2,423.55	2,849.37	4,410.71	2,529.25	2,693.84	3,004.90	2,529.25	2,133.63	2,281.61

Non Door-to-Door: Drop-off, Hold at Location, Drop-off and Hold at Location

Zones	491	494	451	452	453	454	455
151-999 Lbs. (Price per Lb.)	\$7.55	\$7.61	\$13.50	\$13.72	\$16.92	\$18.34	\$26.84
1,000 Lbs. or More (Price per Lb.)	7.17	7.32	13.00	13.20	16.30	17.63	25.22
Minimum Rate	1,140.05	1,149.11	2,038.50	2,071.72	2,554.92	2,769.34	4,052.84

Zones	456	457	458	459	461	462	463	470	471
151-999 Lbs. (Price per Lb.)	\$14.89	\$18.01	\$27.30	\$15.64	\$16.16	\$18.43	\$16.00	\$12.81	\$13.95
1,000 Lbs. or More (Price per Lb.)	14.48	16.56	25.70	15.03	15.68	17.47	15.41	12.31	13.39
Minimum Rate	2,248.39	2,719.51	4,122.30	2,361.64	2,440.16	2,782.93	2,416.00	1,934.31	2,106.45

Notes:

- Door-to-door refers to shipments picked up and delivered to addresses designated by the shipper.
- Drop-off refers to shipments that are dropped off at a UPS Worldwide Express Freight Center and delivered to a designated address.
- Hold at Location refers to shipments picked up at a designated address and held at a UPS Worldwide Express Freight Center for pickup.
- Drop-off and Hold at Location refers to shipments that are dropped off and held at a UPS Worldwide Express Freight Center for pickup.
- For UPS Worldwide Express Freight Midday shipments, additional charges may apply to larger pallets. Pallets exceeding maximum size or weight restrictions (which vary by origin and destination) as set forth at [ups.com/assets/resources/media/wwef_max_dim.pdf](https://www.ups.com/assets/resources/media/wwef_max_dim.pdf) require prior authorization. Refer to page 124 for more information.
- For additional information, refer to page 26.

Import

UPS Worldwide Express Freight®

Guaranteed delivery by end of day from 76 and to 81 countries and territories. Delivery is guaranteed on the next business day from Canada and Mexico and one to two business days from Asia, Europe and Latin America. Rates include door-to-door and non door-to-door delivery with routine, in-house customs clearance by UPS Supply Chain Solutions® for palletized shipments of more than 150 pounds.

Door-to-Door

Zones	491	494	451	452	453	454	455
151-999 Lbs. (Price per Lb.)	\$6.85	\$6.56	\$12.03	\$12.58	\$14.81	\$16.44	\$26.14
1,000 Lbs. or More (Price per Lb.)	6.51	6.32	11.59	12.11	14.27	15.82	24.58
Minimum Rate	1,033.28	990.56	1,816.53	1,899.58	2,236.31	2,482.44	3,947.14

Zones	456	457	458	459	461	462	463	470	471
151-999 Lbs. (Price per Lb.)	\$13.96	\$16.41	\$25.40	\$13.40	\$14.87	\$15.92	\$13.40	\$12.29	\$13.14
1,000 Lbs. or More (Price per Lb.)	13.58	15.12	23.92	12.88	14.44	15.11	12.91	11.82	12.63
Minimum Rate	2,107.96	2,477.91	3,835.40	2,023.40	2,245.37	2,403.92	2,023.40	1,855.40	1,984.07

Non Door-to-Door: Drop-off, Hold at Location, Drop-off and Hold at Location

Zones	491	494	451	452	453	454	455
151-999 Lbs. (Price per Lb.)	\$6.57	\$6.09	\$11.25	\$11.43	\$14.10	\$15.28	\$24.40
1,000 Lbs. or More (Price per Lb.)	6.24	5.86	10.83	11.00	13.58	14.69	22.93
Minimum Rate	991.00	919.59	1,698.75	1,725.93	2,129.10	2,307.28	3,684.40

Zones	456	457	458	459	461	462	463	470	471
151-999 Lbs. (Price per Lb.)	\$12.95	\$15.66	\$23.74	\$12.51	\$13.47	\$14.74	\$12.80	\$11.14	\$12.13
1,000 Lbs. or More (Price per Lb.)	12.59	14.40	22.35	12.02	13.07	13.97	12.33	10.71	11.64
Minimum Rate	1,955.45	2,364.66	3,584.74	1,889.01	2,033.97	2,225.74	1,932.80	1,681.75	1,831.56

Notes:

- Door-to-door refers to shipments picked up and delivered to addresses designated by the shipper.
- Drop-off refers to shipments that are dropped off at a UPS Worldwide Express Freight Center and delivered to a designated address.
- Hold at Location refers to shipments picked up at a designated address and held at a UPS Worldwide Express Freight Center for pickup.
- Drop-off and Hold at Location refers to shipments that are dropped off and held at a UPS Worldwide Express Freight Center for pickup.
- For UPS Worldwide Express Freight shipments, additional charges may apply to larger pallets. Pallets exceeding maximum size or weight restrictions (which vary by origin and destination) as set forth at [ups.com/assets/resources/media/wwef_max_dim.pdf](https://www.ups.com/assets/resources/media/wwef_max_dim.pdf) require prior authorization. Refer to page 124 for more information.
- For additional information, refer to page 26.

Import

UPS Worldwide Saver®

Guaranteed delivery by end of day from more than 185 countries and territories. Delivery is guaranteed on the next business day from Canada and Mexico and one to two business days from Asia, Europe and Latin America. Rates include door-to-door delivery with routine, in-house customs clearance by UPS Supply Chain Solutions®.

Letter/Document

Zones	491	494	451	452	453	454	455	456	457	458	459	461	462	463	470	471
Letter*	\$54.75	\$55.42	\$95.11	\$79.91	\$101.74	\$76.31	\$112.23	\$77.12	\$91.79	\$101.63	\$75.51	\$87.87	\$68.80	\$76.43	\$73.74	\$70.59
1 Lbs.	76.59	58.68	110.27	88.62	130.32	95.70	123.42	88.38	115.78	121.79	100.68	95.23	81.68	100.68	83.13	84.06
2	79.95	59.29	111.90	90.29	132.47	97.35	153.09	111.51	138.69	153.32	103.79	117.27	90.35	112.22	87.29	102.87
3	110.25	82.87	168.25	144.06	196.88	152.28	273.97	163.80	208.04	259.86	157.05	160.45	148.27	157.05	128.69	137.27
4	121.20	89.66	189.73	158.65	218.38	171.96	315.70	188.25	232.32	312.35	177.90	182.28	170.98	177.90	146.40	161.10
5	132.23	96.98	212.05	173.24	239.90	192.12	357.42	215.74	264.56	341.06	194.23	212.35	187.84	194.23	159.37	181.67
6	143.05	103.23	229.07	189.99	264.90	210.74	397.35	239.27	288.65	379.13	213.00	230.02	207.22	213.00	178.66	197.31
7	153.58	111.10	243.46	204.41	285.62	230.49	438.38	260.12	314.37	426.50	231.14	253.41	226.75	231.14	193.92	215.85
8	163.96	114.71	259.10	218.56	303.91	249.52	486.33	283.91	339.42	472.14	249.69	270.08	245.19	249.69	204.27	230.97
9	174.43	120.43	270.93	232.77	325.15	268.98	517.10	305.13	361.00	512.77	269.05	291.22	264.44	269.05	219.55	249.75
10	184.91	124.86	278.63	246.95	344.65	275.96	538.18	317.17	387.10	557.10	278.04	307.66	276.79	278.04	235.04	250.17

Non-document

Zones	491	494	451	452	453	454	455	456	457	458	459	461	462	463	470	471
1 Lbs.	\$90.52	\$68.95	\$158.28	\$109.43	\$173.06	\$129.74	\$194.72	\$122.41	\$164.73	\$184.68	\$127.10	\$137.87	\$118.72	\$130.53	\$100.12	\$105.07
2	102.53	77.28	180.61	131.11	197.84	153.38	232.83	146.97	191.69	222.37	149.24	162.53	135.75	149.24	119.16	124.85
3	114.31	86.36	198.20	146.43	218.31	177.29	282.33	168.80	228.61	273.27	170.73	183.42	154.58	170.73	134.31	142.96
4	125.66	93.43	221.92	161.55	250.26	200.80	325.78	193.94	262.17	315.34	188.75	204.30	172.63	188.75	148.01	162.41
5	137.11	101.07	240.80	176.96	270.33	223.62	368.67	220.62	288.66	353.62	205.60	223.94	189.82	205.60	163.30	184.56
6	148.32	107.59	256.48	191.00	287.64	246.30	410.01	244.56	312.51	393.09	224.29	237.20	209.48	224.29	181.81	199.81
7	159.24	115.26	270.87	205.49	304.96	269.12	452.37	268.47	336.48	442.22	239.24	260.30	228.51	239.24	194.50	218.65
8	170.00	119.54	285.02	219.71	328.44	288.42	496.76	289.89	362.06	475.87	254.60	284.08	247.54	254.60	205.26	234.32
9	180.54	125.50	297.73	234.01	349.54	307.83	533.60	311.55	386.03	525.85	273.45	302.09	266.80	273.45	222.83	252.87
10	191.73	129.72	304.16	248.26	371.81	309.86	541.99	323.85	412.28	577.64	281.84	315.72	281.79	281.84	235.25	253.85
11	201.96	130.59	306.38	252.31	381.01	314.44	551.79	326.76	434.86	579.28	282.32	320.55	286.45	285.46	237.28	254.35
12	203.97	131.77	308.75	254.17	383.99	322.62	562.23	329.50	448.80	583.89	289.58	326.25	297.27	295.05	244.53	262.12
13	217.48	151.47	354.36	291.57	443.41	380.86	673.12	382.59	483.27	662.92	335.02	374.09	342.54	335.02	271.43	296.56
14	229.61	157.83	367.51	305.15	454.70	398.71	705.35	399.02	506.27	689.78	354.42	388.62	361.03	354.42	282.22	314.18
15	237.59	161.33	379.32	318.74	473.31	420.58	736.74	420.02	528.73	722.92	366.57	408.31	379.73	366.57	298.84	330.07
16	244.23	169.01	392.51	331.75	492.70	434.30	763.39	434.10	554.41	750.81	379.79	415.93	402.62	379.79	311.37	349.02
17	252.86	174.41	404.35	344.73	512.12	453.58	793.45	444.02	576.88	780.35	391.96	427.06	416.59	391.96	322.92	361.82
18	260.03	182.74	416.20	357.77	531.54	469.75	818.96	458.79	594.92	805.19	400.32	446.41	439.18	400.32	330.52	379.18
19	267.49	184.17	428.04	370.78	563.60	487.14	854.10	469.92	616.89	835.11	413.02	463.45	457.67	413.02	342.63	393.16
20	275.70	188.01	438.32	383.79	570.36	500.20	874.57	484.14	635.30	849.93	425.26	476.51	478.02	425.26	354.82	408.50

*The Letter rate applies only to documents, correspondence and electronic media shipments of no commercial value that do not exceed eight ounces sent in a UPS Express® Envelope.

Note: For additional information, refer to page 26.

Import

UPS Worldwide Saver®

Non-document

Zones	491	494	451	452	453	454	455	456	457	458	459	461	462	463	470	471
21 Lbs.	\$280.92	\$193.33	\$443.00	\$396.75	\$603.35	\$500.56	\$876.12	\$490.40	\$665.53	\$880.63	\$431.33	\$477.84	\$488.76	\$431.33	\$371.73	\$415.25
22	287.83	197.26	449.31	406.89	609.19	501.53	877.79	490.64	675.69	910.81	433.92	482.07	492.00	438.78	380.59	416.73
23	294.64	197.66	449.56	407.90	622.98	508.95	879.53	493.49	691.86	911.38	434.74	482.30	501.23	452.66	381.44	423.33
24	298.62	197.90	449.80	408.15	624.36	513.01	880.08	498.82	708.03	911.91	434.97	482.83	504.66	463.11	390.47	439.50
25	300.23	199.35	452.68	410.40	627.20	526.99	886.50	502.14	710.15	920.89	439.91	486.78	516.15	470.65	391.45	441.85
26	312.90	223.14	507.99	453.70	683.79	609.24	1,019.16	547.17	752.30	1,001.55	487.82	553.79	581.75	489.94	422.41	465.66
27	318.12	233.66	521.46	472.13	702.44	635.01	1,041.45	582.15	759.25	1,027.93	502.32	573.98	597.77	502.78	440.20	491.79
28	325.03	239.87	533.05	484.60	737.69	651.28	1,063.72	595.61	793.98	1,045.31	512.74	586.47	612.89	515.42	451.36	503.77
29	331.17	246.10	542.65	497.03	756.68	668.50	1,096.64	612.11	807.62	1,071.97	524.26	599.04	634.25	526.80	462.26	515.78
30	337.58	247.61	554.18	509.50	758.58	685.71	1,117.84	624.84	812.24	1,097.07	535.23	611.57	645.07	537.87	472.08	527.10
31	343.85	255.15	565.67	520.83	770.84	694.63	1,135.41	635.87	836.84	1,114.24	548.63	624.09	660.16	548.63	481.49	537.75
32	349.93	260.77	575.13	532.17	801.25	711.67	1,162.33	652.67	862.91	1,115.98	560.48	636.60	672.73	560.48	491.98	549.09
33	354.99	262.85	582.49	533.97	806.57	732.37	1,182.59	668.48	868.44	1,150.33	570.68	649.14	682.86	570.68	496.00	558.01
34	360.11	267.93	591.92	554.19	808.15	743.72	1,197.27	674.28	869.69	1,181.68	582.33	661.68	703.16	582.33	514.53	569.44
35	365.17	275.82	602.65	558.83	839.46	760.71	1,219.49	687.18	894.36	1,203.57	588.44	670.51	728.54	588.44	516.67	578.62
36	370.26	280.47	612.84	577.48	848.81	783.91	1,241.76	700.15	902.02	1,225.60	596.77	686.75	740.54	596.77	538.24	591.57
37	376.17	286.22	622.44	588.82	849.77	799.00	1,271.01	713.04	918.17	1,238.19	607.21	699.58	742.02	607.21	548.73	603.05
38	376.76	291.57	631.94	599.74	868.50	816.60	1,286.27	727.38	934.35	1,258.86	625.26	713.19	755.91	625.26	557.23	613.04
39	385.49	296.78	641.37	603.65	870.39	832.38	1,315.76	740.33	955.63	1,276.31	633.98	724.30	776.08	633.98	559.84	623.55
40	390.55	301.84	650.83	611.87	882.84	848.72	1,337.24	757.84	966.23	1,307.76	643.36	736.82	783.42	643.36	566.96	634.33
41	395.17	304.63	660.08	636.09	914.52	864.92	1,358.74	771.00	986.86	1,329.66	657.85	745.94	800.51	657.85	587.88	644.73
42	399.81	312.25	669.28	644.98	925.99	881.42	1,380.37	784.14	997.32	1,355.41	661.15	758.40	811.33	661.15	599.98	655.51
43	407.80	317.59	678.48	645.91	934.01	909.66	1,402.82	797.16	1,009.11	1,360.71	685.11	770.84	825.09	685.11	600.14	666.31
44	409.13	322.64	687.68	664.33	934.81	920.47	1,420.16	811.40	1,019.40	1,379.93	712.32	779.70	838.99	712.32	616.25	676.41
45	413.81	328.40	696.95	666.18	938.78	937.64	1,445.38	815.93	1,031.21	1,407.50	722.86	784.69	872.90	722.86	617.57	686.66
46	418.46	333.33	706.16	677.08	968.22	953.98	1,474.15	837.83	1,051.04	1,454.42	727.48	803.75	882.51	727.48	629.31	695.85
47	423.13	338.67	712.77	700.27	974.57	971.29	1,502.54	841.59	1,062.81	1,459.12	731.25	815.40	883.60	731.25	651.60	705.69
48	427.77	339.90	724.59	702.59	975.91	982.20	1,523.57	854.44	1,074.08	1,461.29	737.24	826.12	905.90	737.24	653.57	717.01
49	429.98	347.72	725.76	722.39	1,002.65	999.70	1,546.75	867.27	1,084.54	1,504.64	745.34	837.08	912.17	745.34	662.76	725.78
50	430.55	352.52	726.94	729.55	1,005.33	1,016.22	1,566.57	880.10	1,096.18	1,574.85	758.36	848.56	921.28	758.36	663.90	736.82
52	448.27	362.01	765.32	754.42	1,037.03	1,049.57	1,594.38	905.46	1,126.59	1,578.82	784.47	894.81	967.46	784.47	689.20	752.61
54	449.46	373.76	781.04	775.44	1,059.44	1,083.84	1,639.05	930.90	1,153.64	1,675.49	813.84	912.25	1,006.18	813.84	708.63	773.38
56	462.34	385.49	799.53	796.40	1,071.84	1,116.32	1,695.77	961.72	1,180.33	1,690.86	836.87	937.30	1,030.76	836.87	739.82	794.01
58	475.20	397.20	818.02	817.35	1,084.24	1,148.26	1,746.86	987.74	1,205.37	1,692.87	845.37	962.35	1,051.46	845.37	758.52	814.78
60	476.49	408.85	836.41	838.39	1,128.24	1,180.24	1,763.57	1,007.06	1,230.04	1,702.91	887.91	974.55	1,108.75	887.91	778.04	835.03

Note: For additional information, refer to page 26.

Import

UPS Worldwide Saver®

Non-document

Zones	491	494	451	452	453	454	455	456	457	458	459	461	462	463	470	471
62 Lbs.	\$493.81	\$421.66	\$861.97	\$848.86	\$1,132.33	\$1,212.19	\$1,807.79	\$1,035.71	\$1,255.08	\$1,763.07	\$920.18	\$998.69	\$1,143.16	\$920.18	\$783.37	\$856.47
64	502.83	440.61	874.46	888.03	1,149.93	1,248.98	1,877.14	1,059.23	1,281.75	1,823.24	943.39	1,046.51	1,167.53	943.39	817.17	877.64
66	511.89	447.70	900.22	893.63	1,198.49	1,278.02	1,894.88	1,077.11	1,306.16	1,871.07	963.90	1,053.58	1,190.31	963.90	819.72	883.45
68	514.90	464.68	909.40	909.62	1,202.09	1,306.37	1,954.02	1,104.79	1,331.16	1,873.65	971.75	1,087.67	1,246.25	971.75	835.29	900.68
70	526.45	478.09	926.92	929.90	1,232.86	1,331.60	2,012.37	1,134.88	1,356.10	1,914.22	1,030.00	1,122.29	1,275.63	1,030.00	854.84	939.14
72	540.18	490.95	961.67	961.37	1,236.58	1,366.16	2,022.10	1,166.31	1,382.49	1,975.73	1,041.31	1,149.68	1,298.00	1,041.31	889.80	978.51
74	550.66	502.74	968.73	970.50	1,282.91	1,399.49	2,119.76	1,196.11	1,405.53	2,020.63	1,062.06	1,173.05	1,332.12	1,062.06	893.16	997.14
76	561.14	515.20	976.09	1,002.39	1,298.88	1,432.38	2,138.46	1,201.71	1,445.06	2,063.53	1,087.85	1,214.29	1,372.12	1,087.85	928.26	1,002.52
78	571.85	524.45	1,001.61	1,022.22	1,301.59	1,464.91	2,199.91	1,218.50	1,458.45	2,164.28	1,089.82	1,256.54	1,403.78	1,089.82	937.77	1,010.78
80	572.47	537.26	1,015.49	1,049.84	1,348.65	1,497.25	2,251.76	1,249.11	1,483.77	2,192.12	1,154.39	1,274.09	1,434.93	1,154.39	966.85	1,031.95
82	586.06	554.50	1,035.69	1,063.36	1,358.76	1,530.45	2,258.75	1,262.26	1,509.48	2,229.07	1,171.41	1,293.18	1,466.64	1,171.41	986.07	1,052.57
84	597.44	564.30	1,052.15	1,075.52	1,384.59	1,561.30	2,317.34	1,275.57	1,534.82	2,293.95	1,199.25	1,307.28	1,468.80	1,199.25	1,004.75	1,072.55
86	608.36	578.88	1,064.71	1,094.02	1,397.03	1,600.68	2,319.38	1,288.57	1,561.61	2,339.59	1,219.52	1,333.22	1,509.57	1,219.52	1,023.90	1,093.20
88	619.59	585.60	1,090.86	1,114.85	1,416.18	1,613.08	2,359.05	1,295.62	1,587.06	2,358.35	1,235.17	1,333.79	1,530.98	1,235.17	1,042.44	1,113.54
90	630.39	594.03	1,112.20	1,115.91	1,418.11	1,628.37	2,415.92	1,308.71	1,612.65	2,421.05	1,250.10	1,369.84	1,577.58	1,250.10	1,043.75	1,130.14
92	641.65	605.90	1,127.87	1,122.91	1,418.69	1,637.68	2,445.39	1,347.20	1,614.14	2,431.58	1,289.16	1,381.24	1,597.76	1,289.16	1,053.87	1,146.05
94	651.81	607.97	1,134.55	1,136.17	1,419.36	1,647.54	2,447.91	1,360.53	1,650.46	2,436.52	1,305.72	1,404.69	1,607.64	1,305.72	1,071.73	1,163.33
96	662.84	627.72	1,148.42	1,155.72	1,424.14	1,657.68	2,497.38	1,373.98	1,683.65	2,544.24	1,309.05	1,415.55	1,629.45	1,309.05	1,080.65	1,184.21
98	673.38	633.51	1,170.09	1,160.96	1,426.28	1,659.97	2,563.93	1,375.56	1,705.05	2,550.53	1,341.07	1,417.04	1,647.06	1,341.07	1,104.96	1,203.22
100	683.56	662.61	1,202.46	1,257.41	1,493.63	1,676.42	2,613.20	1,408.08	1,739.68	2,555.25	1,370.63	1,495.46	1,672.73	1,370.63	1,126.15	1,222.80
105	713.74	703.76	1,262.61	1,320.27	1,568.90	1,760.01	2,743.87	1,469.52	1,830.65	2,682.20	1,441.16	1,570.70	1,741.22	1,441.16	1,206.19	1,273.32
110	744.31	737.27	1,322.73	1,383.16	1,641.93	1,841.18	2,874.53	1,539.37	1,915.19	2,807.25	1,494.82	1,641.38	1,821.52	1,494.82	1,291.47	1,323.02
115	775.79	770.78	1,382.85	1,446.02	1,716.01	1,924.38	3,005.19	1,608.22	1,980.93	2,932.44	1,574.53	1,714.39	1,894.47	1,574.53	1,347.48	1,379.17
120	806.04	801.76	1,442.97	1,508.89	1,786.68	1,992.36	3,135.85	1,677.38	2,047.24	3,057.10	1,626.92	1,797.91	1,966.77	1,626.92	1,405.64	1,438.45
125	835.92	829.53	1,503.10	1,571.76	1,858.40	2,074.90	3,266.50	1,744.83	2,114.07	3,183.62	1,693.33	1,885.09	2,049.23	1,693.33	1,459.08	1,493.43
130	865.97	859.26	1,563.22	1,634.63	1,941.94	2,147.08	3,397.17	1,814.28	2,179.95	3,309.63	1,756.16	1,954.19	2,113.17	1,756.16	1,514.00	1,546.61
135	896.82	890.60	1,623.34	1,697.50	2,011.55	2,226.09	3,527.83	1,883.01	2,245.02	3,436.17	1,815.46	2,025.92	2,176.43	1,815.46	1,567.74	1,601.45
140	926.12	923.18	1,683.46	1,760.37	2,079.86	2,306.01	3,658.49	1,952.29	2,328.79	3,561.61	1,878.89	2,090.75	2,239.53	1,878.89	1,625.48	1,657.32
145	956.63	955.89	1,743.58	1,823.25	2,150.66	2,386.65	3,789.15	2,022.27	2,394.38	3,687.08	1,944.63	2,155.72	2,311.47	1,944.63	1,680.15	1,711.08
150	986.52	982.95	1,803.69	1,886.11	2,220.03	2,465.63	3,919.80	2,092.54	2,460.22	3,809.45	2,009.15	2,229.22	2,387.59	2,009.15	1,730.37	1,767.50

Shipments of More Than 150 Pounds

Zones	491	494	451	452	453	454	455	456	457	458	459	461	462	463	470	471
Price Per Pound	\$6.58	\$6.56	\$12.03	\$12.58	\$14.81	\$16.44	\$26.14	\$13.96	\$16.41	\$25.40	\$13.40	\$14.87	\$15.92	\$13.40	\$11.54	\$11.79
Minimum Rate	986.52	982.95	1,803.69	1,886.11	2,220.03	2,465.63	3,919.80	2,092.54	2,460.22	3,809.45	2,009.15	2,229.22	2,387.59	2,009.15	1,730.37	1,767.50

Note: For additional information, refer to page 26.

Import

UPS Worldwide Expedited®

Guaranteed delivery by end of business day from more than 80 countries and territories. Delivery is guaranteed in two business days from Canada, two to three business days from Mexico and four to five business days from Asia, Europe and Latin America. Rates include door-to-door delivery with routine, in-house customs clearance by UPS Supply Chain Solutions®

Zones	61	64	651/681	652/682	653/683	654/684	655/685	656/686	657/687	658/688	659/689	661/691	662/692	663/693	670	671
1 Lbs.	\$81.22	\$59.86	\$143.41	\$92.12	\$162.47	\$108.77	\$140.28	\$112.22	\$140.85	\$171.91	\$112.30	\$110.82	\$103.84	\$115.77	\$87.17	\$93.56
2	91.70	67.35	163.03	110.36	185.47	128.63	176.88	135.00	172.36	205.99	132.98	128.97	119.58	132.98	103.76	114.10
3	102.40	75.05	179.13	123.18	204.71	148.52	208.88	157.20	198.66	239.54	150.61	145.48	135.87	150.61	116.96	126.44
4	111.90	81.98	200.91	137.19	227.99	171.63	236.99	183.14	229.76	276.49	163.04	162.06	151.85	163.04	128.87	144.35
5	120.70	88.78	217.00	150.13	250.37	187.52	264.38	201.93	252.92	329.78	181.37	175.53	166.89	181.37	142.19	158.45
6	130.16	96.19	232.29	163.70	270.34	213.75	291.15	228.01	273.90	366.72	187.50	193.41	186.99	187.50	154.93	170.97
7	138.56	99.58	245.28	175.09	285.94	229.28	312.60	250.83	294.80	383.86	211.44	213.31	204.03	211.44	168.94	186.92
8	146.86	105.91	258.06	187.16	304.31	246.67	335.76	265.31	317.29	437.07	227.88	223.32	221.49	227.88	181.31	200.50
9	155.59	109.18	270.38	196.60	324.82	263.25	355.77	285.08	338.35	506.08	240.07	240.30	238.94	240.07	190.40	215.16
10	164.02	119.83	282.14	210.70	344.88	279.86	384.52	310.72	361.02	553.48	255.40	252.61	255.67	255.40	204.34	227.80
11	169.62	120.50	295.60	220.13	364.09	295.19	398.01	319.83	379.54	562.79	270.83	259.10	272.83	270.83	213.19	238.54
12	174.05	127.45	305.22	229.12	367.32	306.67	430.51	325.07	399.47	566.04	285.97	273.05	274.35	285.97	224.63	242.97
13	180.11	132.34	319.21	244.96	402.16	330.60	455.53	349.75	421.70	627.23	298.80	286.60	304.36	298.80	235.76	260.40
14	185.03	138.86	331.05	254.04	419.04	345.87	481.04	371.68	442.09	627.73	310.99	296.62	320.66	310.99	246.06	275.87
15	189.86	140.24	340.99	267.49	442.55	356.59	496.70	386.96	461.65	686.24	323.67	305.18	337.31	323.67	259.60	289.83
16	194.00	146.21	353.58	278.79	460.45	369.30	519.90	387.52	483.95	741.07	336.21	321.58	355.65	336.21	270.45	304.71
17	197.97	150.44	363.58	286.74	478.43	402.29	541.46	401.28	503.50	758.90	346.08	331.07	369.60	346.08	277.14	316.35
18	203.76	159.25	374.95	303.24	489.58	407.75	561.71	412.27	522.74	783.31	355.90	341.72	386.18	355.90	291.84	325.81
19	205.74	163.33	385.57	311.37	516.01	426.95	581.79	435.69	537.59	791.35	363.65	361.13	402.87	363.65	302.06	345.22
20	209.48	168.51	394.90	319.43	535.98	438.62	603.64	444.60	557.12	791.85	373.40	365.77	419.08	373.40	308.66	358.70
21	214.38	172.91	405.86	330.30	551.08	453.95	622.42	457.32	584.13	793.72	381.71	369.80	441.48	381.71	317.08	370.63
22	220.76	177.68	416.40	344.31	567.55	469.25	651.05	477.61	603.44	806.88	391.40	389.46	457.51	391.40	332.95	381.73
23	226.52	180.58	425.29	353.53	591.51	488.26	674.96	487.46	613.39	858.37	414.23	408.89	475.77	414.23	341.47	390.92
24	229.82	187.24	437.20	366.84	603.33	499.72	684.60	489.19	637.22	883.31	422.56	409.39	486.48	422.56	352.69	400.90
25	231.24	193.38	446.65	372.41	605.80	513.69	688.48	492.73	652.54	893.93	426.24	415.43	501.98	432.24	363.44	403.96
26	235.40	200.57	456.33	388.95	639.79	535.82	702.59	518.86	676.87	920.59	436.13	430.55	516.52	437.81	373.50	423.50
27	239.56	207.16	468.39	400.35	658.20	543.36	719.27	522.95	694.70	958.11	446.01	445.53	530.88	452.55	382.37	430.77
28	247.03	211.58	478.77	410.64	678.18	558.16	737.20	551.21	711.92	958.61	449.80	459.16	542.50	465.11	392.07	441.27
29	247.78	214.09	486.46	417.85	695.56	573.38	754.48	557.78	726.88	959.11	459.52	460.02	556.77	477.36	401.53	451.80
30	251.92	219.97	496.77	423.42	716.34	587.81	769.98	572.26	736.66	968.01	473.76	461.51	573.20	488.49	409.95	461.72
31	256.66	225.44	508.04	437.30	729.66	602.59	788.54	591.13	756.96	987.44	480.27	473.09	587.84	498.83	418.23	471.04
32	259.52	230.27	516.54	451.23	741.72	624.55	810.84	593.03	768.81	987.94	500.92	487.25	598.54	506.17	427.35	480.97
33	263.31	232.59	523.14	460.48	753.35	630.86	824.13	608.14	780.06	1,010.46	507.01	499.64	611.46	514.08	438.56	488.76
34	270.65	236.25	531.58	470.10	771.36	647.05	836.33	616.09	790.11	1,085.91	507.89	503.11	629.86	520.90	447.42	498.81
35	271.40	240.71	541.22	480.98	772.99	671.88	858.70	627.70	799.53	1,108.02	520.07	518.57	647.33	528.96	454.67	506.83

Note: For additional information, refer to page 26.

Import

UPS Worldwide Expedited[®]

Zones	61	64	651/681	652/682	653/683	654/684	655/685	656/686	657/687	658/688	659/689	661/691	662/692	663/693	670	671
36 Lbs.	\$274.67	\$247.48	\$550.39	\$491.04	\$786.15	\$688.73	\$863.33	\$645.11	\$808.87	\$1,112.26	\$524.27	\$533.53	\$649.17	\$536.52	\$467.53	\$518.19
37	279.62	252.97	559.10	499.49	799.02	707.94	877.62	657.20	817.86	1,128.02	538.58	542.08	666.58	546.82	476.63	528.22
38	282.26	257.39	567.60	511.22	804.93	716.23	891.28	675.10	828.16	1,140.58	547.85	563.86	673.38	555.08	484.34	536.96
39	289.14	263.57	576.10	520.88	821.17	721.10	904.97	678.12	837.64	1,149.21	559.33	574.45	689.37	563.05	492.65	546.18
40	289.84	265.60	584.60	530.12	837.45	754.08	918.42	689.75	846.91	1,157.70	560.99	574.95	695.91	572.56	501.29	555.64
41	293.97	270.02	592.07	539.00	856.02	765.40	939.99	706.47	859.94	1,177.09	570.92	594.31	709.12	580.26	511.46	564.71
42	303.80	274.80	598.42	545.47	867.29	768.36	958.94	719.61	863.34	1,197.62	586.40	604.74	720.21	586.40	521.14	574.18
43	305.98	279.94	606.93	558.00	875.08	780.34	969.31	723.29	875.70	1,217.80	606.98	605.24	732.77	606.98	529.44	583.62
44	306.54	283.61	619.13	568.24	885.73	793.17	975.38	724.44	884.79	1,240.96	617.57	605.74	747.26	617.57	537.51	584.12
45	310.42	286.74	621.76	574.03	893.16	794.69	987.32	747.01	893.90	1,272.19	618.81	609.64	763.66	618.81	546.04	601.47
46	314.54	291.88	635.17	578.24	900.25	824.81	1,008.11	768.72	906.66	1,282.42	641.29	616.75	773.44	641.29	550.54	609.51
47	319.27	297.67	640.59	589.84	908.84	842.71	1,022.32	770.91	914.43	1,301.88	645.85	630.04	783.34	645.85	559.39	618.12
48	327.25	302.64	648.20	607.93	909.73	844.52	1,037.90	782.72	923.89	1,319.29	646.42	643.32	798.33	646.42	574.78	628.06
49	328.06	308.42	654.27	612.02	915.96	852.82	1,049.35	794.07	933.12	1,332.20	656.79	643.87	807.21	656.79	582.34	635.73
50	332.77	313.43	658.85	612.52	923.79	884.01	1,058.90	821.77	946.25	1,364.67	666.52	650.64	815.93	666.52	582.84	645.43
52	341.06	325.42	678.64	639.85	941.07	911.92	1,071.29	835.57	968.80	1,370.75	687.56	671.54	858.35	687.56	607.38	659.24
54	348.15	335.22	686.64	660.97	975.10	925.50	1,081.87	836.67	988.43	1,383.99	716.17	702.01	890.42	716.17	625.70	677.43
56	356.03	347.68	701.51	675.83	991.19	964.08	1,090.96	868.10	993.89	1,421.39	733.76	719.75	918.01	733.76	642.64	695.50
58	363.92	358.95	716.38	692.06	999.07	1,002.66	1,123.25	899.51	1,004.38	1,458.85	751.37	740.92	942.33	751.37	658.87	713.71
60	375.19	370.77	736.28	715.37	1,022.26	1,037.22	1,134.15	925.26	1,030.93	1,617.22	777.99	753.39	974.66	777.99	675.82	731.43
62	384.26	382.61	755.89	727.98	1,040.55	1,066.61	1,157.96	950.84	1,065.93	1,638.03	787.14	791.11	999.26	787.14	688.51	748.88
64	393.25	394.40	766.84	752.89	1,066.23	1,100.59	1,170.06	980.49	1,080.43	1,710.61	823.87	808.23	1,015.39	823.87	706.98	761.38
66	401.48	405.13	788.17	769.27	1,091.05	1,129.86	1,181.20	1,002.59	1,095.29	1,714.02	856.90	837.07	1,035.04	856.90	721.36	773.84
68	416.96	417.66	796.02	784.57	1,121.54	1,130.45	1,194.64	1,012.20	1,118.13	1,714.52	862.18	847.53	1,066.21	862.18	738.54	790.73
70	425.99	429.26	811.93	802.21	1,132.84	1,131.47	1,206.49	1,054.57	1,129.33	1,715.02	896.50	874.22	1,094.70	896.50	755.84	822.63
72	435.90	439.45	829.58	802.71	1,164.44	1,208.19	1,218.45	1,078.38	1,136.06	1,742.78	908.82	891.23	1,099.13	908.82	756.34	846.26
74	438.90	449.45	846.43	837.51	1,170.34	1,221.35	1,231.81	1,083.21	1,151.92	1,781.62	919.99	904.26	1,124.59	919.99	789.71	869.61
76	445.90	461.62	862.23	838.01	1,171.21	1,234.07	1,243.96	1,083.79	1,152.56	1,784.23	966.66	928.81	1,154.32	966.66	790.21	878.15
78	456.14	472.56	873.50	858.85	1,194.01	1,266.62	1,256.49	1,084.36	1,173.82	1,842.24	988.93	945.88	1,179.81	988.93	807.61	885.37
80	457.42	482.92	887.00	865.02	1,225.05	1,297.62	1,268.58	1,087.51	1,195.24	1,897.89	1,010.12	987.24	1,206.71	1,010.12	816.41	903.91

Note: For additional information, refer to page [26](#).

Import

UPS Worldwide Expedited®

Zones	61	64	651/681	652/682	653/683	654/684	655/685	656/686	657/687	658/688	659/689	661/691	662/692	663/693	670	671
82 Lbs.	\$465.09	\$495.03	\$901.53	\$880.11	\$1,233.26	\$1,329.97	\$1,281.32	\$1,098.21	\$1,206.74	\$1,916.03	\$1,023.29	\$1,010.28	\$1,236.31	\$1,023.29	\$832.64	\$921.99
84	475.92	496.11	908.89	887.36	1,234.01	1,361.67	1,294.00	1,119.71	1,218.20	1,921.32	1,033.85	1,026.28	1,242.30	1,033.85	849.33	939.47
86	479.72	502.19	927.72	928.12	1,242.57	1,393.60	1,306.35	1,142.62	1,229.58	1,950.86	1,058.42	1,050.19	1,271.20	1,058.42	889.72	957.55
88	487.38	503.67	935.34	944.87	1,250.95	1,414.55	1,318.84	1,146.84	1,241.14	1,995.29	1,084.36	1,066.01	1,291.15	1,084.36	906.27	975.39
90	495.33	528.09	939.70	945.37	1,254.47	1,433.72	1,331.96	1,173.67	1,252.26	2,022.56	1,100.91	1,072.61	1,319.40	1,100.91	906.77	989.92
92	498.13	528.64	954.71	947.69	1,257.95	1,434.28	1,344.17	1,174.35	1,262.91	2,066.57	1,101.46	1,085.66	1,341.38	1,101.46	913.93	1,003.81
94	505.05	547.50	967.35	952.62	1,265.75	1,434.84	1,356.11	1,195.13	1,274.28	2,108.51	1,114.51	1,108.76	1,360.91	1,114.51	916.12	1,018.55
96	513.89	557.87	969.04	969.46	1,269.38	1,435.34	1,368.05	1,221.93	1,285.57	2,132.33	1,123.26	1,131.81	1,386.88	1,123.26	931.24	1,030.16
98	531.65	560.01	978.76	971.33	1,270.38	1,435.84	1,394.22	1,223.87	1,294.66	2,175.36	1,136.02	1,158.62	1,413.80	1,136.02	931.74	1,043.71
100	533.29	563.87	992.20	1,017.25	1,281.56	1,454.46	1,407.37	1,248.06	1,307.05	2,413.38	1,145.96	1,171.45	1,440.33	1,145.96	957.92	1,063.50
105	559.96	593.20	1,041.83	1,072.20	1,336.55	1,504.11	1,472.16	1,310.46	1,345.22	2,534.06	1,187.88	1,223.51	1,519.35	1,187.88	1,018.30	1,098.80
110	586.62	621.23	1,090.55	1,121.23	1,406.29	1,571.31	1,503.12	1,372.88	1,371.77	2,654.40	1,240.41	1,272.49	1,582.83	1,240.41	1,051.84	1,134.99
115	613.29	648.88	1,128.43	1,170.21	1,464.48	1,642.74	1,545.02	1,435.27	1,410.21	2,774.50	1,296.79	1,327.57	1,651.66	1,296.79	1,089.34	1,175.93
120	639.96	675.47	1,160.52	1,220.28	1,522.57	1,714.16	1,588.92	1,497.68	1,437.17	2,892.42	1,353.17	1,361.77	1,716.37	1,353.17	1,146.21	1,219.25
125	666.60	703.64	1,220.72	1,270.74	1,582.98	1,785.57	1,631.63	1,560.08	1,462.85	3,012.90	1,407.81	1,390.81	1,786.97	1,407.81	1,191.88	1,260.57
130	693.27	734.52	1,273.00	1,320.79	1,651.17	1,857.00	1,674.36	1,622.47	1,502.91	3,130.44	1,439.18	1,419.28	1,822.56	1,439.18	1,238.84	1,300.02
135	719.94	760.67	1,316.63	1,371.57	1,695.77	1,928.42	1,703.20	1,684.88	1,528.53	3,250.86	1,468.85	1,448.53	1,878.66	1,468.85	1,285.20	1,345.58
140	746.16	790.21	1,344.74	1,423.37	1,724.57	1,981.27	1,735.95	1,747.28	1,568.83	3,367.92	1,471.74	1,451.39	1,941.02	1,471.74	1,319.67	1,382.32
145	772.75	817.57	1,380.47	1,475.22	1,775.31	2,025.28	1,765.23	1,809.69	1,619.69	3,488.26	1,500.93	1,480.22	1,980.55	1,500.93	1,349.79	1,412.99
150	799.26	843.77	1,418.11	1,526.13	1,803.57	2,071.29	1,796.01	1,872.09	1,647.75	3,601.69	1,528.48	1,508.64	2,047.24	1,528.48	1,379.94	1,444.25

Shipments of More Than 150 Pounds

Zones	61	64	651/681	652/682	653/683	654/684	655/685	656/686	657/687	658/688	659/689	661/691	662/692	663/693	670	671
Price Per Pound	\$5.33	\$5.63	\$9.46	\$10.18	\$12.03	\$13.81	\$11.98	\$12.49	\$10.99	\$24.02	\$10.19	\$10.06	\$13.65	\$10.19	\$9.20	\$9.63
Minimum Rate	799.26	843.77	1,418.11	1,526.13	1,803.57	2,071.29	1,796.01	1,872.09	1,647.75	3,601.69	1,528.48	1,508.64	2,047.24	1,528.48	1,379.94	1,444.25

Note: For additional information, refer to page 26.

Import

UPS 3 Day Select® from Canada

Guaranteed delivery by the end of the third business day to the 48 contiguous states from all Canadian provinces. Rates include door-to-door delivery with routine, in-house customs clearance by UPS Supply Chain Solutions®

Zones	475	476	477
1 Lbs.	\$49.58	\$49.79	\$51.25
2	53.30	54.31	56.54
3	56.87	58.94	61.59
4	59.84	63.39	66.90
5	63.32	68.15	71.57
6	67.00	72.78	76.87
7	69.94	77.41	82.10
8	73.60	81.73	87.26
9	77.00	86.25	92.39
10	80.51	90.53	97.02
11	83.76	94.09	101.35
12	86.81	97.59	105.55
13	90.29	100.88	109.45
14	93.42	104.31	113.43
15	96.84	107.38	116.90
16	100.09	110.39	120.58
17	103.07	113.63	123.99
18	106.22	116.82	127.66
19	109.20	119.52	131.03
20	112.26	122.30	134.38
21	115.21	124.53	137.02
22	117.91	126.74	139.14
23	122.90	128.77	141.47
24	125.45	131.05	143.32
25	128.27	133.05	145.44
26	130.91	135.27	147.31
27	134.84	137.43	149.35
28	137.49	139.41	151.38
29	139.96	141.47	153.33
30	142.51	143.81	155.53
31	144.83	145.67	160.71
32	147.07	147.71	162.98
33	149.57	149.75	165.09
34	151.42	151.87	167.22
35	152.63	153.84	172.07

Zones	475	476	477
36 Lbs.	\$154.95	\$155.96	\$174.36
37	156.62	158.19	175.63
38	157.88	160.16	178.47
39	159.55	162.32	180.54
40	161.83	164.82	182.84
41	162.87	167.23	184.96
42	165.30	169.29	187.15
43	166.72	171.27	189.19
44	168.46	173.69	190.58
45	170.25	175.31	193.38
46	171.27	177.49	195.23
47	173.06	179.55	197.36
48	175.53	181.40	199.75
49	176.65	183.47	201.73
50	178.92	185.14	203.98
52	182.60	189.67	207.95
54	183.58	193.78	212.15
56	188.87	197.94	216.74
58	192.47	202.05	220.86
60	196.92	205.43	225.35
62	199.93	210.56	229.58
64	203.50	214.55	233.91
66	207.04	218.88	238.13
68	211.29	222.99	242.31
70	214.97	226.97	246.72
72	218.66	231.13	251.16
74	222.21	235.24	255.08
76	225.81	239.16	259.63
78	229.27	243.31	263.68
80	233.01	247.55	270.45
82	236.34	251.53	272.35
84	240.00	255.55	276.54
86	242.80	259.86	280.56
88	247.00	263.78	284.63
90	250.72	267.81	288.78

Zones	475	476	477
92 Lbs.	\$254.25	\$271.98	\$292.91
94	257.67	276.15	297.09
96	261.07	280.02	301.18
98	264.59	284.56	305.05
100	268.22	288.72	309.10
105	277.49	298.77	325.75
110	286.68	309.21	341.83
115	295.92	319.77	357.88
120	305.03	330.10	373.69
125	313.01	340.48	389.67
130	322.03	350.73	405.49
135	332.31	361.11	421.63
140	341.43	371.44	437.35
145	350.55	381.82	453.37
150	360.04	392.38	469.40

Shipments of More Than 150 Pounds

Zones	475	476	477
Price Per Pound	\$2.41	\$2.62	\$3.13
Minimum Rate	360.04	392.38	469.40

Note: For additional information, refer to page [26](#).

Import

UPS® Standard from Canada*

Guaranteed delivery by end of day to the 48 contiguous states within two to seven business days from all Canadian provinces. Rates include door-to-door delivery. Customs clearance is not included. See pages 135-136 for U.S. Entry Preparation rates. UPS will provide Customs Brokerage Services by UPS Supply Chain Solutions® unless a different broker is specified. Charges will be billed to the importer unless otherwise indicated by the shipper. Saturday Delivery available in select areas.

Zones	376	378	380
1 Lbs.	\$26.20	\$26.67	\$27.52
2	27.52	27.88	29.27
3	28.57	29.15	30.96
4	29.27	30.61	32.97
5	30.42	32.00	34.41
6	31.28	32.59	36.11
7	32.13	33.57	37.81
8	33.14	35.02	39.57
9	33.82	36.42	41.26
10	34.90	37.76	43.08
11	35.01	38.53	44.17
12	35.68	39.98	45.92
13	36.24	41.45	47.49
14	36.59	42.66	49.20
15	37.01	43.98	50.88
16	37.91	45.08	52.34
17	38.92	46.22	54.16
18	39.98	47.44	55.61
19	40.69	48.59	57.36
20	41.31	49.50	59.12
21	43.47	52.14	62.11
22	43.96	52.82	63.66
23	45.01	54.25	65.33
24	45.71	55.17	66.88
25	46.50	56.24	68.61
26	47.38	57.30	70.34
27	48.19	58.59	71.89
28	50.18	60.59	74.76
29	50.28	60.90	75.29
30	51.47	62.48	77.35

Zones	376	378	380
31 Lbs.	\$52.21	\$62.94	\$79.06
32	53.47	64.19	80.77
33	54.15	65.30	82.44
34	55.88	67.12	84.99
35	56.30	67.30	85.72
36	57.24	68.66	87.59
37	58.24	70.35	89.03
38	59.30	71.97	90.83
39	60.70	74.40	93.51
40	61.23	75.19	94.18
41	62.26	76.69	95.87
42	64.26	79.55	99.42
43	64.87	80.67	100.29
44	65.30	81.42	100.97
45	66.69	83.87	103.17
46	67.16	84.40	104.19
47	67.98	85.90	105.63
48	69.77	88.43	108.51
49	70.03	88.88	108.81
50	71.14	90.30	109.94
52	73.26	93.47	113.53
54	75.44	96.83	117.11
56	77.73	99.80	120.72
58	79.89	102.86	124.12
60	82.13	105.92	127.41
62	84.30	108.76	130.81
64	86.67	111.70	134.10
66	88.89	114.42	137.76
68	92.54	119.52	143.89
70	94.85	122.13	146.92

*Visit [ups.com/holidays](https://www.ups.com/holidays) for time in transit changes effective during the holiday season.

Notes:

- For additional information, refer to pages 26 and 94.
- For a multiple-package shipment, the minimum charge will be based on an average weight of 15 pounds per package.

Import

UPS® Standard from Canada*

Zones	376	378	380
72 Lbs.	\$96.95	\$125.05	\$150.64
74	98.63	126.93	153.39
76	100.81	129.66	157.19
78	102.96	132.82	161.17
80	103.78	133.94	162.67
82	105.09	135.94	165.40
84	108.74	140.79	171.37
86	109.05	141.11	172.24
88	112.47	144.45	176.83
90	112.96	146.13	179.07
92	114.77	148.38	182.64
94	116.89	150.43	186.05
96	119.29	152.72	189.34
98	122.47	157.44	195.86
100	122.58	157.51	196.03
105	125.31	159.86	201.26
110	128.91	162.73	206.18
115	132.21	165.57	211.07
120	135.49	168.25	216.12
125	138.55	170.98	221.20
130	141.60	173.78	226.13
135	144.75	176.98	231.10
140	147.62	179.67	236.24
145	150.78	182.45	241.03
150	153.59	185.14	246.09

Shipments of More Than 150 Pounds

Zones	376	378	380
Price Per Pound	\$1.02	\$1.23	\$1.64
Minimum Rate	153.59	185.14	246.09

*Visit [ups.com/holidays](https://www.ups.com/holidays) for time in transit changes effective during the holiday season.

Note: For additional information, refer to pages [26](#) and [94](#).

Import

UPS® Standard from Mexico*

Guaranteed delivery by end of day to the 48 contiguous states within three to seven business days from all of Mexico. Rates include routine, in-house customs clearance by UPS Supply Chain Solutions®. Saturday Delivery available in select areas.

Zones	362	363	364	365	366	367	368
1 Lbs.	\$45.54	\$45.89	\$46.26	\$47.06	\$47.56	\$47.90	\$48.43
2	51.76	52.34	52.57	53.90	54.47	54.87	55.16
3	57.87	58.33	58.55	59.76	59.99	60.57	61.21
4	63.33	63.73	64.02	65.45	66.03	67.19	68.04
5	69.78	70.19	70.45	71.47	74.15	74.61	74.99
6	75.47	75.82	76.25	77.51	80.26	80.83	81.15
7	78.82	79.39	79.66	79.77	83.63	84.21	85.09
8	81.27	81.73	82.17	83.52	86.14	89.82	91.00
9	84.30	84.84	85.26	86.73	89.29	92.80	95.48
10	86.12	86.47	86.95	88.31	90.94	94.42	97.13
11	88.64	89.04	89.42	90.82	93.40	96.95	99.64
12	90.74	91.09	91.46	92.80	95.43	99.05	101.68
13	92.72	93.07	93.61	94.86	97.48	101.03	103.67
14	95.06	95.64	96.19	97.24	100.05	103.32	106.31
15	97.86	98.51	98.94	100.10	103.49	107.00	110.33
16	99.62	100.37	100.75	102.14	105.95	109.87	113.25
17	102.03	103.07	103.32	104.95	108.98	112.89	116.75
18	103.70	104.94	105.25	107.22	111.39	115.64	119.68
19	105.80	107.45	107.88	109.87	114.42	118.74	123.07
20	107.11	108.96	109.59	111.79	116.34	120.91	125.46
21	107.64	109.50	109.98	112.33	116.94	121.45	126.16
22	109.32	111.43	111.96	114.54	119.40	124.12	129.20
23	111.71	113.82	114.42	117.16	122.19	127.03	132.25
24	114.36	116.68	117.23	120.26	125.51	130.49	135.98
25	116.74	119.03	119.61	122.77	128.33	133.35	139.32
26	118.55	120.90	122.00	125.15	130.95	136.03	142.40
27	120.84	123.11	124.23	127.67	133.87	139.08	145.68
28	122.99	125.57	126.80	130.32	136.63	142.05	148.96
29	125.69	128.20	129.55	133.11	139.79	145.27	152.58
30	127.45	130.02	130.78	134.40	141.36	146.91	154.55
31	128.26	130.88	132.76	136.50	143.81	149.47	157.49
32	129.96	132.23	134.16	137.90	145.50	151.23	159.29
33	131.00	133.94	135.79	139.95	147.43	153.33	161.69
34	133.28	136.43	138.43	142.64	150.23	156.38	165.13
35	135.98	139.30	141.36	145.73	153.63	159.76	168.71

*Visit [ups.com/holidays](https://www.ups.com/holidays) for time in transit changes effective during the holiday season.

Notes:

- For additional information, refer to pages [26](#) and [94](#).
- For a multiple-package shipment, the minimum charge will be based on an average weight of 15 pounds per package.

Import

UPS® Standard from Mexico*

Zones	362	363	364	365	366	367	368
36 Lbs.	\$136.48	\$139.80	\$141.86	\$146.23	\$154.13	\$160.26	\$169.21
37	140.97	144.32	146.45	150.75	158.35	164.27	172.34
38	143.62	147.07	149.24	153.28	161.23	166.98	175.05
39	146.16	149.54	151.56	155.86	163.60	169.46	177.52
40	148.23	151.39	153.56	157.81	165.61	171.30	179.59
41	150.87	154.15	156.26	160.39	168.25	174.24	182.23
42	153.80	157.26	159.30	163.56	171.24	177.17	185.28
43	155.99	159.44	161.60	165.75	173.72	179.42	187.87
44	158.00	160.36	162.52	166.77	174.76	180.50	188.72
45	158.53	161.63	163.79	168.09	175.90	181.76	189.99
46	160.08	163.36	165.56	169.70	177.64	183.62	191.79
47	160.61	163.89	166.09	170.23	178.43	184.20	192.47
48	162.72	166.06	168.21	172.29	180.04	185.86	194.02
49	165.96	169.12	171.19	175.50	183.16	189.03	197.06
50	168.38	171.53	173.73	177.98	185.69	191.57	199.65
52	172.63	175.96	178.49	183.49	191.22	197.03	205.06
54	179.89	183.27	185.74	190.66	198.40	204.22	212.36
56	187.88	191.16	193.72	198.59	206.47	212.16	220.23
58	193.00	196.28	198.77	203.76	211.53	217.22	225.34
60	198.23	201.40	203.94	208.87	216.72	222.41	230.42
62	203.24	206.57	209.00	213.94	221.84	227.54	235.58
64	207.27	210.56	213.53	219.10	227.82	236.11	243.24
66	212.29	215.62	218.59	224.27	233.01	241.23	248.30
68	217.47	220.69	223.65	229.44	238.13	246.23	253.42
70	222.69	225.92	228.76	234.50	243.30	251.41	258.63
72	227.76	230.98	233.86	239.56	248.30	256.54	263.76
74	233.01	236.22	239.10	244.73	253.56	261.72	268.87
76	236.39	239.68	242.61	249.84	258.68	268.56	274.86
78	241.58	245.02	247.82	255.36	264.07	274.03	280.50
80	242.72	246.06	248.85	256.32	265.17	275.01	281.36
82	246.64	249.97	252.77	260.12	268.97	278.88	285.10
84	251.76	254.98	257.82	265.29	273.92	283.87	290.15
86	257.00	260.34	262.98	270.33	279.22	289.00	295.33
88	262.12	265.34	268.23	275.57	284.17	294.23	300.51
90	267.29	270.75	273.39	280.74	289.45	299.70	305.50

*Visit [ups.com/holidays](https://www.ups.com/holidays) for time in transit changes effective during the holiday season.

Note: For additional information, refer to pages [26](#) and [94](#).

Import

UPS® Standard from Mexico*

Zones	362	363	364	365	366	367	368
92 Lbs.	\$273.01	\$276.22	\$278.89	\$285.85	\$294.40	\$304.60	\$310.63
94	278.75	281.69	284.54	291.02	299.35	309.54	315.62
96	284.10	287.04	289.98	296.14	304.25	314.32	320.51
98	289.00	291.35	294.58	300.33	308.33	318.64	324.89
100	293.95	295.73	299.34	304.63	312.71	323.01	329.42
105	295.05	296.87	300.04	305.16	313.69	323.82	329.95
110	304.66	306.26	308.31	312.97	320.48	330.49	336.72
115	315.59	317.72	319.98	324.23	331.93	342.24	348.58
120	328.65	330.33	332.95	336.92	344.87	355.58	362.09
125	333.20	335.10	337.72	341.17	349.25	359.73	366.16
130	345.12	347.47	350.06	353.24	361.35	371.93	378.53
135	356.97	359.79	362.59	365.18	373.37	383.79	390.78
140	360.14	363.06	365.75	367.76	375.84	385.91	392.73
145	375.97	379.35	382.24	383.79	391.96	402.04	409.17
150	389.43	393.34	396.36	397.47	405.61	415.62	422.92

Shipments of More Than 150 Pounds

Zones	362	363	364	365	366	367	368
Shipments of 151 to 199 Pounds							
Price Per Pound	\$2.60	\$2.63	\$2.65	\$2.65	\$2.71	\$2.78	\$2.82
Minimum Rate	389.43	393.34	396.36	397.47	405.61	415.62	422.92
Shipments of 200 Pounds or More							
Price Per Pound	\$2.49	\$2.49	\$2.49	\$2.51	\$2.56	\$2.62	\$2.68
Minimum Rate	516.64	521.83	525.84	527.30	538.10	551.39	561.08

*Visit [ups.com/holidays](https://www.ups.com/holidays) for time in transit changes effective during the holiday season.

Note: For additional information, refer to pages [26](#) and [94](#).

Value-Added Services

Value-added services are available for the UPS services indicated. For additional information and rates, refer to pages [114-119](#).

	Domestic							International							Page				
	UPS Next Day Air® Early	UPS Next Day Air®	UPS Next Day Air Saver®	UPS 2nd Day Air A.M.®	UPS 2nd Day Air®	UPS 3 Day Select®	UPS® Ground	UPS® Ground with Freight Pricing	UPS Worldwide Express Plus®	UPS Worldwide Express NA1®	UPS Worldwide Express®	UPS Worldwide Express Freight® Midday	UPS Worldwide Express Freight®	UPS Worldwide Saver®	UPS Worldwide Expedited®	UPS 3 Day Select® from Canada	UPS® Standard to/from Canada	UPS® Standard to/from Mexico	
Delivery Instructions and Notification																			
Adult Signature Required	●	●	●	●	●	●	●	●	●	●	●	●	●	●	●	●	●	●	118
Collect on Delivery (C.O.D.) Services	●	●	●	●	●	●	●	●								●	●		114
Delivery Change Request	●	●	●	●	●	●	●	●	●	●	●	●	●	●	●	●	●	●	115
UPS Delivery Confirmation		●	●	●	●	●	●	●											115
UPS Delivery Intercept®	●	●	●	●	●	●	●	●											115
Direct Delivery Only	●	●	●	●	●	●	●	●	●	●	●	●	●	●	●	●	●	●	116
Hold at Location											●	●							116
Hold for Pickup	●	●	●	●	●	●	●	●											116
UPS My Choice® for Business	●	●	●	●	●	●	●	●	●	●	●	●	●	●	●	●	●	●	117
UPS My Choice®	●	●	●	●	●	●	●	●	●	●	●	●	●	●	●	●	●	●	117
Proof of Delivery (P.O.D.)	●	●	●	●	●	●	●	●	●	●	●	●	●	●	●	●	●	●	118
Saturday Delivery*	●	●		●	●	●	●	●	●	●	●	●	●			●	●	●	118
Shipper Release	●	●	●	●	●	●	●	●											121
Signature Required		●	●	●	●	●	●	●	●	●	●	●	●	●	●	●	●	●	118
International Shipping																			
Billing Options																			
Certificate of Origin									●	●	●	●	●	●	●	●	●	●	114
Currency Conversion Rate									●	●	●	●	●	●	●	●	●	●	115
Electronic Export Information (E.E.I.)									●	●	●	●	●	●	●	●	●	●	116
UPS Import Control®									●	●	●	●	●	●	●	●	●	●	116
Non-Resident Importer (NRI)									●	●	●	●	●	●	●	●	●	●	118
World Ease®									●	●	●	●	●	●	●	●	●	●	121
Pickup																			
Daily On-Route Pickup	●	●	●	●	●	●	●	●	●	●	●			●	●	●	●	●	120
Daily Pickup	●	●	●	●	●	●	●	●	●	●	●			●	●	●	●	●	120
Day-Specific Pickup	●	●	●	●	●	●	●	●	●	●	●			●	●	●	●	●	120
Saturday Air Processing Fee (Saturday Pickup)	●	●	●	●	●														120
Saturday Export Processing Fee								●	●				●						120
Saturday Stop Charge** – UPS Smart Pickup®	●	●	●	●	●	●	●	●											120
Saturday Stop Charge** – Scheduled Pickup	●	●	●	●	●	●	●	●											120
Saturday Stop Charge** – UPS On-Call Pickup®	●	●	●	●	●	●	●	●											120
UPS On-Call Pickup®	●	●	●	●	●	●	●	●	●	●	●	●	●	●	●	●	●	●	118
UPS Smart Pickup®	●	●	●	●	●	●	●	●	●	●	●			●	●	●	●	●	120
Returns***																			
1 UPS Pickup Attempt Label	●	●		●	●	●	●	●	●	●	●	●	●	●	●	●	●	●	119
3 UPS Pickup Attempts Label	●	●		●	●	●	●	●	●	●			●	●	●	●	●	●	119
UPS Authorized Return Service®		●		●	●	●	●	●											119
Electronic Return Label	●	●		●	●	●	●	●	●	●	●	●	●	●	●	●	●	●	119
Print and Mail Return Label	●	●		●	●	●	●	●	●	●	●	●	●	●	●	●	●	●	119
Print Return Label	●	●		●	●	●	●	●	●	●	●	●	●	●	●	●	●	●	119
Returns and The UPS Store®	●	●		●	●	●	●	●	●	●	●			●	●	●	●	●	119
UPS Returns® Exchange	●	●		●	●	●	●	●	●	●	●			●	●	●	●	●	119
Additional Options																			
Branded Tracking from UPS	●	●	●	●	●	●	●	●	●	●	●	●	●	●	●	●	●	●	114
UPS carbon neutral	●	●	●	●	●	●	●	●	●	●	●	●	●	●	●	●	●	●	114
Declared Value for Carriage	●	●	●	●	●	●	●	●	●	●	●	●	●	●	●	●	●	●	115
UPS® Premier	●	●	●																118
Ship to a UPS Access Point® Location	●	●	●	●	●	●	●	●	●	●	●	●	●	●	●	●	●	●	118
Third Party Billing Service	●	●	●	●	●	●	●	●	●	●	●	●	●	●	●	●	●	●	121

*Saturday Delivery is only available for UPS 3 Day Select, UPS Ground, UPS Ground with Freight Pricing, UPS Standard from Canada and UPS Standard from Mexico services in select areas. Saturday Delivery is not available for UPS Standard to Canada or UPS Standard to Mexico services.

**Saturday Pickup is only available for UPS 3 Day Select, UPS Ground and UPS Ground with Freight Pricing services in select areas.

***UPS Returns® Service options for UPS® Simple Rate are limited to UPS Print Return Label Service only.

Other Charges

Additional charges may apply to your shipment. For additional information and rates, refer to pages [122-125](#).

	Domestic										International										Page
	UPS Next Day Air® Early	UPS Next Day Air®	UPS Next Day Air Saver®	UPS 2nd Day Air A.M.®	UPS 2nd Day Air®	UPS 3 Day Select®	UPS® Ground	UPS® Ground with Freight Pricing	UPS Worldwide Express Plus®	UPS Worldwide Express NA1®	UPS Worldwide Express®	UPS Worldwide Express Freight® Midday	UPS Worldwide Express Freight®	UPS Worldwide Express Saver®	UPS Worldwide Expedited®	UPS 3 Day Select® from Canada	UPS® Standard to/from Canada	UPS® Standard to/from Mexico			
Additional Handling	●	●	●	●	●	●	●	●	●	●	●	●	●	●	●	●	●	122			
Address Correction	●	●	●	●	●	●	●	●	●	●	●	●	●	●	●	●	●	122			
Chargeback for Consignee Billing Shipments	●	●	●	●	●	●	●	●	●	●	●	●	●	●	●	●	●	122			
Dangerous Goods																					
– International Dangerous Goods								●	●	●	●	●	●	●	●	●	●	123			
– Hazardous Materials	●	●	●	●	●	●	●											123			
– Dry Ice	●	●	●	●	●	●	●	●	●	●	●	●	●	●	●	●	●	123			
Delivery Area Surcharge	●	●	●	●	●	●	●	●	●	●	●	●	●	●	●	●	●	122			
Delivery Reattempt											●	●						122			
Destination Outside Service Area	●																	122			
Extended Area Surcharge								●	●	●	●	●	●	●	●	●	●	123			
Large Package Surcharge	●	●	●	●	●	●	●	●	●	●	●	●	●	●	●	●	●	123			
Missing PLD Fee	●	●	●	●	●	●	●	●	●	●	●	●	●	●	●	●	●	124			
Missing/Invalid Account Number or Refusal Fee	●	●	●	●	●	●	●	●	●	●	●	●	●	●	●	●	●	124			
UPS On-Call Pickup® Area Surcharge	●	●	●	●	●	●	●	●		●			●	●		●	●	124			
Over Maximum Limits	●	●	●	●	●	●	●	●	●	●			●	●	●	●	●	124			
Oversize Pallet Handling Surcharge											●	●						124			
Package Tracking, Tracing and Refund Requests	●	●	●	●	●	●	●	●	●	●	●	●	●	●	●	●	●	124			
Pickup Area Surcharge											●	●						124			
Prohibited Item Fee	●	●	●	●	●	●	●	●	●	●	●	●	●	●	●	●	●	124			
Rebill Fee	●	●	●	●	●	●	●	●	●	●	●	●	●	●	●	●	●	124			
Remote Area Surcharge	●	●	●	●	●	●	●	●	●	●	●	●	●	●	●	●	●	125			
Residential Surcharge	●	●	●	●	●	●	●	●	●	●	●	●	●	●	●	●	●	125			
Shipping Charge Correction Audit Fee*	●	●	●	●	●	●	●	●		●	●	●	●	●		●	●	125			
Special Handling of Undeliverable Shipments	●	●	●	●	●	●	●											125			
Undeliverable Shipment Surcharge								●	●	●	●	●	●	●	●	●	●	125			

*Shipping Charge Correction Audit Fee does not apply to import shipments.

Notes:

- Peak Surcharges also apply to certain packages tendered during Peak Periods. See [ups.com/peaksurcharges](https://www.ups.com/peaksurcharges) for details.
- The following surcharges do not apply to UPS® Simple Rate shipments: Delivery Area Surcharge, Delivery Area Surcharge Extended, Residential Surcharge and fuel surcharges. All other charges apply to UPS Simple Rate shipments.

Domestic, Export and Import Value-Added Services

PACKAGE

Unless otherwise noted, UPS rates are per package for domestic services and per shipment for international services.

Available Options	Description	Fee
Billing Options	<ul style="list-style-type: none"> – If the duties or the duties and taxes are billed outside the destination country, a Duty and Tax Forwarding Charge will be applied. – UPS can bill shipping charges to the shipper, the receiver or a third party to and from most countries. Check your UPS Shipping System or contact UPS for service availability. 	\$15.00
Branded Tracking from UPS	<ul style="list-style-type: none"> – A turn-key solution that merges UPS® tracking with your company's branding to help re-engage customers and promote sales. – Create a custom shipment tracking page that looks like your website but is hosted by UPS. – Easy to set up and start quickly. – Learn more at solutions.ups.com/ups-branded-tracking-lp.html. 	Contractual service
UPS carbon neutral	<ul style="list-style-type: none"> – UPS calculates the CO₂ emissions associated with the transport of your package and purchases carbon offsets to balance out the CO₂ impact. – Available to shippers using a UPS automated shipping system. – The shipping label will include a carbon neutral indicator. Also, if you select e-mail notifications, your recipient will receive a UPS carbon neutral branded e-mail. – Learn more at ups.com/carbonneutral. 	Per package charge: – UPS Domestic Air Services and UPS 3 Day Select®: \$0.20 – UPS® Ground and UPS® Standard: \$0.05 – UPS International Air Services and UPS 3 Day Select® from Canada: \$0.75 Per pallet charge: – UPS Worldwide Express Freight® Services: \$20.00
Certificate of Origin	<ul style="list-style-type: none"> – Can be prepared by UPS on behalf of the shipper for exported goods manufactured and originating within the U.S. 	\$10.00
Collect on Delivery (C.O.D.) Services	<ul style="list-style-type: none"> – UPS will attempt to collect the amount shown on C.O.D. tag or package label, then send payment to you. If payment cannot be collected after three attempts, the package will be returned. – C.O.D. service is available for packages shipped throughout the U.S. and Puerto Rico. – Also available for imports from Canada where the fee would apply per package. – Business or personal checks are accepted as payment. Currency is not accepted for payment. – C.O.D. service is not available when using a UPS 3 Day Select or UPS Ground shipping document. Refer to page 22 for an explanation of these documents. 	
UPS C.O.D.	To request a C.O.D. electronically: <ul style="list-style-type: none"> – Service is available by using a UPS automated shipping system. – The shipping system will produce a barcoded address label that contains all C.O.D. information. To request a C.O.D. using a manual tag: <ul style="list-style-type: none"> – Type or print an address label and attach it to the top of the package. – Complete the UPS C.O.D. tag per the instructions on the tag and specify the exact amount due. – Attach C.O.D. tag to each package requiring collection, covering the address label. – Retain the "Shipper Receipt" portion for your records. 	\$16.50
C.O.D. Direct®*	<ul style="list-style-type: none"> – Receive C.O.D. payments generally within six business days of package delivery. – Direct electronic transfer of funds into your designated accounts; timely alert of non-sufficient funds. – Receive daily reports of payments received, net deposits to accounts and total returned items. – Must have minimum annual 50 C.O.D. packages to qualify. – No additional fee beyond the C.O.D. rate. Please contact your account representative or call 1-877-263-8772 for details. 	Contractual service
C.O.D. Automatic®*	<ul style="list-style-type: none"> – Receive advanced C.O.D. funds in as few as two days after package delivery. – Direct electronic transfer of funds into your designated accounts; timely alert of non-sufficient funds. – Receive daily reports of payments received, net deposits to accounts and total returned items. – Online access to statement history, check images and downloadable transaction details. – Must have minimum annual C.O.D. remittances of \$30,000.00 and at least 100 C.O.D. packages to qualify. – Please contact your account representative or call 1-877-263-8772 for details. 	Contractual service
Delayed Deposit for C.O.D. Direct and C.O.D. Automatic*	<ul style="list-style-type: none"> – Additional feature of C.O.D. Direct and C.O.D. Automatic services. – Eliminates manual handling of checks held for delayed deposits by electronically scheduling future deposits directly into your designated accounts; includes online, self-service capabilities. – Please contact your account representative or call 1-877-263-8772 for details. 	Contractual service

*Visit upscapital.com/cod or call 1-877-263-8772 for more information.

Notes:

- The value-added services listed are available for UPS domestic, international package, UPS Worldwide Express Freight® Midday and UPS Worldwide Express Freight services unless otherwise noted on page 112.
- Fuel surcharges apply to value-added services associated with pickup, transport and delivery. For current fuel surcharges, where applicable, visit ups.com.

Domestic, Export and Import Value-Added Services

PACKAGE

Unless otherwise noted, UPS rates are per package for domestic services and per shipment for international services.

Available Options	Description	Fee
Collect on Delivery (C.O.D.) Services (cont.) C.O.D. Secure**	<ul style="list-style-type: none"> – Receive all the benefits of C.O.D. Automatic® service, along with protection for returned C.O.D. checks up to a specified limit. – UPS Capital® handles/manages the collections process on bad checks. – Must have minimum annual C.O.D. remittances of \$50,000.00 and at least 50 C.O.D. packages to qualify. – Please contact your account representative or call 1-877-263-8772 for details. 	Contractual service
Currency Conversion Rate	– Charges to a payer's account in a foreign currency will be converted to the payer's currency using a weekly exchange rate secured through major money center banks.	0.75% of currency amount converted
Declared Value for Carriage	<ul style="list-style-type: none"> – UPS's liability for loss or damage for each domestic package or international shipment, or to each pallet in a UPS Worldwide Express Freight® Middyay or UPS Worldwide Express Freight® shipment is limited to \$100.00 without a declaration of value. – The maximum declared value is \$50,000.00 per package/\$100,000.00 per pallet shipped via UPS Worldwide Express Freight Middyay and UPS Worldwide Express Freight services. UPS's liability for loss or damage can be increased up to \$50,000.00 per package or \$100,000.00 per pallet by making a declaration of value for an additional charge (subject to terms and conditions). Certain domestic packages are eligible for the enhanced maximum declared value of \$70,000.00, subject to restrictions set forth in the "UPS Tariff/Terms and Conditions of Service – United States" available at ups.com/terms and also set forth in "Maximum Declared Values" on page 8. – Declarations of value from \$100.01 to \$300.00 are subject to a charge of \$3.45. Declarations of value over \$300.00 incur a charge for each \$100.00 (or portion of \$100.00) of the total value declared, including the first \$100.00. For example, a declaration of \$950.00 value incurs a charge of \$11.50 (10 times \$1.15). – For international shipments with a declared value of more than \$50,000.00, multiply the total declared value by the rate to determine the declared value charge for the shipment. – For packages tendered to a UPS driver with a declared value amount of more than \$1,000.00, the shipper must retain a high-value shipment summary signed by the driver. The UPS Shipping System provides this form when the shipping label is requested. – Declared value charges can be included in charges billed to receivers or third parties. 	<ul style="list-style-type: none"> – Value from \$100.01 to \$300.00 \$3.45 – Value over \$300.00, charge for each \$100.00 (or portion of \$100.00) of the total value declared (from \$0.00 to total value declared) \$1.15 – For international shipments with a declared value of more than \$50,000.00: \$0.009 times the declared value
Delivery Change Options	– In addition to Delivery Change Option fees, additional transportation charges and all applicable surcharges may apply. Refer to the "UPS Tariff/Terms and Conditions of Service – United States" available at ups.com/terms for more information.	
UPS Delivery Intercept®	<ul style="list-style-type: none"> – As a shipper, after you tender your package to UPS, you can request that UPS return the package to you**, reroute the package to a new address**, have the package available at Will Call for pickup or have the package delivered on a future date. When the package is tracked, the status of the UPS Delivery Intercept request will be displayed. – Shippers can make a UPS Delivery Intercept request through the Shipping History with WorldShip® or UPS CampusShip® shipping systems, ups.com shipping, Quantum View Manage® or UPS tracking on ups.com. A UPS Delivery Intercept request can also be made by calling 1-800-PICK-UPS® (1-800-742-5877). 	UPS Delivery Intercept: <ul style="list-style-type: none"> – \$17.60 for web requests – \$24.90 for phone requests – No charge for Will Call
Delivery Change Request	<ul style="list-style-type: none"> – For domestic packages and import shipments only. After the first delivery attempt has occurred, consignees may, via the tracking application on ups.com or by calling 1-800-PICK-UPS® (1-800-742-5877), request the following Delivery Change Requests for a package or pallet: Return to sender**, Hold for future delivery, Change a domestic package's delivery location** (but not a pallet's), Deliver** eligible domestic packages to a UPS Access Point® location, Redeliver to the original address a package that was taken to a UPS Access Point location, and Request that UPS hold a package for Will Call at a UPS Customer Center. – A UPS InfoNotice® number is required to change the destination delivery address. 	Delivery Change Requests for a package or pallet: <ul style="list-style-type: none"> – Return to sender** - Free – Hold for future delivery - \$11.99 – Change a domestic package's delivery location** (but not a pallet's) - \$16.99 – Deliver** eligible domestic packages to a UPS Access Point location - \$7.99 – Redeliver to the original address a package that UPS elected to deliver to a UPS Access Point location without your request - Free – Request that UPS hold a package for Will Call or Same Day Will Call at a UPS Customer Center - \$7.99
UPS Delivery Confirmation	<ul style="list-style-type: none"> – Confirmation of delivery is sent by mail, and includes the delivery date, either the name of the recipient or the package disposition, and in the event of a return, the reason for the return. – Similar information, including the ability to view a signature, is available for no charge when you track your package at ups.com. 	\$2.00

*Visit [upscapital.com/cod](https://www.ups.com/cod) or call 1-877-263-8772 for more information.

**Additional transportation fees and all applicable surcharges may apply. For requests to return to the sender, any such fees will be assessed to the shipper. Refer to the "UPS Tariff/Terms and Conditions of Service – United States" available at [ups.com/terms](https://www.ups.com/terms) for more information.

Notes:

- The value-added services listed are available for UPS domestic, international package, UPS Worldwide Express Freight Middyay and UPS Worldwide Express Freight services unless otherwise noted on page 112.
- Fuel surcharges apply to value-added services associated with pickup, transport and delivery. For current fuel surcharges, where applicable, visit [ups.com](https://www.ups.com).

Domestic, Export and Import Value-Added Services

PACKAGE

Unless otherwise noted, UPS rates are per package for domestic services and per shipment for international services.

Available Options	Description	Fee
Direct Delivery Only	<ul style="list-style-type: none"> – Except for shipper requests, where available, the package may not be re-routed, re-directed or delivered to an alternate address (except requests to hold for Will Call at UPS Customer Centers). – Delivery pursuant to UPS's driver release and Shipper Release procedures is still available. Signature on delivery and delivery to the person specified as the receiver not required. – Available for residential and commercial delivery. 	\$2.00
Electronic Export Information (E.E.I.) formerly known as Shipper's Export Declaration (S.E.D.)	<ul style="list-style-type: none"> – UPS can file E.E.I. on your behalf when all required data is provided with the proper Power of Attorney. – Providing E.E.I. as part of a shipment using WorldShip®, UPS CampusShip® or ups.com shipping systems ensures that UPS has all the information to file E.E.I. in a timely manner. – File E.E.I. free of charge at cbp.gov/ace, the U.S. Government website designed for U.S. export shippers. 	\$15.00
Hold at Location	<ul style="list-style-type: none"> – For UPS Worldwide Express Freight® Middyay or UPS Worldwide Express Freight® shipments, the shipper may request that UPS hold a shipment at a UPS Worldwide Express Freight Center location for pickup. For each such shipment, the shipper will complete an address label showing the words "Hold for Pickup," the consignee's name, telephone number, the name of a contact person and the full address of the consignee (designated UPS Worldwide Express Freight Center address not required). 	No charge
Hold for Pickup	<ul style="list-style-type: none"> – UPS will deliver the package to a selected UPS Customer Center and call the recipient for pickup, usually by 8:30 a.m. on the scheduled day of delivery. – Recipient will be required to present a government-issued photo ID. – If a recipient's representative is picking up the package, a letter on company letterhead authorizing release or a company ID may be required. – Packages not picked up within five business days will be returned to the shipper. – Hold for Pickup service is not available for Saturday Delivery. – For each package, customers must prepare a label including the words "Hold for Pickup," the recipient's name and telephone number and the full address of the UPS Customer Center. – Apply a UPS Hold for Pickup label above the address label on the package. Labels can be ordered from ups.com. – Visit ups.com for the most convenient UPS Hold for Pickup location. 	No charge
UPS Import Control®		
Print Label	– You generate the label(s) and distribute to your customer, who applies it to the shipment.	\$1.05 per label
Electronic Label	– UPS e-mails the label(s) upon request to your customer, who then prints and applies the label(s) to the shipment.	\$1.05 per label
Print and Mail Label	– UPS prints the label(s) upon request and mails it to your customer, who then applies the label(s) to the shipment.	\$2.25 per label
1 UPS Pickup Attempt Label	– UPS delivers a shipping label to your customer and collects the shipment. If the shipment cannot be picked up on the first attempt, UPS will leave the label at the pickup location.	\$6.00 per label
3 UPS Pickup Attempts Label*	– UPS delivers a shipping label to your customer and collects the shipment. If the shipment cannot be picked up on the first attempt, UPS will only make two more pickup attempts over the next two business days.	\$8.20 per label
Invoice Removal	– UPS removes the commercial invoice prior to delivery, which keeps merchandise values confidential from the final consignee.	\$20.00 per shipment

GENERAL INFORMATION REGARDING UPS IMPORT CONTROL

- Importers initiate UPS shipments from another country, delivering to themselves or an alternate location.
- Allows importers to use a UPS automated shipping system or their own system to generate labels and commercial invoices, which can be forwarded to a supplier/exporter in another country by e-mail, mail or via a UPS driver with a pickup dispatch.
- Includes import document preparation, pickup, customs clearance, visibility and delivery.
- Facilitates pickup/delivery in over 145 countries and territories; varies by country; transportation charges based upon the scheduled delivery date.
- Exporter will be responsible for meeting export/import documentation requirements; to facilitate export, exporter may receive an Instruction Sheet with every label delivered to them.
- Shipments containing certain items including, but not limited to, Hazardous Materials or Dangerous Goods requiring shipping papers are not allowed in UPS Import Control shipments.
- Transportation charges for return packages are billed after entering the UPS system.
- Print and Mail Label, 1 UPS Pickup Attempt Label and 3 UPS Pickup Attempts Label accessorials are billed at the time of request. Print Label and Electronic Label fees are billed after the package enters the UPS system.
- Regulations and requirements for documentation for individual commodities vary from country to country. See ups.com for country-specific rules.
- Shipments with a package or pallet valued greater than \$1,000.00 (or local equivalent) must include a high-value shipment summary from the exporter with the labels and must be signed by the driver.

*Not available for UPS Worldwide Express Freight Services.

Notes:

- The value-added services listed are available for UPS domestic, international package, UPS Worldwide Express Freight Middyay and UPS Worldwide Express Freight services unless otherwise noted on page [112](#).
- Fuel surcharges apply to value-added services associated with pickup, transport and delivery. For current fuel surcharges, where applicable, visit ups.com.

Domestic, Export and Import Value-Added Services

PACKAGE

Unless otherwise noted, UPS rates are per package for domestic services and per shipment for international services.

Available Options	Description	Fee
UPS My Choice® for Business	<ul style="list-style-type: none"> – A new web-based tool designed to give commercial and home-based businesses better control and visibility into their shipments, allowing them to easily manage their UPS services from a customizable dashboard. • View, at a glance, all inbound and outbound shipments with interactive dashboards to easily track shipments. • View estimated delivery windows to prepare incoming shipments. • Filter by date, shipment characteristics or accounts with updates from label creation to delivery. • View current shipment status to provide more accurate timing to customers and help resolve any issues. • Set notifications preferences to get automatic status alerts, including for the day before and day of delivery. • Enable additional users within your organization to access important visibility information. • Learn more and enroll any time at: ups.com/mychoiceforbusiness. 	<ul style="list-style-type: none"> Change Requests for a package or pallet – Return to sender** - Free – Hold for future delivery - Free – Change a domestic package's delivery location** (but not a pallet's) - \$14.99 – Deliver** eligible domestic packages to a UPS Access Point® location - \$5.99 – Request that UPS hold a package for Will Call or Same Day Will Call at a UPS Customer Center - \$5.99 – Redeliver to the original address a package that UPS elected to deliver to a UPS Access Point location without your request - Free
UPS My Choice®	<p>UPS My Choice service helps shippers to:</p> <ul style="list-style-type: none"> – Ensure delivery on the first attempt – Maintain superior customer service – Reduce tracking calls and returns – Improve online purchasing experience <p>With two levels of membership, UPS My Choice service provides recipients with online and mobile access to flexible delivery options to manage their home deliveries.</p> <ul style="list-style-type: none"> – Available in 112 countries 	
UPS My Choice® Member	<ul style="list-style-type: none"> – Proactive alerts via text,* e-mail or UPS® Mobile App push notification. – Provides an online Delivery Planner to help manage and track recipients' home deliveries. – Recipients may give authorization online for UPS to deliver packages without a signature. – Leave a package with a neighbor (someone within walking distance of the original delivery address). – UPS will provide delivery information, typically a four-hour approximate delivery time. – Follow My Delivery (FMD), map-based tracking notification sent morning of delivery, enables you to track premium and UPS® Ground package deliveries in real time. – Manage premium and Ground package deliveries with real-time, map-based tracking. – Set a vacation and have eligible domestic packages delivered to a UPS Access Point location and pick up within seven calendar days (unless shipper provides otherwise).** <p>Service upgrades:</p> <ul style="list-style-type: none"> – Deliver eligible packages to another address or on another day: <ul style="list-style-type: none"> • Redeliver to My Address: If UPS elected to deliver packages to a UPS Access Point location without your request, recipient can request that eligible packages be delivered back to the original address. • Deliver to a UPS Access Point location:** Have eligible domestic packages delivered to a location of The UPS Store® or UPS Access Point location (where available – refer to the "UPS Tariff/Terms and Conditions of Service – United States" available at ups.com/terms). • Request that UPS hold a package for Will Call or Same Day Will Call at a UPS Customer Center. • Deliver package on another day. • Deliver package to another address.** • Set a vacation and have all packages delivered on one of the three business days after the vacation ends. – Confirmed Delivery Window: Select a two-hour confirmed delivery window. – Upgrade UPS SurePost® service*** to UPS Ground. 	<ul style="list-style-type: none"> Free No additional charge \$5.99 per package \$5.99 per package \$9.99 per package \$14.99 per package \$9.99 per package \$14.99 per shipment \$7.99 per package
UPS My Choice® Premium Member	<ul style="list-style-type: none"> – Includes same features as a UPS My Choice Member in addition to the following: <ul style="list-style-type: none"> • Unlimited deliveries of eligible packages to another address** • Unlimited deliveries on another day (including vacation holds) <p>Service upgrades:</p> <ul style="list-style-type: none"> – Redeliver to My Address: If UPS elected to deliver packages to a UPS Access Point location without your request, recipient can request that eligible packages be delivered back to the original address. – Confirmed Delivery Window: <ul style="list-style-type: none"> • Two confirmed delivery window (two-hour) requests annually • Additional confirmed delivery window requests – Unlimited upgrades from UPS SurePost service*** to UPS Ground. 	<ul style="list-style-type: none"> \$19.99 annual fee No additional charge No additional charge \$14.99 per shipment No additional charge

*Your carrier's standard message and data rates may apply.

**Additional transportation fees and all applicable surcharges may apply. For requests to return to the sender, any such fees will be assessed to the shipper. Refer to the "UPS Tariff/Terms and Conditions of Service – United States" available at ups.com/terms for more information.

***UPS SurePost is a contract-only, non-guaranteed economy residential service with final delivery typically provided by the U.S. Postal Service.

Notes:

– The value-added services listed are available for UPS domestic, international package, UPS Worldwide Express Freight® Midday and UPS Worldwide Express Freight services unless otherwise noted on page 112.

– Fuel surcharges apply to value-added services associated with pickup, transport and delivery. For current fuel surcharges, where applicable, visit ups.com.

Domestic, Export and Import Value-Added Services

PACKAGE

Unless otherwise noted, UPS rates are per package for domestic services and per shipment for international services.

Available Options	Description	Fee
Non-Resident Importer (NRI)	<ul style="list-style-type: none"> – Applicable when shipping to Canada via UPS Air or UPS® Ground shipments. – A Non-Resident Importer is a shipper in the U.S. who acts as the importer of record to the Canadian government. – An NRI account allows you to pay the duties, taxes and brokerage charges for shipments to Canada, simplifying the experience for your consignee. – Shipper files the Power of Attorney (clearance authorization) with UPS for clearance of goods in Canada and is responsible for the payment of all Canadian duties, taxes and brokerage fees. – UPS will automatically charge all Canadian duties, taxes and brokerage fees to the shipper's NRI brokerage account. – Consignee is not involved in the customs clearance process. – Shipper undertakes all importing responsibilities as required by Canadian law. – Shipper must maintain records on all importation into Canada for a period of time prescribed by the Canadian government (for U.S. NRI account holders, that period is six years). – NRI option can be utilized on UPS Air or UPS Ground shipments. – Contact your UPS representative if you would like to set up an NRI account. 	No charge
UPS On-Call Pickup®	<ul style="list-style-type: none"> – With one pickup request, UPS will pick up all of your packages – Air, International, UPS 3 Day Select® and Ground services at your office or home. – Schedule a same-day or future-day pickup via ups.com. – At ups.com, send an e-mail confirmation of your pickup request to multiple addresses, modify your pickup request or cancel the request. – Fees are applied per pickup request regardless of the number of packages being picked up. <p>UPS Worldwide Express Freight® MIDDAY and UPS Worldwide Express Freight®</p> <ul style="list-style-type: none"> – Pickup or drop-off must be scheduled for each UPS Worldwide Express Freight MIDDAY and UPS Worldwide Express Freight shipment via WorldShip® shipping system or UPS CampusShip® shipping systems, ups.com shipping, a UPS Ready® solution, UPS® Developer Kit, ups.com or by calling 1-800-782-7892. – UPS Worldwide Express Freight MIDDAY and UPS Worldwide Express Freight pickups cannot be combined with Air, International or UPS 3 Day Select services package pickup. 	<p>Package</p> <ul style="list-style-type: none"> – Same-Day Pickup: \$6.90 – Future-Day Pickup: \$5.80 – Residential and area surcharges may apply <p>UPS Worldwide Express Freight Services</p> <p>No charge</p>
UPS® Premier	<ul style="list-style-type: none"> – Proactive monitoring and intervention service for UPS Next Day Air®, UPS Next Day Air® Early, and UPS Next Day Air Saver® shipments. – UPS provides 24-hour-a-day, seven-day-a-week support for these shipments. – Intervention is available for these shipments to help ensure service commitments and shipment integrity. – Ideal for customers shipping critical high-value, time- or temperature-sensitive products that require an additional layer of protection. 	Contractual service
Proof of Delivery (P.O.D.)	<ul style="list-style-type: none"> – Proof of Delivery of a shipment can be requested after the shipment has been delivered by calling 1-800-PICK-UPS® (1-800-742-5877). – Proof of Delivery includes the time of delivery, full delivery address and the name and signature of the person who accepted your shipment, if available. – Information can be provided via e-mail, fax or mail and is subject to a charge which will be assessed to the shipper. – Similar information is available for no charge when you track your shipment at ups.com. 	\$3.00 per package
Saturday Delivery	<ul style="list-style-type: none"> – For time-critical shipments, UPS offers the convenience of Saturday Delivery in select locations. – UPS Next Day Air® Early shipments are typically guaranteed one hour later than the guaranteed weekday delivery time to many UPS Next Day Air Early destinations. – UPS Next Day Air shipments are typically guaranteed an hour and a half later than the guaranteed weekday delivery time. – UPS 2nd Day Air® shipments are guaranteed by end of day. – UPS Worldwide Express Plus®, UPS Worldwide Express NA1® and UPS Worldwide Express services available to/from select locations. – UPS 3 Day Select and UPS Ground shipments to commercial delivery addresses within Saturday Ground Service Territories are guaranteed by end of day, if Saturday Delivery is requested by the shipper at the time of shipping. Commercial consignees in Saturday Ground Service Territories also are eligible to receive deliveries for UPS 3 Day Select, UPS Ground, UPS Ground with Freight Pricing, UPS® Standard from Canada and UPS® Standard from Mexico services on Saturday, if the consignee has a Saturday Scheduled Pickup and has opted in to receive such deliveries, but not by request. – UPS 3 Day Select, UPS Ground, UPS Ground with Freight Pricing, UPS® Standard from Canada and UPS® Standard from Mexico services are available to residential addresses within Saturday Ground Service Territories, but not by request. – Where Saturday Delivery is requested for UPS Air and international services, each package or pallet must have a Saturday Delivery routing label. A Saturday Delivery routing label is not required for UPS 3 Day Select, UPS Ground, UPS Ground with Freight Pricing, UPS Standard from Canada and UPS Standard from Mexico services. – Availability of Saturday Delivery may vary based on location of delivery address. Refer to ups.com for delivery areas. 	<p>UPS Ground Commercial and UPS 3 Day Select Commercial</p> <p>\$4.00</p> <p>UPS Ground with Freight Pricing Commercial</p> <p>\$4.00 per shipment</p> <p>UPS Air and International Services</p> <p>\$16.00</p> <p>UPS Worldwide Express Freight</p> <p>\$200.00</p>
Ship to a UPS Access Point® Location*	<p>Ship to a UPS Access Point Location Service:</p> <ul style="list-style-type: none"> – Available to all shippers with a valid UPS small package account number. – Available with all UPS small package shipping services** and most value-added services. – Shippers can integrate a UPS Locator into their e-commerce platforms, allowing their customers to select the UPS Access Point delivery location that is most convenient for them. – Only shippers with an approved UPS agreement for transportation of wine may ship wine to a UPS Access Point location, subject to limitations set forth at ups.com/wine. – For more information, go to ups.com/media/en/ShiptoUPSAccessPointlocation_US_EN.pdf. <p>Additional Service Options for Ship to a UPS Access Point Location:</p> <ul style="list-style-type: none"> – Deliver to Addressee Only – For added security, the shipment may only be picked up by the person identified on the shipping label (pickup by any third party is not permitted). – Package Release Code – For combined flexibility and security, enter a four- to six-digit numerical code when preparing a shipment and provide the code to the person you want to pick it up. The code is known only to you and the person you provide it to. 	<p>Ship to a UPS Access Point Location Service</p> <p>\$2.99</p> <p>Deliver to Addressee Only</p> <p>\$4.90 per shipment</p> <p>Package Release Code</p> <p>No additional charge</p>
Signature Required and Adult Signature Required	<ul style="list-style-type: none"> – UPS will obtain the necessary signature upon delivery. For Signature Required packages only, UPS may obtain, at its discretion, an electronic authorization to release the package without a signature upon delivery. 	Signature Required: \$5.55 Adult Signature Required: \$6.70

*For more information and restrictions on UPS Access Point Location, refer to page 24, Pickup and Drop-off Availability.

**Not available for UPS Worldwide Express Freight Services.

Notes:

– The value-added services listed are available for UPS domestic, international package, UPS Worldwide Express Freight MIDDAY and UPS Worldwide Express Freight services unless otherwise noted on page 112.

– Fuel surcharges apply to value-added services associated with pickup, transport and delivery. For current fuel surcharges, where applicable, visit [ups.com](https://www.ups.com).

DAILY RATES

Domestic, Export and Import Value-Added Services

UPS RETURNS® FOR PACKAGE

Available Options	Description	Fee
STANDARD RETURNS SOLUTIONS		
UPS Authorized Return Service®	<ul style="list-style-type: none"> – UPS preprints these return labels and provides to you for distribution. – You may include these return labels within an outbound shipment or distribute the label separately. – For domestic return shipments only. 	Contractual service
UPS Mail Innovations® Returns*	<ul style="list-style-type: none"> – Return packages through the United States Postal Service. – Features include easy-to-use label, thousands of drop off locations and detailed tracking through ups.com. 	Contractual service
Electronic Return Label	<ul style="list-style-type: none"> – UPS electronically provides a return label to your customer through a variety of formats, including e-mail, UPS tracking results or with a mobile barcode on a mobile device. – Request that UPS transmit a return label to your customer. – Pre-authorize your customer's return packages when they meet parameters agreed upon by you and UPS within the UPS Returns Manager portal. Once implemented, your customer obtains their return label through the portal; the shipper is responsible for payment of return charges and fees regardless of when the package is tendered. 	\$1.05 per label
Print and Mail Return Label	<ul style="list-style-type: none"> – UPS prints the return label upon your request and sends it to your customer, via First-Class Mail, who then applies the label to the package. 	\$2.25 per label
Print Return Label	<ul style="list-style-type: none"> – You print the return label and include it in an outbound shipment or distribute separately to your customer, who then applies the label to the package. 	\$1.05 per label
PREMIUM RETURNS SOLUTIONS		
1 UPS Pickup Attempt Label	<ul style="list-style-type: none"> – UPS delivers a return shipping label to your customer and collects the item for return. If the package cannot be picked up on the first attempt, UPS will leave the return label at the pickup location. – Pickup attempt date is not guaranteed. 	\$6.00 per label
3 UPS Pickup Attempts Label	<ul style="list-style-type: none"> – UPS delivers a return shipping label to your customer and collects the item for return. If the package cannot be picked up on the first attempt, UPS will only make two more pickup attempts over the next two business days. – Pickup attempt date is not guaranteed. 	\$8.20 per label
UPS Returns® Exchange	<ul style="list-style-type: none"> – UPS delivers a replacement item and picks up a like item for return during the same visit. – The new item is unpacked by the driver and customer; then using the delivery packaging, the old item is repacked for return to the shipper. – Replacement item won't be delivered until consignee provides the item for return to the driver. – Text and e-mail notifications are available to notify your customer of the upcoming exchange. – The outbound and return package tracking numbers are linked for round-trip visibility. 	Contractual service \$15.00 (or local equivalent) per exchange
CUSTOM RETURNS SOLUTIONS		
Customized Returns	<ul style="list-style-type: none"> – UPS can customize existing returns capabilities to address a customer's specific returns needs. 	Contractual service
Returns and The UPS Store®	<ul style="list-style-type: none"> – The UPS Store locations provide product return and exchange programs that can be tailored to large customer returns needs and that leverage The UPS Store retail network of nearly 5,000 locations to improve your client's returns experience. 	Contractual service

GENERAL INFORMATION REGARDING UPS RETURNS SERVICES

- Return packages must be UPS-compatible, conforming to UPS packaging guidelines and fall within UPS size and weight limits.
- Shipments containing certain items including, but not limited to, Hazardous Materials or Dangerous Goods requiring shipping papers are not allowed in UPS Returns Services.
- Transportation charges for return packages are billed after the package enters the UPS system.
- UPS Returns Print and Mail Label, 1 UPS Pickup Attempt Label, 3 UPS Pickup Attempts Label and UPS Returns Exchange accessorials fees are billed at the time of request.
- UPS Returns Print Return Label and Electronic Return Label fees are billed after the package enters the UPS system.
- UPS Automated Shipping Systems will allow you to produce a commercial invoice along with the label for international returns shipments.
- UPS Returns Services facilitate the pickup of return shipments and their delivery in over 145 countries and territories. Specific details may vary by country.
- The exporter will be responsible for meeting export/import documentation requirements, regardless of who processes a shipment.
- Regulations and requirements for documentation for individual commodities vary from country to country. See Export and Import rules on [ups.com](https://www.ups.com) for country-specific rules.
- Refer to the "UPS Tariff/Terms and Conditions of Service – United States" available at [ups.com/terms](https://www.ups.com/terms) for limits on actual and declared value for UPS Returns Services shipments.
- UPS provides third-country returns (where the international shipment is to be returned to a country other than the exporter's or processing party's country) only as a contractual service.
- UPS Returns® Service options for UPS® Simple Rate are limited to UPS Print Return Label Service only.

*Provided by UPS Mail Innovations. For more information, visit [ups.com/mireturns](https://www.ups.com/mireturns).

Notes:

- The value-added services listed are available for UPS domestic, international package, UPS Worldwide Express Freight® Midday and UPS Worldwide Express Freight services unless otherwise noted on page [112](#).
- Fuel surcharges apply to value-added services associated with pickup, transport and delivery. For current fuel surcharges, where applicable, visit [ups.com](https://www.ups.com).

Domestic, Export and Import Value-Added Services

PACKAGE

Unless otherwise noted, UPS rates are per package for domestic services and per shipment for international services.

Available Options	Description	Fee												
Saturday Air Processing Fee	<ul style="list-style-type: none"> – Formerly referred to as Saturday Pickup. – UPS Next Day Air® packages will be delivered the next business day, and UPS 2nd Day Air® packages will be delivered within two business days. – Available in select locations for UPS Next Day Air® Early. – Includes UPS Air Services and UPS Hundredweight Service® Air Services packages tendered to UPS on Saturday, including packages dropped off at retail locations. – If a Saturday pickup is scheduled but nothing is shipped, the Saturday Air Processing Fee will be assessed. – Additional pickup fees will apply for UPS On-Call Pickup® service. 	\$16.00												
Saturday Export Processing Fee	<ul style="list-style-type: none"> – UPS Worldwide Express Plus®, UPS Worldwide Express® and UPS Worldwide Saver® shipments picked up on Saturday will be delivered one day sooner than shipments picked up on Monday. – Available to select destination countries. – Includes UPS Worldwide Express Plus, UPS Worldwide Express and UPS Worldwide Saver shipments tendered to UPS on Saturday, including shipments dropped off at retail locations. – If a Saturday pickup is scheduled but nothing is shipped, the Saturday Export Processing Fee will be assessed. – Additional pickup fees will apply for UPS On-Call Pickup service. 	\$16.00 per shipment												
Saturday Stop Charge	<ul style="list-style-type: none"> – Saturday pickup is available for UPS 3 Day Select®, UPS® Ground and UPS Ground with Freight Pricing services in Saturday Ground Service Territories. – A Saturday Stop Charge that varies depending on the pickup service selected will apply any time a pickup is requested in addition to any applicable Saturday Air Processing Fee(s) or Saturday Export Processing Fee(s). – In Saturday Ground Service Territories, if a Saturday pickup is scheduled but nothing is shipped, the Saturday Stop Charge will be assessed (in lieu of the Saturday Air Processing Fee or Saturday Export Processing Fee). 													
UPS Smart Pickup®	<ul style="list-style-type: none"> – When you process a shipment using WorldShip® or UPS CampusShip® shipping systems, or ups.com shipping on Saturday, the system automatically notifies a UPS driver to make a UPS Smart Pickup service request. – In Saturday Ground Service Territories, a UPS Smart Pickup Saturday Stop Charge will apply at any time a UPS Smart Pickup request is made for Saturday pickup. 	\$6.00 per stop												
Scheduled Pickup	<ul style="list-style-type: none"> – A UPS driver automatically stops at your location once each Saturday, as scheduled. – In Saturday Ground Service Territories, a Saturday Stop Charge – Scheduled Pickup will apply any time a Saturday pickup is requested. – When paying for a Saturday Stop Charge – Scheduled Pickup, customers in Saturday Ground Service Territories may opt in to receive eligible deliveries on Saturday. 	\$9.00 per stop												
UPS On-Call Pickup	<ul style="list-style-type: none"> – Schedule a same-day or future-day Saturday pickup via ups.com. – In Saturday Ground Service Territories, a UPS On-Call Pickup Saturday Stop Charge in addition to the applicable UPS On-Call Pickup Charge will apply any time a Saturday pickup is requested. 	\$3.20 per stop UPS On-Call Pickup Fees will also apply. Refer to page 118 for UPS On-Call Pickup details.												
Scheduled Pickup Options	<ul style="list-style-type: none"> – One UPS driver will pick up all of your packages – Air, International, UPS 3 Day Select and Ground Services. That can mean a lower carbon footprint for UPS and you. – Scheduled pickup options are restricted to Monday-Friday pickups. For Saturday options, refer to the section above. – For more information, visit ups.com/pickupoptions. – Scheduled pickup options are not available for UPS Worldwide Express Freight® Midday and UPS Worldwide Express Freight® shipments. Pickups for UPS Worldwide Express Freight Midday and UPS Worldwide Express Freight services must be requested using WorldShip® or UPS CampusShip shipping systems, ups.com shipping, a UPS Ready® solution, UPS® Developer Kit, ups.com or by calling 1-800-782-7892. 													
UPS Smart Pickup**	<ul style="list-style-type: none"> – Automatically arrange a pickup only when you have packages to ship. – When you process a shipment using WorldShip or UPS CampusShip shipping systems, or ups.com shipping, the system automatically notifies a UPS driver to make a UPS Smart Pickup service request that same day. 	\$15.45 per week												
Day-Specific Pickup*	<ul style="list-style-type: none"> – A UPS driver automatically stops at your location Monday through Friday. You decide which days are best for your business. – The weekly service fee will vary based on the number of pickup days selected. 	<p style="text-align: right;">Weekly Billing Total:</p> <p style="text-align: right;">\$0.00-\$74.99 \$75.00 or more</p> <table border="0"> <tr> <td>Day-Specific Pickup</td> <td></td> <td></td> </tr> <tr> <td>– 1-2 days</td> <td>\$15.45</td> <td>\$15.45</td> </tr> <tr> <td>– 3 days</td> <td>\$24.30</td> <td>\$15.45</td> </tr> <tr> <td>– 4 days</td> <td>\$31.00</td> <td>\$15.50</td> </tr> </table>	Day-Specific Pickup			– 1-2 days	\$15.45	\$15.45	– 3 days	\$24.30	\$15.45	– 4 days	\$31.00	\$15.50
Day-Specific Pickup														
– 1-2 days	\$15.45	\$15.45												
– 3 days	\$24.30	\$15.45												
– 4 days	\$31.00	\$15.50												
Daily On-Route Pickup	<ul style="list-style-type: none"> – A UPS driver makes a pickup at your location once each business day while making deliveries in your area, even if there are no packages delivered to your location. 	Daily On-Route Pickup \$31.00 \$15.50												
Daily Pickup*	<ul style="list-style-type: none"> – A UPS driver automatically stops at your location once each business day, as scheduled. 	Daily Pickup \$33.00 \$16.50												

*Customers who select this Scheduled Pickup option receive one UPS On-Call Pickup request for Air, International or UPS 3 Day Select packages per day at no extra charge for shipments tendered after their Scheduled Pickup time. (For Day-Specific Pickup, the total number of free UPS On-Call Pickup requests for the week will not exceed the number of selected pickup days.)

Notes:

- The value-added services listed are available for UPS domestic, international package, UPS Worldwide Express Freight Midday and UPS Worldwide Express Freight® services unless otherwise noted on page 112.
- Fuel surcharges apply to value-added services associated with pickup, transport and delivery. For current fuel surcharges, where applicable, visit [ups.com](https://www.ups.com).

DAILY RATES

Domestic, Export and Import Value-Added Services

PACKAGE

Unless otherwise noted, UPS rates are per package for domestic services and per shipment for international services.

Available Options	Description	Fee
Shipper Release	– Have UPS deliver your package without requiring the recipient's signature.	No charge
Third Party Billing Service	<ul style="list-style-type: none"> – A fee applies to any shipment billed to a Third Party (regardless of the country of origin or destination of the shipment) and will be charged to the payer. – Based upon all charges, including transportation and accessorials. Excludes duties and taxes assessed by government authorities. – Does not apply to UPS Returns® Services or UPS Import Control® shipments. – UPS® Simple Rate does not qualify for Third Party Billing service. 	5.0% of total charges
World Ease®	<ul style="list-style-type: none"> – Simplifies customs clearance and reduces cost by grouping several shipments destined for one country or the entire European Union into a single shipment. – Available to and from over 75 countries and territories. – Multiple shipments travel together until customs clearance. Transit times may vary from traditional single-shipment transit times. – Call 1-800-782-7892 for more information. 	Contractual service

Notes:

- The value-added services listed are available for UPS domestic, international package, UPS Worldwide Express Freight® Midday and UPS Worldwide Express Freight services unless otherwise noted on page [112](#).
- Fuel surcharges apply to value-added services associated with pickup, transport and delivery. For current fuel surcharges, where applicable, visit [ups.com](https://www.ups.com).

Domestic, Export and Import Other Charges

PACKAGE

Unless otherwise noted, UPS rates are per package for domestic services and per shipment for international services.

Charges	Description	Fee																								
Additional Handling	<ul style="list-style-type: none"> – An Additional Handling charge will be assessed for any package that requires special handling, as determined by UPS in its sole discretion, including, but not limited to: <ul style="list-style-type: none"> • Weight: <ul style="list-style-type: none"> - Domestic: Any package with an actual weight of more than 50 pounds. <ul style="list-style-type: none"> - Each package in a shipment where the average weight per package is greater than 50 pounds and the weight for each package is not specified on the source document or the UPS automated shipping system used. - International: Any package with an actual weight of more than 70 pounds. <ul style="list-style-type: none"> - Each package in a shipment where the average weight per package is greater than 70 pounds and the weight for each package is not specified on the source document or the UPS automated shipping system used. • Length plus girth: Any package with its length (longest side of the package) plus girth [(2 x width) + (2 x height)] combined exceeding 105 inches. • Length: Any package with the longest side exceeding 48 inches. • Width: Any package with its second-longest side exceeding 30 inches. • Packaging: <ul style="list-style-type: none"> - Any article that is not fully encased in a corrugated cardboard shipping container, including tires. - Any package with an outer shipping container not made of corrugated cardboard, including but not limited to canvas, leather, metal, wood, hard plastic, soft plastic (e.g., plastic bag) or expanded polystyrene foam (e.g., styrofoam). - Any article that is encased in a soft-sided pack (e.g., poly bags and bubble mailers) that exceeds 18 inches along its longest side or 14 inches along its second-longest side or 6 inches in height. - Any package with an outer shipping container covered in shrink wrap or stretch wrap. - Any package bound with metal, plastic or cloth banding, or that has wheels, casters, handles or straps (including packages where the outer surface area is loosely wrapped or where the contents protrude outside the container surface). - Any cylindrical-like item, including but not limited to barrels, buckets, cans, drums, mailing tubes or pails. - Any package routed through UPS's irregular package sortation process, including but not limited to packages 1 inch or less in height. - Any other package that requires special handling, as determined by UPS in its sole discretion. – Applies per package for both domestic and international services. – For a package that meets multiple criteria listed above, only one Additional Handling charge will be assessed, in the following order: Weight, Length plus girth, Length, Width, Packaging. – An Additional Handling charge will not be assessed when a Large Package Surcharge is applied. 	<p><i>Effective through April 10, 2021</i></p> <p>Domestic</p> <ul style="list-style-type: none"> – Weight \$25.50 – Length + girth \$16.00 – Length \$16.00 – Width \$16.00 – Packaging \$15.25 <p>International \$16.00</p> <p><i>Effective April 11, 2021**</i></p> <table border="1"> <thead> <tr> <th>Domestic</th> <th>Zone 2</th> <th>Zones 3-4</th> <th>Zones 5+</th> </tr> </thead> <tbody> <tr> <td>– Weight</td> <td>\$24.00</td> <td>\$25.50</td> <td>\$27.00</td> </tr> <tr> <td>– Length + girth</td> <td>\$15.00</td> <td>\$16.00</td> <td>\$18.00</td> </tr> <tr> <td>– Length</td> <td>\$15.00</td> <td>\$16.00</td> <td>\$18.00</td> </tr> <tr> <td>– Width</td> <td>\$15.00</td> <td>\$16.00</td> <td>\$18.00</td> </tr> <tr> <td>– Packaging</td> <td>\$14.00</td> <td>\$15.00</td> <td>\$16.00</td> </tr> </tbody> </table> <p>International \$16.00</p>	Domestic	Zone 2	Zones 3-4	Zones 5+	– Weight	\$24.00	\$25.50	\$27.00	– Length + girth	\$15.00	\$16.00	\$18.00	– Length	\$15.00	\$16.00	\$18.00	– Width	\$15.00	\$16.00	\$18.00	– Packaging	\$14.00	\$15.00	\$16.00
Domestic	Zone 2	Zones 3-4	Zones 5+																							
– Weight	\$24.00	\$25.50	\$27.00																							
– Length + girth	\$15.00	\$16.00	\$18.00																							
– Length	\$15.00	\$16.00	\$18.00																							
– Width	\$15.00	\$16.00	\$18.00																							
– Packaging	\$14.00	\$15.00	\$16.00																							
Address Correction	<ul style="list-style-type: none"> – If any shipment has an incorrect or incomplete address, UPS will make reasonable efforts to secure the correct or complete address and will make available to the shipper the correct address. UPS may also correct or complete an address based on information obtained from the shipper or consignee. An Address Correction charge will be assessed to the shipper for an address correction or completion. – An address validated by UPS may be incorrect or incomplete for purposes of completing delivery, and may be corrected by UPS. 	<p>Package and UPS Worldwide Express Freight Services</p> <p>\$18.00</p> <p>UPS® Ground with Freight Pricing</p> <p>\$18.00 per package up to a maximum of \$126.00 per shipment.</p>																								
Chargeback for Consignee Billing Shipments	<ul style="list-style-type: none"> – In the event of non-payment by the consignee or third party, the original shipper will be billed a refusal fee in addition to the shipping charges. 	\$18.00																								
Delivery Area Surcharge	<ul style="list-style-type: none"> – A surcharge applies to each package delivered to certain ZIP Codes within the 48 contiguous states. For Alaska and Hawaii, refer to page 125 for the Remote Area Surcharge. – Refer to the Area Surcharge Listing at ups.com/rates for a listing of applicable ZIP Codes. – Delivery Area Surcharge does not apply to UPS Ground with Freight Pricing or UPS® Simple Rate shipments. 	<table border="1"> <thead> <tr> <th></th> <th>Ground</th> <th>Air*</th> </tr> </thead> <tbody> <tr> <td>– Commercial</td> <td>\$3.10</td> <td>\$3.25</td> </tr> <tr> <td>– Residential</td> <td>\$4.30</td> <td>\$4.70</td> </tr> <tr> <td>– Commercial Extended</td> <td>\$3.70</td> <td>\$3.85</td> </tr> <tr> <td>– Residential Extended</td> <td>\$5.90</td> <td>\$5.90</td> </tr> </tbody> </table> <p>Import:</p> <ul style="list-style-type: none"> – Delivery Area Surcharge: \$3.25 – Delivery Area Surcharge Extended: \$3.85 		Ground	Air*	– Commercial	\$3.10	\$3.25	– Residential	\$4.30	\$4.70	– Commercial Extended	\$3.70	\$3.85	– Residential Extended	\$5.90	\$5.90									
	Ground	Air*																								
– Commercial	\$3.10	\$3.25																								
– Residential	\$4.30	\$4.70																								
– Commercial Extended	\$3.70	\$3.85																								
– Residential Extended	\$5.90	\$5.90																								
Delivery Reattempt	<ul style="list-style-type: none"> – For UPS Worldwide Express Freight® Midday and UPS Worldwide Express Freight shipments, one delivery attempt is included in the rate. – Additional delivery attempts may have additional charges. 	\$60.00																								
Destination Outside Service Area	<ul style="list-style-type: none"> – If delivery of a UPS Next Day Air® Early package is requested to a destination outside the UPS Next Day Air Early service area, UPS reserves the right to assess an additional fee. 	\$10.00																								

*UPS 3 Day Select® packages receive the charge listed for UPS Air Services.

**Effective April 11, 2021 for non-Hundredweight service packages, and effective July 11, 2021 for Hundredweight service packages.

Notes:

– The other charges listed are available for UPS domestic, international package, UPS Worldwide Express Freight Midday and UPS Worldwide Express Freight services unless otherwise noted on page 113.

– Fuel surcharges apply to other charges associated with pickup, transport and delivery. For current fuel surcharges, where applicable, visit [ups.com](https://www.ups.com).

DAILY RATES

Domestic, Export and Import Other Charges

PACKAGE

Unless otherwise noted, UPS rates are per package for domestic services and per shipment for international services.

Charges	Description	Fee																																															
Dry Ice	<ul style="list-style-type: none"> Most non-Dangerous Goods shipments containing dry ice are accepted, without requiring the shipper to enter into the UPS Dangerous Goods Agreement (contract). Prepare and process these packages through WorldShip® or UPS CampusShip® shipping systems, UPS® Developer Kit or an approved UPS Ready® solution. The IATA "Shipper's Declaration for Dangerous Goods" is not required for domestic shipments of non-Dangerous Goods packed in dry ice. Title 49 C.F.R. Shipping Papers are only required for non-medical shipments containing more than 5.5 pounds of dry ice. International dry ice shipping is available on a contractual basis only. For more information, visit ups.com or call the Hazardous Materials Support Center at 1-800-554-9964. 	\$6.15 per package																																															
Extended Area Surcharge	<ul style="list-style-type: none"> An Extended Area Surcharge applies to shipments for some international origins and destinations. Visit ups.com/rates or call 1-800-782-7892 to determine if a particular origin or destination is classified as an Extended Area. 	Greater of \$42.00 per shipment or \$0.42 per lb.																																															
Dangerous Goods (Hazardous Materials)	<ul style="list-style-type: none"> UPS accepts Hazardous Materials only from customers with a UPS Dangerous Goods Agreement (contract) in effect and a Scheduled Pickup account, and then for transport only within and between all 50 states and Puerto Rico. Materials prepared in accordance with Title 49 C.F.R. 173.4 Small Quantities for highway and rail, 173.4a Excepted Quantities, and 173.4b de minimis exceptions; and Excepted Quantities, as defined in the International Air Transport Association (IATA) 2.7, may be shipped without a Hazardous Materials contract in the 50 states and Puerto Rico. International Dangerous Goods (IDG) shipments requiring "Shipper's Declaration for Dangerous Goods," as defined under the International Civil Aviation Organization (ICAO) and published in the International Air Transport Association (IATA) "Dangerous Goods Regulations," are accepted for transportation only as a contractual service. Excepted Quantities require a contract for International Dangerous Goods (IDG) service but are not subject to the additional International Dangerous Goods (IDG) charge. UPS accepts International Dangerous Goods (IDG) only for transportation within and between defined international service areas. For valid countries and territories, see ups.com/approvedcountries. Domestic Air®, International Air® and UPS Worldwide Express Freight Services Dangerous Goods are rated based on the class of the commodity being shipped. If a package or shipment contains any Accessible Dangerous Goods commodities or the shipper fails to identify the class of the commodity, the Accessible charge will apply. <ul style="list-style-type: none"> Accessible Dangerous Goods: Class 1.4 Explosives, Class 2.1 Flammable Gas, Class 2.2 Non-Flammable Gas in Cargo Aircraft Only (CAO) quantities, Class 3 Flammable Liquid, Class 4 Flammable Solid, Dangerous When Wet, Class 5 Oxidizers and Organic Peroxides, and Class 8 Corrosives. Inaccessible Dangerous Goods: Class 2.2 Non-Flammable Gas in Passenger (PAX) and Limited (LQ) quantities, Class 6 Toxic and Infectious Substances, Class 7 Radioactive Material and Class 9 Miscellaneous Dangerous Substances. For additional information, call the Hazardous Materials Support Center at 1-800-554-9964. Hazardous Materials are not accepted for transportation using UPS® Simple Rate, UPS Ground with Freight Pricing or UPS Worldwide Expedited® Ground Freight. 	<p>Package</p> <ul style="list-style-type: none"> UPS® Ground: \$39.00 UPS® Standard to/from Canada: the greater of \$46.40 per shipment or \$5.27 per Dangerous Goods package <p>Domestic and International Air Services</p> <p>Accessible Dangerous Goods</p> <ul style="list-style-type: none"> UPS Domestic Air Services*: \$115.00 per package UPS International Air Services*: the greater of \$171.00 per shipment or \$20.53 per Dangerous Goods package UPS Worldwide Express Freight Services: the greater of \$171.00 per shipment or \$0.93 per lb. <p>Inaccessible Dangerous Goods</p> <ul style="list-style-type: none"> UPS Domestic Air Services*: \$54.50 per package UPS International Air Services*: the greater of \$85.50 per shipment or \$10.26 per Dangerous Goods package UPS Worldwide Express Freight Services: the greater of \$85.50 per shipment or \$0.47 per lb. 																																															
Large Package Surcharge	<ul style="list-style-type: none"> For domestic shipments, a package is considered a "Large Package" when its length (longest side of the package) plus girth [(2 x width) + (2 x height)] combined exceeds 130 inches or its length exceeds 96 inches. For international shipments, a package is considered a "Large Package" when its length (longest side of the package) plus girth [(2 x width) + (2 x height)] combined exceeds 130 inches. With the exception of UPS Ground with Freight Pricing packages, Large Packages are subject to a minimum billable weight of 90 pounds. Applies per package for both domestic and international services. For a domestic package that meets both criteria listed above, only the Large Package Surcharge applicable when length plus girth combined exceeds 130 inches will be assessed. An Additional Handling charge will not be assessed when a Large Package Surcharge is applied. 	<p><i>Effective through April 10, 2021</i></p> <table border="1"> <thead> <tr> <th></th> <th>Length + Girth >130"</th> <th>Length >96"</th> </tr> </thead> <tbody> <tr> <td>Domestic</td> <td></td> <td></td> </tr> <tr> <td>– Commercial</td> <td>\$105.00</td> <td>\$105.00</td> </tr> <tr> <td>– Residential</td> <td>\$130.00</td> <td>\$130.00</td> </tr> <tr> <td>International</td> <td colspan="2">\$105.00</td> </tr> </tbody> </table> <p><i>Effective April 11, 2021**</i></p> <table border="1"> <thead> <tr> <th></th> <th>Zone 2</th> <th>Zones 3-4</th> <th>Zones 5+</th> </tr> </thead> <tbody> <tr> <td>Commercial</td> <td></td> <td></td> <td></td> </tr> <tr> <td>– Length + girth >130"</td> <td>\$100.00</td> <td>\$105.00</td> <td>\$120.00</td> </tr> <tr> <td>– Length >96"</td> <td>\$100.00</td> <td>\$105.00</td> <td>\$120.00</td> </tr> <tr> <td>Residential</td> <td></td> <td></td> <td></td> </tr> <tr> <td>– Length + girth >130"</td> <td>\$125.00</td> <td>\$130.00</td> <td>\$145.00</td> </tr> <tr> <td>– Length >96"</td> <td>\$125.00</td> <td>\$130.00</td> <td>\$145.00</td> </tr> <tr> <td>International</td> <td colspan="3">\$105.00</td> </tr> </tbody> </table>		Length + Girth >130"	Length >96"	Domestic			– Commercial	\$105.00	\$105.00	– Residential	\$130.00	\$130.00	International	\$105.00			Zone 2	Zones 3-4	Zones 5+	Commercial				– Length + girth >130"	\$100.00	\$105.00	\$120.00	– Length >96"	\$100.00	\$105.00	\$120.00	Residential				– Length + girth >130"	\$125.00	\$130.00	\$145.00	– Length >96"	\$125.00	\$130.00	\$145.00	International	\$105.00		
	Length + Girth >130"	Length >96"																																															
Domestic																																																	
– Commercial	\$105.00	\$105.00																																															
– Residential	\$130.00	\$130.00																																															
International	\$105.00																																																
	Zone 2	Zones 3-4	Zones 5+																																														
Commercial																																																	
– Length + girth >130"	\$100.00	\$105.00	\$120.00																																														
– Length >96"	\$100.00	\$105.00	\$120.00																																														
Residential																																																	
– Length + girth >130"	\$125.00	\$130.00	\$145.00																																														
– Length >96"	\$125.00	\$130.00	\$145.00																																														
International	\$105.00																																																

*UPS 3 Day Select® shipments receive the charge listed for UPS Domestic Air Services. UPS 3 Day Select® from Canada receives the charge listed for UPS International Air Services. References to "Domestic and International Air" in this section include UPS 3 Day Select Services.

**Effective April 11, 2021 for non-Hundredweight service packages and effective July 11, 2021 for Hundredweight service packages.

Notes:

– The other charges listed are available for UPS domestic, international package, UPS Worldwide Express Freight® Midday and UPS Worldwide Express Freight services unless otherwise noted on page [113](#).

– Fuel surcharges apply to other charges associated with pickup, transport and delivery. For current fuel surcharges, where applicable, visit [ups.com](https://www.ups.com).

Domestic, Export and Import Other Charges

PACKAGE

Unless otherwise noted, UPS rates are per package for domestic services and per shipment for international services.

Charges	Description	Fee
Missing PLD Fee	<ul style="list-style-type: none"> – A processing fee will be charged when the shipper does not provide all applicable Package Level Detail (PLD) information to UPS prior to delivery. – Applies per package for both domestic and international services. 	\$2.00 per package
Missing/Invalid Account Number or Refusal Fee	<ul style="list-style-type: none"> – A processing fee will be charged for a missing or invalid account number when the account number is missing, the account number is not the correct number for the bill-to party, the account number is for a receiver or third party who fails to pay the shipping charges or the package is shipped to an unauthorized consignee. 	\$18.00
UPS On-Call Pickup® Area Surcharge	<ul style="list-style-type: none"> – A surcharge applies to each residential UPS On-Call Pickup request at certain ZIP Codes within the 48 contiguous states. – Refer to the Area Surcharge Listing at ups.com/rates for a listing of applicable ZIP Codes. – Does not apply to UPS On-Call Pickup requests made at commercial addresses. 	<ul style="list-style-type: none"> – Residential: \$4.30 – Extended Residential: \$5.90
Over Maximum Limits	<ul style="list-style-type: none"> – Packages with an actual weight of more than 150 pounds, or that exceed 108 inches in length or exceed a total of 165 inches in length plus girth [(2 x width) + (2 x height)] combined, as measured to determine their billable weight, are not accepted for transportation. – If found in the UPS system, they are subject to additional charges. UPS reserves the right in its sole and unlimited discretion to return such packages to the shipper at the shipper's expense. – Refer to the "UPS Tariff/Terms and Conditions of Service – United States" available at ups.com/terms for more information. 	\$920.00 per package
Oversize Pallet Handling Surcharge	<ul style="list-style-type: none"> – UPS Worldwide Express Freight® Midday and UPS Worldwide Express Freight® pallets that exceed maximum size or weight restrictions (which vary by origin and destination) as set forth at ups.com/assets/resources/media/wwef_max_dim.pdf require prior approval and are subject to an Oversize Pallet Handling Surcharge. 	\$920.00 per pallet
Package Tracking, Tracing and Refund Requests	<ul style="list-style-type: none"> – Shipper may be assessed a charge per request for excessive tracking, tracing and refund requests. 	\$3.00
Peak Surcharges	<ul style="list-style-type: none"> – One or more Peak Surcharges will apply to certain packages tendered during a Peak Period. Details are available at ups.com/peaksurcharges. – Refer to the "UPS Tariff/Terms and Conditions of Service – United States" available at ups.com/terms for more information. 	Refer to ups.com/peaksurcharges
Pickup Area Surcharge	<ul style="list-style-type: none"> – A surcharge applies to each UPS Worldwide Express Freight Midday or UPS Worldwide Express Freight U.S. export shipment picked up from certain ZIP Codes within the 48 contiguous states. – Refer to the Area Surcharge Listing at ups.com/rates or call 1-800-782-7892 for a listing of applicable ZIP Codes. 	Greater of \$42.00 per shipment or \$0.42 per lb.
Prohibited Item Fee	<ul style="list-style-type: none"> – Packages containing prohibited articles or restricted articles not in compliance with all UPS policies and procedures and applicable laws and regulations are subject to additional charges if found in the UPS system. – Such charges apply in addition to all other applicable charges. – UPS reserves the right in its sole and unlimited discretion to dispose of such packages, submit such packages to governmental authorities or return such packages to the shipper solely at the shipper's risk and expense. – Refer to the "UPS Tariff/Terms and Conditions of Service – United States" available at ups.com/terms for more information. 	\$150.00 per package
Rebill Fee	<ul style="list-style-type: none"> – A fee will be assessed for each request to change the billing account for a shipment. 	\$18.00 per request

Notes:

- The other charges listed are available for UPS domestic, international package, UPS Worldwide Express Freight Midday and UPS Worldwide Express Freight services unless otherwise noted on page 113.
- Fuel surcharges apply to other charges associated with pickup, transport and delivery. For current fuel surcharges, where applicable, visit [ups.com](https://www.ups.com).

Domestic, Export and Import Other Charges

PACKAGE

Unless otherwise noted, UPS rates are per package for domestic services and per shipment for international services.

Charges	Description	Fee
Remote Area Surcharge	<ul style="list-style-type: none"> – A Remote Area Surcharge applies to deliveries to certain ZIP Codes within Alaska and Hawaii and select origins and destinations. – Applies to any UPS On-Call Pickup® request made within certain ZIP Codes within Alaska and Hawaii. – Refer to the Area Surcharge Listing at ups.com/rates for a listing of applicable ZIP Codes. – Applies to UPS® Simple Rate shipments. 	<p>Package</p> <ul style="list-style-type: none"> – Alaska: \$32.50 – Hawaii: \$10.65 – Non-U.S. origins and destinations: Greater of \$42.00 per shipment or \$0.42 per lb. <p>UPS Worldwide Express Freight® Services</p> <ul style="list-style-type: none"> – Alaska/Hawaii: Greater of \$42.00 per shipment or \$0.42 per lb. – Non-U.S. origins and destinations: Greater of \$42.00 per shipment or \$0.42 per lb.
Residential Surcharge	<ul style="list-style-type: none"> – A surcharge will apply (in addition to all applicable Area Surcharges) to any delivery to, or a UPS On-Call Pickup request from, a location that is a home, including a business operating out of a home. – UPS® Ground service fee applies to UPS On-Call Pickup requests made at a residential address. – Refer to the “UPS Tariff/Terms and Conditions of Service – United States” available at ups.com/terms for more information. – Residential Surcharge does not apply to UPS Simple Rate shipments. 	<p>Package</p> <ul style="list-style-type: none"> – UPS Domestic and International Air Services, UPS 3 Day Select® and UPS 3 Day Select® from Canada: \$5.00 – UPS Ground services \$4.45 – UPS® Standard services \$4.80 – UPS Ground with Freight Pricing: \$43.20 per shipment <p>UPS Worldwide Express Freight Services</p> <ul style="list-style-type: none"> – \$160.00
Shipping Charge Correction Audit Fee	<ul style="list-style-type: none"> – An audit fee will be assessed when the average shipping charge correction during an invoice week is greater than \$2.00 per package subject to a shipping charge correction. – The fee will be calculated per account number, based on shipping charge corrections billed to the account number during the applicable invoice period. – Shipping Charge Correction Audit Fee does not apply to import shipments. 	<p>Greater of:</p> <ul style="list-style-type: none"> – \$1.00 per package subject to a shipping charge correction during the applicable invoice period; or – 6% of the total amount of shipping charge corrections during the applicable invoice period
Special Handling of Undeliverable Shipments	<ul style="list-style-type: none"> – Domestic packages refused by the consignee, or which are undeliverable for any reason, will be returned to the shipper at the shipper’s expense. – Return service level will be UPS 3 Day Select for Air Services and UPS Ground for UPS Ground shipments at the applicable rate. Packages in UPS Ground with Freight Pricing shipments will be charged at the applicable rate for single-piece UPS Ground service. All applicable surcharges apply to any return. – The UPS Service Guarantee does not apply to undeliverable packages returned to the shipper. 	<ul style="list-style-type: none"> – UPS Air Services and UPS 3 Day Select: applicable UPS 3 Day Select rate – UPS Ground and UPS Ground with Freight Pricing: applicable UPS Ground rate – All applicable surcharges apply
Undeliverable Shipment Surcharge	<ul style="list-style-type: none"> – For all international shipments refused by the consignee, or which are undeliverable for any reason, UPS will contact the shipper for further instructions.* – Forwarding costs, return transportation charges, all applicable surcharges, duties, taxes and a return surcharge apply to any return, at the shipper’s expense. – The UPS Service Guarantee does not apply to undeliverable packages returned to the shipper. 	<p>Applicable costs plus \$10.00 per undeliverable shipment</p>

*For UPS® Standard to Mexico shipments, in cases where the shipment cannot be imported, the shipment will be automatically returned to the exporter.

Notes:

- The other charges listed are available for UPS domestic, international package, UPS Worldwide Express Freight® Midday and UPS Worldwide Express Freight services unless otherwise noted on page [113](#).
- Fuel surcharges apply to other charges associated with pickup, transport and delivery. For current fuel surcharges, where applicable, visit ups.com.

Value-Added Services

FREIGHT

Value-added services are available for the UPS services indicated. For additional information and rates, refer to the pages listed in the "Page" column at right.

	Air Freight						UPS Freight® LTL (Less-Than-Truckload)				Freight Between the U.S. and Mexico		Page				
	UPS Next Day Air® Freight	UPS Next Day Air® Freight NGS	UPS 2nd Day Air® Freight	UPS 2nd Day Air® Freight NGS	UPS 3 Day Freight®	UPS 3 Day Freight® NGS	LTL	LTL Guaranteed	LTL Guaranteed A.M.	LTL Urgent	UPS® Standard LTL	UPS Worldwide Expedited® Ground Freight	Air Freight	UPS Freight LTL	UPS Standard LTL	UPS Worldwide Expedited Ground Freight	
Delivery Instructions and Notification																	
Collect on Delivery (C.O.D.) Services							•				•	•			130	130	
Hold at Destination Airport for Pickup (HAPU)	•	•	•	•	•	•						•	128				132
Proof of Delivery (P.O.D.)	•	•	•	•	•	•	•	•	•	•	•	•	128	130	130		132
Saturday Delivery	•	•	•	•	•	•							128				
Saturday, Sunday or Holiday Delivery							•				•	•		130	130		
International Shipping																	
Certificate of Origin	•	•	•	•	•	•						•	128				132
Pickup																	
Saturday Pickup	•	•											128				
Saturday, Sunday or Holiday Pickup							•				•	•		130	130		
Additional Options																	
Declared Value for Carriage	•	•	•	•	•	•	•	•	•	•	•	•	128	130	130		132

Note: For information on additional charges that may apply to your Coyote Logistics® shipments, please call 1-877-626-9683 or visit coyote.com.

Other Charges

FREIGHT

Additional charges may apply to your shipment. For additional information and rates for the UPS services indicated, refer to the pages listed in the “Page” column at right.

	Air Freight						UPS Freight® LTL (Less-Than-Truckload)				Freight Between the U.S. and Mexico		Page			
	UPS Next Day Air® Freight	UPS Next Day Air® Freight NGS	UPS 2nd Day Air® Freight	UPS 2nd Day Air® Freight NGS	UPS 3 Day Freight®	UPS 3 Day Freight® NGS	LTL	LTL Guaranteed	LTL Guaranteed A.M.	LTL Urgent	UPS® Standard LTL	UPS Worldwide Expedited® Ground Freight	Air Freight	UPS Freight LTL	UPS Standard LTL	UPS Worldwide Expedited Ground Freight
Address Correction	•	•	•	•	•	•					•	129			133	
Chargeback for Consignee Billed Shipments	•	•	•	•	•	•					•	129			133	
Corrected Bill of Lading							•	•	•	•	•		131	131		
Dangerous Goods		•										129				
Detention of Vehicle	•	•	•	•	•	•	•	•	•	•	•		131	131	133	
Hazardous Materials							•			•			131	131		
Inside Delivery and Inside Pickup							•			•	•		131	131		
Liftgate Services	•	•	•	•	•	•	•			•	•	129	131	131	133	
Missing/Invalid Account Number or Refusal Fee	•	•	•	•	•	•					•	129			133	
Non-Conforming Freight	•	•	•	•	•	•					•	129			133	
Notification Prior to Delivery							•			•	•		131	131		
Oversize	•	•	•	•	•	•	•			•	•	129	131	131	133	
Payer Rebilling Fee	•	•	•	•	•	•					•	129			133	
Redelivery	•	•	•	•	•	•	•	•	•	•	•	129	131	131	133	
Residential Delivery/Pickup		•		•		•	•			•	•	129	131	131	133	
Storage							•	•	•	•	•		131	131		
Truck Waiting Time	•	•	•	•	•	•					•	129			133	

Note: For information on additional charges that may apply to your Coyote Logistics® shipments, please call 1-877-626-9683 or visit coyote.com.

Within and Between the U.S., Canada and Puerto Rico

Value-Added Services

AIR FREIGHT

Available Options	Description	Fee
Certificate of Origin	– Can be prepared by UPS on behalf of the shipper for exported goods manufactured and originating within the U.S.	\$25.00
Declared Value for Carriage	– UPS's liability for all losses is limited to \$50.00 per shipment or \$0.50 per pound, whichever is greater. – Shipper may declare a value in excess of these limits, subject to maximum allowable values for an additional charge. – For more information, refer to the "UPS Air Freight Terms and Conditions of Contract for UPS Air Freight Services in the United States, Canada and International" at ups-scs.com/terms .	– \$1.10 per \$100.00 – Minimum of \$115.00
Hold at Destination Airport for Pickup (HAPU)	– Freight is to be held at the carrier's destination location for pickup by the recipient. – HAPU requires a consignee name and phone number. – All services will be billed door-to-door.	No charge
Proof of Delivery (P.O.D.)	– Contact your local service center to request Proof of Delivery. To locate your local service center, call 1-800-443-6379.	\$10.00
Saturday Delivery	– Saturday Delivery may be selected by the shipper where available to A.M. points only. – Shipments delivered on Saturday must be picked up on Friday.	\$33.00 per 100 lbs.: \$210.00 minimum in U.S., Canada and Puerto Rico
Saturday Pickup	– Saturday Pickup may be selected by the shipper where available to A.M. points only.	\$33.00 per 100 lbs.: \$210.00 minimum in U.S., Canada and Puerto Rico

Notes:

- The value-added services listed are available for UPS Air Freight services unless otherwise noted on page [126](#).
- Fuel surcharges apply to value-added services associated with pickup, transport and delivery. For current fuel surcharges, where applicable, visit [ups-scs.com/surcharges](https://www.ups.com/surcharges).

Within and Between the U.S., Canada and Puerto Rico

Other Charges

AIR FREIGHT

Charges	Description	Fee
Address Correction	<ul style="list-style-type: none"> – If any shipment has an incorrect or incomplete address, UPS will make reasonable efforts to secure the correct or complete address and will provide the shipper with the correct address. UPS may also correct or complete an address based on information obtained from the shipper or consignee. An Address Correction charge will be assessed to the shipper for an address correction or completion. – An address validated by UPS may be incorrect or incomplete for purposes of completing delivery and may be corrected by UPS. 	\$84.00
Chargeback for Consignee Billed Shipments	<ul style="list-style-type: none"> – In the event of non-payment by the consignee or third party, the original shipper will be billed a refusal fee in addition to the shipping charges. 	\$25.00
Dangerous Goods	<ul style="list-style-type: none"> – Dangerous Goods can be shipped via UPS Next Day Air® Freight NGS only. – Non-conforming freight may be subject to service delays. 	\$0.49 per lb.; \$113.00 minimum
Liftgate Services	<ul style="list-style-type: none"> – Liftgate equipment on trailers is available for customers who do not have a shipping or receiving dock and cannot load or unload their shipment without liftgate assistance. – Liftgate service must be requested, as not all trailers are equipped with liftgate devices. 	<ul style="list-style-type: none"> – Origin: \$9.26 per 100 lbs.; \$137.00 minimum; \$451.00 maximum – Destination: \$9.26 per 100 lbs.; \$137.00 minimum; \$451.00 maximum
Missing/Invalid Account Number or Refusal Fee	<ul style="list-style-type: none"> – A processing fee will be charged for a missing or invalid account number when the account number is missing, the account number is not the correct number for the bill-to party, the account number is for a receiver or third party who fails to pay the shipping charges or the package is shipped to an unauthorized consignee. 	\$25.00
Non-Conforming Freight	<ul style="list-style-type: none"> – Shipments that are unusually shaped, non-stackable, difficult to handle or require special handling in transit (to prevent damage to the shipment, the other shipments it may come in contact with or the equipment). – Non-conforming freight may be subject to service delays and additional charges. 	30% of Air Freight charges; \$245.00 minimum
Oversize	<ul style="list-style-type: none"> – Oversize fees will be charged to shipments that exceed 120 inches in length, 83 inches in width and 60 inches in height. 	Cubic Dimensional Weight and % of transportation charge for the greater of: <ul style="list-style-type: none"> – 20% if length + girth > 200" – 30% if a dimension ≥ 60" – Minimum \$185.00 when a dimension > 120"
Payer Rebilling Fee	<ul style="list-style-type: none"> – A payer rebilling fee will be assessed for each request to change the billing instructions for a shipment. 	\$25.00
Redelivery	<ul style="list-style-type: none"> – If more than one delivery attempt is made. 	\$0.077 per lb.; \$70.50 minimum
Residential Delivery/Pickup	<ul style="list-style-type: none"> – Fee assessed for pickup from or delivery to a home address, including a business operating out of a home that does not have an entrance open to the public. 	\$160.00 per shipment
Truck Waiting Time	<ul style="list-style-type: none"> – If the driver is required to wait more than 15 minutes for either a pickup or delivery, charges based on waiting time will be computed by multiplying the hourly rate by the time involved. 	<ul style="list-style-type: none"> – \$65.00 per hour – \$47.00 per vehicle for each 15 minutes or fraction thereof shall be made for the time consumed for the delay, subject to a minimum charge of \$83.50 – \$128.00 per vehicle for each 24-hour period or fraction thereof, excluding non-business days

Notes:

- The other charges listed are available for UPS Air Freight services unless otherwise noted on page [127](#).
- Fuel surcharges apply to other charges associated with pickup, transport and delivery. For current fuel surcharges, where applicable, visit ups-scs.com/surcharges.

Within the U.S. and Between the U.S., Canada and Mexico

Value-Added Services

UPS FREIGHT® LTL (LESS-THAN-TRUCKLOAD)

Available Options	Description
Collect on Delivery (C.O.D.)	– C.O.D. is accepted on your behalf when requested.
Declared Value for Carriage	<ul style="list-style-type: none"> – UPS's liability for losses is determined by several criteria, including origin and destination of the shipment, the actual invoice value of the commodities lost, damaged or destroyed, the amount determined from the applicable limited liability provisions of the National Motor Freight Classification (NMFC), and the limits provided by contract, if applicable, or the UPS Freight® 102 Series Tariff. – Shipper may declare a value in excess of these limits, subject to maximum allowable values for an additional charge. – For more information, refer to the UPS Freight 102 Series Tariff at upsfreight.com/tariff Item 166.
Proof of Delivery (P.O.D.)	<ul style="list-style-type: none"> – Proof of Delivery includes the time of delivery, full delivery address and the name and signature of the person who accepted your shipment, if available. – Information can be provided via Tracking on ups.com when logged in, Quantum View Manage® tracking, UPS Billing Center, My LTL Freight, e-mail, fax or mail.
Saturday, Sunday or Holiday Delivery	– Delivery service is available on non-business days such as Saturdays, Sundays and holidays upon request.
Saturday, Sunday or Holiday Pickup	– Pickup service is available on non-business days such as Saturdays, Sundays and holidays upon request.

Notes:

- The value-added services listed are available for UPS Freight LTL and UPS® Standard LTL services unless otherwise noted on page [126](#).
- The list of value-added services listed above is not a comprehensive list of all value-added services available. For a complete list of value-added services, fees and current fuel surcharges, where applicable, visit [upsfreight.com](https://www.upsfreight.com) and refer to the UPS Freight Rules Tariff for Less-Than-Truckload transportation. For full details and updates, refer to [upsfreight.com/tariff](https://www.upsfreight.com/tariff).

Within the U.S. and Between the U.S., Canada and Mexico

Other Charges

UPS FREIGHT® LTL (LESS-THAN-TRUCKLOAD)

Charges	Description
Corrected Bill of Lading	– When information on a shipping document must be corrected.
Detention of Vehicle	– Detention of Vehicle fees apply (with power and without power) upon expiration of the applicable free time allowed.
Hazardous Materials	– UPS Freight® accepts Hazardous Materials for Ground Transportation within the 48 contiguous states under the D.O.T. Code of Federal Regulations, as outlined in Title 49, Parts 100-185 on Transportation (49 C.F.R.).
Inside Delivery and Inside Pickup	– For shipments that require the driver to deliver or pick up at points beyond the area immediately accessible to the loading dock.
Liftgate Services	– Liftgate equipment on trailers is available for customers who do not have a shipping or receiving dock and cannot load or unload their shipment without liftgate assistance. – Liftgate service must be requested, as not all trailers are equipped with liftgate devices.
Notification Prior to Delivery	– When recipient must be contacted in advance of arrival.
Oversize	– Shipments containing one or more articles with any single dimension that equals or exceeds the applicable length threshold shall be subject to a charge.
Redelivery	– If more than one delivery attempt is made, a fee applies if redelivery is needed after UPS Freight attempts to deliver during committed delivery time.
Residential Delivery/Pickup	– A surcharge will apply to any delivery or pickup to or from a location that is a home, including a business operating out of a home.
Storage	– A fee is assessed if UPS Freight is unable to deliver a shipment during committed delivery times and must store the shipment at a UPS Freight facility.

Notes:

- The other charges listed are available for UPS Freight LTL and UPS® Standard LTL services unless otherwise noted on page [127](#).
- The list of other charges listed above is not a comprehensive list of all other charges that may apply. For a complete list of other charges, fees and current fuel surcharges, where applicable, visit [upsfreight.com](https://www.upsfreight.com) and refer to the UPS Freight Rules Tariff for Less-Than-Truckload transportation. For full details and updates, refer to [upsfreight.com/tariff](https://www.upsfreight.com/tariff).

Freight Between the U.S. and Mexico

Value-Added Services

UPS WORLDWIDE EXPEDITED® GROUND FREIGHT

Available Options	Description	Fee
Certificate of Origin	– Can be prepared by UPS on behalf of the shipper for exported goods manufactured and originating within the U.S.	\$25.00
Declared Value for Carriage	– UPS's liability for all losses is limited to \$50.00 per shipment or \$0.50 per pound, whichever is greater. – Shipper may declare a value in excess of these limits, subject to maximum allowable values for an additional charge. – For more information, refer to the "UPS Air Freight Terms and Conditions of Contract for UPS Air Freight Services in the United States, Canada and International" at ups-scs.com/terms .	– \$1.10 per \$100.00 – Minimum of \$115.00
Hold at Destination Airport for Pickup (HAPU)	– Freight is to be held at the carrier's destination location for pickup by the recipient. – HAPU requires a consignee name and phone number. – All services will be billed door-to-door.	No charge
Proof of Delivery (P.O.D.)	– Contact your local service center to request Proof of Delivery. To locate your local service center call 1-800-443-6379.	\$10.00

Notes:

- Fuel surcharges apply to value-added services associated with pickup, transport and delivery. For current fuel surcharges, where applicable, visit [ups-scs.com/surcharges](https://www.ups.com/scs/surcharges).
- The value-added services listed are available for UPS Worldwide Expedited Ground Freight services unless otherwise noted on page [126](#).
- UPS Worldwide Expedited Ground Freight is governed by the "UPS Air Freight Terms of Contract for UPS Air Freight Services in the United States, Canada and International" at [ups-scs.com/terms](https://www.ups.com/scs/terms).

Freight Between the U.S. and Mexico

Other Charges

UPS WORLDWIDE EXPEDITED® GROUND FREIGHT

Charges	Description	Fee
Address Correction	<ul style="list-style-type: none"> – If any shipment has an incorrect or incomplete address, UPS will make reasonable efforts to secure the correct or complete address and will provide the shipper with the correct address. UPS may also correct or complete an address based on information obtained from the shipper or consignee. An Address Correction charge will be assessed to the shipper for an address correction or completion. – An address validated by UPS may be incorrect or incomplete for purposes of completing delivery, and may be corrected by UPS. 	\$84.00
Chargeback for Consignee Billed Shipments	– In the event of non-payment by the consignee or third party, the original shipper will be billed a refusal fee in addition to the shipping charges.	\$25.00
Detention of Vehicle	– Detention of Vehicle fees apply (with power and without power) upon expiration of the applicable free time allowed.	\$65.00
Liftgate Services		
Origin	– Fee assessed for pickup that requires a vehicle equipped with a mechanical lifting device.	<ul style="list-style-type: none"> – \$9.26 per 100 lbs. – \$137.00 minimum – \$451.00 maximum
Destination	– Fee assessed for delivery that requires a vehicle equipped with a mechanical lifting device.	<ul style="list-style-type: none"> – \$9.26 per 100 lbs. – \$137.00 minimum – \$451.00 maximum
Missing/Invalid Account Number or Refusal Fee	– A processing fee will be charged for a missing or invalid account number when the account number is missing, the account number is not the correct number for the bill-to party, the account number is for a receiver or third party who fails to pay the shipping charges or the package is shipped to an unauthorized consignee.	\$25.00
Non-Conforming Freight	<ul style="list-style-type: none"> – Shipments that are unusually shaped, non-stackable, difficult to handle or require special handling in transit (to prevent damage to the shipment, the other shipments it may come in contact with or the equipment). – Non-conforming freight may be subject to service delays and additional charges. 	<ul style="list-style-type: none"> 30% of Air Freight charges \$245.00 minimum
Oversize	– Oversize fees will be charged to shipments that exceed 120 inches in length, 83 inches in width and 60 inches in height.	<ul style="list-style-type: none"> Cubic Dimensional Weight and % of transportation charge for the greater of: – 20% if length + girth > 200" – 30% if a dimension ≥ 60" – Minimum \$185.00 when a dimension > 120"
Payer Rebilling Fee	– A payer rebilling fee will be assessed for each request to change the billing instructions for a shipment.	\$25.00
Redelivery	– If more than one delivery attempt is made.	\$0.077 per lb.; \$70.50 minimum
Residential Delivery/Pickup	– A surcharge will apply to any delivery to a location that is a home, including a business operating out of a home.	\$160.00 per shipment
Truck Waiting Time	– If the driver is required to wait more than 15 minutes for either a pickup or delivery, charges based on waiting time will be computed by multiplying the hourly rate by the time involved.	<ul style="list-style-type: none"> – \$65.00 per hour – \$47.00 per vehicle for each 15 minutes or fraction thereof shall be made for the time consumed for the delay, subject to a minimum charge of \$83.50 – \$128.00 per vehicle for each 24-hour period or fraction thereof, excluding non-business days

Notes:

- Fuel surcharges apply to other charges associated with pickup, transport and delivery. For current fuel surcharges, where applicable, visit [ups-scs.com/surcharges](https://www.ups.com/surcharges).
- The other charges listed are available for UPS Worldwide Expedited Ground Freight services unless otherwise noted on page 127.
- UPS Worldwide Expedited Ground Freight is governed by the "UPS Air Freight Terms of Contract for UPS Air Freight Services in the United States, Canada and International" at [ups-scs.com/terms](https://www.ups.com/terms).

Customs Brokerage

PACKAGE

The following applies per shipment for imports into the U.S.:

- All UPS Worldwide Express Plus®, UPS Worldwide Express NA1®, UPS Worldwide Express®, UPS Worldwide Express Freight® Midday, UPS Worldwide Express Freight®, UPS Worldwide Saver®, UPS Worldwide Expedited®, UPS 3 Day Select® from Canada and UPS® Standard to/from Mexico rates include routine customs clearance. Routine customs clearance is built into your rates when you use UPS to perform the customs clearance for any of these services.
- Additional services such as parts database management, customer-specific classification directives, special operating plans, assigned rating team, custom reporting and other value-added services are part of our Customized Brokerage Services

and subject to a customs entry fee and/or other charges. Please see Customized Brokerage Services in the Special Services section below for more information.

- UPS also provides services designed to facilitate movements of your UPS® Standard shipments to and from Canada (see brokerage rates into Canada at ups.com/rates/ca) and other non-routine services that include formal entry clearance, live entry clearance, temporary import bonds and duty drawbacks. In addition, UPS can provide customs clearance for other ocean, air freight, truck and rail U.S. imports. The importer is responsible for all brokerage fees, including duties and taxes. See charts on the following pages for more information.
- The UPS Service Guarantee does not apply when customs clearance is performed by brokerage offices other

than those designated by UPS, or if a service delay is the result of certain events beyond our control, such as a government agency hold.

- Customs clearance for services specified here is provided by the UPS Supply Chain Solutions® customs brokerage offices designated by UPS for handling package customs clearance. Other UPS Supply Chain Solutions customs brokerage offices charge fees for clearance of packages and freight. Customs clearance and brokerage services are subject to the Customs Brokerage and Freight Forwarding Terms and Conditions/ U.S. located at ups-scs.com/tools/terms.html.

For more information on any of our Customs Brokerage Services, call 1-800-782-7892.

UPS Broker of Choice®

With UPS Broker of Choice service, importers select their own alternate customs broker for customs clearance of their UPS international shipments. This service is available for all UPS international shipments, except for UPS® Standard service.

This contractual, fee-based service allows the importer to utilize UPS for international shipping needs, with an alternate broker providing customs clearance. The importer may use UPS Broker of Choice service for specific

commodities or product lines, while continuing to utilize UPS brokerage expertise for others.

UPS technology makes shipment information and documentation (e.g., the commercial invoice) available to the designated broker at the time of export. This enables customs clearance in a timely manner.

Importers have two options:

1. UPS Broker of Choice OnSite keeps shipments in UPS's possession while the

importer's customs broker completes customs clearance procedures prior to UPS completing delivery of the shipment.

2. UPS Broker of Choice OffSite moves shipments in-bond directly to a customs-controlled (bonded) warehouse (at the importer's direction), where the importer's customs broker completes the customs clearance procedures. The UPS transport is completed upon delivery of the shipment to the warehouse. Refer to page [137](#) for fees.

Note: For information on UPS Customs Brokerage Services for your freight needs, including the Customs Brokerage and Freight Forwarding Terms and Conditions, please visit ups-scs.com.

Customs Brokerage

PACKAGE

UPS® FTZ Facilitator

With UPS FTZ Facilitator service, importers and exporters have the ability to use UPS to transport international shipments in-bond to and from a global Free/Foreign Trade Zone (FTZ). This service is available for all UPS international shipments, except for UPS® Standard service.

This contractual, fee-based service allows the shipment of goods to and from an FTZ, while retaining the benefits of UPS's transportation network. Using UPS as a single source enables

importers and exporters to increase visibility and tracking, and reduce the chance for errors and costs associated with utilizing multiple transportation providers.

UPS technology enables shipment information and documentation (e.g., the commercial invoice) available to the customer, customer's broker and FTZ operator at the time of export. This enables prompt processing of the FTZ entry.

Importers will choose UPS FTZ Facilitator import service to direct shipments to be delivered in-bond to a designated FTZ rather than being cleared through customs.

Exporters will choose UPS FTZ Facilitator export service to ship goods in-bond from an FTZ to an international destination. Refer to page [137](#) for fees.

Entry Preparation Charges for Importing into the United States

All rates and values are shown in U.S. funds. Rates are per shipment and do not include applicable taxes.

Value for Duty	UPS Worldwide Express Plus® UPS Worldwide Express NA1® UPS Worldwide Express® UPS Worldwide Express Freight® Midday UPS Worldwide Express Freight® UPS Worldwide Saver® UPS Worldwide Expedited® UPS 3 Day Select® from Canada UPS® Standard from Mexico	UPS® Standard from Canada*
\$0.00 to \$800.00**	No Charge***	No Charge††
\$800.01† to \$1,250.00	No Charge***	\$28.75
\$1,250.01 to \$2,500.00	No Charge***	\$40.50
Each Additional \$1,000.00 or Part Thereof	No Charge***	\$1.95

*When UPS Supply Chain Solutions® is designated as the customs broker on the commercial invoice for the product listed above, the UPS Service Guarantee applies to your shipment, subject to its terms set forth in the applicable "UPS Tariff/Terms and Conditions of Service – United States" available at [ups.com/terms](https://www.ups.com/terms). The UPS Service Guarantee does not apply when customs clearance is performed by customs brokerage offices other than those designated by UPS for clearing the products listed above. Call 1-800-782-7892 for more information.

**\$800.00 or current de minimis requirements set forth by law, if different.

***For UPS Worldwide Express Plus, UPS Worldwide Express NA1, UPS Worldwide Express, UPS Worldwide Express Freight Midday, UPS Worldwide Express Freight, UPS Worldwide Saver, UPS Worldwide Expedited, UPS 3 Day Select from Canada and UPS Standard from Mexico service levels, routine customs clearance (for entries up to three entry lines) is included at no additional cost. Additional charges will apply if customs clearance is performed by customs brokerage offices other than those designated by UPS for clearing the products listed above.

†\$800.01 or \$0.01 higher than current de minimis requirement set forth by law, if different.

††An Entry Preparation Charge will apply on any UPS Standard from Canada shipment below de minimis value requiring an entry, at the fee amount published for goods valued between \$800.01 and \$1,250.00.

Customs Brokerage

PACKAGE

The Customs Brokerage information below applies to all UPS international package and UPS Worldwide Express Freight® services, unless otherwise noted.

Service	Explanation	Fee
BONDS (CONTRACT ONLY)		
Continuous Transaction Bond	<ul style="list-style-type: none"> – One-year import bond for all entries made in a single year with up to \$50,000.00 coverage. – Required under special circumstances. 	\$25.00
In-Transit Bond (IT Bond)	– Allows a shipment to be transported under U.S. Customs and Border Protection supervision until it is formally entered into the customs territory of the U.S. and duty is paid, or until it is exported from the U.S.	\$85.00
Single Entry Bond (SEB)	<ul style="list-style-type: none"> – One-time import bond issued to ensure compliance with U.S. laws and regulations. – When an SEB is necessary, UPS will contact the importer prior to customs clearance. 	\$4.50 per \$1,000.00 (minimum \$45.00)
SPECIAL ENTRIES		
Additional Consignee or Invoice	– A fee applies if the shipment has more than one consignee or one commercial invoice.	\$2.10 per consignee or invoice
Complex Entries	<ul style="list-style-type: none"> – Usually requires a formal entry and may require an additional day of customs clearance. – A Complex Entry fee will be applied to the following: <ul style="list-style-type: none"> • A live entry that is required by U.S. Customs and Border Protection (CBP) when an export license (visa) is mandated for import into the U.S. • If the commodity and country of origin require Antidumping/Countervailing Duties. Antidumping/Countervailing Duty entries help U.S. companies compete with foreign industries and require additional information for U.S. Customs and Border Protection. • Any imported goods, goods returned and goods previously imported that require additional U.S. Customs and Border Protection documentation to substantiate the duty-free claim. • Goods with additional licensing requirements. • When the customer requests UPS to file a single entry for a non-restricted commodity which normally qualifies for clearance under a consolidated manifest (Title 19 C.F.R. 128). 	\$25.00
Duty Drawbacks	– The preparation of a refund request for part or all of customs duty or domestic tax paid on imported merchandise that was subsequently manufactured into a different article or re-exported.	\$90.00 minimum*
Entry-Line Charge After First Three Lines	– A fee applies when more than three entry lines are entered.	\$3.20/line
Entry Type 86 Processing	– A fee applies when the customer requests UPS to file a single entry under Entry Type 86 for a shipment which normally qualifies for clearance under a consolidated manifest (Title 19 C.F.R. 128.24(e)).	\$11.00
Fish and Wildlife (F&W) Entry Preparation	– Fish and Wildlife Service is a government agency that requires the filing of certain documents and permits, and conducts inspections of products that contain wildlife or plant species that fall under the F&W jurisdiction. A fee of \$25.00 will be assessed for UPS preparing and submitting the Fish and Wildlife USFWS Form 3-177.	\$25.00**
Foreign Trade Zone (FTZ) Entry	– These types of entries are non-routine and must be requested by the importer to UPS Supply Chain Solutions. For more information, refer to UPS® FTZ Facilitator service on pages 135 and 137 .	Upon request

*Additional charges may apply.

**All fees charged by any government agency or other third party, if any, will be billed in addition to the listed fees.

Customs Brokerage

PACKAGE

The Customs Brokerage information below applies to all UPS international package and UPS Worldwide Express Freight® services, unless otherwise noted.

Service	Explanation	Fee
SPECIAL ENTRIES (CONTINUED)		
Partner Government Agency (PGA) Clearance	<ul style="list-style-type: none"> Government agencies work with U.S. Customs and Border Protection on regulating and controlling commodities coming into the U.S. from other countries. Special documents must be submitted to these agencies for shipments that contain controlled commodities. Agencies include the Food and Drug Administration (FDA), Department of Agriculture (USDA) and the Federal Communications Commission (FCC), among others. 	\$25.00*
Prior Notice for Food and Food Products	<ul style="list-style-type: none"> A fee applies if you want UPS to provide Prior Notice to the U.S. Food and Drug Administration (FDA) for food and food products imported into or moving through the U.S. This advance notice is required by the Bioterrorism Preparedness and Response Act of 2002. For import shipments, the Prior Notice fee is in addition to the existing FDA Clearance fee for regulated food and food products. 	\$12.00
Temporary Import Under Bond	<ul style="list-style-type: none"> Special customs entry for merchandise to be brought into the country exempt of duty, provided the merchandise exits the country within a certain amount of time and under U.S. Customs and Border Protection supervision. 	\$95.00
UPS Broker of Choice®	<ul style="list-style-type: none"> Enables an importer to use an alternate customs broker for imported shipments, providing advanced visibility of shipment documents to the selected alternate broker, clearance while in UPS's possession (OnSite), with UPS completing delivery or after UPS has delivered to a designated bonded warehouse (OffSite). 	\$55.00 (OnSite)/\$55.00 (OffSite) OffSite will also include a separate In-Transit Bond fee
UPS® FTZ Facilitator	<ul style="list-style-type: none"> Facilitates the bonded movement from the first port of arrival to the FTZ location, providing advanced visibility of shipment documents to the importer or FTZ operator; also available for international shipments originating in FTZ. 	\$80.00
Warehouse Entry	<ul style="list-style-type: none"> Fee assessed to the customer when a request is made by the importer to file a warehouse entry. These types of entries are non-routine and must be requested by the importer to UPS Supply Chain Solutions. 	\$132.50
OTHER SERVICES		
Customized Brokerage Services	<ul style="list-style-type: none"> UPS can provide additional customized brokerage services to meet your specific importing and compliance needs. Examples of these contractual, fee-based services include customized reports, shipment pre-alerts, classification confirmations and others. The fees for these customized services depend on the types of services requested. 	Upon request
Customs Entry Packets	<ul style="list-style-type: none"> Entry and payment documentation for shipments that have been through the U.S. Customs and Border Protection payment and review process. Request by the shipper, consignee and/or third party for import clearance documentation which could include, but is not limited to, records previously supplied to the broker by the shipper/consignee or copies of any import clearance documentation. 	\$2.00 per packet or shipment
Disbursement Fee	<ul style="list-style-type: none"> Customers are responsible for payment of duty and taxes. Fee of 2% (minimum \$12.00) of the amount paid or processed by UPS on behalf of the customer will be charged. 	2% of Duty/Tax (minimum \$12.00)
Duty	<ul style="list-style-type: none"> Fee imposed by U.S. Customs and Border Protection on imported merchandise. 	Based on the value and/or gross weight; it differs according to the commodity

*All fees charged by any government agency or other third party, if any, will be billed in addition to the listed fees.

Customs Brokerage

PACKAGE

The Customs Brokerage information below applies to all UPS international package and UPS Worldwide Express Freight® services, unless otherwise noted.

Service	Explanation	Fee
OTHER SERVICES (CONTINUED)		
Formal Entry	– Required for shipments valued at more than \$2,500.00 (U.S.) or for shipments containing specific commodities designated by U.S. Customs and Border Protection.	See Complex Entries on page 136
Marking Notice Processing	– Special documents must be filed for a shipment not properly marked with the country of origin. – Customs Power of Attorney must also be completed and on file with brokerage before the shipment can be forwarded to the consignee for proper marking.	\$80.00
Merchandise Processing Fee	– A non-refundable fee charged by U.S. Customs and Border Protection for administrative expenses for processing certain imported shipments. The fee will not apply if the goods qualify under applicable free trade agreements. For Air shipments: – Applicable only for formal entries (customs value more than \$2,500.49 or as required by regulation). For Ground shipments: – Applicable for both informal and formal entries.	Based on the value of merchandise; minimum and maximum fees may apply
Overtime/Special Handling Service (Hourly Rate)	– When additional, non-routine activities/services are required, selected services may be performed by UPS. – Services offered include (but are not limited to) manipulations, labeling, inventory, auditing, customized reports, spreadsheets, key entry, general order processing, etc. – UPS reserves the right to charge in one-hour increments, rounded up to the next hour. – Please contact a brokerage specialist if there is a need for additional clearance services.	\$53.00 per hour*
Post Entry Services	– Protest: Request from an importer to recoup the overpayment of duty to U.S. Customs and Border Protection due to a description discrepancy or misclassification on the customs entry. – Post Summary Correction: Request from an importer to obtain corrections to an entry filed with U.S. Customs and Border Protection prior to liquidation. – Voluntary Tender: Request from an importer to submit additional duties owed to U.S. Customs and Border Protection, where submission is initiated by the customer.	\$95.00 / \$120.00**
Pre-Release Notification	– This fee applies when customer contact is required prior to releasing the shipment.	\$14.00 per shipment
Transportation Handling	– Assessed when shipments are removed from the UPS system, at the request of the importer, to be forwarded to another broker for clearance. – Shipments are transferred from the UPS-bonded facility to the designated bonded agent's facility. – A bonded carrier or cartman must be used to transfer goods in-bond from UPS to another carrier based on approval to move the goods from U.S. Customs and Border Protection. – Transfer may be denied by UPS Supply Chain Solutions® Customs Brokerage Services.	\$30.00
United States-Mexico-Canada Agreement (USMCA) Processing	– Special processing to ensure that the required USMCA documentation on a shipment is complete to allow any applicable reduced tariff.	\$21.25
Warehouse Storage – Air/Ground – Per Day After Two Days	– Assessed when shipments remain in the UPS warehouse after the two free days regardless of the customs broker.	\$20.00 + \$0.04 per lb. per day

*All fees charged by any government agency or other third party, if any, will be billed in addition to the listed fees.

**Complex post entry services include, but are not limited to, protests and complex post summary corrections (i.e., tariff exclusions and multiple tariff lines).

How To Use This Guide

Section 1 CHOOSING A SERVICE PAGES [3-9](#)

Section 2 PREPARING A SHIPMENT PAGES [10-24](#)

Section 3 DETERMINING THE RATE PAGES [25-138](#)

Section 4

TRACKING AND PAYMENT

Convenient and up-to-the-minute ways to track shipments are reviewed, as well as an explanation of the UPS invoice, its presentation and various billing and payment options.

- Track your shipment as it moves through the UPS system from drop-off or pickup to completed delivery. Pages [140-141](#)
 - Choose to review your invoice in a variety of electronic formats or as a paper summary. Page [142](#)
 - Select from a number of payment plans that offer weekly and monthly options. Page [143](#)
 - Review solutions for managing your invoice and tips on how to avoid additional charges. Page [144](#)
-

Track Your Shipment

Convenient Ways to Track Shipments

Method	Description
UPS® Mobile App*	– Track your package and freight shipments anytime and anywhere directly from your mobile device. Visit ups.com/mobile to learn more or to download the app.
coyote.com	Provides direct access for customers to create, view, track and settle their own loads, and for carriers to find, accept and update loads. – Network map includes filters to provide a focused, filtered view and ability to hover over lane to see lane information. – Customizable load board allows users to add or remove columns to view the most valuable information. – Streamlined accounting features allow for uploading paperwork, viewing invoices and checking accounting status. – Call 1-877-626-9683 or coyote.com/technology for more information.
CoyoteHOWL®	– CoyoteHOWL® mobile app allows shippers to easily connect with their Coyote reps and access shipments, documents and business trends right from their mobile phones. It offers ability to receive load updates via push notifications and provides shippers free, on-the-go visibility 24/7. – Visit noexcuses.coyote.com/CoyoteHOWL to learn more.
Flex® Global View	– Query status and receive e-mail alerts on Air Freight, Ocean Freight and UPS Worldwide Expedited® Ground Freight shipment exceptions, warehouse inventory and backorders, purchase orders and fulfillment, as well as customs brokerage entries and clearance. – Search by multiple customer reference types, trade lanes, purchase orders, waybills, bills of lading and ocean containers; receive standard and customized reports in PDF, Excel or text formats. – Contact your UPS representative or visit ups.com for more information on Flex Global View .
UPS InfoNotice® Number	– Number assigned by UPS that links all shipments for a delivery attempt together (patent pending). For detailed information on each shipment, go to ups.com or call 1-800-833-9943.
upsfreight.com	– Track UPS Freight® LTL shipments directly from the upsfreight.com homepage using your PRO Number. You can also track using your Bill of Lading or Purchase Order numbers.
UPS My Choice®**	– Provides recipients with proactive delivery alerts via text,** e-mail or UPS® Mobile App push notification the day before delivery and the morning of delivery. Confirmation of delivery and delivery schedule updates are available.
UPS My Choice® for Business	– A new web-based tool designed to give commercial and home-based businesses better control and visibility into their shipments, allowing them to easily manage their UPS services from a customizable dashboard: <ul style="list-style-type: none"> • At-a-glance view of all inbound and outbound shipments with interactive dashboards to easily track shipments • View estimated delivery windows to prepare incoming shipments • Filter by date, shipment characteristics or accounts with updates from label creation to delivery • View current shipment status to provide more accurate timing to customers and help resolve any issues • Set notifications preferences to get automatic status alerts, including for the day before and day of delivery • Enable additional users within your organization to access important visibility information • Learn more and enroll any time at: ups.com/mychoiceforbusiness
PRO Number	– Number automatically assigned to your LTL shipment by UPS Freight® to identify and locate the shipment.
Quantum View® Data*	– An information service that provides package status updates via data files hourly (or as often as requested), when new information is available, about UPS shipments you ship/receive and shipments billed to your UPS account. Files are available in CSV, Flat File (TXT), XML and EDI formats for integration into your software applications and databases. – Contact your UPS representative or visit ups.com/quantumview for more information.
Quantum View Manage®	– Allows you to receive proactive package and freight shipment status information via a user-friendly web interface without having to provide a tracking number. View information about UPS shipments you ship, receive or bill to your UPS account. – Create custom views of shipping information, filter information and results, search by criteria you choose, set alerts, e-mail interested parties with shipping information and download data. – For importers: provides additional inbound solutions to expedite clearance delays, automate customs compliance processes, audit post-clearance shipments prior to the payment of duties, contact UPS Customs Brokerage representatives and archive trade documents. – Contact your UPS representative or visit ups.com/quantumview for more information.
Quantum View Notify®	– Sends proactive e-mail notifications of key package and freight shipment events to as many as five e-mail addresses per request or two SMS recipients when requested in UPS.com tracking or Quantum View Manage. – Choose any combination of three critical shipment notifications for a particular shipment: when shipping information is received by UPS, when the shipment is delivered and when there is an exception which results in a change in the scheduled day of delivery. – Can be requested at the time a shipment is processed in WorldShip® or UPS CampusShip® shipping systems, the UPS App, the UPS® Developer Kit, ups.com shipping and a UPS Ready® solution approved to use this service. – Can also be selected post-shipment at Tracking on ups.com and Quantum View Manage tracking. – Contact your UPS representative or visit ups.com/quantumview for more information. – If UPS carbon neutral is also selected, e-mail notifications will be on a UPS carbon neutral branded template highlighting that the shipment is carbon neutral.
Reference Number	– Number you can assign when you ship to help you identify your shipment. Reference number can contain any combination of letters and numbers up to 35 characters.
Text Message	– Track your package shipment via text messaging. Visit ups.com/mobile to get started.

*Not available for UPS Worldwide Express Freight® Services.

**Your carrier's standard message and data rates may apply.

Track Your Shipment

Convenient Ways to Track Shipments (continued)

Method	Description
Tracking Number	– Number automatically assigned to your shipment by UPS to identify and locate the shipment as it travels through the UPS system.
ups.com	– Track your package and freight shipments directly from the ups.com homepage or click on the Tracking menu to track up to 25 different tracking or UPS InfoNotice® numbers; you can also track by using your own reference numbers.
Within Your Business	– Integrate the Tracking Application Programming Interface (API), one of the UPS Developer Kit APIs, into your business applications or onto your website; use a tracking or reference number to track your package and freight shipments.

PACKAGE

Proof of Delivery (P.O.D.)

Service	Description
Proof of Delivery (P.O.D.)	– Proof of Delivery of a shipment via e-mail, fax or mail is subject to a charge which will be assessed to the shipper. Refer to page 118 for charges and details.
UPS Delivery Confirmation (Domestic)	– Confirmation of delivery for domestic package will be mailed to the shipper. Delivery Confirmation mailings will no longer be included with Signature Required or Adult Signature Required services. Refer to page 115 for charges and details.
Signature Tracking®	– Web-based enhanced shipment tracking for instant access to Proof of Delivery information, including a digital signature image and full delivery address. – Available at no charge. – Sign up at ups.com/myups/login . Once logged in, select Tracking from the Services menu and then choose Signature Tracking from the menu of services on the right side of the page.

Manage Your Claims

Now you can efficiently and conveniently manage your package claims online. From this website you can:

- Report a problem
- Provide claim documentation
- Check the status of a claim
- Receive key status updates via e-mail
- View and download claim history
- Initiate a claim dispute
- Access information about minimizing specific packaging problems that can result in lost or damaged packages
- Contact UPS with questions

You can access the claim site by:

- Visiting [Claims Support](#)
- Going to the Customer Service section under the Support tab on [ups.com](https://www.ups.com)

Plus, the ability to manage your claims has been integrated into systems you already use:

- Tracking on [ups.com](https://www.ups.com): If there is a problem with your package, you will see a link under “File a Claim” on the detailed tracking result page. This link will allow you to report a lost or damaged package or missing C.O.D.

- Quantum View Manage® tracking: If you are a subscriber, you will see a link on the Shipment Progress page to “report a lost or damaged package.”

For UPS Worldwide Express Freight® Midday and UPS Worldwide Express Freight® claims, call 1-800-782-7892.

Reviewing Your Invoice

Viewing, Downloading, Paying and Managing Your Invoice

UPS offers a number of options for viewing, downloading, paying and managing your invoice. You may want to consider one of our information-rich electronic invoice formats, designed to help your company allocate and reconcile UPS charges more effectively. To learn more or enroll in these options, visit ups.com/billing.

Solutions	Description	Benefits
UPS Billing Center	<ul style="list-style-type: none"> – A secure, easy-to-use website that allows you to view, pay and request adjustments to your invoice online. – Provides invoices electronically through online reporting, customized reports or downloading a file of your invoice similar to UPS Billing Data in PDF, CSV (32 and 250 elements) or XML formats. – To learn more, visit ups.com/billing. 	<ul style="list-style-type: none"> – An electronic alternative to receiving paper bills for package and freight services, including Brokerage and UPS Mail Innovations® service. – Receive invoices faster. – Set up/arrange to have payments sent electronically, eliminating the printing and mailing of checks. – Access to supporting brokerage documents (e.g., Commercial Invoice) for U.S. import shipments. – Create/download summary or detailed reports to improve cost allocation for package shipments.* – Print as much or as little of the invoices as needed. – Electronic filing of invoices saves time and space.
UPS Billing Data	<ul style="list-style-type: none"> – UPS Billing Data is a detailed electronic billing file that can be received in a CSV, XML or EDI 210 format. – To learn more, visit ups.com/billing. 	<ul style="list-style-type: none"> – An electronic alternative to receiving paper bills for package and freight services. – Receive invoices faster. – Allows the integration of UPS billing information into accounting and other business applications. – Facilitates faster and easier invoice reconciliation, cost allocation and accounts payable processes.
UPS PDF Invoice	<ul style="list-style-type: none"> – The electronic document is an exact copy of your paper bill and is available for domestic, export, import and LTL bills. – When your bill is ready, UPS will send you an e-mail that directs you to ups.com to receive your invoice. 	<ul style="list-style-type: none"> – Able to view up to 52 weeks of PDF invoices. – Easy record-keeping and allows you to view your statements faster.
UPS Paper Bill	<ul style="list-style-type: none"> – Receive a summary or detailed paper bill sent via the U.S. Mail. 	<ul style="list-style-type: none"> – Does not require a computer to review shipping charges.
coyote.com	<ul style="list-style-type: none"> – Provides direct access for customers to create, view, track and settle their own loads, and for carriers to find, accept and update loads. – Call 1-877-626-9683 or coyote.com/technology for more information. 	<ul style="list-style-type: none"> – Network map includes filters to provide a focused, filtered view and ability to hover over lane to see lane information. – Customizable load board allows users to add or remove columns to view the most valuable information. – Streamlined accounting features allow for uploading paperwork, viewing invoices and checking accounting status. – Simplified tracking allows you to flag and track high-priority shipments, export entire load activity for easy viewing and mark specific commodities to quickly view all related shipments.

*Not available for Air Freight, Ocean Freight and UPS Worldwide Expedited® Ground Freight.

Reviewing Your Invoice

PACKAGE

UPS Billing and Payment Schedules

Schedules	Description
Billed Weekly/Pay Weekly	<ul style="list-style-type: none"> – Receive an invoice weekly and pay weekly. – Payment is due within the terms stated on the invoice. – A late payment fee will be assessed on balances that are past due. – Payment can be made by Electronic Funds Transfer, credit card or check. – Electronic Payment options are available via the UPS Billing Center.
Billed Weekly/Pay Monthly	<ul style="list-style-type: none"> – Receive an invoice weekly but pay only once a month. – A prepayment equal to four weeks' average shipping charges must be made and will remain on account with UPS. – Payment is due within the terms stated on the invoice. – A late payment fee will be assessed on balances that are past due. – Payment can be made by Electronic Funds Transfer or check. – Electronic Payment options are available via the UPS Billing Center.
Billed Monthly/Pay Monthly*	<ul style="list-style-type: none"> – Receive an invoice monthly and pay monthly. – A prepayment equal to four weeks' average shipping charges must be made and will remain on account with UPS. – To avoid a prepayment, a Credit Extension Fee can be charged based on your annual shipping charges and is subject to change annually. – Establishing an Electronic Funds Transfer payment option allows you to avoid a prepayment and the Credit Extension Fee. – Payment is due within the terms stated on the invoice. – A late payment fee will be assessed on balances that are past due. – Payment can be made by Electronic Funds Transfer or check. – Electronic Payment options are available via the UPS Billing Center.

*Monthly billing is limited to customers with average shipping charges of \$200.00 or less per week. To be eligible for the Credit Extension Plan, you must use UPS transportation services solely for business, commercial or agricultural purposes. The first-year fee is \$45.00. The fee for each following year will be based on yearly revenue. If the yearly revenue is under \$15,600.00, the fee will be \$45.00. If the yearly revenue exceeds \$15,600.00, the fee will be the actual yearly revenue multiplied by .0163.

Notes:

- UPS reserves the right to approve billing and payment schedules and payment methods requested.
- The “UPS Tariff/Terms and Conditions of Service – United States” available at [ups.com/terms](https://www.ups.com/terms) contains provisions for a late payment fee on past-due balances (including, without limitation, any previously assessed, but unpaid, late payment fees).
- The shipper should check with its bank to ensure that there are no fees for electronic transactions.

Reviewing Your Invoice

Solutions for Managing Your Invoice

UPS offers a variety of options to help you manage your shipping costs by allowing you to determine who pays what portion of the shipping charges.

UPS Billing/Payer Options

Options	Description
PACKAGE, AIR FREIGHT, LESS-THAN-TRUCKLOAD AND UPS WORLDWIDE EXPEDITED® GROUND FREIGHT	
Bill Shipper (Prepaid)	– Shipper's UPS account is billed for shipping charges.
Bill Receiver (Freight Collect)	– Receiver's UPS account is billed for shipping charges.
Bill Third Party	– A third party's UPS account is billed for shipping charges.
INTERNATIONAL PACKAGE	
Free Domicile	– The shipper pays all costs of delivery, including customs clearance fees, directly to the door of the consignee.
Split Duty and Tax	– Shipper's UPS account is billed for shipping charges and duties. – Receiver's UPS account is billed for all taxes.
AIR FREIGHT AND UPS WORLDWIDE EXPEDITED GROUND FREIGHT	
Shipper's Check Received	
– Delivery Duties Paid (DDP)*	Fees vary by country and seller's charges.
– Delivery Duties Unpaid (DDU)*	Importer is responsible for fees that vary by country.

**For a quoted price, the seller/exporter clears the goods for export and is responsible for making them available to the buyer at the named place of destination cleared for import, but not unloading them from the transport vehicle.*

Notes:

- For international shipments, the above billing options can be used in combination with one another, allowing the shipper, receiver or third party to be billed for all or part of the shipping charges. International shipping charges typically include the cost of transportation, duties, brokerage fees and taxes.
- Unless otherwise specified at the time of shipping, shipping charges are billed to the shipper. In the event of non-payment by the consignee or third party, the charges are billed to the shipper.

Managing Inbound Charges

Control who can and cannot bill shipping charges to your UPS account number. There are two convenient ways to manage this process. Select the option that is appropriate for your business needs.

– Allow any shipper to bill shipping charges to your UPS account number, except for certain shippers you wish to exclude.

– Allow only certain shippers to bill shipping charges to your UPS account and exclude all others.

To begin controlling your inbound charges, go to [ups.com/billing](https://www.ups.com/billing).

Consolidated Payment Plans

A Consolidated Payment Plan offers a convenient way to aggregate UPS invoices for multiple UPS account numbers into a single invoice for payment.

Consolidated Payment Plans can be created for UPS domestic, export and import invoices.

To learn more about Consolidated Payment Plans, call 1-800-PICK-UPS® (1-800-542-5877).

Managing Additional Charges

Additional charges can occur when shipments are not processed properly.

Tips for avoiding these charges may be found at [ups.com/avoidcharges](https://www.ups.com/avoidcharges).

Index

A

Additional Charges	
<i>See Value-Added Services and Other Charges</i>	112-138
Additional Consignee or Invoice	136
Additional Handling	113, 122
Address Correction	113, 127
Air Freight	129
Package	122
UPS Worldwide Expedited Ground Freight	133
Adult Signature Required	112, 118, 141
Air Freight Services	74-75
Air Shipping Documents (ASDs)	22
Alcoholic Beverages	8
Alliance Location (Staples)	9, 24
Ammunition	8
Authorized Shipping Outlet	9, 24
Automated Processing	
Air Freight	21, 22
LTL	21, 22
Package	21, 22

B

Batteries	11
Bill of Lading	
Corrected Bill of Lading	127, 131
LTL	22
Billing Options	112
Air Freight	144
LTL	144
Package	114, 143-145
Bonds	
Continuous Transaction Bond	136
In-Transit Bond (IT Bond)	136
Single Entry Bond (SEB)	136
Branded Tracking from UPS	112, 114
Brokerage Services	76, 94, 134-138
Bundled or Strapped Boxes	11

C

Canada	
Canada Zone Chart	
Export	33-37
Import	42
UPS Standard	
From Canada	4, 42, 94, 107-109, 135
To Canada	4, 33-37, 76, 88-90
UPS 3 Day Select from Canada	4, 42, 94, 106, 135
UPS Worldwide Service to Canada	4
Certificate of Origin	112, 114, 126
Air Freight	128
Package	114
UPS Worldwide Expedited Ground Freight	132
Chargeback for Consignee Billing Shipments	113, 127
Air Freight	129
Package	122
UPS Worldwide Expedited Ground Freight	133
Check	142, 143, 144
Claims	141
Collect on Delivery (C.O.D.) Services	112, 126
C.O.D. Automatic	114
C.O.D. Direct	114
C.O.D. Secure	115
C.O.D. Service Restrictions	8
Delayed Deposit	114
LTL	130
Manual C.O.D. Tags	114
Package	114
Complex Entries	136
Corrected Bill of Lading	127, 131
Coyote Logistics	21, 140, 142
Collaborative Transportation Management	5, 6
CoyoteHOWL	22, 140
Truckload and Intermodal	5, 6
Credit Extension Fee	143
Currency Conversion Rate	112, 115
Customer Service	
International Customer Service	76, 94
Customized Brokerage Services	137
Customized Returns	119
Customs Brokerage	76, 94, 134-138
Customs Clearance Entry Preparation Charges	135
Customs Entry Packets	137

Index

D

Daily On-Route Pickup	23 , 112 , 120
Daily Pickup	23 , 112 , 120
Dangerous Goods	113 , 127
Air Freight	129
International	123
Day-Specific Pickup	23 , 112 , 120
Declared Value for Carriage	112 , 126
Air Freight	128
LTL	130
Package	115
UPS Worldwide Expedited Ground Freight	132
Dedicated Contract Carriage	6
Delivery Area Surcharge	113 , 122
Commercial, Commercial Extended	122
Residential, Residential Extended	122
Delivery Attempt	
Air Freight	129
UPS Worldwide Expedited Ground Freight	133
Delivery Change Options	115
Delivery Change Request	112 , 115
Delivery Reattempt	115 , 122
Destination Outside Service Area	113 , 122
Detention of Vehicle	127
LTL	131
UPS Worldwide Expedited Ground Freight	133
Determine the Rate	
Domestic, Export and Import	26-27
Determine the Weight and Size	16-20
Air Freight	19-20
Domestic Shipments	16-17
International Shipments	16-17
Irregularly Shaped Packages	17
Items Shipped in Bags	17
Letter Rates	17
UPS Worldwide Expedited Ground Freight	19
UPS Worldwide Express Freight	18
UPS Worldwide Express Freight Midday	18
Determine the Zone	
Domestic	27
Export	27
Import	27
Dimensional Weight	
Air Freight	19-20
Package	16-17 , 76 , 94
Domestic	16-17
International	16-17
UPS Worldwide Expedited Ground Freight	19
UPS Worldwide Express Freight	18
UPS Worldwide Express Freight Midday	18
Direct Delivery Only	112 , 116
Disbursement Fee	137

D (continued)

Documentation	
Air Shipping Documents (ASDs)	22
Domestic Package Rates and Services	
UPS Express Critical	4 , 5 , 7
UPS Ground	4 , 68-71
UPS Next Day Air	4 , 48-51
UPS Next Day Air Early	4 , 44-47
UPS Next Day Air Saver	4 , 52-55
UPS 2nd Day Air	4 , 60-63
UPS 2nd Day Air A.M.	4 , 56-59
UPS 3 Day Select	4 , 64-67
Domestic Freight Service Options	
Air Freight	74-75
LTL	6
TL and Intermodal	6
Dry Ice	7 , 113 , 123
Duty	137
Duty Drawbacks	136

E

Electronic Export Information (E.E.I.)	112 , 116
Electronic Funds Transfer	143
Electronic Label	116
Electronic Media	11 , 17
Electronic Return Label	112 , 119
Entry-Line Charge	136
Export Support	76 , 94
Extended Area Surcharge	113 , 123

F

Fabric and Wallpaper	11
Firearms	8
Fish and Wildlife (F&W) Entry Preparation	136
Flex Global View	140
Foreign Trade Zone (FTZ) Entry	136
Formal Entry	138
Freight Between the U.S. and Mexico	4 , 5 , 126 , 127
Freight Preparation	13-15
Fuel Surcharge	114-125 , 128-133
Full Container Load (FCL) NVOCC Service	5

Index

G

Ground Shipping Documents [22](#)

H

Hazardous Materials and Dangerous Goods [113, 127](#)
 Air Freight [129](#)
 LTL [131](#)
 Package [123](#)

Hazardous Materials and
 International Dangerous Goods [7, 8, 113, 123](#)

Hazardous Materials Service Restrictions
 Setting Up Service [7](#)
 To and From Alaska, Hawaii, Puerto Rico
 and Catalina Island [7](#)

Hearing Impaired Service Number 1-800-833-0056

Heavy Package [12](#)

Heavy Package Sticker [12](#)

Hold at Destination Airport for Pickup (HAPU) [126](#)
 Air Freight [128](#)
 UPS Worldwide Expedited Ground Freight [132](#)

Hold at Location [112, 116](#)

Hold for Pickup [112, 116](#)

I

Import Support [76, 94](#)

Inside Delivery and Inside Pickup [127, 131](#)

Intermodal [6](#)

International Customer Service Center 1-800-782-7892

International Dangerous Goods (IDG) [7, 8, 113, 123](#)

International Freight Services [4, 5](#)

International Rates and Services

UPS Air Freight Consolidated [4](#)

UPS Air Freight Direct [4](#)

UPS Air Freight Premium Direct [4](#)

UPS Express Critical [4, 5](#)

UPS Standard from Canada [4, 94, 107-108, 135](#)

UPS Standard to Canada [4, 33-37, 76, 88-90](#)

UPS Standard from Mexico [4, 109-111](#)

UPS Standard to Mexico [4, 76, 91-93](#)

UPS 3 Day Select from Canada [4, 94, 106](#)

UPS Worldwide Expedited [4, 5, 76, 85-87, 94, 103-105](#)

UPS Worldwide Express [4, 76, 77-79, 94, 95-97](#)

UPS Worldwide Express Freight [4, 76, 81, 94, 99](#)

UPS Worldwide Express Freight Midday [4, 76, 80, 94, 98](#)

UPS Worldwide Express NA1 [4, 94, 95-97](#)

UPS Worldwide Express Plus [4, 76, 77-79, 94, 95-97](#)

UPS Worldwide Saver [4, 76, 82-84, 94, 100-102](#)

I (continued)

International Service Options [4, 5](#)

Invoice

Air Freight [144](#)

Invoice Removal [116](#)

LTL [144](#)

Package [136, 143-144](#)

UPS Worldwide Expedited Ground Freight [144](#)

Irregularly Shaped Items and Bare Metals [12](#)

J

Jewelry [8](#)

L

Label

Electronic Label [116](#)

Electronic Return Label [112, 119](#)

1 UPS Pickup Attempt Label [112, 116, 119](#)

Print and Mail Label [116](#)

Print and Mail Return Label [112, 119](#)

Print Label [116](#)

Print Return Label [112, 119](#)

3 UPS Pickup Attempts Label [112, 116, 119](#)

UPS Smart Label [22](#)

Large and/or Heavy Packages [12](#)

Large Package Surcharge [17, 113, 123](#)

Late Payment Fee [143](#)

Less-Than-Container Load (LCL) NVOCC Service [5](#)

Less-Than-Truckload (LTL) Services

LTL [5, 6](#)

LTL Guaranteed [5, 6](#)

LTL Guaranteed A.M. [5, 6](#)

LTL Urgent [5, 6](#)

Liftgate Services [127](#)

Air Freight [129](#)

LTL [131](#)

UPS Worldwide Expedited Ground Freight [133](#)

Limited Quantities (Ltd Qty) [7, 24, 26, 27](#)

Index

M

Manual Processing	
LTL	22
Package	22
Marking Notice Processing	138
Maximum Declared Values	8
Maximum Length	8
Maximum Size	8
Maximum Weight	8
Merchandise Processing Fee	138
Mexico	
UPS Standard	
From Mexico	4, 109-111, 135
To Mexico	4, 91-93
Zone Chart	38, 43
Missing/Invalid Account Number or Refusal Fee	113, 127
Air Freight	129
Package	124
UPS Worldwide Expedited Ground Freight	133
Missing PLD Fee	124
MyFreight	21
My LTL Freight	21

N

Non-Conforming Freight	127
Air Freight	129
UPS Worldwide Expedited Ground Freight	133
Non-Resident Importer (NRI)	112, 118
North American Freight	5
Notification Prior to Delivery	127, 131

O

Ocean Freight	5
Ocean Freight Forwarding	5
1 UPS Pickup Attempt Label	112, 116, 119
Other Charges	113, 127
Air Freight	129
LTL	131
Package	122-125
UPS Worldwide Expedited Ground Freight	133
Over Maximum Limits	113, 124
Oversize	127
Air Freight	129
LTL	131
UPS Worldwide Expedited Ground Freight	133
Oversize Pallet Handling Surcharge	113, 124
Overtime/Special Handling Service	138

P

Pack & Ship Guarantee	12, 24
Package Tracking, Tracing and Refund Requests	113, 124
Packaging Assistance	
Packaging Advisor	12
Packing Services	12
UPS Package Design and Test Lab	12
Packaging Guidelines	13-15
Air Freight	13-15
LTL	13-15
UPS Worldwide Expedited Ground Freight	13-15
UPS Worldwide Express Freight	13-15
UPS Worldwide Express Freight Middy	13-15
Packaging Needs	
Heavy Package	12
Packages Weighing More Than 70 Pounds	12
Special Packaging Needs	11-12
Palletized Freight	13-15
Non-Palletized Freight	13, 15
Palletized Shipments	13, 80, 98
International Palletized Shipments	18
Partner Government Agency (PGA) Clearance	137
Payer Rebilling Fee	127
Air Freight	129
UPS Worldwide Expedited Ground Freight	133
Payment Options	142-144
Peak Surcharges	124
Pickup and Drop-off Availability	23-24
Pickup Area Surcharge	113, 124
Pickup Notifications for LTL	23
Post Entry Services	138
Prepare Your Shipment	
<i>See Packaging Guidelines</i>	13
Pre-Release Notification	138
Print and Mail Label	116
Print and Mail Return Label	112, 119
Print Label	116
Print Return Label	112, 119
Prior Notice for Food and Food Products	137
Prohibited and Restricted Goods	
Export and Import	7-9
Package	7-9
Prohibited Item Fee	113, 124
Project Cargo Management	5
PRO Number	14, 140
Proof of Delivery (P.O.D.)	112, 126
Air Freight	128
LTL	130
Package	118, 141
UPS Worldwide Expedited Ground Freight	132

Index

Q

Quantum View Data	140
Quantum View Manage	140
Quantum View Notify	140

R

Rates	
Air Freight	27, 74-75
Package	
Domestic	27, 44-71
Export	27, 77-93
Import	27, 95-111
Rebill Fee	113, 124
Redelivery	127
Air Freight	129
LTL	131
UPS Worldwide Expedited Ground Freight	133
Reference Number	140
Remote Area Surcharge	113, 125
Residential Delivery/Pickup	127
Air Freight	129
LTL	131
UPS Worldwide Expedited Ground Freight	133
Residential Surcharge	113, 125
Returns and The UPS Store	112, 119
Reviewing Your Invoice	142-144

S

Saturday Air Processing Fee (Saturday Pickup)	112
Package	120
Saturday Delivery	112, 126
Air Freight	128
Package	118
Saturday Pickup	112, 126
Air Freight	128
Package	120
Saturday Stop Charge	112, 120
Scheduled Pickup	112, 120
UPS On-Call Pickup	112, 120
UPS Smart Pickup	112, 120

S (continued)

Saturday, Sunday or Holiday Delivery	126, 130
LTL	130
Saturday, Sunday or Holiday Pickup	126, 130
LTL	130
Scheduled Pickup Options	23, 120
Daily On-Route Pickup	23, 112, 120
Daily Pickup	23, 112, 120
Day-Specific Pickup	23, 112, 120
Package	23, 120
UPS Smart Pickup	23, 112, 120
Service Options	
Air Freight	4, 5
LTL	5, 6
Package	
Domestic	4
International	4, 5
Truckload and Intermodal	5, 6
Service Restrictions	7-9
Air Freight	7-9
LTL	7-9
Package	7-9
Prohibited and Restricted Goods	8-9
Ship to a UPS Access Point Location	112, 118
Shipment Pricing	
Export	76
Import	94
Shipper Release	112, 121
Shipper's Export Declaration (S.E.D.)	
<i>See Electronic Export Information</i>	112, 116
Shipping Charge Correction Audit Fee	113, 125
Shipping Forms	76, 94
Shipping Solutions	21-22
Signature Required	112, 118, 141
Signature Tracking	141
Special Handling of Undeliverable Shipments	113, 125
Special Packaging Needs (Package)	11-12
Staples	9, 24
State Classifications and Abbreviations	
West and East	28
Storage	127, 131

Index

T

Table of Contents	2
Telecommunications Device for the Deaf Service Number	1-800-833-0056
Temperature Protection Services	6
Temporary Import Under Bond	137
The UPS Store	9, 12, 24, 117, 119
Thermal Label Printer	22
Third Party Billing Service	112, 121
Third-Party Retail Locations Alliance Location [Staples] as well as Authorized Shipping Outlets	9, 24
3 UPS Pickup Attempts Label	112, 116, 119
Tires	12
Tobacco	9
Track Your Shipment	140-141
Flex Global View	140
PRO Number	140
Quantum View Data	140
Quantum View Manage	140
Quantum View Notify	140
Reference Number	140
Text Message	140
Tracking Number	140
UPS App	140
UPS InfoNotice Number	140
UPS My Choice	140
UPS My Choice for Business	140
Trade Show Services	6
Transportation Handling	138
Truck Waiting Time	127
Air Freight	129
UPS Worldwide Expedited Ground Freight	133

U

Undeliverable Shipment Surcharge	113, 125
United States-Mexico-Canada Agreement (USMCA) Processing	138
ups.com	140
ups.com shipping	21
UPS Access Point	24, 112, 118
UPS Air Freight Consolidated	4, 19
UPS Air Freight Direct	4, 19
UPS Air Freight Premium Direct	4, 19
UPS Alliance Location (Staples)	9, 24
UPS App	22, 140
UPS Authorized Return Service	112, 119
UPS Authorized Shipping Outlet	9, 24

U (continued)

UPS Billing and Payment Schedules	
Billed Monthly/Pay Monthly	143
Billed Weekly/Pay Monthly	143
Billed Weekly/Pay Weekly	143
UPS Billing Center	142
UPS Billing Data	142
UPS Billing/Payer Options	
Bill Receiver (Freight Collect)	144
Bill Shipper (Prepaid)	144
Bill Third Party	144
Free Domicile	144
Shipper's Check Received	144
Split Duty and Tax	144
UPS Broker of Choice	134, 137
UPS CampusShip	21
UPS carbon neutral	112, 114
UPS C.O.D.	114
UPS Customer Center	24
UPS Delivery Confirmation	112, 115, 141
UPS Delivery Intercept	112, 115
UPS Developer Kit	22
UPS Drop Box	24
UPS Express Critical	4, 5
UPS Express Pak	17
upsfreight.com	140
UPS Freight Services	
Dedicated Contract Carriage	5, 6
LTL	5, 6, 23, 126, 127
LTL Guaranteed	5, 6, 23, 126, 127
LTL Guaranteed A.M.	5, 6, 23, 126, 127
LTL Urgent	5, 6, 23, 126, 127
Temperature Protection Services	5, 6, 23
Trade Show Services	5, 6, 23
UPS FTZ Facilitator	135, 137
UPS Ground	4, 22, 68-71, 112, 113
UPS Ground Shipping Documents	22
UPS Ground with Freight Pricing	4, 6, 112, 113
UPS Hundredweight Service	6
UPS Import Control	94, 112, 117
UPS InfoNotice Number	140
UPS Mail Innovations Returns	119
UPS marketplace shipping	21
UPS My Choice for Business	112, 117
UPS My Choice	112, 117, 140
UPS My Choice Member	117
UPS My Choice Premium Member	117
UPS Next Day Air Letter Rate	4, 48-51, 112, 113 48

Index

U (continued)

UPS Next Day Air Early Letter Rate	4, 44-47, 112, 113 44
UPS Next Day Air Freight	5, 19, 74, 126, 127
UPS Next Day Air Freight NGS	5, 19, 75, 126, 127
UPS Next Day Air Saver Letter Rate	4, 52-55, 112, 113 52
UPS On-Call Pickup	23, 112, 118, 120
UPS On-Call Pickup Area Surcharge	113, 124
UPS On-Call Pickup Saturday Stop Charge	112, 120
UPS Package Design and Test Lab	12, 14
UPS Paper Bill	142
UPS Paperless Invoice	76, 94
UPS Preferred Multimodal Freight Services	5
UPS Premier	112, 118
UPS Ready	21, 22
UPS Returns	
Customized Returns	119
Returns and The UPS Store	112, 119
UPS Mail Innovations Returns	119
UPS Returns Exchange	112, 119
UPS Returns Services	9, 119
UPS 2nd Day Air Letter Rate	4, 60-63, 112, 113 60
UPS 2nd Day Air A.M. Letter Rate	4, 56-59, 112, 113 56
UPS 2nd Day Air Freight	5, 19, 74, 126, 127
UPS 2nd Day Air Freight NGS	5, 19, 75, 126, 127
UPS Service Guarantee	125, 134, 135
UPS Services	
Air Freight	4, 5
Domestic	4, 5
International	4, 5
LTL	5, 6
Truckload and Intermodal	5, 6
UPS Services Website Address	ups.com/services
UPS Simple Rate	72-73
UPS Smart Label	22
UPS Smart Pickup	23, 112, 120
UPS Smart Pickup Saturday Stop Charge	112, 120
UPS Standard	
From Canada	4, 42, 94, 107-108, 112, 113, 135
From Mexico	4, 43, 109-111, 112, 113, 135
To Canada	4, 33-37, 76, 88-90, 112, 113
To Mexico	4, 38, 76, 91-93, 112, 113
UPS Standard LTL	5, 126, 127
UPS Standard Truckload	5
UPS Standard Zone Chart	
From Canada	42
From Mexico	43
To Canada	33-37
To Mexico	38

U (continued)

UPS Supply Chain Solutions Call Centers	23
UPS Supply Chain Solutions Quick Zip	74, 75
UPS 3 Day Freight	5, 19, 74, 126, 127
UPS 3 Day Freight NGS	5, 19, 75, 126, 127
UPS 3 Day Select	4, 7, 22, 64-67,
UPS 3 Day Select from Canada	4, 42, 94, 106, 112, 113, 135
UPS TradeAbility	76, 94
UPS Website Address	ups.com
UPS Worldwide Expedited	112, 113
Export	4, 29-37, 76, 85-87
Import	4, 39-41, 94, 103-105, 135
UPS Worldwide Expedited Air Freight	5, 19
UPS Worldwide Expedited Ground Freight	5, 19, 126, 127, 132, 133
UPS Worldwide Expedited Truckload	5
UPS Worldwide Express	112, 113
Export	4, 29-37, 76, 77-79
10 KG Box	77
25 KG Box	77
Letter Rate	77
Pak Rate	77
Import	4, 39-41, 94, 95-97, 135
Letter Rate	95
UPS Worldwide Express Freight	112, 113
Export	4, 29-37, 76, 81
Import	4, 39-41, 94, 99, 135
UPS Worldwide Express Freight Center	24
UPS Worldwide Express Freight Midday	112, 113
Export	4, 29-37, 76, 80
Import	4, 39-41, 94, 98, 135
UPS Worldwide Express NA1	112, 113
Import	4, 39, 40, 41, 94, 95-97, 135
Letter Rate	95
UPS Worldwide Express Plus	112, 113
Export	4, 29-37, 76, 77-79
10 KG Box	77
25 KG Box	77
Letter Rate	77
Pak Rate	77
Import	4, 39-41, 94, 95-97, 135
Letter Rate	95
UPS Worldwide Saver	112, 113
Export	4, 29-37, 76, 82-84
10 KG Box	82
25 KG Box	82
Letter Rate	82
Pak Rate	82
Import	4, 39-41, 94, 100-102, 135
Letter Rate	100
UPS Worldwide Services Waybill	22

Index

V

Value-Added Services	112 , 126
Air Freight	128
LTL	130
Package	114-121
UPS Worldwide Expedited Ground Freight	132
Vaping Products	9

W

Warehouse	
Entry	137
Storage	138
Waybill	22
Weapons	8
Weight and Size Information	
Air Freight	19
Package	16-17
UPS Worldwide Expedited Ground Freight	19
UPS Worldwide Express Freight	18
UPS Worldwide Express Freight Midday	18
West and East State Classifications	28
World Ease	112 , 121
WorldShip	21

Z

Zone Charts	
Air Freight	27 , 29-43
Package	
Determine the Zone	27 , 29-43
International Export	
Except Canada	29-32
To Canada	33-37
To Mexico	38
International Import	
UPS Standard from Mexico	43
UPS 3 Day Select and UPS Standard from Canada	42



[ups.com](https://www.ups.com)

© 2021 United Parcel Service of America, Inc. UPS, the UPS brandmark and the color brown are trademarks of United Parcel Service of America, Inc. All rights reserved. 4/21

Event Summary - NASPO Small Package Delivery Services

Type	Request for Proposal No Line Item	Number	CH21-36
Stage Title	-	Organization	StateOfUtah
Currency	US Dollar	Event Status	Awarded
Work Group	Division of Purchasing	Exported on	9/14/2021
Exported by	Cherilyn Hess	Estimated Value	-
Payment Terms	-		

Bid and Evaluation

Respond by Proxy	Allow	Use Panel Questionnaire	No
Sealed Bid	Yes	Auto Score	No
		Cost Analysis	No
Alternate Items	No		

Visibility and Communication

Visible to Public Yes

Enter a short description for this public event

The State of Utah, Division of Purchasing and General Services is requesting proposals for Small Package Delivery Services in collaboration with NASPO ValuePoint.

Commodity Codes

Commodity Code	Description
78100	Mail and cargo transport including transport of letters and parcels and postal and small parcel and courier services and letter or small parcel local delivery services and worldwide delivery services

Event Dates

Time Zone	MDT/MST - Mountain Standard Time (US/Mountain)
Released	-
Open	3/12/2021 2:00 PM MST
Close	4/26/2021 2:00 PM MDT
Sealed Until	4/26/2021 2:00 PM
	<input type="checkbox"/> Show Sealed Bid Open Date to Vendor
Q&A Close	4/16/2021 10:45 AM MDT

Event Users

Event Creator

Cherilyn Hess

chess@utah.gov

Event Owners

Cherilyn Hess

chess@utah.gov

SciQuest Admin

sciquestadmin@utah.gov

Contacts

Cherilyn Hess

chess@utah.gov

Stakeholders

Christopher Jennings

ctjennings@utah.gov

Purchasing Records Officer

purchgrama@gmail.com

Kayla Medina

kaylamedina@utah.gov

Tiffany Rydalch

trydalch@utah.gov

Tara Eutsler

teutsler@utah.gov

Cherilyn Hess

chess@utah.gov

Description

The State of Utah

Division of Purchasing & General Services

In conjunction with

NASPO ValuePoint

Request for Proposal

State of Utah Solicitation Number CH21-26

NASPO ValuePoint Master Agreement for

Small Package Delivery Services

This Request for Proposals ("RFP") is issued in accordance with the Utah Procurement Code and applicable administrative rules of the Utah Administrative Code. If any provision of this RFP conflicts with the Utah Procurement Code or Utah Administrative Code, then the Utah Procurement Code or Utah Administrative Code will take precedence.

Purpose of this Solicitation

The purpose of this RFP is to enter into a contract to provide: NASPO ValuePoint Master Agreement for Small Package Delivery Services.

This RFP and resulting contract award(s) is a solutions-based solicitation; meaning the State of Utah is seeking equipment, products, and/or services that meet the requirements of this RFP and that are commonly desired or are required by law or industry standards. Offerors may include related equipment, accessories, and services to the extent that these solutions are complementary to the equipment, products, and/or services identified in this RFP.

Given the cooperative nature of this RFP, it is expected that offerors shall propose a wide array of equipment, products, and/or services at lower prices and with better value than what they would ordinarily offer to the public or to a single government entity.

Closing date and time

The closing date and time for this sourcing event is as provided in this posting. If your time is different from that shown, your profile may be set to a different time zone. Please see the attachment titled "Changing Your Time Zone" in the Buyer Attachments section for directions on how to update your profile. It is your responsibility to make sure you submit your response by the date and time indicated above.

Multiple Contract Award Anticipated

It is anticipated that this RFP will result in multiple contract awards. The methodology or formula that will be used to determine the number of contract awards is: Any offeror that receives a combined total score of 65% of all available points will be offered a contract. There are 1600 technical points available and 400 cost points for each region. Thus, any vendor that complies with the requirement of this RFP and achieves a minimum score of 1300 out of 2000 total points (technical + cost) will receive a contract for each region.

Future Procurements

The State of Utah reserves the right and may reopen this solicitation, or create a new solicitation if it determines there may be more competition for the procurement item than when the original solicitation was posted.

Length of the Contract

The contract resulting from this RFP will be for FIVE (5) years.

Background

NASPO ValuePoint is the cooperative contracting arm of the National Association of State Procurement Officials (NASPO). NASPO is a non-profit association dedicated to strengthening the procurement community through education, research, and communication. It is made up of the directors of the central purchasing offices in each of the 50 states, the District of Columbia, and the territories of the United States. NASPO ValuePoint facilitates administration of the cooperative group contracting consortium of state chief procurement officials for the benefit of state departments, institutions, agencies, and Political Subdivisions (i.e. colleges, school districts, counties, cities etc.) and other eligible entities (i.e. Non-Profit Organizations, etc.) for all States, the District of Columbia, and territories of the United States. For more information, consult the NASPO website (<http://www.naspo.org>) and the NASPO ValuePoint website (<http://www.naspovaluepoint.org>).

Issuing Procurement Unit, Conducting Procurement Unit, and Solicitation Number

The State of Utah Division of Purchasing is the issuing procurement unit and the conducting procurement unit for this RFP (referred to as "the State"). The reference number for this RFP is Solicitation #CH21-36. This solicitation number must be referred to on all proposals, correspondence, and documentation submitted to the State relating to this RFP.

Additional Information

Offerors are prohibited from communications regarding this RFP with the conducting procurement unit staff, evaluation committee members, or other associated individuals EXCEPT the State of Utah Division of Purchasing procurement officer overseeing this RFP.

Wherever in this RFP an item is defined by using a trade name, brand name, or a manufacturer and/or model number, it is intended that the words, "or equivalent" apply; and invites the submission of equivalent products by the Offerors.

Offerors may be required to submit product samples to assist the chief procurement officer or head of a procurement unit with independent procurement authority in evaluating whether a procurement item meets the specifications and other requirements set forth in the request for proposals. Product samples must be furnished free of charge unless otherwise stated in the request for proposals, and if not destroyed by testing, will upon written request within any deadline stated in the request for proposals, be returned at the Offeror's expense. Samples must be labeled or otherwise identified as specified in the request for proposals by the procurement unit.

The issuing procurement unit may not accept a proposal after the time for submission of a proposal has expired.

The State reserves the right to conduct discussions with the Offerors who submit proposals determined to be reasonably susceptible of being selected for award, but proposals may be accepted without discussions.

New Technology

Pursuant to Utah Administrative Rule R33-12-502 the awarded contract(s) may be modified to incorporate new technology or technological upgrades associated with the procurement item being solicited, including new or upgraded: (i) systems; (ii) apparatuses; (iii) modules; (iv) components; and (v) other supplementary items. Further, a maintenance or service agreement associated with the procurement item under the resulting contract(s) may be modified to include any new technology or technological upgrades. Any contract modification incorporating new technology or technological upgrades will be specific to the procurement item being solicited and substantially within the scope of the original procurement or contract.

Evaluation Administrative and Mandatory Minimum Requirement Compliance

Each proposal received shall be evaluated as outlined in this RFP and the Utah Procurement Code.

To be responsive and responsible Offerors must review and respond to the following sections of this RFP: Prerequisites, Buyer Attachments, Questions, and Items.

- The Prerequisites section includes the objective and subjective criteria that will be used to evaluate the proposals, which include the mandatory minimum requirements, technical criteria, and other prerequisites that Offerors must read and agree to in order to respond to this RFP.
- The Buyer Attachments Section contains the standard contractual terms and conditions required by the State and any other required documents associated with this RFP.

- The Questions Section contains the questions that Offerors are required to answer in order to submit a proposal.

Offerors must review each section carefully.

Right to Open For Competition

The State of Utah reserves the right and may reopen this solicitation, or create a new solicitation if it determines there may be more competition for the procurement item than when the original solicitation was posted.

Prerequisites

★ Required to Enter Bid

1 ★ Instructions To Vendor :

Offerors are encouraged to review this RFP prior to the deadline to submit a proposal, even if a proposal has been submitted, in case an addendum has been issued by the issuing procurement unit.

Certification

I certify that I have read and agree to the terms above.

Vendor Must Also Upload a File:

No

Prerequisite Content:

Addenda shall be published within a reasonable time prior to the deadline that proposals are due, to allow prospective offerors to consider the addenda in preparing proposals. Publication at least 5 calendar days prior to the deadline that proposals are due shall be deemed a reasonable time. Minor addenda and urgent circumstances may require a shorter period of time. After the due date and time for submitting a proposal to this RFP, at the discretion of issuing procurement unit, addenda to this RFP may be limited to Offerors that have submitted proposals, provided the addenda does not make a substantial change to this RFP.

2 ★ **Instructions To Vendor :**

All questions must be submitted through SciQuest during the Question and Answer period.

Certification

I certify that I have read and agree to the terms above.

Vendor Must Also Upload a File:

No

Prerequisite Content:

The Question and Answer period closes on date and time specified on SciQuest. All questions must be submitted through SciQuest during the Question and Answer period. Answers from the State will be posted on SciQuest. Questions may include notifying the State of any ambiguity, inconsistency, scope exception, excessively restrictive requirement, or other errors in this RFP. Questions are encouraged.

Questions may be answered individually or may be compiled into one document.

Questions may also be answered via an addendum. An answered question or an addendum may modify the specification or requirements of this RFP. Answered questions and addenda will be posted on SciQuest. Offerors should periodically check SciQuest for answered questions and addenda before the closing date. It is the responsibility of the Offerors to submit their proposals as required by this RFP, including any requirements contained in an answered question and/or addenda.

3 ★ **Instructions To Vendor :**

Offerors may request that part of its proposal be protected by submitting a Claim of Business Confidentiality Form. See the Buyers Attachment section.

Certification

I certify that I have read and agree to the terms above.

Vendor Must Also Upload a File:

No

Prerequisite Content:

Pricing may not be classified as confidential or protected and will be considered public information.

Process for Requesting Non-Disclosure: To protect information under a Claim of Business Confidentiality, an Offeror must complete the Claim of Business Confidentiality form, at the time the proposal is submitted, with the following information:

- Include a concise statement of reasons supporting the claim of business confidentiality (Subsection 63G-2-309(1)).
- Submit an electronic “redacted” (excluding protected information) copy of the proposal. Copy must clearly be marked “Redacted Version.”

The Claim of Business Confidentiality form may be accessed at:

<http://www.purchasing.utah.gov/contract/documents/confidentialityclaimform.doc>

An entire proposal cannot be identified as “**PROTECTED**”, “**CONFIDENTIAL**” or “**PROPRIETARY**”.

Redacted Copy: If an Offeror submits a proposal that contains information claimed to be confidential or protected, the Offeror **MUST** submit two separate proposals: one redacted version for public release, with all protected business confidential information either blacked-out or removed, clearly marked as "Redacted Version"; and one non-redacted version for evaluation purposes clearly marked as "Protected Business Confidential."

All materials submitted become the property of the State of Utah. Materials may be evaluated by anyone designated by the State as part of the evaluation committee. Materials submitted may be returned only at the State's option.

4 ★ **Instructions To Vendor :**

The issuing procurement unit may not accept a proposal after the time for submission of a proposal has expired.

Certification

I certify that I have read and agree to the terms above.

Vendor Must Also Upload a File:

No

Prerequisite Content:

When submitting a proposal or modification to a proposal electronically, Offerors must allow sufficient time to complete the online forms and upload documents. This RFP will close at the closing time posted on SciQuest. If an Offeror is in the middle of uploading a proposal when the closing time arrives, SciQuest will stop the process and the proposal or modification to a proposal will not be accepted.

It is the Offeror's responsibility to ensure that they have completed all requirements, read and reviewed all documents, submitted all required information, uploaded all required forms, and submitted their proposal prior to the closing time. Even if an Offeror completes all sections, but does not submit their proposal, the State of Utah Division of Purchasing will not be able to receive their proposal and they will be deemed non-responsive.

Be aware that entering information and uploading documents onto SciQuest may take time. Offerors should not wait until the last minute to submit a proposal. Offerors are strongly encouraged to start the submission process early in order to allow sufficient time for completing their proposal. If an offeror is still working on its proposal when the solicitation closes then when the screen refreshes to the next page, it will receive a 500 Session Timed Out Application Error. After reopening the solicitation an offeror will see that the solicitation is closed and it will not be allowed to submit its proposal. As such, it is strongly recommended that proposals be uploaded and completed at least two days before any established deadline in the solicitation so that a proposal will not be received late and be ineligible for award consideration.

5 ★ **Instructions To Vendor :**

Proposals must be submitted electronically, through SciQuest.

Certification

I certify that I have read and agree to the terms above.

Vendor Must Also Upload a File:

No

Prerequisite Content:

When submitting a proposal electronically through SciQuest, please allow sufficient time to complete the online forms and to upload proposal documents. The RFP will end at the deadline. If an Offeror is in the middle of uploading a proposal when the deadline arrives, the system will stop the upload process and the proposal will not be accepted by SciQuest, and the attempted submission will be considered late and ineligible for consideration.

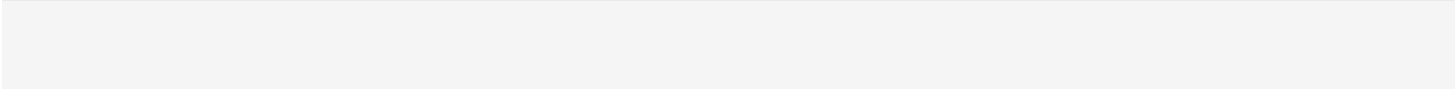

6 ★ **Instructions To Vendor :**

Offeror acknowledges the requirements to submit a proposal through SciQuest.

Certification

I certify that I have read and agree to the terms above.

Vendor Must Also Upload a File:

No

Prerequisite Content:

Offeror acknowledges that after completing their response they must click on the link in the left hand menu bar labeled "Review & Submit", then check the box under the "Certification" heading to certify their response. Then click the blue box labeled "Submit Response" in order to submit their response.

Once the response has been submitted, Vendor will receive a confirmation that the response was successfully submitted. Vendors who fail to submit their response will not have their response reviewed and will be ineligible for further consideration under this solicitation.

Buyer Attachments

CH21-36 RFP- Amended 4-15-2021	CH21-36 RFP- Amended 4-15-2021.docx	../Attachments/CH21-36 RFP- Amended 4-15-2021.docx
Attachment A- NASPO ValuePoint Master Agreement Terms and Conditions	Attachment A- NASPO ValuePoint Master Agreement Terms and Conditions.docx	../Attachments/Attachment A- NASPO ValuePoint Master Agreement Terms and Conditions.docx
Attachment B- Scope of Work	Attachment B- Scope of Work.docx	../Attachments/Attachment B- Scope of Work.docx
Attachment C- Cost Proposal - Amended 4-9-2021.xlsx	Attachment C- Cost Proposal - Amended 4-9-2021.xlsx	../Attachments/Attachment C- Cost Proposal - Amended 4-9-2021.xlsx
Attachment D- RFP Evaluation Scoresheet	Attachment D- RFP Evaluation Scoresheet.xls	../Attachments/Attachment D- RFP Evaluation Scoresheet.xls
Attachment E- Alaska ITP	Attachment E- Alaska ITP.pdf	../Attachments/Attachment E- Alaska ITP.pdf
Attachment F- California ITP	Attachment F- California ITP.pdf	../Attachments/Attachment F- California ITP.pdf
Attachment G- Colorado ITP	Attachment G- Colorado ITP.pdf	../Attachments/Attachment G- Colorado ITP.pdf
Attachment H- Florida ITP	Attachment H- Florida ITP.docx	../Attachments/Attachment H- Florida ITP.docx
Attachment I- Hawaii ITP	Attachment I- Hawaii ITP.pdf	../Attachments/Attachment I- Hawaii ITP.pdf
Attachment J- Idaho ITP	Attachment J- Idaho ITP.docx	../Attachments/Attachment J- Idaho ITP.docx
Attachment K- Louisiana ITP	Attachment K- Louisiana ITP.docx	../Attachments/Attachment K- Louisiana ITP.docx
Attachment L- Maryland ITP	Attachment L- Maryland ITP.pdf	../Attachments/Attachment L- Maryland ITP.pdf
Attachment M- Montana ITP	Attachment M- Montana ITP.docx	../Attachments/Attachment M- Montana ITP.docx
Attachment N- Nevada ITP	Attachment N- Nevada ITP.docx	../Attachments/Attachment N- Nevada ITP.docx
Attachment O- Oregon ITP	Attachment O- Oregon ITP.pdf	../Attachments/Attachment O- Oregon ITP.pdf
Attachment P- Rhode Island ITP	Attachment P- Rhode Island ITP.pdf	../Attachments/Attachment P- Rhode Island ITP.pdf
Attachment Q- South Dakota ITP	Attachment Q- South Dakota ITP.docx	../Attachments/Attachment Q- South Dakota ITP.docx
Attachment R- Texas ITP	Attachment R- Texas ITP.docx	../Attachments/Attachment R- Texas ITP.docx
Attachment S- Utah ITP	Attachment S- Utah ITP.pdf	../Attachments/Attachment S- Utah ITP.pdf
Attachment T- Arizona ITP	Attachment T- Arizona ITP.pdf	../Attachments/Attachment T- Arizona ITP.pdf
Attachment U- Tennessee ITP	Attachment U- Tennessee ITP.pdf	../Attachments/Attachment U- Tennessee ITP.pdf
Attachment V- Ohio ITP	Attachment V- Ohio ITP.docx	../Attachments/Attachment V- Ohio ITP.docx
Attachment W- Delaware ITP	Attachment W- Delaware ITP.pdf	../Attachments/Attachment W- Delaware ITP.pdf
Attachment X- New Mexico ITP	Attachment X- New Mexico ITP.pdf	../Attachments/Attachment X- New Mexico ITP.pdf
Attachment Y- Virginia ITP	Attachment Y- Virginia ITP.pdf	../Attachments/Attachment Y- Virginia ITP.pdf
Attachment Z- Vermont ITP.pdf	Attachment Z- Vermont ITP.pdf	../Attachments/Attachment Z- Vermont ITP.pdf
Attachment EE- Pennsylvania ITP.docx	Attachment EE- Pennsylvania ITP.docx	../Attachments/Attachment EE- Pennsylvania ITP.docx
Claim of Business Confidentiality 12.7.20.pdf	Claim of Business Confidentiality 12.7.20.pdf	../Attachments/Claim of Business Confidentiality 12.7.20.pdf

Changing your Time Zone

Changing Your Time Zone.pptx

../Attachments/Changing Your Time
Zone.pptx

Questions

★ Vendor Response Is Required

Page 1

Group 1: Acceptance of Prerequisites

- 1.1 Offeror acknowledges that it is the offerors responsibility to to upload any and all documents in responding to the solicitation. If the vendors fails to upload a document, uploads an incorrect document, uploads a blank document, or uploads any document incorrectly the State of Utah may not allow the vendor to make changes following the closing of the solicitation. ★
Yes/No
- 1.2 Is Offeror presently or has Offeror ever been debarred, suspended, proposed for debarment, or declared ineligible by any governmental department or agency, whether international, national, state, or local? ★
Yes/No
- 1.3 Offeror acknowledges that they do not have financial ties to individuals or entities on an OFAC sanctions list. ★
Yes/No
- 1.4 If Offeror has any information that is not already provided within its proposal that if known to the State would impact the State's determination on offeror's responsiveness for a contract award (i.e., legal action, recent turn-over in major personnel, loss of a major contract, any alleged violations of federal, state or local regulations, etc.), please mark "yes" to this question and upload such information in the space provided below. Otherwise, please mark "no". Please see UCA 63G-6a-120 & 902 for additional details. ★
Yes/No
- 1.5 Please upload information impacting Offeror's responsiveness here. ★
File Upload
- 1.6 Offeror acknowledges that it must acquire and maintain all applicable federal, state, and local licenses before the contract is entered into. Licenses must be maintained throughout the entire contract period. Persons doing business as an Individual, Association, Partnership, Corporation, or otherwise shall be registered with the Utah State Division of Corporations and Commercial Code. NOTE: Forms and information on registration may be obtained by calling (801) 530-4849 or toll free at 877-526-3994, or by accessing: www.commerce.utah.gov. ★
Yes/No
- 1.7 In the event that an Offeror offers pricing discounts for educational entities that (1) are applicable to this solicitation and (2) result in lower pricing than what is generally offered to other governmental entities, please attach a separate cost proposal labeled "Educational Pricing" to your proposal. This cost proposal for Educational Pricing is to be submitted in addition to the original Cost Proposal Form and will only be available to authorized end users. The Educational Pricing will not be used to evaluate costs. Offeror acknowledges that it has read and understands this question. ★
Yes/No
- 1.8 Does Offeror have an outstanding tax lien in the State of Utah? If yes, Offeror must provide a statement regarding its debarment or suspension. ★
Yes/No
- 1.9 If awarded a State Cooperative Contract Offeror understands that its resulting contract may be terminated for convenience, without cause, if there is no reported spend for any one fiscal year of its contract. ★
Yes/No

Group 2: Vendor Information

- 2.1 Please provide your firm's legal company name. ★
Text (Multi-Line)

- 2.2 Please provide your federal tax identification number. (If the vendor is sole proprietor please do not provide your social security number.) ★
Text (Multi-Line)
- 2.3 Please provide your firm's contact information for this contract, including the name, phone number, and email address of your firm's authorized representative. ★
Text (Multi-Line)
- 2.4 Please provide your ordering address and the remit to address. Please clearly identify each address. ★
Text (Multi-Line)
- 2.5 Please provide your firm's State of Utah Sales Tax ID Number. If you do not have a State of Utah Sales Tax ID Number, please write "N/A". ★
Text (Multi-Line)
- 2.6 Identify your firm's type of business. ★
Dropdown List (Pick One)
Partnership
Government
Sole Proprietor
Limited Liability Company
Not-for-Profit Corporation
For-Profit Corporation
- 2.7 Is Offeror (owners, principles, partners) a retiree currently receiving benefits through the Utah Retirement Systems (URS)? ★
Yes/No
- 2.8 Is Offeror an employee of the State of Utah? If yes, then Offeror must submit an external employment form signed by Offeror's manager at the State of Utah. ★
Yes/No

Group 3: Mandatory Minimums & Technical Criteria Submission

- 3.1 Offeror confirms to this question that they have firm fixed rates. The Offeror must request any increase to the Lead State. The Lead State will review each rate increase submission and the Lead State may, utilize the PPI and CPI to reject, approve, or negotiate rate increases. The awarded Offeror will be required to submit firm rate sheets before contracts are finalized. All prices and rates must be guaranteed for one year. Following the initial one year period, any request for price or rate adjustment must be for an equal guarantee period, and must be made at sixty (60) days prior to the effective date. Requests for price or rate adjustment must include sufficient documentation supporting the request. Any adjustment or amendment to the Master Agreement shall not be effective unless approved by the Lead State. No retroactive adjustments to prices or rates will be allowed. ★
Yes/No
- 3.2 Offeror confirms to this question that if a fuel surcharge will be applied, an express (air) and ground cap cannot exceed 7% for the full term of the Master Agreement. Offeror's must further certify that a fuel surcharge, if any, will be published on its website so that all Authorized Users can confirm the accuracy of invoices. Offeror must further certify that its website shall also provide historical fuel surcharge information. This section is only to be used to certify that the Offeror will not exceed the 7% cap for the full term of the Master Agreement, that it will publish the fuel surcharge, if any, on its website, and will provide historical fuel surcharge information on its website. ★
Yes/No
- 3.3 Offeror confirms to this question that the following regarding the exclusion of listed charges. A) The Offeror shall not propose or apply pick-up charges or weekly service in addition to the contracted rates due to aggregate NASPO ValuePoint volume anticipated. B) The Offeror shall not require a minimum number of packages per trip, per day, per week or per month. ★
Yes/No

- 3.4 Offeror must upload to this question the Offeror's Carrier's Service Guide that would be in effect at the time of Master Agreement contract start date and be in effect for the first year of the Master Agreement with no changes in rates or charges during that time without the prior written approval of the NASPO ValuePoint Contract Administrator. ★
File Upload
- 3.5 Offeror must upload to this question their proposal that responds to the Technical Criteria outlined in Section 3.3 Technical Criteria. ★
File Upload
- 3.6 Offeror understands that Attachment C- Cost Proposal was amended on 4-9-2021 and Offeror must upload the completed attachment named "Attachment C- Cost Proposal - Amended 4-9-2021" to Question 3.7? ★
Yes/No
- 3.7 Offeror must upload to this question their completed Attachment C: Cost Proposal - Amended 4-9-2021. ★
File Upload

Group 4: Vendor's Submission

- 4.1 Offeror/Bidder understands and acknowledges that if Offeror/Bidder accessed the "View as PDF" document available on the Utah Public Procurement Place Business Opportunities website and did not login to Offeror/Bidder's account in the Utah Public Procurement Place system, that Offeror/Bidder may not be viewing the entire the sourcing event and therefore may not be viewing the complete sourcing event requirements. ★
Yes/No
- 4.2 Offeror/Bidder acknowledges that Offeror/Bidder has logged into Utah Public Procurement Place account and viewed the full sourcing event requirements including hyperlinks before submitting a response to a sourcing event. ★
Text (Multi-Line)
- 4.3 Potential Conflicts of Interest. Vendor must identify any conflict, or potential conflict of interest, that might arise during the contract. If no conflicts are identified or expected, write "None" in this section. ★
Text (Multi-Line)
- 4.3 If your firm is requesting parts of its proposal be protected please upload your Claim of Business Confidentiality Form here as well as your redacted proposal. ★
File Upload
- 4.4 Any exceptions to the Terms and Conditions must be uploaded here in the format outlined in Prerequisites: Standard Terms and Conditions (Exceptions and Negotiations). Further, any vendor terms and end user agreements (EULAs) required by your firm must also be uploaded here in the format outlined in Prerequisites: Standard Terms and Conditions (Exceptions and Negotiations). Exceptions and/or additions submitted after the date and time for receipt of proposals will not be considered. If you have no exceptions or additions, upload a document stating "None". ★
File Upload
- 4.5 Offeror affirms that yes that pursuant to the Code of Federal Regulations 2 CFR 200.216 - Prohibition on certain telecommunication and video surveillance services or equipment, that none of the goods (including component parts) or services offered within its proposal are from the entity Huawei Technologies Company or ZTE Corporation (or any subsidiary or affiliate of such entities). ★
Yes/No

4.6 Vendor understands and acknowledges that its response, including all uploaded documents, will not be considered received by the State of Utah unless the Vendor clicks submit. Even if Vendor uploads all required documents and responds to all required questions its response will not be considered if it does not click submit. Offeror acknowledges that after completing the solicitation it must click on the link in the left hand menu bar labeled "Review & Submit", then check the box under the "Certification" heading to certify their bid. Then click the blue box labeled "Submit Response" in order to submit their bid. Once the response has been submitted, Vendor will receive a confirmation that the response was successfully submitted. Vendors who fail to submit their response will not have their response reviewed and will be ineligible for further consideration under this solicitation. ★

Yes/No

Mandy McEwen

mmcewen@timelogisticsinc.com

Toni Stephenson

tstephenson@timelogisticsinc.com

USIQ, Inc.

Progress

Intention Not Declared

Sector Manager

registrations@usiq.com

Award for NASPO Small Package Delivery Services is as follows: 1.FedEx Corporate Services, Inc. for Region 1 – West, Region 2 – Midwest, Region 3 – Southwest, Region 4 – Southeast, and Region 5 - Northeast
2.General Logistics Systems US, Inc. for Region 1 – West
3.United Parcel Service for Region 1 – West, Region 2 – Midwest, Region 3 – Southwest, Region 4 – Southeast, and Region 5 - Northeast

Q&A Board

Subject = NAPSO Small Package Delivery Services (Progressive Medical Services Inc)	Public Thread
<p>Q: Hello, I am contacting you because we have received this via email from our state website. We operate in the state of Washington, and I like to get some clarification as to whether or not the services that are being requested here would be for Washington state. If so, we will be happy to provide you with a bid. Please let us know.</p>	Question added by: Kam Der
<p>A: The State of Washington has signed an Intent to Participate for the NASPO contract. Washington may sign Participating Addendum(s) with awarded vendor(s) that provide services in the State according to their needs and State codes.</p>	Answered by: Cheryl Hess
Subject = Multiple Questions for CH21-36 (United Parcel Service)	Public Thread
<p>Q: Please see revised file attached.</p>	Question added by: Felicia Hall
<p>UPS NASPO Questions 4.12.21.docx - ../Attachments/QABoardAttachments/UPS NASPO Questions</p>	
<p>A: Answers are provided in the Attached Word Doc.</p>	Answered by: Cheryl Hess
<p>UPS NASPO Questions 4.12.21 (1).docx - ../Attachments/QABoardAttachments/UPS NASPO Questions</p>	
Subject = Multiple Questions for CH21-36 (United Parcel Service)	Public Thread
<p>Q: Please see attached file for questions.</p>	Question added by: Felicia Hall
<p>A: On the document uploaded it states, "Proprietary and Confidential" to the vendor. Questions and Answers cannot be confidential and all information to the solicitation is available to all vendors. If offeror would like their Q&A answered, please remove that sentence in and resubmit to the Q&A.</p>	Answered by: Cheryl Hess
Subject = Postal code in WA State offer (DELIVERY PULLMAN LLC)	Public Thread
<p>Q: Regarding WA State offer, my company is available for only this postal codes: 99163, 99164, 99111, 99113, 99179, 99102, 99161. Can I still send an offer? Thanks</p>	Question added by: FRANK CONTRERAS
<p>A: Please review attachment "CH21-36 RFP - Amended 3-24-2021" in Section 1.1 Purpose it states, "While the primary purpose of this solicitation is to select an Offeror(s) who can offer the Products or Services for all members participating in the NASPO ValuePoint Cooperative Purchasing Program, Offerors are permitted to submit a Proposal on more limited geographical areas, but not less than for a single State. Offerors must clearly describe the geographical limits (e.g. by State name) if proposing a geographical area less than that of all member States. However, if an Offeror elects to submit a Proposal for a single State then the Offeror must be willing to supply the entire State and will only be allowed to add states within a Region they have been awarded."</p>	Answered by: Cheryl Hess
Subject = resellar? (FedEx Corporate Services, Inc.)	Public Thread
<p>Q: Please provide a broader explanation about this especially as it relates to the term Reseller. Additional Agreement with NASPO: Upon request by NASPO ValuePoint, awarded Contractor shall enter into a direct contractual relationship with NASPO ValuePoint related to Reseller's obligations to NASPO ValuePoint under the terms of the Master Agreement, the terms of which shall be the same or similar (and not less favorable) than the terms set forth in the Master Agreement.</p>	Question added by: Elaine Heath
<p>A: That term in Attachment A: NASPO ValuePoint Master Agreement Terms and Conditions applies if applicable.</p>	Answered by: Cheryl Hess

Subject = Cost+Proposal (Rapid Response Delivery Inc.)**Public Thread**

Q: How should we fill out the cost and proposal document if none of the scenarios are applicable? We are in Maryland which is listed in the Northeast region. I would prefer to not have to put \$0.00 for all answers.

Question added by: Ryan Conley

4/2/2021 11:01 AM MDT

A: Attachment C- Cost Proposal has been amended to include a scenario for Maryland. The updated attachment is named Attachment C- Cost Proposal - Amended 4-9-2021.

Answered by: Cheryl Hess

4/9/2021 7:57 AM MDT

Q: is the new addendum required if we already finished the other one and don't feel this change will be material to us?

Question added by: Elaine Heath

4/9/2021 8:01 AM MDT

A: Offeror must upload the amended Cost Proposal, Attachment C- Cost Proposal - Amended 4-9-2021.

Answered by: Cheryl Hess

4/9/2021 8:11 AM MDT

Subject = National or Localized Vendors (SEAMESSCO LLC)**Public Thread**

Q: Is this bid looking for localized vendors to call on as needed or national vendors who can deliver locally?

Question added by: Andrew Pack

4/2/2021 10:17 AM MDT

A: Please review the whole Section 1.1 Purpose in attachment CH21-36 RFP. "While the primary purpose of this solicitation is to select an Offeror(s) who can offer the Products or Services for all members participating in the NASPO ValuePoint Cooperative Purchasing Program, Offerors are permitted to submit a Proposal on more limited geographical areas, but not less than for a single State. Offerors must clearly describe the geographical limits (e.g. by State name) if proposing a geographical area less than that of all member States. However, if an Offeror elects to submit a Proposal for a single State then the Offeror must be willing to supply the entire State and will only be allowed to add states within a Region they have been awarded."

Answered by: Cheryl Hess

4/2/2021 10:47 AM MDT

Q: Attachment C has no scenarios for Washington State, which means we would score 0 on the Cost Proposal despite the instructions saying Region 1 - West includes Washington State. May we provide our own scenario since we would be proposing intrastate services for WA? I know the instructions say any alteration could result in the proposal being deemed non-responsive but I'm unsure how to complete the cost proposal without a WA scenario.

Question added by: Andrew Pack

4/2/2021 11:41 AM MDT

A: Attachment C- Cost Proposal has been amended to include a scenario for Washington. The updated attachment is named Attachment C- Cost Proposal - Amended 4-9-2021.

Answered by: Cheryl Hess

4/9/2021 7:57 AM MDT

Subject = Frequency (Singh Group Inc)**Public Thread**

Q: Some scenarios of attachment C are on-call. Are deliveries every day/week? And are these routes to and from the same addresses or will they be from different locations?

Question added by: Adolf Singh

4/1/2021 12:59 PM MDT

A: The scenarios in Attachment C- Cost Proposal are scenarios only to compare prices between Offerors. Deliveries will may be on call, scheduled, any day of the week depending on the need of the eligible users.

Answered by: Cheryl Hess

4/9/2021 7:47 AM MDT

Subject = iowa (Insight Logistics Freight Management LLC)**Public Thread**

Q: Do you have any work in Iowa?

Question added by: Jacquiline Nagila

3/31/2021 5:32 PM MDT

A: Currently the State of Iowa has not signed an Intent to Participate for this NASPO contract. States can choose to sign an Intent to Participate at any stage of the Master Agreement according to their own state's Code.

Answered by: Cheryl Hess

4/2/2021 10:12 AM MDT

Subject = various (FedEx Corporate Services, Inc.)**Public Thread**

Q: various. see attached

Question added by: Elaine Heath

3/29/2021 12:28 PM MDT

A: Please see attachment for answers to Questions.

Answered by: Cheryl Hess

4/2/2021 10:44 AM MDT

NASPO Questions.docx - ../Attachments/QABoardAttachments/NASPO Questions.docx



The State of Utah
Division of Purchasing and General Purposes

In conjunction with



Request for Proposal

Utah Solicitation Number CH21-36

**NASPO ValuePoint Master Agreement for
Small Package Delivery Services**

March 12, 2021

Table of Contents

RFP Administrative Information

Section 1	General Information
Section 2	Solicitation Requirements, Information and Instructions to Offerors
Section 3	Evaluation and Award
Section 4	Administrative and Technical Response Requirements
Attachment A	NASPO ValuePoint Master Agreement Terms and Conditions
Attachment B	Scope of Work
Attachment C	Cost Proposal
Attachment D	RFP Evaluation Scoresheet
Attachments E – EE	Lead State and Additional Participating States' Terms and Conditions

RFP Administrative Information

RFP Title:	Small Package Delivery Services
RFP Project Description: (See Section 1.1)	The State of Utah in conjunction with NASPO ValuePoint, is seeking Contractor(s) to provide Small Package Delivery Services.
RFP Lead: (See Section 1.2)	Cherilyn Hess State Contract Analyst 4315 South 2700 West, Floor 3 Taylorsville, UT 84129-21280 (801) 957-7133 chess@utah.gov
Electronic Submission: (See Section 2.10)	Proposals must be submitted electronically via U3P (the Utah Public Procurement Place) here: https://bids.sciquest.com/apps/Router/PublicEvent?CustomOrg=StateOfUtah Hard copy submissions will not be accepted. From the U3P link type "CH21-36" into the search bar, and click the search icon. The "Small Package Delivery Services" posting will appear.
Deadline To Receive Questions: (See Sections 1.3 and 2.1)	April 12, 2021 at 2:00 PM MT
Question & Answers: (See Section 2.1)	All questions, including those about Terms and Conditions, must be submitted through U3P. Questions must be submitted by the question deadline date
RFP Closing Date: (See Section 1.3)	April 21, 2021
RFP Closing Time: (See Section 1.3)	2:00 PM MT
Initial Term of Contract and Renewals: (See Attachment A, Section 3)	The contract(s) resulting from this RFP will be for FIVE (5) years.
TAKE NOTE OF THE 0.25% NASPO VALUEPOINT ADMINISTRATIVE FEE DETAILED IN SECTION 6 OF THE NASPO VALUEPOINT STANDARD TERMS AND CONDITIONS, WHICH MUST BE INCORPORATED INTO YOUR BASE PRICE. OTHER STATES MAY NEGOTIATE ADDITIONAL ADMINISTRATIVE FEES IN THEIR PARTICIPATING ADDENDA FOLLOWING AWARD OF A MASTER AGREEMENT.	

REQUEST FOR PROPOSAL

Small Package Delivery Services

Solicitation #CH21-36

Section 1: NASPO ValuePoint Solicitation - General Information

1.1. Purpose

The State of Utah, Division of Purchasing and General Services is requesting proposals for Small Package Delivery Services in collaboration with NASPO ValuePoint. The purpose of this Request for Proposal (RFP) is to establish Master Agreements with qualified Offerors to provide Small Package Delivery Services for all Participating States and other eligible entities. The objective of this RFP is to obtain best value, and in some cases achieve more favorable pricing, than is obtainable by an individual state or local government entity because of the collective volume of potential purchases by numerous state and local government entities. The Master Agreement(s) resulting from this procurement may be used by state governments (including departments, agencies, institutions), institutions of higher education, political subdivisions (i.e., colleges, school districts, counties, cities, etc.), the District of Columbia, territories of the United States, and other eligible entities subject to approval by the applicable state's chief procurement official and compliance with local statutory and regulatory provisions. The contract(s) resulting from this RFP will be for FIVE (5) years.

It is anticipated that this RFP may result in Master Agreement awards to multiple contractors, in the Lead State's discretion.

The methodology or formula that will be used to determine the number of contract awards is: Any offeror that receives a combined total score of 65% of all available points will be offered a contract. There are 1600 technical points available and 400 cost points for each region. Thus, any vendor that complies with the requirement of this RFP and achieves a minimum score of 1300 out of 2000 total points (technical + cost) will receive a contract for each region.

This RFP is designed to provide interested Offerors with sufficient information to submit proposals meeting minimum requirements, but is not intended to limit a proposal's content or exclude any relevant or essential data. Offerors are encouraged to expand upon the specifications to add service and value consistent with state requirements.

This RFP will result in awards that will replace the expiring Master Agreement held by the State of Utah and NASPO ValuePoint.

While the primary purpose of this solicitation is to select an Offeror(s) who can offer the Products or Services for all members participating in the NASPO ValuePoint Cooperative Purchasing Program, Offerors are permitted to submit a Proposal on more limited geographical areas, but not less than for a single State. Offerors must clearly

describe the geographical limits (e.g. by State name) if proposing a geographical area less than that of all member States. However, if an Offeror elects to submit a Proposal for a single State then the Offeror must be willing to supply the entire State and will only be allowed to add states within a Region they have been awarded.

The Lead State/Sourcing Team, with the assistance as deemed advisable of the relevant Participating State (or relevant group of Participating States), may evaluate and select an Offeror for award in more limited geographical areas (e.g. a single state) where judged to be in the best interests of the State or States involved.

1.2. Lead State, Solicitation Number and Lead State Contract Administrator

The State of Utah, Division of Purchasing and General Services is the Lead State and issuing office for this document and all subsequent addenda relating to it. The reference number for the transaction is Solicitation #CH21-36. This number must be referred to on all proposals, correspondence, and documentation relating to the RFP.

The Lead State Contract Administrator identified below is the Single Point of Contact during this procurement process. Offerors and interested persons shall direct to the Lead State Contract Administrator all questions concerning the procurement process, technical requirements of this RFP, contractual requirements, requests for brand approval, changes, clarifications, and protests, the award process, and any other questions that may arise related to this solicitation and the resulting Master Agreement. The Lead State Contract Administrator designated by the State of Utah, Division of Purchasing and General Services is:

Cherilyn Hess
 State Contract Analyst
 4315 South 2700 West, Floor 3
 Taylorsville, UT 84129-21280
 (801) 957-7133
 chess@utah.gov

1.3 Schedule of Events

Sourcing Team Note: The NASPO ValuePoint Standard for RFP Publication is a minimum of 40 days

The Lead State will tailor the schedule of events to refer to significant events. Identify specific time zone for Lead State.

Make sure times are included for events where there are legal implications, e.g. receipt of proposals.

Solicitation Release:	March 12, 2021
Pre-Proposal Conference:	N/A
Question Deadline:	April 12, 2021 at 2:00 PM MT
Closing Date and Time:	April 21, 2021 at 2:00 PM MT
Anticipated Award Date:	May 31, 2021

All times are Mountain Time unless indicated otherwise.

1.4. Definitions

The following definitions apply to this solicitation, as well as those definitions set forth in Section 2 of Attachment A, NASPO ValuePoint Master Agreement Terms and Conditions.

Lead State means the State centrally administering any resulting Master Agreement(s). **Offeror** means the company or firm who submits a proposal in response to this Request for Proposal.

Proposer has the same meaning as Offeror.

Proposal means the official written response submitted by an Offeror in response to this Request for Proposal.

Request for Proposal or "RFP" means the entire solicitation document, including all parts, sections, exhibits, attachments, and Addenda.

Sourcing Team means the multistate group of subject matter experts, drafters, and evaluators that work with the Lead State to create, administer, and evaluate this RFP.

1.5. NASPO ValuePoint Background Information

NASPO ValuePoint is the cooperative contracting arm of the National Association of State Procurement Officials (NASPO). NASPO is a non-profit association dedicated to strengthening the procurement community through education, research, and communication. It is made up of the directors of the central purchasing offices in each of the 50 states, the District of Columbia, and the territories of the United States. NASPO ValuePoint facilitates administration of the cooperative group contracting consortium of state chief procurement officials for the benefit of state departments, institutions, agencies, and Political Subdivisions (i.e. colleges, school districts, counties, cities etc.) and other eligible entities (i.e. Non-Profit Organizations, etc.) for all States, the District of Columbia, and territories of the United States. For more information, consult the NASPO website (<http://www.naspo.org>) and the NASPO ValuePoint website (<http://www.naspovaluepoint.org>).

1.6. Participating States

In addition to the Lead State conducting this solicitation, the following Participating States have requested to be named in this RFP as potential users of the resulting Master Agreement: Alaska, Arizona, California, Colorado, Delaware, Florida, Hawaii, Idaho, Louisiana, Maryland, Montana, Nevada, New Mexico, Ohio, Oregon, Pennsylvania, Rhode Island, South Dakota, Tennessee, Texas, Utah, Vermont and Virginia. Other entities may become Participating Entities after award of the Master Agreement. Some States may have included special or unique terms and conditions for their state that will

govern their state Participating Addendum. These terms and conditions are being provided as a courtesy to proposers to indicate which additional terms and conditions may be incorporated into the state Participating Addendum after award of the Master Agreement. The Lead State will not address questions or concerns or negotiate other States' terms and conditions. The Participating States shall negotiate these terms and conditions directly with the supplier. State-specific terms and conditions are included in Attachments E - EE.

1.7. Anticipated Usage

Below contains the historical usage data from the previous contract and anticipated usage from additional states who have indicated an interest in participating. No minimum or maximum level of sales volume is guaranteed or implied.

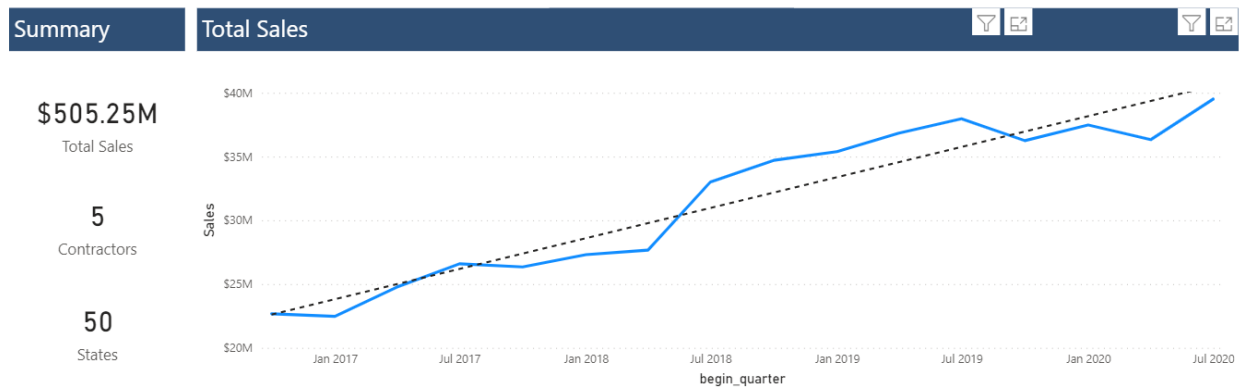

Section 2: Solicitation Requirements, Information and Instructions to Offerors

2.1 RFP Question and Answer Process

All questions, including those about Terms and Conditions, must be submitted through U3P. Question must be submitted by the question deadline date and time shown in Section 1.3 (Schedule of Events). Answers will be given via the U3P site as soon as possible. Please refer back to the RFP Administrative Information page for additional information on how to access U3P.

The Lead State may refuse to answer questions received after the Question/Answer deadline.

The Question and Answer period closes on date and time specified on U3P. All questions must be submitted through U3P during the Question and Answer period. Answers from the State will be posted on U3P. Questions may include notifying the State of any ambiguity, inconsistency, scope exception, excessively restrictive requirement, or other errors in this RFP. Questions are encouraged.

Questions may be answered individually or may be compiled into one document.

Questions may also be answered via an addendum. An answered question or an

addendum may modify the specification or requirements of this RFP. Answered questions and addenda will be posted on U3P. Offerors should periodically check U3P for answered questions and addenda before the closing date. It is the responsibility of the Offerors to submit their proposals as required by this RFP, including any requirements contained in an answered question and/or addenda.

The identity of potential Offerors will not be published with the answers, but the text of questions will be restated, so Offerors are cautioned about including context in questions that may reveal the source of questions.

2.2 RFP Addenda

Formal changes to this RFP including but not limited to contractual terms and procurement requirements shall only be changed via formal written addenda issued by the Lead State.

Offerors are encouraged to review this RFP prior to the deadline to submit a proposal, even if a proposal has been submitted, in case an addendum has been issued by the issuing procurement unit.

Addenda shall be published within a reasonable time prior to the deadline that proposals are due, to allow prospective offerors to consider the addenda in preparing proposals. Publication at least 5 calendar days prior to the deadline that proposals are due shall be deemed a reasonable time. Minor addenda and urgent circumstances may require a shorter period of time. After the due date and time for submitting a proposal to this RFP, at the discretion of issuing procurement unit, addenda to this RFP may be limited to Offerors that have submitted proposals, provided the addenda does not make a substantial change to this RFP.

2.3 Reserved

2.4 Proposal Due Date

Proposals must be received by the posted Closing date and time as described in the Schedule of Events in Section 1.3 of this RFP. Proposals received after the deadline will be late and rejected.

If your time is different from that shown, your profile may be set to a different time zone. Please see the attachment titled "Changing Your Time Zone" in the Buyer Attachments section for directions on how to update your profile. It is your responsibility to make sure you submit your response by the date and time indicated above.

When submitting a proposal or modification to a proposal electronically, Offerors must allow sufficient time to complete the online forms and upload documents. This RFP will close at the closing time posted on U3P. If an Offeror is in the middle of uploading a proposal when the closing time arrives, U3P will stop the process and the proposal or modification to a proposal will not be accepted.

It is the Offeror's responsibility to ensure that they have completed all requirements, read and reviewed all documents, submitted all required information, uploaded all required forms, and submitted their proposal prior to the closing time. Even if an Offeror completes all sections, but does not submit their proposal, the State of Utah Division of Purchasing will not be able to receive their proposal and they will be deemed non-responsive.

Be aware that entering information and uploading documents onto U3P may take time. Offerors should not wait until the last minute to submit a proposal. Offerors are strongly encouraged to start the submission process early in order to allow sufficient time for completing their proposal. If an offeror is still working on its proposal when the solicitation closes then when the screen refreshes to the next page, it will receive a 500 Session Timed Out Application Error. After reopening the solicitation an offeror will see that the solicitation is closed and it will not be allowed to submit its proposal. As such, it is strongly recommended that proposals be uploaded and completed at least two days before any established deadline in the solicitation so that a proposal will not be received late and be ineligible for award consideration.

Offeror acknowledges that after completing their response they must click on the link in the left hand menu bar labeled "Review & Submit", then check the box under the "Certification" heading to certify their response. Then click the blue box labeled "Submit Response" in order to submit their response.

Once the response has been submitted, Vendor will receive a confirmation that the response was successfully submitted. Vendors who fail to submit their response will not have their response reviewed and will be ineligible for further consideration under this solicitation.

2.5 Cancellation of Procurement

This RFP may be canceled at any time prior to award of the Master Agreement(s) if the Lead State determines such action to be in the collective best interests of Participating States.

2.6 Governing Laws and Regulations

This procurement is conducted by the Lead State Division of Purchasing and General Services, in accordance with the State of Utah's Procurement Code. These are available at <https://purchasing.utah.gov/>.

This procurement shall be governed by the regulations and laws of the Lead State. Venue for any administrative or judicial action relating to this procurement, evaluation, and award shall be in the State of Utah. The provisions governing choice of law and venue for issues arising after award and during contract performance are specified in section 35 of the NASPO ValuePoint Master Agreement Terms and Conditions in Attachment A.

2.7 Firm Offers

The awarded Offeror will be required to submit firm rate sheets before contracts are finalized.

All prices and rates must be guaranteed for one year. Following the initial one year period, any request for price or rate adjustment must be for an equal guarantee period, and must be made at sixty (60) days prior to the effective date. Requests for price or rate adjustment must include sufficient documentation supporting the request. Any adjustment or amendment to the Master Agreement shall not be effective unless approved by the Lead State. No retroactive adjustments to prices or rates will be allowed.

The Offeror must request the increase from the Lead State. The Lead State will review each rate increase submission and the Lead State may, utilize the PPI and CPI to reject, approve, or negotiate rate increases.

2.8 Right to Accept All or Portion of Proposal

Unless otherwise specified in the solicitation, the Lead State may accept any item or combination of items as specified in the solicitation or of any proposal unless the Offeror expressly restricts an item or combination of items in its Proposal and conditions its response on receiving all items for which it provided a proposal. In the event that the Offeror so restricts its Proposal, the Lead State may consider the Offeror's restriction and evaluate whether the award on such basis will result in the best value to the Lead State and NASPO ValuePoint members. The Lead State may otherwise determine at its sole discretion that such restriction is non-responsive and renders the Offeror ineligible for further evaluation.

2.9 Proposal Content and Format Requirements

Proposals must be detailed and concise. Each Proposal must be labeled and organized in a manner that is congruent with the requirements and terminology used in this RFP and must include a point-by-point response, structured in form and reference to the RFP, addressing all requirements and the Scope of Work elements.

2.10 Proposal Submission Instructions

By submitting a proposal to this RFP, the Offeror acknowledges and agrees that the requirements, scope of work, and the evaluation process outlined in this RFP are understood, fair, equitable, and are not unduly restrictive. Any exceptions to the content of this RFP must be addressed within the Q&A period. The Offeror further acknowledges that it has read this RFP. More information regarding submittal requirements are provided within the RFP documents.

All costs incurred by an Offeror in the preparation and submission of a proposal, including any costs incurred during interviews, oral presentations, and/or product demonstrations are the responsibility of the Offeror and will not be reimbursed.

The cost proposal will be evaluated independently from the technical proposal, pursuant to Utah Code Annotated (UCA) § 63G-6a Part 7, and as such, **must** be submitted separate from the technical proposal. Separate, for the purposes of this solicitation, means that a separate document is submitted with the labeling instructions provided in this RFP document. Failure to submit cost or pricing data separately may result in your proposal being judged as non-responsive and ineligible for contract award. For electronic submissions, submitting the cost schedule as a separate document is considered separate.

Proposals must be received by the posted due date and time posted on U3P (“deadline”). Proposals received after the deadline will be late and ineligible for consideration.

Proposals shall be submitted electronically through U3P. We will not accept proposals submitted through any other means. For ease in distributing proposals for evaluation we must have electronic copies received through U3P only.

Proposals must be submitted electronically via U3P (the Utah Public Procurement Place) here:

<https://bids.scquest.com/apps/Router/PublicEvent?CustomerOrg=StateOfUtah>

Hard copy submissions will not be accepted.

From the U3P link type “CH21-36” into the search bar, and click the search icon. The “Small Package Delivery Services” posting will appear.

2.11 Required Format

All Proposals must be submitted in the following format. Detailed information on submitting each of these sections is contained in later sections of this RFP.

1. **Executive Summary.** The one or two page executive summary is to briefly describe the Offeror's Proposal. This summary should highlight the major features of the Proposal. It must indicate any requirements that cannot be met by the Offeror. The Lead State should be able to determine the essence of the Proposal by reading the executive summary.
2. **Technical Response.** This section should constitute the Technical response of the proposal and must contain at least the following information:
 - A. A complete narrative of the Offeror's assessment of the work to be performed, the Offeror's ability and approach, and the resources necessary to fulfill the requirements. This should demonstrate the Offeror's understanding of the desired overall performance expectations and clearly indicate any options or alternatives proposed.
 - B. A specific point-by-point response, in the order listed, to each requirement in the Section 3.3, Technical Criteria.
3. **Confidential, Protected or Proprietary Information.** All confidential, protected or proprietary Information must be included in this section of proposal response.

Do not incorporate protected information throughout the Proposal. Rather, provide a reference in the proposal response directing the Lead State to the specific area of this protected Information section.

4. **Cost Proposal.** Cost will be evaluated independently from the technical proposal. Please enumerate all costs in Attachment C, Cost Proposal.

Pursuant to Utah Code Annotated (UCA) § 63G-6a-707(7), the cost proposal will be evaluated independently from the technical proposal; and as such, **must** be submitted separately from the technical proposal. Offerors must not include costs or pricing data in their responses to the Mandatory Minimum Requirements and the Technical Response.

Offeror must upload a completed Attachment C, Cost Proposal, in the Question Section of U3P. If an offeror fails to upload a completed cost proposal form, then its proposal will be considered non-responsive and the proposal will be rejected.

Failure to submit cost or pricing data separately will result in your proposal being judged as non-responsive and ineligible for contract award.

2.12 Ownership or Disposition of Proposals and other Materials submitted

Offerors may be required to submit product samples to assist the chief procurement officer or head of a procurement unit with independent procurement authority in evaluating whether a procurement item meets the specifications and other requirements set forth in the request for proposals. Product samples must be furnished free of charge unless otherwise stated in the request for proposals, and if not destroyed by testing, will upon written request within any deadline stated in the request for proposals, be returned at the Offeror's expense. Samples must be labeled or otherwise identified as specified in the request for proposals by the procurement unit.

2.13 Confidential or Proprietary Information

Offerors may request that part of its proposal be protected by submitting a Claim of Business Confidentiality Form. Form located in the Buyers Attachment Section of U3P.

Pricing may not be classified as confidential or protected and will be considered public information.

Process for Requesting Non-Disclosure: To protect information under a Claim of Business Confidentiality, an Offeror must complete the Claim of Business Confidentiality form, at the time the proposal is submitted, with the following information:

- Include a concise statement of reasons supporting the claim of business confidentiality (Subsection 63G-2-309(1)).
- Submit an electronic “redacted” (excluding protected information) copy of the proposal. Copy must clearly be marked “Redacted Version.”

The Claim of Business Confidentiality form may be accessed at:
<http://www.purchasing.utah.gov/contract/documents/confidentialityclaimform.doc>

An entire proposal cannot be identified as **“PROTECTED”**, **“CONFIDENTIAL”** or **“PROPRIETARY”**.

Redacted Copy: If an Offeror submits a proposal that contains information claimed to be confidential or protected, the Offeror **MUST** submit two separate proposals: one redacted version for public release, with all protected business confidential information either blacked-out or removed, clearly marked as "Redacted Version"; and one non-redacted version for evaluation purposes clearly marked as "Protected Business Confidential."

All materials submitted become the property of the State of Utah. Materials may be evaluated by anyone designated by the State as part of the evaluation committee. Materials submitted may be returned only at the State's option.

2.14 Offeror Exceptions to Terms and Conditions

Offerors should identify or seek to clarify any problems with contract language or any other document contained within this RFP through their written inquiries about the RFP using the process in Section 2.1.

Exceptions and/or additions to Attachment A: NASPO ValuePoint Master Agreement Terms and Conditions are strongly discouraged. However, any requested exceptions and/or additions to terms and conditions must be submitted as an answer to the corresponding question in the Question Section of this solicitation. Exceptions and/or additions submitted after the date and time for receipt of proposals will not be considered. Offerors may not submit requests for exceptions and/or additions by reference to a vendor's website or URL. URLs provided with a proposal may result in that proposal being rejected as non-responsive. Offerors may submit questions during the Question and Answer period regarding the Standard Terms and Conditions.

The Lead State (and its sourcing team) may refuse to negotiate exceptions and/or additions that are determined to be excessive; that are inconsistent with similar contracts of the procurement unit; to warranties, insurance, or indemnification provisions that are necessary to protect the procurement unit after consultation with the applicable legal counsel; where the solicitation specifically prohibits exceptions and/or additions; or that are not in the best interest NASPO and participating states.

In a multiple award, the State reserves the right to negotiate exceptions and/or additions to terms and conditions in a manner resulting in expeditious resolutions. This process may include beginning negotiations with the Offeror having the least amount of exceptions and/or additions and concluding with the Offeror submitting the greatest number of exceptions and/or additions. Contracts may be executed and become effective as negotiations are completed.

For any proposed change(s), Offeror must provide the NASPO's Attachment A: Terms and Conditions for this solicitation in Microsoft Word format with redline edits. Additional terms or documents must be submitted in separate Microsoft Word documents. Offeror must also provide the name, contact information, and access to the person(s) that will be directly involved in legal negotiations.

Any mandatory required acceptance of an Offeror's terms and conditions may result in the proposal being determined to be non-responsive.

An award resulting from this RFP is subject to successful contract terms and conditions negotiation (if required). The Lead State may reject a proposal if the offeror who submitted the proposal fails to sign a contract within 90 days after the contract award.

2.15 Certification of Non-Debarment

The Offeror certifies that neither the Offeror nor its principals are presently debarred, suspended, proposed for debarment, declared ineligible, or voluntarily excluded from participation in this transaction (Master Agreement) by any governmental department or agency. If the Offeror cannot certify this statement, attach a written explanation for review by the Lead State.

2.16 Interviews and Presentations

If it is determined to be in the best interest of the Conducting Procurement Unit, interviews and presentations may be held at the option of the State.

The State shall establish a date and time for the interviews or presentations and shall notify eligible Offerors of the procedures. Offerors invited to interviews or presentations shall be limited to those Offerors meeting the minimum requirements and minimum technical score threshold specified in the RFP. Representations made by an Offeror during interviews or presentations shall become an addendum to the Offeror's proposal and shall be documented. Representations must be consistent with the Offeror's original proposal and may only be used for purposes of clarifying or filling in gaps in the Offeror's proposal. Interviews and presentations will be at the Offeror's expense.

Section 3: Evaluation and Award

3.1 Reserved

3.2 Mandatory Minimum Requirements

The following mandatory minimum requirements must be met in order for a proposal to be considered responsive:

1. Offeror confirms in the Question Section of U3P that they have firm fixed rates. The Offeror must request any increase to the Lead State. The Lead State will review each rate increase submission and the Lead State may, utilize the PPI and CPI to reject, approve, or negotiate rate increases. The awarded Offeror will be required to submit firm rate sheets before contracts are finalized. All prices and rates must be guaranteed for one year. Following the initial one year period, any request for price or rate adjustment must be for an equal guarantee period, and must be made at sixty (60) days prior to the effective date. Requests for price or rate adjustment must include sufficient documentation supporting the request. Any adjustment or amendment to the Master Agreement shall not be effective unless approved by the Lead State. No retroactive adjustments to prices or rates will be allowed.
2. Offeror confirms in the Question Section of U3P that if a fuel surcharge will be applied, an express (air) and ground cap cannot exceed 7% for the full term of the Master Agreement. Offeror's must further certify that a fuel surcharge, if any, will be published on its website so that all Authorized Users can confirm the accuracy of invoices. Offeror must further certify that its website shall also provide historical fuel surcharge information. This section is only to be used to certify that the Offeror will not exceed the 7% cap for the full term of the Master Agreement, that it will publish the fuel surcharge, if any, on its website, and will provide historical fuel surcharge information on its website.
3. Offeror confirms in the Question Section of U3P the following regarding the exclusion of listed charges. A) The Offeror shall not propose or apply pick-up charges or weekly service in addition to the contracted rates due to aggregate NASPO ValuePoint volume anticipated. B) The Offeror shall not require a minimum number of packages per trip, per day, per week or per month.
4. Offeror must upload in the Question Section of U3P portal the Offeror's Carrier's Service Guide that would be in effect at the time of Master Agreement contract start date and be in effect for the first year of the Master Agreement with no changes in rates or charges during that time without the prior written approval of the NASPO ValuePoint Contract Administrator.
5. Offeror must upload in the Question Section of U3P their proposal that responds to the Technical Criteria outlined in Section 3.3 Technical Criteria.
6. Offeror must upload in the Question Section of U3P their completed Attachment C: Cost Proposal.

If it is determined that a proposal does not meet these requirements, at any time during the solicitation process, the proposal will be deemed non-responsive and disqualified from further consideration.

3.3 Technical Criteria

To determine which proposal provides the best value, the evaluation committee will

evaluate each responsive and responsible proposal that has not been disqualified or rejected using the subjective criteria listed below:

1. Qualification of Carriers – 270 Points Possible

- a. Offeror must attach a true, correct and complete copy of its operating permit (nationally or states offeror is submitting to) in their Proposal. The Authorized User and Carrier agree that each and every shipment tendered to Carrier under the Contract is a tender to the Carrier.
- b. Offeror shall provide represent and warrant that it is authorized pursuant to permits issued to transport shipments, as described in this Master Agreement in interstate and foreign commerce from, to, or between all points and places in the United States and international points and to lawfully furnish to the Authorized User all related services provided for herein.
- c. The Offeror shall certify that it agrees to immediately notify the Authorized User of any threatened or actual suspension or revocation of any such permit or operating authority during the course of any awarded price agreement.
- d. The Offeror shall represent and warrant that it has not, and during the term of this Master Agreement, will not request, pursuant to 49 U.S. C. Section 14501 (c) (B) (ii), to be subject to any law, regulation or provision that purports to create any right or obligation that is inconsistent with the provision of this Master Agreement.
- e. The Offeror must provide its calendar or fiscal year 2019 Operating Ratio (operating expenses divided by operating revenues multiplied by 100 give the percentage of the operating revenues which are required to pay the operating expenses, this being the operating ratio).
- f. The Offeror must provide its Shipment Claims Ratio for calendar or fiscal year 2019. The ratio shall be the ratio of claims for shipment loss or damage to total shipments for both express small package air and expedited ground service shipments.
- g. The Offeror shall provide the following information specific to the Offeror's company:
 1. Company's full legal name;
 2. Primary business address;
 3. Description of company ownership structure;
 4. Number of employees;
 5. Website address; and
 6. Sales contact information.

2. Ability to Meet the Scope of Work – 270 Points Possible

- a. Offeror to respond to the seven points listed in Attachment B: Scope and describe in detail their ability to meet or execute those points to this technical criteria.

3. Prior Experience – 195 Points Possible

- a. Offeror must submit a list of states where they have done business in the last twelve (12) months along with Account point of contact information for each state/area. This includes their name, phone number and email. The State reserves the right to reach out to any state and collect past performance information that can be used to evaluate past performance.
- b. Offeror shall demonstrate an established, successful track record of past performance in duties and responsibilities related to domestic and if applicable international transportation services specified herein. This can be established by providing a copy of reports such as a Carrier annual report, report to Surface Transportation Board, or balance sheets and income and expense statements.
- c. Offeror shall provide documentation of on time and late delivery performance for express small package air and small parcel ground services for the past twelve (12) months.

4. Dispute Resolution – 195 Points Possible

- a. Package Security
 - i. Describe the procedures in place to ensure packages are secure and tracked during transport. Explain a situation where the package being shipped needs special handling due to the contents being shipped. How did the Offerors' policies, driver training, customer service all assist in that process? If there were challenges explain those too.
 - ii. Offeror shall demonstrate how sensitive packages are kept secure and are delivered properly and timely.
- b. Security Protocols
 - i. Offeror shall provide all security protocols followed and how they shall conform to security protocols by State Agencies.
 - ii. Describe the security protocols in place if a package or a driver runs in to a Security issue, i.e., the package is an issue or any other scenario.
- c. Offeror to describe how they handle issues and disputes.
 - i. Offeror shall provide a 24/7 customer service center and escalation contacts for States. Offeror shall detail how users would dispute and/or submit a complaint to customer service.
 - ii. Offeror to describe how they handle issues and disputes with customers including billing issues.

5. Handling State Emergencies – 195 Points Possible

- a. Describe how the Offeror's company has responded to any state that had a specific emergency or if an emergency has affected the nation. Include an example that includes but not limited to when the Offeror's company needed to adjust operations to accommodate a need, how communications with the customer worked, some challenges that were worked through and how well the outcome was for the Offeror and the end user.
- b. Offeror shall agree to provide next day pick up/shipping on any pick ups or deliveries on packages deemed critically necessary to meet the needs and demands of declared State emergencies.

- c. Offeror shall agree to provide a dedicated point of contact to assist State emergency contact persons in determining the best shipping method and any additional shipping requirements needed for being shipped.
- d. Offeror shall work alongside State emergency contact persons to provide any needed reports for Federal Emergency Management Agency reporting requirements.

6. Data Security – 125 Points Possible

- a. Offeror shall describe in detail what measures are taken to protect sensitive customer information.
- b. Demonstrate the data security policies in place if data was breached. How is the customer notified and if the customer finds a breach, how do they notify the Offeror?
- c. 'Click-through' or Terms of Use Agreement
If access to the Offerors' system or partnering system requires users to agree to Terms of Use or similar 'Click-Through' style agreements, copies of those agreements must be included in the RFP response.

7. Drop Boxes and Shipping Supplies – 100 Points Possible

- a. Offerors must agree to place package collection receptacles in convenient locations within Participating States and describe other centralized package collection procedures available. Collection receptacles must be of sufficient size to contain 8 ½" x 11" sheets of paper, without folding, up to the weight limit for various categories. The Offeror shall provide express pack boxes and express tubes to Participating States at no cost. The Offeror shall provide requested materials and supplies within 48 hours of request, except for pre-printed shipping forms. Pre-printed shipping forms are the Offeror's shipping forms pre-printed with an Authorized User's address and billing information. Note: Any pre-printed Terms and Conditions on any Offeror forms, which are inconsistent with the Terms and Conditions of the Master Agreement and any Participating Addendum are rejected and do not modify, change or replace the Terms and Conditions of this Master Agreement or subsequent Participating Addenda.
- b. Offeror must agree to place receptacles in convenient locations within Participating States and describe other centralized collection procedures available. Containers must be of sufficient size to contain 8 ½" x 11" sheets of paper, without folding, up to the weight limit for various categories. The Carrier shall provide express pack boxes and express tubes to Participating States at no cost. Carrier shall provide requested materials and supplies within 48 hours of request, except for pre-printed shipping forms. Pre-printed shipping forms are Carrier's shipping forms pre-printed with users address and billing information. Note: Any pre-printed terms and conditions on any Carrier forms, which are inconsistent with the terms and conditions of the Master Agreement and any Participating Addendum are rejected and do not modify, change or replace the terms and conditions of this Master Agreement or subsequent Participating Addenda.
- c. The Offeror shall, at no additional charge, provide Authorized Users with label printers, labels, etc. or the ability to print labels that are required to prepare

articles for shipment. The Offeror shall describe its program for providing such printers, including its lease terms and conditions or the ability to print labels.

- d. Offeror shall provide online services ordering capability as well as online printing of shipment documentation and labels. Online ordering and printing services shall be available to Authorized Users via access through the Internet and be capable of being accessed utilizing standard Internet Web Browsers. Offeror shall describe its online ordering and shipment documentation printing services, including a description of the security and privacy protection features that will be applicable to online services. The system shall accommodate a reference field for internal tracking numbers for invoice payment. The reference field shall accommodate up to 20 characters. Explain the process for modification of the online system if the Authorized user needs a change to the online order system. Is the system customizable?

8. Marketing Plan – 100 Points Possible

- a. Offerors shall provide a marketing plan explaining how an Offeror will market its relationship with NASPO ValuePoint, the Lead State, and Participating Entities in future marketing material and campaigns. The NASPO ValuePoint Master Agreement Terms and Conditions include program provisions governing participation in the cooperative, reporting and payment of administrative fees, and marketing/education relating to the NASPO ValuePoint cooperative procurement program. In this regard, the Offeror should address the following:
 - b. Briefly describe how the Offeror intends to promote the use of the Master Agreement.
 - c. Knowing that state procurement officials (CPO) must permit use of the Master Agreement in their state, how will you integrate the CPO's permission into your plan for promoting the agreement?
 - d. Public entities are sensitive to "scope" issues, whether performance is within the intended scope of the solicitation as awarded. In the context of the Offeror's method of promoting Master Agreements of this nature, how would the Offeror clarify any questions regarding the scope of the Master Agreement with respect to any potential order?
 - e. How will the Offeror's company manage due dates for administrative fee payments and usage reports?
 - f. Offeror to describe report customizations they can provide.
 - g. Through its Cooperative Development Coordinators and Education & Outreach team, NASPO ValuePoint assists Lead States by engaging vendors in strategies aimed at promoting master agreements. The Offeror should describe the opportunities and/or challenges you as an Offeror see in working with NASPO ValuePoint staff in this way.

9. Green Transportation Plan – 75 Points Possible

- a. The Offeror shall outline its green transportation plan.
- b. Offeror must describe what green transportation plans the Offeror has in place and any future plans.
- c. Offeror shall describe in detail how it will meet the scope of work provided below:
 - i. The scope of this RFP includes US domestic and international door-to-door express small package air services covering interstate, intrastate and international service. This RFP will cover both inbound and outbound shipments. Outbound shipments will move prepaid and inbound shipments will ship collect for each Participating State. Domestic expedited ground parcel shipments will also ship outbound prepaid and inbound collect by each participating state. Domestic shipment service includes the contiguous 48 states, Alaska, Hawaii, American Virgin Islands, and Puerto Rico, for both commercial and residential shipments.
 - ii. Offerors desiring to offer intrastate ground or other related services for a specific state only must clearly designate each rate table and schedule of rates and charges accordingly. Those rates and service must apply to all points and places within the designated state and Offeror must document its ability to provide statewide pick-up and delivery service in its Proposal.
 - iii. The scope of work for this RFP only includes small package delivery and does not include courier services, LTL freight or freight.

10. Point of Contact – 75 Points Possible

- a. General Point of Contact: Carrier must provide the name of the person who will work with the NASPO ValuePoint Contract Administrator during the term of the Master Agreement. This person must be authorized to coordinate with other Offeror representatives in each Participating State to ensure an efficient implementation of the Master Price Agreement. These representatives will be able to quickly assign agency account numbers and insure the NASPO ValuePoint contract rates are attached accordingly. Offeror must describe the process required to obtain agency account numbers and Offeror personnel assigned must have full knowledge of the NASPO ValuePoint Master Agreement. Offeror shall provide to each Participating State the name, address and telephone number of such person and shall keep this information current at all times. Should contact with such person require long distance calls, Offeror will provide a toll free number to be used during normal business hours.
- b. Problem Resolution Contact: Offeror shall be available to Authorized Users via local or toll free phone number for normal problem resolution including but not limited to problems of shipment pickup, delivery, claims handling or incorrect billing. Requests for on-site problem resolution shall be on an as needed basis per request by the Authorized User. Offeror will not charge any travel costs to the Authorized User if on-site resolution is requested. Offeror shall respond to the on-site problem resolution within 24 hours of Authorized User's request. Offeror to describe the escalation process.

- c. Offerors shall have trained personnel that can research and maintain a quality assurance program through tracking and monitoring deliveries. Offerors must describe its ongoing quality control program along with how often staff is trained in protocols for quality control.
- d. Offerors describe security measures in place such as having uniformed personnel, with carrier identification, vehicles that have the Carrier's name on the side and can follow security procedures required by Authorized Users. Describe how Authorized Users can confirm the identity of Carrier staff and escalation procedures.
- e. Describe the training and pick up procedures for drivers, processing staff, and delivery staff. At a minimum, Offeror must have trained personnel that can research and maintain a quality assurance program through tracking and monitoring deliveries.

3.4 Evaluation Process

All proposals in response to this RFP will be evaluated in a manner consistent with the Utah Procurement Code, Administrative Rules, policies and the evaluation criteria in this RFP. Offerors bear sole responsibility for the items included or not included within the proposal submitted by the Offeror. Each area of the evaluation criteria must be addressed in detail in the proposal.

Stage 1: Initial Review

In the initial phase of the evaluation process, the conducting procurement unit will review all proposals timely received. Non-responsive proposals not conforming to RFP requirements or unable to meet the mandatory minimum requirements will be eliminated from further consideration.

Stage 2: Technical Proposal Evaluation

Responsive proposals will then be evaluated by an evaluation committee appointed by the conducting procurement unit against the proposal evaluation criteria noted in this RFP. Proposals will be evaluated against the evaluation criteria as follows:

Evaluation Criteria	Possible Points
1. Qualification of Carriers	270
2. Ability to Meet Scope of Work	270
3. Prior Experience	195
4. Dispute Resolution	195
5. Handling State Emergencies	195
6. Data Security	125
7. Drop Boxes and Shipping Supplies	100
8. Marketing Plan	100
9. Green Transportation Plan	75
10. Point of Contact	75
Total Technical Criteria	1600

<i>Threshold to Move to Cost</i>	<i>1040</i>
----------------------------------	-------------

Offerors that achieve minimum score threshold of 1040 will proceed to the Final Stage: Cost Proposal Evaluation. Offerors with a score of less than the minimum required technical points will be deemed non-responsive and ineligible for further consideration. The evaluation score sheet has been attached to this RFP. The attached evaluation score sheet states the relative weight that will be given to each evaluation criteria.

The evaluation committee, for this RFP, will tally the final scores for criteria other than cost to arrive at a consensus score by the following method: an average of the individual scores.

Final Stage: Cost Proposal Evaluation

Offerors successful in the technical evaluation will advance to the Final Stage: Cost Proposal Evaluation. The Offeror with the lowest total cost per scenario will receive the maximum points of 80 for each scenario. The maximum points for each region is 400 points. Points assigned to each Offeror's cost proposal will be based on the lowest proposal price for each scenario that an Offeror submits a Cost Proposal for within that region.

The points assigned to each Offeror's cost proposal will be based on the lowest proposal price of each scenario. The Offeror with the lowest Proposed Price will receive 100% of the price points for that scenario. All other Offerors will receive a portion of the total cost points based on what percentage higher their Proposed Price is than the Lowest Proposed Price. An Offeror whose Proposed Price is more than double (200%) the Lowest Proposed Price will receive no points. The formula to compute the points is: $\text{Cost Points} \times (2 - \frac{\text{Proposed Price}}{\text{Lowest Proposed Price}})$.

3.5 Notice of Intent to Award

After a final selection(s) is made, the Lead State will issue an intent-to-award announcement on its electronic procurement system. Proposal files are public records and available for review at the offices of the Lead State by appointment.

3.6 Protest

Offerors are directed to Utah Code Part 16 and Utah Administrative Code Rule R16 available at https://le.utah.gov/xcode/Title63G/Chapter6A/63G-6a-P16.html?v=C63G-6a-P16_2016032820160328 and <https://rules.utah.gov/publicat/code/r033/r033-016.htm> for available protest processes.

3.7 Post Award Formalization of the Master Agreement

The Lead State reserves the right during contract negotiation of the Master Agreement to adjust terms and conditions that would not (in the Lead State's judgment) have a material effect on price, schedule, scope of work, or risk to the Lead State and Participating States, with materiality defined in terms of the effect on the evaluation and award. The Lead State reserves the right to accept contract or pricing changes that are

more favorable to the Lead State.

If no Master Agreement is reached with the apparent awardee(s), the Lead State may negotiate with other Offerors or elect to make no award under this RFP.

Section 4: Administrative and Technical Response Requirements

4.1 Insurance

To be eligible for award, the Offeror agrees to acquire insurance from an insurance carrier or carriers licensed to conduct business in each Participating Entity's state at the prescribed levels set forth in Section 21 of the NASPO ValuePoint Master Agreement Terms and Conditions. Describe your insurance or plans to obtain insurance satisfying the requirements in Section 21.

4.2. NASPO ValuePoint Requirements

To be eligible for award, the Offeror agrees to comply with Sections 6 ((Administrative fees), Section 7 (NASPO ValuePoint Summary and Detailed Usage Reports), and Section 8 (NASPO ValuePoint Cooperative Program Marketing, Training, and Performance Reviews) as specified in the NASPO ValuePoint Master Agreement Terms and Conditions.

Offeror shall identify the person responsible for providing the mandatory usage reports. This information must be kept current during the contract period. Contractor will be required to provide reporting contact within 15 days of Master Agreement execution.

Additional Agreement with NASPO: Upon request by NASPO ValuePoint, awarded Contractor shall enter into a direct contractual relationship with NASPO ValuePoint related to Reseller's obligations to NASPO ValuePoint under the terms of the Master Agreement, the terms of which shall be the same or similar (and not less favorable) than the terms set forth in the Master Agreement.

4.4 Participating State Terms and Conditions

For informational purposes only, some Participating State specific Terms and Conditions are provided in Attachments E – EE (Lead State and Additional Participating States' Terms and Conditions) to this solicitation and will be negotiated with other Participating States after award of the Master Agreement. Each State reserves the right to negotiate additional terms and conditions in its Participating Addendums. Offeror shall submit a statement that they understand they may be required to negotiate these additional terms and conditions when executing a Participating Addendum.

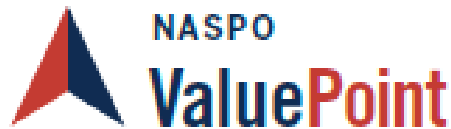

ATTACHMENT A

NASPO VALUEPOINT MASTER AGREEMENT TERMS AND CONDITIONS

I. Definitions

- 1.1 **Acceptance** means acceptance of goods and services as set forth in Section IX of this Master Agreement.
- 1.2 **Contractor** means a party to this Master Agreement, whether a person or entity, that delivers goods or performs services under the terms set forth in this Master Agreement.
- 1.3 **Embedded Software** means one or more software applications which permanently reside on a computing device.
- 1.4 **Intellectual Property** means any and all patents, copyrights, service marks, trademarks, trade secrets, trade names, patentable inventions, or other similar proprietary rights, in tangible or intangible form, and all rights, title, and interest therein.
- 1.5 **Lead State** means the State centrally administering any resulting Master Agreement(s) who is a party to this Master Agreement.
- 1.6 **Master Agreement** means the underlying agreement executed by and between the Lead State, acting in cooperation with NASPO ValuePoint, and the Contractor, as now or hereafter amended.
- 1.7 **NASPO ValuePoint** is a division of the National Association of State Procurement Officials ("NASPO"), a 501(c)(3) limited liability company. NASPO ValuePoint facilitates administration of the NASPO cooperative group contracting consortium of state chief procurement officials for the benefit of state departments, institutions, agencies, and political subdivisions and other eligible entities (i.e., colleges, school districts, counties, cities, some nonprofit organizations, etc.) for all states, the District of Columbia, and territories of the United States. NASPO ValuePoint is identified in the Master Agreement as the recipient of reports and may perform contract administration functions relating to collecting and receiving reports, as well as other contract administration functions as assigned by the Lead State.
- 1.8 **Order** or **Purchase Order** means any purchase order, sales order, contract or other document used by a Purchasing Entity to order the Products.

- 1.9 Participating Addendum** means a bilateral agreement executed by a Contractor and a Participating Entity incorporating this Master Agreement and any additional Participating Entity-specific language or other requirements (e.g., ordering procedures specific to the Participating Entity, entity-specific terms and conditions, etc.).
- 1.10 Participating Entity** means a state (as well as the District of Columbia and US territories), city, county, district, other political subdivision of a State, or a nonprofit organization under the laws of some states properly authorized to enter into a Participating Addendum, that has executed a Participating Addendum.
- 1.11 Participating State** means a state that has executed a Participating Addendum or has indicated an intent to execute a Participating Addendum.
- 1.12 Product or Products and Services** means any equipment, software (including embedded software), documentation, service, or other deliverable supplied or created by the Contractor pursuant to this Master Agreement. The term Product includes goods and services.
- 1.13 Purchasing Entity** means a state (as well as the District of Columbia and US territories), city, county, district, other political subdivision of a State, or a nonprofit organization under the laws of some states if authorized by a Participating Addendum, that issues a Purchase Order against the Master Agreement and becomes financially committed to the purchase.

II. Term of Master Agreement

- 2.1 Initial Term.** The initial term of this Master Agreement is for five (5) years.

The Master Agreement may be extended for a reasonable period of time, not to exceed 120 days, if in the judgment of the Lead State a follow-on, competitive procurement will be unavoidably delayed (despite good faith efforts) beyond the planned date of execution of the follow-on master agreement. This subsection shall not be deemed to limit the authority of a Lead State under its state law otherwise to negotiate contract extensions.

- 2.2 Amendment Limitations.** The terms of this Master Agreement will not be waived, altered, modified, supplemented, or amended in any manner whatsoever without prior written agreement of the Lead State and Contractor.

- 2.3 Amendment Term.** The term of the Master Agreement may be amended past the initial term and stated renewal periods for a reasonable period if in the judgment of the Lead State a follow-on competitive procurement will be unavoidably delayed (despite good faith efforts) beyond the planned date of execution of the follow-on master agreement. This subsection will not be deemed to limit the authority of a Lead State under its state law to otherwise negotiate contract extensions.

III. Order of Precedence

- 3.1 Order.** Any Order placed under this Master Agreement will consist of the following documents:
- 3.1.1** A Participating Entity's Participating Addendum ("PA");
 - 3.1.2** NASPO ValuePoint Master Agreement, including all attachments thereto;
 - 3.1.3** A Purchase Order or Scope of Work/Specifications issued against the Master Agreement;
 - 3.1.4** The Solicitation or, if separately executed after award, the Lead State's bilateral agreement that integrates applicable provisions;
 - 3.1.5** Contractor's response to the Solicitation, as revised (if permitted) and accepted by the Lead State.
- 3.2 Conflict.** These documents will be read to be consistent and complementary. Any conflict among these documents will be resolved by giving priority to these documents in the order listed above. Contractor terms and conditions that apply to this Master Agreement are only those that are expressly accepted by the Lead State and must be in writing and attached to this Master Agreement as an Exhibit or Attachment.
- 3.3 Participating Addenda.** Participating Addenda will not be construed to diminish, modify, or otherwise derogate any provisions in this Master Agreement between the Lead State and Contractor. Participating Addenda will not include a term of agreement that exceeds the term of the Master Agreement.

IV. Participants and Scope

- 4.1 Requirement for a Participating Addendum.** Contractor may not deliver Products under this Master Agreement until a Participating Addendum acceptable to the Participating Entity and Contractor is executed.
- 4.2 Applicability of Master Agreement.** NASPO ValuePoint Master Agreement Terms and Conditions are applicable to any Order by a Participating Entity (and other Purchasing Entities covered by their Participating Addendum), except to the extent altered, modified, supplemented or amended by a Participating Addendum, subject to Section III. For the purposes of illustration and not limitation, this authority may apply to unique delivery and invoicing requirements, confidentiality requirements, defaults on Orders, governing law and venue relating to Orders by a Participating Entity, indemnification, and insurance requirements. Statutory or constitutional requirements relating to availability of funds may require specific language in some Participating Addenda in order to comply with applicable law. The expectation is that these alterations, modifications, supplements, or amendments will be addressed in the Participating Addendum or, with the consent of the Purchasing Entity and Contractor, may be included in the ordering

document (e.g., purchase order or contract) used by the Purchasing Entity to place the Order.

- 4.3 Authorized Use.** Use of specific NASPO ValuePoint Master Agreements by state agencies, political subdivisions and other Participating Entities is subject to applicable state law and the approval of the respective State Chief Procurement Official. Issues of interpretation and eligibility for participation are solely within the authority of the respective State Chief Procurement Official.
- 4.4 Obligated Entities.** Obligations under this Master Agreement are limited to those Participating Entities who have signed a Participating Addendum and Purchasing Entities within the scope of those Participating Addenda. States or other entities permitted to participate may use an informal competitive process to determine which Master Agreements to participate in through execution of a Participating Addendum. Participating Entities incur no financial obligations on behalf of other Purchasing Entities.
- 4.5 Notice of Participating Addendum.** Contractor shall email a fully executed PDF copy of each Participating Addendum to pa@naspovaluepoint.org to support documentation of participation and posting in appropriate databases.
- 4.6 Eligibility for a Participating Addendum.** Eligible entities who are not states may under some circumstances sign their own Participating Addendum, subject to the consent of the Chief Procurement Official of the state where the entity is located. Coordinate requests for such participation through NASPO ValuePoint. Any permission to participate through execution of a Participating Addendum is not a determination that procurement authority exists; the entity must ensure that they have the requisite procurement authority to execute a Participating Addendum.
- 4.7 Prohibition on Resale.** Subject to any specific conditions included in the solicitation or Contractor's proposal as accepted by the Lead State, or as explicitly permitted in a Participating Addendum, Purchasing Entities may not resell Products purchased under this Master Agreement. Absent any such condition or explicit permission, this limitation does not prohibit: payments by employees of a Purchasing Entity for Products; sales of Products to the general public as surplus property; and fees associated with inventory transactions with other governmental or nonprofit entities and consistent with a Purchasing Entity's laws and regulations. Any sale or transfer permitted by this subsection must be consistent with license rights granted for use of intellectual property.
- 4.8 Individual Customers.** Except as may otherwise be agreed to by the Purchasing Entity and Contractor, each Purchasing Entity shall follow the terms and conditions of the Master Agreement and applicable Participating Addendum and will have the same rights and responsibilities for their purchases as the Lead State has in the Master Agreement and as the Participating Entity has in the Participating Addendum, including but

not limited to any indemnity or right to recover any costs as such right is defined in the Master Agreement and applicable Participating Addendum for their purchases. Each Purchasing Entity will be responsible for its own charges, fees, and liabilities. The Contractor will apply the charges and invoice each Purchasing Entity individually.

- 4.9 Release of Information.** Throughout the duration of this Master Agreement, Contractor must secure from the Lead State prior approval for the release of information that pertains to the potential work or activities covered by the Master Agreement. This limitation does not preclude publication about the award of the Master Agreement or marketing activities consistent with any proposed and accepted marketing plan.
- 4.10 No Representations.** The Contractor shall not make any representations of NASPO ValuePoint, the Lead State, any Participating Entity, or any Purchasing Entity's opinion or position as to the quality or effectiveness of the services that are the subject of this Master Agreement without prior written consent.

V. NASPO ValuePoint Provisions

- 5.1 Applicability.** NASPO ValuePoint is not a party to the Master Agreement. The terms set forth in Section V are for the benefit of NASPO ValuePoint as a third-party beneficiary of this Master Agreement.

5.2 Administrative Fees

5.2.1 NASPO ValuePoint Fee. Contractor shall pay to NASPO ValuePoint, or its assignee, a NASPO ValuePoint Administrative Fee of one-quarter of one percent (0.25% or 0.0025) no later than sixty (60) days following the end of each calendar quarter. The NASPO ValuePoint Administrative Fee must be submitted quarterly and is based on all sales of products and services under the Master Agreement (less any charges for taxes or shipping). The NASPO ValuePoint Administrative Fee is not negotiable. This fee is to be included as part of the pricing submitted with a vendor's response to the Lead State's solicitation.

5.2.2 State Imposed Fees. Some states may require an additional fee be paid directly to the state on purchases made by Purchasing Entities within that state. For all such requests, the fee rate or amount, payment method and schedule for such reports and payments will be incorporated into the applicable Participating Addendum. Unless agreed to in writing by the state, Contractor may not adjust the Master Agreement pricing to include the state fee for purchases made by Purchasing Entities within the jurisdiction of the state. No such agreement will affect the NASPO ValuePoint Administrative Fee percentage or the prices paid by Purchasing Entities outside the jurisdiction of the state requesting the additional fee.

5.3 NASPO ValuePoint Summary and Detailed Usage Reports

- 5.3.1 Summary Sales Data.** The Contractor shall submit quarterly sales reports directly to NASPO ValuePoint using the NASPO ValuePoint Quarterly Sales/Administrative Fee Reporting Tool found at <http://calculator.naspovaluepoint.org>. All sales made under this Master Agreement must be reported as cumulative totals by state. Contractor must submit a report for each quarter, including quarters during which a Contractor has no sales, in which case this will be indicated in the Reporting Tool. Reports must be submitted no later than thirty (30) days following the end of the calendar quarter (as specified in the reporting tool).
- 5.3.2 Detailed Sales Data.** Contractor shall also report detailed sales data by: (1) state; (2) entity/customer type, e.g. local government, higher education, K12, non-profit; (3) Purchasing Entity name; (4) Purchasing Entity bill-to and ship-to locations; (4) Purchasing Entity and Contractor Purchase Order identifier/number(s); (5) Purchase Order Type (e.g. sales order, credit, return, upgrade, determined by industry practices); (6) Purchase Order date; (7) Ship Date; (8) and line item description, including product number if used. The report must be submitted in any form required by the solicitation. Reports are due on a quarterly basis and must be received by the Lead State and NASPO ValuePoint Cooperative Development Team no later than thirty (30) days after the end of the reporting period. Reports must be delivered to the Lead State and to the NASPO ValuePoint Cooperative Development Team electronically through a designated portal or other method as determined by the Lead State and NASPO ValuePoint. Detailed sales data reports must include sales information for all sales under Participating Addenda executed under this Master Agreement.
- 5.3.3 Reporting on Personal Use.** Reportable sales for the summary sales data report and detailed sales data report includes sales to employees for personal use where authorized by the solicitation and the Participating Addendum. Report data for employees should be limited to ONLY the state and entity ((state and agency, city, county, school district, etc.) under whose authority the employee is purchasing Product for personal use and the amount of sales. No personal identification numbers (e.g., names, addresses, social security numbers or any other numerical identifier) may be submitted with any report.
- 5.3.4 Executive Summary.** Contractor shall provide the NASPO ValuePoint Cooperative Development Coordinator with an executive summary each quarter that includes, at a minimum, a list of states with an active Participating Addendum, states that Contractor is in negotiations with and any Participating Addendum roll out or implementation activities and issues. NASPO ValuePoint

Cooperative Development Coordinator and Contractor will determine the format and content of the executive summary. The executive summary is due thirty (30) days after the conclusion of each calendar quarter.

5.3.5 Use of Data. Timely submission of these reports is a material requirement of the Master Agreement. The recipient of the reports will have exclusive ownership of the media containing the reports. The Lead State and NASPO ValuePoint shall have a perpetual, irrevocable, non-exclusive, royalty free, transferable right to display, modify, copy, and otherwise use reports, data and information provided under this section.

5.4 NASPO ValuePoint Cooperative Program Marketing, Training, and Performance Review

5.4.1 Staff Education. Contractor shall work cooperatively with NASPO ValuePoint personnel. Contractor shall present plans to NASPO ValuePoint for the education of Contractor's contract administrator(s) and sales/marketing workforce regarding the Master Agreement contract, including the competitive nature of NASPO ValuePoint procurements, the master agreement and participating addendum process, and the manner in which eligible entities can participate in the Master Agreement.

5.4.2 Onboarding Plan. Upon request by NASPO ValuePoint, Contractor shall, as Participating Addendums are executed, provide plans to launch the program for the Participating Entity. Plans will include time frames to launch the agreement and confirmation that the Contractor's website has been updated to properly reflect the scope and terms of the Master Agreement as available to the Participating Entity and eligible Purchasing Entities.

5.4.3 Annual Contract Performance Review. Contractor shall participate in an annual contract performance review with the Lead State and NASPO ValuePoint, which may at the discretion of the Lead State be held in person and which may include a discussion of marketing action plans, target strategies, marketing materials, Contractor reporting, and timeliness of payment of administration fees.

5.4.4 Use of NASPO ValuePoint Logo. The NASPO ValuePoint logos may not be used by Contractor in sales and marketing until a separate logo use agreement is executed with NASPO ValuePoint.

5.4.5 Most Favored Customer. Contractor shall, within thirty (30) days of their effective date, to notify the Lead State and NASPO ValuePoint of any contractual most-favored-customer provisions in third-party contracts or agreements that may affect the promotion of this Master Agreements or whose terms provide for adjustments to

future rates or pricing based on rates, pricing in, or Orders from this Master Agreement. Upon request of the Lead State or NASPO ValuePoint, Contractor shall provide a copy of any such provisions.

- 5.5 Cancellation.** In consultation with NASPO ValuePoint, the Lead State may, in its discretion, cancel the Master Agreement pursuant to section 28, or not exercise an option to renew, when utilization of Contractor's Master Agreement does not warrant further administration of the Master Agreement. The Lead State may also exercise its right to not renew the Master Agreement if vendor fails to record or report revenue for three consecutive quarters, upon 60-calendar day written notice to the Contractor. Cancellation based on nonuse or under-utilization will not occur sooner than [two years] after execution of the Master Agreement. This subsection does not limit the discretionary right of either the Lead State or Contractor to cancel the Master Agreement or terminate for default subject to the terms herein. This subsection also does not limit any right of the Lead State to cancel the Master Agreement under applicable laws.

VI. Pricing, Payment & Leasing

- 6.1 Pricing.** The prices contained in this Master Agreement or offered under this Master Agreement represent the not-to-exceed price to any Purchasing Entity.
- 6.1.1** All prices and rates must be guaranteed for the initial term of the Master Agreement.
- 6.1.2** Following the initial term of the Master Agreement, any request for a price or rate adjustment must be for an equal guarantee period and must be made at least 60 days prior to the effective date.
- 6.1.3** Requests for a price or rate adjustment must include sufficient documentation supporting the request. Any adjustment or amendment to the Master Agreement will not be effective unless approved in writing by the Lead State.
- 6.1.4** No retroactive adjustments to prices or rates will be allowed.
- 6.2 Payment.** Unless otherwise agreed upon in a Participating Addendum or Order, Payment after Acceptance will be made within thirty (30) days following the date the entire order is delivered or the date a correct invoice is received, whichever is later. After 45 days the Contractor may assess overdue account charges up to a maximum rate of one percent per month on the outstanding balance, unless a different late payment amount is specified in a Participating Addendum or Order, or otherwise prescribed by applicable law. Payments will be remitted in the manner specified in the Participating Addendum or Order. Payments may be made via a purchasing card with no additional charge.

- 6.3 Leasing or Alternative Financing Methods.** The procurement and other applicable laws of some Purchasing Entities may permit the use of leasing or alternative financing methods for the acquisition of Products under this Master Agreement. Where the terms and conditions are not otherwise prescribed in an applicable Participating Addendum, the terms and conditions for leasing or alternative financing methods are subject to negotiation between the Contractor and Purchasing Entity.

VII. Ordering

- 7.1 Order Numbers.** Master Agreement order and purchase order numbers must be clearly shown on all acknowledgments, packing slips, invoices, and on all correspondence.
- 7.2 Quotes.** Purchasing Entities may define entity-specific or project-specific requirements and informally compete the requirement among companies having a Master Agreement on an “as needed” basis. This procedure may also be used when requirements are aggregated or other firm commitments may be made to achieve reductions in pricing. This procedure may be modified in Participating Addenda and adapted to the Purchasing Entity’s rules and policies. The Purchasing Entity may in its sole discretion determine which Master Agreement Contractors should be solicited for a quote. The Purchasing Entity may select the quote that it considers most advantageous, cost, and other factors considered.
- 7.3 Applicable Rules.** Each Purchasing Entity will identify and utilize its own appropriate purchasing procedure and documentation. Contractor is expected to become familiar with the Purchasing Entities’ rules, policies, and procedures regarding the ordering of supplies and/or services contemplated by this Master Agreement.
- 7.4 Required Documentation.** Contractor shall not begin work without a valid Purchase Order or other appropriate commitment document under the law of the Purchasing Entity.
- 7.5 Term of Purchase.** Orders may be placed consistent with the terms of this Master Agreement and applicable Participating Addendum during the term of the Master Agreement and Participating Addendum.
- 7.5.1** Orders must be placed pursuant to this Master Agreement prior to the termination date thereof, but may have a delivery date or performance period up to 120 days past the then-current termination date of this Master Agreement.
- 7.5.2** Notwithstanding the previous, Orders must also comply with the terms of the applicable Participating Addendum, which may further restrict the period during which Orders may be placed or delivered.
- 7.5.3** Financial obligations of Purchasing Entities payable after the current applicable fiscal year are contingent upon agency funds for that purpose being appropriated, budgeted, and otherwise made available.

- 7.5.4** Notwithstanding the expiration, cancellation or termination of this Master Agreement, Contractor shall perform in accordance with the terms of any Orders then outstanding at the time of such expiration or termination. Contractor shall not honor any Orders placed after the expiration, cancellation, or termination of this Master Agreement, or in any manner inconsistent with this Master Agreement's terms.
- 7.5.5** Orders for any separate indefinite quantity, task order, or other form of indefinite delivery order arrangement priced against this Master Agreement may not be placed after the expiration or termination of this Master Agreement, notwithstanding the term of any such indefinite delivery order agreement.
- 7.6 Order Form Requirements.** All Orders pursuant to this Master Agreement, at a minimum, must include:
- 7.6.1** The services or supplies being delivered;
- 7.6.2** A shipping address and other delivery requirements, if any;
- 7.6.3** A billing address;
- 7.6.4** Purchasing Entity contact information;
- 7.6.5** Pricing consistent with this Master Agreement and applicable Participating Addendum and as may be adjusted by agreement of the Purchasing Entity and Contractor;
- 7.6.6** A not-to-exceed total for the products or services being ordered; and
- 7.6.7** The Master Agreement number or the applicable Participating Addendum number, provided the Participating Addendum references the Master Agreement number.
- 7.7 Communication.** All communications concerning administration of Orders placed must be furnished solely to the authorized purchasing agent within the Purchasing Entity's purchasing office, or to such other individual identified in writing in the Order.
- 7.8 Contract Provisions for Orders Utilizing Federal Funds.** Pursuant to Appendix II to 2 Code of Federal Regulations (CFR) Part 200, Contract Provisions for Non-Federal Entity Contracts Under Federal Awards, Orders funded with federal funds may have additional contractual requirements or certifications that must be satisfied at the time the Order is placed or upon delivery. These federal requirements may be proposed by Participating Entities in Participating Addenda and Purchasing Entities for incorporation in Orders placed under this Master Agreement.

VIII. Shipping and Delivery

- 8.1 Shipping Terms.** All deliveries will be F.O.B. destination, freight pre-paid, with all transportation and handling charges paid by the Contractor.
- 8.1.1** Notwithstanding the above, responsibility and liability for loss or damage will remain the Contractor's until final inspection and acceptance when responsibility will pass to the Purchasing Entity except as to latent defects, fraud, and Contractor's warranty obligations.
- 8.2 Minimum Shipping.** The minimum shipment amount, if any, must be contained in the Master Agreement. Any order for less than the specified amount is to be shipped with the freight prepaid and added as a separate item on the invoice. Any portion of an Order to be shipped without transportation charges that is back ordered will be shipped without charge.
- 8.3 Inside Deliveries.** To the extent applicable, all deliveries will be "Inside Deliveries" as designated by a representative of the Purchasing Entity placing the Order. Inside Delivery refers to a delivery to a location other than a loading dock, front lobby, or reception area. Specific delivery instructions will be noted on the order form or Purchase Order. Costs to repair any damage to the building interior (e.g., scratched walls, damage to the freight elevator, etc.) caused by Contractor or Contractor's carrier will be the responsibility of the Contractor. Immediately upon becoming aware of such damage, Contractor shall notify the Purchasing Entity placing the Order.
- 8.4 Packaging.** All products must be delivered in the manufacturer's standard package. Costs must include all packing and/or crating charges. Cases must be of durable construction, in good condition, properly labeled and suitable in every respect for storage and handling of contents. Each shipping carton must be marked with the commodity, brand, quantity, item code number and the Purchasing Entity's Purchase Order number.

IX. Inspection and Acceptance

- 9.1 Laws and Regulations.** Any and all Products offered and furnished must comply fully with all applicable Federal, State, and local laws and regulations.
- 9.2 Applicability.** Unless otherwise specified in the Master Agreement, Participating Addendum, or ordering document, the terms of this Section IX will apply. This section is not intended to limit rights and remedies under the applicable commercial code.
- 9.3 Inspection.** All Products are subject to inspection at reasonable times and places before Acceptance. Contractor shall provide right of access to the Lead State, or to any other authorized agent or official of the Lead State or other Participating or Purchasing Entity, at reasonable times, to monitor

and evaluate performance, compliance, and/or quality assurance requirements under this Master Agreement.

9.3.1 Products that do not meet specifications may be rejected. Failure to reject upon receipt, however, does not relieve the contractor of liability for material (nonconformity that substantially impairs value) latent or hidden defects subsequently revealed when goods are put to use.

9.3.2 Acceptance of such goods may be revoked in accordance with the provisions of the applicable commercial code, and the Contractor is liable for any resulting expense incurred by the Purchasing Entity related to the preparation and shipping of Product rejected and returned, or for which Acceptance is revoked.

9.4 Failure to Conform. If any services do not conform to contract requirements, the Purchasing Entity may require the Contractor to perform the services again in conformity with contract requirements, at no increase in Order amount. When defects cannot be corrected by re-performance, the Purchasing Entity may require the Contractor to take necessary action to ensure that future performance conforms to contract requirements and reduce the contract price to reflect the reduced value of services performed.

9.5 Acceptance Testing. Purchasing Entity may establish a process, in keeping with industry standards, to ascertain whether the Product meets the standard of performance or specifications prior to Acceptance by the Purchasing Entity.

9.5.1 The Acceptance Testing period will be thirty (30) calendar days, unless otherwise specified, starting from the day after the Product is delivered or, if installed by Contractor, the day after the Product is installed and Contractor certifies that the Product is ready for Acceptance Testing.

9.5.2 If the Product does not meet the standard of performance or specifications during the initial period of Acceptance Testing, Purchasing Entity may, at its discretion, continue Acceptance Testing on a day-to-day basis until the standard of performance is met.

9.5.3 Upon rejection, the Contractor will have fifteen (15) calendar days to cure. If after the cure period, the Product still has not met the standard of performance or specifications, the Purchasing Entity may, at its option: (a) declare Contractor to be in breach and terminate the Order; (b) demand replacement Product from Contractor at no additional cost to Purchasing Entity; or, (c) continue the cure period for an additional time period agreed upon by the Purchasing Entity and the Contractor.

9.5.4 Contractor shall pay all costs related to the preparation and shipping of Product returned pursuant to the section.

9.5.5 No Product will be deemed Accepted and no charges will be paid until the standard of performance or specification is met.

X. Warranty

10.1 Applicability. Unless otherwise specified in the Master Agreement, Participating Addendum, or ordering document, the terms of this Section X will apply.

10.2 Warranty. The Contractor warrants for a period of one year from the date of Acceptance that: (a) the Product performs according to all specific claims that the Contractor made in its response to the solicitation, (b) the Product is suitable for the ordinary purposes for which such Product is used, (c) the Product is suitable for any special purposes identified in the solicitation or for which the Purchasing Entity has relied on the Contractor's skill or judgment, (d) the Product is designed and manufactured in a commercially reasonable manner, and (e) the Product is free of defects.

10.3 Breach of Warranty. Upon breach of the warranty set forth above, the Contractor will repair or replace (at no charge to the Purchasing Entity) the Product whose nonconformance is discovered and made known to the Contractor. If the repaired and/or replaced Product proves to be inadequate, or fails of its essential purpose, the Contractor will refund the full amount of any payments that have been made.

10.4 Rights Reserved. The rights and remedies of the parties under this warranty are in addition to any other rights and remedies of the parties provided by law or equity, including, without limitation, actual damages, and, as applicable and awarded under the law, to a prevailing party, reasonable attorneys' fees and costs.

10.5 Warranty Period Start Date. The warranty period will begin upon Acceptance, as set forth in Section IX.

XI. Product Title

11.1 Conveyance of Title. Upon Acceptance by the Purchasing Entity, Contractor shall convey to Purchasing Entity title to the Product free and clear of all liens, encumbrances, or other security interests.

11.2 Embedded Software. Transfer of title to the Product must include an irrevocable and perpetual license to use any Embedded Software in the Product. If Purchasing Entity subsequently transfers title of the Product to another entity, Purchasing Entity shall have the right to transfer the license to use the Embedded Software with the transfer of Product title. A subsequent transfer of this software license will be at no additional cost or charge to either Purchasing Entity or Purchasing Entity's transferee.

11.3 License of Pre-Existing Intellectual Property. Contractor grants to the Purchasing Entity a nonexclusive, perpetual, royalty-free, irrevocable, license to use, publish, translate, reproduce, transfer with any sale of tangible media or Product, perform, display, and dispose of the Intellectual Property, and its derivatives, used or delivered under this Master Agreement, but not created under it ("Pre-existing Intellectual Property"). The Contractor shall be responsible for ensuring that this license is consistent with any third-party rights in the Pre-existing Intellectual Property.

XII. Indemnification

12.1 General Indemnification. The Contractor shall defend, indemnify and hold harmless NASPO, NASPO ValuePoint, the Lead State, Participating Entities, and Purchasing Entities, along with their officers and employees, from and against third-party claims, damages or causes of action including reasonable attorneys' fees and related costs for any death, injury, or damage to tangible property arising from any act, error, or omission of the Contractor, its employees or subcontractors or volunteers, at any tier, relating to performance under this Master Agreement.

12.2 Intellectual Property Indemnification. The Contractor shall defend, indemnify and hold harmless NASPO, NASPO ValuePoint, the Lead State, Participating Entities, Purchasing Entities, along with their officers and employees ("Indemnified Party"), from and against claims, damages or causes of action including reasonable attorneys' fees and related costs arising out of the claim that the Product or its use infringes Intellectual Property rights of another person or entity ("Intellectual Property Claim").

12.2.1 The Contractor's obligations under this section will not extend to any combination of the Product with any other product, system or method, unless the Product, system or method is:

12.2.1.1 provided by the Contractor or the Contractor's subsidiaries or affiliates;

12.2.1.2 specified by the Contractor to work with the Product;

12.2.1.3 reasonably required to use the Product in its intended manner, and the infringement could not have been avoided by substituting another reasonably available product, system or method capable of performing the same function; or

12.2.1.4 reasonably expected to be used in combination with the Product.

12.2.2 The Indemnified Party shall notify the Contractor within a reasonable time after receiving notice of an Intellectual Property Claim. Even if the Indemnified Party fails to provide reasonable notice, the Contractor shall not be relieved from its obligations unless the Contractor can demonstrate that it was prejudiced in

defending the Intellectual Property Claim resulting in increased expenses or loss to the Contractor. If the Contractor promptly and reasonably investigates and defends any Intellectual Property Claim, it shall have control over the defense and settlement of the Intellectual Property Claim. However, the Indemnified Party must consent in writing for any money damages or obligations for which it may be responsible.

12.2.3 The Indemnified Party shall furnish, at the Contractor's reasonable request and expense, information and assistance necessary for such defense. If the Contractor fails to vigorously pursue the defense or settlement of the Intellectual Property Claim, the Indemnified Party may assume the defense or settlement of the Intellectual Property Claim and the Contractor shall be liable for all costs and expenses, including reasonable attorneys' fees and related costs, incurred by the Indemnified Party in the pursuit of the Intellectual Property Claim.

12.2.4 Unless otherwise set forth herein, Section 12.2 is not subject to any limitations of liability in this Master Agreement or in any other document executed in conjunction with this Master Agreement.

XIII. Insurance

13.1 Term. Contractor shall, during the term of this Master Agreement, maintain in full force and effect, the insurance described in this section. A Participating Entity may negotiate alternative Insurance requirements in their Participating Addendum.

13.2 Class. Contractor shall acquire such insurance from an insurance carrier or carriers licensed to conduct business in each Participating Entity's state and having a rating of A-, Class VII or better, in the most recently published edition of A.M. Best's Insurance Reports. Failure to buy and maintain the required insurance may result in this Master Agreement's termination or, at a Participating Entity's option, result in termination of its Participating Addendum.

13.3 Coverage. Coverage must be written on an occurrence basis. The minimum acceptable limits will be as indicated below:

13.3.1 Contractor shall maintain Commercial General Liability insurance covering premises operations, independent contractors, products and completed operations, blanket contractual liability, personal injury (including death), advertising liability, and property damage, with a limit of not less than \$1 million per occurrence and \$2 million general aggregate;

13.3.2 Contractor must comply with any applicable State Workers Compensation or Employers Liability Insurance requirements.

- 13.4 Notice of Cancellation.** Contractor shall pay premiums on all insurance policies. Contractor shall provide notice to a Participating Entity who is a state within five (5) business days after Contractor is first aware of expiration, cancellation or nonrenewal of such policy or is first aware that cancellation is threatened or expiration, nonrenewal or expiration otherwise may occur.
- 13.5 Notice of Endorsement.** Prior to commencement of performance, Contractor shall provide to the Lead State a written endorsement to the Contractor's general liability insurance policy or other documentary evidence acceptable to the Lead State that (1) provides that written notice of cancellation will be delivered in accordance with the policy provisions, and (2) provides that the Contractor's liability insurance policy will be primary, with any liability insurance of any Participating State as secondary and noncontributory.
- 13.6 Participating Entities.** Contractor shall provide to Participating States and Participating Entities the same insurance obligations and documentation as those specified in Section XIII, except the endorsement is provided to the applicable Participating State or Participating Entity.
- 13.7 Furnishing of Certificates.** Contractor shall furnish to the Lead State copies of certificates of all required insurance in a form sufficient to show required coverage within thirty (30) calendar days of the execution of this Master Agreement and prior to performing any work. Copies of renewal certificates of all required insurance will be furnished within thirty (30) days after any renewal date to the applicable state Participating Entity. Failure to provide evidence of coverage may, at the sole option of the Lead State, or any Participating Entity, result in this Master Agreement's termination or the termination of any Participating Addendum.
- 13.8 Disclaimer.** Insurance coverage and limits will not limit Contractor's liability and obligations under this Master Agreement, any Participating Addendum, or any Purchase Order.

XIV. General Provisions

14.1 Records Administration and Audit

- 14.1.1** The Contractor shall maintain books, records, documents, and other evidence pertaining to this Master Agreement and Orders placed by Purchasing Entities under it to the extent and in such detail as will adequately reflect performance and administration of payments and fees. Contractor shall permit the Lead State, a Participating Entity, a Purchasing Entity, the federal government (including its grant awarding entities and the U.S. Comptroller General), and any other duly authorized agent of a governmental agency, to audit, inspect, examine, copy and/or transcribe Contractor's books, documents, papers and records directly pertinent to this Master Agreement or orders placed by a

Purchasing Entity under it for the purpose of making audits, examinations, excerpts, and transcriptions. This right will survive for a period of six (6) years following termination of this Agreement or final payment for any order placed by a Purchasing Entity against this Master Agreement, whichever is later, or such longer period as is required by the Purchasing Entity's state statutes, to assure compliance with the terms hereof or to evaluate performance hereunder.

14.1.2 Without limiting any other remedy available to any governmental entity, the Contractor shall reimburse the applicable Lead State, Participating Entity, or Purchasing Entity for any overpayments inconsistent with the terms of the Master Agreement or Orders or underpayment of fees found as a result of the examination of the Contractor's records.

14.1.3 The rights and obligations herein exist in addition to any quality assurance obligation in the Master Agreement that requires the Contractor to self-audit contract obligations and that permits the Lead State to review compliance with those obligations.

14.2 Confidentiality, Non-Disclosure, and Injunctive Relief

14.2.1 Confidentiality. Contractor acknowledges that it and its employees or agents may, in the course of providing a Product under this Master Agreement, be exposed to or acquire information that is confidential to Purchasing Entity or Purchasing Entity's clients.

14.2.1.1 Any and all information of any form that is marked as confidential or would by its nature be deemed confidential obtained by Contractor or its employees or agents in the performance of this Master Agreement, including but not necessarily limited to (1) any Purchasing Entity's records, (2) personnel records, and (3) information concerning individuals, is confidential information of Purchasing Entity ("Confidential Information").

14.2.1.2 Any reports or other documents or items (including software) that result from the use of the Confidential Information by Contractor shall be treated in the same manner as the Confidential Information.

14.2.1.3 Confidential Information does not include information that (1) is or becomes (other than by disclosure by Contractor) publicly known; (2) is furnished by Purchasing Entity to others without restrictions similar to those imposed by this Master Agreement; (3) is rightfully in Contractor's possession without the

obligation of nondisclosure prior to the time of its disclosure under this Master Agreement; (4) is obtained from a source other than Purchasing Entity without the obligation of confidentiality, (5) is disclosed with the written consent of Purchasing Entity; or (6) is independently developed by employees, agents or subcontractors of Contractor who can be shown to have had no access to the Confidential Information.

14.2.2 Non-Disclosure. Contractor shall hold Confidential Information in confidence, using at least the industry standard of confidentiality, and shall not copy, reproduce, sell, assign, license, market, transfer or otherwise dispose of, give, or disclose Confidential Information to third parties or use Confidential Information for any purposes whatsoever other than what is necessary to the performance of Orders placed under this Master Agreement.

14.2.2.1 Contractor shall advise each of its employees and agents of their obligations to keep Confidential Information confidential. Contractor shall use commercially reasonable efforts to assist Purchasing Entity in identifying and preventing any unauthorized use or disclosure of any Confidential Information.

14.2.2.2 Without limiting the generality of the foregoing, Contractor shall advise Purchasing Entity, applicable Participating Entity, and the Lead State immediately if Contractor learns or has reason to believe that any person who has had access to Confidential Information has violated or intends to violate the terms of this Master Agreement, and Contractor shall at its expense cooperate with Purchasing Entity in seeking injunctive or other equitable relief in the name of Purchasing Entity or Contractor against any such person.

14.2.2.3 Except as directed by Purchasing Entity, Contractor will not at any time during or after the term of this Master Agreement disclose, directly or indirectly, any Confidential Information to any person, except in accordance with this Master Agreement, and that upon termination of this Master Agreement or at Purchasing Entity's request, Contractor shall turn over to Purchasing Entity all documents, papers, and other matter in Contractor's possession that embody Confidential Information.

14.2.2.4 Notwithstanding the foregoing, Contractor may keep one copy of such Confidential Information necessary for quality assurance, audits, and evidence of the performance of this Master Agreement.

14.2.3 Injunctive Relief. Contractor acknowledges that Contractor's breach of Section 14.2 would cause irreparable injury to the Purchasing Entity that cannot be inadequately compensated in monetary damages. Accordingly, Purchasing Entity may seek and obtain injunctive relief against the breach or threatened breach of the foregoing undertakings, in addition to any other legal remedies that may be available. Contractor acknowledges and agrees that the covenants contained herein are necessary for the protection of the legitimate business interests of Purchasing Entity and are reasonable in scope and content.

14.2.4 Purchasing Entity Law. These provisions will be applicable only to extent they are not in conflict with the applicable public disclosure laws of any Purchasing Entity.

14.2.5 NASPO ValuePoint. The rights granted to Purchasing Entities and Contractor's obligations under this section will also extend to NASPO ValuePoint's Confidential Information, including but not limited to Participating Addenda, Orders or transaction data relating to Orders under this Master Agreement that identify the entity/customer, Order dates, line-item descriptions and volumes, and prices/rates. This provision does not apply to disclosure to the Lead State, a Participating State, or any governmental entity exercising an audit, inspection, or examination pursuant to this Master Agreement. To the extent permitted by law, Contractor shall notify the Lead State of the identify of any entity seeking access to the Confidential Information described in this subsection.

14.2.6 Public Information. This Master Agreement and all related documents are subject to disclosure pursuant to the Lead State's public information laws.

14.3 Assignment/Subcontracts

14.3.1 Contractor shall not assign, sell, transfer, subcontract or sublet rights, or delegate responsibilities under this Master Agreement, in whole or in part, without the prior written approval of the Lead State.

14.3.2 The Lead State reserves the right to assign any rights or duties, including written assignment of contract administration duties, to NASPO ValuePoint and other third parties.

14.4 Changes in Contractor Representation. The Contractor must, within ten (10) calendar days, notify the Lead State in writing of any changes in the

Contractor's key administrative personnel managing the Master Agreement. The Lead State reserves the right to approve or reject changes in key personnel, as identified in the Contractor's proposal. The Contractor shall propose replacement key personnel having substantially equal or better education, training, and experience as was possessed by the key person proposed and evaluated in the Contractor's proposal.

- 14.5 Independent Contractor.** Contractor is an independent contractor. Contractor has no authorization, express or implied, to bind the Lead State, Participating States, other Participating Entities, or Purchasing Entities to any agreements, settlements, liability or understanding whatsoever, and shall not to hold itself out as agent except as expressly set forth herein or as expressly set forth in an applicable Participating Addendum or Order.
- 14.6 Cancellation.** Unless otherwise set forth herein, this Master Agreement may be canceled by either party upon sixty (60) days' written notice prior to the effective date of the cancellation. Further, any Participating Entity may cancel its participation upon thirty (30) days' written notice, unless otherwise limited or stated in the Participating Addendum. Cancellation may be in whole or in part. Any cancellation under this provision will not affect the rights and obligations attending Orders outstanding at the time of cancellation, including any right of a Purchasing Entity to indemnification by the Contractor, rights of payment for Products delivered and accepted, rights attending any warranty or default in performance in association with any Order, and requirements for records administration and audit. Cancellation of the Master Agreement due to Contractor default may be immediate.
- 14.7 Force Majeure.** Neither party to this Master Agreement shall be held responsible for delay or default caused by fire, riot, unusually severe weather, other acts of God, or acts of war which are beyond that party's reasonable control. The Lead State may terminate this Master Agreement upon determining such delay or default will reasonably prevent successful performance of the Master Agreement.
- 14.8 Defaults and Remedies**
- 14.8.1** The occurrence of any of the following events will be an event of default under this Master Agreement:
- 14.8.1.1** Nonperformance of contractual requirements;
 - 14.8.1.2** A material breach of any term or condition of this Master Agreement;
 - 14.8.1.3** Any certification, representation or warranty by Contractor in response to the solicitation or in this Master Agreement that proves to be untrue or materially misleading;

- 14.8.1.4** Institution of proceedings under any bankruptcy, insolvency, reorganization or similar law, by or against Contractor, or the appointment of a receiver or similar officer for Contractor or any of its property, which is not vacated or fully stayed within thirty (30) calendar days after the institution or occurrence thereof; or
- 14.8.1.5** Any default specified in another section of this Master Agreement.
- 14.8.2** Upon the occurrence of an event of default, the Lead State shall issue a written notice of default, identifying the nature of the default, and providing a period of fifteen (15) calendar days in which Contractor shall have an opportunity to cure the default. The Lead State shall not be required to provide advance written notice or a cure period and may immediately terminate this Master Agreement in whole or in part if the Lead State, in its sole discretion, determines that it is reasonably necessary to preserve public safety or prevent immediate public crisis. Time allowed for cure will not diminish or eliminate Contractor's liability for damages, including liquidated damages to the extent provided for under this Master Agreement.
- 14.8.3** If Contractor is afforded an opportunity to cure and fails to cure the default within the period specified in the written notice of default, Contractor shall be in breach of its obligations under this Master Agreement and the Lead State shall have the right to exercise any or all of the following remedies:
- 14.8.3.1** Any remedy provided by law;
- 14.8.3.2** Termination of this Master Agreement and any related Contracts or portions thereof;
- 14.8.3.3** Assessment of liquidated damages as provided in this Master Agreement;
- 14.8.3.4** Suspension of Contractor from being able to respond to future bid solicitations;
- 14.8.3.5** Suspension of Contractor's performance; and
- 14.8.3.6** Withholding of payment until the default is remedied.
- 14.8.4** Unless otherwise specified in the Participating Addendum, in the event of a default under a Participating Addendum, a Participating Entity shall provide a written notice of default as described in this section and shall have all of the rights and remedies under this paragraph regarding its participation in the Master Agreement, in addition to those set forth in its Participating Addendum. Unless otherwise specified in an Order, a Purchasing Entity shall provide written notice of default

as described in this section and have all of the rights and remedies under this paragraph and any applicable Participating Addendum with respect to an Order placed by the Purchasing Entity. Nothing in these Master Agreement Terms and Conditions will be construed to limit the rights and remedies available to a Purchasing Entity under the applicable commercial code.

- 14.9 Waiver of Breach.** Failure of the Lead State, Participating Entity, or Purchasing Entity to declare a default or enforce any rights and remedies will not operate as a waiver under this Master Agreement, any Participating Addendum, or any Purchase Order. Any waiver by the Lead State, Participating Entity, or Purchasing Entity must be in writing. Waiver by the Lead State or Participating Entity of any default, right or remedy under this Master Agreement or Participating Addendum, or by Purchasing Entity with respect to any Purchase Order, or breach of any terms or requirements of this Master Agreement, a Participating Addendum, or Purchase Order will not be construed or operate as a waiver of any subsequent default or breach of such term or requirement, or of any other term or requirement under this Master Agreement, any Participating Addendum, or any Purchase Order.
- 14.10 Debarment.** The Contractor certifies that neither it nor its principals are presently debarred, suspended, proposed for debarment, declared ineligible, or voluntarily excluded from participation in public procurement or contracting by any governmental department or agency. This certification represents a recurring certification made at the time any Order is placed under this Master Agreement. If the Contractor cannot certify this statement, attach a written explanation for review by the Lead State.
- 14.11 No Waiver of Sovereign Immunity**
- 14.11.1** In no event will this Master Agreement, any Participating Addendum or any contract or any Purchase Order issued thereunder, or any act of the Lead State, a Participating Entity, or a Purchasing Entity be a waiver of any form of defense or immunity, whether sovereign immunity, governmental immunity, immunity based on the Eleventh Amendment to the Constitution of the United States or otherwise, from any claim or from the jurisdiction of any court.
- 14.11.2** This section applies to a claim brought against the Participating Entities who are states only to the extent Congress has appropriately abrogated the state's sovereign immunity and is not consent by the state to be sued in federal court. This section is also not a waiver by the state of any form of immunity, including but not limited to sovereign immunity and immunity based on the Eleventh Amendment to the Constitution of the United States.

14.12 Governing Law and Venue

- 14.12.1** The procurement, evaluation, and award of the Master Agreement will be governed by and construed in accordance with the laws of the Lead State sponsoring and administering the procurement. The construction and effect of the Master Agreement after award will be governed by the law of the state serving as Lead State. The construction and effect of any Participating Addendum or Order against the Master Agreement will be governed by and construed in accordance with the laws of the Participating Entity's or Purchasing Entity's state.
- 14.12.2** Unless otherwise specified in the RFP, the venue for any protest, claim, dispute or action relating to the procurement, evaluation, and award is in the state serving as Lead State. Venue for any claim, dispute or action concerning the terms of the Master Agreement will be in the state serving as Lead State. Venue for any claim, dispute, or action concerning any Order placed against the Master Agreement or the effect of a Participating Addendum will be in the Purchasing Entity's state.
- 14.12.3** If a claim is brought in a federal forum, then it must be brought and adjudicated solely and exclusively within the United States District Court for (in decreasing order of priority): the Lead State for claims relating to the procurement, evaluation, award, or contract performance or administration if the Lead State is a party; a Participating State if a named party; the state where the Participating Entity or Purchasing Entity is located if either is a named party.

14.13 Assignment of Antitrust Rights. Contractor irrevocably assigns to a Participating Entity who is a state any claim for relief or cause of action which the Contractor now has or which may accrue to the Contractor in the future by reason of any violation of state or federal antitrust laws (15 U.S.C. § 1-15 or a Participating Entity's state antitrust provisions), as now in effect and as may be amended from time to time, in connection with any goods or services provided in that state for the purpose of carrying out the Contractor's obligations under this Master Agreement or Participating Addendum, including, at the Participating Entity's option, the right to control any such litigation on such claim for relief or cause of action.

Attachment B: Scope of Work

CH21-36: NASPO Small Package Delivery Services

1. Exclusion of Listed Charges:

Offeror certifies the following regarding the exclusion of listed charges:

- a. The Offeror shall not propose or apply pick-up charges or weekly service in addition to the contracted rates due to aggregate NASPO ValuePoint volume anticipated.
- b. The Offeror shall not require a minimum number of packages per trip, per day, per week or per month.

2. Carrier Pick-Up:

Offeror will pick-up packages directly from all requesting agencies and political subdivisions upon request. Offeror must bill each Authorized User for shipments the Authorized User tenders to the Carrier. Packages must be scanned when picked up at the location.

3. Money Back Guarantee

- a. Offeror must provide a 100% Money Back Guarantee. The Carrier shall fully refund or credit the Authorized User account for the packages that are not delivered or picked up in accordance with the guaranteed delivery service. Authorized User shall decide between a refund or a credit to their account. Packages that are delivered over 60 seconds after the guaranteed delivery time are considered late. The Authorized User shall request the refund or credit within 30 days of the scheduled delivery time. Carriers are encouraged to offer automatic refunds. If the late package meets one or more of the Carrier's exception criteria, as stated in the Service Guide, the Carrier is not obligated to issue a refund to the Authorized User.
- b. Carrier must provide clearly marked money back guaranteed zone based price sheets (schedules of rates and charges) for each service showing rates and charges by weight and zone for all contiguous 48 state domestic shipping. Separate rates in pages may be provided and clearly marked for Hawaii and Alaska and Puerto Rico services. Carriers offering pricing for intrastate ground services only must provide separate clearly marked zone based pricing for the designated state. Rates will be in dollars and cents per pound.
- c. Non-Money Back Guarantee: Offerors must propose a money back guarantee. If an Offeror opts to additionally propose a non-money back guarantee option, the offeror must clearly delineate between the money back guarantee cost and the non-money back guarantee cost. (This portion of the Scope may be updated depending on the vendor's submission and their Money Back guarantee the offeror provides.)

4. Carrier Capabilities:

Offerors providing interstate services must serve every zip code in the United States or if providing interstate services in certain states only, offer services in every zip code in the states in which services are provided. Offerors providing intrastate services shall serve every zip code within the boundaries of the Participating State requesting intra-state services as identified in this RFP.

5. Software:

Offerors shall provide a description of how the software is accessed in the solicitation response. Including, if an online application is available instead of or along with the software needed to run the shipping system. All software whether online or separate software must have the Master Agreement Rates pre-loaded and the Offeror maintains the software and website free of charge to the Participating Users and Master Agreement.

6. Shipment of Materials:

- a. Describe the process for picking up dangerous, Hazardous or Otherwise Restricted Materials: Carrier shall be capable of shipping a variety of hazardous, dangers or other restricted types of materials. Offeror shall provide its policy for dangerous, hazardous, and restricted materials.
- b. Evidentiary Materials: Describe the process and tracking for evidentiary materials. Also, describe an instance and detail the approach taken when the Carrier's process needed to be modified for a participating state's laws, policies, or procedures. Alternatively, describe how Carrier would approach modifying their process for an Authorized User based on the user's laws, policies, or procedures. Note: Offeror must be able to provide services for shipments of evidentiary materials in compliance with any participating state's laws, policies or procedures.

7. Deliver as Addressed:

When requested, Offerors must return undeliverable packages to senders, rather than performing an address correction and forwarding the package to an address. Offerors shall work with Authorized User's to adequately identify these items as "deliver as addressed" or something similar in language mutually agreed upon between the State and the Offeror rather than forwarding an undeliverable package. Authorized Users shall notify Offerors of such packages.

Attachment C: Cost Proposal

CH21-36: Small Package Delivery Services

Instructions:

1. Any alteration to Attachment C: Cost Proposal may result in proposal being deemed non-responsive.
2. Offeror submitting costs to Nationwide Coverage MUST fill out all of the Regional Cost tabs to be awarded for Nationwide Coverage.
3. Offeror who is not submitting cost for Nationwide Coverage may fill out a Cost Proposal for each region they are applying for an award for. If a tab does not have any costs submitted the Offeror will not be awarded for that region or National coverage.
4. If Offeror is awarded a regional contract they may sign a PA with states within that region. If Offeror does not get awarded a region they will not be able to sign a PA with those States through the term of the contract.
5. Offeror does not have to provide services to every state in a Region. The US is broken up regionally to evaluate costs for regional vendors and allow expansion of PA's to awarded offerors within a region.

Regional Map:

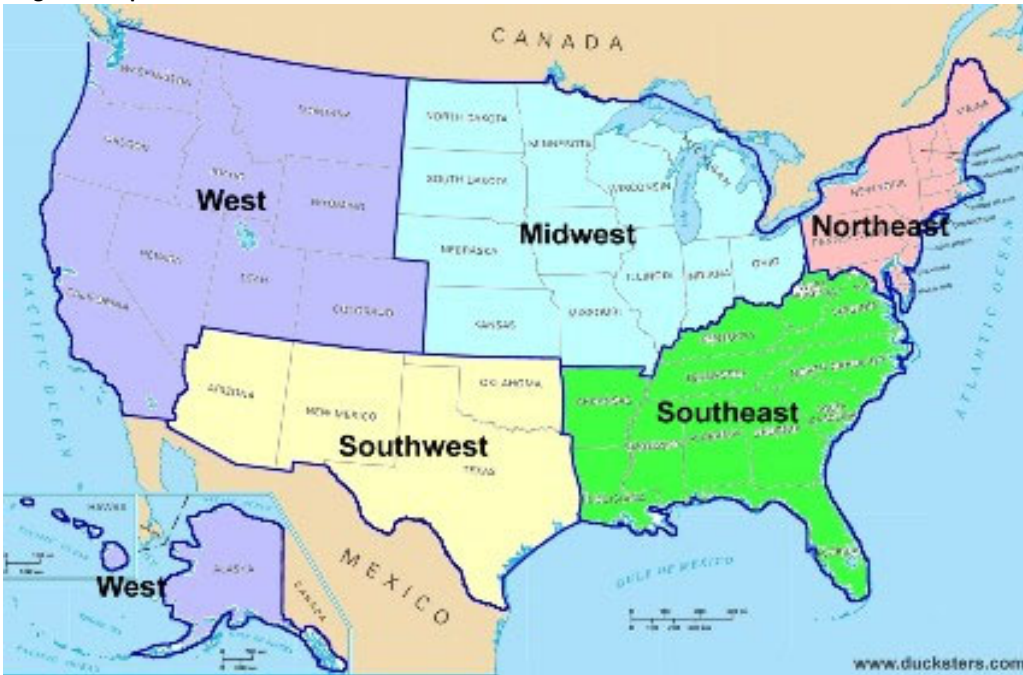

Region 1 - West

States included: Colorado, Wyoming, Montana, Idaho, Washington, Oregon, Utah, Nevada, California, Alaska, Hawaii

Region 2 - Midwest

States included: Ohio, Indiana, Michigan, Illinois, Missouri, Wisconsin, Minnesota, Iowa, Kansas, Nebraska, South Dakota, North Dakota

Region 3 - Southwest

States included: Texas, Oklahoma, New Mexico, Arizona

Region 4 - Southeast

States included: West Virginia, Virginia, Kentucky, Tennessee, North Carolina, South Carolina, Georgia, Alabama, Mississippi, Arkansas, Louisiana, Florida

Region 5 -Northeast

States included: Maine, Massachusetts, Rhode Island, Connecticut, New Hampshire, Vermont, New York, Pennsylvania, New Jersey, Delaware, Maryland

Region 1 - West

States included: Colorado, Wyoming, Montana, Idaho, Washington, Oregon, Utah, Nevada, California, Alaska, Hawaii

Regional Instructions:

1. If Offeror cannot provide a cost for the scenario, put \$0.00 or leave Scenario blank.
2. Any Scenario with \$0.00 will receive no Cost Points for that line item.
3. The points assigned to each Offeror's cost proposal will be based on the lowest proposal price of each scenario. The Offeror with the lowest Proposed Price will receive 100% of the price points for that scenario. All other Offerors will receive a portion of the total cost points based on what percentage higher their Proposed Price is than the Lowest Proposed Price. An Offeror whose Proposed Price is more than double (200%) the Lowest Proposed Price will receive no points. The formula to compute the points is: $\text{Cost Points} \times (2 - \frac{\text{Proposed Price}}{\text{Lowest Proposed Price}})$.
4. Offeror shall describe each fee associated with the shipping scenario
5. Offeror to fill out the portions in Yellow.

Scenario #1 - Total of 80 Points Possible

CA Intrastate, Express Overnight: 4lbs package shipped from 90095 to 94720; declared value.

Description of Fees:

Total Cost:

Scenario #2 - Total of 80 Points Possible

UT Intrastate, Ground, Residential: 15lb package shipped from 84111 to 84404; on-call pickup, same day; proof of delivery.

Description of Fees:

Total Cost:

Scenario #3 - Total of 80 Points Possible

WA Interstate, Express 2nd day: 7lb package shipped from 98101 to 98402; declared signature required; declared value, express.

Description of Fees:

Total Cost:

Scenario #4 - Total of 80 Points Possible

OR Interstate; Express overnight mid-AM; 4lbs package shipped from 97215 to 97301; adult signature required

Description of Fees:

Total Cost:

Scenario #5 - Total of 80 Points Possible

NV Interstate, Ground: 5lbs package shipped from 89403 to 88901; Saturday delivery

Description of Fees:

Total Cost:

Region 2 - Midwest

States included: Ohio, Indiana, Michigan, Illinois, Missouri, Wisconsin, Minnesota, Iowa, Kansas, Nebraska, South Dakota, North Dakota

Regional Instructions:

1. If Offeror cannot provide a cost for the scenario, put \$0.00 or leave Scenario blank.
2. Any Scenario with \$0.00 will receive no Cost Points for that line item.
3. The points assigned to each Offeror's cost proposal will be based on the lowest proposal price of each scenario. The Offeror with the lowest Proposed Price will receive 100% of the price points for that scenario. All other Offerors will receive a portion of the total cost points based on what percentage higher their Proposed Price is than the Lowest Proposed Price. An Offeror whose Proposed Price is more than double (200%) the Lowest Proposed Price will receive no points. The formula to compute the points is: $\text{Cost Points} \times (2 - \frac{\text{Proposed Price}}{\text{Lowest Proposed Price}})$.
4. Offeror shall describe each fee associated with the shipping scenario
5. Offeror to fill out the portions in Yellow.

Scenario #1 - Total of 80 Points Possible

IL Intrastate, Express Overnight: 4lbs package shipped from 62629 to 60007; declared value.

Description of Fees:

Total Cost:

Scenario #2 - Total of 80 Points Possible

OH Intrastate, Ground, Residential: 15lb package shipped from 43004 to 41073; on-call pickup, same day; proof of delivery.

Description of Fees:

Total Cost:

Scenario #3 - Total of 80 Points Possible

WI Interstate, Express 2nd day: 7lb package shipped from 53702 to 53221; declared signature required; declared value, express.

Description of Fees:

Total Cost:

Scenario #4 - Total of 80 Points Possible

MI Interstate, Ground: 10lb package shipped from 48864 to 48103; with address correction surcharge.

Description of Fees:

Total Cost:

Scenario #5 - Total of 80 Points Possible

NE Interstate, Ground: 5lbs package shipped from 68501 to 68007; Saturday delivery

Description of Fees:

Total Cost:

Region 3 - Southwest

States included: Texas, Oklahoma, New Mexico, Arizona

Regional Instructions:

1. If Offeror cannot provide a cost for the scenario, put \$0.00 or leave Scenario blank.
2. Any Scenario with \$0.00 will receive no Cost Points for that line item.
3. The points assigned to each Offeror's cost proposal will be based on the lowest proposal price of each scenario. The Offeror with the lowest Proposed Price will receive 100% of the price points for that scenario. All other Offerors will receive a portion of the total cost points based on what percentage higher their Proposed Price is than the Lowest Proposed Price. An Offeror whose Proposed Price is more than double (200%) the Lowest Proposed Price will receive no points. The formula to compute the points is: $\text{Cost Points} \times (2 - \text{Proposed Price} / \text{Lowest Proposed Price})$.
4. Offeror shall describe each fee associated with the shipping scenario
5. Offeror to fill out the portions in Yellow.

Scenario #1 - Total of 80 Points Possible

TX Intrastate, Express Overnight: 4lbs package shipped from 72096 to 78006; declared value.

Description of Fees:

Total Cost:

Scenario #2 - Total of 80 Points Possible

TX Intrastate, Ground, Residential: 15lb package shipped from 76063 to 79835; on-call pickup, same day; proof of delivery.

Description of Fees:

Total Cost:

Scenario #3 - Total of 80 Points Possible

NM Interstate, Express 2nd day: 7lb package shipped from 87503 to 87101; declared signature required; declared value, express.

Description of Fees:

Total Cost:

Scenario #4 - Total of 80 Points Possible

AZ Interstate, Ground: 10lb package shipped from 85001 to 85054; with address correction surcharge.

Description of Fees:

Total Cost:

Scenario #5 - Total of 80 Points Possible

OK Interstate, Ground: 5lbs package shipped from 73008 to 74008; Saturday delivery

Description of Fees:

Total Cost:

Region 4 - Southeast

States included: West Virginia, Virginia, Kentucky, Tennessee, North Carolina, South Carolina, Georgia, Alabama, Mississippi, Arkansas, Louisiana, Florida

Regional Instructions:

1. If Offeror cannot provide a cost for the scenario, put \$0.00 or leave Scenario blank.
2. Any Scenario with \$0.00 will receive no Cost Points for that line item.
3. The points assigned to each Offeror's cost proposal will be based on the lowest proposal price of each scenario. The Offeror with the lowest Proposed Price will receive 100% of the price points for that scenario. All other Offerors will receive a portion of the total cost points based on what percentage higher their Proposed Price is than the Lowest Proposed Price. An Offeror whose Proposed Price is more than double (200%) the Lowest Proposed Price will receive no points. The formula to compute the points is: $\text{Cost Points} \times (2 - \frac{\text{Proposed Price}}{\text{Lowest Proposed Price}})$.
4. Offeror shall describe each fee associated with the shipping scenario
5. Offeror to fill out the portions in Yellow.

Scenario #1 - Total of 80 Points Possible

TN, Express, Intrastate, Commercial: 3lb. package shipped from Nashville, TN 37243 to Jackson, TN 38302 (commercial address) via Express Priority Overnight (delivery by 10:30AM), scheduled daily pick-up.

Description of Fees:

Total Cost:

Scenario #2 - Total of 80 Points Possible

FL Interstate, Ground: 10lb package shipped from 32399 to 22904; with address correction surcharge.

Description of Fees:

Total Cost:

Scenario #3 - Total of 80 Points Possible

LA Interstate, Express 2nd day: 7lb package shipped from 70801 to 70114; declared signature required; declared value, express.

Description of Fees:

Total Cost:

Scenario #4 - Total of 80 Points Possible

GA Interstate, Ground: 10lb package shipped from 30301 to 31402; with address correction surcharge.

Description of Fees:

Total Cost:

Scenario #5 - Total of 80 Points Possible

WV Interstate, Ground: 5lbs package shipped from 25301 to 25701; Saturday delivery

Description of Fees:

Total Cost:

Region 5 - Northeast

States included: Maine, Massachusetts, Rhode Island, Connecticut, New Hampshire, Vermont, New York, Pennsylvania, New Jersey, Delaware, Maryland

Regional Instructions:

1. If Offeror cannot provide a cost for the scenario, put \$0.00 or leave Scenario blank.
2. Any Scenario with \$0.00 will receive no Cost Points for that line item.
3. The points assigned to each Offeror's cost proposal will be based on the lowest proposal price of each scenario. The Offeror with the lowest Proposed Price will receive 100% of the price points for that scenario. All other Offerors will receive a portion of the total cost points based on what percentage higher their Proposed Price is than the Lowest Proposed Price. An Offeror whose Proposed Price is more than double (200%) the Lowest Proposed Price will receive no points. The formula to compute the points is: $\text{Cost Points} \times (2 - \text{Proposed Price} / \text{Lowest Proposed Price})$.
4. Offeror shall describe each fee associated with the shipping scenario
5. Offeror to fill out the portions in Yellow.

Scenario #1 - Total of 80 Points Possible

ME Intrastate, Express Overnight: 4lbs package shipped from 04609 to 04005; declared value.

Description of Fees:

Total Cost:

Scenario #2 - Total of 80 Points Possible

NY Intrastate, Ground, Residential: 15lb package shipped from 10002 to 14606; on-call pickup, same day; proof of delivery.

Description of Fees:

Total Cost:

Scenario #3 - Total of 80 Points Possible

NJ Interstate, Express 2nd day: 7lb package shipped from 07101 to 07087; declared signature required; declared value, express.

Description of Fees:

Total Cost:

Scenario #4 - Total of 80 Points Possible

MA Interstate, Ground: 10lb package shipped from 02101 to 01851; with address correction surcharge.

Description of Fees:

Total Cost:

Scenario #5 - Total of 80 Points Possible

MD Interstate, Ground: 5lbs package shipped from 20743 to 21230; Saturday delivery

Description of Fees:

Total Cost:

**SMALL PACKAGE DELIVERY SERVICE
SOLICITATION #CH21-36
RFP EVALUATION SCORESHEET**

Firm Name: _____

Evaluator: _____

Date: _____

Score will be assigned as follows:

0 = Fail, the proposal fails to address the requirements or criteria described
 1 = Poor, the proposal inadequately addresses the requirements or criteria
 2 = Unsatisfactory, the proposal addresses the requirements or criteria described
 3 = Satisfactory, the proposal addresses all requirements or criteria described
 4 = Good, the proposal addresses all requirements or criteria described in the
 5 = Excellent, the proposal addresses and exceeds all of the requirements or

Minimum Mandatory Requirements	RFP Section	Evaluation (Pass/Fail)
1 Offeror confirms in the Question Section of U3P that they have firm fixed rates. The Offeror must request any increase to the Lead State. The Lead State will review each rate increase submission and the Lead State may, utilize the PPI and CPI to reject, approve, or negotiate rate increases. The awarded Offeror will be required to submit firm rate sheets before contracts are finalized. All prices and rates must be guaranteed for one year. Following the initial one year period, any request for price or rate adjustment must be for an equal guarantee period, and must be made at sixty (60) days prior to the effective date. Requests for price or rate adjustment must include sufficient documentation supporting the request. Any adjustment or amendment to the Master Agreement shall not be effective unless approved by the Lead State. No retroactive adjustments to prices or rates will be	CH21-36 RFP, Section 2.2	
2 Offeror confirms in the Question Section of U3P that that if a fuel surcharge will be applied, an express (air) and ground cap cannot exceed 7% for the full term of the Master Agreement. Offeror's must further certify that a fuel surcharge, if any, will be published on its website so that all Authorized Users can confirm the accuracy of invoices. Offeror must further certify that its website shall also provide historical fuel surcharge information. This section is only to be used to certify that the Offeror will not exceed the 7% cap for the full term of the Master Agreement that it will publish the fuel surcharge, if any, on its website, and will provide historical fuel surcharge information on its website.	CH21-36 RFP, Section 2.2	
3 Offeror confirms in the Question Section of U3P the following regarding the exclusion of listed charges. A) The Offeror shall not propose or apply pick-up charges or weekly service in addition to the contracted rates due to aggregate NASPO ValuePoint volume anticipated. B) The Offeror shall not require a minimum number of packages per trip, per day, per week or per month.	CH21-36 RFP, Section 2.2	
4 Offeror must upload in the Question Section of U3P the Carrier's Service Guide that would be in effect at the time of Master Agreement award will be in effect for the first year of the Master Agreement with no changes in rates or charges during that time without the prior written approval of the NASPO ValuePoint Contract Administrator.	CH21-36 RFP, Section 2.2	
5 proposal that responds to the Technical Criteria outlined in Section 3.3 Technical Criteria	CH21-36 RFP, Section 2.2	
6 Offeror must upload in the Question Section of U3P their completed Attachment C: Cost Proposal.	CH21-36 RFP, Section 2.2	

Scoreable Technical Criteria	RFP Section	Evaluator Score (0-5)	Criteria Weight	% of Tech Criteria	Points Possible	Points Earned
1 Qualification of Carriers	CH21-36 RFP, Section 3.3		54	16.9%	270.0	0.0
2 Ability to Meet Scope of Work	CH21-36 RFP, Section 3.3		54	16.9%	270.0	0.0
3 Prior Experience	CH21-36 RFP, Section 3.3		39	12.2%	195.0	0.0
4 Dispute Resolution	CH21-36 RFP, Section 3.3		39	12.2%	195.0	0.0
5 Handling State Emergencies	CH21-36 RFP, Section 3.3		39	12.2%	195.0	0.0

6	Data Security	CH21-36 RFP, Section 3.3		25	7.8%	125.0	0.0	
7	Drop Boxes and Shipping Supplies	CH21-36 RFP, Section 3.3		20	6.3%	100.0	0.0	
8	Marketing Plan	CH21-36 RFP, Section 3.3		20	6.3%	100.0	0.0	
9	Green Transportation Plan	CH21-36 RFP, Section 3.3		15	4.7%	75.0	0.0	
10	Point of Contact	CH21-36 RFP, Section 3.3		15	4.7%	75.0	0.0	
						100.0%	1600.0	0.0

Required Technical Point Threshold	RFP Section	Min Percent	Min Points Required	Points Earned	Percent Earned	Evaluation
	CH21-36 RFP, Section 3.4	65%	1040.0	0.0	0.0%	

Cost	RFP Section	Low Cost Option	Offered Cost	Percent of Total	Points Possible	Points Earned
Region 1 - West	Attachment C: Cost Proposal			20%	400.0	0.0
Region 2 - Midwest	Attachment C: Cost Proposal			20%	400.0	0.0
Region 3 - Southeast	Attachment C: Cost Proposal			20%	400.0	0.0
Region 4 - Southeast	Attachment C: Cost Proposal			20%	400.0	0.0
Region 5 - Northeast	Attachment C: Cost Proposal			20%	400.0	0.0

* Purchasing will use the following cost formula: The points assigned to each offeror's cost proposal will be based on the lowest proposal price. The offeror with the lowest Proposed Price will receive 100% of the price points. All other offerors will receive a portion of the total cost points based on what percentage higher their Proposed Price is than the Lowest Proposed Price. An offeror whose Proposed Price is more than double (200%) the Lowest Proposed Price will receive no points. The formula to compute the points is: $\text{Cost Points} \times (2 - \frac{\text{Proposed Price}}{\text{Lowest Proposed Price}})$.

Total Evaluation Points	Percent of Total	Points Possible	Points Earned
Total Technical Evaluation Points	80%	1,600.0	0.0
Total Cost Evaluation Points - Region 1 - West	20%	400.0	0.0
Total Evaluation Points - Region 1 - West	100%	2,000.0	0.0
Total Cost Evaluation Points - Region 2 - Midwest	20%	400.0	0.0
Total Evaluation Points - Region 2 - Midwest	100%	2,000.0	0.0
Total Cost Evaluation Points - Region 3 - Southeast	20%	400.0	0.0
Total Evaluation Points - Region 3 - Southeast	100%	2,000.0	0.0
Total Cost Evaluation Points - Region 4 - Southeast	20%	400.0	0.0
Total Evaluation Points - Region 4 - Southeast	100%	2,000.0	0.0
Total Cost Evaluation Points - Region 5 - Northeast	20%	400.0	0.0
Total Evaluation Points - Region 5 - Northeast	100%	2,000.0	0.0



**NASPO ValuePoint
INTENT TO PARTICPATE
Cooperative Contract(s) for Small Package Delivery Services**

I. PURPOSE:

The purpose of this Agreement is to provide interested NASPO states with the opportunity to participate in multi-state cooperative contract(s) for the **Small Package Delivery Services SCOPE OF THE CONTRACT portfolio**

The State of **Utah** is authorized by agreement of the participants to act as the procurement officer in developing multi-state cooperative contract(s) for **Small Package Delivery Services**

The resulting contracts will be permissive contracts.

Administrative Fee

There will be a 0.25% NASPO ValuePoint administrative fee associated with these contracts. It is anticipated that the individual states will be able to add an administrative fee when the state executes its Participating Addendum.

II. TERM OF THE CONTRACT

The initial term of the contract will be established for **five years** from the date of award with options to extend the contract.

III. SOLICITATION AND CONTRACT DEVELOPMENT/ADDITIONAL INFORMATION

The solicitation and contract development shall be accomplished in compliance with the NASPO ValuePoint Process Guide and the NASPO Memorandum of Agreement for the NASPO cooperative purchasing program, incorporated herein by reference.

Solicitation Publication Period

Bidders/Offerors will be given at least 40 days after publication to submit proposals.

Solicitation Type and Evaluation Criteria

This RFP will be issued and evaluated in concert with the procurement laws and rules of the State of **Utah** by a sourcing team comprised of members from several states.

Award(s):

The solicitation will permit multiple awards.

Additional Requested Information

State Specific Terms and Conditions: If the participating state wishes to include any State specific terms and conditions with the release of this RFP, please attach those with this Intent to Participate.

Annual Estimated Volume: If your State has an existing contract for this commodity or service, please indicate your annual volume of spend (including any potential political subdivision usage if available).

Annual State Spend \$434,394.93

Annual Political Subdivision Spend NA

Total Spend NA

State of Alaska

Thor Vue, Chief Procurement Officer

Director Name

907-754-3533

Director Phone

Thor.Vue@alaska.gov

Director Email

Director has approved submitting the ITP? Yes No
(Click appropriate box)

State Specific T&Cs to be included in RFP? Yes No
(Click appropriate box)

Linda Polk

State Point of Contact Name and Title

907-465-8292

Phone

Linda.Polk@alaska.gov

Email

Please email completed "Intent to Participate" document by March 11, 2021 to:

Tara Larwick
Cooperative Contract Coordinator
NASPO ValuePoint
tlarwick@naspovaluepoint.org

State of Alaska Specific Terms and Conditions:

Contractor agrees to provide an Administrative Fee to the State of Alaska for all net sales made under Alaska's Participating Addendum.

- a) Contractor shall submit a check, payable to the State of Alaska, remitted to the Department of Administration, Division of General Services for the calculated amount equal to **1.5%** of the net sales for the quarterly period.
- b) Contractor must include the PA Number on the check. Those checks submitted to the State without the PA Number will be returned to Contractor for additional identifying information.
- c) Administrative fee checks shall be submitted to:

ATTN: Purchasing Section
State of Alaska
Office of Procurement and Property Management
PO Box 110214
Juneau, AK 99811-0214

- d) The administrative fee shall not be included as an adjustment to Contractor's Master Agreement pricing and shall not be invoiced or charged to the ordering agency.
- e) Payment of the administrative fee is due irrespective of payment status on any orders from a Purchasing Entity.
- f) Administrative fee checks are due for each quarter as follows:

<u>Reporting Period</u>	<u>Due Date</u>
State Fiscal Quarter 1 (Jul 1 - Sept 30):	Oct 31
State Fiscal Quarter 2 (Oct 1 - Dec 31):	Jan 31
State Fiscal Quarter 3 (Jan 1 - Mar 31):	Apr 30
State Fiscal Quarter 4 (Apr 1 - Jun 30):	Jul 31

- g) Any quarter with zero sales must be reported as zero sales. This may be done electronically via email to the State of Alaska contact listed in this PA.



**NASPO ValuePoint
INTENT TO PARTICPATE
Cooperative Contract(s) for Small Package Delivery Services**

I. PURPOSE:

The purpose of this Agreement is to provide interested NASPO states with the opportunity to participate in multi-state cooperative contract(s) for the **Small Package Delivery Services SCOPE OF THE CONTRACT portfolio**

The State of **Utah** is authorized by agreement of the participants to act as the procurement officer in developing multi-state cooperative contract(s) for **Small Package Delivery Services**

The resulting contracts will be permissive contracts.

Administrative Fee

There will be a 0.25% NASPO ValuePoint administrative fee associated with these contracts. It is anticipated that the individual states will be able to add an administrative fee when the state executes its Participating Addendum.

II. TERM OF THE CONTRACT

The initial term of the contract will be established for **five years** from the date of award with options to extend the contract.

III. SOLICITATION AND CONTRACT DEVELOPMENT/ADDITIONAL INFORMATION

The solicitation and contract development shall be accomplished in compliance with the NASPO ValuePoint Process Guide and the NASPO Memorandum of Agreement for the NASPO cooperative purchasing program, incorporated herein by reference.

Solicitation Publication Period

Bidders/Offerors will be given at least 40 days after publication to submit proposals.

Solicitation Type and Evaluation Criteria

This RFP will be issued and evaluated in concert with the procurement laws and rules of the State of **Utah** by a sourcing team comprised of members from several states.

Award(s):

The solicitation will permit multiple awards.

Additional Requested Information

State Specific Terms and Conditions: If the participating state wishes to include any State specific terms and conditions with the release of this RFP, please attach those with this Intent to Participate.

Annual Estimated Volume: If your State has an existing contract for this commodity or service, please indicate your annual volume of spend (including any potential political subdivision usage if available).

Annual State Spend \$18,103,825

Annual Political Subdivision Spend \$3,243,758

Total Spend \$21,347,583

State of California

Angela Shell

Director Name

916-375-4417

Director Phone

Angela.Shell@dgs.ca.gov

Director Email

Director has approved submitting the ITP? Yes No
(Click appropriate box)

State Specific T&Cs to be included in RFP? Yes No
(Click appropriate box)

Maureen Seiferling, State Contract Administrator

State Point of Contact Name and Title

916-376-5494

Phone

Maureen.Seiferling@dgs.ca.gov

Email

Please email completed "Intent to Participate" document by March 11, 2021 to:

Tara Larwick
Cooperative Contract Coordinator
NASPO ValuePoint
tlarwick@naspovaluepoint.org

STATE OF CALIFORNIA - ADDITIONAL TERMS

Terms and conditions listed below will be incorporated and made a part of California Participating Addenda. The State of California reserves the right to add additional terms and conditions to individual Participating Addenda.

A. Terms

- 1) General Terms and Conditions (GTC 04/2017) effective 4/4/2017. This document can be reviewed at the [DGS Office of Legal Services website](https://www.dgs.ca.gov/OLS/Resources/Page-Content/Office-of-Legal-Services-Resources-List-Folder/Standard-Contract-Language) (<https://www.dgs.ca.gov/OLS/Resources/Page-Content/Office-of-Legal-Services-Resources-List-Folder/Standard-Contract-Language>).

B. Administrative Fee

Contractor shall submit a check, payable to the State of California, remitted to the Cooperative Agreement Unit for the calculated amount equal to 1.25% of the sales for the quarterly period.

Contractor must include the Participating Addendum Number on the check. Those checks submitted to the State without the Participating Addendum Number will be returned to Contractor for additional identifying information.

Administrative fee checks shall be submitted to:

State of California
Department of General Services, Procurement Division
Attention: Cooperative Agreement Payment Processing
707 3rd Street, 2nd Floor, MS 2-202
West Sacramento, CA 95605

The administrative fee shall not be included as an adjustment to Contractor's NASPO ValuePoint Master Agreement pricing.

The administrative fee shall not be invoiced or charged to the ordering agency.

Payment of the administrative fee is due irrespective of payment status on orders or service contracts from a purchasing entity.

Administrative fee checks are due for each quarter as follows:

Reporting Period	Due Date
January 1 to March 31	April 30
April 1 to June 30	July 31
July 1 to September 30	October 31
October 1 to December 31	January 31

Failure to meet administrative fee requirements and submit fees on a timely basis shall constitute grounds for suspension of the Participating Addendum.



**NASPO ValuePoint
INTENT TO PARTICPATE
Cooperative Contract(s) for Small Package Delivery Services**

I. PURPOSE:

The purpose of this Agreement is to provide interested NASPO states with the opportunity to participate in multi-state cooperative contract(s) for the **Small Package Delivery Services SCOPE OF THE CONTRACT portfolio**

The State of **Utah** is authorized by agreement of the participants to act as the procurement officer in developing multi-state cooperative contract(s) for **Small Package Delivery Services**

The resulting contracts will be permissive contracts.

Administrative Fee

There will be a 0.25% NASPO ValuePoint administrative fee associated with these contracts. It is anticipated that the individual states will be able to add an administrative fee when the state executes its Participating Addendum.

II. TERM OF THE CONTRACT

The initial term of the contract will be established for **five years** from the date of award with options to extend the contract.

III. SOLICITATION AND CONTRACT DEVELOPMENT/ADDITIONAL INFORMATION

The solicitation and contract development shall be accomplished in compliance with the NASPO ValuePoint Process Guide and the NASPO Memorandum of Agreement for the NASPO cooperative purchasing program, incorporated herein by reference.

Solicitation Publication Period

Bidders/Offerors will be given at least 40 days after publication to submit proposals.

Solicitation Type and Evaluation Criteria

This RFP will be issued and evaluated in concert with the procurement laws and rules of the State of **Utah** by a sourcing team comprised of members from several states.

Award(s):

The solicitation will permit multiple awards.

Additional Requested Information

State Specific Terms and Conditions: If the participating state wishes to include any State specific terms and conditions with the release of this RFP, please attach those with this Intent to Participate.

Annual Estimated Volume: If your State has an existing contract for this commodity or service, please indicate your annual volume of spend (including any potential political subdivision usage if available).

Annual State Spend	\$760,000
Annual Political Subdivision Spend	\$400,000
Total Spend	\$1,160,000

State of Colorado

Sherri Maxwell
Director Name

Click here to enter text.
Director Phone

Sherri.Maxwell@state.co.us
Director Email

Director has approved submitting the ITP? Yes No
(Click appropriate box)

State Specific T&Cs to be included in RFP? Yes No
(Click appropriate box)

John Chapman
State Point of Contact Name and Title

Click here to enter text.
Phone

John.Chapman@state.co.us
Email

Please email completed "Intent to Participate" document by March 11, 2021 to:

Tara Larwick
Cooperative Contract Coordinator
NASPO ValuePoint
tlarwick@naspovaluepoint.org

COLORADO SPECIAL PROVISIONS (COLORADO FISCAL RULE 3-3)

These Special Provisions apply to all contracts except where noted in italics.

A. STATUTORY APPROVAL. §24-30-202(1), C.R.S.

This Contract shall not be valid until it has been approved by the Colorado State Controller or designee. If this Contract is for a Major Information Technology Project, as defined in §24-37.5-102(2.6), then this Contract shall not be valid until it has been approved by the State's Chief Information Officer or designee.

B. FUND AVAILABILITY. §24-30-202(5.5), C.R.S.

Financial obligations of the State payable after the current State Fiscal Year are contingent upon funds for that purpose being appropriated, budgeted, and otherwise made available.

C. GOVERNMENTAL IMMUNITY.

Liability for claims for injuries to persons or property arising from the negligence of the State, its departments, boards, commissions committees, bureaus, offices, employees and officials shall be controlled and limited by the provisions of the Colorado Governmental Immunity Act, §24-10-101, et seq., C.R.S.; the Federal Tort Claims Act, 28 U.S.C. Pt. VI, Ch. 171 and 28 U.S.C. 1346(b), and the State's risk management statutes, §§24-30-1501, et seq. C.R.S. No term or condition of this Contract shall be construed or interpreted as a waiver, express or implied, of any of the immunities, rights, benefits, protections, or other provisions, contained in these statutes.

D. INDEPENDENT CONTRACTOR

Contractor shall perform its duties hereunder as an independent contractor and not as an employee. Neither Contractor nor any agent or employee of Contractor shall be deemed to be an agent or employee of the State. Contractor shall not have authorization, express or implied, to bind the State to any agreement, liability or understanding, except as expressly set forth herein. **Contractor and its employees and agents are not entitled to unemployment insurance or workers compensation benefits through the State and the State shall not pay for or otherwise provide such coverage for Contractor or any of its agents or employees. Contractor shall pay when due all applicable employment taxes and income taxes and local head taxes incurred pursuant to this Contract. Contractor shall (i) provide and keep in force workers' compensation and unemployment compensation insurance in the amounts required by law, (ii) provide proof thereof when requested by the State, and (iii) be solely responsible for its acts and those of its employees and agents.**

E. COMPLIANCE WITH LAW.

Contractor shall comply with all applicable federal and State laws, rules, and regulations in effect or hereafter established, including, without limitation, laws applicable to discrimination and unfair employment practices.

F. CHOICE OF LAW, JURISDICTION, AND VENUE.

Colorado law, and rules and regulations issued pursuant thereto, shall be applied in the interpretation, execution, and enforcement of this Contract. Any provision included or incorporated herein by reference which conflicts with said laws, rules, and regulations shall

be null and void. All suits or actions related to this Contract shall be filed and proceedings held in the State of Colorado and exclusive venue shall be in the City and County of Denver.

G. PROHIBITED TERMS.

Any term included in this Contract that requires the State to indemnify or hold Contractor harmless; requires the State to agree to binding arbitration; limits Contractor's liability for damages resulting from death, bodily injury, or damage to tangible property; or that conflicts with this provision in any way shall be void ab initio. Nothing in this Contract shall be construed as a waiver of any provision of §24-106-109 C.R.S.

H. SOFTWARE PIRACY PROHIBITION.

State or other public funds payable under this Contract shall not be used for the acquisition, operation, or maintenance of computer software in violation of federal copyright laws or applicable licensing restrictions. Contractor hereby certifies and warrants that, during the term of this Contract and any extensions, Contractor has and shall maintain in place appropriate systems and controls to prevent such improper use of public funds. If the State determines that Contractor is in violation of this provision, the State may exercise any remedy available at law or in equity or under this Contract, including, without limitation, immediate termination of this Contract and any remedy consistent with federal copyright laws or applicable licensing restrictions.

I. EMPLOYEE FINANCIAL INTEREST/CONFLICT OF INTEREST. §§24-18-201 and 24-50-507, C.R.S.

The signatories aver that to their knowledge, no employee of the State has any personal or beneficial interest whatsoever in the service or property described in this Contract. Contractor has no interest and shall not acquire any interest, direct or indirect, that would conflict in any manner or degree with the performance of Contractor's services and Contractor shall not employ any person having such known interests.

J. VENDOR OFFSET AND ERRONEOUS PAYMENTS. §§24-30-202(1) and 24-30-202.4, C.R.S.

[Not applicable to intergovernmental agreements] Subject to §24-30-202.4(3.5), C.R.S., the State Controller may withhold payment under the State's vendor offset intercept system for debts owed to State agencies for: (i) unpaid child support debts or child support arrearages; (ii) unpaid balances of tax, accrued interest, or other charges specified in §§39-21-101, *et seq.*, C.R.S.; (iii) unpaid loans due to the Student Loan Division of the Department of Higher Education; (iv) amounts required to be paid to the Unemployment Compensation Fund; and (v) other unpaid debts owing to the State as a result of final agency determination or judicial action. The State may also recover, at the State's discretion, payments made to Contractor in error for any reason, including, but not limited to, overpayments or improper payments, and unexpended or excess funds received by Contractor by deduction from subsequent payments under this Contract, deduction from any payment due under any other contracts, grants or agreements between the State and Contractor, or by any other appropriate method for collecting debts owed to the State.

K. PUBLIC CONTRACTS FOR SERVICES. §§8-17.5-101, *et seq.*, C.R.S.

[Not applicable to agreements relating to the offer, issuance, or sale of securities, investment advisory services or fund management services, sponsored projects, intergovernmental agreements, or information technology services or products and

services] Contractor certifies, warrants, and agrees that it does not knowingly employ or contract with an illegal alien who will perform work under this Contract and will confirm the employment eligibility of all employees who are newly hired for employment in the United States to perform work under this Contract, through participation in the E-Verify Program or the State verification program established pursuant to §8-17.5-102(5)(c), C.R.S., Contractor shall not knowingly employ or contract with an illegal alien to perform work under this Contract or enter into a contract with a Subcontractor that fails to certify to Contractor that the Subcontractor shall not knowingly employ or contract with an illegal alien to perform work under this Contract. Contractor **(i)** shall not use E-Verify Program or the program procedures of the Colorado Department of Labor and Employment (“Department Program”) to undertake pre-employment screening of job applicants while this Contract is being performed, **(ii)** shall notify the Subcontractor and the contracting State agency or institution of higher education within 3 days if Contractor has actual knowledge that a Subcontractor is employing or contracting with an illegal alien for work under this Contract, **(iii)** shall terminate the subcontract if a Subcontractor does not stop employing or contracting with the illegal alien within 3 days of receiving the notice, and **(iv)** shall comply with reasonable requests made in the course of an investigation, undertaken pursuant to §8-17.5-102(5), C.R.S., by the Colorado Department of Labor and Employment. If Contractor participates in the Department program, Contractor shall deliver to the contracting State agency, Institution of Higher Education or political subdivision, a written, notarized affirmation, affirming that Contractor has examined the legal work status of such employee, and shall comply with all of the other requirements of the Department program. If Contractor fails to comply with any requirement of this provision or §§8-17.5-101, *et seq.*, C.R.S., the contracting State agency, institution of higher education or political subdivision may terminate this Contract for breach and, if so terminated, Contractor shall be liable for damages.

L. PUBLIC CONTRACTS WITH NATURAL PERSONS. §§24-76.5-101, *et seq.*, C.R.S.

Contractor, if a natural person eighteen (18) years of age or older, hereby swears and affirms under penalty of perjury that Contractor **(i)** is a citizen or otherwise lawfully present in the United States pursuant to federal law, **(ii)** shall comply with the provisions of §§24-76.5-101, *et seq.*, C.R.S., and **(iii)** has produced one form of identification required by §24-76.5-103, C.R.S. prior to the Effective Date of this Contract.



**NASPO ValuePoint
INTENT TO PARTICPATE
Cooperative Contract(s) for Small Package Delivery Services**

I. PURPOSE:

The purpose of this Agreement is to provide interested NASPO states with the opportunity to participate in multi-state cooperative contract(s) for the **Small Package Delivery Services SCOPE OF THE CONTRACT portfolio**

The State of **Utah** is authorized by agreement of the participants to act as the procurement officer in developing multi-state cooperative contract(s) for **Small Package Delivery Services**

The resulting contracts will be permissive contracts.

Administrative Fee

There will be a 0.25% NASPO ValuePoint administrative fee associated with these contracts. It is anticipated that the individual states will be able to add an administrative fee when the state executes its Participating Addendum.

II. TERM OF THE CONTRACT

The initial term of the contract will be established for **five years** from the date of award with **no** options to extend the contract.

III. SOLICITATION AND CONTRACT DEVELOPMENT/ADDITIONAL INFORMATION

The solicitation and contract development shall be accomplished in compliance with the NASPO ValuePoint Process Guide and the NASPO Memorandum of Agreement for the NASPO cooperative purchasing program, incorporated herein by reference.

Solicitation Publication Period

Bidders/Offerors will be given at least 40 days after publication to submit proposals.

Solicitation Type and Evaluation Criteria

This RFP will be issued and evaluated in concert with the procurement laws and rules of the State of **Utah** by a sourcing team comprised of members from several states.

Award(s):

The solicitation will permit multiple awards.

Additional Requested Information

State Specific Terms and Conditions: If the participating state wishes to include any State specific terms and conditions with the release of this RFP, please attach those with this Intent to Participate.

Annual Estimated Volume: If your State has an existing contract for this commodity or service, please indicate your annual volume of spend (including any potential political subdivision usage if available).

Annual State Spend	\$5,258,792.23
Annual Political Subdivision Spend	\$1,334,183.42
Total Spend	\$138,677,134.23

State of Florida

Rosalyn Ingram
Director Name

(850) 488-3049
Director Phone

Rosalyn.Ingram@dms.fl.gov
Director Email

Director has approved submitting the ITP? Yes No

State Specific T&Cs to be included in RFP? Yes No

*Florida provided recommendations via email on 3/11/2021.

Jennifer Dunkle, Purchasing Analyst
State Point of Contact Name and Title

(850) 921-0030
Phone

Jennifer.Dunkle@dms.fl.gov
Email

Please email completed "Intent to Participate" document by March 12, 2021 to:

Tara Larwick
Cooperative Contract Coordinator
NASPO ValuePoint
tlarwick@naspovaluepoint.org



**NASPO ValuePoint
INTENT TO PARTICPATE
Cooperative Contract(s) for Small Package Delivery Services**

I. PURPOSE:

The purpose of this Agreement is to provide interested NASPO states with the opportunity to participate in multi-state cooperative contract(s) for the **Small Package Delivery Services SCOPE OF THE CONTRACT portfolio**

The State of **Utah** is authorized by agreement of the participants to act as the procurement officer in developing multi-state cooperative contract(s) for **Small Package Delivery Services**

The resulting contracts will be permissive contracts.

Administrative Fee

There will be a 0.25% NASPO ValuePoint administrative fee associated with these contracts. It is anticipated that the individual states will be able to add an administrative fee when the state executes its Participating Addendum.

II. TERM OF THE CONTRACT

The initial term of the contract will be established for **five years** from the date of award with options to extend the contract.

III. SOLICITATION AND CONTRACT DEVELOPMENT/ADDITIONAL INFORMATION

The solicitation and contract development shall be accomplished in compliance with the NASPO ValuePoint Process Guide and the NASPO Memorandum of Agreement for the NASPO cooperative purchasing program, incorporated herein by reference.

Solicitation Publication Period

Bidders/Offerors will be given at least 40 days after publication to submit proposals.

Solicitation Type and Evaluation Criteria

This RFP will be issued and evaluated in concert with the procurement laws and rules of the State of **Utah** by a sourcing team comprised of members from several states.

Award(s):

The solicitation will permit multiple awards.

Additional Requested Information

State Specific Terms and Conditions: If the participating state wishes to include any State specific terms and conditions with the release of this RFP, please attach those with this Intent to Participate.

Annual Estimated Volume: If your State has an existing contract for this commodity or service, please indicate your annual volume of spend (including any potential political subdivision usage if available).

Annual State Spend Approximately \$328,000.00

Annual Political Subdivision Spend Incorporated in State spend

Total Spend Approximately \$1,260,000.00 for a 5-year contract

State of Hawaii

Bonnie Kahakui, Acting Administrator



Mar 1, 2021

Director Name

Director Signature

Date

808-586-0554

bonnie.a.kahakui@hawaii.gov

Director Phone

Director Email

Director has approved submitting the ITP? Yes No
(Click appropriate box)

State Specific T&Cs to be included in RFP? Yes No
(Click appropriate box)

Sample PA attached

State Point of Contact Name and Title

Lori Cervantes, Purchasing Specialist

lori.m.cervantes@hawaii.gov

Phone

Email

Please email completed "Intent to Participate" document by March 11, 2021 to:

Tara Larwick
Cooperative Contract Coordinator
NASPO ValuePoint
tlarwick@naspovaluepoint.org

NASPO ValuePoint
PARTICIPATING ADDENDUM



INSERT PORTFOLIO TITLE HERE

Led by the State of **insert State**

Master Agreement #: **enter number** (hereinafter "Master Agreement")

Contractor: **enter NAME (Contractor)** (hereinafter "Contractor")

Participating State: **STATE OF HAWAII** (hereinafter "Participating State")

State of Hawaii, State Procurement Office (SPO) Price List Contract No. insert VL/PL No.

This Addendum will add the State of Hawaii as a Participating State to purchase from the NASPO ValuePoint Master Agreement Number **insert contract number** with **insert contractor name**.

1. Scope: This addendum covers the **[contract title]** led by the State of **[xxxxxx]** for use by state agencies and other entities located in the Participating State of Hawaii authorized by that State's statutes to utilize State contracts.
2. Participation: All jurisdictions located within the State of Hawaii, which have obtained prior written approval by its Chief Procurement Officer, will be allowed to purchase from the Master Agreement. Private nonprofit health or human services organizations with current purchase of service contracts governed by Hawaii Revised Statutes (HRS) chapter 103F are eligible to participate in the SPO price/vendor list contracts upon mutual agreement between the Contractor and the non-profit. (Each such participating jurisdiction and participating nonprofit is hereinafter referred to as a "Participating Entity"). Issues of interpretation and eligibility for participation are solely within the authority of the Administrator, State Procurement Office.
3. Primary Contacts: The primary contact individuals for this Participating Addendum are as follows (or their named successors):

Contractor

Name:	Name
Address:	Address
Telephone:	Phone
Fax:	Fax
Email:	email

NASPO ValuePoint
PARTICIPATING ADDENDUM



INSERT PORTFOLIO TITLE HERE

Led by the State of **insert State**

Participating State

Name:	Name of Purchasing Specialist
Address:	State Procurement Office 1151 Punchbowl Street, Room 416 Honolulu, HI 98613
Telephone:	Phone Number
Fax:	(808) 586-0540
Email:	Purchasing Specialist E-mail Address

4. Participating State Modifications or Additions to the Master Agreement: These modifications or additions apply only to actions and relationships within the Participating State and its Entities.

The following changes are modifying or supplementing the Master Agreement terms and conditions.

Changes:

- A. Usage Reports. Contractor shall submit a quarterly gross sales report (including zero-dollar sales) in EXCEL to the contact person listed in the Participating Addendum, Paragraph 3 (or as amended) in accordance with the following schedule (or as requested):

<u>Quarter Ending</u>	<u>Report Due</u>
March 31	April 30
June 30	July 31
September 30	October 31
December 31	January 31

The report shall identify each transaction and include the following information:

Department/Agency Name
Date of Purchase
Product/Service Description
Quantity
Unit of Measure
Item No. Part Number (if applicable)
MSRP List Price
NASPO ValuePoint Contract Price

NASPO ValuePoint
PARTICIPATING ADDENDUM



INSERT PORTFOLIO TITLE HERE

Led by the State of **insert State**

The quarterly report shall also include any adjustment from prior periods (i.e. exchanges and/or return).

- B. The validity of this Addendum, any of its terms or provisions, as well as the right and duties of the parties in this Addendum, shall be governed by the laws of the State of Hawaii. A copy of the Attorney General's General Conditions, which is made a part of this Addendum, can be found at <https://spo.hawaii.gov/wp-content/uploads/2017/12/AG-008-103D-1.pdf>. Any action at law or in equity to enforce or interpret the provisions of this Addendum shall be brought in a court of competent jurisdiction in Honolulu, Hawaii.
- C. **Inspection of Facilities.** Pursuant to HRS § 103D-316, the Participating State, at reasonable times, may inspect the part of the plant or place of business of the Contractor or any subcontractor that is related to the performance of a Master Agreement and this Addendum.
- D. **Campaign Contributions.** The Contractor is notified of the applicability of HRS § 11-355, which prohibits campaign contributions from Contractor during the term of the Addendum if the contractor is paid with funds appropriated by the Hawaii State Legislature.
- E. **Purchases by State of Hawaii government entities under this Master Agreement is not mandatory.** This Addendum is secondary and non-exclusive.
- F. **The State of Hawaii's purchasing card (pCard) is required to be used by the State's executive departments/agencies (excluding the Department of Education, the Hawaii Health System Corporation, the Office of Hawaiian Affairs, and the University of Hawaii) for all orders totaling less than \$2,500. For purchases of \$2,500 or more, agencies may use the pCard, subject to its credit limit or issue a purchase order.**
- G. Pursuant to HRS §103D-310(c), if Contractor is doing business in the Participating State, Contractor is required to comply with all laws governing entities doing business in the Participating State, including the following HRS chapters.
1. Chapter 237, General Excise Tax Law;
 2. Chapter 383, Hawaii Employment Security Law;
 3. Chapter 386, Workers' Compensation;
 4. Chapter 392, Temporary Disability Insurance;
 5. Chapter 393, Prepaid Health Care Act; and

A Certificate of Good Standing is required for entities doing business in the State.

The Hawaii Compliance Express (HCE) is utilized for verification of compliance. The SPO will conduct periodic checks to confirm Contractor's compliance on HCE throughout the term of the Addendum.

NASPO ValuePoint

PARTICIPATING ADDENDUM**INSERT PORTFOLIO TITLE HERE**Led by the State of **insert State**

Alternatively, Contractors not utilizing HCE to demonstrate compliance shall provide paper certificates to the SPO as instructed below. All certificates must be valid on the date it is received by the SPO. All applications for applicable clearances are the responsibility of the Contractor.

HRS Chapter 237 tax clearance requirement. Pursuant to Section 103D-328, HRS, Contractor shall be required to submit a tax clearance certificate issued by the Hawaii State Department of Taxation (DOTAX) and the Internal Revenue Service (IRS). The certificate shall have an original green certified copy stamp and shall be valid for six (6) months from the most recent approval stamp date on the certificate.

The Tax Clearance Application, Form A-6, and its completion and filing instructions, are available on the DOTAX website: <http://tax.hawaii.gov/forms/>.

HRS Chapters 383 (Unemployment Insurance), 386 (Workers' Compensation), 392 (Temporary Disability Insurance), and 393 (Prepaid Health Care) requirements. Pursuant to Section 103D-310(c) Contractor shall be required to submit a certificate of compliance issued by the Hawaii State Department of Labor and Industrial Relations (DLIR). The certificate is valid for six (6) months from the date of issue. A photocopy of the certificate is acceptable to the SPO.

The DLIR Form LIR#27 Application for Certificate of Compliance with Section 3-122-112, HAR, and its filing instructions are available on the DLIR website: <http://labor.hawaii.gov/forms/>.

Compliance with Section 103D-310(c), HRS, for an entity doing business in the State. Contractor shall be required to submit a Certificate of Good Standing (COGS) issued by the State of Hawaii Department of Commerce and Consumer Affairs (DCCA) – Business Registration Division (BREG). The Certificate is valid for six (6) months from date of issue. A photocopy of the certificate is acceptable to the SPO.

To obtain the Certificate, the Contractor must be registered with the BREG. A sole proprietorship is not required to register with the BREG and is therefore not required to submit the certificate.

For more information regarding online business registration and the COGS is available at <http://cca.hawaii.gov/breg/>.

- H. Effective Date and Contract Period. This Addendum is effective upon the date of execution by the Participating State and shall continue for the term set forth in the Master Agreement.

NASPO ValuePoint
PARTICIPATING ADDENDUM



INSERT PORTFOLIO TITLE HERE

Led by the State of **insert State**

I. Licensing

Contractors must be properly licensed and capable of performing the Work as described in the Master Agreement, in accordance with the Professional and Vocational licensing laws of the state. Contractors under Participating Addendums must maintain any and all required licenses through the duration of the contract and Participating Addendum.

J. Insurance

The Contractor shall maintain in full force and effect during the life of this contract, liability and property damage insurance to protect the Contractor and his Subcontractors, if any, from claims for damages for personal injury, accidental death and property damage which may arise from operations under this contract, whether such operations be by the Contractor or by Subcontractor or anyone directly or indirectly employed by either of them. If any Subcontractor is involved, the insurance policy or policies shall name the Subcontractor as additional insured.

As an alternative to the Contractor providing insurance to cover operations performed by a Subcontractor and naming the Subcontractor as additional insured, the Contractor may require the Subcontractor to provide its own insurance, which meets the requirements herein. It is understood that a Subcontractor's insurance policy or policies are in addition to the Contractor's own policy or policies.

The following minimum insurance coverage(s) and limit(s) shall be provided by the Contractor, including its Subcontractor(s) where appropriate.

Coverage

Limits

Commercial General Liability (occurrence form)	\$1,000,000 per occurrence \$2,000,000 aggregate
Automobile Liability	\$1,000,000 per accident
Professional Liability	\$1,000,000 per claim \$2,000,000 aggregate

Professional Liability shall be required from Contractors providing professional services requiring a license to conduct its business such as an engineer, architect, accountant, lawyer, information technology services etc. Use as applicable.

Cyber Liability covering claims and losses with respect to network, internet (Cloud) or other data disclosure risks (such as data breaches, releases of Confidential

NASPO ValuePoint
PARTICIPATING ADDENDUM



INSERT PORTFOLIO TITLE HERE

Led by the State of **insert State**

Information, unauthorize access/use of information, and identity theft) within limits of not less than \$1,000,000 per claim and \$2,000,000 aggregate. – use as applicable

Each insurance policy required by this contract (with the exception of the **Professional Liability policy-use as applicable**), including a Subcontractor's policy, shall contain the following clauses:

- A. "The State of Hawaii is added as an additional insured as respects to operations performed for the State of Hawaii."
- B. "It is agreed that any insurance maintained by the State of Hawaii will apply in excess of, and not contribute with, insurance provided by this policy."

A Waiver of Subrogation shall apply to the General Liability, Automobile Liability and Worker's Compensation insurance policies and shall be in favor of the State of Hawaii.

The Contractor agrees to deposit with the State of Hawaii certificate(s) of insurance necessary to satisfy the State that the insurance provisions of this Addendum and have been complied with and to keep such insurance in effect and the certificate(s) therefore on deposit with the State during the entire term of the price/vendor list and price/vendor list extensions, if any, including those of its Subcontractor(s), where appropriate. Upon request by the State, Contractor shall be responsible for furnishing a copy of the policy or policies.

Failure of the Contractor to provide and keep in force such insurance shall be regarded as material default, entitling the State to exercise any or all of the remedies provided in the contract and this RFP for a default by the Contractor.

The procuring of such required insurance shall not be construed to limit the Contractor's liability hereunder nor to fulfill the indemnification provisions and requirements of this RFP. Notwithstanding said policy or policies of insurance, the Contractor shall be obliged for the full and total amount of any damage, injury, or loss caused by negligence or neglect connected with this price list.

- 5. Lease Agreements: Leasing is not authorized by this Addendum. **Adjust as applicable.**
- 6. Subcontractors: All contactors, dealers, and resellers authorized in the State of **insert Lead State**, as shown on the dedicated Contractor (cooperative contract) website, are approved to provide sales and service support to participants in the NASPO ValuePoint Master Agreement. The contractor's dealer participation will be in accordance with the terms and conditions set forth in the aforementioned Master Agreement. Subcontractors are **(or are not)** allowed under this Addendum.

NASPO ValuePoint
PARTICIPATING ADDENDUM



INSERT PORTFOLIO TITLE HERE

Led by the State of **insert State**

7. Orders: Any order placed by a Participating Entity or Purchasing Entity for a product and/or service available from this Master Agreement shall be deemed to be a sale under (and governed by the prices and other terms and conditions) of the Master Agreement unless the parties to the order agree in writing that another contract or agreement applies to such order.

8. Freight Charges (unless otherwise stated in the master contract):

Prices proposed will be the delivered price to any state agency or political subdivision. All deliveries will be F.O.B. destination with all transportation and handling charges paid by the Contractor. Responsibility and liability for loss or damage will remain with Contractor until final inspection and acceptance when responsibility will pass to the Buyer except as to latent defects, fraud, and Contractor's warranty obligations. Any portion of a full order originally shipped without transportation charges (that failed to ship with the original order, thereby becoming back-ordered) will also be shipped without transportation charges.

9. Purchase Order and Payment Instructions:

All purchase orders issued by Participating Entities under this Addendum shall include the Participating State contract number: SPO Price List Contract No. **add number** and the NASPO ValuePoint Master Agreement Number **add number**.

Purchase Orders and Payments shall be made to **add contractor name** or authorized subcontractors, if any.

Invoices and Payment Instructions:

Contractor(s) shall forward original invoice(s), directly to the ordering agency. The GET or use tax and county surcharge may be added to the invoice as a separate line item and shall not exceed the current max pass-on tax rate(s) for each island.

County surcharges on state general excise (GE) tax or Use tax may be visibly passed on but is not required. For more information on county surcharges and the max pass-on tax rate, please visit the Department of Taxation's website at <http://tax.hawaii.gov/geninfo/countysurcharge>.

Pursuant to HRS § 103-10, Participating State and any agency of the Participating State or any county, shall have thirty (30) calendar days after receipt of invoice or satisfactory delivery of goods to make payment. Any interest for delinquent payment shall be as allowed by HRS § 103-10.

10. Participating Entity as Individual Customer:

Each Participating Entity shall be treated as an individual customer. Except to the extent modified by this Addendum, each Participating Entity will be responsible to follow the

NASPO ValuePoint
PARTICIPATING ADDENDUM



INSERT PORTFOLIO TITLE HERE

Led by the State of **insert State**

terms and conditions of the Master Agreement; and will have the same rights and responsibilities for their purchases as the Lead State has in the Master Agreement. Each Participating Entity will be responsible for its own charges, fees, and liabilities. Each Participating Entity will have the same rights to any indemnity or to recover any costs allowed in the Master Agreement for their purchases. The Contractor will apply the charges to each Participating Entity individually.

11. Entire Contract:

This Addendum, the Master Agreement, and the Attorney General's General Conditions, set forth the entire agreement, and all the conditions, understandings, promises, warranties and representations among the parties with respect to this Addendum and the Master Agreement, and supersedes any prior communications, representations or agreements whether, oral or written, with respect to the subject matter hereof.

Terms and conditions inconsistent with, contrary or in addition to the terms and conditions of this Addendum, the Master Agreement, and the Attorney General's General Conditions that are included in any purchase order or other document shall be void. The terms and conditions of this Addendum, the Master Agreement, and the Attorney General's General Conditions, shall govern in the case of any such inconsistent, contrary, or additional terms.

IN WITNESS WHEREOF, the parties have executed this Addendum as of the date of execution by both parties below.

Participating State: STATE OF HAWAII	Contractor:
Signature:	Signature:
Name: SARAH ALLEN	Name:
Title: Administrator, SPO	Title:
Date:	Date:

NASPO ValuePoint
PARTICIPATING ADDENDUM



INSERT PORTFOLIO TITLE HERE

Led by the State of **insert State**

APPROVED AS TO FORM:

Deputy Attorney General

For questions on executing a participating addendum, please contact:

NASPO ValuePoint

Cooperative Development Coordinator:	Name
Telephone:	Phone
Email:	email

[Please email fully executed PDF copy of this document to
PA@naspovaluepoint.org
to support documentation of participation and posting in appropriate data bases.]

SAMPLE



**NASPO ValuePoint
INTENT TO PARTICPATE
Cooperative Contract(s) for Small Package Delivery Services**

I. PURPOSE:

The purpose of this Agreement is to provide interested NASPO states with the opportunity to participate in multi-state cooperative contract(s) for the **Small Package Delivery Services SCOPE OF THE CONTRACT portfolio**

The State of **Utah** is authorized by agreement of the participants to act as the procurement officer in developing multi-state cooperative contract(s) for **Small Package Delivery Services**

The resulting contracts will be permissive contracts.

Administrative Fee

There will be a 0.25% NASPO ValuePoint administrative fee associated with these contracts. It is anticipated that the individual states will be able to add an administrative fee when the state executes its Participating Addendum.

II. TERM OF THE CONTRACT

The initial term of the contract will be established for **five years** from the date of award with **no** options to extend the contract.

III. SOLICITATION AND CONTRACT DEVELOPMENT/ADDITIONAL INFORMATION

The solicitation and contract development shall be accomplished in compliance with the NASPO ValuePoint Process Guide and the NASPO Memorandum of Agreement for the NASPO cooperative purchasing program, incorporated herein by reference.

Solicitation Publication Period

Bidders/Offerors will be given at least 40 days after publication to submit proposals.

Solicitation Type and Evaluation Criteria

This RFP will be issued and evaluated in concert with the procurement laws and rules of the State of **Utah** by a sourcing team comprised of members from several states.

Award(s):

The solicitation will permit multiple awards.

Additional Requested Information

State Specific Terms and Conditions: If the participating state wishes to include any State specific terms and conditions with the release of this RFP, please attach those with this Intent to Participate.

Annual Estimated Volume: If your State has an existing contract for this commodity or service, please indicate your annual volume of spend (including any potential political subdivision usage if available).

Annual State Spend Approximately \$1,000,000.00

Annual Political Subdivision Spend Unknown

Total Spend Approximately \$5,000,000.00 for a 5-year contract

State of Idaho

Chelsea Robillard, State Purchasing Manager

Valerie Bollinger, Administrator

Director Name

208-332-1607

chelsea.robillard@adm.idaho.gov

208-332-1631

valerie.bollinger@adm.idaho.gov

Director Phone

Director Email

Director has approved submitting the ITP? Yes No
(Click appropriate box)

State Specific T&Cs to be included in RFP? Yes No
(Click appropriate box)

Idaho has a quarterly 1.25% administrative fee.

State Point of Contact Name and Title

Joseph Nelson, Purchasing Officer [Click here to enter text.](#)

Phone 208-332-1602

Email joseph.nelson@adm.idaho.gov

Please email completed "Intent to Participate" document by March 11, 2021 to:

Tara Larwick

Cooperative Contract Coordinator

NASPO ValuePoint

tlarwick@naspovaluepoint.org



**NASPO ValuePoint
INTENT TO PARTICPATE
Cooperative Contract(s) for Small Package Delivery Services**

I. PURPOSE:

The purpose of this Agreement is to provide interested NASPO states with the opportunity to participate in multi-state cooperative contract(s) for the **Small Package Delivery Services SCOPE OF THE CONTRACT portfolio**

The State of **Utah** is authorized by agreement of the participants to act as the procurement officer in developing multi-state cooperative contract(s) for **Small Package Delivery Services**

The resulting contracts will be permissive contracts.

Administrative Fee

There will be a 0.25% NASPO ValuePoint administrative fee associated with these contracts. It is anticipated that the individual states will be able to add an administrative fee when the state executes its Participating Addendum.

II. TERM OF THE CONTRACT

The initial term of the contract will be established for **five years** from the date of award with options to extend the contract.

III. SOLICITATION AND CONTRACT DEVELOPMENT/ADDITIONAL INFORMATION

The solicitation and contract development shall be accomplished in compliance with the NASPO ValuePoint Process Guide and the NASPO Memorandum of Agreement for the NASPO cooperative purchasing program, incorporated herein by reference.

Solicitation Publication Period

Bidders/Offerors will be given at least 40 days after publication to submit proposals.

Solicitation Type and Evaluation Criteria

This RFP will be issued and evaluated in concert with the procurement laws and rules of the State of **Utah** by a sourcing team comprised of members from several states.

Award(s):

The solicitation will permit multiple awards.

Additional Requested Information

State Specific Terms and Conditions: If the participating state wishes to include any State specific terms and conditions with the release of this RFP, please attach those with this Intent to Participate.



**NASPO ValuePoint
INTENT TO PARTICPATE
Cooperative Contract(s) for Small Package Delivery Services**

I. PURPOSE:

The purpose of this Agreement is to provide interested NASPO states with the opportunity to participate in multi-state cooperative contract(s) for the **Small Package Delivery Services SCOPE OF THE CONTRACT portfolio**

The State of **Utah** is authorized by agreement of the participants to act as the procurement officer in developing multi-state cooperative contract(s) for **Small Package Delivery Services**

The resulting contracts will be permissive contracts.

Administrative Fee

There will be a 0.25% NASPO ValuePoint administrative fee associated with these contracts. It is anticipated that the individual states will be able to add an administrative fee when the state executes its Participating Addendum.

II. TERM OF THE CONTRACT

The initial term of the contract will be established for **five years** from the date of award with options to extend the contract.

III. SOLICITATION AND CONTRACT DEVELOPMENT/ADDITIONAL INFORMATION

The solicitation and contract development shall be accomplished in compliance with the NASPO ValuePoint Process Guide and the NASPO Memorandum of Agreement for the NASPO cooperative purchasing program, incorporated herein by reference.

Solicitation Publication Period

Bidders/Offerors will be given at least 40 days after publication to submit proposals.

Solicitation Type and Evaluation Criteria

This RFP will be issued and evaluated in concert with the procurement laws and rules of the State of **Utah** by a sourcing team comprised of members from several states.

Award(s):

The solicitation will permit multiple awards.

Additional Requested Information

State Specific Terms and Conditions: If the participating state wishes to include any State specific terms and conditions with the release of this RFP, please attach those with this Intent to Participate.

Annual Estimated Volume: If your State has an existing contract for this commodity or service, please indicate your annual volume of spend (including any potential political subdivision usage if available).

Annual State Spend \$5,000,000

Annual Political Subdivision Spend [Click here to enter text.](#)

Total Spend \$25,000,000 over 5 years

State of [Maryland](#)

[Robert Gleason](#)
Director Name

[443-462-7590](#)
Director Phone

robert.gleason@maryland.gov
Director Email

Director has approved submitting the ITP? Yes No
(Click appropriate box)

State Specific T&Cs to be included in RFP? Yes No
(Click appropriate box)

Maryland State Admin Fee: Estimated at 1%, but any fee will be determined at such time Maryland may elect to negotiate any Participating Addendum. Maryland State specific Ts&Cs attached.

State Point of Contact Name and Title

Fred C. Payne, Leader Vendor Management Office, Office of State Procurement

[Fred C. Payne](#)
Phone

fred.payne@maryland.gov
Email

Please email completed "Intent to Participate" document by March 11, 2021 to:

Tara Larwick
Cooperative Contract Coordinator
NASPO ValuePoint
tlarwick@naspovaluepoint.org

Title 21
STATE PROCUREMENT REGULATIONS

Subtitle 07 CONTRACT TERMS AND CONDITIONS

Chapter 01 Mandatory Contract Provisions — All Contracts (except as provided under COMAR 21.05.07, 21.07.02, and 21.07.03)

Authority: Election Law Article, §§14-101—14-108; General Provisions Article, §§5-101 and 5-503;
State Finance and Procurement Article, §§12-101, 13-211, 13-217—13-219, 13-221—13-223, 13-317, 16-202, 17-401, 17-402, and 19-114;
Annotated Code of Maryland; Chs. 588, 589, and 630, Acts of 2017

.01 Parties to the Contract.

Mandatory provision for all contracts.

.02 Scope of Contract.

Mandatory provision for all contracts. This provision shall reflect the unilateral right of the State to order in writing changes in the work within the scope of the contract.

.03 Compensation and Method of Payment.

Mandatory provision for all contracts. The contractor's taxpayer identification number consisting of the Social Security number for individuals and sole proprietors and the federal employer identification number for all other types of organizations shall be indicated in this clause.

.04 Contract Modifications.

Mandatory provision for all contracts.

.05 Non-Hiring of Officials and Employees.

Mandatory provision for all contracts: "No official or employee of the State of Maryland, as defined under General Provisions Article, §5-101, Annotated Code of Maryland, whose duties as such official or employee include matters relating to or affecting the subject matter of this contract, shall during the pendency and term of this contract and while serving as an official or employee of the State become or be an employee of the contractor or any entity that is a subcontractor on this contract."

.06 Disputes.

Mandatory provision for all contracts. One of the following clauses is preferred:

A. Alternate Disputes Clause (short form). "This contract shall be subject to the provisions of State Finance and Procurement Article, Title 15, Subtitle 2, Annotated Code of Maryland, and COMAR 21.10 (Administrative and Civil Remedies). Pending resolution of a claim, the Contractor shall proceed diligently with the performance of the contract in accordance with the procurement officer's decision."

B. Alternate Disputes Clause (long form).

"(1) This contract is subject to the provisions of State Finance and Procurement Article, Title 15, Subtitle 2, Annotated Code of Maryland and COMAR 21.10 (Administrative and Civil Remedies).

(2) Except as otherwise may be provided by law, all disputes arising under or as a result of a breach of this contract that are not disposed of by mutual agreement shall be resolved in accordance with this clause.

(3) As used herein, "claim" means a written demand or assertion by one of the parties seeking, as a legal right, the payment of money, adjustment or interpretation of contract terms, or other relief, arising under or relating to this contract. A voucher, invoice, or request for payment that is not in dispute when submitted is not a claim under this clause. However, if the submission subsequently is not acted upon in a reasonable time, or is disputed as to liability or amount, it may be converted to a claim for the purpose of this clause.

(4) A claim shall be made in writing and submitted to the procurement officer for decision in consultation with the Office of the Attorney General.

(5) When a claim cannot be resolved by mutual agreement, the contractor shall submit a written request for final decision to the procurement officer. The written request shall set forth all the facts surrounding the controversy.

(6) The contractor, at the discretion of the procurement officer, may be afforded an opportunity to be heard and to offer evidence in support of his claim.

STATE PROCUREMENT REGULATIONS

21.07.01.07

(7) The procurement officer shall render a written decision on all claims within 180 days of receipt of the contractor's written claim, unless the procurement officer determines that a longer period is necessary to resolve the claim. If a decision is not issued within 180 days, the procurement officer shall notify the contractor of the time within which a decision shall be rendered and the reasons for such time extension. The decision shall be furnished to the contractor, by certified mail, return receipt requested, or by any other method that provides evidence of receipt. The procurement officer's decision shall be deemed the final action of the State.

(8) The procurement officer's decision shall be final and conclusive unless the contractor mails or otherwise files a written appeal with the Maryland State Board of Contract Appeals within 30 days of receipt of the decision.

(9) Pending resolution of a claim, the contractor shall proceed diligently with the performance of the contract in accordance with the procurement officer's decision."

.07 Maryland Law Prevails.

Mandatory provision for all contracts unless otherwise authorized by the Board of Public Works.

.08 Nondiscrimination in Employment.

Mandatory provision for all contracts. The following clause is preferred:

"The Contractor agrees:(a) not to discriminate in any manner against an employee or applicant for employment because of race, color, religion, creed, age, sex, sexual orientation, gender identification, marital status, national origin, ancestry genetic information or any otherwise unlawful use of characteristics, or disability of a qualified individual with a disability unrelated in nature and extent so as to reasonably preclude the performance of the employment, or the individual's refusal to submit to a genetic test or make available the results of a genetic test; (b) to include a provision similar to that contained in subsection(a), above, in any underlying subcontract except a subcontract for standard commercial supplies or raw materials; and (c) to post and to cause subcontractors to post in conspicuous places available to employees and applicants for employment, notices setting forth the substance of this clause."

.09 Contingent Fee Prohibition.

Mandatory provision for all contracts:

"The contractor, architect, or engineer (as applicable) warrants that it has not employed or retained any person, partnership, corporation, or other entity, other than a bona fide employee or agent working for the contractor, architect, or engineer, to solicit or secure this agreement, and that it has not paid or agreed to pay any person, partnership, corporation, or other entity, other than a bona fide employee or agent, any fee or any other consideration contingent on the making of this agreement."

.10 Multi-Year Contracts Contingent Upon Appropriations.

Mandatory provision for all contracts and contract modifications to be effective in more than one fiscal year:

"If the General Assembly fails to appropriate funds or if funds are not otherwise made available for continued performance for any fiscal period of this Contract succeeding the first fiscal period, this Contract shall be cancelled automatically as of the beginning of the fiscal year for which funds were not appropriated or otherwise made available; provided, however, that this will not affect either the State's rights or the Contractor's rights under any termination clause in this Contract. The effect of termination of the Contract hereunder will be to discharge both the Contractor and the State from future performance of the Contract, but not from their rights and obligations existing at the time of termination. The Contractor shall be reimbursed for the reasonable value of any non-recurring costs incurred but not amortized in the price of the Contract. The State shall notify the Contractor as soon as it has knowledge that funds may not be available for the continuation of this Contract for each succeeding fiscal period beyond the first."

.11 Termination for Default.

Mandatory provision for all contracts. One of the following clauses is preferred:

A. Alternate Clause — Termination for Default (short form).

"If the Contractor fails to fulfill its obligation under this contract properly and on time, or otherwise violates any provision of the contract, the State may terminate the contract by written notice to the Contractor. The notice shall specify the acts or omissions relied upon as cause for termination. All finished or unfinished work provided by the Contractor shall, at the State's option, become the State's property. The State shall pay the Contractor fair and equitable compensation for satisfactory

CONTRACT TERMS AND CONDITIONS

21.07.01.11

performance prior to receipt of notice of termination, less the amount of damages caused by Contractor's breach. If the damages are more than the compensation payable to the Contractor, the Contractor will remain liable after termination and the State can affirmatively collect damages. Termination hereunder, including the determination of the rights and obligations of the parties, shall be governed by the provisions of COMAR 21.07.01.11B."

B. Alternate Clause — Termination for Default (long form).

"(1) The State may, subject to the provisions of paragraph (3) of this regulation, by written notice of default to the Contractor, terminate the whole or any part of this contract in any one of the following circumstances:(a) If the Contractor fails to perform within the time specified herein or any extension thereof; or (b) If the Contractor fails to perform any of the other provisions of this contract, or so fails to make progress as to endanger performance of this contract in accordance with its terms, and in either of these two circumstances does not cure such failure within a period of 10 days (or such longer period as the procurement officer may authorize in writing) after receipt of notice from the procurement officer specifying such failure.

"(2) In the event the State terminates this contract in whole or in part as provided in paragraph(1) of this clause, the State may procure substitute performance upon terms and in whatever manner the procurement officer may deem appropriate, and the Contractor shall be liable to the State for any excess costs for substitute performance; provided, that the Contractor shall continue the performance of this contract to the extent not terminated under the provisions of this clause.

"(3) Except with respect to defaults of subcontractors, the Contractor shall not be liable for any excess costs if the failure to perform the contract arises out of causes beyond the control and without the fault or negligence of the Contractor. Such causes may include, but are not restricted to, acts of God or of the public enemy, acts of the State in either its sovereign or contractual capacity, fires, floods, epidemics, quarantine restrictions, strikes, freight embargoes, and unusually severe weather; but in every case the failure to perform shall be beyond the control and without the fault or negligence of the Contractor. If the failure to perform is caused by the default of a subcontractor, and if the default arises out of causes beyond the control of both the Contractor and subcontractor, and without the fault or negligence of either of them, the Contractor shall not be liable for any excess costs for failure to perform unless substitute performance for the subcontractor was obtainable from another source in sufficient time to permit the Contractor to meet the performance schedule.

"(4) If, after notice of termination of this contract under the provisions of this clause, it is determined for any reason that the Contractor was not in default under the provisions of this clause, or that the default was excusable under the provisions of this clause, the rights and obligations of the parties shall, if the contract contains a clause providing for termination for convenience of the State, be the same as if the notice of termination had been issued pursuant to such clause. If, after notice of termination of this contract under the provisions of this clause, it is determined for any reason that the Contractor was not in default under the provisions of this clause, and if this contract does not contain a clause providing for termination for convenience of the State, the contract shall be equitably adjusted to compensate for such termination and the contract modified accordingly; failure to agree to any such adjustment shall be a dispute concerning a question of fact within the meaning of the clause of this contract entitled "Disputes."

"(5) If this contract is terminated as provided in paragraph(1) of this clause, the State, in addition to any other rights provided in this clause, may require the Contractor to transfer title and deliver to the State, in the manner, at the times, and to the extent, if any, directed by the procurement officer,(a) the fabricated or unfabricated parts, work in progress, completed work, supplies, and other material produced as a part of, or acquired in connection with the performance of, the work terminated by the Notice of Termination, and (b) the completed or partially completed plans, drawings, information, and other property which, if the contract had been completed, would have been required to be furnished to the State; and the Contractor shall, upon direction of the procurement officer, protect and preserve property in the possession of the Contractor in which the State has an interest. Payment for completed supplies delivered to and accepted by the State shall be at the contract price. Payment for manufacturing materials delivered to and accepted by the State and for the protection and preservation of property shall be in an amount agreed upon by the Contractor and procurement officer; failure to agree to such amount shall be a dispute concerning a question of fact within the meaning of the clause of this contract entitled "Disputes." The State may withhold from amounts otherwise due the Contractor hereunder such sum as the procurement officer determines to be necessary to protect the State against loss because of outstanding liens or claims of former lien holders.

"(6) The rights and remedies of the State provided in this clause shall not be exclusive and are in addition to any other rights and remedies provided by law or under this contract.

STATE PROCUREMENT REGULATIONS

21.07.01.12

"(7) As used in paragraph (3) of this clause, the terms, "subcontractor" and "subcontractors" mean subcontractor(s) at any tier."

.12 Termination for Convenience.

A. Except as provided in §B of this regulation, mandatory provision for all contracts. One of the following clauses is preferred:

(1) Alternate Clause — Termination for Convenience (short form).

"The performance of work under this contract may be terminated by the State in accordance with this clause in whole, or from time to time in part, whenever the State shall determine that such termination is in the best interest of the State. The State will pay all reasonable costs associated with this contract that the Contractor has incurred up to the date of termination and all reasonable costs associated with termination of the Contract. However, the Contractor shall not be reimbursed for any anticipatory profits that have not been earned up to the date of termination. Termination hereunder, including the determination of the rights and obligations of the parties, shall be governed by the provisions of COMAR 21.07.01.12A(2)."

(2) Alternate Clause — Termination for Convenience (long form).

"(1) The performance of work under this contract may be terminated by the State in accordance with this clause in whole, or from time to time in part, whenever the State shall determine that such termination is in the best interest of the State. Any such termination shall be effected by delivery to the Contractor of a Notice of Termination specifying the extent to which performance of work is terminated and the time when such termination becomes effective.

"(2) After receipt of a Notice of Termination, and except as otherwise directed by the procurement officer, the Contractor shall:

(a) stop work as specified in the Notice of Termination;

(b) place no further orders or subcontracts for materials, services or facilities, except as may be necessary for completion of the portion of the work under the contract as is not terminated;

(c) terminate all orders and subcontracts to the extent that they relate to the performance of work terminated by the Notice of Termination;

(d) assign to the State, in the manner, at times, and to the extent directed by the procurement officer, all of the right, title, and interest of the Contractor under the orders and subcontracts so terminated, in which case the State shall have the right, in its discretion, to settle or pay any or all claims arising out of the termination of such orders and subcontracts;

(e) settle all outstanding liabilities and all claims arising out of such termination of orders and subcontracts, with the approval or ratification of the procurement officer, to the extent he may require, which approval or ratification shall be final for all the purposes of this clause;

(f) transfer title and deliver to the State, in the manner, at the times, and to the extent, if any, directed by the procurement officer, (i) the fabricated or unfabricated parts, work in process, completed work, supplies, and other material produced as a part of, or acquired in connection with the performance of, the work terminated by the Notice of Termination, and (ii) the completed or partially completed plans, drawings, information, and other property which, if the contract had been completed, would have been required to be furnished to the State;

(g) use its best efforts to sell, in the manner, at the times, to the extent, and at the price or prices directed or authorized by the procurement officer, any property of the types referred to in (f) above; provided, however, that the Contractor (i) may not be required to extend credit to any purchaser, and (ii) may acquire any such property under the conditions prescribed by and at a price or prices approved by the procurement officer; and provided further that the proceeds of any such transfer or disposition shall be applied in reduction of any payments to be made by the State to the Contractor under this contract or shall otherwise be credited to the price or cost of the work covered by this contract or paid in such other manner as the procurement officer may direct;

(h) complete performance of such part of the work as shall not have been terminated by the Notice of Termination; and

(i) take any action that may be necessary, or as the procurement officer may direct, for the protection and preservation of the property related to this contract which is in the possession of the Contractor and in which the State has or may acquire an interest.

CONTRACT TERMS AND CONDITIONS

21.07.01.12

The Contractor shall submit to the procurement officer a list, certified as to quantity and quality, of any or all items of termination inventory not previously disposed of, exclusive of items the disposition of which has been directed or authorized by the procurement officer, and may request the State to remove them or enter into a storage agreement covering them. Not later than fifteen (15) days thereafter, the State shall accept title to these items and remove them or enter into a storage agreement covering the same; provided, that the list submitted shall be subject to verification by the procurement officer upon removal of the items, or if the items are stored, within forty-five (45) days from the date of submission of the list, and any necessary adjustment to correct the list as submitted shall be made before final settlement.

"(3) After receipt of a Notice of Termination, the Contractor shall submit to the procurement officer his termination claim, in the form and with certification prescribed by the procurement officer. This claim shall be submitted promptly but in no event later than one(1) year from the effective date of termination, unless one or more extensions in writing are granted by the procurement officer, upon request of the Contractor made in writing within the one-year period or authorized extension thereof. However, if the procurement officer determines that the facts justify such action, he may receive and act upon any such termination claim at any time after the one-year period or any extension thereof. Upon failure of the Contractor to submit his termination claim within the time allowed, the procurement officer may determine the claim at any time after the one-year period or any extension thereof. Upon failure of the Contractor to submit his termination claim within the time allowed, the procurement officer may determine, on the basis of information available to him, the amount, if any, due to the Contractor by reason of the termination and shall thereupon pay to the Contractor the amount so determined.

"(4) Subject to the provisions of paragraph (3), the Contractor and the procurement officer may agree upon the whole or any part of the amount or amounts to be paid to the Contractor by reason of the total or partial termination of work pursuant to this clause, which amount or amounts may include a reasonable allowance for profit on work done; provided, that such agreed amount or amounts, exclusive of settlement costs, shall not exceed the total contract price as reduced by the amount of payments otherwise made and as further reduced by the contract price of work not terminated. The contract shall be amended accordingly, and the Contractor shall be paid the agreed amount. Nothing in paragraph (5) of this clause, prescribing the amount to be paid to the Contractor in the event of failure of the Contractor and the procurement officer to agree upon the whole amount to be paid to the Contractor by reason of the termination of work pursuant to this clause, shall be deemed to limit, restrict, or otherwise determine or affect the amount or amounts that may be agreed upon to be paid to the Contractor pursuant to this paragraph.

"(5) In the event of the failure of the Contractor and the procurement officer to agree as provided in paragraph (4) upon the whole amount to be paid to the Contractor by reason of the termination of work pursuant to this clause, the procurement officer shall pay to the Contractor the amounts determined by the procurement officer as follows, but without duplication of any amounts agreed upon in accordance with paragraph (4):

(a) for completed supplies or services accepted by the State (or sold or acquired as provided in paragraph (2)(g) above) and for which payment has not theretofore been made, a sum equivalent to the aggregate price for the supplies or services computed in accordance with the price or prices specified in the contract, appropriately adjusted for any saving of freight or other charges;

(b) the total of:

(i) the costs incurred in the performance of the work terminated, including initial costs and preparatory expense allocable thereto, but exclusive of any costs attributable to supplies or services paid or to be paid for under paragraph (5)(a) hereof;

(ii) the cost of settling and paying claims arising out of the termination of work under subcontracts or orders, as provided in paragraph (2)(e) above, which are properly chargeable to the terminated portion of the contract (exclusive of amounts paid or payable on account of supplies or materials delivered or services furnished by subcontractors or vendors before the effective date of the Notice of Termination, which amounts shall be included in the costs payable under(i) above); and

(iii) a sum, as profit on(i) above, determined by the procurement officer to be fair and reasonable; provided, however, that if it appears that the contractor would have sustained a loss on the entire contract had it been completed, no profit shall be included or allowed under this subdivision (iii) and an appropriate adjustment shall be made reducing the amount of the settlement to reflect the indicated rate of loss; and

(c) the reasonable cost of settlement accounting, legal, clerical, and other expenses reasonably necessary for the preparation of settlement claims and supporting data with respect to the terminated portion of the contract and for the termination

STATE PROCUREMENT REGULATIONS

21.07.01.12

and settlement of subcontracts thereunder, together with reasonable storage, transportation, and other costs incurred in connection with the protection or disposition of property allocable to this contract.

The total sum to be paid to the Contractor under (a) and (b) of this paragraph shall not exceed the total contract price as reduced by the amount of payments otherwise made and as further reduced by the contract price of work not terminated. Except for normal spoilage, and except to the extent that the State shall have otherwise expressly assumed the risk of loss, there shall be excluded from the amounts payable to the Contractor as provided in (5)(a) and (b)(i) above, the fair value, as determined by the procurement officer, of property that is destroyed, lost, stolen, or damaged so as to become undeliverable to the State or to a buyer pursuant to paragraph (2)(g).

"(6) Costs claimed, agreed to, or determined pursuant to (3), (4), (5) and (11) hereof shall be in accordance with COMAR 21.09 (Contract Cost Principles and Procedures) as in effect on the date of this contract.

"(7) The Contractor shall have the right of appeal, under the clause of this contract entitled "Disputes," from any determination made by the procurement officer under paragraph (3), (5), or (9) hereof, except that if the Contractor has failed to submit his claim within the time provided in paragraph (3) or (9) hereof, and has failed to request extension of the time, he shall have no right of appeal. In any case where the procurement officer has made a determination of the amount due under paragraph (3), (5), or (9) hereof, the State shall pay to the Contractor the following: (a) if there is no right of appeal hereunder or if no timely appeal has been taken, the amount so determined by the procurement officer, or (b) if an appeal has been taken, the amount finally determined on such appeal.

"(8) In arriving at the amount due the Contractor under this clause there shall be deducted (a) all unliquidated advance or other payments on account theretofore made to the Contractor, applicable to the terminated portion of this contract, (b) any claim which the State may have against the Contractor in connection with this contract, and (c) the agreed price for, or the proceeds of sale of, any materials, supplies, or other things acquired by the Contractor or sold, pursuant to the provisions of this clause, and not otherwise recovered by or credited to the State.

"(9) If the termination hereunder be partial, the Contractor may file with the procurement officer a claim for an equitable adjustment of the price or prices specified in the contract relating to the continued portion of the contract (the portion not terminated by the Notice of Termination), and such equitable adjustment as may be agreed upon shall be made in such price or prices. Any claim by the Contractor for an equitable adjustment under this clause shall be asserted within ninety (90) days from the effective date of the termination notice, unless an extension is granted in writing by the procurement officer.

"(10) The State may from time to time, under such terms and conditions as it may prescribe, make partial payments and payments on account against costs incurred by the Contractor in connection with the terminated portion of this contract whenever in the opinion of the procurement officer the aggregate of such payments shall be within the amount to which the Contractor shall be entitled hereunder. If the total of such payments is in excess of the amount finally agreed or determined to be due under this clause, such excess shall be payable by the Contractor to the State upon demand, together with interest computed at the prime rate established by the State Treasurer for the period from the date such excess payment is received by the Contractor to the date on which such excess is repaid to the State; provided, however, that no interest shall be charged with respect to any such excess payment attributable to a reduction in the Contractor's claim by reason of retention or other disposition of termination inventory until ten days after the date of such retention or disposition, or a later date as determined by the procurement officer by reason of the circumstances.

"(11) Unless otherwise provided for in this contract, or by applicable statute, the Contractor shall—from the effective date of termination until the expiration of three years after final settlement under this contract—preserve and make available to the State at all reasonable times at the office of the Contractor but without direct charge to the State, all his books, records, documents and other evidence bearing on the costs and expenses of the Contractor under this contract and relating to the work terminated hereunder, or, to the extent approved by the procurement officer, reproductions thereof."

B. Leases of Real Property.

(1) Inclusion of a termination for convenience clause in a real property lease is discretionary with the Board of Public Works, upon recommendation of the Secretary of General Services.

(2) In recommending the exclusion of a termination for convenience clause in a real property lease, the Secretary shall consider such factors as:

CONTRACT TERMS AND CONDITIONS

21.07.01.18

(a) The practicality of including the termination for convenience clause in a lease of real property located in another state or overseas when the demand for property of a particular type or in some particular geographic location is extremely intense, or when the contents of a lease are established by a foreign government and are effectively non-negotiable, or both;

(b) The perception of some landlords that the termination for convenience clause permits the State to unilaterally convert a fixed term lease to a day-to-day lease; or

(c) The prospects that some lending institutions may reject loan requests from landlords owning property that the State might wish to lease but that must be first upgraded at the owner's expense to meet State User Agency Requirements.

.13 Delays and Extensions of Time.

Mandatory provision for all contracts. It shall be in substantially the same form as follows:

"Delays and Extensions of Time"

"The Contractor agrees to prosecute the work continuously and diligently and no charges or claims for damages shall be made by it for any delays or hindrances from any cause whatsoever during the progress of any portion of the work specified in this Contract.

"Time extensions will be granted only for excusable delays that arise from unforeseeable causes beyond the control and without the fault or negligence of the Contractor, including but not restricted to, acts of God, acts of the public enemy, acts of the State in either its sovereign or contractual capacity, acts of another Contractor in the performance of a contract with the State, fires, floods, epidemics, quarantine restrictions, strikes, freight embargoes, or delays of subcontractors or suppliers arising from unforeseeable causes beyond the control and without the fault or negligence of either the Contractor or the subcontractors or suppliers."

.14 Liquidated Damages.

Mandatory provision for:

- A. All contracts with certified MBE participation goals in accordance with COMAR 21.11.03.10E; and
- B. Any other contracts deemed appropriate by the procurement officer in consultation with the Office of the Attorney General.

.15 Variations in Estimated Quantities.

Mandatory provision for all contracts that contain estimated quantity items.

.16 Suspension of Work.

Mandatory provision for all contracts. It shall be in substantially the same form as follows:

"The procurement officer unilaterally may order the Contractor in writing to suspend, delay, or interrupt all or any part of the work for such period of time as he may determine to be appropriate for the convenience of the State."

.17 Pre-existing Regulations.

Mandatory provision for all contracts. It shall be in substantially the same form as follows:

"In accordance with the provisions of §11-206 of the State Finance and Procurement Article, Annotated Code of Maryland, the regulations set forth in Title 21 of the Code of Maryland Regulations (COMAR Title 21) in effect on the date of execution of this Contract are applicable to this Contract."

.18 Payment of State Obligations.

Mandatory provision for all contracts. The following clause is preferred:

"Unless a payment is unauthorized, deferred, delayed, or set-off under COMAR 21.02.07, Payments to the Contractor pursuant to this Contract shall be made no later than 30 days after the State's receipt of a proper invoice from the Contractor.

The Contractor may be eligible to receive late payment interest at the rate of 9% per annum if:

- (1) The Contractor submits an invoice for the late payment interest within thirty days after the date of the State's payment of the amount on which the interest accrued; and
- (2) A contract claim has not been filed under State Finance and Procurement Article, Title 15, Subtitle 2, Annotated Code of Maryland.

STATE PROCUREMENT REGULATIONS

21.07.01.19

The State is not liable for interest:

- (1) Accruing more than one year after the 31st day after the agency receives the proper invoice; or
- (2) On any amount representing unpaid interest. Charges for late payment of invoices are authorized only as prescribed by Title 15, Subtitle 1, of the State Finance and Procurement Article, Annotated Code of Maryland, or by the Public Service Commission of Maryland with respect to regulated public utilities, as applicable."

.19 Financial Disclosure.

Mandatory provision for all contracts:

"The Contractor shall comply with the provisions of State Finance and Procurement Article §13-221, Annotated Code of Maryland. That section requires a business to file with the Secretary of State of Maryland certain specified information, including disclosure of beneficial ownership of the business, within 30 days of the date the aggregate value of any contracts, leases, or other agreements that the business enters into with the State of Maryland or its agencies during a calendar year reaches \$200,000."

.20 Political Contribution Disclosure.

Mandatory provision for all contracts:

"The Contractor shall comply with Election Law Article, Title 14, Annotated Code of Maryland, which requires that every person that enters into a procurement contract with the State, a county, or a municipal corporation, or other political subdivision of the State, during a calendar year in which the person receives a contract with a governmental entity in the amount of \$200,000 or more, shall file with the State Board of Elections statements disclosing:(a) any contributions made during the reporting period to a candidate for elective office in any primary or general election; and (b) the name of each candidate to whom one or more contribution in a cumulative amount of \$500 or more were made during the reporting period. The statement shall be filed with the State Board of Elections:(a) before execution of a contract by the State, a county, a municipal corporation, or other political subdivision of the State, and shall cover the 24 months prior to when a contract was awarded; and (b) if the contribution is made after the execution of a contract, then twice a year, throughout the contract term, on or before:(i) May 31, to cover the six (6) month period ending April 30; and (ii) November 30, to cover the six (6) month period ending October 31. Additional information is available on the State Board of Election website: http://www.elections.state.md.us/campaign_finance/index.html."

.21 Retention of Records.

Mandatory provision for all contracts. The following clause is preferred:

"The Contractor shall retain and maintain all records and documents relating to this Contract for three years after final payment by the State hereunder or any applicable statute of limitations, whichever is longer, and shall make them available for inspection and audit by authorized representatives of the State, including the procurement officer or designee, at all reasonable times."

.22 Compliance with Laws.

Mandatory provision for all contracts. The following clause is preferred:

"The Contractor hereby represents and warrants that:

"A. It is qualified to do business in the State of Maryland and that it will take such action as, from time to time hereafter, may be necessary to remain so qualified;

"B. It is not in arrears with respect to the payment of any monies due and owing the State of Maryland, or any department or unit thereof, including but not limited to the payment of taxes and employee benefits, and that it shall not become so in arrears during the term of this Contract;

"C. It shall comply with all federal, State, and local laws, regulations, and ordinances applicable to its activities and obligations under this Contract; and

"D. It shall obtain, at its expense, all licenses, permits, insurance, and governmental approvals, if any, necessary to the performance of its obligations under this Contract."

.23 Cost and Price Certification.

Mandatory provision for all contracts and contract modifications (excluding real property leases and architectural services or engineering services contracts (see Regulation .24)) if the contract or modification exceeds \$100,000 or a smaller amount

CONTRACT TERMS AND CONDITIONS

21.07.01.25

determined by the procurement officer under State Finance and Procurement Article, §13-220. The language shall be in substantially the same form as follows:

"Cost and Price Certification"

"A. The Contractor by submitting cost or price information certifies that, to the best of its knowledge, the information submitted is accurate, complete, and current as of a mutually determined specified date prior to the conclusion of any price discussions or negotiations for:

"(1) A negotiated contract, if the total contract price is expected to exceed \$100,000, or a smaller amount set by the procurement officer; or

"(2) A change order or contract modification, expected to exceed \$100,000, or a smaller amount set by the procurement officer.

"B. The price under this Contract and any change order or modification hereunder, including profit or fee, shall be adjusted to exclude any significant price increases occurring because the Contractor furnished cost or price information which, as of the date agreed upon between the parties, was inaccurate, incomplete, or not current."

.24 Truth-In-Negotiation Certification.

Mandatory provision for architectural services or engineering services contracts exceeding \$100,000. It shall be in substantially the same form as follows:

"Truth-In-Negotiation Certification"

"The Contractor by submitting cost or price information, including wage rates or other factual unit costs, certifies to the best of its knowledge, information and belief, that:

"A. The wage rates and other factual unit costs supporting the firm's compensation, as set forth in the proposal, are accurate, complete and current as of the contract date;

"B. If any of the items of compensation were increased due to the furnishing of inaccurate, incomplete or noncurrent wage rates or other units of costs, the State is entitled to an adjustment in all appropriate items of compensation, including profit or fee, to exclude any significant sum by which the price was increased because of the defective data. The State's right to adjustment includes the right to a price adjustment for defects in costs or pricing data submitted by a prospective or actual subcontractor; and

"C. If additions are made to the original price of the contract, such additions may be adjusted to exclude any significant sums where it is determined the price has been increased due to inaccurate, incomplete or noncurrent wage rates and other factual costs."

.25 Contract Affidavit.

Mandatory contract addendum. The contract addendum shall be in substantially the same form as follows and submitted upon initial award and each renewal thereafter:

A. AUTHORITY

I HEREBY AFFIRM THAT:

I, (print name) _____ possess the legal authority to make this Affidavit.

B. CERTIFICATION OF REGISTRATION OR QUALIFICATION WITH THE STATE DEPARTMENT OF ASSESSMENTS AND TAXATION

I FURTHER AFFIRM THAT:

The business named above is a (check applicable items):

- (1) Corporation — domestic or foreign;
- (2) Limited Liability Company — domestic or foreign;
- (3) Partnership — domestic or foreign;
- (4) Statutory Trust — domestic or foreign;
- (5) Sole Proprietorship

STATE PROCUREMENT REGULATIONS

21.07.01.25

and is registered or qualified as required under Maryland Law.

I further affirm that the above business is in good standing both in Maryland and (IF APPLICABLE) in the jurisdiction where it is presently organized, and has filed all of its annual reports, together with filing fees, with the Maryland State Department of Assessments and Taxation. The name and address of its resident agent (IF APPLICABLE) filed with the State Department of Assessments and Taxation is:

Name and Department ID

Number: _____ Address: _____

and that if it does business under a trade name, it has filed a certificate with the State Department of Assessments and Taxation that correctly identifies that true name and address of the principal or owner as:

Name and Department ID Number: _____

Address: _____.

C. FINANCIAL DISCLOSURE AFFIRMATION

I FURTHER AFFIRM THAT:

I am aware of, and the above business will comply with, the provisions of State Finance and Procurement Article, §13-221, Annotated Code of Maryland, which require the business to file with the Secretary of State of Maryland certain specified information, including disclosure of beneficial ownership of the business, within 30 days of the date the aggregate value of any contracts, leases, or other agreements that the business enters into with the State of Maryland or its agencies during a calendar year reaches \$200,000.

D. POLITICAL CONTRIBUTION DISCLOSURE AFFIRMATION

I FURTHER AFFIRM THAT:

I am aware of, and the above business will comply with, Election Law Article, Title 14, Annotated Code of Maryland, which requires that every person that enters into a procurement contract with the State, a county, a municipal corporation, or other political subdivision of the State, during a calendar year in which the person receives a contract with a governmental entity in the amount of \$200,000 or more shall file with the State Board of Elections statements disclosing: (a) any contributions made during the reporting period to a candidate for elective office in any primary or general election; and (b) the name of each candidate to whom one or more contributions in a cumulative amount of \$500 or more were made during the reporting period. The statement shall be filed with the State Board of Elections: (a) before execution of a contract by the State, a county, a municipal corporation, or other political subdivision of the State, and shall cover the 24 months prior to when a contract was awarded; and (b) if the contribution is made after the execution of a contract, then twice a year, throughout the contract term, on: (i) May 31, to cover the six (6) month period ending April 30; and (ii) November 30, to cover the six (6) month period ending October 31.

E. DRUG AND ALCOHOL FREE WORKPLACE

(Applicable to all contracts unless the contract is for a law enforcement agency and the agency head or the agency head's designee has determined that application of COMAR 21.11.08 and this certification would be inappropriate in connection with the law enforcement agency's undercover operations.)

I CERTIFY THAT:

- (1) Terms defined in COMAR 21.11.08 shall have the same meanings when used in this certification.
- (2) By submission of its bid or offer, the business, if other than an individual, certifies and agrees that, with respect to its employees to be employed under a contract resulting from this solicitation, the business shall:
 - (a) Maintain a workplace free of drug and alcohol abuse during the term of the contract;
 - (b) Publish a statement notifying its employees that the unlawful manufacture, distribution, dispensing, possession, or use of drugs, and the abuse of drugs or alcohol is prohibited in the business' workplace and specifying the actions that will be taken against employees for violation of these prohibitions;
 - (c) Prohibit its employees from working under the influence of drugs or alcohol;

CONTRACT TERMS AND CONDITIONS

21.07.01.25

(d) Not hire or assign to work on the contract anyone who the business knows, or in the exercise of due diligence should know, currently abuses drugs or alcohol and is not actively engaged in a bona fide drug or alcohol abuse assistance or rehabilitation program;

(e) Promptly inform the appropriate law enforcement agency of every drug-related crime that occurs in its workplace if the business has observed the violation or otherwise has reliable information that a violation has occurred;

(f) Establish drug and alcohol abuse awareness programs to inform its employees about:

(i) The dangers of drug and alcohol abuse in the workplace;

(ii) The business's policy of maintaining a drug and alcohol free workplace;

(iii) Any available drug and alcohol counseling, rehabilitation, and employee assistance programs; and

(iv) The penalties that may be imposed upon employees who abuse drugs and alcohol in the workplace;

(g) Provide all employees engaged in the performance of the contract with a copy of the statement required by §E(2)(b), of this regulation;

(h) Notify its employees in the statement required by §E(2)(b), of this regulation, that as a condition of continued employment on the contract, the employee shall:

(i) Abide by the terms of the statement; and

(ii) Notify the employer of any criminal drug or alcohol abuse conviction for an offense occurring in the workplace not later than 5 days after a conviction;

(i) Notify the procurement officer within 10 days after receiving notice under §E(2)(h)(ii), of this regulation, or otherwise receiving actual notice of a conviction;

(j) Within 30 days after receiving notice under §E(2)(h)(ii), of this regulation, or otherwise receiving actual notice of a conviction, impose either of the following sanctions or remedial measures on any employee who is convicted of a drug or alcohol abuse offense occurring in the workplace:

(i) Take appropriate personnel action against an employee, up to and including termination; or

(ii) Require an employee to satisfactorily participate in a bona fide drug or alcohol abuse assistance or rehabilitation program;

and

(k) Make a good faith effort to maintain a drug and alcohol free workplace through implementation of §E(2)(a)—(j), of this regulation.

(3) If the business is an individual, the individual shall certify and agree as set forth in §E(4), of this regulation, that the individual shall not engage in the unlawful manufacture, distribution, dispensing, possession, or use of drugs or the abuse of drugs or alcohol in the performance of the contract.

(4) I acknowledge and agree that:

(a) The award of the contract is conditional upon compliance with COMAR 21.11.08 and this certification;

(b) The violation of the provisions of COMAR 21.11.08 or this certification shall be cause to suspend payments under, or terminate the contract for default under COMAR 21.07.01.11 or 21.07.03.15, as applicable; and

(c) The violation of the provisions of COMAR 21.11.08 or this certification in connection with the contract may, in the exercise of the discretion of the Board of Public Works, result in suspension and debarment of the business under COMAR 21.08.03.

STATE PROCUREMENT REGULATIONS

21.07.01.26

F. CERTAIN AFFIRMATIONS VALID**I FURTHER AFFIRM THAT:**

To the best of my knowledge, information, and belief, each of the affirmations, certifications, or acknowledgements contained in that certain Bid/Proposal Affidavit dated _____, 20____, and executed by me for the purpose of obtaining the contract to which this Exhibit is attached remains true and correct in all respects as if made as of the date of this Contract Affidavit and as if fully set forth herein.

I DO SOLEMNLY DECLARE AND AFFIRM UNDER THE PENALTIES OF PERJURY THAT THE CONTENTS OF THIS AFFIDAVIT ARE TRUE AND CORRECT TO THE BEST OF MY KNOWLEDGE, INFORMATION, AND BELIEF.

Date: _____

By: _____ (printed name of Authorized Representative and affiant)

_____ (signature of Authorized Representative and affiant)

.26 Commercial Nondiscrimination Clause.

A. The following provision is mandatory for all State contracts and subcontracts: "As a condition of entering into this Agreement, Contractor represents and warrants that it will comply with the State's Commercial Nondiscrimination Policy, as described under Title 19 of the State Finance and Procurement Article of the Annotated Code of Maryland. As part of such compliance, Contractor may not discriminate on the basis of race, color, religion, ancestry, national origin, sex, age, marital status, sexual orientation, sexual identity, genetic information or an individual's refusal to submit to a genetic test or make available the results of a genetic test or on the basis of disability, or other unlawful forms of discrimination in the solicitation, selection, hiring, or commercial treatment of subcontractors, vendors, suppliers, or commercial customers, nor shall Contractor retaliate against any person for reporting instances of such discrimination. Contractor shall provide equal opportunity for subcontractors, vendors, and suppliers to participate in all of its public sector and private sector subcontracting and supply opportunities, provided that this clause does not prohibit or limit lawful efforts to remedy the effects of marketplace discrimination that have occurred or are occurring in the marketplace. Contractor understands that a material violation of this clause shall be considered a material breach of this Agreement and may result in termination of this Agreement, disqualification of Contractor from participating in State contracts, or other sanctions. This clause is not enforceable by or for the benefit of, and creates no obligation to, any third party.

B. The following provision is mandatory for all State contracts: "As a condition of entering into this Agreement, upon the request of the Commission on Civil Rights, and only after the filing of a complaint against Contractor under Title 19 of the State Finance and Procurement Article of the Annotated Code of Maryland, as amended from time to time, Contractor agrees to provide within 60 days after the request a complete list of the names of all subcontractors, vendors, and suppliers that Contractor has used in the past 4 years on any of its contracts that were undertaken within the State of Maryland, including the total dollar amount paid by Contractor on each subcontract or supply contract. Contractor further agrees to cooperate in any investigation conducted by the State pursuant to the State's Commercial Nondiscrimination Policy as set forth under Title 19 of the State Finance and Procurement Article of the Annotated Code of Maryland, and to provide any documents relevant to any investigation that are requested by the State. Contractor understands that violation of this clause is a material breach of this Agreement and may result in contract termination, disqualification by the State from participating in State contracts, and other sanctions."

.27 Performance and Payment Bonds.

This regulation is added as a separate pdf form within this chapter.

.27 Performance and Payment Bonds.

Mandatory provision for contracts exceeding \$100,000 with surety bond requirements:

A. Performance Bond. The required performance bond shall be in the form specified as follows:

PERFORMANCE BOND

Principal	Business Address of Principal
Surety a corporation of the State of _____ and authorized to do business in the State of Maryland	Obligee STATE OF MARYLAND
Penal Sum of Bond (express in words and figures)	Date of Contract _____, 20____
Description of Contract	Date Bond Executed _____, 20____
Contract Number: _____	

KNOW ALL BY THESE PRESENTS, That we, the Principal named above and Surety named above, are held and firmly bound unto the Obligee named above in the Penal Sum of this Performance Bond stated above, for the payment of which Penal Sum we bind ourselves, our heirs, executors, administrators, personal representatives, successors, and assigns, jointly and severally, firmly by these presents. However, where Surety is composed of corporations acting as co-sureties, we the co-sureties, bind ourselves, our successors and assigns, in such Penal Sum jointly and severally as well as severally only for the purpose of allowing a joint action or actions against any or all of us, and for all other purposes each co-surety binds itself, jointly and severally with the Principal, for the payment of such sum as appears above its name below, but if no limit of liability is indicated, the limit of such liability shall be the full amount of the Penal Sum.

WHEREAS, Principal has entered into or will enter into a contract with the State of Maryland, by and through the Administration named above acting for the State of Maryland, which contract is described and dated as shown above, and incorporated herein by reference. The contract and all items incorporated into the contract, together with any and all changes, extensions of time, alterations, modifications, or additions to the contract or to the work to be performed thereunder or to the Plans, Specifications, and Special Provisions, or any of them, or to any other items incorporated into the contract shall hereinafter be referred as "the Contract."

WHEREAS, it is one of the conditions precedent to the final award of the Contract that these presents be executed.

NOW, THEREFORE, during the original term of said Contract, during any extensions thereto that may be granted by the Administration, and during the guarantee and warranty period, if any, required under the Contract, unless otherwise stated therein, this Performance Bond shall remain in full force and effect unless and until the following terms and conditions are met:

1. Principal shall well and truly perform the Contract; and
2. Principal and Surety shall comply with the terms and conditions in this Performance Bond.

Whenever Principal shall be declared by the Administration to be in default under the Contract, the Surety may, within 15 days after notice of default from the Administration, notify the Administration of its election to either promptly proceed to remedy the default or promptly proceed to complete the contract in accordance with and subject to its terms and conditions. In the event the Surety does not elect to exercise either of the above stated options, then the Administration thereupon shall have the remaining contract work completed, Surety to remain liable hereunder for all expenses of completion up to but not exceeding the penal sum stated above.

The Surety hereby stipulates and agrees that no change, extension of time, alteration or addition to the terms of the Contract or to the work to be performed thereunder or the Specifications accompanying the same shall in any way affect its obligation on this Performance Bond, and it does hereby waive notice of any such change, extension of time, alteration or addition to the terms of the Contract or to the work or to the Specifications.

This Performance Bond shall be governed by and construed in accordance with the laws of the State of Maryland and any reference herein to Principal or Surety in the singular shall include all entities in the plural who or which are signatories under the Principal or Surety heading below.

IN WITNESS WHEREOF, Principal and Surety have set their hands and seals to this Performance Bond. If any individual is a signatory under the Principal heading below, then each such individual has signed below on his or her own behalf, has set forth below the name of the firm, if any, in whose name he or she is doing business, and has set forth below his or her title as a sole proprietor. If any partnership or joint venture is a signatory under the Principal heading below, then all members of each such partnership or joint venture have signed below, each member has set forth below the name of the partnership or joint venture, and each member has set forth below his or her title as a general partner, limited partner, or member of joint venture, whichever is applicable. If any corporation is a signatory under the Principal or Surety heading below, then each such corporation has caused the following: the corporation's name to be set forth below, a duly authorized representative of the corporation to affix below the

corporation's seal and to attach hereto a notarized corporate resolution of power of attorney authorizing such action, and each such duly authorized representative to sign below and set forth below his or her title as a representative of the corporation. If any individual acts as a witness to any signature below, then each such individual has signed below and has set forth below his or her title as a witness. All of the above has been done as of the Date of Bond shown above.

In Presence of: _____ Individual Principal
Witness: _____ as to _____ (SEAL)

In Presence of: _____ Co-Partnership Principal
Witness: _____ (SEAL)

(Name of Co-Partnership)
By: _____ (SEAL)
_____ as to _____ (SEAL)
_____ as to _____ (SEAL)
_____ as to _____ (SEAL)

Attest: _____ Corporate Principal
(Name of Corporation)
AFFIX
By: _____ CORPORATE
Corporate Secretary as to _____ President SEAL

Attest: _____ (SEAL) _____ (Corporate Surety)
By: _____ (SEAL)
Signature _____
Bonding Agent's Name: _____
Agent's Address _____
Title _____

(Business Address of Surety)

Approved as to legal form and sufficiency this
_____ day of _____ 20____

Asst. Attorney General

B. Payment Bond. The required payment bond shall be in the form specified as follows:

PAYMENT BOND

Principal	Business Address of Principal
Surety a corporation of the State of _____ and authorized to do business in the State of Maryland Penal Sum of Bond (express in words and figures) _____	Obligee STATE OF MARYLAND
Description of Contract _____	Date of Contract _____, 20____
Contract Number: _____	Date Bond Executed _____, 20____

KNOW ALL BY THESE PRESENTS, That we, the Principal named above and Surety named above, being authorized to do business in Maryland, and having business address as shown above, are held and firmly bound unto the Obligee named above, for the use and benefit of claimants as hereinafter defined, in the Penal Sum of this Payment Bond stated above, for the payment of which Penal Sum we bind ourselves, our heirs, executors, administrators, personal representatives, successors, and assigns, jointly and severally, firmly by these co-sureties, bind ourselves, our successors and assigns, in such Penal Sum jointly and severally as well as severally only for the purpose of allowing a joint action or actions against any or all of us, and for all other

purposes each co-surety binds itself, jointly and severally with the Principal, for the payment of such sum as appears above its name below, but if no limit of liability is indicated, the limit of such liability shall be the full amount of the Penal Sum.

WHEREAS, Principal has entered into or will enter into a contract with the State, by and through the Administration named above acting for the State of Maryland, which contract is described and dated as shown above, and incorporated herein by reference. The contract and all items incorporated into the contract, together with any and all changes, extensions of time, alterations, modifications, or additions to the contract or to the work to be performed thereunder or to the Plans, Specifications, and Special Provisions, or any of them, or to any other items incorporated into the contract shall hereinafter be referred to as the "Contract".

WHEREAS, it is one of the conditions precedent to the final award of the Contract that these presents be executed.

NOW THEREFORE, the condition of this obligation is such that if the Principal shall promptly make payment to all claimants as hereinafter defined, for all labor and materials furnished, supplied and reasonably required for use in the performance of the Contract, then this obligation shall be null and void; otherwise it shall remain in full force and effect, subject to the following conditions:

1. A claimant is defined to be any and all of those persons supplying services or materials (including lessors of equipment to the extent of the fair market value thereof) to the Principal or its subcontractors and subcontractors in the prosecution of the work provided for in the Contract.

2. The above named Principal and Surety hereby jointly and severally agree with the Oblige that every claimant as herein defined, may sue on this Bond for the use of such claimant and prosecute the suit to final judgment for such sum or sums as may be justly due claimant and have execution thereon. The Oblige shall not be liable for the payment of any costs or expenses of any such suit.

The Surety hereby stipulates and agrees that no change, extension of time, alteration or addition to the terms of the Contract or to the work to be performed thereunder or the Specifications accompanying the same shall in any way affect its obligation on this Payment Bond, and it does hereby waive notice of any such change, extension of time, alteration or addition to the terms of the Contract or to the work or to the Specifications.

This Payment Bond shall be governed by and construed in accordance with the laws of the State of Maryland and any reference herein to Principal or Surety in the singular shall include all entities in the plural who or which are signatories under the Principal or Surety heading below.

IN WITNESS WHEREOF, Principal and Surety have set their hands and seals to this Payment Bond. If any individual is a signatory under the Principal heading below, then each such individual has signed below on his or her own behalf, has set forth below the name of the firm, if any, in whose name he or she is doing business, and has set forth below his or her title as a sole proprietor. If any partnership or joint venture is a signatory under the Principal heading below, then all members of each such partnership or joint venture have signed below, each member has set forth below the name of the partnership or joint venture, and each member has set forth below his or her title as a general partner, limited partner, or member of joint venture, whichever is applicable. If any corporation is a signatory under the Principal or Surety heading below, then each such corporation has caused the following: the corporation's name to be set forth below, a duly authorized representative of the corporation to affix below the corporation's seal and to attach hereto a notarized corporate resolution of power of attorney authorizing such action, and each such duly authorized representative to sign below and set forth below his or her title as a representative of the corporation. If any individual acts as a witness to any signature below, then each such individual has signed below and has set forth below his or her title as a witness. All of the above has been done as of the Date of Bond shown above.

In Presence of:	Individual Principal
Witness:	
_____ as to	_____ (SEAL)

In Presence of:	Co-Partnership Principal
Witness:	
_____ as to	_____ (SEAL)
_____ as to	(Name of Co-Partnership)
_____ as to	By: _____ (SEAL)
	_____ (SEAL)
	_____ (SEAL)

Corporate Principal

 (Name of Corporation)
 AFFIX
 By: _____ CORPORATE
 President SEAL

Attest: _____ (SEAL)
 Corporate Secretary

Signature _____
 Bonding Agent's Name: _____
 Agent's Address _____

 (Corporate Surety)
 By: _____ (SEAL)
 Title _____

 (Business Address of Surety)

Approved as to legal form and sufficiency this
 _____ day of _____ 20____

 Asst. Attorney General

CONTRACT TERMS AND CONDITIONS

21.07.01.28

.28 Performance and Payment Bonds — Multiyear Annual and Renewable.

This regulation is added as a separate pdf form within this chapter.

.28 Performance and Payment Bonds—Multiyear Annual and Renewable.

Optional forms for multiyear contracts exceeding \$100,000 with annual and renewable surety bonds:

A. Performance Bond. The required performance bond shall be in the form specified as follows:

ANNUAL PERFORMANCE BOND – RENEWABLE FOR MULTIYEAR AWARDS

Principal	Business Address of Principal
Surety a corporation of the State of _____ and authorized to do business in the State of Maryland	Obligee STATE OF MARYLAND
Penal Sum of Bond (express in words and figures) _____	Date Bond Executed _____, 20____ Initial Term Fiscal Year Ending June 30, 20____

KNOW ALL BY THESE PRESENTS, That we, the Principal named above and Surety named above, are held and firmly bound unto the Obligee named above in the Penal Sum of this Performance Bond stated above, for the payment of which Penal Sum we bind ourselves, our heirs, executors, administrators, personal representatives, successors, and assigns, jointly and severally, firmly by these presents. However, where Surety is composed of corporations acting as co-sureties, we the co-sureties, bind ourselves, our successors and assigns, in such Penal Sum jointly and severally as well as severally only for the purpose of allowing a joint action or actions against any or all of us, and for all other purposes each co-surety binds itself, jointly and severally with the Principal, for the payment of such sum as appears above its name below, but if no limit of liability is indicated, the limit of such liability shall be the full amount of the Penal Sum.

WHEREAS, Principal has entered into or will enter into a multiyear contract with the State, by and through the Administration named above acting for the State of Maryland, which contract is described above, and incorporated herein by reference. The contract and all items incorporated into the contract, together with any and all changes, extensions of time, alterations, modifications, or additions to the contract or to the work to be performed thereunder or to the Plans, Specifications, and Special Provisions, or any of them, or to any other items incorporated into the contract shall hereinafter be referred to as the "Contract".

The term of this Bond is for the period beginning on the date the bond is executed and ending on the indicated Initial Term Fiscal Year Ending Date (the "Initial Term"). If requested by the Principal, the Initial Term may be extended, solely at the option of the Surety, for additional one (1) year periods (each a "Renewal Term"), ending on the subsequent Fiscal Year ending date. This Bond shall expire at the end of the Initial Term or, if extended, at the end of the final Renewal Term. Provided that at any time should the surety elect not to extend the bond for a Renewal Term, it must so inform the Obligee in writing prior to ninety (90) days before the expiry of the existing Initial Term or final Renewal Term. If the surety does not so inform the Obligee of its intention not to extend the bond as stated herein, the bond will automatically be deemed extended for an additional Renewal Term.

WHEREAS, it is one of the conditions precedent to the final award of the Contract that these presents be executed.

NOW, THEREFORE, during the initial term of said Contract, any renewal term, and during any extensions thereto that may be granted by the Administration, and during the guarantee and warranty period, if any, required under the Contract, unless otherwise stated therein, this Performance Bond shall remain in full force and effect unless and until the following terms and conditions are met:

1. Principal shall well and truly perform the Contract; and
2. Principal and Surety shall comply with the terms and conditions in this Performance Bond.

Whenever Principal shall be declared by the Administration to be in default under the Contract, the Surety may, within 15 days after notice of default from the Administration, notify the Administration of its election to either promptly proceed to remedy the default or promptly proceed to complete the contract in accordance with and subject to its terms and conditions. In the event the Surety does not elect to exercise either of the above stated options, then the Administration thereupon shall have the remaining contract work completed, Surety to remain liable hereunder for all expenses of completion up to but not exceeding the penal sum stated above.

The Surety hereby stipulates and agrees that no change, extension of time, alteration or addition to the terms of the Contract or to the work to be performed thereunder or the Specifications accompanying the same shall in any way affect its obligation on this Performance Bond, and it does hereby waive notice of any such change, extension of time, alteration or addition to the terms of the Contract or to the work or to the Specifications.

This Performance Bond shall be governed by and construed in accordance with the laws of the State of Maryland and any reference herein to Principal or Surety in the singular shall include all entities in the plural who or which are signatories under the Principal or Surety heading below.

IN WITNESS WHEREOF, Principal and Surety have set their hands and seals to this Performance Bond. If any individual is a signatory under the Principal heading below, then each such individual has signed below on his or her own behalf, has set forth below the name of the firm, if any, in whose name he or she is doing business, and has set forth below his or her title as a sole proprietor. If any partnership or joint venture is a signatory under the Principal heading below, then all members of each such partnership or joint venture have signed below, each member has set forth below the name of the partnership or joint venture, and each member has set forth below his or her title as a general partner, limited partner, or member of joint venture, whichever is applicable. If any corporation is a signatory under the Principal or Surety heading below, then each such corporation has caused the following: the corporation's name to be set forth below, a duly authorized representative of the corporation to affix below the corporation's seal and to attach hereto a notarized corporate resolution of power of attorney authorizing such action, and each such duly authorized representative to sign below and set forth below his or her title as a representative of the corporation. If any individual acts as a witness to any signature below, then each such individual has signed below and has set forth below his or her title as a witness. All of the above has been done as of the Date of Bond shown above.

In Presence of: Witness: _____ as to _____	Individual Principal _____ (SEAL)
---	--------------------------------------

In Presence of: Witness: _____ _____ as to _____ _____ as to _____ _____ as to _____	Co-Partnership Principal _____ (SEAL) (Name of Co-Partnership) By: _____ (SEAL) _____ (SEAL) _____ (SEAL)
--	--

Attest: _____ as to _____ Corporate Secretary	Corporate Principal _____ (Name of Corporation) AFFIX By: _____ CORPORATE President SEAL
---	---

Attest: _____ (SEAL) Signature _____ Bonding Agent's Name: _____ Agent's Address _____	_____ (Corporate Surety) By: _____ (SEAL) Title _____ _____ (Business Address of Surety)
---	---

Approved as to legal form and sufficiency this
 _____ day of _____ 20 _____

 Asst. Attorney General

B. Payment Bond. The required payment bond shall be in the form specified as follows:

ANNUAL PAYMENT BOND – RENEWABLE FOR MULTIYEAR AWARDS

Principal	Business Address of Principal
Surety a corporation of the State of _____ and authorized to do business in the State of Maryland	Obligee STATE OF MARYLAND
Penal Sum of Bond (express in words and figures) _____	Date Bond Executed _____, 20____ Initial Term Fiscal Year Ending June 30, 20____

KNOW ALL BY THESE PRESENTS, That we, the Principal named above and Surety named above, being authorized to do business in Maryland, and having business address as shown above, are held and firmly bound unto the Obligee named above, for the use and benefit of claimants as hereinafter defined, in the Penal Sum of this Payment Bond stated above, for the payment of which Penal Sum we bind ourselves, our heirs, executors, administrators, personal representatives, successors, and assigns, jointly and severally, firmly by these co-sureties, bind ourselves, our successors and assigns, in such Penal Sum jointly and severally as well as severally only for the purpose of allowing a joint action or actions against any or all of us, and for all other purposes each co-surety binds itself, jointly and severally with the Principal, for the payment of such sum as appears above its name below, but if no limit of liability is indicated, the limit of such liability shall be the full amount of the Penal Sum.

WHEREAS, Principal has entered into or will enter into a multiyear contract with the State, by and through the Administration named above acting for the State of Maryland, which contract is described above, and incorporated herein by reference. The contract and all items incorporated into the contract, together with any and all changes, extensions of time, alterations, modifications, or additions to the contract or to the work to be performed thereunder or to the Plans, Specifications, and Special Provisions, or any of them, or to any other items incorporated into the contract shall hereinafter be referred to as the "Contract".

The term of this Bond is for the period beginning on the date the bond is executed and ending on the indicated Initial Term Fiscal Year Ending Date (the "Initial Term"). If requested by the Principal, the Initial Term may be extended, solely at the option of the Surety, for additional one (1) year periods (each a "Renewal Term"), ending on the subsequent Fiscal Year ending date. This Bond shall expire at the end of the Initial Term or, if extended, at the end of the final Renewal Term. Provided that at any time should the surety elect not to extend the bond for a Renewal Term, it must so inform the Obligee in writing prior to ninety (90) days before the expiry of the existing Initial Term or final Renewal Term. If the surety does not so inform the Obligee of its intention not to extend the bond as stated herein, the bond will automatically be deemed extended for an additional Renewal Term.

WHEREAS, it is one of the conditions precedent to the final award of the Contract that these presents be executed.

NOW THEREFORE, the condition of this obligation is such that if the Principal shall promptly make payment to all claimants as hereinafter defined, for all labor and materials furnished, supplied and reasonably required for use in the performance of the Contract, then this obligation shall be null and void; otherwise it shall remain in full force and effect, subject to the following conditions:

1. A claimant is defined to be any and all of those persons supplying services or materials (including lessors of equipment to the extent of the fair market value thereof) to the Principal or its subcontractors and subcontractors in the prosecution of the work provided for in the Contract.

2. The above named Principal and Surety hereby jointly and severally agree with the Obligee that every claimant as herein defined, may sue on this Bond for the use of such claimant and prosecute the suit to final judgment for such sum or sums as may be justly due claimant and have execution thereon. The Obligee shall not be liable for the payment of any costs or expenses of any such suit.

The Surety hereby stipulates and agrees that no change, extension of time, alteration or addition to the terms of a Contract or to the work to be performed thereunder or the Specifications accompanying the same shall in any way affect its obligation on this Payment Bond, and it does hereby waive notice of any such change, extension of time, alteration or addition to the terms of a Contract or to the work or to the Specifications.

This Payment Bond shall be governed by and construed in accordance with the laws of the State of Maryland and any reference herein to Principal or Surety in the singular shall include all entities in the plural who or which are signatories under the Principal or Surety heading below.

IN WITNESS WHEREOF, Principal and Surety have set their hands and seals to this Payment Bond. If any individual is a signatory under the Principal heading below, then each such individual has signed below on his or her own behalf, has set forth below the name of the firm, if any, in whose name he or she is doing business, and has set forth below his or her title as a sole proprietor. If any partnership or joint venture is a signatory under the Principal heading below, then all members of each such partnership or joint venture have signed below, each member has set forth below the name of the partnership or joint venture, and

each member has set forth below his or her title as a general partner, limited partner, or member of joint venture, whichever is applicable. If any corporation is a signatory under the Principal or Surety heading below, then each such corporation has caused the following: the corporation's name to be set forth below, a duly authorized representative of the corporation to affix below the corporation's seal and to attach hereto a notarized corporate resolution of power of attorney authorizing such action, and each such duly authorized representative to sign below and set forth below his or her title as a representative of the corporation. If any individual acts as a witness to any signature below, then each such individual has signed below and has set forth below his or her title as a witness. All of the above has been done as of the Date of Bond shown above.

In Presence of: _____ Individual Principal
Witness: _____ as to _____ (SEAL)

In Presence of: _____ Co-Partnership Principal
Witness: _____ (SEAL)

(Name of Co-Partnership)
By: _____ (SEAL)
_____ as to _____ (SEAL)
_____ as to _____ (SEAL)
_____ as to _____ (SEAL)

Attest: _____

Corporate Secretary
Corporate Principal

(Name of Corporation)
AFFIX
By: _____ CORPORATE
President SEAL

Attest: _____ (SEAL)

Signature
Bonding Agent's Name: _____
Agent's Address _____
(Corporate Surety)
By: _____ (SEAL)
Title _____

(Business Address of Surety)

Approved as to legal form and sufficiency this
_____ day of _____ 20 _____

Asst. Attorney General

STATE PROCUREMENT REGULATIONS

21.07.01.28

Administrative History

Effective date: July 1, 1981 (8:13 Md. R. II-5)

Regulation .09A amended effective May 6, 1985 (12:9 Md. R. 816)

Chapter revised effective January 9, 1989 (15:27 Md. R. 3138)

Regulation .03 amended effective August 2, 1993 (20:15 Md. R. 1221)

Regulation .05 amended effective October 2, 2000 (27:19 Md. R. 1730); July 9, 2001 (28:13 Md. R. 1216)

Regulation .08 amended effective December 25, 2000 (27:25 Md. R. 2284); January 2, 2017 (43:26 Md. R. 1449)

Regulation .11A amended effective November 22, 1993 (20:23 Md. R. 1086)

Regulation .12A amended effective November 22, 1993 (20:23 Md. R. 1086)

Regulation .14 amended effective May 13, 2013 (40:9 Md. R. 789); July 15, 2019 (46:14 Md. R. 623)

Regulation .18 amended effective January 2, 2017 (43:26 Md. R. 1449)

Regulation .19 amended effective March 11, 2019 (46:5 Md. R. 310)

Regulation .20 amended effective January 26, 1998 (25:2 Md. R. 79); December 25, 2000 (27:25 Md. R. 2284); January 2, 2017 (43:26 Md. R. 1449)

Regulation .25 amended effective October 1, 1990 (17:19 Md. R. 2322); August 2, 1993 (20:15 Md. R. 1221); August 8, 2011 (38:16 Md. R. 946); May 13, 2013 (40:9 Md. R. 789)

Regulation .25C amended effective March 11, 2019 (46:5 Md. R. 310)

Regulation .25D amended effective January 2, 2017 (43:26 Md. R. 1449)

Regulation .26 adopted as an emergency provision effective August 8, 1997 (24:18 Md. R. 1294); emergency status rescinded effective October 16, 1997 (24:23 Md. R. 1608)

Regulation .26 adopted effective March 12, 2007 (34:5 Md. R. 562)

Regulation .26A amended effective January 2, 2017 (43:26 Md. R. 1449)

Regulation .26B amended effective March 5, 2012 (39:4 Md. R. 338)

Regulation .27 adopted effective July 15, 2019 (46:14 Md. R. 623)

Regulation .28 adopted effective July 15, 2019 (46:14 Md. R. 623)

Annual Estimated Volume: If your State has an existing contract for this commodity or service, please indicate your annual volume of spend (including any potential political subdivision usage if available).

Annual State Spend [Click here to enter text.](#)

Annual Political Subdivision Spend [Click here to enter text.](#)

Total Spend Approximately \$3,500,000.00

State of Louisiana

Paula Tregre
Director Name

225-342-3793 paula.tregre@la.gov
Director Phone **Director Email**

Director has approved submitting the ITP? Yes No
(Click appropriate box)

State Specific T&Cs to be included in RFP? Yes No
(Click appropriate box)

Felicia M. Sonnier
State Point of Contact Name and Title

225-342-8029 felicia.sonnier@la.gov
Phone **Email**

Please email completed "Intent to Participate" document by March 11, 2021 to:

Tara Larwick
Cooperative Contract Coordinator
NASPO ValuePoint
tlarwick@naspovaluepoint.org



**NASPO ValuePoint
INTENT TO PARTICIPATE
Cooperative Contract(s) for Small Package Delivery Services**

I. PURPOSE:

The purpose of this Agreement is to provide interested NASPO states with the opportunity to participate in multi-state cooperative contract(s) for the **Small Package Delivery Services SCOPE OF THE CONTRACT portfolio**

The State of **Utah** is authorized by agreement of the participants to act as the procurement officer in developing multi-state cooperative contract(s) for **Small Package Delivery Services**

The resulting contracts will be permissive contracts.

Administrative Fee

There will be a 0.25% NASPO ValuePoint administrative fee associated with these contracts. It is anticipated that the individual states will be able to add an administrative fee when the state executes its Participating Addendum.

II. TERM OF THE CONTRACT

The initial term of the contract will be established for **five years** from the date of award with **no** options to extend the contract.

III. SOLICITATION AND CONTRACT DEVELOPMENT/ADDITIONAL INFORMATION

The solicitation and contract development shall be accomplished in compliance with the NASPO ValuePoint Process Guide and the NASPO Memorandum of Agreement for the NASPO cooperative purchasing program, incorporated herein by reference.

Solicitation Publication Period

Bidders/Offerors will be given at least 40 days after publication to submit proposals.

Solicitation Type and Evaluation Criteria

This RFP will be issued and evaluated in concert with the procurement laws and rules of the State of **Utah** by a sourcing team comprised of members from several states.

Award(s):

The solicitation will permit multiple awards.

Additional Requested Information

State Specific Terms and Conditions: If the participating state wishes to include any State specific terms and conditions with the release of this RFP, please attach those with this Intent to Participate.

Annual Estimated Volume: If your State has an existing contract for this commodity or service, please indicate your annual volume of spend (including any potential political subdivision usage if available).

Annual State Spend Approximately \$800,000

Annual Political Subdivision Spend Included in Annual State Spend

Total Spend Approximately \$800,000

State of Montana

Meghan Holmlund

Chief Procurement Official

406-444-1459

Phone

mholmlund@mt.gov

Email

Director has approved submitting the ITP? Yes No
(Click appropriate box)

State Specific T&Cs to be included in RFP? Yes No
(Click appropriate box)

State Admin Fee: 1.50%

State Point of Contact Name and Title

Amanda Henrich, Contracts Officer

Phone 406-444-2516

Email Amanda.henrich@mt.gov

Please email completed "Intent to Participate" document by March 11, 2021 to:

Tara Larwick
Cooperative Contract Coordinator
NASPO ValuePoint
tlarwick@naspovaluepoint.org

The following changes are modifying or supplementing the Master Agreement terms and conditions. The Master Agreement and the Participating Addendum together are referred to herein as the "Contract."

State of Montana Terms and Conditions

ACCESS AND RETENTION OF RECORDS: Contractor agrees to provide the Participating Entity, Legislative Auditor, or their authorized agents, access to any records necessary to determine contract compliance. (Section 18-1-118, MCA). Contractor agrees to create and retain records supporting the services rendered or supplies delivered for a period of eight years after either the completion date of the Contract or the conclusion of any claim, litigation, or exception relating to the Contract taken by the Participating Entity or third party.

ASSIGNMENT, TRANSFER AND SUBCONTRACTING: Contractor shall not assign, transfer or subcontract any portion of the Contract without the express written consent of the Participating Entity. (Section 18-4-141, MCA.)

COMPLIANCE WITH LAWS: Contractor shall, in performance of work under this Contract, fully comply with all applicable federal, state, or local laws, rules, regulations, and executive orders including but not limited to, the Montana Human Rights Act, the Equal Pay Act of 1963, the Civil Rights Act of 1964, the Age Discrimination Act of 1975, the Americans with Disabilities Act of 1990, and Section 504 of the Rehabilitation Act of 1973. Contractor is the employer for the purpose of providing healthcare benefits and paying any applicable penalties, fees and taxes under the Patient Protection and Affordable Care Act [P.L. 111-148, 124 Stat. 119]. Any subletting or subcontracting by Contractor subjects subcontractors to the same provisions. In accordance with 49-3-207, MCA, and Executive Order No. 04-2016 Contractor agrees that the hiring of persons to perform this Contract will be made on the basis of merit and qualifications and there will be no discrimination based on race, color, sex, pregnancy, childbirth or medical conditions related to pregnancy or childbirth, political or religious affiliation or ideas, culture, creed, social origin or condition, genetic information, sexual orientation, gender identity or expression, national origin, ancestry, age, disability, military service or veteran status, or marital status by the persons performing this Contract.

DEFENSE, INDEMNIFICATION /HOLD HARMLESS: Contractor shall defend, indemnify and hold harmless the State of Montana and the contracting agency hereunder and their elected and appointed officials, agents, and employees, while acting within the scope of their duties as such, from and against all claims, demands, causes of action, liabilities, damages, judgments, expenses or fees, including the reasonable cost of defense thereof and attorney fees, arising or awarded in favor of Contractor's or its subcontractor's employees or agents or third parties for bodily or personal injuries, death, damage to property, or financial or other loss resulting or allegedly resulting in whole or part from (i) the services performed or products provided or (ii) other acts or omissions of Contractor and/or its agents, employees, representatives, assigns, subcontractors, except the sole negligence of Participating Entity or the contracting agency.

REDUCTION OF FUNDING: Participating Entity must by law terminate this Contract if funds are not appropriated or otherwise made available to support the Participating Entity's or contracting agency's continuation of performance of this Contract in a subsequent fiscal period. (18-4-313(4), MCA) If state or federal government funds are not appropriated or otherwise made available through the state budgeting process to support continued performance of this Contract (whether at an initial contract payment level or any contract increases to that initial level) in subsequent fiscal periods, Participating Entity shall terminate this Contract as required by law. Participating Entity shall provide Contractor the date Participating Entity's termination shall take effect. Participating Entity shall not be liable to Contractor for any payment that would have been payable had the Contract not been terminated under this provision. As stated above, Participating Entity shall be liable to Contractor only for the payment, or prorated portion of that payment, owed to Contractor up to the date Participating Entity's termination takes effect. This is Contractor's sole remedy. Participating Entity shall not be liable to Contractor for any other payments or damages arising from termination under this section, including but not limited to general, special, or consequential damages such as lost profits or revenues.

CHOICE OF LAW AND VENUE: Montana law governs this Contract. The parties agree that any litigation concerning this bid, proposal, or this Contract must be brought in the First Judicial District in and for the County of Lewis and Clark, State of Montana, and each party shall pay its own costs and attorney fees, except as provided in **Defense, Indemnification/Hold Harmless**.

TAX EXEMPTION: Participating Entity is exempt from Federal Excise Taxes (#81-0302402) except as otherwise provided in the federal Patient Protection and Affordable Care Act [P.L. 111-148, 124 Stat. 119].

STATE OF MONTANA ADMINISTRATIVE FEE: The Participating Entity assesses an Administrative Fee of one and one-half percent (1.50%) for all net sales (sales less credits and returns) made under this PA. The prices paid to Contractor must include the 1.5% Administrative Fee. The Contractor shall remit this Administrative Fee concurrent with the Required Usage Reporting described below. The Administrative Fee must be submitted by ACH along with email notification to the State of Montana Contracts Officer. This Administrative Fee is effective upon execution of this Participating Addendum.

REQUIRED REPORTING: Contractor shall submit quarterly reports to the Contracts Officer (CO) assigned by the Participating Entity to manage this contract. Contractor shall provide CO with an electronic usage report (Excel), which must list the following information at the minimum: purchasing entity; description of items purchased; date of purchase; contract price; and the extended price for each transaction. These reports are due no more than 30 days after the end of the quarter.

First Quarter:	July 1 through September 30
Second Quarter:	October 1 through December 31
Third Quarter:	January 1 through March 31
Fourth Quarter:	April 1 through June 30

DELIVERY: Weekends and holidays excepted, deliveries shall be **F.O.B. DESTINATION**, to the location shown below. The term "F.O.B. destination" as used in this clause, means free of expense to the Participating Entity or contracting agency and delivered to the location specified. The Contractor shall:

- Pack and mark the shipment to comply with specifications; or if the specifications do not contain specific packing or marking instructions, pack and mark the shipment in accordance with prevailing commercial practices and in such a manner as to ensure delivery in good condition and as required by this IFB;
- Prepare and distribute commercial bills of lading and Material Safety Data Sheets (MSDS) as appropriate;
- Deliver the shipment in good order and condition to the point of delivery specified in the IFB;
- Be responsible for any loss of and/or damage to the goods occurring before receipt of the shipment by the Participating Entity or contracting agency at the delivery point specified in the IFB;
- Furnish a delivery schedule and designate the mode of delivering carrier; and
- Pay and bear all charges to the specified points of delivery.

Federal Terms and Conditions

(Non-Construction)

1. NONDISCRIMINATION

The Contractor agrees that no person shall be denied benefits of, or otherwise be subjected to discrimination in connection with the Contractor's performance under this contract, on the ground of race, religion, color, national origin, sex or handicap. Accordingly, and to the extent applicable, the Contractor agrees to comply with the following:

a. On the basis of race, color or national origin, in Title VI of the Civil Rights Act of 1964 (42 U.S.C. Section 2000d et seq.) as implemented by DoD regulations at 32 CFR part 195.

b. On the basis of race, color, religion, sex, or national origin, in Executive Order 11246 {3 CFR, 1964-1965 Comp. pg. 339}, as implemented by Department of Labor regulations at 41 CFR part 60.

c. On the basis of sex or blindness, in Title IX of the Education Amendments of 1972 (20 U.S.C. 1681, et seq.), as implemented by DoD regulations at 32 CFR part 196.

d. On the basis of age, in The Age Discrimination Act of 1975 (42 U.S.C. Section 6101 et seq.), as implemented by Department of Health and Human Services regulations at 45 CFR part 90.

e. On the basis of handicap, in Section 504 of the Rehabilitation Act of 1973 (29 U.S.C. 794), as implemented by Department of Justice regulations at 28 CFR part 41 and DoD regulations at 32 CFR part 56.

2. LOBBYING

a. The Contractor agrees that it will not expend any funds appropriated by Congress to pay any person for influencing or attempting to influence an officer or employee of any agency, or a Member of Congress in connection with any of the following covered Federal actions: the awarding of any Federal contract; the making of any Federal grant; the making of any Federal loan; the entering into of any cooperative agreement; and, the extension, continuation, renewal, amendment, or modification of any Federal contract, grant, loan, or cooperative agreement.

b. The Final Rule, New Restrictions on Lobbying, issued by the Office of Management and Budget and the Department of Defense (32 CFR Part 28) to implement the provisions of Section 319 of Public Law 101-121 (31 U.S.C. Section 1352) is incorporated by reference and the State agrees to comply with all the provisions thereof, including any amendments to the Interim Final Rule that may hereafter be issued.

3. DRUG-FREE WORK PLACE

The Contractor agrees to comply with the requirements regarding drug-free workplace requirements in Subpart B of 32 CFR part 26, which implements sec. 5151-5160 of the Drug-Free Workplace Act of 1988 (Public Law 100-690, Title V, Subtitle D; 41 U.S.C. 701, et seq.).

4. ENVIRONMENTAL PROTECTION

a. The Contractor agrees that its performance under this contract shall comply with:

- (1) The requirements of Section 114 of the Clean Air Act (42 U.S.C. Section 7414);
- (2) Section 308 of the Federal Water Pollution Control Act (33 U.S.C. Section 1318), that relates generally to inspection, monitoring, entry reports, and information, and with all regulations and guidelines issued thereunder;
- (3) The Resources Conservation and Recovery Act (RCRA);
- (4) The Comprehensive Environmental Response, Compensation and Liabilities Act (CERCLA);
- (5) The National Environmental Policy Act (NEPA);
- (6) The Solid Waste Disposal Act (SWDA);
- (7) The applicable provisions of the Clean Air Act (42 U.S.C. 7401, et seq.) and Clean Water Act (33 U.S.C. 1251, et seq.), as implemented by Executive Order 11738 and Environmental Protection Agency (EPA) rules at 40 CFR Part 31;
- (8) To identify any impact this contract may have on the quality of the human environment and provide help as needed to comply with the National Environmental Policy Act (NEPA, at 42 U.S.C. 4321, et seq.) and any applicable federal, state or local environmental regulation.

b. In accordance with the EPA rules, the parties further agree that the Contractor shall also identify to the state any impact this contract may have on:

- (1) The quality of the human environment, and provide help the agency may need to comply with the National Environmental Policy Act (NEPA, at 42 U.S.C 4321, et seq.) and to prepare Environment Impact Statements or other required environmental documentation. In such cases, the recipient agrees to take no action that will have an adverse environmental impact (e.g., physical disturbance of a site such as breaking of ground) until the agency provides written notification of compliance with the environmental impact analysis process.
- (2) Flood-prone areas, and provide help the agency may need to comply with the National Flood Insurance Act of 1968 and Flood Disaster Protection Act of 1973 (42 U.S.C. 4001, et seq.), which require flood insurance, when available, for federally assisted construction or acquisition in flood-prone areas.
- (3) Coastal zones, and provide help the agency may need to comply with the Coastal Zone Management Act of 1972 (16 U.S.C. 1451, et seq.), concerning protection of U.S. coastal resources.
- (4) Coastal barriers, and provide help the agency may need to comply with the Coastal Barriers Resource Act (16 U.S.C. 3501 et seq.), concerning preservation of barrier resources.
- (5) Any existing or proposed component of the National Wild and Scenic Rivers System, and provide help the agency may need to comply with the Wild and Scenic Rivers Act of 1968 (16 U.S.C. 1271 et seq.). Underground sources of drinking water in areas that have an aquifer that is the sole or principal drinking water source, and provide help the agency may need to comply with the Safe Drinking Water Act (42 U.S.C 300H-3).
- (6) Underground sources of drinking water in areas that have an aquifer that is the sole or principal drinking work source, and provide help the agency may need to comply with the Safe Drinking Water Act (42 U.S.C 300H-3)

5. USE OF UNITED STATES FLAG VESSELS

a. The Contactor agrees that travel under this contract shall use U.S.-flag air carriers (air carriers holding certificates under 49 U.S.C. 41102) for international air transportation of people and property to the extent that such service is available, in accordance with the International Air Transportation Fair Competitive

Practices Act of 1974 (49 U.S.C. 40118) and the inter-operative guidelines issued by the Comptroller General of the United States in the March 31, 1981, amendment to Comptroller General Decision B138942.

b. The Contactor agrees that it will comply with the Cargo Preference Act of 1954 (46 U.S.C. 1241), as implemented by Department of Transportation regulation at 46 CFR 381.7, and 46 CFR 381.7(b).

6. DEBARMENT AND SUSPENSION

a. The Contractor shall not make any award or permit any award (sub-contract or contract) at any tier to any party which is debarred or suspended or is otherwise excluded from or ineligible for participation in Federal assistance programs under Executive Order 12549, "Debarment and Suspension.

b. The Contractor agrees to comply with the requirements regarding debarment and suspension in Subpart C of the OMB guidance in 2 CFR part 180, as implemented by the DoD in 2 CFR part 1125. The Contractor shall comply with 2 CFR Part 1125 by checking the Excluded Parties List System (EPLS) at www.sam.gov to verify Contractor eligibility to receive contracts and subcontracts resulting from this Agreement. The Contractor shall not solicit offers from, nor award contracts to Contractors listed in EPLS. This verification shall be documented in the Contractor's contract files, and shall be subject to audit by federal/State audit agencies

The Contractor agrees to communicate the requirement to comply with Subpart C to persons at the next lower tier with whom the Contractor enters into transactions that are "covered transactions" under Subpart B of 2 CFR part 180 and the DoD implementation in 2 CFR part 1125.

7. BUY AMERICAN ACT

The Contractor agrees that it will not expend any funds appropriated by Congress without complying with The Buy American Act (41 U.S.C. 10a et seq). The Buy American Act gives preference to domestic end products and domestic construction material. In addition, the Memorandum of Understanding between the United States of America and the European Economic Community on Government Procurement, and the North American Free Trade Agreement (NAFTA), provide that EEC and NAFTA end products and construction materials are exempted from application of the Buy American Act.

8. UNIFORM RELOCATION ASSISTANCE AND REAL PROPERTY POLICES

The Contractor agrees that it will comply with CFR 49 part 24, which implements the provisions of the Uniform Relocation Assistance and Real Property Acquisition Policies Act of 1970 (42 U.S.C. § 4601 et seq.) and provides for fair and equitable treatment of persons displaced by federally assisted programs or persons whose property is acquired as a result of such programs.

9. COPELAND "ANTI-KICKBACK" ACT

The Contractor agrees that it will comply with the Copeland "Anti-Kickback" Act (18 U.S.C. 874) as supplemented in Department of Labor regulations (29 CFR Part 3). As applied to this contract, the Copeland "Anti-Kickback" Act makes it unlawful to induce, by force, intimidation, threat or procuring dismissal from

employment, or otherwise, any person employed in the construction or repair of public buildings or public works, financed in whole or in part by the United States, to give up any part of the compensation to which that person is entitled under a contract of employment.

10. CONTRACT WORK HOURS AND SAFETY STANDARDS

The Contractor agrees that it will comply with Sections 103 and 107 of the Contract Work Hours and Safety Standards Act.(40 U.S.C. 327-330) as supplemented by Department of Labor regulations (29 CFR Part 5). As applied to this agreement, the Contract Work Hours and Safety Standards Act specifies that no laborer or mechanic doing any part of the work contemplated by this agreement shall be required or permitted to work more than 40 hours in any workweek unless paid for all additional hours at not less than 1 1/2 times the basic rate of pay.

11. RIGHTS TO INVENTIONS MADE UNDER A CONTRACT OR AGREEMENT

Any discovery or invention that arises during the course of the contract shall be reported to the non-Federal entity. Contractor must comply with the requirements of 37 CFR Part 401, "Rights to Inventions Made by Nonprofit Organizations and Small Business Firms Under Government Grants, Contracts and Cooperative Agreements," and any implementing regulations issued by the awarding agency.

12. CLEAN AIR ACT (42 U.S.C. 7401-7671Q.) AND THE FEDERAL WATER POLLUTION CONTROL ACT (33 U.S.C. 1251-1387), AS AMENDED

Any Contract or subcontract in excess of \$150,000 must comply with all applicable standards, orders or regulations issued pursuant to the Clean Air Act (42 U.S.C. 7401-7671q) and the Federal Water Pollution Control Act as amended (33 U.S.C. 1251-1387). Violations must be reported to the State who in turn will report to the Federal awarding agency and the Regional Office of the Environmental Protection Agency (EPA).

13. BYRD ANTI-LOBBYING AMENDMENT (31 U.S.C. 1352)

Contractors that bid for an award exceeding \$100,000 must file the required certification. Each tier certifies to the tier above that it will not and has not used Federal appropriated funds to pay any person or organization for influencing or attempting to influence an officer or employee of any agency, a member of Congress, officer or employee of Congress, or an employee of a member of Congress in connection with obtaining any Federal contract, grant or any other award covered by 31 U.S.C. 1352. Each tier must also disclose any lobbying with non-Federal funds that takes place in connection with obtaining any Federal award. Such disclosures are forwarded from tier to tier up to the non-Federal award.

14. PROCUREMENT OF RECOVERED MATERIALS

Contractors must comply with section 6002 of the Solid Waste Disposal Act, as amended by the Resource Conservation and Recovery Act. The requirements of Section 6002 include procuring only items designated in guidelines of the Environmental Protection Agency (EPA) at [40 CFR part 247](#) that contain the

highest percentage of recovered materials practicable, consistent with maintaining a satisfactory level of competition, where the purchase price of the item exceeds \$10,000 or the value of the quantity acquired during the preceding fiscal year exceeded \$10,000; procuring solid waste management services in a manner that maximizes energy and resource recovery; and establishing an affirmative procurement program for procurement of recovered materials identified in the EPA guidelines.

15. PROHIBITION ON CERTAIN TELECOMMUNICATIONS AND VIDEO SURVEILLANCE SERVICES OR EQUIPMENT

The Contractor agrees it will not provide or use covered telecommunications equipment or services in the performance of this contract in compliance with 2 CFR 200.216. Covered telecommunications equipment or services has the meaning provided in Public Law 115-232, section 889.



**NASPO ValuePoint
INTENT TO PARTICPATE
Cooperative Contract(s) for Small Package Delivery Services**

I. PURPOSE:

The purpose of this Agreement is to provide interested NASPO states with the opportunity to participate in multi-state cooperative contract(s) for the **Small Package Delivery Services SCOPE OF THE CONTRACT portfolio**

The State of **Utah** is authorized by agreement of the participants to act as the procurement officer in developing multi-state cooperative contract(s) for **Small Package Delivery Services**

The resulting contracts will be permissive contracts.

Administrative Fee

There will be a 0.25% NASPO ValuePoint administrative fee associated with these contracts. It is anticipated that the individual states will be able to add an administrative fee when the state executes its Participating Addendum.

II. TERM OF THE CONTRACT

The initial term of the contract will be established for **five years** from the date of award with options to extend the contract.

III. SOLICITATION AND CONTRACT DEVELOPMENT/ADDITIONAL INFORMATION

The solicitation and contract development shall be accomplished in compliance with the NASPO ValuePoint Process Guide and the NASPO Memorandum of Agreement for the NASPO cooperative purchasing program, incorporated herein by reference.

Solicitation Publication Period

Bidders/Offerors will be given at least 40 days after publication to submit proposals.

Solicitation Type and Evaluation Criteria

This RFP will be issued and evaluated in concert with the procurement laws and rules of the State of **Utah** by a sourcing team comprised of members from several states.

Award(s):

The solicitation will permit multiple awards.

Additional Requested Information

State Specific Terms and Conditions: If the participating state wishes to include any State specific terms and conditions with the release of this RFP, please attach those with this Intent to Participate.

Annual Estimated Volume: If your State has an existing contract for this commodity or service, please indicate your annual volume of spend (including any potential political subdivision usage if available).

Annual State Spend Approximately \$570,000.00

Annual Political Subdivision Spend Unknown

Total Spend Approximately \$2,850,000.00 for a 5-year contract

State of Nevada

Kevin D. Doty, Purchasing Administrator

Director Name

775-684-0170

Director Phone

kddoty@admin.nv.gov

Director Email

Director has approved submitting the ITP? Yes No
(Click appropriate box)

State Specific T&Cs to be included in RFP? Yes No
(Click appropriate box)

The State has a quarterly 1% administrative fee which would need to be added.

State Point of Contact Name and Title

Annette Morfin, Purchasing Officer [Click here to enter text.](#)

Phone 775-684-0185

Email amorfin@admin.nv.gov

Please email completed "Intent to Participate" document by March 11, 2021 to:

Tara Larwick
Cooperative Contract Coordinator
NASPO ValuePoint
tlarwick@naspovaluepoint.org



**NASPO ValuePoint
INTENT TO PARTICPATE
Cooperative Contract(s) for Small Package Delivery Services**

I. PURPOSE:

The purpose of this Agreement is to provide interested NASPO states with the opportunity to participate in multi-state cooperative contract(s) for the **Small Package Delivery Services SCOPE OF THE CONTRACT portfolio**

The State of **Utah** is authorized by agreement of the participants to act as the procurement officer in developing multi-state cooperative contract(s) for **Small Package Delivery Services**

The resulting contracts will be permissive contracts.

Administrative Fee

There will be a 0.25% NASPO ValuePoint administrative fee associated with these contracts. It is anticipated that the individual states will be able to add an administrative fee when the state executes its Participating Addendum.

II. TERM OF THE CONTRACT

The initial term of the contract will be established for **five years** from the date of award with **no** options to extend the contract.

III. SOLICITATION AND CONTRACT DEVELOPMENT/ADDITIONAL INFORMATION

The solicitation and contract development shall be accomplished in compliance with the NASPO ValuePoint Process Guide and the NASPO Memorandum of Agreement for the NASPO cooperative purchasing program, incorporated herein by reference.

Solicitation Publication Period

Bidders/Offerors will be given at least 40 days after publication to submit proposals.

Solicitation Type and Evaluation Criteria

This RFP will be issued and evaluated in concert with the procurement laws and rules of the State of **Utah** by a sourcing team comprised of members from several states.

Award(s):

The solicitation will permit multiple awards.

Additional Requested Information

State Specific Terms and Conditions: If the participating state wishes to include any State specific terms and conditions with the release of this RFP, please attach those with this Intent to Participate.

Annual Estimated Volume: If your State has an existing contract for this commodity or service, please indicate your annual volume of spend (including any potential political subdivision usage if available).

Annual State Spend Estimated \$18,726,541.26

Annual Political Subdivision Spend Included above.

Total Spend estimated \$18,726,541.26

State of Oregon

Debbie Dennis

Director Name

971.701.0295

Director Phone

Debbie.Dennis@oregon.gov

Director Email

Director has approved submitting the ITP? Yes No
(Click appropriate box)

State Specific T&Cs to be included in RFP? Yes No
(Click appropriate box)

Kaliska King, CPPB, OPBC

State Point of Contact Name and Title

503.798.1907

Phone

Kaliska.king@oregon.gov

Email

Please email completed "Intent to Participate" document by March 12, 2021 to:

Tara Larwick

Cooperative Contract Coordinator

NASPO ValuePoint

tlarwick@naspovaluepoint.org

EXHIBIT NO. 1**Changes to Master Agreement State-Specific Constitutional, Statutory and Other Requirements**

1. Incorporation of Master Agreement. Participating State and Purchasing Entities are entitled to rely upon all of the representations and warranties, rights, remedies, and benefits under the Master Agreement and this Addendum, subject to the State-Specific Constitutional, Statutory and other requirements set forth herein.

2. Definitions. Capitalized terms not defined in this Addendum have the meaning ascribed to them in the Master Agreement and its exhibits. The following terms have the meanings set forth below:

“Business Days” means Monday through Friday, 8:00 a.m. to 5:00 p.m., pacific time, excluding State of Oregon holidays and business closure days.

3. Purchase Orders.

3.1 Eligible Purchasing Entities. All state agencies under DAS procurement authority; and all state agencies with their own procurement authority, institutions of higher institution, political subdivisions and other entities that are members of the Oregon Cooperative Purchasing Program (ORCPP), are eligible to acquire Goods and Services under this Addendum.

3.2 Verification of Purchasing Entities. Contractor shall verify that it provides Goods and Services under this Addendum only to eligible Purchasing Entities. Contractor may verify that a particular entity is an ORCPP member on-line at <http://www.oregon.gov/das/Procurement/Pages/Orcppmember.aspx> or by using the Oregon Procurement Information Network (ORPIN) at <http://orpin.oregon.gov/open.dll/welcome>.

3.3 Effect of Purchase Orders. The State is only liable for purchases under Purchase Orders issued by State of Oregon agencies. Other Purchasing Entities are responsible for any purchases under Purchase Orders they issue. The State expressly disclaims any liability for purchases made by non-State agency Purchasing Entities or any other entity.

4. Third Party Agreements. To the extent any Goods or Services are subject to the provisions of a third-party license agreement, subscription agreement, maintenance and support agreement or any other third party agreement, Contractor shall provide Purchasing Entity with a copy of any such third party agreement. Purchasing Entity shall have thirty (30) calendar days to review the agreement. Purchasing Entity may accept the terms of the agreement, reject the terms, or attempt to negotiate the terms with the third-party provider. In the event Purchasing Entity rejects the terms or is unable to come to agreement with the third-party provider, Purchaser Entity may revoke the Purchase Order and will be entitled to a full refund of all amounts paid and will not be subject to any early termination fees.

5. Payment Provisions; Expenses. All payments are subject to ORS 293.462. Purchasing Entity will not be obligated to pay any travel expenses unless expressly agreed upon in a Purchase Order. Any obligation to pay travel expenses, including transportation, lodging, or meals, is subject to the rates and limitations set under Oregon law. Contracts with the State of

Oregon are subject to the rates and limitations of the Statewide Travel Policy, currently found online at: <http://www.oregon.gov/das/Financial/Acctng/Documents/40.10.00.pdf>.

6. Funds available and authorized/non-appropriation. The State of Oregon's and its agencies' payment obligations under this Addendum are conditioned upon Purchasing Entity receiving funding, appropriations, limitations, allotments, or other expenditure authority sufficient to allow Purchasing Entity, in the exercise of its reasonable administrative discretion, to meet its payment obligations under any Purchase Order issued under this Addendum. Contractor is not entitled to receive payment under this Addendum or any Purchase Order from any part of Oregon state government other than Purchasing Entity. Nothing in this Addendum or Purchase Order is to be construed as permitting any violation of Article XI, section 7 of the Oregon Constitution or any other law regulating liabilities or monetary obligations of the State of Oregon. Purchasing Entity represents that it has sufficient appropriations and limitation for the current biennium to make payments under any Purchase Order issued under this Addendum.

7. Volume Sales Reports (VSRs) / Vendor Collected Administrative Fee (VCAF). Contractor shall submit volume sales reports and pay the administrative fee as set forth in Exhibit 5.

8. Warranties. Purchasing Entities are entitled to the warranties, rights, remedies, and benefits under the Master Agreement and this Addendum. The warranties set forth the Master Agreement are in addition to, and not in lieu of, any other warranties provided by law. All warranties are cumulative and will be interpreted expansively so as to afford Purchasing Entity the broadest warranty protection available.

9. Dispute Resolution. Any dispute between the parties under this Addendum that is not resolved through informal discussions may be submitted to mediation upon the consent of both parties. If informal discussions or mediation are unsuccessful, either party may initiate litigation to resolve the dispute. The parties specifically disclaim any right to arbitration of disputes. Neither party waives its right to a jury trial or right to participate in class, collective, or representative claims.

10. Control of Defense and Settlement. Contractor's obligation to indemnify Purchasing Entity as set forth in the Master Agreement is conditioned on Purchasing Entity providing to Contractor prompt notification of any claim or potential claim of which Purchasing Entity becomes aware. Contractor shall have control of the defense and settlement of any claim that is subject to indemnification; however, neither Contractor nor any attorney engaged by Contractor shall defend the claim in the name of the State of Oregon or any Purchasing Entity of the State of Oregon, nor purport to act as legal representative of the State of Oregon or any of its agencies, without the approval of the Attorney General, nor shall Contractor settle any claim on behalf of the State of Oregon without the approval of the Attorney General. The State of Oregon may, at its election and expense, assume its own defense and settlement in the event that the State of Oregon determines that Contractor is prohibited from defending the State of Oregon, is not adequately defending the State of Oregon's interests, or that an important governmental principle is at issue and the State of Oregon desires to assume its own defense.

11. Limitation of Liability. The Participating State's or a Purchasing Entity's indemnification obligations to Contractor, if any, are subject to the provisions of Article XI, Section 7 of the Oregon Constitution and the Oregon Tort Claims Act (ORS 30.260 to 30.300).

12. Insurance. Within ten (10) days of the Effective Date, Contractor shall deliver to DAS a certificate evidencing the insurance coverage set forth on Exhibit No. 2. No Purchase Orders may be placed

or accepted until proof is provided that these requirements have been met. Purchasing Entities may request additional insurance coverage, as necessary.

13. Jurisdiction and Venue. Any claim, action, suit or proceeding (collectively, "Claim") between State or any other agency or department of the State of Oregon, and Contractor, that arises from or relates to this Addendum or a Purchase Order under this Addendum, will be brought and conducted solely and exclusively in the Circuit Court of Marion County for the State of Oregon; provided, however, if a Claim must be brought in a federal forum, then it will be brought and conducted solely and exclusively in the United States District Court of the District of Oregon. CONTRACTOR, BY EXECUTION OF THIS ADDENDUM OR ACCEPTANCE OF A PURCHASE ORDER SUBMITTED PURSUANT TO THIS ADDENDUM HEREBY CONSENTS TO THE IN PERSONAM JURISDICTION OF SAID COURTS. Nothing in this section will be construed as a waiver of the State of Oregon's sovereign immunity with respect to any Claim, whether brought under State or Federal law, or the consent to jurisdiction in State or Federal Court.

Any Claims between Contractor and an Purchasing Entity other than the State of Oregon or State agency that arise from or are related to individual Purchase Orders or this Addendum will be brought and conducted solely and exclusively within the Circuit Court of the county in the State of Oregon in which such Purchasing Entity resides or has its principal office, or at Purchasing Entity's option, within such other county as Purchasing Entity will be entitled to proceed under the venue laws of Oregon to bring or defend Claims. If any such Claim must be brought in a federal forum, then it will be brought and conducted solely and exclusively within the United States District Court for the District of Oregon.

14. Remedies. If any goods or services furnished by Contractor are, in Contractor's opinion, likely to become the subject of an Infringement Claim, or if an Purchasing Entity is prevented from exercising its rights under this Addendum based on any Infringement Claim or court order arising from any Infringement Claim, then Contractor may, at its option and expense, procure for the Purchasing Entity the right to continue using the allegedly infringing goods or services, or replace or modify the goods or services so that they become non-infringing; provided that the replacement or modified good or service meets the specifications set forth in the applicable Purchase Order to the satisfaction of the Purchasing Entity. If the foregoing remedies are not available, then Purchasing Entity will return the allegedly infringing goods or terminate the allegedly infringing services, and Contractor will refund Purchasing Entity's payments, in full, for the allegedly infringing goods or services.

15. Term and Termination of Participating Addendum.

15.1 This Addendum remains in effect until the earlier of (a) the expiration or termination of the Master Agreement, or (b) termination of this Addendum in accordance with its terms.

15.2 Termination. In addition to its termination rights under the Master Agreement, DAS may terminate this Addendum, in whole or in part, at any time upon thirty (30) days prior written notice to Contractor.

16. Termination of Individual Purchase Orders. In addition to its termination rights under the Master Agreement, Purchasing Entity may, at its sole discretion, terminate individual Purchase Orders, in whole or in part, upon 30 days written notice to Contractor, or Purchasing Entity and Contractor may mutually agree to terminate a Purchase Order at any time by written consent.

17. Governing Law. The laws of the State of Oregon (without giving effect to its conflicts of law principles) govern all matters arising out of or relating to this Addendum and resulting Purchase Orders, including, without limitation, their validity, interpretation, construction, performance, and enforcement.

18. Compliance with Law.

18.1 General. In addition to the compliance of law provisions of the Master Agreement, Contractor shall comply with all federal, state and local laws, rules, regulations, executive orders and ordinances applicable to Contractor or to the Goods or Services ordered under this Addendum or any Purchase Order. Further, a Purchasing Entity's performance under a Purchase Order is conditioned on Contractor's compliance with the provisions of ORS 279B.220, 279B.235, 279B.230. and 279B.270.

18.2 Pay Equity. Contractor shall comply with ORS 652.220 and shall not unlawfully discriminate against any of Contractor's employees in the payment of wages or other compensation for work of comparable character on the basis of an employee's membership in a protected class. "Protected class" means a group of persons distinguished by race, color, religion, sex, sexual orientation, national origin, marital status, veteran status, disability or age. Contractor's compliance with this section constitutes a material element of this Addendum and a failure to comply constitutes a breach that entitles DAS or Purchasing Entity to terminate this Addendum or a Purchase Order for cause.

Contractor may not prohibit any of Contractor's employees from discussing the employee's rate of wage, salary, benefits, or other compensation with another employee or another person. Contractor may not retaliate against an employee who discusses the employee's rate of wage, salary, benefits, or other compensation with another employee or another person.

18.3 False Claims. Contractor understands and acknowledges it is subject to the Oregon False Claims Act (ORS 180.750 to 180.785) and to any liabilities or penalties associated with the making of a false claim under that Act. By its execution of the Addendum, Contractor certifies the truthfulness, completeness, and accuracy of any statement or claim it has made, it makes, it may make, or cause to be made that pertains to the Addendum or the Purchase Orders, including but not limited to Contractor invoices, correspondence, reports, or other deliverables.

18.4 Non-Discrimination. Contractor certifies that it has a written policy and practice that meets the requirements described in ORS 279A.112 for preventing sexual harassment, sexual assault, and discrimination against employees who are members of a protected class. Contractor agrees, as a material condition, to maintain such policy and practice in force during the term of this Addendum and each Purchase Order.

18.5 Undisclosed Debt; Tax Compliance and Certification. By executing this Addendum, the undersigned certifies under penalty of perjury that, to the best of the individual's knowledge, Contractor has no undisclosed liquidated and delinquent debt owed to the State of Oregon or any of its agencies, boards, commissions, departments or divisions, and Contractor complied with the tax laws of the State of Oregon and the applicable tax laws of any political subdivision of this state, and Contractor shall, for the term of this Addendum and any extensions, comply with all tax laws of this state and all applicable tax laws of any political subdivision of this state. For the purposes of this section, "tax laws" includes: (i) All tax laws of this state, including but not limited to ORS 305.620 and ORS chapters 316, 317, and 318; (ii) Any tax provisions imposed by a

political subdivision of this state that apply to Lessor, to Lessor's property, operations, receipts, or income, or to Lessor's performance of or compensation for any work performed by Lessor; (iii) Any tax provisions imposed by a political subdivision of this state that apply to Lessor, or to goods, services, or property, whether tangible or intangible, provided by Lessor; and (iv) Any rules, regulations, charter provisions, or ordinances that implemented or enforced any of the foregoing tax laws or provisions. Any violation of this provision will be considered a material breach of this Addendum and applicable Purchase Orders. DAS and Purchasing Entity, as applicable, may pursue any and all remedies set forth in the Master Agreement, including termination of this Addendum or a Purchase Order.

This Addendum will be reported to the Oregon Department of Revenue. The Department of Revenue may take any and all actions permitted by law relative to the collection of taxes and debt due to the State of Oregon or a political subdivision, including (i) garnishing Lessor's compensation under this Lease, or (ii) exercising a right of setoff against Lessor's compensation relating to this Lease for any amounts that may be due and unpaid to the State of Oregon or its political subdivisions for which the Department of Revenue collects debts.

19. Security and Data Privacy Laws. In addition to the confidentiality provisions set forth in the Master Agreement, Contractor and all Contractor employees, contractors, and agents shall comply with all applicable state and federal laws and regulations, and State of Oregon policies governing use and disclosure of State Agency Purchasing Entity information and data and access to State of Oregon information assets, including as those laws, regulations, and policies may be updated from time to time. Applicable laws, regulations, and policies include but are not limited to:

- Oregon's Statewide Information Security Standards: <https://www.oregon.gov/das/OSCIO/Documents/2019StatewideInformationAndCyberSecurityStandardsV1.0.pdf>
- Oregon's Statewide Information Security Plan, <https://www.oregon.gov/das/OSCIO/Documents/StatewideInformationSecurityPlan.pdf>; and
- Oregon's Statewide Policies: www.oregon.gov/das/Pages/policies.aspx#IT.
- The Oregon Consumer Information Protection Act, ORS 646A.600 through 646A.628.

20. Application of Public Records Law. Participating State or Purchasing Entity's obligations of confidentiality, if any, are subject to application of the Oregon Public Records Law, including but not limited to ORS 192.311 to 192.478, the provisions for the Custody and Maintenance of Public Records, ORS 192.005 – 192.710, and of ORS 646.461 - 646.475.

21. Recycled Products. To the maximum extent economically feasible in the performance of this Addendum or any Purchase Order, Contractor will use recycled paper (as defined in ORS 279A.010(1)(gg)), recycled PETE products (as defined in ORS 279A.010(1)(hh)), and other recycled plastic resin products and recycled products (as "recycled product" is defined in ORS 279A.010(1)(ii)).

22. Foreign Contractor. If Contractor is not domiciled in or registered to do business in the State of Oregon as of the effective date of this Addendum, Contractor will promptly provide to the Oregon Department of Revenue all information required by that Department relative to the Addendum or any Purchase Order. An Purchasing Entity may withhold final payment under a

Purchase Order until Contractor has provided the Oregon Department of Revenue with the required information.

23. Independent Contractor. Contractor shall act at all times as an independent contractor and not as an agent or employee of Purchasing Entity. Contractor has no right or authority to incur or create any obligation for or legally bind Purchasing Entity in any way. Contractor is not an "officer", "employee", or "agent" of Purchasing Entity (or any other agency, office, or department of the State of Oregon), as those terms are used in ORS 30.265, and shall not make representations to third parties to the contrary. Neither party shall make any statements, representations, nor commitments of any kind or to take any action binding on the other except as provided for herein or authorized in writing by the party to be bound.

24. Access to Records. Contractor will maintain all fiscal records relating to Purchase Orders in accordance with generally accepted accounting principles and will maintain any other records relating to Purchase Orders in such a manner as to clearly document Contractor's performance thereunder. The Purchasing Entity, the State and its agencies, the Oregon Secretary of State Audits Division and their duly authorized representatives will have access to such fiscal records and to all other books, documents, papers, plans and writings of Contractor which relate to this Addendum to perform examination and audits and make excerpts and transcripts. To the extent provided by law, the federal government will be entitled to the same access as the State of Oregon and Purchasing Entities. Contractor will retain and keep accessible all such fiscal records, books, documents, papers, plans, and writings for a minimum of six years, or such longer period as may be required by applicable law following final payment and termination of this Addendum, or until the conclusion of any audit, controversy or litigation arising out of or related to this Addendum, whichever date is later.

EXHIBIT NO. 2

INSURANCE

Contractor shall obtain at Contractor's expense the insurance specified in this Exhibit No. 2 prior to performing under this Addendum and shall maintain it in full force and at its own expense throughout the duration of this Addendum and all warranty periods. Contractor shall obtain the following insurance from insurance companies or entities that are authorized to transact the business of insurance and issue coverage in State and that are acceptable to DAS. Coverage shall be primary and non-contributory with any other insurance and self-insurance. Contractor shall pay for all deductibles, self-insured retention and self-insurance, if any.

Purchasing Entity may request additional insurance coverage, as necessary.

WORKERS' COMPENSATION & EMPLOYERS' LIABILITY. All employers, including Contractor, shall provide workers' compensation insurance as required by applicable workers' compensation laws for persons performing work under this Addendum including Employers' Liability Insurance with limits not less than \$500,000 each accident. Contractor shall require and ensure that each of its subcontractors complies with these requirements.

COMMERCIAL GENERAL LIABILITY. Commercial General Liability Insurance covering bodily injury, death and property damage in a form and with coverage that are satisfactory to the State. This insurance shall include personal injury liability, products and completed operations, and contractual liability coverage. Coverage shall be written on an occurrence basis in an amount of not less than \$1,000,000.00 per occurrence. Annual aggregate limit shall not be less than \$2,000,000.00.

AUTOMOBILE LIABILITY INSURANCE. Automobile Liability Insurance covering all owned, non-owned, or hired vehicles with a combined single limit of not less than \$5,000,000.00 for bodily injury and property damage.

PROFESSIONAL LIABILITY. Professional Liability insurance covering any damages caused by an error, omission or any negligent acts related to the services to be provided under this Addendum in an amount not less than \$ 1,000,000.00 per occurrence. Annual aggregate limit shall not be less than \$2,000,000.00. If coverage is on a claims made basis, then either an extended reporting period of not less than 24 months shall be included in the Professional Liability insurance coverage, or the Contractor shall provide Tail Coverage as stated below.

ADDITIONAL INSURED. The Commercial General Liability insurance and Automobile Liability insurance required under this Addendum shall include the State of Oregon, its officers, employees and agents as Additional Insureds but only with respect to Contractor's activities to be performed under this Addendum.

TAIL COVERAGE. If any of the required insurance is on a claims made basis and does not include an extended reporting period of at least 24 months, Contractor shall maintain either tail coverage or continuous claims made liability coverage, provided the effective date of the continuous claims made coverage is on or before the effective date of this Addendum, for a minimum of 24 months following the later of (i) Contractor's completion and DAS' acceptance of all Services required under this Addendum, or, (ii) The expiration of all warranty periods provided under this Addendum.

CERTIFICATE(S) AND PROOF OF INSURANCE. Contractor shall provide to DAS Certificate(s) of Insurance for all required insurance before delivering any Goods and performing any Services required under this Addendum. The Certificate(s) shall list the State of Oregon, its officers, employees and agents as a Certificate holder and as Additional Insured, specify that Contractor shall pay for all deductibles, self-insured retention and self-insurance, if any, that all coverage shall be primary and non-contributory with any other insurance and self-insurance, and confirm that either an extended reporting period of at least 24 months is provided on all claims made policies or that tail coverage is provided. As proof of insurance DAS has the right to request copies of insurance policies relating to the insurance requirements in this Addendum.

NOTICE OF CHANGE OR CANCELLATION. Contractor or its insurer must provide at least 30 days' written notice to DAS before cancellation of, material change to, potential exhaustion of aggregate limits of, or non-renewal of the required insurance coverage(s).

INSURANCE REQUIREMENT REVIEW. Contractor agrees to periodic review of insurance requirements by DAS under this Addendum and to provide updated requirements as mutually agreed upon by Contractor and DAS.

EXHIBIT NO. 3**CONTRACTOR DATA**

Contractor Information. This information is requested pursuant to ORS 305.385.

PLEASE PRINT OR TYPE THE FOLLOWING INFORMATION

Contractor Name (exactly as filed with the IRS): _____

Street address: _____

City, state, zip code: _____

Email address: _____

Telephone: _____

()

Fax: _____

()

Contractor's taxpayer identification numbers;

Federal Tax Number _____

Oregon Tax Number _____

Is Contractor a nonresident alien, as defined in 26 U.S.C. § 7701(b)(1)?

(Check one box): YES NO

Business Designation: (Check one box):

Professional Corporation

Nonprofit Corporation

Limited Partnership

Limited Liability Company

Limited Liability Partnership

Sole Proprietorship

Corporation

Partnership

Other

EXHIBIT NO. 4**VENDOR COLLECTED ADMINISTRATIVE FEE/VOLUME SALES REPORT**

1) Volume Sales Reports (VSRs). Pursuant to the process defined by DAS found at: [\(insert web address\)](#), Contractor shall submit a Volume Sales Report (VSR) to DAS on a quarterly basis. The quarterly report is due no later than thirty (30) calendar days from the end of the quarter. (For purposes of this Agreement, quarters end March 31, June 30, September 30 and December 31.) Upon written notice from DAS, Contractor shall submit the VSR on a monthly basis no later than five (5) business days from the end of the preceding month, as directed by DAS.

The VSR will contain:

- Complete and accurate details of all receipts (sales and refunds) for the reported period; and
- Such other information as DAS may reasonably request.

Contractor is responsible for timely reporting and shall submit a VSR whether or not there are sales. When no sales have been recorded for the reporting period, a report must be submitted stating “**No Sales for the Reporting Period**”.

2) Vendor Collected Administrative Fee (VCAF). Pursuant to the process defined by DAS and published at [\(insert web address\)](#), Contractor shall submit a Vendor Collected Administrative Fee (VCAF), as directed by DAS. The VCAF is a charge equal to Two Percent (2.0%) of Contractor's Gross total sales, less any credits, made to Purchasing Entities during the reporting period.

Contractor may not reflect the VCAF fee as a separate line item charge to Purchasing Entities. Contractor's prices must reflect all Contractor's charges to Purchasing Entities.

Contractor is responsible for timely payment of the VCAF, regardless of entity that actually reports or makes VCAF payment to DAS. The form of payment must be specifically approved by the Contract Administrator. Late payments from Contractor will accrue interest at a rate of 18% per annum or the maximum rate permitted by law, whichever is less, until such overdue amount shall have been paid in full.

Audit. DAS may, upon reasonable request during regular business hours, by itself or by a person authorized by it, audit Contractor's records and other pertinent data, to determine and verify the figures reported in any VSRs furnished by Contractor. In the event that any such audit reveals underpayment of administrative fees, Contractor shall immediately pay the amount of deficiency, together with interest. If the audit reveals that an underpayment exists, Contractor shall pay the cost of the audit.



**NASPO ValuePoint
INTENT TO PARTICPATE
Cooperative Contract(s) for Small Package Delivery Services**

I. PURPOSE:

The purpose of this Agreement is to provide interested NASPO states with the opportunity to participate in multi-state cooperative contract(s) for the **Small Package Delivery Services SCOPE OF THE CONTRACT portfolio**

The State of **Utah** is authorized by agreement of the participants to act as the procurement officer in developing multi-state cooperative contract(s) for **Small Package Delivery Services**

The resulting contracts will be permissive contracts.

Administrative Fee

There will be a 0.25% NASPO ValuePoint administrative fee associated with these contracts. It is anticipated that the individual states will be able to add an administrative fee when the state executes its Participating Addendum.

II. TERM OF THE CONTRACT

The initial term of the contract will be established for **five years** from the date of award with options to extend the contract.

III. SOLICITATION AND CONTRACT DEVELOPMENT/ADDITIONAL INFORMATION

The solicitation and contract development shall be accomplished in compliance with the NASPO ValuePoint Process Guide and the NASPO Memorandum of Agreement for the NASPO cooperative purchasing program, incorporated herein by reference.

Solicitation Publication Period

Bidders/Offerors will be given at least 40 days after publication to submit proposals.

Solicitation Type and Evaluation Criteria

This RFP will be issued and evaluated in concert with the procurement laws and rules of the State of **Utah** by a sourcing team comprised of members from several states.

Award(s):

The solicitation will permit multiple awards.

Additional Requested Information

State Specific Terms and Conditions: If the participating state wishes to include any State specific terms and conditions with the release of this RFP, please attach those with this Intent to Participate.

Annual Estimated Volume: If your State has an existing contract for this commodity or service, please indicate your annual volume of spend (including any potential political subdivision usage if available).

Annual State Spend [Click here to enter text.](#)

Annual Political Subdivision Spend [Click here to enter text.](#)

Total Spend [Click here to enter text.](#)

State of Rhode Island

Nancy McIntyre
Director Name

[Click here to enter text.](#)
Director Phone

Nancy.McIntyre@purchasing.ri.gov
Director Email

Director has approved submitting the ITP? Yes No
(Click appropriate box)

*by Michael D. Hutchins
Deputy Purchasing Agent
3/11/21*

State Specific T&Cs to be included in RFP? Yes No
(Click appropriate box)

Jonathan Nadeau
State Point of Contact Name and Title

401-574-8133
Phone

jonathan.nadeau@purchasing.ri.gov
Email

Please email completed "Intent to Participate" document by March 11, 2021 to:

Tara Larwick
Cooperative Contract Coordinator
NASPO ValuePoint
tlarwick@naspovaluepoint.org



State of Rhode Island
Department of Administration / Division of Purchases
One Capitol Hill, Providence, Rhode Island 02908-5855
Tel: (401) 574-8100 Fax: (401) 574-8387

NASPO ValuePoint Small Package Delivery Services
Rhode Island Specific Terms and Conditions

Cooperative (NASPO) Participating Addendum:

Any Purchase Agreement arising from a Participating Addendum shall be subject to the Rhode Island "State Purchases Act", R. I. Gen. Laws § 37-2-1, et seq., the Rhode Island Procurement Regulations and the Rhode Island General Conditions of Purchase (Link Attached).

Jurisdiction and venue for any lawsuits arising here from shall be in the Providence Superior Court and shall be governed by the laws of the State of Rhode Island without reference to its principles of conflicts of laws.

General Conditions of Purchase link: <https://rules.sos.ri.gov/regulations/part/220-30-00-13>

General Conditions Addendum A link: <https://www.ridop.ri.gov/documents/general-conditions-addendum-a.pdf>

Vendors must register in Ocean State Procures (OSP) before a Participating Addendum may be executed.



**NASPO ValuePoint
INTENT TO PARTICPATE
Cooperative Contract(s) for Small Package Delivery Services**

I. PURPOSE:

The purpose of this Agreement is to provide interested NASPO states with the opportunity to participate in multi-state cooperative contract(s) for the **Small Package Delivery Services SCOPE OF THE CONTRACT portfolio**

The State of **Utah** is authorized by agreement of the participants to act as the procurement officer in developing multi-state cooperative contract(s) for **Small Package Delivery Services**

The resulting contracts will be permissive contracts.

Administrative Fee

There will be a 0.25% NASPO ValuePoint administrative fee associated with these contracts. It is anticipated that the individual states will be able to add an administrative fee when the state executes its Participating Addendum.

II. TERM OF THE CONTRACT

The initial term of the contract will be established for **five years** from the date of award with options to extend the contract.

III. SOLICITATION AND CONTRACT DEVELOPMENT/ADDITIONAL INFORMATION

The solicitation and contract development shall be accomplished in compliance with the NASPO ValuePoint Process Guide and the NASPO Memorandum of Agreement for the NASPO cooperative purchasing program, incorporated herein by reference.

Solicitation Publication Period

Bidders/Offerors will be given at least 40 days after publication to submit proposals.

Solicitation Type and Evaluation Criteria

This RFP will be issued and evaluated in concert with the procurement laws and rules of the State of **Utah** by a sourcing team comprised of members from several states.

Award(s):

The solicitation will permit multiple awards.

Additional Requested Information

State Specific Terms and Conditions: If the participating state wishes to include any State specific terms and conditions with the release of this RFP, please attach those with this Intent to Participate.

Annual Estimated Volume: If your State has an existing contract for this commodity or service, please indicate your annual volume of spend (including any potential political subdivision usage if available).

Annual State Spend \$655,845.07

Annual Political Subdivision Spend Unknown

Total Spend \$655,845.07

State of South Dakota

Steven L. Berg
Director Name

605-773-3405
Director Phone

steven.berg@state.sd.us
Director Email

Director has approved submitting the ITP? Yes No
(Click appropriate box)

State Specific T&Cs to be included in RFP? Yes No
(Click appropriate box)

Lisa Hubbard, Purchasing Specialist
State Point of Contact Name and Title

605-773-4580
Phone

lisa.hubbard@state.sd.us
Email

Please email completed "Intent to Participate" document by March 11, 2021 to:

Tara Larwick
Cooperative Contract Coordinator
NASPO ValuePoint
tlarwick@naspovaluepoint.org



**NASPO ValuePoint
INTENT TO PARTICPATE
Cooperative Contract(s) for Small Package Delivery Services**

I. PURPOSE:

The purpose of this Agreement is to provide interested NASPO states with the opportunity to participate in multi-state cooperative contract(s) for the **Small Package Delivery Services SCOPE OF THE CONTRACT portfolio**

The State of **Utah** is authorized by agreement of the participants to act as the procurement officer in developing multi-state cooperative contract(s) for **Small Package Delivery Services**

The resulting contracts will be permissive contracts.

Administrative Fee

There will be a 0.25% NASPO ValuePoint administrative fee associated with these contracts. It is anticipated that the individual states will be able to add an administrative fee when the state executes its Participating Addendum.

II. TERM OF THE CONTRACT

The initial term of the contract will be established for **five years** from the date of award with options to extend the contract.

III. SOLICITATION AND CONTRACT DEVELOPMENT/ADDITIONAL INFORMATION

The solicitation and contract development shall be accomplished in compliance with the NASPO ValuePoint Process Guide and the NASPO Memorandum of Agreement for the NASPO cooperative purchasing program, incorporated herein by reference.

Solicitation Publication Period

Bidders/Offerors will be given at least 40 days after publication to submit proposals.

Solicitation Type and Evaluation Criteria

This RFP will be issued and evaluated in concert with the procurement laws and rules of the State of **Utah** by a sourcing team comprised of members from several states.

Award(s):

The solicitation will permit multiple awards.

Additional Requested Information

State Specific Terms and Conditions: If the participating state wishes to include any State specific terms and conditions with the release of this RFP, please attach those with this Intent to Participate.

Annual Estimated Volume: If your State has an existing contract for this commodity or service, please indicate your annual volume of spend (including any potential political subdivision usage if available).

Annual State Spend [Click here to enter text.](#)

Annual Political Subdivision Spend [Click here to enter text.](#)

Total Spend \$16.93 Million (CY20)

State of Texas

Bobby Pounds

Director Name

512-463-4941

Director Phone

bobby.pounds@cpa.texas.gov

Director Email

Director has approved submitting the ITP? Yes No
(Click appropriate box)

State Specific T&Cs to be included in RFP? Yes No
(Click appropriate box)

Gerard MacCrossan (Data Management, Analytics & Technology Manager

Brad Payne, Contract Development Area Manager

State Point of Contact Name and Title

512-463-4468 / 512/936-0285

Phone

gerard.maccrossan@cpa.texas.gov / Bradley.payne@cpa.texas.gov

Email

Please email completed "Intent to Participate" document by March 11, 2021 to:

Tara Larwick

Cooperative Contract Coordinator

NASPO ValuePoint

tlarwick@naspovaluepoint.org



**NASPO ValuePoint
INTENT TO PARTICPATE
Cooperative Contract(s) for Small Package Delivery Services**

I. PURPOSE:

The purpose of this Agreement is to provide interested NASPO states with the opportunity to participate in multi-state cooperative contract(s) for the **Small Package Delivery Services SCOPE OF THE CONTRACT portfolio**

The State of **Utah** is authorized by agreement of the participants to act as the procurement officer in developing multi-state cooperative contract(s) for **Small Package Delivery Services**

The resulting contracts will be permissive contracts.

Administrative Fee

There will be a 0.25% NASPO ValuePoint administrative fee associated with these contracts. It is anticipated that the individual states will be able to add an administrative fee when the state executes its Participating Addendum.

II. TERM OF THE CONTRACT

The initial term of the contract will be established for **five years** from the date of award with options to extend the contract.

III. SOLICITATION AND CONTRACT DEVELOPMENT/ADDITIONAL INFORMATION

The solicitation and contract development shall be accomplished in compliance with the NASPO ValuePoint Process Guide and the NASPO Memorandum of Agreement for the NASPO cooperative purchasing program, incorporated herein by reference.

Solicitation Publication Period

Bidders/Offerors will be given at least 40 days after publication to submit proposals.

Solicitation Type and Evaluation Criteria

This RFP will be issued and evaluated in concert with the procurement laws and rules of the State of **Utah** by a sourcing team comprised of members from several states.

Award(s):

The solicitation will permit multiple awards.

Additional Requested Information

State Specific Terms and Conditions: If the participating state wishes to include any State specific terms and conditions with the release of this RFP, please attach those with this Intent to Participate.

Annual Estimated Volume: If your State has an existing contract for this commodity or service, please indicate your annual volume of spend (including any potential political subdivision usage if available).

Annual State Spend [Click here to enter text.](#)

Annual Political Subdivision Spend [Click here to enter text.](#)

Total Spend \$10,103,303.16

State of [Utah](#)

[Christopher Hughes](#)

Director Name

[Click here to enter text.](#)

Director Phone

christopherhughes@utah.gov

Director Email

Director has approved submitting the ITP? Yes No
(Click appropriate box)

State Specific T&Cs to be included in RFP? Yes No
(Click appropriate box)

[Cherilyn Hess](#)

State Point of Contact Name and Title

[Click here to enter text.](#)

Phone

[Click here to enter text.](#)

Email

Please email completed "Intent to Participate" document by March 11, 2021 to:

Tara Larwick
Cooperative Contract Coordinator
NASPO ValuePoint
tlarwick@naspovaluepoint.org

ATTACHMENT A: STATE OF UTAH STANDARD TERMS AND CONDITIONS FOR GOODS AND SERVICES

1. **DEFINITIONS:** The following terms shall have the meanings set forth below:
 - a) "**Confidential Information**" means information that is deemed as confidential under applicable state and federal laws, including personal information. The Eligible User reserves the right to identify, during and after this Contract, additional reasonable types of categories of information that must be kept confidential under federal and state laws.
 - b) "**Contract**" means the Contract Signature Page(s), including all referenced attachments and documents incorporated by reference. The term "Contract" shall include any purchase orders that result from this Contract.
 - c) "**Contract Signature Page(s)**" means the State of Utah cover page(s) that the Division and Contractor signed.
 - d) "**Contractor**" means the individual or entity delivering the Procurement Item identified in this Contract. The term "Contractor" shall include Contractor's agents, officers, employees, and partners.
 - e) "**Custom Deliverable**" means the Work Product that Contractor is required to deliver to the Eligible User under this Contract.
 - f) "**Division**" means the Division of Purchasing and General Services.
 - g) "**Eligible User(s)**" means those authorized to use State Cooperative Contracts and includes the State of Utah's government departments, institutions, agencies, political subdivisions (e.g., colleges, school districts, counties, cities, etc.), and, as applicable, nonprofit organizations, agencies of the federal government, or any other entity authorized by the laws of the State of Utah to participate in State Cooperative Contracts.
 - h) "**End User Agreement**" means any agreement that Eligible Users are required to sign in order to participate in this Contract, including an end user agreement, customer agreement, memorandum of understanding, statement of work, lease agreement, service level agreement, or any other named separate agreement.
 - i) "**Procurement Item**" means a supply, a service, Custom Deliverable, construction, or technology that Contractor is required to deliver to the Eligible User under this Contract.
 - j) "**Response**" means the Contractor's bid, proposals, quote, or any other document used by the Contractor to respond to the Solicitation.
 - k) "**Solicitation**" means an invitation for bids, request for proposals, notice of a sole source procurement, request for statement of qualifications, request for information, or any document used to obtain bids, proposals, pricing, qualifications, or information for the purpose of entering into this Contract.
 - l) "**State of Utah**" means the State of Utah, in its entirety, including its institutions, agencies, departments, divisions, authorities, instrumentalities, boards, commissions, elected or appointed officers, employees, agents, and authorized volunteers.
 - m) "**Subcontractors**" means a person under contract with a contractor or another subcontractor to provide services or labor for design or construction, including a trade contractor or specialty contractor.
 - n) "**Work Product**" means every invention, modification, discovery, design, development, customization, configuration, improvement, process, software program, work of authorship, documentation, formula, datum, technique, know how, secret, or intellectual property right whatsoever or any interest therein (whether patentable or not patentable or registerable under copyright or similar statutes or subject to analogous protection) that is specifically made, conceived, discovered, or reduced to practice by Contractor or Contractor's Subcontractors (either alone or with others) pursuant to this Contract. Work Product shall be considered a work made for hire under federal, state, and local laws; and all interest and title shall be transferred to and owned by the Eligible User. Notwithstanding anything in the immediately preceding sentence to the contrary, Work Product does not include any Eligible User intellectual property, Contractor's intellectual property (that it owned or licensed prior to this Contract) or Third Party intellectual property.
2. **GOVERNING LAW AND VENUE:** This Contract shall be governed by the laws, rules, and regulations of the State of Utah. Any action or proceeding arising from this Contract shall be brought in a court of competent jurisdiction in the State of Utah. Venue shall be in Salt Lake City, in the Third Judicial District Court for Salt Lake County.
3. **LAWS AND REGULATIONS:** At all times during this Contract, Contractor and all Procurement Items delivered and/or performed under this Contract will comply with all applicable federal and state constitutions, laws, rules, codes, orders, and regulations, including applicable licensure and certification requirements. If this Contract is funded by federal funds, either in whole or in part, then any federal regulation related to the federal funding, including CFR Appendix II to Part 200, will supersede this Attachment A.
4. **RECORDS ADMINISTRATION:** Contractor shall maintain or supervise the maintenance of all records necessary to properly account for Contractor's performance and the payments made by Eligible Users to Contractor under this Contract. These records shall be retained by Contractor for at least six (6) years after final payment, or until all audits initiated within the six (6) years have been completed, whichever is later. Contractor agrees to allow, at no additional cost, State of Utah auditors, federal auditors, Eligible Users or any firm identified by the Division, access to all such records. Contractor must refund to the Division any overcharges brought to Contractor's attention by the Division or the Division's auditor and Contractor is not permitted to offset identified overcharges by alleged undercharges to Eligible Users.
5. **PERMITS:** If necessary Contractor shall procure and pay for all permits, licenses, and approvals necessary for the execution of this Contract.
6. **CERTIFY REGISTRATION AND USE OF EMPLOYMENT "STATUS VERIFICATION SYSTEM":** The Status Verification System, also referred to as "E-verify", only applies to contracts issued through a Request for Proposal process, to sole sources that are included within a Request for Proposal, and when Contractor employs any personnel in Utah.
 - a. Contractor certifies as to its own entity, under penalty of perjury, that Contractor has registered and is participating in the Status Verification System to verify the work eligibility status of Contractor's new employees that are employed in the State of Utah in accordance with applicable immigration laws.

- b. Contractor shall require that each of its Subcontractors certify by affidavit, as to their own entity, under penalty of perjury, that each Subcontractor has registered and is participating in the Status Verification System to verify the work eligibility status of Subcontractor's new employees that are employed in the State of Utah in accordance with applicable immigration laws.
- c. Contractor's failure to comply with this section will be considered a material breach of this Contract.
7. **CONFLICT OF INTEREST:** Contractor represents that none of its officers or employees are officers or employees of the Division or the State of Utah, unless disclosure has been made to the Division.
8. **INDEPENDENT CONTRACTOR:** Contractor and Subcontractors, in the performance of this Contract, shall act in an independent capacity and not as officers or employees or agents of the Division or the State of Utah.
9. **CONTRACTOR RESPONSIBILITY:** Contractor is solely responsible for fulfilling the contract, with responsibility for all Procurement Items delivered and/or performed as stated in this Contract. Contractor shall be the sole point of contact regarding all contractual matters. Contractor must incorporate Contractor's responsibilities under this Contract into every subcontract with its Subcontractors that will provide the Procurement Item(s) to the Eligible Users under this Contract. Moreover, Contractor is responsible for its Subcontractors compliance under this Contract.
10. **INDEMNITY:** Contractor shall be fully liable for the actions of its agents, employees, officers, partners, and Subcontractors, and shall fully indemnify, defend, and save harmless the Division, the Eligible Users and the State of Utah from all claims, losses, suits, actions, damages, and costs of every name and description arising out of Contractor's performance of this Contract to the extent caused by any intentional wrongful act or negligence of Contractor, its agents, employees, officers, partners, or Subcontractors, without limitation; provided, however, that the Contractor shall not indemnify for that portion of any claim, loss, or damage arising hereunder due to the fault of an Eligible User. The parties agree that if there are any limitations of the Contractor's liability, including a limitation of liability clause for anyone for whom the Contractor is responsible, such limitations of liability will not apply to injuries to persons, including death, or to damages to property.
11. **EMPLOYMENT PRACTICES:** Contractor agrees to abide by the following federal and state employment laws, including: (i) Title VI and VII of the Civil Rights Act of 1964 (42 U.S.C. 2000e), which prohibits discrimination against any employee or applicant for employment or any applicant or recipient of services on the basis of race, religion, color, or national origin; (ii) Executive Order No. 11246, as amended, which prohibits discrimination on the basis of sex; (iii) 45 CFR 90, which prohibits discrimination on the basis of age; (iv) Section 504 of the Rehabilitation Act of 1973, or the Americans with Disabilities Act of 1990, which prohibits discrimination on the basis of disabilities; and (v) Utah's Executive Order 2019-1, dated February 5, 2019, which prohibits unlawful harassment in the workplace. Contractor further agrees to abide by any other laws, regulations, or orders that prohibit the discrimination of any kind by any of Contractor's employees. Contractor agrees to abide by any other laws, regulations, or orders that prohibit the discrimination of any kind by any of Contractor's employees.
12. **AMENDMENTS:** This Contract may only be amended by the mutual written agreement of the parties, provided that the amendment is within the Scope of Work of this Contract and is within the scope/purpose of the original solicitation for which this Contract was derived. The amendment will be attached and made part of this Contract. Automatic renewals will not apply to this Contract, even if listed elsewhere in this Contract.
13. **DEBARMENT:** Contractor certifies that it is not presently nor has ever been debarred, suspended, proposed for debarment, or declared ineligible by any governmental department or agency, whether international, national, state, or local. Contractor must notify the Division within thirty (30) days if debarred, suspended, proposed for debarment, declared ineligible, or voluntarily excluded from participation in any contract by any governmental entity during this Contract.
14. **TERMINATION:** This Contract may be terminated, with cause by either party, in advance of the specified expiration date, upon written notice given by the other party. The party in violation will be given ten (10) days after written notification to correct and cease the violations, after which this Contract may be terminated for cause immediately and subject to the remedies below. This Contract may also be terminated without cause (for convenience), in advance of the specified expiration date, by the Division, upon thirty (30) days written termination notice being given to the Contractor. The Division and the Contractor may terminate this Contract, in whole or in part, at any time, by mutual agreement in writing.

On termination of this Contract, all accounts and payments will be processed according to the financial arrangements set forth herein for approved and conforming Procurement Items ordered prior to date of termination. In no event shall the Eligible Users be liable to the Contractor for compensation for any Procurement Item neither requested nor accepted by an Eligible User. In no event shall the Division's exercise of its right to terminate this Contract for convenience relieve the Contractor of any liability to the Eligible Users for any damages or claims arising under this Contract.

15. **NONAPPROPRIATION OF FUNDS, REDUCTION OF FUNDS, OR CHANGES IN LAW:** Upon thirty (30) days written notice delivered to the Contractor, a purchase order that results from this Contract may be terminated in whole or in part at the sole discretion of an Eligible User, if an Eligible User reasonably determines that: (i) a change in Federal or State legislation or applicable laws materially affects the ability of either party to perform under the terms of this Contract; or (ii) that a change in available funds affects an Eligible User's ability to pay under this Contract. A change of available funds as used in this paragraph includes, but is not limited to a change in Federal or State funding, whether as a result of a legislative act or by order of the President or the Governor.

If a written notice is delivered under this section, an Eligible User will reimburse Contractor for the Procurement Item(s) properly ordered and/or properly performed until the effective date of said notice. An Eligible User will not be liable for any performance, commitments, penalties, or liquidated damages that accrue after the effective date of said written notice.

16. **SALES TAX EXEMPTION:** The Procurement Item(s) under this Contract will be paid for from an Eligible User's funds and used in the exercise of an Eligible Users essential functions. Upon request, an Eligible User will provide Contractor with its sales tax exemption number. It is Contractor's responsibility to request an Eligible User's sales tax exemption number. It also

is Contractor's sole responsibility to ascertain whether any tax deduction or benefits apply to any aspect of this Contract.

17. **WARRANTY OF PROCUREMENT ITEM(S):** Contractor warrants, represents and conveys full ownership and clear title, free of all liens and encumbrances, to the Procurement Item(s) delivered to an Eligible User under this Contract. Contractor warrants for a period of one (1) year that: (i) the Procurement Item(s) perform according to all specific claims that Contractor made in its Response; (ii) the Procurement Item(s) are suitable for the ordinary purposes for which such Procurement Item(s) are used; (iii) the Procurement Item(s) are suitable for any special purposes identified in the Contractor's Response; (iv) the Procurement Item(s) are designed and manufactured in a commercially reasonable manner; (v) the Procurement Item(s) are manufactured and in all other respects create no harm to persons or property; and (vi) the Procurement Item(s) are free of defects. Unless otherwise specified, all Procurement Item(s) provided shall be new and unused of the latest model or design. Remedies available to an Eligible User under this section include, but are not limited to, the following: Contractor will repair or replace Procurement Item(s) at no charge to the Eligible User within ten (10) days of any written notification informing Contractor of the Procurement Items not performing as required under this Contract. If the repaired and/or replaced Procurement Item(s) prove to be inadequate, or fail its essential purpose, Contractor will refund the full amount of any payments that have been made. Nothing in this warranty will be construed to limit any rights or remedies an Eligible User may otherwise have under this Contract.
18. **CONTRACTOR'S INSURANCE RESPONSIBILITY.** The Contractor shall maintain the following insurance coverage:
- Workers' compensation insurance during the term of this Contract for all its employees and any Subcontractor employees related to this Contract. Workers' compensation insurance shall cover full liability under the workers' compensation laws of the jurisdiction in which the work is performed at the statutory limits required by said jurisdiction.
 - Commercial general liability [CGL] insurance from an insurance company authorized to do business in the State of Utah. The limits of the CGL insurance policy will be no less than one million dollars (\$1,000,000.00) per person per occurrence and three million dollars (\$3,000,000.00) aggregate.
 - Commercial automobile liability [CAL] insurance from an insurance company authorized to do business in the State of Utah. The CAL insurance policy must cover bodily injury and property damage liability and be applicable to all vehicles used in your performance of Services under this Agreement whether owned, non-owned, leased, or hired. The minimum liability limit must be \$1 million per occurrence, combined single limit. The CAL insurance policy is required if Contractor will use a vehicle in the performance of this Contract.
 - Other insurance policies required in the Solicitation.

Certificate of Insurance, showing up-to-date coverage, shall be on file with the State before the Contract may commence.

The State reserves the right to require higher or lower insurance limits where warranted. Failure to provide proof of insurance as required will be deemed a material breach of this Contract. Contractor's failure to maintain this insurance requirement for the term of this Contract will be grounds for immediate termination of this Contract.

19. **RESERVED.**

20. **PUBLIC INFORMATION:** Contractor agrees that this Contract, related purchase orders, related pricing documents, and invoices will be public documents and may be available for public and private distribution in accordance with the State of Utah's Government Records Access and Management Act (GRAMA). Contractor gives the Division, the Eligible Users, and the State of Utah express permission to make copies of this Contract, related sales orders, related pricing documents, and invoices in accordance with GRAMA. Except for sections identified in writing by Contractor and expressly approved by the Division, Contractor also agrees that the Contractor's Response will be a public document, and copies may be given to the public as permitted under GRAMA. The Division, the Eligible Users, and the State of Utah are not obligated to inform Contractor of any GRAMA requests for disclosure of this Contract, related purchase orders, related pricing documents, or invoices.
21. **DELIVERY:** All deliveries under this Contract will be F.O.B. destination with all transportation and handling charges paid for by Contractor. Responsibility and liability for loss or damage will remain with Contractor until final inspection and acceptance when responsibility will pass to an Eligible User, except as to latent defects or fraud. Contractor shall strictly adhere to the delivery and completion schedules specified in this Contract.
22. **ACCEPTANCE AND REJECTION:** An Eligible User shall have thirty (30) days after delivery of the Procurement Item(s) to perform an inspection of the Procurement Item(s) to determine whether the Procurement Item(s) conform to the standards specified in the Solicitation and this Contract prior to acceptance of the Procurement Item(s) by the Eligible User. If Contractor delivers nonconforming Procurement Item(s), an Eligible User may, at its option and at Contractor's expense: (i) return the Procurement Item(s) for a full refund; (ii) require Contractor to promptly correct or replace the nonconforming Procurement Item(s); or (iii) obtain replacement Procurement Item(s) from another source, subject to Contractor being responsible for any cover costs. Contractor shall not redeliver corrected or rejected Procurement Item(s) without: first, disclosing the former rejection or requirement for correction; and second, obtaining written consent of the Eligible User to redeliver the corrected Procurement Item(s). Repair, replacement, and other correction and redelivery shall be subject to the terms of this Contract.
23. **INVOICING:** Contractor will submit invoices within thirty (30) days after the delivery date of the Procurement Item(s) to the Eligible User. The contract number shall be listed on all invoices, freight tickets, and correspondence relating to this Contract. The prices paid by the Eligible User will be those prices listed in this Contract, unless Contractor offers a discount at the time

of the invoice. It is Contractor's obligation to provide correct and accurate invoicing. The Eligible User has the right to adjust or return any invoice reflecting incorrect pricing.

24. **PAYMENT:** Payments are to be made within thirty (30) days after a correct invoice is received. All payments to Contractor will be remitted by mail, electronic funds transfer, or the State of Utah's Purchasing Card (major credit card). If payment has not been made after sixty (60) days from the date a correct invoice is received by an Eligible User, then interest may be added by Contractor as prescribed in the Utah Prompt Payment Act. The acceptance by Contractor of final payment, without a written protest filed with the Eligible User within ten (10) business days of receipt of final payment, shall release the Eligible User from all claims and all liability to the Contractor. An Eligible User's payment for the Procurement Item(s) and/or Services shall not be deemed an acceptance of the Procurement Item(s) and is without prejudice to any and all claims that the Eligible User may have against Contractor. Contractor shall not charge Eligible Users electronic payment fees of any kind.
25. **INDEMNIFICATION RELATING TO INTELLECTUAL PROPERTY:** Contractor will indemnify and hold the Division, the Eligible Users, and the State of Utah harmless from and against any and all damages, expenses (including reasonable attorneys' fees), claims, judgments, liabilities, and costs in any action or claim brought against the Division, the Eligible User, or the State of Utah for infringement of a third party's copyright, trademark, trade secret, or other proprietary right. The parties agree that if there are any limitations of Contractor's liability, such limitations of liability will not apply to this section.
26. **OWNERSHIP IN INTELLECTUAL PROPERTY:** The Division, the Eligible User, and Contractor each recognizes that each has no right, title, or interest, proprietary or otherwise, in the intellectual property owned or licensed by the other, unless otherwise agreed upon by the parties in writing. All Procurement Item(s), documents, records, programs, data, articles, memoranda, and other materials not developed or licensed by Contractor prior to the execution of this Contract, but specifically manufactured under this Contract shall be considered work made for hire, and Contractor shall transfer any ownership claim to the Eligible User.
27. **OWNERSHIP IN CUSTOM DELIVERABLES:** In the event that Contractor provides Custom Deliverables to the Eligible User, pursuant to this Contract, Contractor grants the ownership in Custom Deliverables, which have been developed and delivered by Contractor exclusively for the Eligible User and are specifically within the framework of fulfilling Contractor's contractual obligations under this contract. Custom Deliverables shall be deemed work made for hire, such that all intellectual property rights, title and interest in the Custom Deliverables shall pass to the Eligible User, to the extent that the Custom Deliverables are not recognized as work made for hire, Contractor hereby assigns to the Eligible User any and all copyrights in and to the Custom Deliverables, subject to the following:
1. Contractor has received payment for the Custom Deliverables,
 2. Each party will retain all rights to patents, utility models, mask works, copyrights, trademarks, trade secrets, and any other form of protection afforded by law to inventions, models, designs, technical information, and applications ("Intellectual Property Rights") that it owned or controlled prior to the effective date of this contract or that it develops or acquires from activities independent of the services performed under this contract ("Background IP"), and
 3. Contractor will retain all right, title, and interest in and to all Intellectual Property Rights in or related to the services, or tangible components thereof, including but not limited to (a) all know-how, intellectual property, methodologies, processes, technologies, algorithms, software, or development tools used in performing the Services (collectively, the "Utilities"), and (b) such ideas, concepts, know-how, processes and reusable reports, designs, charts, plans, specifications, documentation, forms, templates, or output which are supplied or otherwise used by or on behalf of Contractor in the course of performing the Services or creating the Custom Deliverables, other than portions that specifically incorporate proprietary or Confidential Information or Custom Deliverables of the Eligible User (collectively, the "Residual IP"), even if embedded in the Custom Deliverables.
 4. Custom Deliverables, not including Contractor's Intellectual Property Rights, Background IP, and Residual IP, may not be marketed or distributed without written approval by the Eligible User.
- Contractor agrees to grant to the Eligible User a perpetual, irrevocable, royalty-free license to use Contractor's Background IP, Utilities, and Residual IP, as defined above, solely for the Eligible User and the State of Utah to use the Custom Deliverables. The Eligible User reserves a royalty-free, nonexclusive, and irrevocable license to reproduce, publish, or otherwise use and to authorize others to use, for the Eligible User's and the State of Utah's internal purposes, such Custom Deliverables. For the Goods delivered that consist of Contractor's scripts and code and are not considered Custom Deliverables or Work Product, for any reason whatsoever, Contractor grants the Eligible User a non-exclusive, non-transferable, irrevocable, perpetual right to use, copy, and create derivative works from such, without the right to sublicense, for the Eligible User's and the State of Utah's internal business operation under this Contract. The Eligible User and the State of Utah may not participate in the transfer or sale of, create derivative works from, or in any way exploit Contractor's Intellectual Property Rights, in whole or in part.
28. **ASSIGNMENT:** Contractor may not assign, sell, transfer, subcontract or sublet rights, or delegate any right or obligation under this Contract, in whole or in part, without the prior written approval of the Division.
29. **REMEDIES:** Any of the following events will constitute cause for an Eligible User to declare Contractor in default of this Contract: (i) Contractor's non-performance of its contractual requirements and obligations under this Contract; or (ii) Contractor's material breach of any term or condition of this Contract. An Eligible User may issue a written notice of default providing a ten (10) day period in which Contractor will have an opportunity to cure. Time allowed for cure will not diminish or eliminate Contractor's liability for damages. If the default remains after Contractor has been provided the opportunity to cure, an Eligible User may do one or more of the following: (i) exercise any remedy provided by law or equity; (ii) terminate this Contract; (iii) impose liquidated damages, if liquidated damages are listed in this Contract; (iv) debar/suspend Contractor from receiving future contracts from the Division; or (v) demand a full refund of any payment that the Eligible User has made to Contractor under this Contract for Procurement Item(s) that do not conform to this Contract.

30. **FORCE MAJEURE:** Neither an Eligible User nor Contractor will be held responsible for delay or default caused by fire, riot, act of God, and/or war which is beyond that party's reasonable control. An Eligible User may terminate a purchase order resulting from this Contract after determining such delay will prevent Contractor's successful performance of this Contract.
31. **CONFIDENTIALITY:** If Confidential Information is disclosed to Contractor, Contractor shall: (i) advise its agents, officers, employees, partners, and Subcontractors of the obligations set forth in this Contract; (ii) keep all Confidential Information strictly confidential; and (iii) not disclose any Confidential Information received by it to any third parties. Contractor will promptly notify an Eligible User of any potential or actual misuse or misappropriation of Confidential Information.
- Contractor shall be responsible for any breach of this duty of confidentiality, including any required remedies and/or notifications under applicable law. Contractor shall indemnify, hold harmless, and defend the Eligible User, including anyone for whom the Eligible User is liable, from claims related to a breach of this duty of confidentiality, including any notification requirements, by Contractor or anyone for whom the Contractor is liable.
- Upon termination or expiration of this Contract, Contractor will return all copies of Confidential Information to the Eligible User or certify, in writing, that the Confidential Information has been destroyed. This duty of confidentiality shall be ongoing and survive the termination or expiration of this Contract.
32. **LARGE VOLUME DISCOUNT PRICING:** Eligible Users may seek to obtain additional volume discount pricing for large orders provided Contractor is willing to offer additional discounts for large volume orders. No amendment to this Contract is necessary for Contractor to offer discount pricing to an Eligible User for large volume purchases.
33. **ELIGIBLE USER PARTICIPATION:** Participation under this Contract by Eligible Users is voluntarily determined by each Eligible User. Contractor agrees to supply each Eligible User with Procurement Items based upon the same terms, conditions, and prices of this Contract.
34. **INDIVIDUAL CUSTOMERS:** Each Eligible User that purchases Procurement Items from this Contract will be treated as individual customers. Each Eligible User will be responsible to follow the terms and conditions of this Contract. Contractor agrees that each Eligible User will be responsible for their own charges, fees, and liabilities. Contractor shall apply the charges to each Eligible User individually. The Division is not responsible for any unpaid invoice.
35. **REPORTS AND FEES:**
- a. **Administrative Fee:** Contractor agrees to provide a quarterly administrative fee to the State in the form of a check, EFT or online payment through the Division's Automated Vendor Usage Management System. Checks will be payable to the "State of Utah Division of Purchasing" and will be sent to State of Utah, Division of Purchasing, Attn: Cooperative Contracts, PO Box 141061, Salt Lake City, UT 84114-1061. The Administrative Fee will be the amount listed in the Solicitation and will apply to all purchases (net of any returns, credits, or adjustments) made under this Contract.
 - b. **Quarterly Reports:** Contractor agrees to provide a quarterly utilization report, reflecting net sales to the State during the associated fee period. The report will show the dollar volume of purchases by each Eligible User. The quarterly report will be provided in secure electronic format through the Division's Automated Vendor Usage Management System found at: <https://statecontracts.utah.gov/Vendor..>
 - c. **Report Schedule:** Quarterly utilization reports shall be made in accordance with the following schedule:

Period End	Reports Due
March 31	April 30
June 30	July 31
September 30	October 31
December 31	January 31
 - d. **Fee Payment:** After the Division receives the quarterly utilization report, it will send Contractor an invoice for the total quarterly administrative fee owed to the Division. Contractor shall pay the quarterly administrative fee within thirty (30) days from receipt of invoice.
 - e. **Timely Reports and Fees:** If the quarterly administrative fee is not paid by thirty (30) days of receipt of invoice or quarterly utilization reports are not received by the report due date, then Contractor will be in material breach of this Contract.
36. **ORDERING:** Orders will be placed by the using Eligible User directly with Contractor. All orders will be shipped promptly in accordance with the terms of this Contract.
37. **END USER AGREEMENTS:** If Eligible Users are required by Contractor to sign an End User Agreement before participating in this Contract, then a copy of the End User Agreement must be attached to this Contract as an attachment. The term of the End User Agreement shall not exceed the term of this Contract, and the End User Agreement will automatically terminate upon the completion of termination of this Contract. An End User Agreement must reference this Contract, and may not be amended or changed unless approved in writing by the Division. Eligible Users will not be responsible or obligated for any early termination fees if the End User Agreement terminates as a result of completion or termination of this Contract.
38. **PUBLICITY:** Contractor shall submit to the Division for written approval all advertising and publicity matters relating to this Contract. It is within the Division's sole discretion whether to provide approval, which approval must be in writing.
39. **WORK ON STATE OF UTAH OR ELIGIBLE USER PREMISES:** Contractor shall ensure that personnel working on the premises of an Eligible User shall: (i) abide by all of the rules, regulations, and policies of the premises; (ii) remain in authorized

areas; (iii) follow all instructions; and (iv) be subject to a background check, prior to entering the premises. The Eligible User may remove any individual for a violation hereunder.

40. **CONTRACT INFORMATION:** During the duration of this Contract the State of Utah Division of Purchasing is required to make available contact information of Contractor to the State of Utah Department of Workforce Services. The State of Utah Department of Workforce Services may contact Contractor during the duration of this Contract to inquire about Contractor's job vacancies within the State of Utah.
41. **WAIVER:** A waiver of any right, power, or privilege shall not be construed as a waiver of any subsequent right, power, or privilege.
42. **SUSPENSION OF WORK:** Should circumstances arise which would cause an Eligible User to suspend Contractor's responsibilities under this Contract, but not terminate this Contract, this will be done by formal written notice pursuant to the terms of this Contract. Contractor's responsibilities may be reinstated upon advance formal written notice from the Eligible User.
43. **PROCUREMENT ETHICS:** Contractor understands that a person who is interested in any way in the sale of any supplies, services, construction, or insurance to the State of Utah is violating the law if the person gives or offers to give any compensation, gratuity, contribution, loan, reward, or any promise thereof to any person acting as a procurement officer on behalf of the State of Utah, or to any person in any official capacity who participates in the procurement of such supplies, services, construction, or insurance, whether it is given for their own use or for the use or benefit of any other person or organization.
44. **CHANGES IN SCOPE:** Any changes in the scope of the services to be performed under this Contract shall be in the form of a written amendment to this Contract, mutually agreed to and signed by both parties, specifying any such changes, fee adjustments, any adjustment in time of performance, or any other significant factors arising from the changes in the scope of services.
45. **ATTORNEY'S FEES:** In the event of any judicial action to enforce rights under this Contract, the prevailing party shall be entitled its costs and expenses, including reasonable attorney's fees incurred in connection with such action.
46. **TRAVEL COSTS:** If travel expenses are permitted by the Solicitation All travel costs associated with the delivery of Services under this Contract will be paid according to the rules and per diem rates found in the Utah Administrative Code R25-7. Invoices containing travel costs outside of these rates will be returned to the vendor for correction.
47. **PERFORMANCE EVALUATION:** The Division may conduct a performance evaluation of Contractor, including Contractor's Subcontractors. Results of any evaluation may be made available to Contractor upon request.
48. **STANDARD OF CARE:** The services performed by Contractor and its Subcontractors shall be performed in accordance with the standard of care exercised by licensed members of their respective professions having substantial experience providing similar services which similarities include the type, magnitude, and complexity of the services that are the subject of this Contract. Contractor shall be liable to the Eligible User for claims, liabilities, additional burdens, penalties, damages, or third party claims (e.g., another Contractor's claim against the State of Utah), to the extent caused by wrongful acts, errors, or omissions that do not meet this standard of care.
49. **REVIEWS:** The Division reserves the right to perform plan checks, plan reviews, other reviews, and/or comment upon the services of Contractor. Such reviews do not waive the requirement of Contractor to meet all of the terms and conditions of this Contract.
50. **DISPUTE RESOLUTION:** Prior to either party filing a judicial proceeding, the parties agree to participate in the mediation of any dispute. The Division or an Eligible User, after consultation with Contractor, may appoint an expert or panel of experts to assist in the resolution of a dispute. If the Division or an Eligible User appoints such an expert or panel, the Division or the Eligible User and Contractor agree to cooperate in good faith in providing information and documents to the expert or panel in an effort to resolve the dispute.
51. **ORDER OF PRECEDENCE:** In the event of any conflict in the terms and conditions in this Contract, the order of precedence shall be: (i) this Attachment A; (ii) Contract Signature Page(s); (iii) the State of Utah's additional terms and conditions, if any; (iv) any other attachment listed on the Contract Signature Page(s); and (v) Contractor's terms and conditions that are attached to this Contract, if any. Any provision attempting to limit the liability of Contractor or limit the rights of an Eligible User, the Division, or the State of Utah must be in writing and attached to this Contract or it is rendered null and void.
52. **SURVIVAL OF TERMS:** Termination or expiration of this Contract shall not extinguish or prejudice Eligible Users' right to enforce this Contract with respect to any default of this Contract or defect in the Procurement Item(s) that has not been cured, or of any of the following clauses, including: Governing Law and Venue, Laws and Regulations, Records Administration, Remedies, Dispute Resolution, Indemnity, Newly Manufactured, Indemnification Relating to Intellectual Property, Warranty of Procurement Item(s), Insurance.
53. **SEVERABILITY:** The invalidity or unenforceability of any provision, term, or condition of this Contract shall not affect the validity or enforceability of any other provision, term, or condition of this Contract, which shall remain in full force and effect.
54. **ERRORS AND OMISSIONS:** Contractor shall not take advantage of any errors and/or omissions in this Contract. The Contractor must promptly notify the Division of any errors and/or omissions that are discovered.
55. **ENTIRE AGREEMENT:** This Contract constitutes the entire agreement between the parties and supersedes any and all other prior and contemporaneous agreements and understandings between the parties, whether oral or written.

(Revision Date: 23 April 2020)



**NASPO ValuePoint
INTENT TO PARTICPATE
Cooperative Contract(s) for Small Package Delivery Services**

I. PURPOSE:

The purpose of this Agreement is to provide interested NASPO states with the opportunity to participate in multi-state cooperative contract(s) for the **Small Package Delivery Services SCOPE OF THE CONTRACT portfolio**

The State of **Utah** is authorized by agreement of the participants to act as the procurement officer in developing multi-state cooperative contract(s) for **Small Package Delivery Services**

The resulting contracts will be permissive contracts.

Administrative Fee

There will be a 0.25% NASPO ValuePoint administrative fee associated with these contracts. It is anticipated that the individual states will be able to add an administrative fee when the state executes its Participating Addendum.

II. TERM OF THE CONTRACT

The initial term of the contract will be established for **five years** from the date of award with options to extend the contract.

III. SOLICITATION AND CONTRACT DEVELOPMENT/ADDITIONAL INFORMATION

The solicitation and contract development shall be accomplished in compliance with the NASPO ValuePoint Process Guide and the NASPO Memorandum of Agreement for the NASPO cooperative purchasing program, incorporated herein by reference.

Solicitation Publication Period

Bidders/Offerors will be given at least 40 days after publication to submit proposals.

Solicitation Type and Evaluation Criteria

This RFP will be issued and evaluated in concert with the procurement laws and rules of the State of **Utah** by a sourcing team comprised of members from several states.

Award(s):

The solicitation will permit multiple awards.

Additional Requested Information

State Specific Terms and Conditions: If the participating state wishes to include any State specific terms and conditions with the release of this RFP, please attach those with this Intent to Participate.

Annual Estimated Volume: If your State has an existing contract for this commodity or service, please indicate your annual volume of spend (including any potential political subdivision usage if available).

Annual State Spend \$2,996,000.00

Annual Political Subdivision Spend \$1,606,000.00

Total Spend \$4,602,000.00

State of Arizona

Stephen Nettles

Director Name

602.542.9145

Director Phone

steve.nettles@azdoa.gov

Director Email

Director has approved submitting the ITP? Yes No
(Click appropriate box)

State Specific T&Cs to be included in RFP? Yes No
(Click appropriate box)

Charles Schmidt

State Point of Contact Name and Title

602.542.0100

Phone

Charles.schmidt@azdoa.gov

Email

Please email completed "Intent to Participate" document by March 11, 2021 to:

Tara Larwick

Cooperative Contract Coordinator

NASPO ValuePoint

tlarwick@naspovaluepoint.org

	<h2>Special Terms and Conditions</h2>	<p>State of Arizona State Procurement Office 100 North 15th Avenue, Suite 402 Phoenix, AZ 85007</p>
---	---------------------------------------	---

The Special Terms and Conditions modify the Uniform Terms and Conditions and its Appendices. It can modify them by replacing, deleting, appending to, or revising the text of an existing provision or by inserting a new paragraph into an existing article. No other document modifies or adds to the Uniform Terms and Conditions, except as may subsequently be otherwise and expressly agreed and incorporated by Contract Amendment.

1.0 Definition of Terms

As used in the Contract, the terms listed below are defined as follows:

- 1.1. Acceptance** "Acceptance" means the document headed "Offer and Acceptance Form" bearing the State contract number once Procurement Officer has signed it to signify (1) State's formal acceptance of the Accepted Offer and (2) the formation of the Contract. For clarity of intent, the foregoing is not to be confused with the term "acceptance" used throughout the Contract in the context of delivery, inspection, etc., with respect to Materials or Services.
- 1.2. Accepted Offer** If State did not request a Revised Offer, then "Accepted Offer" means the Initial Offer.
If State did request a Revised Offer but not a Best and Final Offer, then "Accepted Offer" means the latest Revised Offer.
If State requested a Best and Final Offer, then "Accepted Offer" means the Best and Final Offer.
- 1.3. Arizona Procurement Code; A.R.S.; A.A.C.** "Arizona Procurement Code, "A.R.S.," and "A.A.C." are each defined in the Instructions to Offerors.
- 1.4. Arizona TPT** "Arizona TPT" means Arizona Transaction Privilege Tax. For information, refer to the Arizona Department of Revenue (DOR) website at:
<https://www.azdor.gov/business/transactionprivilegetax.aspx>.
- 1.5. Attachment** "Attachment" means any item that:
- 1.5.1. the Solicitation required Offeror to submit as part of the relevant Offer (e.g., Initial Offer, Revised Offer, or BAFO);
 - 1.5.2. was attached to an Offer when submitted; and
 - 1.5.3. was included in the Accepted Offer.
- 1.6. Pricing Document** "Pricing Document" means Section 2-B of Part 2 of the Solicitation Documents, provided that, if there is no such Section in the Contract, then "Pricing Document" is to be construed as referring to whatever item in the Contract contains the contracted pricing and payment provisions.
- 1.7. Contract Amendment** "Contract Amendment" means a document signed by Procurement Officer that has been issued for the purpose of making changes to the Contract after execution.
- 1.8. Contract Terms and Conditions** "Contract Terms and Conditions" means the Special Terms and Conditions and these Uniform Terms and Conditions taken collectively.
- 1.9. Contractor** "Contractor" means the Person identified on the Accepted Offer who has entered into the Contract with State.
- 1.10. Contractor Indemnitor** "Contractor Indemnitor" means Contractor or any of its owners, officers, directors, agents, employees, or Subcontractors.
- 1.11. Co-Op Buyer** "Co-Op Buyer" means a member of the State Purchasing Cooperative that has entered into a "Cooperative Purchasing Agreement" with the Arizona Department of Administration State Procurement Office under A.R.S. § 41-2632. Unless there is an applicable Cooperative Purchasing Agreement in effect at the time, a State Purchasing Cooperative member cannot be a Co-Op Buyer. For reference, "Co-Op Buyer" is to be construed as encompassing "eligible procurement unit" under A.A.C. R2-7-101(23).
- NOTE: Membership in the State Purchasing Cooperative is open to all Arizona political subdivisions, including cities, counties, school districts, and special districts. Membership is also available to non-profit organizations, other state governments, the federal government and tribal nations. For reference, "non-profit organizations" are defined in A.R.S. § 41-2631(4) as any nonprofit corporation as designated by the IRS under section 501(c)(3) through 501(c)(6) of the tax code.

	<h2>Special Terms and Conditions</h2>	<p style="text-align: center;"> State of Arizona State Procurement Office 100 North 15th Avenue, Suite 402 Phoenix, AZ 85007 </p>
---	---------------------------------------	---

- 1.12. Eligible Agency** If the Special Terms and Conditions indicates that the Contract is a “single-agency” contract, then “Eligible Agency” means the particular State of Arizona agency, university, commission, or board identified therein. If the Special Terms and Conditions indicates that the Contract is a “statewide” contract, then “Eligible Agency” means any State of Arizona department, agency, university, commission, or board.
- 1.13. Indemnified Basic Claims** “Indemnified Basic Claims” means any and all claims, actions, liabilities, damages, losses, or expenses, including court costs, attorneys’ fees, and costs of claim processing, investigation and litigation, for bodily injury or personal injury, including death, or loss or damage to any real or tangible or intangible personal property, collectively. See paragraph 6.3.
- 1.14. Instructions to Offerors** “Instructions to Offerors” is Section 3-a of Part 3 of the Solicitation Documents.
- 1.15. Order** “Order” means the instrument by which State authorizes Contractor to perform some or all of the Work. Whether the Contract will have one Order or many Orders depends the scope of the Contract and how State will use it. The Special Terms and Conditions provide that information. Any of the following is to be construed as being an “Order”:
- .. “Release” or “Release Purchase Order” in The State’s e-Procurement System;
 - .. “task order”, “service order,” or “job order” when a Release Purchase Order for Services has already been committed in The State’s e-Procurement System; or
 - .. “purchase order” for buying by Co Op Buyers, if co-op buying applies.
- 1.16. The State’s e-Procurement System** “The State’s e-Procurement System” means State’s official electronic procurement system, established pursuant to A.A.C. R2-7-201 as set forth in the Arizona Department of Administration State Procurement Office policy document *Technical Bulletin No. 020, The State’s e-Procurement System – The Official State eProcurement System*.
NOTE (1): Technical Bulletin No. 020 is available online at:
<https://spo.az.gov/administration-policy/state-procurement-resource/procurement-regulations>
- 1.17. State** With respect to the Contract generally, “State” means the State of Arizona and its department, agency, university, commission, or board that has executed the Contract. With respect to administration or rights, remedies, obligations and duties under the Contract for a given Order, “State” means each of Eligible Agency or Co-Op Buyer who has issued the Order.
- 1.18. State Indemnities** “State Indemnities” means, collectively, the State of Arizona, its departments, agencies, universities, commissions, and boards and, and their respective officers, agents, and employees.
- 1.19. Subcontractor** “Subcontractor” has the meaning given in A.R.S. § 41-2503(38), which, for convenience of reference only, is “... a person who contracts to perform work or render service to ... [C]ontractor or to another [S]ubcontractor as a part of a contract with a state governmental unit . . .”The Contract is to be construed as “a contract with a state governmental unit” for purposes of the definition. For clarity of intent, a Person carrying out any element of the Work is a Subcontractor from the moment they first carry out that element of the Work regardless of whether or not a Subcontract exists then or subsequently.
- 1.20. Work** “Work” means the totality of the Materials and the Services and all the acts of administration, creation, production, and performance necessary to fulfill and incidental to fulfilling all of Contractor’s obligations and duties under the Contract in conformance with the Contract and applicable laws.

2.0 Contract Interpretation

- 2.1. Usage**
- 2.1.1. Where the Contract:
- 2.1.1.1. assigns obligations to Contractor, any reference to “Contractor” is to be construed to be a reference to “Contractor and all Subcontractors, whether they are first-tier subcontractors, sub-subcontractors, suppliers, sub-suppliers, consultants, or sub-consultants, as well as all of Contractor’s and the Subcontractors’ respective agents, representatives, and employees” in every instance unless the context plainly requires that it is be a reference only to Contractor as apart from Subcontractors;
 - 2.1.1.2. uses the permissive “may” with respect to a party’s actions, determinations, etc., the term is to be interpreted as in A.A.C. R2-7-101(31) [Definitions]. For clarity of intent, any right given to State

	<h2>Special Terms and Conditions</h2>	<p style="text-align: center;"> State of Arizona State Procurement Office 100 North 15th Avenue, Suite 402 Phoenix, AZ 85007 </p>
---	---------------------------------------	---

using “State may” or a like construction denotes discretion and freedom to act so far as any regulatory or operative constraints permit in the relevant circumstances, provided that:

2.1.1.2.1. where written “may, at its discretion,” the discretion extends to whatever is most advantageous to State; and

2.1.1.2.2. where written only as “may,” the discretion is constrained by what is fair, reasonable, and as accommodating of the respective best interests of both parties as practicable under the circumstances;

2.1.1.3. uses the imperative “shall” with respect to a party’s actions, duties, etc., the term is to be interpreted as in A.A.C. R2-7-101(43) [Definitions]. Conversely, the phrase “shall not” is to be interpreted as an imperative prohibition.

2.1.1.4. uses the term “must” with respect to a requirement, criterion, etc., the term is to be interpreted as conveying compulsion or strict necessity, and is to be read as though written “must, if [the subject] is to be entitled to have [the object] considered or credited as being compliant with, conforming to, or satisfying [the requirement, criterion, constraint, etc.], otherwise, [the object] will be considered or debited as being non compliant, non-conforming, or unsatisfactory for its Contract-related purposes” in every instance;

2.1.1.5. uses the term “might” with respect to an event, outcome, action, etc., the term is to be interpreted as conveying contingency or non-discretionary conditionality; and

2.1.1.6. uses the term “will” or the phrases “is to be” or “are to be” with respect to an event, outcome, action, etc., the term or phrase is to be interpreted as conveying such certainty or imperativeness that “shall” is either unnecessary or irrelevant in that instance.

2.2. Contract Order of Precedence

- 2.2.1. COMPLEMENTARY DOCUMENTS. All of the documents forming the Contract are complementary. If certain work, requirements, obligations, or duties are set out only in one but not in another, Contractor shall carry out the Work as though the relevant work, requirements, obligations, or duties had been fully described in all, consistent with the other documents forming the Contract and as is reasonably inferable from them as being necessary to produce complete results.
- 2.2.2. CONFLICTS. In case of any inconsistency, conflict, or ambiguity among the documents forming the Contract and their provisions, they are to prevail in the following order, descending from most dominate to most subordinate, provided that, among categories of documents or provisions having the same rank, the document or provision with the latest date prevails. Information being identified in one document but not in another is not to be considered a conflict or inconsistency.
- 2.2.2.1. State of Arizona Participating Addendum and Attachments A, B, and C;
- 2.2.2.2. Utah NASPO ValuePoint Master Agreement including all Addendums;
- 2.2.2.3. The Solicitation including all Addendums; and
- 2.2.2.4. Contract Vendors response to the Solicitation
- 2.2.3. ATTACHMENTS AND EXHIBITS. For clarity of intent, if an item was an Attachment in the Solicitation Documents or an Offer (either Initial, Revised, Best and Final, or Accepted) and was subsequently made into an Exhibit, or its content was incorporated into one of the other Contract documents, then that Attachment no longer exists contractually as an “Attachment” since it has at that point been made into some other Contract document. In every other case, an Attachment and the Offeror data therein remain part of the Accepted Offer for purposes of precedence and contractual effect.

2.3. Independent Contractor

Contractor is an independent contractor and shall act in an independent capacity in performance under the Contract. Neither party is or is to be construed as being to be the employee or agent of the other party, and no action, inaction, event, or circumstance will be grounds for deeming it to be so.

2.4. Complete Integration

The Contract, including any documents incorporated into the Contract by reference, is intended by the parties as a final and complete expression of their agreement. There are no prior, contemporaneous, or additional agreements, either oral or in writing, pertaining to the Contract.

	<h2 style="text-align: center;">Special Terms and Conditions</h2>	<p style="text-align: center;"> State of Arizona State Procurement Office 100 North 15th Avenue, Suite 402 Phoenix, AZ 85007 </p>
---	---	---

3.0 Contract Administration and Operation

- 3.1. Term of Contract** The term of the Contract will commence on the date indicated on the Execution page of the Participating Addendum and continue for twelve (12) months unless cancelled, terminated, or permissibly extended.
- 3.2. Contract Extensions** State may at its discretion extend the initial Contract term in increments of one or more months and do so one or more times, provided that, the maximum aggregate term of the Contract including extensions cannot exceed the maximum aggregate term of five (5) years.
- 3.3. Notices and Correspondence**
- 3.3.1. TO CONTRACTOR. State shall:
- 3.3.1.1. address all Contract correspondence other than formal notices to the email address indicated as "Default for Type" for "General Mailing Address" in Contractor's corresponding The State's e-Procurement System Vendor Profile; and
- 3.3.1.2. address any required notices to Contractor to the "Contact Name and Title" at the "Mailing Address" indicated on the Accepted Offer, as that address might have been amended during the term of the Contract.
- 3.3.2. TO STATE. Contractor shall :
- 3.3.2.1. address all Contract correspondence other than format notices to the email address indicated in "Contact Instructions" in the The State's e-Procurement System Summary for State; and
- 3.3.2.2. address any required notices to State to Procurement Officer identified as "Purchaser" in the State's e-Procurement System Summary at the following mailing address:
 Arizona Department of Administration
 State Procurement Office
 100 N 15th Ave., Suite 402
 Phoenix, AZ 85007
- 3.3.3. CHANGES. State may change the designated Procurement Officer, update contact information, or change the applicable mailing address by Contract Amendment.
- 3.4. Signing of Contract Amendments**
- 3.4.1. Contractor's counter-signature – or "approval" in The State's e-Procurement System, in the case of an amendment – is not required to give effect if the Contract Amendment only covers either:
- 3.4.1.1. extension of the term of the Contract within the maximum aggregate term;
- 3.4.1.2. revision to Procurement Officer appointment or contact information; or
- 3.4.1.3. modifications of a clerical nature that have no effect on terms, conditions, price, scope, or other material aspect of the Contract.
- 3.4.2. In every case other than those listed in (3.4.1.1), (3.4.1.2), and (3.4.1.3) above, both parties' signature – or "approval" in The State's e-Procurement System, in the case of an Amendment – are required to give it effect.
- 3.5. Click-Through Terms and Conditions**
- If either party uses a web based ordering system, an electronic purchase order system, an electronic order acknowledgement, a form of an electronic acceptance, or any software based ordering system with respect to the Contract (each an "Electronic Ordering System"), the parties acknowledge and agree that an Electronic Ordering System is for ease of administration only, and Contractor is hereby given notice that the persons using Electronic Ordering Systems on behalf of State do not have any actual or apparent authority to create legally binding obligations that vary from the terms and conditions of the Contract. Accordingly, where an authorized State user is required to "click through" or otherwise accept or be made subject to any terms and conditions in using an Electronic Ordering Systems, any such terms and conditions are deemed void upon presentation. Additionally, where an authorized State user is required to accept or be made subject to any terms and conditions in accessing or employing any Materials or Services, those terms and conditions will also be void.
- 3.6. Books and Records**
- 3.6.1. RETAIN RECORDS. By A.R.S. § 41-2548(B), Contractor shall retain and shall contractually require each Subcontractor to retain books and records relating for any cost and pricing data submitted in satisfaction of § 41-2543 for the period specified in the statute.
- 3.6.2. RIGHT TO AUDIT. The retained books and records are subject to audit by State during that period. By A.R.S. § 41-2548(B), Contractor shall retain and shall contractually require each Subcontractor to retain

	<h2 style="text-align: center;">Special Terms and Conditions</h2>	<p style="text-align: center;"> State of Arizona State Procurement Office 100 North 15th Avenue, Suite 402 Phoenix, AZ 85007 </p>
---	---	---

books and records relating to performance under the Contract for the period specified in the statute and those retained books and records are subject to audit by State during that period.

- 3.6.3. **AUDITING.** Contractor or Subcontractor shall either make all such books and records under subparagraphs 3.6.1 and 3.6.2 available to State at all reasonable times or produce the records at a designated State office on State's demand, the choice of which being at State's discretion. For the purpose of this paragraph, "reasonable times" are during normal business hours and in such a manner so as to not unreasonably interfere with normal business activities.

3.7. Contractor Licenses

Contractor shall maintain current all federal, state and local licenses and permits required for the operation of its business in general, for its operations under the Contract, and for the Work itself.

3.8. Inspection and Testing

By A.R.S. § 41-2547, State may at reasonable times inspect the part of Contractor's or Subcontractors' plant or places of business related to performance under the Contract. Accordingly, Contractor agrees to permit (for itself) and ensure (for Subcontractors) access for inspection at any reasonable time to its facilities, processes, and services. State may inspect or test, at its own cost, any finished goods, work-in-progress, components, or unfinished materials that are to be supplied under the Contract or that will be incorporated into something to be supplied under the Contract. If the inspection or testing shows non-conformance or defects, then Contractor will owe State reimbursement or payment of all costs it incurred in carrying out or contracting for the inspection and testing, as well as for any re-inspection or re-testing that might be necessary. Neither inspection of facilities nor testing of goods, work, components, or unfinished materials will of itself constitute acceptance by State of those things.

3.9. Ownership of Intellectual Property

- 3.9.1. **RIGHTS IN WORK PRODUCT.** All intellectual property originated or prepared by Contractor pursuant to the Contract, including but not limited to, inventions, discoveries, intellectual copyrights, trademarks, trade names, trade secrets, technical communications, records reports, computer programs and other documentation or improvements thereto, including Contractor's administrative communications and records relating to the Contract, are considered work product and Contractor's property, provided that, State has Government Purpose Rights to that work product as and when it was delivered to State.
- 3.9.1.1. "Government Purpose Rights" are:
- 3.9.1.1.1. the unlimited, perpetual, irrevocable, royalty free, non-exclusive, worldwide right to use, modify, reproduce, release, perform, display, sublicense, disclose and create derivatives from that work product without restriction for any activity in which State is a party;
 - 3.9.1.1.2. the right to release or disclose that work product to third parties for any State government purpose; and
 - 3.9.1.1.3. the right to authorize those to whom it rightfully releases or discloses that work product to use, modify, release, create derivative works from the work product for any State government purpose; such recipients being understood to include the federal government, the governments of other states, and various local governments.
- 3.9.1.2. "Government Purpose Rights" do not include any right to use, modify, reproduce, perform, release, display, create derivative works from, or disclose that work product for any commercial purpose or to authorize others to do so.
- 3.9.2. **JOINT DEVELOPMENTS.** The parties may each use equally any ideas, concepts, know-how, or techniques developed jointly during the course of the Contract, and may do so at their respective discretion, without obligation of notice or accounting to the other party.
- 3.9.3. **PRE-EXISTING MATERIAL.** All pre-existing software and other materials developed or otherwise obtained by or for Contractor or its affiliates independently of the Contract or applicable Purchase Orders are not part of the work product to which rights are granted State under subparagraph 3.9.1 above, and will remain the exclusive property of Contractor, provided that:
- 3.9.3.1. any derivative works of such pre-existing material or elements thereof that are created pursuant to the Contract are part of that work product;
 - 3.9.3.2. any elements of derivative work of such pre-existing material that was not created pursuant to the Contract are not part of that work product; and



Special Terms and Conditions

State of Arizona
 State Procurement Office
 100 North 15th Avenue, Suite 402
 Phoenix, AZ 85007

- 3.9.3.3. except as expressly stated otherwise, nothing in the Contract is to be construed to interfere or diminish Contractor's or its affiliates' ownership of such pre-existing materials.
- 3.9.4. DEVELOPMENTS OUTSIDE OF CONTRACT. Unless expressly stated otherwise in the Contract does not preclude Contractor from developing competing materials outside the Contract, irrespective of any similarity to materials delivered or to be delivered to State hereunder.
- 3.10. Subcontracts**
- 3.10.1. INITIAL LIST. At the time of the MMCAP Infuse Master Contract execution, Contractor's candidate Subcontractors were to be identified. Agreeing to them being included in the Accepted Offer signified Procurement Officer's advance consent for Contractor to enter into a Subcontract with each candidate, which Contractor shall do as promptly as necessary to ensure its ability to carry out the Work in a timely manner.
- 3.10.2. ADDITIONAL NAMES. Contractor shall not enter into a Subcontract without first obtaining Procurement Officer's written consent with any prospective Subcontractor that
- 3.10.1.1. was not identified at the time of the NASPO Master Contract execution or
- 3.10.1.2. for any Materials or Services categories other than the ones for which they were previously consented.
- 3.10.1.3. For either case (3.10.1.1.) or (3.10.1.2.), Contractor shall submit a written request sufficiently in advance of the need date for those materials or services so that performance under the Contract is not impaired. Procurement Officer may request any additional information he or she determines is necessary to assess the submittal, and may withhold consent pending it.
- 3.10.3. FLOW-DOWN. Contractor shall incorporate the provisions, terms, and conditions of the Contract into every Subcontract by inclusion or by reference, as appropriate. When making any post-execution consent requests, Contractor shall include its warrant that it will do the same for the pending Subcontracts covered by the request. Entering into Subcontracts will not relieve Contractor of any of its obligations or duties under the Contract, including, among other things, the duty to supervise and coordinate the work of Subcontractors. Nothing contained in any Subcontract will create or is to be construed as creating any contractual relationship between State and the Subcontractor.
- 3.11. Offshore Performance of Certain Work Prohibited**
- Contractor shall only perform those portions of the Services that directly serve State or its clients and involve access to secure or sensitive data or personal client data within the defined territories of the United States. Unless specifically stated otherwise in the Scope of Work, this paragraph does not apply to indirect or overhead services, redundant back-up services, or services that are incidental to performance under the Contract. This provision applies to work performed by Subcontractors at all tiers.
- 3.12. Orders**
- 3.12.1. ORDER SUFFICIENCY. The Contract was awarded in accordance with the Arizona Procurement Code; the transactions and procedures required by the code for competitive source selection have been met. An Order issued that cites the correct State contract number will suffice to authorize Contractor to provide the Materials and perform the Services covered by that Order.
- 3.12.2. ORDER TERMS. All Orders are subject to the Contract Terms and Conditions; an Order cannot modify the Contract Terms and Conditions.
- 3.12.3. ORDERS ARE OBLIGATORY. Until the expiration or earlier termination of the Contract, State may issue and Contractor shall accept Orders that make proper reference to the Contract and are permissible hereunder, provided that, Contractor is not obliged to accept any Order that is not consistent with the then-current pricing, lead times, specifications, or payment provisions of the Contract. Contractor shall fulfill and complete any Orders that are begun but not yet completed as of expiration or earlier termination of the Contract unless State instructs otherwise at the time.
- 3.12.4. SPECIAL CASE. In the special case where both the following conditions are true, Procurement Officer's signature on the Acceptance is Contractor's authorization to perform and therefore no Order is required:
- 3.12.4.1. the Contract is identified as being a "single-agency/single-project" contract and
- 3.12.4.2. the Contract was created in The State's e-Procurement System as something other than a "Master/ Blanket" type.
- 3.12.5. NO MINIMUMS OR COMMITMENTS.
- 3.12.5.1. Contractor shall not impose any minimum dollar amount, item count, services volume, or services duration on Orders;



Special Terms and Conditions

State of Arizona
 State Procurement Office
 100 North 15th Avenue, Suite 402
 Phoenix, AZ 85007

- 3.12.5.2. State makes no commitment of any kind concerning the quantity or monetary value of activity actually initiated or completed during the term of the Contract;
- 3.12.5.3. Contractor shall only deliver or perform as authorized by Orders; and
- 3.12.5.4. State is not limited as to the number of Orders it may issue for the Contract.
- 3.12.5.5. For clarity of intent, the foregoing applies equally whether an Eligible Agency issues the Order or, if applicable, a Co Op Buyer issues it.
- 3.12.6. NON-CONTRACTED MATERIALS OR SERVICES. Any attempt to knowingly represent for sales, marketing, or related purposes that goods or services not specifically awarded are under a State contract is a violation of the Contract and law.
- 3.13. Provisions for Statewide Contracts:**
- Co-Op Usage
 - Eligible Agencies
 - Quarterly Reporting
- 3.13.1. The Contract is a "statewide" contract for multiple purchases, projects, or assignments, and can be purchased against by some or all Eligible Agencies and any Co-Op Buyers that elect to participate. Even if only one Eligible Agency needs or elects to purchase against the Contract, it is to be construed as being a "statewide" contract hereunder.
- 3.13.2. The Contract is an indefinite delivery, indefinite quantity (ID/IQ) type of contract; it is to be construed as a "delivery order" sub type of ID/IQ contract to the extent the Work is Materials, and a "task order" sub-type to the extent the Work is Services
- 3.13.3. **Co-Op Usage**
- 3.13.3.1. Contractor shall verify if an ordering entity is a bona fide Co-Op Buyer before selling Materials to or providing Services for them under the Contract. The current list of Co Op Buyers is available on the State Procurement Office website:
<https://spo.az.gov/procurement-services/cooperative-procurement/state-purchasing-cooperative>
- 3.13.3.2. Contractor shall sell to Co-Op Buyers at the same price and on the same lead times and other terms and conditions under which it sells to Eligible Agencies, with the sole exception of any legitimately additional costs for extraordinary shipping or delivery requirements if the Co-Op Buyer is having Materials delivered or installed or Services performed at locations not contemplated in the contracted pricing (e.g. delivery to a location outside Arizona).
- 3.13.3.3. Contractor shall pay State an administrative fee against all Contract sales to Co Op Buyers, as provided for under A.R.S. § 41 2633. The fee rate is one (1%) percent. Failure to remit the administrative fees is a material breach of contract, and will entitle State to its remedies under Article 8 and its right to terminate for default under Article 9. Method of calculation, payment procedures, and other details are provided on the State Procurement Office website:
<https://spo.az.gov/contractor-resources/statewide-contracts-administrative-fee>
- 3.13.3.4. Contractor shall acknowledge each Order from Co-Op Buyers in conformance with each buyer's instructions given at the time of ordering or in any supplemental participating agreement Contractor might have with them. Orders from Co-Op Buyers create no obligation on State's part, since they are entirely between the Co-Op Buyer and Contractor. That notwithstanding, Contractor's obligation under the Contract is to service Co-Op Buyers commercially as though they were with an Eligible Agency, and Contractor's refusal to do so would be a material breach of the Contract.
- 3.13.4. **Eligible Agencies – Orders**
- 3.13.4.1. Contractor shall acknowledge each Order from Eligible Agencies within 1 (one) business day after receipt by either:
- 3.13.4.1.1. "Approving" the Order electronically in The State's e-Procurement System, which will indicate Contractor's unqualified acceptance of the Order as-issued; or,
- 3.13.4.1.2. "Rejecting" the Order electronically in The State's e-Procurement System, with a concurrent explanation by email to relevant originator as to the reason for rejecting it. By way of reminder, the only grounds on which Contractor may reject or refuse an Order are those set out in subparagraph 3.14.3 (Orders are Obligatory).



Special Terms and Conditions

State of Arizona
 State Procurement Office
 100 North 15th Avenue, Suite 402
 Phoenix, AZ 85007

3.13.4.2. Unless and until Contractor has approved the Order in the State's e-Procurement System, it will have no effect under the Contract and will not oblige either State or Contractor. If the relevant Eligible Agency explicitly instructs at the time that a verbal acceptance is sufficient because of urgency or other unusual circumstances and Contractor duly gives its verbal acceptance, then Contractor will be deemed to have accepted the Order immediately upon commencing performance, provided that, Contractor must follow-up its verbal acceptance by accepting the Purchase Order electronically In The State's e-Procurement System within three (3) business days. Contractor shall thereafter be barred from subsequently rejecting the Order in The State's e-Procurement System and if it does so the rejection will be void.

3.13.5. Quarterly Usage Reports

3.13.5.1.1. Contractor shall submit to State a Quarterly Usage Report documenting all Contract sales to both Eligible Agencies and Co Op Buyers, itemized separately. A Quarterly Usage Report shall still be submitted, even if there have been no sales to either Eligible Agencies and/or Co-Op Buyers. Contractor shall further itemize divisions, groups or areas within a given Eligible Agency if they place Orders independently of each other. Failure to submit the report is a material breach of contract, and will entitle State to its remedies under Article 8 and its right to terminate for default under Article 9. Contractor shall submit the report using the forms and following the instructions on the State Procurement Office website:

<https://spo.az.gov/contractor-resources/statewide-contracts-administrative-fee>

3.14. Multiple-Use Provisions

3.14.1. Eligible Agencies may issue Orders for Services in several forms, all of which become final and effective by a "Release Purchase Order" in The State's e-Procurement System. Orders issued by Co-Op Buyers will be in whatever form the Co-Op Buyer normally uses. Regardless of origin, Orders must cite the State contract number to be valid. State may, at its discretion in each instance, determine the scope, schedule, and price for each Order in any of the following ways:

- 3.14.1.1. By choosing some or all of the Materials or Services items covered by the Contract for which a price is established in the Pricing Document, then preparing an Order using those prices (e.g., filling out an order form), and sending it to Contractor.
- 3.14.1.2. By instructing Contractor to provide a comprehensive proposal of item quantities, combinations, etc., or services hours, personnel, etc., for a defined scope using those established prices as a basis, then validating and negotiating the proposal with Contractor and issuing an Order if and when reaching agreement.
- 3.14.1.3. As described in (3.14.1.2.) above but requesting the proposal from both Contractor and other vendors who are contracted within the applicable scope categories and locations, either sequentially or concurrently, then selecting the proposal or proposals combination that is most advantageous to State.
- 3.14.1.4. As described in (3.14.1.3.) above but introducing ad-hoc commercial competition by making the selection and ordering conditional on obtaining more favorable prices than the contractually-established ones.

3.14.2. When evaluating the proposals under (3) and (4) above, State may select based on price (for example, a quoted number of hours times the contracted or improved rate plus a fixed amount for incidentals), by experience and qualifications (for example, having an office nearer the required work location), or whatever combination thereof it determines is most appropriate to the work in question.

3.15. Other Contractors

State may undertake with its own forces or award other contracts to the same or other vendors for additional or related work. In such cases, Contractor shall cooperate fully with State's employees and such other vendors and carefully coordinate, fit, connect, accommodate, adjust, or sequence its work to the related work by others. Where the Contract requires handing-off Contractor's work to others, Contractor shall cooperate as State instructs regarding the necessary transfer of its work product, services, or records to State or the other vendors. Contractor shall not commit or permit any act that interferes with the State's or other vendors' performance of their work, provided that, State shall enforce the foregoing section equitably among all its vendors so as not impose an unreasonable burden on any one of them.

3.16. Work on State Premises

3.16.1. COMPLIANCE WITH RULES. Contractor is responsible for ensuring that its personnel comply with State's rules, regulations, policies, documented practices, and documented operating procedures while delivering or installing Materials or performing Services on State's grounds or in its facilities. For clarity of



Special Terms and Conditions

State of Arizona
 State Procurement Office
 100 North 15th Avenue, Suite 402
 Phoenix, AZ 85007

intent, the foregoing means that if Contractor is required to comply with certain security requirements in order to deliver, install, or perform at that particular location, then it shall do so nonetheless and without entitlement to any additional compensation or additional time for performance if those particular requirements are not expressly stated in the Contract. Contractor is reminded that violation of the prohibition under A.R.S. § 13-1502 against possession of weapons on State's property by anyone for whom Contractor is responsible is a material breach of contract and grounds for termination for default.

- 3.16.2. PROTECTION OF GROUNDS AND FACILITIES. Contractor shall deliver or install the Materials and perform the Services without damaging any State grounds or facilities. Contractor shall repair or replace any damage it does cause promptly and at its own expense, subject to whatever instructions and restrictions State needs to make to prevent inconvenience or disruption of operations. If Contractor fails to make the necessary repairs or replacements and do so in a timely manner, State will be entitled to exercise its remedies under paragraph 8.5 [Right of Offset] of the Uniform Terms and Conditions.

4.0 Costs and Payments

4.1. Payments

- 4.1.1. PAYMENT DEADLINE. State shall make payments in compliance with Arizona Revised Statutes Titles 35 and 41. Unless and then only to the extent expressly stated otherwise in the Pricing Document, State shall make payment in full for Materials that have been delivered and accepted and Services that have been performed and accepted within the time specified in A.R.S. § 35-342 after both of the following become true:
- 4.1.1.1. all of the Materials being invoiced have been delivered or installed (as applicable) and accepted and all of the Services being invoiced have been performed and accepted; and
- 4.1.1.2. Contractor has provided a complete and accurate invoice in the form and manner called for in the Pricing Document, provided that, State will not make or be liable for any payments to Contractor until Contractor has registered properly in The State's e-Procurement System and provided a current IRS Form W-9 to State unless excused by law from providing one.
- 4.1.2. PAYMENTS ONLY TO CONTRACTOR. Unless compelled otherwise by operation of law or order of a court of competent jurisdiction, State will only make payment to Contractor under the federal tax identifier indicated on the Accepted Offer.

4.2. Applicable Taxes

- 4.2.1. CONTRACTOR TO PAY ALL TAXES. State is subject to Arizona TPT. Therefore, Arizona TPT applies to all sales under the Contract and Arizona TPT is Contractor's responsibility (as seller) to remit. Contractor's failure to collect Arizona TPT or any other applicable sales or use taxes from an Eligible Agency or Co-Op Buyer (as buyer) will not relieve Contractor of any obligation to remit sales or use taxes that are due under the Contract or laws. Unless stated otherwise in the Pricing Document, all prices therein include Arizona TPT as well as every other manner of transaction privilege or sales/use tax that is due to a municipality or another state or its political subdivisions. Contractor shall pay all federal, state, and local taxes applicable to its operations and personnel.
- 4.2.2. TAX INDEMNITY. Contractor shall hold State harmless from any responsibility for taxes or contributions, including any applicable damages and interest, that are due to federal, state, and local authorities with respect to the Work and the Contract, as well any related costs; the foregoing expressly includes Arizona TPT, unemployment compensation insurance, social security, and workers' compensation insurance.

5.0 Contract Changes

5.1. Contract Amendments

The Contract is issued for State under the authority of Procurement Officer. Only a Contract Amendment can modify the Contract, and then only if it does not change the Contract's general scope. Purported changes to the Contract by a person not expressly authorized by Procurement Officer or made unilaterally by Contractor will be void and without effect; Contractor will not be entitled to any claim made under the Contract based on any such purported changes.

5.2. Assignment and Delegation

5.2.1. IN WHOLE. Contractor shall not assign in whole its rights or delegate in whole its duties under the Contract without Procurement Officer's prior written consent, which consent Procurement Officer may withhold at his or her discretion. If Contractor's proposed assignment or delegation stems from a split, sale, acquisition, or other non-merger change in control, then no such consent will be given in any event without the assignee or delegate giving State satisfactory and equivalent evidence or assurance of its financial soundness, competency, capacity, and qualification to perform as that which Contractor possessed when State first awarded it the Contract.

	<h2>Special Terms and Conditions</h2>	<p>State of Arizona State Procurement Office 100 North 15th Avenue, Suite 402 Phoenix, AZ 85007</p>
---	---------------------------------------	---

5.2.2. IN PART. Subject to paragraph 3.10 [Subcontracts] with respect to subcontracting, Contractor may assign particular rights or delegate particular duties under the Contract, but shall obtain Procurement Officer's written consent before doing so. Procurement Officer shall not unreasonably withhold consent so long as the proposed assignment or delegation does not attempt to modify the Contract in any way or to alter or impair State's rights or remedies under the Contract or laws.

6.0 Risk and Liability

6.1. Risk of Loss

Contractor shall bear all risk of loss to Materials while in pre-production, production, storage, transit, staging, assembly, installation, testing, and commissioning, if and as those duties are within the scope of the Work, until they have been accepted as conforming by State in the particular location and situation specified in the Order, or as specified generally elsewhere in the Contract if the Order does not provide particulars, provided that, risk of loss for nonconforming Materials will remain with Contractor notwithstanding acceptance to the extent the loss stems from the nonconformance.

6.2. Contractor Insurance

6.2.1. Contractor and subcontractors shall procure and maintain until all of their obligations have been discharged, including any warranty periods under this Contract, are satisfied, insurance against claims for injury to persons or damage to property which may arise from or in connection with the performance of the work hereunder by the Contractor, his agents, representatives, employees or subcontractors.

6.2.2. The insurance requirements herein are minimum requirements for this Contract and in no way limit the indemnity covenants contained in this Contract. The State of Arizona in no way warrants that the minimum limits contained herein are sufficient to protect the Contractor from liabilities that might arise out of the performance of the work under this contract by the Contractor, its agents, representatives, employees or subcontractors, and Contractor is free to purchase additional insurance.

MINIMUM SCOPE AND LIMITS OF INSURANCE: Contractor shall provide coverage with limits of liability not less than those stated below.

1. Commercial General Liability (CGL) – Occurrence Form

Policy shall include bodily injury, property damage personal injury and broad form contractual liability coverage

General Aggregate	\$2,000,000
Products – Completed Operations Aggregate	\$1,000,000
Personal and Advertising Injury	\$1,000,000
Damage to Rented Premises	\$ 50,000
Each Occurrence	\$1,000,000

- a. The policy shall be endorsed, as required by this written agreement, to include the State of Arizona, and its departments, agencies, boards, commissions, universities, officers, officials, agents, and employees as additional insureds with respect to liability arising out of the activities performed by or on behalf of the Contractor.
- b. Policy shall contain a waiver of subrogation endorsement, as required by this written agreement, in favor of the State of Arizona, and its departments, agencies, boards, commissions, universities, officers, officials, agents, and employees for losses arising from work performed by or on behalf of the Contractor.

2. Business Automobile Liability

Bodily Injury and Property Damage for any owned, hired, and/or non-owned vehicles used in the performance of this Contract.

Combined Single Limit (CSL)	\$1,000,000
-----------------------------	-------------

- a. Policy shall be endorsed, as required by this written agreement, to include the State of Arizona, and its departments, agencies, boards, commissions, universities and its officers, officials, agents, and employees as additional insureds with respect to liability arising out of the activities performed by, or on behalf of, the Contractor, involving automobiles owned, leased, hired and/or non-owned by the Contractor.
- b. Policy shall contain a waiver of subrogation endorsement as required by this written agreement in favor of the State of Arizona, and its departments, agencies, boards, commissions, universities, officers,



Special Terms and Conditions

State of Arizona
 State Procurement Office
 100 North 15th Avenue, Suite 402
 Phoenix, AZ 85007

officials, agents, and employees for losses arising from work performed by or on behalf of the Contractor.

3. Worker's Compensation and Employers' Liability

Workers' Compensation.....	Statutory
Each Accident	\$1,000,000
Disease – Each Employee	\$1,000,000
Disease – Policy Limit	\$1,000,000

- a. Policy shall contain a waiver of subrogation endorsement as required by this written agreement in favor of the State of Arizona, and its departments, agencies, boards, commissions, universities, officers, officials, agents, and employees for losses arising from work performed by or on behalf of the Contractor.
- b. This requirement shall not apply to each Contractor or subcontractor that is exempt under A.R.S. 23-901, and when such contractor or subcontractor executes the appropriate waiver form (Sole Proprietor/Independent Contractor).

ADDITIONAL INSURANCE REQUIREMENTS: The policies shall include, or be endorsed to include, the following provisions:

1. The Contractor's policies, as applicable, shall stipulate that the insurance afforded the Contractor shall be primary and that any insurance carried by the Department, its agents, officials, employees or the State of Arizona shall be excess and not contributory insurance, as provided by A.R.S. § 41-621 E
2. Insurance provided by the Contractor shall not limit the Contractor's liability assumed under the indemnification provisions of this Contract.

NOTICE OF CANCELLATION: Applicable to all insurance policies required within the Insurance Requirements of this Contract, Contractor's insurance shall not be permitted to expire, be suspended, be canceled, or be materially changed for any reason without thirty (30) days prior written notice to the State of Arizona. Within two (2) business days of receipt, Contractor must provide notice to the State of Arizona if they receive notice of a policy that has been or will be suspended, canceled, materially changed for any reason, has expired, or will be expiring. Such notice shall be sent directly to the Department and shall be mailed, emailed, hand delivered or sent by facsimile transmission to State Procurement Office.

ACCEPTABILITY OF INSURERS: Contractor's Insurance shall be placed with companies licensed in the State of Arizona or hold approved non-admitted status on the Arizona Department of Insurance List of Qualified Unauthorized Insurers. Insurers shall have an "A.M. Best" rating of not less than A- VII. The State of Arizona in no way warrants that the above-required minimum insurer rating is sufficient to protect the Contractor from potential insurer insolvency.

VERIFICATION OF COVERAGE: Contractor shall furnish the State of Arizona with certificates of insurance (valid ACORD form or equivalent approved by the State of Arizona) evidencing that Contractor has the insurance as required by this Contract. An authorized representative of the insurer shall sign the certificates.

All such certificates of insurance and policy endorsements must be received by the State before work commences. The State's receipt of any certificates of insurance or policy endorsements that do not comply with this written agreement shall not waive or otherwise affect the requirements of this agreement.

Each insurance policy required by this Contract must be in effect at, or prior to, commencement of work under this Contract. Failure to maintain the insurance policies as required by this Contract, or to provide evidence of renewal, is a material breach of contract.

All such certificates required by this Contract shall be sent directly to the Arizona State Procurement Office. The State of Arizona project/contract number and project description shall be noted on the certificate of insurance. The State of Arizona reserves the right to require complete, certified copies of all insurance policies required by this Contract at any time.

SUBCONTRACTORS: Contractors' certificate(s) shall include all subcontractors as insured under its policies or Contractor shall be responsible for ensuring and/or verifying that all subcontractors have valid and collectable insurance as evidenced by the certificates of insurance and endorsements for each subcontractor. All coverages for subcontractors shall be subject to the minimum Insurance Requirements identified above. The Department reserves the right to require, at any time throughout the life of this contract, proof from the Contractor that its subcontractors have the required coverage.

APPROVAL and MODIFICATIONS: The Contracting Agency, in consultation with State Risk, reserves the right to review or make modifications to the insurance limits, required coverage's, or endorsements throughout the life of this contract, as deemed necessary. Such action will not require a formal Contract amendment but may be made by administrative action.

	<h2>Special Terms and Conditions</h2>	<p style="text-align: center;"> State of Arizona State Procurement Office 100 North 15th Avenue, Suite 402 Phoenix, AZ 85007 </p>
---	---------------------------------------	---

EXCEPTIONS: In the event the Contractor or sub-contractor(s) is/are a public entity, then the Insurance Requirements shall not apply. Such public entity shall provide a Certificate of self-insurance. If the Contractor or sub-contractor(s) is/are a State of Arizona agency, board, commission, or university, none of the above shall apply.

6.3. Indemnification

- 6.3.1. To the fullest extent permitted by law, Contractor shall defend, indemnify, and hold harmless the State of Arizona, and its departments, agencies, boards, commissions, universities, officers, officials, agents, and employees (hereinafter referred to as "Indemnitee") from and against any and all claims, actions, liabilities, damages, losses, or expenses (including court costs, attorneys' fees, and costs of claim processing, investigation and litigation) (hereinafter referred to as "Claims") for bodily injury or personal injury (including death), or loss or damage to tangible or intangible property caused, or alleged to be caused, in whole or in part, by the negligent or willful acts or omissions of Contractor or any of its owners, officers, directors, agents, employees or subcontractors. This indemnity includes any claim or amount arising out of, or recovered under, the Workers' Compensation Law or arising out of the failure of such Contractor to conform to any federal, state, or local law, statute, ordinance, rule, regulation, or court decree. It is the specific intention of the parties that the Indemnitee shall, in all instances, except for Claims arising solely from the negligent or willful acts or omissions of the Indemnitee, be indemnified by Contractor from and against any and all claims. It is agreed that Contractor will be responsible for primary loss investigation, defense, and judgement costs where this indemnification is applicable. In consideration of the award of this contract, the Contractor agrees to waive all rights of subrogation against the State of, its officers, officials, agents, and employees for losses arising from the work performed by the Contractor for the State of Arizona. This indemnification will survive the termination of the above listed contract with the Contractor.
- 6.3.2. This indemnity shall not apply if the Contractor or sub-contractor(s) is/are an agency, board, commission or university of the State of Arizona.

6.4. Patent and Copyright Indemnification

- 6.4.1. CONTRACTOR/VENDOR (NOT PUBLIC AGENCY). With respect to Materials or Services provided or proposed by a Contractor Indemnitor for performance under the Contract, Contractor shall indemnify, defend and hold harmless State Indemnitees against any third-party claims for liability, costs, and expenses, including, but not limited to reasonable attorneys' fees, for infringement or violation of any patent, trademark, copyright, or trade secret by the Materials and the Services. With respect to the defense and payment of claims under this subparagraph:
- 6.4.1.1. State shall provide reasonable and timely notification to Contractor of any claim for which Contractor may be liable under this paragraph;
- 6.4.1.2. Contractor, with reasonable consultation from State, shall have control of the defense of any action on an indemnified claim including all negotiations for its settlement or compromise;
- 6.4.1.3. State may elect to participate in such action at its own expense; and
- 6.4.1.4. State may approve or disapprove any settlement or compromise, provided that, (i) State shall not unreasonably withhold or delay such approval or disapproval and (ii) State shall cooperate in the defense and in any related settlement negotiations.
- 6.4.2. If Contractor is a public agency, this paragraph 6.4 does not apply.

6.5. Force Majeure

- 6.5.1. DEFINITION. For this paragraph, "force majeure" means an occurrence that is (a) beyond the control of the affected party, (b) occurred without the party's fault or negligence, and (c) something the party was unable to prevent by exercising reasonable diligence. Without limiting the generality of the foregoing, force majeure expressly includes acts of God, acts of the public enemy, war, riots, strikes, mobilization, labor disputes, civil disorders, fire, flood, lockouts, injunctions-intervention-acts, failures or refusals to act by government authorities, and, subject to paragraph 7.66 [*Performance in Public Health Emergency*], declared public health emergencies. Force majeure expressly does not include late delivery caused by congestion at a manufacturer's plant or elsewhere, an oversold condition of the market, late performance by a Subcontractor unless the delay arises out of an occurrence of force majeure, or inability of either Contractor or any Subcontractor to acquire or maintain any required insurance, bonds, licenses, or permits.
- 6.5.2. RELIEF FROM PERFORMANCE. Except for payment of sums due, the parties are not liable to each other if an occurrence of force majeure prevents its performance under the Contract. If either party is delayed at any time in the progress of their respective performance under the Contract by an occurrence of force majeure, the delayed party shall notify the other no later than the following working day after the occurrence, or as soon as it could reasonably have been expected to recognize that the occurrence had effect in cases where the effects were not readily apparent. In any event, the notice must make specific reference to this paragraph specifying the causes of the delay in the notice and, if the effects of the occurrence are on-going, provide an initial notification and

	<h2>Special Terms and Conditions</h2>	<p style="text-align: center;"> State of Arizona State Procurement Office 100 North 15th Avenue, Suite 402 Phoenix, AZ 85007 </p>
---	---------------------------------------	---

thereafter the delayed party shall provide regular updates until such time as the effects are fully known. To the extent it is able, the delayed party shall cause the delay to cease promptly and notify the other party when it has done so. The parties shall extend the time of completion by Contract Amendment for a period equal to the time that the results or effects of the delay prevented the delayed party from performing.

- 6.5.3. EXCUSABLE DELAY IS NOT DEFAULT. Failure in performance by either party will not constitute default hereunder or give rise to any claim for damages or loss of anticipated profits if and to the extent that such failure was or is being caused by an occurrence of force majeure.
- 6.5.4. DEFAULT DIMINISHES RELIEF. Entitlement to relief from the effects of an occurrence of force majeure is diminished to the extent that the delay did or will result from the affected party's default unrelated to the occurrence, in which case and to that extent the other party's normal remedies and the affected party's obligations would apply undiminished.

6.6. Third Party Antitrust Violations

Contractor assigns to State any claim for overcharges resulting from antitrust violations to the extent that those violations concern materials or services supplied by third parties to Contractor toward fulfillment of the Contract.

7.0 Warranties

- 7.1. Conformity to Requirements**
- 7.1.1. Contractor warrants that, unless expressly provided otherwise elsewhere in the Contract, the Materials and Services will for 1 (one) year after acceptance and in each instance:
- 7.1.1.1. conform to the requirements of the Contract, which by way of reminder include without limitation all descriptions, specifications, and drawings identified in the Scope of Work and any Contractor affirmations included as part of the Contract;
 - 7.1.1.2. be free from defects of material and workmanship;
 - 7.1.1.3. conform to or perform in a manner consistent with current industry standards; and
 - 7.1.1.4. be fit for the intended purpose or use described in the Contract.
- 7.1.2. Mere delivery or performance does not substitute for express acceptance by State. Where inspection, testing, or other acceptance assessment of Materials or Services cannot be done until after installation, the forgoing warranty will not begin until State's acceptance.
- 7.2. Contractor Personnel**
- Contractor warrants that its personnel will perform their duties under the Contract in a professional manner, applying the requisite skills and knowledge, consistent with industry standards, and in accordance with the requirements of the Contract. Contractor further warrants that its key personnel will maintain any certifications relevant to their work, and Contractor shall provide individual evidence of certification to State's authorized representatives upon request.
- 7.3. Intellectual Property**
- Contractor warrants that the Materials and Services do not and will not infringe or violate any patent, trademark, copyright, trade secret, or other intellectual property rights or laws, except only to the extent the Specifications do not permit use of any other product and Contractor is not and cannot reasonably be expected to be aware of the infringement or violation.
- 7.4. Licenses and Permits**
- Contractor warrants that it will maintain all licenses required under paragraph 3.7 [*Contractor Licenses*] and all required permits valid and in force.
- 7.5. Operational Continuity**
- Contractor warrants that it will perform without relief notwithstanding being sold or acquired; no such event will operate to mitigate or alter any of Contractor's duties hereunder absent a consented delegation under paragraph 5.2 [*Assignment and Delegation*] that expressly recognizes the event.
- 7.6. Performance in Public Health Emergency**
- 7.6.1. Contractor warrants that it will:
- 7.6.1.1. have in effect promptly after commencement a plan for continuing performance in the event of a declared public health emergency that addresses, at a minimum:
 - 7.6.1.1.1. identification of response personnel by name;
 - 7.6.1.1.2. key succession and performance responses in the event of sudden and significant decrease in workforce; and
 - 7.6.1.1.3. alternative avenues to keep sufficient product on hand or in the supply chain; and

	<h2>Special Terms and Conditions</h2>	<p align="center"> State of Arizona State Procurement Office 100 North 15th Avenue, Suite 402 Phoenix, AZ 85007 </p>
---	---------------------------------------	--

7.6.1.1.4. provide a copy of its current plan to State within 3 (three) business days after State's written request. If Contractor claims relief under paragraph 6.5 [Force Majeure] for an occurrence of force majeure that is a declared public health emergency, then that relief will be conditioned on Contractor having first implemented its plan and exhausted all reasonable opportunity for that plan implementation to overcome the effects of that occurrence, or mitigate those effects to the extent that overcoming entirely is not practicable.

7.6.2. For clarification of intent, being obliged to implement the plan is not of itself an occurrence of force majeure, and Contractor will not be entitled to any additional compensation or extension of time by virtue of having to implement it. Furthermore, failure to have or implement an appropriate plan will be a material breach of contract.

7.7. Lobbying

7.7.1. PROHIBITION.

7.7.1.1. Contractor warrants that:

7.7.1.1.1. it will not engage in lobbying activities, as defined in 40 CFR part 34 and A.R.S. § 41-1231, et seq., using monies awarded under the Contract, provided that, the foregoing does not intend to constrain Contractor's use of its own monies or property, including without limitation any net proceeds duly realized under the Contract or any value thereafter derived from those proceeds; and

7.7.1.1.2. upon award of the Contract, it will disclose all lobbying activities to State to the extent they are an actual or potential conflict of interest or where such activities could create an appearance of impropriety.

7.7.1.2. Contractor shall implement and maintain adequate controls to assure compliance with (a) above.

7.7.1.3. Contractor shall obtain an equivalent warranty from all Subcontractors and shall include an equivalent no-lobbying provision in all Subcontracts.

7.7.2. EXCEPTION. This paragraph does not apply to the extent that the Services are defined in the Contract as being lobbying for State's benefit or on State's behalf.

7.8. Survival of Warranties

All representations and warrants made by Contractor under the Contract will survive the expiration or earlier termination of the Contract.

8.0 State's Contractual Remedies

No modifications to uniform terms and conditions section

9.0 Contract Termination

No modifications to uniform terms and conditions section

10.0 Contract Claims

10.1 Claim Resolution

Notwithstanding any law to the contrary, all contract claims or controversies under the Contract are to be resolved according to Arizona Revised Statutes Title 41, Chapter 23, Article 9, and rules adopted thereunder, including judicial review under A.R.S. § 12-1518.

10.2 Mandatory Arbitration

In compliance with A.R.S. § 12-1518, the parties agree to comply in a judicial review proceeding with any applicable, mandatory arbitration requirements.

11. General Provisions for Materials

11.1. Applicability

Article 11 applies to the extent the Work is or includes Materials.

11.2. Off-Contract Materials

Contractor shall ensure that the design and/or procedures for the Materials ordering method prevents Orders for off-contract items or excluded items. Notwithstanding that State might have its own internal administrative rules regarding off-contract or excluded item ordering, and endeavors to prevent such orders from occurring, Contractor

	<h2 style="text-align: center;">Special Terms and Conditions</h2>	<p style="text-align: center;"> State of Arizona State Procurement Office 100 North 15th Avenue, Suite 402 Phoenix, AZ 85007 </p>
---	---	---

is responsible for not accepting any such Orders, State may, at its discretion, return any such items under subparagraph 11.17 or cancel any such Order under subparagraph 11.18, neither case being without obligation and at Contractor's expense. As used above, "off-contract item" refers to any product not included in the scope of the Contract and for which no price or compensation has been established contractually, and "excluded item" refers to any product expressly stated in the Contract as being excluded from the Contract.

- 11.3. Compensation for Late Deliveries** Contractor shall have clear, published policies in place regarding late delivery, order cancelation, discounts, or rebates given to compensate for late deliveries, etc., and make them readily available to those Eligible Agencies, and Co-Op Buyers if applicable, that are likely to need them.
- 11.4. Indicate Shipping Costs on Order** Contractor shall identify and provide the required substantiating documentation for the amount it intends to add for shipping in the Order acknowledgment if shipping is additional to the contracted price or rate for an item; otherwise, Contractor shall indicate that shipping is included in the Order price (in other words, every Order must indicate clearly whether or not shipping is included in the Order price, and if not included, how much is to be added and why that amount is the correct or appropriate one)
- 11.5. Current Products** Contractor shall keep all products being offered under the Contract: (a) in current and ongoing production; (b) in its advertised product lines; (c) as models or types that are actively functioning in other paying customer environments; and (d) in conformance to the requirements of the Contract
- 11.6. Maintain Comprehensive Selection** Contractor shall provide at all times the comprehensive selection of products for which a price is established in the Commercial Document for ordering by Eligible Agencies, and Co-Op Buyers if applicable.
- 11.7. Additional Products**
- 11.7.1. State, at its discretion, may modify the scope of the Contract by Contract Amendment to include additional products or product categories so long as they are within the general scope of the ones originally covered by the Contract. Once the Contract Amendment has been fully executed, Contractor shall then update all applicable catalogs and price lists and make them available to all affected entities at no additional cost. Either party may make the request to add products to the Contract; regardless of who makes the request, the parties shall negotiate in good faith a fair price for any additional products, but State may elect not to add some or all of the products in question if no agreement is reached on pricing in a timely manner. Contractor's request or proposal in response to State's request must include:
- 11.7.1.1. documentation demonstrating that the additional products meet or exceed the specifications for the original products while remaining in the same product groups as the original ones; and
- 11.7.1.2. documentation demonstrating that the proposed price for the additional products is both fair and reasonable and at the same level of discount relative to market price as were the original ones. Demonstration of this typically requires showing how prices at which sales are currently or were last made to a significant number of buyers compare to the prices or discounts (as applicable) being proposed for the additional products
- 11.8. Discounted products**
- 11.8.1. If a product or groups of products covered by the Contract are discontinued by the manufacturer, Contractor shall notify State within 5 (five) business days after receiving the manufacturer's notification. State, at its discretion, will either allow Contractor to provide substitutes for the discontinued products or delete the products from the scope of the Contract, both of which will be accomplished by Contract Amendment. Contractor shall then update all applicable catalogs and price lists and make them available to all affected entities at no additional cost. The parties shall negotiate in good faith a fair price for any substitute product, but State may elect to delete the products from the scope of the Contract if no agreement is reached on substitute pricing in a timely manner. When notifying State of the discontinuance, Contractor shall provide:
- 11.8.1.1. manufacturer's announcement or documentation stating that the products have been discontinued, with identification by model/part number;
- 11.8.1.2. documentation demonstrating that the substitute products meet or exceed the specifications for the discontinued products while remaining in the same product groups as were the discontinued ones; and

	<h2 style="text-align: center;">Special Terms and Conditions</h2>	<p style="text-align: center;">State of Arizona State Procurement Office 100 North 15th Avenue, Suite 402 Phoenix, AZ 85007</p>
---	---	---

11.8.1.3. documentation demonstrating that the proposed price for the substitute products is both fair and reasonable and at the same level of discount relative to market price as were the discontinued ones.

- 11.9. Forced Substitutes** Forced substitutions will not be permitted; Contractor shall obtain State's prior written consent before making any discretionary substitution for any product covered by the Contract.
- 11.10. Recalls** In the event of a recall notice, technical service bulletin, or other important notification affecting a product offered under the Contract (collectively, "recalls" hereinafter), Contractor shall send timely notice to State for each applicable Order referencing the affected Order and product. Notwithstanding whatever protection Contractor might have under A.R.S. § 12-684 with respect to a manufacturer, Contractor shall handle recalls entirely and without obligation on State's part, other than to permit removal of installed products, retrieval of stored products, etc., as necessary to implement the recall
- 11.11. Delivery**
- 1.11.1. **PRICING.** Unless stated otherwise in the Commercial Document, all Materials prices set forth therein are FCA (seller's dock) Incoterms®2010, with "seller's dock" meaning the last place of manufacturing, assembly, integration, final packing, or warehousing before departure to designated point of delivery to State. For reference, the foregoing is to be construed as equivalent to "F.o.b. Origin, Contractor's Facility" under [FAR 52.247-30](#)
- 1.11.2. **LIABILITY.** Unless stated otherwise in the Commercial Document or an Order, Contractor's liability for all Materials is DDP (State-designated receiving point per Order) Incoterms®2010, but with unloading at destination included. For reference, the foregoing is to be construed as equivalent to "F.o.b. Destination, Within Consignee's Premises" under [FAR 52.247-35](#).
- 1.11.3. **PAYMENT.** Unless stated otherwise in the Commercial Document or an Order, State shall reimburse Contractor the costs of the difference between DDP (State-designated receiving point per Order) and FCA (seller's dock) with no mark-up, which Contractor shall itemize and invoice separately
- 11.12. Delivery Time** Unless stated otherwise in the Commercial Document generally or in the applicable Order particularly, Contractor shall make delivery within 2 (two) business days after receiving each Order
- 11.13. Delivery Locations**
- 11.13.1. Contractor shall offer deliveries to every location served under the scope of the Contract, specifically
- 11.13.1.1. if the Contract is for a single State agency in a single area, then Contractor shall deliver to any agency location in that area;
- 11.13.1.2. if the Contract is for a single State agency in all its locations, then Contractor shall deliver to any of that agency's location in Arizona;
- 11.13.1.3. if the Contract is for statewide use but excludes certain areas, then Contractor shall deliver to any Eligible Agency or Co-Op Buyer location that is not in the excluded areas; and
- 11.13.1.4. if the Contract is for unrestricted statewide use, then:
- 11.13.1.4.1. Contractor shall deliver to any Eligible Agency or Co-Op Buyer anywhere in Arizona;
- 11.13.1.4.2. If a prospective Co-Op Buyer outside Arizona wishes to order against the Contract, Contractor agrees to negotiate in good faith any fair and reasonable price or lead time adjustments necessary to serve that location if practicable to do so within the scope of its normal business; and,
- 11.13.1.4.3. if the Commercial Document indicates defined delivery areas and prices, those always apply unless the Order expressly states otherwise and Contractor accepts it.
- 11.14. Conditions at Delivery Location** Contractor shall verify receiving hours and conditions (i.e. height/weight restrictions, access control, etc.) with the relevant purchaser for the receiving site before scheduling or making a delivery. State will neither allow extra charges for wait time, comebacks, or the like nor excuse late delivery if Contractor has failed to make the verification or comply with the applicable conditions. Contractor shall make each delivery to the specific location indicated in the Order, which Contractor acknowledges might be inside an industrial building, institutional building,



Special Terms and Conditions

State of Arizona
 State Procurement Office
 100 North 15th Avenue, Suite 402
 Phoenix, AZ 85007

low-rise office building, or high-rise office building instead of a normal receiving dock. Contractor might be required to make deliveries to locations inside a secured perimeter at certain institutional facilities such as prisons where prior clearances are required for each delivery and driver individually. Contractor shall contact each such facility directly to confirm its most-current security clearance procedures, allowable hours for deliveries, visitor dress code, and other applicable rules. State will neither allow extra charges for wait time, comebacks, or the like nor excuse late delivery if Contractor has failed to make the confirmation or comply with the applicable conditions

11.15. Materials Acceptance

State has the right to make acceptance of Materials subject to a complete inspection on delivery and installation, if installation is Contractor's responsibility. State may apply as acceptance criteria conformity to the Contract, workmanship and quality, correctness of constituent materials, and any other matter for which the Contract or applicable laws state a requirement, whether stated directly or by reference to another document, standard, reference specification, etc. Contractor shall remove any rejected Materials from the delivery location, or from any immediate environs to which it might have been reasonably necessary to move it, carry it off the delivery premises, and subsequently deliver an equal number or quantity of conforming items. State will not owe Contractor any payment for rejected Materials, and State may, at its discretion, withhold or make partial payment for any rejected Materials that have been returned to Contractor in those instances where State has agreed to permit repair instead of demanding replacement.

11.16. Correcting Defects

11.16.1. Contractor shall, at no additional cost and without entitlement to extension of any delivery deadline or specified time for performance, remove or exchange and replace any defective or non-conforming delivered or installed Materials.

11.16.1.1. Contractor shall be solely responsible for the cost of any associated cutting and patching, temporary protection measures, packing and crating, hoisting and loading, transportation, unpacking, inspection, repacking, reshipping, and reinstallation if installation is within the scope of the Contract.

11.16.1.2. If Contractor fails to do so in a timely manner, State will be entitled to exercise its remedies under paragraph 8.5 [Right of Offset] of the Uniform Terms and Conditions.

11.16.1.2.1. Whether State will permit Contractor to repair in place or demands that Contractor remove and replace is at State's discretion in each instance, provided that, State shall not apply that discretion punitively if repair in place is practicable and doing so would not create safety hazards, put property at risk, unreasonably interfere with operations, create public nuisance, or give rise to any other reasonable concern on State's part.

11.17. Returns

State may, at its discretion, return for full credit and with no restocking charges any delivered Materials unused in the original packaging, including any instruction manuals or other incidental item that accompanied the original shipment, within thirty (30) days after receipt. If State elects to return delivered Materials, then State shall pay all freight, delivery, and transit insurance costs to return the products to the place from which Contractor shipped them, provided that, if State returns delivered Materials because they are defective or non-conforming or for any other reason having to do with Contractor fault or error, then State will not be responsible for paying freight, delivery, or transit insurance costs to return the products and may, at its discretion, either have those billed directly to Contractor or offset them under paragraph 8.5 [Right of Offset] of the Uniform Terms and Conditions.

11.18. Order Cancellations

11.18.1. State may cancel orders within a reasonable period after issuance and at its discretion. The same method as that used for ordering will be used for cancellation. If State cancels an Order, then State shall:

11.18.1.1. pay Contractor for any portion of the Materials and Services from that Order that have been properly delivered or performed as of the cancellation effective date plus one (1) additional business day

11.18.1.2. reimburse Contractor for:

11.18.1.2.1. its actual, documented costs incurred in fulfilling the Order up to the cancellation effective date plus one (1) additional business day;

11.18.1.2.2. the cost of any obligations it incurred in fulfilling the Order up to the cancellation effective date plus one (1) additional business day that demonstrably cannot be

	<h2>Special Terms and Conditions</h2>	<p align="center"> State of Arizona State Procurement Office 100 North 15th Avenue, Suite 402 Phoenix, AZ 85007 </p>
---	---------------------------------------	--

canceled, or that have pre-established cancellation penalties specified in the relevant Subcontracts, to the extent the penalties are reasonable and customary for the work in question;

11.18.1.3. Contractor shall not charge or be entitled to charge State for any new costs it incurs after receiving the cancellation notice.

11.18.2. By way of reminder, State is not liable for any products that were produced, shipped, or delivered or any services that were performed before Contractor had acknowledged the corresponding Order

11.19. Product Safety

Materials as-shipped must comply with applicable safety regulations and standards. Unless expressly stated otherwise in the Scope of Work, State is not responsible for making any Materials safe or compliant following acceptance and is relying exclusively on Contractor to deliver only products that are already safe and compliant.

11.20. Hazardous Materials

11.20.1. Contractor shall timely provide State with any "Safety Data Sheets" (SDS) and any other hazard communication documentation required under the US Department of Labor's Occupational Safety and Health Administration (OSHA) "Hazard Communication Standard" (often referred to as the "HazCom 2012 Final Rule") that is reasonably necessary for State to comply with regulations when it or its other contractors install, handle, operate, repair, maintain or remove any Materials. Note that, in the past, those documents might have been referred to as "Material Safety Data Sheets" or "Product Safety Data Sheets", but State (and this Contract) use only the more up-to-date "SDS" reference. Contractor shall ensure that all its relevant personnel understand the nature of and hazards associated with, to the extent it they are Contractor's responsibility under the Contract, the design, shipping, handling, delivery, installation, repair and maintenance of any portion of the Work that is, contains or will become upon use a hazardous material, with "hazardous material" being any material or substance that is:

11.20.1.1. identified now or in the future as being hazardous, toxic or dangerous under applicable laws; or

11.20.1.2. subject to statutory or regulatory requirement governing special handling, disposal or cleanup

12. General Provisions for Services

12.1. Applicability

Article 12 applies to the extent the Work is or includes Services.

12.2. Comprehensive Services Offering

Contractor shall provide the comprehensive range of services for which a price is established in the Pricing Document for ordering by Eligible Agencies, and Co-Op Buyers if co-op buying applies.

12.3. Additional Services

State at its discretion may modify the scope of the Contract by Contract Amendment to include additional services or service categories that are within the general scope of the ones originally covered by the Contract if it determines that doing so is in its best interest. Once the Contract Amendment is fully executed, Contractor shall then update all applicable price lists and make them available to all affected entities at no additional cost. Either party may make the request to add services to the Contract; regardless of who makes the request, the parties shall negotiate in good faith a fair price for any additional services, but State may elect not to add some or all of the services in question if no agreement is reached on pricing in a timely manner. Contractor's request or proposal in response to State's request must include documentation demonstrating that the proposed price for the additional services is both fair and reasonable and comparable to the original ones.

12.4. Off-Contract Services

Contractor shall ensure that the design and/or procedures for the Services ordering method prevents Orders for off-contract or excluded services. Notwithstanding that State might have its own internal administrative rules regarding off contract or excluded service ordering, and endeavors to prevent such orders from occurring, Contractor is responsible for not accepting any such Orders. State may, at its discretion, cancel any such Order without obligation. As used above, "off-contract service" refers to any service not included in the scope of the Contract and for which no price or compensation has been established contractually, and "excluded service" refers to any service expressly excluded from the scope of the Contract.

12.5. Removal of Personnel

Notwithstanding that Contractor is in every circumstance responsible for hiring, assigning, directing, managing, training, disciplining, and rewarding its personnel, State may at its discretion and without the

	<h2 style="text-align: center;">Special Terms and Conditions</h2>	<p style="text-align: center;"> State of Arizona State Procurement Office 100 North 15th Avenue, Suite 402 Phoenix, AZ 85007 </p>
---	---	---

obligation to demonstrate cause instruct Contractor to remove any of its personnel from State's facilities or from further assignment under the Contract. In such cases, Contractor shall promptly replace them with other personnel having equivalent qualifications, experience, and capabilities.

12.6. Transitions

During commencement, Contractor shall attend transition meetings with any outgoing vendors to coordinate and ease the transition so that the effect on State's operations is kept to a minimum. State may elect to have outgoing vendors complete some or all of their work or orders in progress to ease the transition as is safest and most efficient in each instance, even if that scope is covered under the Contract. Conversely, State anticipates having a continued need for the same materials and services upon expiration or earlier termination of the Contract. Accordingly, Contractor shall work closely with any new (incoming) vendor and State to ensure as smooth and complete a transfer as is practicable. State's representative shall coordinate all transition activities and facilitate joint development of a comprehensive transition plan by both Contractor and the incoming vendor. As with the incoming transition. State may permit Contractor (outgoing) to complete work or orders in progress to ease the transition as is safest and most efficient in each instance.

12.7. Accuracy of Work

Contractor is responsible for the accuracy of the Services, and shall promptly make all necessary revisions or corrections resulting from errors and omissions on its part without additional compensation. Acceptance by State will not relieve Contractor of responsibility for correction of any errors discovered subsequently or necessary clarification of any ambiguities.

12.8. Requirements at Services Location

Contractor personnel shall perform their assigned portions of the Services at the specific location indicated in the Order (if applicable). Contractor acknowledges that the location might be inside an industrial building, institutional building, or one of various office types and classes. Additionally, if performing the Services requires Contractor personnel to work inside a secured perimeter at certain institutional facilities such as prisons where prior clearances are required, Contractor shall contact the facility directly to confirm its most-current security clearance procedures, allowable hours for work, visitor dress code, and other applicable rules. State will neither allow extra charges for wait time, comebacks, or the like nor excuse late performance if Contractor has failed to make the confirmation or comply with the applicable conditions.

12.9. Services Acceptance

State has the right to make acceptance of Services subject to acceptance criteria. State may apply as acceptance criteria conformity to the Contract, accuracy, completeness, or other indicators of quality or other matter for which the Contract or law states a requirement, whether stated directly or by reference to another document, standard, reference specification, etc. State will not owe Contractor any payment for un-accepted Services; and State may, at its discretion, withhold or make partial payment for any rejected Services if Contractor is still in the process of re-performing or otherwise curing the grounds for State's rejection.

12.10. Corrective Action Required

12.10.1. Notwithstanding any other guarantees, general warranties, or particular warranties Contractor has given under the Contract, if Contractor fails to perform any material portion of the Services, including failing to complete any contractual deliverable, or if its performance fails to meet agreed-upon service levels or service standards set out in or referred to in the Contract, then Contractor shall perform a root-cause analysis to identify the source of the failure and use all commercially reasonable efforts to correct the failure and meet the Contract requirements as promptly as is practicable.

12.10.1.1. Contractor shall provide to State a report detailing the identified cause and setting out its detailed corrective action plan promptly after the date the failure occurred (or the date when the failure first became apparent, if it was not apparent immediately after occurrence).

12.10.1.2. State may demand to review and approve Contractor's analysis and plans, and Contractor shall make any corrections State instructs and adopt State's recommendations so far as is commercially practicable, provided that State may insist on any measures it determines within reason to be necessary for safety or protecting property and the environment.

	<h2>Special Terms and Conditions</h2>	<p align="center"> State of Arizona State Procurement Office 100 North 15th Avenue, Suite 402 Phoenix, AZ 85007 </p>
---	---------------------------------------	--

12.10.1.3. Contractor shall take the necessary action to avoid any like failure in the future, if doing so is appropriate and practicable under the circumstances.

13.0 Data and Information Handling

- 13.1 Applicability**
- 13.1.1. Article 13 applies to the extent the Work includes handling of any:
- 13.1.1.1. State's proprietary and sensitive data or
- 13.1.1.2. confidential or access-restricted information obtained from State or from others at State's behest.
- 13.2 Data Protection and Confidentiality of Information**
- 13.2.1. Contractor warrants that it will establish and maintain procedures and controls acceptable to State for ensuring that State's proprietary and sensitive data is protected from unauthorized access and information obtained from State or others in performance of its contractual duties is not mishandled, misused, or inappropriately released or disclosed. For purposes of this paragraph, all data created by Contractor in any way related to the Contract, provided to Contractor by State, or prepared by others for State are proprietary to State, and all information by those same avenues is State's confidential information. To comply with the foregoing warrant:
- 13.2.1.1. Contractor shall:
- 13.2.1.1.1. notify State immediately of any unauthorized access or inappropriate disclosures, whether stemming from an external security breach, internal breach, system failure, or procedural lapse;
- 13.2.1.1.2. cooperate with State to identify the source or cause of and respond to each unauthorized access or inappropriate disclosure; and
- 13.2.1.1.3. notify State promptly of any security threat that could result in unauthorized access or inappropriate disclosures; and
- 13.2.1.2. Contractor shall not:
- 13.2.1.2.1. release any such data or allow it to be released or divulge any such information to anyone other than its employees or officers as needed for each person's individual performance of his or her duties under the Contract, unless State has agreed otherwise in advance and in writing; or
- 13.2.1.2.2. respond to any requests it receives from a third party for such data or information, and instead route all such requests to State's designated representative.
- 13.3 Personally Identifiable Information.**
- 13.3.1. Without limiting the generality of paragraph 13.2, Contractor warrants that it will protect any personally identifiable information ("PII") belonging to State's employees' or other contractors or members of the general public that it receives from State or otherwise acquires in its performance under the Contract. For purposes of this paragraph:
- 13.3.1.1. PII has the meaning given in the [federal] Office of Management and Budget (OMB) Memorandum M-17-12 Preparing for and Responding to a Breach of Personally Identifiable Information", January 3, 2017; and
- 13.3.1.2. "protect" means taking measures to safeguard personally identifiable information and prevent its breach that are functionally equivalent to those called for in that OMB memorandum and elaborated on in the [federal] General Services Administration (GSA) Directive CIO P 2180.1 GSA Rules of Behavior for Handling Personally Identifiable Information.

NOTE (1): For convenience of reference only, the OMB memorandum is available at:

<https://dpcl.dod.defense.gov/Privacy/Authorities-and-Guidance/>

NOTE (2): For convenience of reference only, the GSA directive is available at:

<http://www.gsa.gov/portal/directive/d0/content/658222>

	<h2>Special Terms and Conditions</h2>	<p align="center"> State of Arizona State Procurement Office 100 North 15th Avenue, Suite 402 Phoenix, AZ 85007 </p>
---	---------------------------------------	--

13.4 Protected Health Information

- 13.4.1. Contractor warrants that, to the extent performance under the Contract involves individually identifiable health information (referred to hereinafter as protected health information (“PHI”) and electronic PHI (“ePHI”) as defined in the Privacy Rule referred to below), it:
- 13.4.1.1. is familiar with and will comply with the applicable aspects of the following collective regulatory requirements regarding patient information privacy protection:
- 13.4.1.1.1. the “Privacy Rule” in CFR 45 Part 160 and Part 164 pursuant to the Health Insurance Portability and Accountability Act (“HIPAA”) of 1996;
- 13.4.1.1.2. Arizona laws, rules, and regulations applicable to PHI/ePHI that are not preempted by CFR 45-160(B) or the Employee Retirement Income Security Act of 1974 (“ERISA”) as amended; and
- 13.4.1.1.3. State’s current and published PHI/ePHI privacy and security policies and procedures;
- 13.4.1.2. will cooperate with State in the course of performing under the Contract so that both State and Contractor stay in compliance with the requirements in (13.4.1.1.) above; and
- 13.4.1.3. will sign any documents that are reasonably necessary to keep both State and Contractor in compliance with the requirements in (13.4.1.1.) above, in particular “Business Associate Agreements” in accordance with the Privacy Rule.

NOTE: For convenience of reference only, the Privacy Rule is available at:

<http://www.hhs.gov/hipaa/for-professionals/privacy/index.html>

14.0 Information Technology Work

14.1 Applicability

Article 14 applies to any Invitation for Bids, Request for Proposals, or Request for Quotations for "Information Technology," as defined in A.R.S. § 41-3501(6) 6: “. . . computerized and auxiliary automated information processing, telecommunications and related technology, including hardware, software, vendor support and related services, equipment and projects” if and to the extent that the Work is or includes Information Technology.

14.2 Background Checks

Each of Contractor’s personnel who is an applicant for an information technology position must undergo the security clearance and background check procedure, which includes fingerprinting, as required by A.R.S. § 41-710. Contractor shall obtain and pay for the security clearance and background check. Contractor personnel who will have administrator privileges on a State network must additionally provide identify and address verification and undergo State-specified training for unescorted access, confidentiality, privacy, and data security.

14.3 Information Access

- 14.3.1. SYSTEM MEASURES. Contractor shall employ appropriate system management and maintenance, fraud prevention and detection, and encryption application and tools to any systems or networks containing or transmitting State’s proprietary data or confidential information.
- 14.3.2. INDIVIDUAL MEASURES. Contractor personnel shall comply with applicable State policies and procedures regarding data access, privacy, and security, including prohibitions on remote access and obtaining and maintaining access IDs and passwords. Contractor is responsible to State for ensuring that any State access IDs and passwords are used only by the person to whom they were issued. Contractor shall ensure that personnel are only provided the minimum only such level of access necessary to perform his or duties. Contractor shall on request provide a current register of the access IDs and passwords and corresponding access levels currently assigned to its personnel.
- 14.3.3. ACCESS CONTROL. Contractor is responsible to State for ensuring that hardware, software, data, information, and that has been provided by State or belongs to or is in the custody of State and is accessed or accessible by Contractor personnel is only used in connection with carrying out the Work, and is never commercially exploited in any manner whatsoever not expressly permitted under the Contract. State may restrict access by Contractor personnel, or instruct Contractor to restrict access their access, if in its determination the requirements of this subparagraph are not being met.



Special Terms and Conditions

State of Arizona
 State Procurement Office
 100 North 15th Avenue, Suite 402
 Phoenix, AZ 85007

14.4 Pass-Through Indemnity

- 14.4.1. INDEMNITY FROM THIRD PARTY. For computer hardware or software included in the Work as discrete units that were manufactured or developed solely by a third party, Contractor may satisfy its indemnification obligations under the Contract by, to the extent permissible by law, passing through to State such indemnity as it receives from the third-party source (each a "Pass-Through Indemnity") and cooperating with State in enforcing that indemnity. If the third party fails to honor its Pass-Through Indemnity, or if a Pass-Through Indemnity is insufficient to indemnify State Indemnitees to the extent and degree Contractor is required to do by the Uniform Terms and Conditions, then Contractor shall indemnify, defend and hold harmless State Indemnitees to the extent the Pass-Through Indemnity does not.
- 14.4.2. NOTIFY OF CLAIMS. State shall notify Contractor promptly of any claim to which a Pass-Through Indemnity might apply. Contractor, with reasonable consultation from State, shall control of the defense of any action on any claim to which a Pass-Through Indemnity applies, including negotiations for settlement or compromise, provided that:
- 14.4.2.1. State reserves the right to elect to participate in the action at its own expense;
- 14.4.2.2. State reserves the right to approve or reject any settlement or compromise on reasonable grounds and if done so timely; and
- 14.4.2.3. State shall in any case cooperate in the defense and any related settlement negotiations.

14.5 Systems and Controls

In consideration for State having agreed to permit Pass-Through Indemnities in lieu of direct indemnity, Contractor agrees to establish and keep in place systems and controls appropriate to ensure that State funds under this Contract are not knowingly used for the acquisition, operation, or maintenance of Materials or Services in violation of intellectual property laws or a third party's intellectual property rights.

14.6 Redress of Infringement.

- 14.6.1. REPLACE, LICENSE, OR MODIFY. If Contractor becomes aware that any Materials or Services infringe, or are likely to be infringing on, any third party's intellectual property rights, then Contractor shall at its sole cost and expense and in consultation with State either:
- 14.6.1.1. replace any infringing items with non-infringing ones;
- 14.6.1.2. obtain for State the right to continue using the infringing items; or
- 14.6.1.3. modify the infringing item so that they become non-infringing, so long as they continue to function as specified following the modification.
- 14.6.2. CANCELLATION OPTION. In every case under 14.6.1, if none of those options can reasonably be accomplished, or if the continued use of the infringing items is impracticable, State may cancel the relevant Order or terminate the Contract and Contractor shall take back the infringing items. If State does cancel the Order or terminate the Contract, Contractor shall refund to State:
- 14.6.2.1. for any software created for State under the Contract, the amount State paid to Contractor for creating it;
- 14.6.2.2. for all other Materials, the net book value of the product provided according to generally accepted accounting principles; and
- 14.6.2.3. for Services, the amount paid by State or an amount equal to 12 (twelve) months of charges, whichever is less.
- 14.6.3. EXCEPTIONS. Contractor will not be liable for any claim of infringement based solely on any of the following by a State Indemnitee:
- 14.6.3.1. modification or use of Materials other than as contemplated by the Contract or expressly authorized or proposed by a Contractor Indemnitor;
- 14.6.3.2. operation of Materials with any operating software other than that supplied by Contractor or authorized or proposed by a Contractor Indemnitor; or
- 14.6.3.3. combination or use with other products in a manner not contemplated by the Contract or expressly authorized or proposed by a Contractor Indemnitor.

	<h2 style="text-align: center;">Special Terms and Conditions</h2>	<p style="text-align: center;"> State of Arizona State Procurement Office 100 North 15th Avenue, Suite 402 Phoenix, AZ 85007 </p>
---	---	---

14.7 First Party Liability Limitation

- 14.7.1. **LIMIT.** Subject to the provisos that follow below and unless stated otherwise in the Special Terms and Conditions, State's and Contractor's respective first party liability arising from or related to the Contract is limited to the greater of \$1,000,000 (one million dollars) or 3 (three) times the purchase price of the specific Materials or Services giving rise to the claim.
- 14.7.2. **PROVISOS.** This paragraph 14.7 limits liability for first party direct, indirect, incidental, special, punitive, and consequential damages relating to the Work regardless of the legal theory under which the liability is asserted. This paragraph 14.7 does not limit liability arising from any:
- 14.7.2.1. Indemnified Claim against which Contractor has indemnified State Indemnitees under paragraph 6.3;
 - 14.7.2.2. claim against which Contractor has indemnified State Indemnitees under paragraph 6.4; or
 - 14.7.2.3. provision of the Contract calling for liquidated damages or specifying amounts or percentages as being at-risk or subject to deduction for performance deficiencies.
- 14.7.3. **PURCHASE PRICE DETERMINATION.** If the Contract is for a single-agency and a single Order (or if no Order applies), then "purchase price" in Subparagraph 14.7.1 above means the aggregate Contract price current at the time of Contract expiration or earlier termination, including all Contract Amendments having an effect on the aggregate price through that date. In all other cases, "purchase price" above means the total price of the Order for the specific equipment, software, or services giving rise to the claim, and therefore a separate limit will apply to each Order.
- 14.7.4. **NO EFFECT ON INSURANCE.** This paragraph does not modify the required coverage limits, terms, and conditions of, or any insured's ability to claim against, any insurance that Contractor is required by the Contract to provide, and Contractor shall obtain express endorsements that it does not.

14.8 Information Technology Warranty

- 14.8.1. **SPECIFIED DESIGN.** Where the Scope of Work for information technology Work provides a detailed design specification or sets out specific performance requirements, Contractor warrants that the Work will provide all functionality material to the intended use stated in the Contract, provided that, the foregoing warranty does not extend to any portions of the Materials that are:
- 14.8.1.1. modified or altered by anyone not authorized by Contractor to do so;
 - 14.8.1.2. maintained in a way inconsistent to any applicable manufacturer recommendations; or
 - 14.8.1.3. operated in a manner not within its intended use or environment.
- 14.8.2. **COTS SOFTWARE.** With respect to Materials provided under the Contract that are commercial-off-the-shelf (COTS) software, Contractor warrants that:
- 14.8.2.1. to the extent possible, it will test the software before delivery using commercially available virus detection software conforming to current industry standards;
 - 14.8.2.2. the COTS software will, to the best of its knowledge, at the time of delivery be free of viruses, backdoors, worms, spyware, malware, and other malicious code that could hamper performance, collect unlawfully any personally identifiable information, or prevent products from performing as required by the Contract; and
 - 14.8.2.3. it will provide a new or clean install of any COTS software that State has reason to believe contains harmful code.
- 14.8.3. **PAYMENT HAS NO EFFECT.** The warranties in this paragraph are not affected by State's inspection, testing, or payment.

14.9 Specific Remedies

Unless expressly stated otherwise elsewhere in the Contract, State's remedy for breach of warranty under paragraph 14.8 includes, at State's discretion, re-performance, repair, replacement, or refund of any amounts paid by State for the nonconforming Work, plus (in every case) Contractor's payment of State's additional, documented, and reasonable costs to procure materials or services equivalent in function, capability, and performance at that first called for. For clarification of intent, the foregoing obligations are limited by the limitation of liability in paragraph 14.7. If none of the foregoing options can reasonably be

	Special Terms and Conditions	State of Arizona State Procurement Office 100 North 15 th Avenue, Suite 402 Phoenix, AZ 85007
---	-------------------------------------	---

effected, or if the use of the materials by State is made impractical by the nonconformance, then State may seek any remedy available to it under law.

14.10 Section 508 Compliance

Unless specifically authorized in the Contract, any electronic or information technology offered to the State of Arizona under this Contract shall comply with A.R.S. § 18-131 and § 18-132 and Section 508 of the Rehabilitation Act of 1973, which requires that employees and members of the public shall have access to and use of information technology that is comparable to the access and use by employees and members of the public who are not individuals with disabilities.

14.11 Cloud Applications

14.11.1. The following are required for Contractor of any “cloud” solution that hosts State data outside of the State’s network, or transmits and/or receives State data.

14.11.1.1. Submit a completed Arizona Baseline Infrastructure Security Controls assessment spreadsheet as found at: <https://aset.az.gov/resources/policies-standards-and-procedures>, and mitigate or install compensating controls for any issues of concern identified by State. Contractor is required to provide any requested documentation supporting the review of the assessment. The assessment shall be re-validated on a minimum annual basis.

14.11.1.2. State reserves the right to conduct Penetration tests or hire a third party to conduct penetration tests of the Contractor’s application. Contractor will be alerted in advance and arrangements made for an agreeable time. Contractor shall respond to all serious flaws discovered by providing an acceptable timeframe to resolve the issue and/or implement a compensating control.

14.11.1.3. Contractor must submit copy of system logs from cloud system to State of AZ security team on a regular basis to be added to the State SIEM (Security Information Event Monitor) or IDS (Intrusion Detection System).

14.11.2. Contractor must employ a government-rated cloud compartment to better protect sensitive or regulated State data.



Uniform Terms and Conditions

State of Arizona
 State Procurement Office
 100 North 15th Avenue, Suite 402
 Phoenix, AZ 85007

1.0 Definition of Terms

As used in the Contract, the terms listed below are defined as follows:

- 1.1. Attachment** "Attachment" means any item the solicitation requires the Offeror to submit as part of the Offer.
- 1.2. Contract** "Contract" means the combination of the Solicitation, including the Uniform and Special Instructions to Offerors, the Uniform and Special Terms and Conditions, and the Specifications and Statement or Scope of Work; the Offer and any Best and Final Offers; and any Solicitation Amendments or Contract Amendments.
- 1.3. Contract Amendment** "Contract Amendment" means a written document signed by the Procurement Officer that is issued for the purpose of making changes in the Contract.
- 1.4. Contractor** "Contractor" means any Person who has a Contract with the State.
- 1.5. Days** "Days" means calendar days unless otherwise specified.
- 1.6. Exhibit** "Exhibit" means any item labeled as an Exhibit in the Solicitation or placed in the Exhibits section of the Solicitation.
- 1.7. Gratuity** "Gratuity" means a payment, loan, subscription, advance, deposit of money, services, or anything of more than nominal value, present or promised, unless consideration of substantially equal or greater value is received.
- 1.8. Materials** "Materials" means all property, including equipment, supplies, printing, insurance and leases of property but does not include land, a permanent interest in land or real property or leasing space.
- 1.9. Procurement Officer** "Procurement Officer" means the person, or his or her designee, duly authorized by the State to enter into and administer Contracts and make written determinations with respect to the Contract.
- 1.10. Services** "Services" has the meaning given in A.R.S. § 41-2503(35), which, for convenience of reference only, is "... the furnishing of labor, time, or effort by [the] [C]ontractor or [S]ubcontractor which does not involve the delivery of a specific end product other than required reports and performance [but] does not include employment agreements or collective bargaining agreements." Services includes Building Work and the service aspects of software described in paragraph 1.8.
- 1.11. State** "State" means the State of Arizona and Department or Agency of the State that executes the Contract.
- 1.12. State Fiscal Year** "State Fiscal Year" means the period beginning with July 1 and ending June 30.
- 1.13. Subcontract** "Subcontract" means any Contract, express or implied, between the Contractor and another party or between a subcontractor and another party delegating or assigning, in whole or in part, the making or furnishing of any material or any service required for the performance of the Contract.

2.0 Contract Interpretation

- 2.1 Arizona Law** The Arizona law applies to this Contract including, where applicable, the Uniform Commercial Code as adopted by the State of Arizona and the Arizona Procurement Code, Arizona Revised Statutes (A.R.S.) Title 41, Chapter 23, and its implementing rules, Arizona Administrative Code (A.A.C.) Title 2, Chapter 7.
- 2.2 Implied Terms** Each provision of law and any terms required by law to be in this Contract are a part of this Contract as if fully stated in it.
- 2.3 Contract Order of Precedence** In the event of a conflict in the provisions of the Contract, as accepted by the State and as they may be amended, the following shall prevail in the order set forth below:
- 2.3.1. Special Terms and Conditions;
 - 2.3.2. Uniform Terms and Conditions;
 - 2.3.3. Statement or Scope of Work;
 - 2.3.4. Specifications;



Uniform Terms and Conditions

State of Arizona
 State Procurement Office
 100 North 15th Avenue, Suite 402
 Phoenix, AZ 85007

- 2.3.5. Attachments;
- 2.3.6. Exhibits;
- 2.3.7. Documents referenced or included in the Solicitation.
- 2.4 Relationship of Parties** The Contractor under this Contract is an independent Contractor. Neither party to this Contract shall be deemed to be the employee or agent of the other party to the Contract.
- 2.5 Severability** The provisions of this Contract are severable. Any term or condition deemed illegal or invalid shall not affect any other term or condition of the Contract..
- 2.6 No Parole Evidence** This Contract is intended by the parties as a final and complete expression of their agreement. No course of prior dealings between the parties and no usage of the trade shall supplement or explain any terms used in this document and no other understanding either oral or in writing shall be binding.
- 2.7 No Waiver** Either party's failure to insist on strict performance of any term or condition of the Contract shall not be deemed a waiver of that term or condition even if the party accepting or acquiescing in the nonconforming performance knows of the nature of the performance and fails to object to it.

3.0 Contract Administration and Operation

- 3.1 Records** Under A.R.S. § 35-214 and § 35-215, the Contractor shall retain and shall contractually require each subcontractor to retain all data and other "records" relating to the acquisition and performance of the Contract for a period of five years after the completion of the Contract. All records shall be subject to inspection and audit by the State at reasonable times. Upon request, the Contractor shall produce a legible copy of any or all such records.
- 3.2 Non-Discrimination** The Contractor shall comply with State Executive Order No. 2009-09 and all other applicable Federal and State laws, rules and regulations, including the Americans with Disabilities Act.
- 3.3 Audit** Pursuant to ARS § 35-214, at any time during the term of this Contract and five (5) years thereafter, the Contractor's or any subcontractor's books and records shall be subject to audit by the State and, where applicable, the Federal Government, to the extent that the books and records relate to the performance of the Contract or Subcontract.
- 3.4 Facilities Inspection and Materials Testing** The Contractor agrees to permit access to its facilities, subcontractor facilities and the Contractor's processes or services, at reasonable times for inspection of the facilities or materials covered under this Contract. The State shall also have the right to test, at its own cost, the materials to be supplied under this Contract. Neither inspection of the Contractor's facilities nor materials testing shall constitute final acceptance of the materials or services. If the State determines noncompliance of the materials, the Contractor shall be responsible for the payment of all costs incurred by the State for testing and inspection.
- 3.5 Notices** Notices to the Contractor required by this Contract shall be made by the State to the person indicated on the Offer and Acceptance form submitted by the Contractor unless otherwise stated in the Contract. Notices to the State required by the Contract shall be made by the Contractor to the Solicitation Contact Person indicated on the Solicitation cover sheet, unless otherwise stated in the Contract. An authorized Procurement Officer and an authorized Contractor representative may change their respective person to whom notice shall be given by written notice to the other and an amendment to the Contract shall not be necessary.
- 3.6 Advertising, Publishing and Promotion of Contract** The Contractor shall not use, advertise or promote information for commercial benefit concerning this Contract without the prior written approval of the Procurement Officer.
- 3.7 Property of the State** Any materials, including reports, computer programs and other deliverables, created under this Contract are the sole property of the State. The Contractor is not entitled to a patent or copyright on those materials and may not transfer the patent or copyright to anyone else. The Contractor shall not use or release these materials without the prior written consent of the State.
- 3.8 Ownership of Intellectual Property** Any and all intellectual property, including but not limited to copyright, invention, trademark, trade name, service mark, and/or trade secrets created or conceived pursuant to or as a result of this contract and any related subcontract ("Intellectual Property"), shall be work made for hire and the State shall be considered the creator of such Intellectual Property. The agency, department, division, board or commission of the State



Uniform Terms and Conditions

State of Arizona
 State Procurement Office
 100 North 15th Avenue, Suite 402
 Phoenix, AZ 85007

of Arizona requesting the issuance of this contract shall own (for and on behalf of the State) the entire right, title and interest to the Intellectual Property throughout the world. Contractor shall notify the State, within thirty (30) days, of the creation of any Intellectual Property by it or its subcontractor(s). Contractor, on behalf of itself and any subcontractor(s), agrees to execute any and all document(s) necessary to assure ownership of the Intellectual Property vests in the State and shall take no affirmative actions that might have the effect of vesting all or part of the Intellectual Property in any entity other than the State. The Intellectual Property shall not be disclosed by contractor or its subcontractor(s) to any entity not the State without the express written authorization of the agency, department, division, board or commission of the State of Arizona requesting the issuance of this contract.

3.9 Federal Immigration and Nationality Act

The contractor shall comply with all federal, state and local immigration laws and regulations relating to the immigration status of their employees during the term of the contract. Further, the contractor shall flow down this requirement to all subcontractors utilized during the term of the contract. The State shall retain the right to perform random audits of contractor and subcontractor records or to inspect papers of any employee thereof to ensure compliance. Should the State determine that the contractor and/or any subcontractors be found noncompliant, the State may pursue all remedies allowed by law, including, but not limited to; suspension of work, termination of the contract for default and suspension and/or debarment of the contractor.

3.10 E-Verify Requirements

In accordance with A.R.S. § 41-4401, Contractor warrants compliance with all Federal immigration laws and regulations relating to employees and warrants its compliance with Section A.R.S. § 23-214, Subsection A.

3.11 Offshore Performance of Work Prohibited.

Any services that are described in the specifications or scope of work that directly serve the State of Arizona or its clients and involve access to secure or sensitive data or personal client data shall be performed within the defined territories of the United States. Unless specifically stated otherwise in the specifications, this paragraph does not apply to indirect or 'overhead' services, redundant back-up services or services that are incidental to the performance of the contract. This provision applies to work performed by subcontractors at all tiers.

4.0 Costs and Payments

4.1 Payments

Payments shall comply with the requirements of A.R.S. Titles 35 and 41, Net 30 days. Upon receipt and acceptance of goods or services, the Contractor shall submit a complete and accurate invoice for payment from the State within thirty (30) days.

4.2 Delivery

Unless stated otherwise in the Contract, all prices shall be F.O.B. Destination and shall include all freight delivery and unloading at the destination.

4.3 Applicable Taxes

- 4.3.1. Payment of Taxes. The Contractor shall be responsible for paying all applicable taxes.
- 4.3.2. State and Local Transaction Privilege Taxes. The State of Arizona is subject to all applicable state and local transaction privilege taxes. Transaction privilege taxes apply to the sale and are the responsibility of the seller to remit. Failure to collect such taxes from the buyer does not relieve the seller from its obligation to remit taxes.
- 4.3.3. Tax Indemnification. Contractor and all subcontractors shall pay all Federal, state and local taxes applicable to its operation and any persons employed by the Contractor. Contractor shall, and require all subcontractors to hold the State harmless from any responsibility for taxes, damages and interest, if applicable, contributions required under Federal, and/or state and local laws and regulations and any other costs including transaction privilege taxes, unemployment compensation insurance, Social Security and Worker's Compensation.
- 4.3.4. IRS W9 Form. In order to receive payment the Contractor shall have a current I.R.S. W9 Form on file with the State of Arizona, unless not required by law

4.4 Availability of Funds for the Next State fiscal year

Funds may not presently be available for performance under this Contract beyond the current state fiscal year. No legal liability on the part of the State for any payment may arise under this Contract beyond the current state fiscal year until funds are made available for performance of this Contract.

4.5 Availability of Funds for the current State fiscal year

Should the State Legislature enter back into session and reduce the appropriations or for any reason and these goods or services are not funded, the State may take any of the following actions:

- 4.5.1. Accept a decrease in price offered by the contractor;
- 4.5.2. Cancel the Contract; or



Uniform Terms and Conditions

State of Arizona
 State Procurement Office
 100 North 15th Avenue, Suite 402
 Phoenix, AZ 85007

4.5.3. Cancel the contract and re-solicit the requirements

5.0 Contract Changes

5.1 Amendments

This Contract is issued under the authority of the Procurement Officer who signed this Contract. The Contract may be modified only through a Contract Amendment within the scope of the Contract. Changes to the Contract, including the addition of work or materials, the revision of payment terms, or the substitution of work or materials, directed by a person who is not specifically authorized by the procurement officer in writing or made unilaterally by the Contractor are violations of the Contract and of applicable law. Such changes, including unauthorized written Contract Amendments shall be void and without effect, and the Contractor shall not be entitled to any claim under this Contract based on those changes.

5.2 Subcontracts

The Contractor shall not enter into any Subcontract under this Contract for the performance of this contract without the advance written approval of the Procurement Officer. The Contractor shall clearly list any proposed subcontractors and the subcontractor's proposed responsibilities. The Subcontract shall incorporate by reference the terms and conditions of this Contract.

5.3 Assignment and Delegation

The Contractor shall not assign any right nor delegate any duty under this Contract without the prior written approval of the Procurement Officer. The State shall not unreasonably withhold approval.

6.0 Risk and Liability

6.1 Risk of Loss

The Contractor shall bear all loss of conforming material covered under this Contract until received by authorized personnel at the location designated in the purchase order or Contract. Mere receipt does not constitute final acceptance. The risk of loss for nonconforming materials shall remain with the Contractor regardless of receipt.

6.2 Indemnification

6.2.1. Contractor/Vendor Indemnification (Not Public Agency) The parties to this contract agree that the State of Arizona, its departments, agencies, boards and commissions shall be indemnified and held harmless by the contractor for the vicarious liability of the State as a result of entering into this contract. However, the parties further agree that the State of Arizona, its departments, agencies, boards and commissions shall be responsible for its own negligence. Each party to this contract is responsible for its own negligence.

6.2.2. Public Agency Language Only Each party (as 'indemnitor') agrees to indemnify, defend, and hold harmless the other party (as 'indemnitee') from and against any and all claims, losses, liability, costs, or expenses (including reasonable attorney's fees) (hereinafter collectively referred to as 'claims') arising out of bodily injury of any person (including death) or property damage but only to the extent that such claims which result in vicarious/derivative liability to the indemnitee, are caused by the act, omission, negligence, misconduct, or other fault of the indemnitor, its officers, officials, agents, employees, or volunteers."

6.3 Indemnification – Patent and Copyright

The Contractor shall indemnify and hold harmless the State against any liability, including costs and expenses, for infringement of any patent, trademark or copyright arising out of Contract performance or use by the State of materials furnished or work performed under this Contract. The State shall reasonably notify the Contractor of any claim for which it may be liable under this paragraph. If the contractor is insured pursuant to A.R.S. § 41-621 and § 35-154, this section shall not apply.

6.4 Force Majeure

6.4.1 Except for payment of sums due, neither party shall be liable to the other nor deemed in default under this Contract if and to the extent that such party's performance of this Contract is prevented by reason of force majeure. The term "*force majeure*" means an occurrence that is beyond the control of the party affected and occurs without its fault or negligence. Without limiting the foregoing, force majeure includes acts of God; acts of the public enemy; war; riots; strikes; mobilization; labor disputes; civil disorders; fire; flood; lockouts; injunctions-intervention-acts; or failures or refusals to act by government authority; and other similar occurrences beyond the control of the party declaring force majeure which such party is unable to prevent by exercising reasonable diligence.

6.4.2. Force Majeure shall **not** include the following occurrences:



Uniform Terms and Conditions

State of Arizona
 State Procurement Office
 100 North 15th Avenue, Suite 402
 Phoenix, AZ 85007

6.4.2.1. Late delivery of equipment or materials caused by congestion at a manufacturer's plant or elsewhere, or an oversold condition of the market;

6.4.2.2. Late performance by a subcontractor unless the delay arises out of a force majeure occurrence in accordance with this force majeure term and condition; or 6.4.2.3. Inability of either the Contractor or any subcontractor to acquire or maintain any required insurance, bonds, licenses or permits.

6.4.3. If either party is delayed at any time in the progress of the work by force majeure, the delayed party shall notify the other party in writing of such delay, as soon as is practicable and no later than the following working day, of the commencement thereof and shall specify the causes of such delay in such notice. Such notice shall be delivered or mailed certified-return receipt and shall make a specific reference to this article, thereby invoking its provisions. The delayed party shall cause such delay to cease as soon as practicable and shall notify the other party in writing when it has done so. The time of completion shall be extended by Contract Amendment for a period of time equal to the time that results or effects of such delay prevent the delayed party from performing in accordance with this Contract.

6.4.4. Any delay or failure in performance by either party hereto shall not constitute default hereunder or give rise to any claim for damages or loss of anticipated profits if, and to the extent that such delay or failure is caused by force majeure.

6.5 Third Party Antitrust Violations The Contractor assigns to the State any claim for overcharges resulting from antitrust violations to the extent that those violations concern materials or services supplied by third parties to the Contractor, toward fulfillment of this Contract.

7.0 Warranties

7.1 Liens The Contractor warrants that the materials supplied under this Contract are free of liens and shall remain free of liens.

7.2 Quality

7.2.1. Unless otherwise modified elsewhere in these terms and conditions, the Contractor warrants that, for one year after acceptance by the State of the materials, they shall be:

7.2.1.1. Of a quality to pass without objection in the trade under the Contract description;

7.2.1.2. Fit for the intended purposes for which the materials are used;

7.2.1.3. Within the variations permitted by the Contract and are of even kind, quantity, and quality within each unit and among all units;

7.2.1.4. Adequately contained, packaged and marked as the Contract may require; and

7.2.1.5. Conform to the written promises or affirmations of fact made by the Contractor.

7.3 Fitness The Contractor warrants that any material supplied to the State shall fully conform to all requirements of the Contract and all representations of the Contractor, and shall be fit for all purposes and uses required by the Contract.

7.4 Inspection/Testing The warranties set forth in subparagraphs 7.1 through 7.3 of this paragraph are not affected by inspection or testing of or payment for the materials by the State.

7.5 Compliance with Laws The materials and services supplied under this Contract shall comply with all applicable Federal, state and local laws, and the Contractor shall maintain all applicable license and permit requirements.

7.6 Survival of Rights and Obligations after Contract Expiration or Termination

7.6.1. Contractor's Representations and Warranties. All representations and warranties made by the Contractor under this Contract shall survive the expiration or termination hereof. In addition, the parties hereto acknowledge that pursuant to A.R.S. § 12-510, except as provided in A.R.S. § 12-529, the State is not subject to or barred by any limitations of actions prescribed in A.R.S., Title 12, Chapter 5.

7.6.2. Purchase Orders. The Contractor shall, in accordance with all terms and conditions of the Contract, fully perform and shall be obligated to comply with all purchase orders received by the Contractor prior to the expiration or termination hereof, unless otherwise directed in writing by the Procurement Officer, including, without limitation, all purchase orders received prior to but not fully performed and satisfied at the expiration or termination of this Contract.



Uniform Terms and Conditions

State of Arizona
 State Procurement Office
 100 North 15th Avenue, Suite 402
 Phoenix, AZ 85007

8.0 State's Contractual Remedies

- 8.1 Right to Assurance** If the State in good faith has reason to believe that the Contractor does not intend to, or is unable to perform or continue performing under this Contract, the Procurement Officer may demand in writing that the Contractor give a written assurance of intent to perform. Failure by the Contractor to provide written assurance within the number of Days specified in the demand may, at the State's option, be the basis for terminating the Contract under the Uniform Terms and Conditions or other rights and remedies available by law or provided by the contract.
- 8.2 Stop Work Order**
- 8.2.1. The State may, at any time, by written order to the Contractor, require the Contractor to stop all or any part, of the work called for by this Contract for period(s) of days indicated by the State after the order is delivered to the Contractor. The order shall be specifically identified as a stop work order issued under this clause. Upon receipt of the order, the Contractor shall immediately comply with its terms and take all reasonable steps to minimize the incurrence of costs allocable to the work covered by the order during the period of work stoppage.
- 8.2.2. If a stop work order issued under this clause is canceled or the period of the order or any extension expires, the Contractor shall resume work. The Procurement Officer shall make an equitable adjustment in the delivery schedule or Contract price, or both, and the Contract shall be amended in writing accordingly.
- 8.3 Non-exclusive Remedies** The rights and the remedies of the State under this Contract are not exclusive.
- 8.4 Nonconforming Tender** Materials or services supplied under this Contract shall fully comply with the Contract. The delivery of materials or services or a portion of the materials or services that do not fully comply constitutes a breach of contract. On delivery of nonconforming materials or services, the State may terminate the Contract for default under applicable termination clauses in the Contract, exercise any of its rights and remedies under the Uniform Commercial Code, or pursue any other right or remedy available to it.
- 8.5 Right of Offset** The State shall be entitled to offset against any sums due the Contractor, any expenses or costs incurred by the State, or damages assessed by the State concerning the Contractor's non-conforming performance or failure to perform the Contract, including expenses, costs and damages described in the Uniform Terms and Conditions.

9.0 Contract Termination

- 9.1 Cancellation for Conflict of Interests** Pursuant to A.R.S. § 38-511, the State may cancel this Contract within three (3) years after Contract execution without penalty or further obligation if any person significantly involved in initiating, negotiating, securing, drafting or creating the Contract on behalf of the State is or becomes at any time while the Contract or an extension of the Contract is in effect an employee of or a consultant to any other party to this Contract with respect to the subject matter of the Contract. The cancellation shall be effective when the Contractor receives written notice of the cancellation unless the notice specifies a later time. If the Contractor is a political subdivision of the State, it may also cancel this Contract as provided in A.R.S. § 38-511.
- 9.2 Gratuities** The State may, by written notice, terminate this Contract, in whole or in part, if the State determines that employment or a Gratuity was offered or made by the Contractor or a representative of the Contractor to any officer or employee of the State for the purpose of influencing the outcome of the procurement or securing the Contract, an amendment to the Contract, or favorable treatment concerning the Contract, including the making of any determination or decision about contract performance. The State, in addition to any other rights or remedies, shall be entitled to recover exemplary damages in the amount of three times the value of the Gratuity offered by the Contractor.
- 9.3 Suspension or Debarment** The State may, by written notice to the Contractor, immediately terminate this Contract if the State determines that the Contractor has been debarred, suspended or otherwise lawfully prohibited from participating in any public procurement activity, including but not limited to, being disapproved as a subcontractor of any public procurement unit or other governmental body. Submittal of an offer or execution of a contract shall attest that the contractor is not currently suspended or debarred. If the contractor becomes suspended or debarred, the contractor shall immediately notify the State.



Uniform Terms and Conditions

State of Arizona
 State Procurement Office
 100 North 15th Avenue, Suite 402
 Phoenix, AZ 85007

- 9.4 Termination for Convenience** The State reserves the right to terminate the Contract, in whole or in part at any time when in the best interest of the State, without penalty or recourse. Upon receipt of the written notice, the Contractor shall stop all work, as directed in the notice, notify all subcontractors of the effective date of the termination and minimize all further costs to the State. In the event of termination under this paragraph, all documents, data and reports prepared by the Contractor under the Contract shall become the property of and be delivered to the State upon demand. The Contractor shall be entitled to receive just and equitable compensation for work in progress, work completed and materials accepted before the effective date of the termination. The cost principles and procedures provided in A.A.C. R2-7-701 shall apply.
- 9.5 Termination for Default**
- 9.5.1. In addition to the rights reserved in the contract, the State may terminate the Contract in whole or in part due to the failure of the Contractor to comply with any term or condition of the Contract, to acquire and maintain all required insurance policies, bonds, licenses and permits, or to make satisfactory progress in performing the Contract. The Procurement Officer shall provide written notice of the termination and the reasons for it to the Contractor.
- 9.5.2. Upon termination under this paragraph, all goods, materials, documents, data and reports prepared by the Contractor under the Contract shall become the property of and be delivered to the State on demand.
- 9.5.3. The State may, upon termination of this Contract, procure, on terms and in the manner that it deems appropriate, materials or services to replace those under this Contract. The Contractor shall be liable to the State for any excess costs incurred by the State in procuring materials or services in substitution for those due from the Contractor.
- 9.6 Continuation of Performance Through Termination** The Contractor shall continue to perform, in accordance with the requirements of the Contract, up to the date of termination, as directed in the termination notice.

10.0 Contract Claims

- 10.1 Contract Claims** All contract claims or controversies under this Contract shall be resolved according to A.R.S. Title 41, Chapter 23, Article 9, and rules adopted thereunder.

11.0 Arbitration

- 11.1 Arbitration** The parties to this Contract agree to resolve all disputes arising out of or relating to this contract through arbitration, after exhausting applicable administrative review, to the extent required by A.R.S. § 12-1518, except as may be required by other applicable statutes (Title 41).

12.0 Comments Welcome

- 12.1 Comments Welcome** The State Procurement Office periodically reviews the Uniform Terms and Conditions and welcomes any comments you may have. Please submit your comments to: State Procurement Administrator, State Procurement Office, 100 North 15th Avenue, Suite 201, Phoenix, Arizona, 85007.

End of Terms and Conditions



**NASPO ValuePoint
INTENT TO PARTICPATE
Cooperative Contract(s) for Small Package Delivery Services**

I. PURPOSE:

The purpose of this Agreement is to provide interested NASPO states with the opportunity to participate in multi-state cooperative contract(s) for the **Small Package Delivery Services SCOPE OF THE CONTRACT portfolio**

The State of **Utah** is authorized by agreement of the participants to act as the procurement officer in developing multi-state cooperative contract(s) for **Small Package Delivery Services**

The resulting contracts will be permissive contracts.

Administrative Fee

There will be a 0.25% NASPO ValuePoint administrative fee associated with these contracts. It is anticipated that the individual states will be able to add an administrative fee when the state executes its Participating Addendum.

II. TERM OF THE CONTRACT

The initial term of the contract will be established for **five years** from the date of award with **no** options to extend the contract.

III. SOLICITATION AND CONTRACT DEVELOPMENT/ADDITIONAL INFORMATION

The solicitation and contract development shall be accomplished in compliance with the NASPO ValuePoint Process Guide and the NASPO Memorandum of Agreement for the NASPO cooperative purchasing program, incorporated herein by reference.

Solicitation Publication Period

Bidders/Offerors will be given at least 40 days after publication to submit proposals.

Solicitation Type and Evaluation Criteria

This RFP will be issued and evaluated in concert with the procurement laws and rules of the State of **Utah** by a sourcing team comprised of members from several states.

Award(s):

The solicitation will permit multiple awards.

Additional Requested Information

State Specific Terms and Conditions: If the participating state wishes to include any State specific terms and conditions with the release of this RFP, please attach those with this Intent to Participate.

Annual Estimated Volume: If your State has an existing contract for this commodity or service, please indicate your annual volume of spend (including any potential political subdivision usage if available).

Annual State Spend \$2,080,000

Annual Political Subdivision Spend 2,500,000

Total Spend 4,580,000

State of Tennessee

Michael Perry
Director Name

615-741-3625
Director Phone

Mike.Perry@tn.gov
Director Email

Director has approved submitting the ITP? Yes No
(Click appropriate box)

State Specific T&Cs to be included in RFP? Yes No
(Click appropriate box)

Laitin Beecham, Category Specialist
State Point of Contact Name and Title

615-291-5794
Phone

Laitin.Beecham@tn.gov
Email

Please email completed "Intent to Participate" document by March 12, 2021 to:

Tara Larwick
Cooperative Contract Coordinator
NASPO ValuePoint
tlarwick@naspovaluepoint.org

**STATE OF TENNESSEE PARTICIPATING ADDENDUM
TO NASPO RFP #####
SMALL PACKAGE DELIVERY SERVICES 2021 - 2026**

- A. SCOPE:** This State of Tennessee Participating Addendum (hereinafter “Contract”) by and between the State of Tennessee (“hereinafter “State”) and **Company(ies)** (hereinafter “Contractor”) is for the provision of Small Package Delivery Services.

The State may purchase and the Contractor shall provide all goods and services, including inbound and outbound US domestic and international door-to-door express small package air and expedited ground intrastate, interstate, and international delivery services offered under the NASPO ValuePoint State Cooperative Contract for Small Package Delivery Services 2021 – 2026 led by the State of Utah (hereinafter “Master Agreement”).

- A.1. The Contractor shall provide all goods or services and deliverables as required, described, and detailed below and shall meet all service and delivery timelines as specified by this Contract.
- A.2. Warranty. Contractor represents and warrants that the term of the warranty (“Warranty Period”) shall be the greater of the Term of this Contract or any other warranty generally offered by Contractor, its suppliers, or manufacturers to customers of its goods or services. The goods or services provided under this Contract shall conform to the terms and conditions of this Contract throughout the Warranty Period. Any nonconformance of the goods or services to the terms and conditions of this Contract shall constitute a “Defect” and shall be considered “Defective.” If Contractor receives notice of a Defect during the Warranty Period, then Contractor shall correct the Defect, at no additional charge.

Contractor represents and warrants that the State is authorized to possess and use all equipment, materials, software, and deliverables provided under this Contract.

Contractor represents and warrants that all goods or services provided under this Contract shall be provided in a timely and professional manner, by qualified and skilled individuals, and in conformity with standards generally accepted in Contractor’s industry.

If Contractor fails to provide the goods or services as warranted, then Contractor will re-provide the goods or services at no additional charge. If Contractor is unable or unwilling to re-provide the goods or services as warranted, then the State shall be entitled to recover the fees paid to Contractor for the Defective goods or services. Any exercise of the State’s rights under this Section shall not prejudice the State’s rights to seek any other remedies available under this Contract or applicable law.

- A.3. Inspection and Acceptance. The State shall have the right to inspect all goods or services provided by Contractor under this Contract. If, upon inspection, the State determines that the goods or services are Defective, the State shall notify Contractor, and Contractor shall re-deliver the goods or provide the services at no additional cost to the State. If after a period of thirty (30) days following delivery of goods or performance of services the State does not provide a notice of any Defects, the goods or services shall be deemed to have been accepted by the State.

B. TERM OF CONTRACT:

This Contract shall be effective on November 28, 2021 (“Effective Date”) and extend for a period of sixty (60) months after the Effective Date (“Term”). The State shall have no obligation for goods or services provided by the Contractor prior to the Effective Date.

C. PAYMENT TERMS AND CONDITIONS:

- C.1. Estimated Liability. The total purchases of any goods or services under the Contract are not known. The State estimates the purchases during the Term shall be **ten million dollars (\$,000,000.00)** ("Estimated Liability"). This Contract does not grant the Contractor any exclusive rights. The State does not guarantee that it will buy any minimum quantity of goods or services under this Contract. Subject to the terms and conditions of this Contract, the Contractor will only be paid for goods or services provided under this Contract after a purchase order is issued to Contractor by the State or as otherwise specified by this Contract.
- C.2. Price Changes. Prices listed in awarded published catalog, price lists or price schedule shall remain firm for three hundred sixty-five (365) days ("Firm Price Period").
- a. Price Decreases. After the Firm Price Period, prices shall be equitably adjusted to reflect a decrease in Contractor's costs.
- b. Price Increases. After the Firm Price Period, Contractor may request price increases. The request shall: include copies of the new price lists or catalog that reflect a change in the Contractor's cost; not constitute an increase in profit; and apply to all of the Contractor's customers.
- c. Approval of Price Changes. The State may at its sole option: (1) grant the Contractor's request; (2) cancel the Contract and award it to the next apparent best evaluated Respondent; (3) cancel the Contract and reissue the solicitation; or (4) deny the Contractor's request. If approved, any price changes of less than seven percent (7%) will become effective upon the State's approval in writing. Price changes exceeding seven percent (7%) shall require a Contract amendment. The Contractor shall honor all purchase orders dated prior to the approved price change. Upon request from the State, the Contractor shall furnish the approved catalog, price schedule or price list as applicable to the State at no charge.
- C.3. Payment Methodology. The Contractor shall be compensated based on the payment rates for goods or services contained in Contract Appendix # and as authorized by the State in a total amount as set forth in Section C.1. The Contractor's compensation shall be contingent upon the satisfactory provision of goods or services as set forth in Section A.
- C.4. Travel Compensation. The Contractor shall not be compensated or reimbursed for travel time, travel expenses, meals, or lodging.
- C.5. Invoice Requirements. The Contractor shall invoice the State only for goods delivered and accepted by the State or services satisfactorily provided at the amounts stipulated in Section C.3., above. Contractor shall submit invoices and necessary supporting documentation, no more frequently than once a month, and no later than thirty (30) days after goods or services have been provided to the following address:

State Agency Billing Address

- a. Each invoice, on Contractor's letterhead, shall clearly and accurately detail all of the following information (calculations must be extended and totaled correctly):
- (1) Invoice number (assigned by the Contractor);
 - (2) Invoice date;
 - (3) Contract number (assigned by the State);
 - (4) Customer account name: **State Agency & Division Name;**
 - (5) Customer account number (assigned by the Contractor to the above-referenced Customer);
 - (6) Contractor name;
 - (7) Contractor Tennessee Edison registration ID number;
 - (8) Contractor contact for invoice questions (name, phone, or email);
 - (9) Contractor remittance address;
 - (10) Description of delivered goods or services provided and invoiced, including identifying information as applicable;

- (11) Number of delivered or completed units, increments, hours, or days as applicable, of each good or service invoiced;
- (12) Applicable payment methodology (as stipulated in Section C.3.) of each good or service invoiced;
- (13) Amount due for each compensable unit of good or service; and
- (14) Total amount due for the invoice period.

b. Contractor's invoices shall:

- (1) Only include charges for goods delivered or services provided as described in Section A and in accordance with payment terms and conditions set forth in Section C;
- (2) Only be submitted for goods delivered or services completed and shall not include any charge for future goods to be delivered or services to be performed;
- (3) Not include Contractor's taxes, which includes without limitation Contractor's sales and use tax, excise taxes, franchise taxes, real or personal property taxes, or income taxes; and
- (4) Include shipping or delivery charges only as authorized in this Contract.

c. The timeframe for payment (or any discounts) begins only when the State is in receipt of an invoice that meets the minimum requirements of this Section C.5.

C.6. Payment of Invoice. A payment by the State shall not prejudice the State's right to object to or question any payment, invoice, or other matter. A payment by the State shall not be construed as acceptance of goods delivered, any part of the services provided, or as approval of any amount invoiced.

C.7. Invoice Reductions. The Contractor's invoice shall be subject to reduction for amounts included in any invoice or payment that is determined by the State, on the basis of audits conducted in accordance with the terms of this Contract, to not constitute proper compensation for goods delivered or services provided.

C.8. Deductions. The State reserves the right to deduct from amounts, which are or shall become due and payable to the Contractor under this or any contract between the Contractor and the State of Tennessee, any amounts that are or shall become due and payable to the State of Tennessee by the Contractor.

C.9. Prerequisite Documentation. The Contractor shall not invoice the State under this Contract until the State has received the following, properly completed documentation.

- a. The Contractor shall complete, sign, and present to the State the "Authorization Agreement for Automatic Deposit Form" provided by the State. By doing so, the Contractor acknowledges and agrees that, once this form is received by the State, payments to the Contractor, under this or any other contract the Contractor has with the State of Tennessee, may be made by ACH; and
- b. The Contractor shall complete, sign, and return to the State the State-provided W-9 form. The taxpayer identification number on the W-9 form must be the same as the Contractor's Federal Employer Identification Number or Social Security Number referenced in the Contractor's Edison registration information.

D. MANDATORY TERMS AND CONDITIONS:

D.1. Required Approvals. The State is not bound by this Contract until it is duly approved by the Parties and all appropriate State officials in accordance with applicable Tennessee laws and regulations. Depending upon the specifics of this Contract, this may include approvals by the Commissioner of Finance and Administration, the Commissioner of Human Resources, the Comptroller of the Treasury, and the Chief Procurement Officer. Approvals shall be evidenced by a signature or electronic approval.

- D.2. Communications and Contacts. All instructions, notices, consents, demands, or other communications required or contemplated by this Contract shall be in writing and shall be made by certified, first class mail, return receipt requested and postage prepaid, by overnight courier service with an asset tracking system, or by email or facsimile transmission with recipient confirmation. All communications, regardless of method of transmission, shall be addressed to the respective Party at the appropriate mailing address, facsimile number, or email address as stated below or any other address provided in writing by a Party.

The State:

Mr. Laitin Beecham, Category Specialist
Central Procurement Office
Tennessee Tower, 3rd Floor
312 Rosa L. Parks Avenue
Nashville, TN 37243
Laitin.Beecham@tn.gov
Telephone # 615-291-5794
FAX # 615-741-0684

The Contractor:

Contractor Contact Name & Title
Contractor Name
Address
Email Address
Telephone # Number
FAX # Number

All instructions, notices, consents, demands, or other communications shall be considered effective upon receipt or recipient confirmation as may be required.

- D.3. Modification and Amendment. This Contract may be modified only by a written amendment signed by all Parties and approved by all applicable State officials.
- D.4. Subject to Funds Availability. The Contract is subject to the appropriation and availability of State or federal funds. In the event that the funds are not appropriated or are otherwise unavailable, the State reserves the right to terminate this Contract upon written notice to the Contractor. The State's exercise of its right to terminate this Contract shall not constitute a breach of Contract by the State. Upon receipt of the written notice, the Contractor shall cease all work associated with the Contract. If the State terminates this Contract due to lack of funds availability, the Contractor shall be entitled to compensation for all conforming goods requested and accepted by the State and for all satisfactory and authorized services completed as of the termination date. Should the State exercise its right to terminate this Contract due to unavailability of funds, the Contractor shall have no right to recover from the State any actual, general, special, incidental, consequential, or any other damages of any description or amount.
- D.5. Termination for Convenience. The State may terminate this Contract for convenience without cause and for any reason. The State shall give the Contractor at least thirty (30) days written notice before the termination date. The Contractor shall be entitled to compensation for all conforming goods delivered and accepted by the State or for satisfactory, authorized services completed as of the termination date. In no event shall the State be liable to the Contractor for compensation for any goods neither requested nor accepted by the State or for any services neither requested by the State nor satisfactorily performed by the Contractor. In no event shall the State's exercise of its right to terminate this Contract for convenience relieve the Contractor of any liability to the State for any damages or claims arising under this Contract.
- D.6. Termination for Cause. If the Contractor fails to properly perform its obligations under this Contract in a timely or proper manner, or if the Contractor materially violates any terms of this

Contract ("Breach Condition"), the State shall have the right to immediately terminate the Contract and withhold payments in excess of compensation for completed services or provided goods. Notwithstanding the above, the Contractor shall not be relieved of liability to the State for damages sustained by virtue of any Breach Condition and the State may seek other remedies allowed at law or in equity for breach of this Contract.

- D.7. Assignment and Subcontracting. The Contractor shall not assign this Contract or enter into a subcontract for any of the goods or services provided under this Contract without the prior written approval of the State. Notwithstanding any use of the approved subcontractors, the Contractor shall be the prime contractor and responsible for compliance with all terms and conditions of this Contract. The State reserves the right to request additional information or impose additional terms and conditions before approving an assignment of this Contract in whole or in part or the use of subcontractors in fulfilling the Contractor's obligations under this Contract.
- D.8. Conflicts of Interest. The Contractor warrants that no part of the Contractor's compensation shall be paid directly or indirectly to an employee or official of the State of Tennessee as wages, compensation, or gifts in exchange for acting as an officer, agent, employee, subcontractor, or consultant to the Contractor in connection with any work contemplated or performed under this Contract.

The Contractor acknowledges, understands, and agrees that this Contract shall be null and void if the Contractor is, or within the past six (6) months has been, an employee of the State of Tennessee or if the Contractor is an entity in which a controlling interest is held by an individual who is, or within the past six (6) months has been, an employee of the State of Tennessee.

- D.9. Nondiscrimination. The Contractor hereby agrees, warrants, and assures that no person shall be excluded from participation in, be denied benefits of, or be otherwise subjected to discrimination in the performance of this Contract or in the employment practices of the Contractor on the grounds of handicap or disability, age, race, creed, color, religion, sex, national origin, or any other classification protected by federal or state law. The Contractor shall, upon request, show proof of nondiscrimination and shall post in conspicuous places, available to all employees and applicants, notices of nondiscrimination.
- D.10. Equal Opportunity. The Contractor agrees as follows:

- a. The Contractor will not discriminate against any employee or applicant for employment because of race, color, religion, sex, sexual orientation, gender identity, or national origin. The Contractor will take affirmative action to ensure that applicants are employed, and that employees are treated during employment, without regard to their race, color, religion, sex, sexual orientation, gender identity, or national origin. Such action shall include, but not be limited to the following:
- (1) Employment, upgrading, demotion, or transfer, recruitment or recruitment advertising;
 - (2) Layoff or termination;
 - (3) Rates of pay or other forms of compensation; and
 - (4) Selection for training, including apprenticeship.

The Contractor agrees to post in conspicuous places, available to employees and applicants for employment, notices to be provided by the contracting officer setting forth the provisions of this nondiscrimination clause.

- b. The Contractor will, in all solicitations or advertisements for employees placed by or on behalf of the Contractor, state that all qualified applicants will receive considerations for employment without regard to race, color, religion, sex, sexual orientation, gender identity, or national origin.
- c. If the State approves any subcontract, the subcontract shall include paragraphs (a) and (b) above.

- d. In addition, to the extent applicable the Contractor agrees to comply with 41 C.F. R. § 60-1.4, as that section is amended from time to time during the term.
- D.11. Prohibition of Illegal Immigrants. The requirements of Tenn. Code Ann. § 12-3-309 addressing the use of illegal immigrants in the performance of any contract to supply goods or services to the state of Tennessee, shall be a material provision of this Contract, a breach of which shall be grounds for monetary and other penalties, up to and including termination of this Contract.
- a. The Contractor agrees that the Contractor shall not knowingly utilize the services of an illegal immigrant in the performance of this Contract and shall not knowingly utilize the services of any subcontractor who will utilize the services of an illegal immigrant in the performance of this Contract. The Contractor shall reaffirm this attestation, in writing, by submitting to the State a completed and signed copy of the document at Attachment 1, semi-annually during the Term. If the Contractor is a party to more than one contract with the State, the Contractor may submit one attestation that applies to all contracts with the State. All Contractor attestations shall be maintained by the Contractor and made available to State officials upon request.
- b. Prior to the use of any subcontractor in the performance of this Contract, and semi-annually thereafter, during the Term, the Contractor shall obtain and retain a current, written attestation that the subcontractor shall not knowingly utilize the services of an illegal immigrant to perform work under this Contract and shall not knowingly utilize the services of any subcontractor who will utilize the services of an illegal immigrant to perform work under this Contract. Attestations obtained from subcontractors shall be maintained by the Contractor and made available to State officials upon request.
- c. The Contractor shall maintain records for all personnel used in the performance of this Contract. Contractor's records shall be subject to review and random inspection at any reasonable time upon reasonable notice by the State.
- d. The Contractor understands and agrees that failure to comply with this section will be subject to the sanctions of Tenn. Code Ann. § 12-3-309 for acts or omissions occurring after its effective date.
- e. For purposes of this Contract, "illegal immigrant" shall be defined as any person who is not: (i) a United States citizen; (ii) a Lawful Permanent Resident; (iii) a person whose physical presence in the United States is authorized; (iv) allowed by the federal Department of Homeland Security and who, under federal immigration laws or regulations, is authorized to be employed in the U.S.; or (v) is otherwise authorized to provide services under the Contract.
- D.12. Records. The Contractor shall maintain documentation for all charges under this Contract. The books, records, and documents of the Contractor, for work performed or money received under this Contract, shall be maintained for a period of five (5) full years from the date of the final payment and shall be subject to audit at any reasonable time and upon reasonable notice by the State, the Comptroller of the Treasury, or their duly appointed representatives. The financial statements shall be prepared in accordance with generally accepted accounting principles.
- D.13. Monitoring. The Contractor's activities conducted and records maintained pursuant to this Contract shall be subject to monitoring and evaluation by the State, the Comptroller of the Treasury, or their duly appointed representatives.
- D.14. Progress Reports. The Contractor shall submit brief, periodic, progress reports to the State as requested.
- D.15. Strict Performance. Failure by any Party to this Contract to require, in any one or more cases, the strict performance of any of the terms, covenants, conditions, or provisions of this Contract shall not be construed as a waiver or relinquishment of any term, covenant, condition, or

provision. No term or condition of this Contract shall be held to be waived, modified, or deleted except by a written amendment signed by the Parties.

- D.16. Independent Contractor. The Parties shall not act as employees, partners, joint venturers, or associates of one another. The Parties are independent contracting entities. Nothing in this Contract shall be construed to create an employer/employee relationship or to allow either Party to exercise control or direction over the manner or method by which the other transacts its business affairs or provides its usual services. The employees or agents of one Party are not employees or agents of the other Party.
- D.17. Patient Protection and Affordable Care Act. The Contractor agrees that it will be responsible for compliance with the Patient Protection and Affordable Care Act ("PPACA") with respect to itself and its employees, including any obligation to report health insurance coverage, provide health insurance coverage, or pay any financial assessment, tax, or penalty for not providing health insurance. The Contractor shall indemnify the State and hold it harmless from any costs to the State arising from Contractor's failure to fulfill its PPACA responsibilities for itself or its employees.
- D.18. Limitation of State's Liability. The State shall have no liability except as specifically provided in this Contract. In no event will the State be liable to the Contractor or any other party for any lost revenues, lost profits, loss of business, decrease in the value of any securities or cash position, time, goodwill, or any indirect, special, incidental, punitive, exemplary or consequential damages of any nature, whether based on warranty, contract, statute, regulation, tort (including but not limited to negligence), or any other legal theory that may arise under this Contract or otherwise. Notwithstanding anything else herein, the State's total liability under this Contract (including without limitation any exhibits, schedules, amendments or other attachments to the Contract) or otherwise shall under no circumstances exceed the Estimated Liability. This limitation of liability is cumulative and not per incident.
- D.19. Limitation of Contractor's Liability. In accordance with Tenn. Code Ann. § 12-3-701, the Contractor's liability for all claims arising under this Contract shall be limited to an amount equal to two (2) times the Estimated Liability amount detailed in Section C.1. and as may be amended, PROVIDED THAT in no event shall this Section limit the liability of the Contractor for: (i) intellectual property or any Contractor indemnity obligations for infringement for third-party intellectual property rights; (ii) any claims covered by any specific provision in the Contract providing for liquidated damages; or (iii) any claims for intentional torts, criminal acts, fraudulent conduct, or acts or omissions that result in personal injuries or death.
- D.20. Hold Harmless. The Contractor agrees to indemnify and hold harmless the State of Tennessee as well as its officers, agents, and employees from and against any and all claims, liabilities, losses, and causes of action which may arise, accrue, or result to any person, firm, corporation, or other entity which may be injured or damaged as a result of acts, omissions, or negligence on the part of the Contractor, its employees, or any person acting for or on its or their behalf relating to this Contract. The Contractor further agrees it shall be liable for the reasonable cost of attorneys' fees, court costs, expert witness fees, and other litigation expenses for the State to enforce the terms of this Contract.

In the event of any suit or claim, the Parties shall give each other immediate notice and provide all necessary assistance to respond. The failure of the State to give notice shall only relieve the Contractor of its obligations under this Section to the extent that the Contractor can demonstrate actual prejudice arising from the failure to give notice. This Section shall not grant the Contractor, through its attorneys, the right to represent the State in any legal matter, as the right to represent the State is governed by Tenn. Code Ann. § 8-6-106.

- D.21. HIPAA Compliance. The State and Contractor shall comply with obligations under the Health Insurance Portability and Accountability Act of 1996 ("HIPAA"), Health Information Technology for Economic and Clinical Health ("HITECH") Act and any other relevant laws and regulations regarding privacy (collectively the "Privacy Rules"). The obligations set forth in this Section shall survive the termination of this Contract.

- a. Contractor warrants to the State that it is familiar with the requirements of the Privacy Rules, and will comply with all applicable requirements in the course of this Contract.
 - b. Contractor warrants that it will cooperate with the State, including cooperation and coordination with State privacy officials and other compliance officers required by the Privacy Rules, in the course of performance of the Contract so that both parties will be in compliance with the Privacy Rules.
 - c. The State and the Contractor will sign documents, including but not limited to business associate agreements, as required by the Privacy Rules and that are reasonably necessary to keep the State and Contractor in compliance with the Privacy Rules. This provision shall not apply if information received or delivered by the parties under this Contract is NOT “protected health information” as defined by the Privacy Rules, or if the Privacy Rules permit the parties to receive or deliver the information without entering into a business associate agreement or signing another document.
 - d. The Contractor will indemnify the State and hold it harmless for any violation by the Contractor or its subcontractors of the Privacy Rules. This includes the costs of responding to a breach of protected health information, the costs of responding to a government enforcement action related to the breach, and any fines, penalties, or damages paid by the State because of the violation.
- D.22. Tennessee Consolidated Retirement System. Subject to statutory exceptions contained in Tenn. Code Ann. §§ 8-36-801, *et seq.*, the law governing the Tennessee Consolidated Retirement System (“TCRS”), provides that if a retired member of TCRS, or of any superseded system administered by TCRS, or of any local retirement fund established under Tenn. Code Ann. §§ 8-35-101, *et seq.*, accepts State employment, the member’s retirement allowance is suspended during the period of the employment. Accordingly and notwithstanding any provision of this Contract to the contrary, the Contractor agrees that if it is later determined that the true nature of the working relationship between the Contractor and the State under this Contract is that of “employee/employer” and not that of an independent contractor, the Contractor, if a retired member of TCRS, may be required to repay to TCRS the amount of retirement benefits the Contractor received from TCRS during the Term.
- D.23. Tennessee Department of Revenue Registration. The Contractor shall comply with all applicable registration requirements contained in Tenn. Code Ann. §§ 67-6-601 – 608. Compliance with applicable registration requirements is a material requirement of this Contract.
- D.24. Debarment and Suspension. The Contractor certifies, to the best of its knowledge and belief, that it, its current and future principals, its current and future subcontractors and their principals:
- a. are not presently debarred, suspended, proposed for debarment, declared ineligible, or voluntarily excluded from covered transactions by any federal or state department or agency;
 - b. have not within a three (3) year period preceding this Contract been convicted of, or had a civil judgment rendered against them from commission of fraud, or a criminal offense in connection with obtaining, attempting to obtain, or performing a public (federal, state, or local) transaction or grant under a public transaction; violation of federal or state antitrust statutes or commission of embezzlement, theft, forgery, bribery, falsification, or destruction of records, making false statements, or receiving stolen property;
 - c. are not presently indicted or otherwise criminally or civilly charged by a government entity (federal, state, or local) with commission of any of the offenses detailed in section b. of this certification; and
 - d. have not within a three (3) year period preceding this Contract had one or more public transactions (federal, state, or local) terminated for cause or default.

The Contractor shall provide immediate written notice to the State if at any time it learns that there was an earlier failure to disclose information or that due to changed circumstances, its principals or the principals of its subcontractors are excluded, disqualified, or presently fall under any of the prohibitions of sections a-d.

- D.25. Force Majeure. "Force Majeure Event" means fire, flood, earthquake, elements of nature or acts of God, wars, riots, civil disorders, rebellions or revolutions, acts of terrorism or any other similar cause beyond the reasonable control of the Party except to the extent that the non-performing Party is at fault in failing to prevent or causing the default or delay, and provided that the default or delay cannot reasonably be circumvented by the non-performing Party through the use of alternate sources, workaround plans or other means. A strike, lockout or labor dispute shall not excuse either Party from its obligations under this Contract. Except as set forth in this Section, any failure or delay by a Party in the performance of its obligations under this Contract arising from a Force Majeure Event is not a default under this Contract or grounds for termination. The non-performing Party will be excused from performing those obligations directly affected by the Force Majeure Event, and only for as long as the Force Majeure Event continues, provided that the Party continues to use diligent, good faith efforts to resume performance without delay. The occurrence of a Force Majeure Event affecting Contractor's representatives, suppliers, subcontractors, customers or business apart from this Contract is not a Force Majeure Event under this Contract. Contractor will promptly notify the State of any delay caused by a Force Majeure Event (to be confirmed in a written notice to the State within one (1) day of the inception of the delay) that a Force Majeure Event has occurred, and will describe in reasonable detail the nature of the Force Majeure Event. If any Force Majeure Event results in a delay in Contractor's performance longer than forty-eight (48) hours, the State may, upon notice to Contractor: (a) cease payment of the fees for the affected obligations until Contractor resumes performance of the affected obligations; or (b) immediately terminate this Contract or any purchase order, in whole or in part, without further payment except for fees then due and payable. Contractor will not increase its charges under this Contract or charge the State any fees other than those provided for in this Contract as the result of a Force Majeure Event.
- D.26. State and Federal Compliance. The Contractor shall comply with all State and federal laws and regulations applicable to Contractor in the Contractor's performance of this Contract.
- D.27. Governing Law. This Contract shall be governed by and construed in accordance with the laws of the State of Tennessee, without regard to its conflict or choice of law rules. The Tennessee Claims Commission or the state or federal courts in Tennessee shall be the venue for all claims, disputes, or disagreements arising under this Contract. The Contractor acknowledges and agrees that any rights, claims, or remedies against the State of Tennessee or its employees arising under this Contract shall be subject to and limited to those rights and remedies available under Tenn. Code Ann. §§ 9-8-101 - 408.
- D.28. Entire Agreement. This Contract is complete and contains the entire understanding between the Parties relating to its subject matter, including all the terms and conditions of the Parties' agreement. This Contract supersedes any and all prior understandings, representations, negotiations, and agreements between the Parties, whether written or oral.
- D.29. Severability. If any terms and conditions of this Contract are held to be invalid or unenforceable as a matter of law, the other terms and conditions of this Contract shall not be affected and shall remain in full force and effect. The terms and conditions of this Contract are severable.
- D.30. Headings. Section headings of this Contract are for reference purposes only and shall not be construed as part of this Contract.
- D.31. Incorporation of Additional Documents. Each of the following documents is included as a part of this Contract by reference. In the event of a discrepancy or ambiguity regarding the Contractor's duties, responsibilities, and performance under this Contract, these items shall govern in order of precedence below:

- a. any amendment to this Contract, with the latter in time controlling over any earlier amendments;
 - b. this Contract with any attachments or exhibits (excluding the items listed at subsections c. through f., below), which includes [identify attachments and exhibits];
 - c. any clarifications of or addenda to the Contractor's proposal seeking this Contract;
 - d. the NASPO solicitation, as may be amended, requesting responses in competition for this Contract;
 - e. any technical specifications provided to proposers during the procurement process to award this Contract; and
 - f. the Contractor's response seeking this Contract.
- D.32. Iran Divestment Act. The requirements of Tenn. Code Ann. § 12-12-101, *et seq.*, addressing contracting with persons as defined at Tenn. Code Ann. §12-12-103(5) that engage in investment activities in Iran, shall be a material provision of this Contract. The Contractor certifies, under penalty of perjury, that to the best of its knowledge and belief that it is not on the list created pursuant to Tenn. Code Ann. § 12-12-106.
- D.33. Insurance. Contractor shall maintain insurance coverage as specified in this Section. The State reserves the right to amend or require additional insurance coverage, coverage amounts, and endorsements required under this Contract. Contractor's failure to maintain or submit evidence of insurance coverage, as required, is a material breach of this Contract. If Contractor loses insurance coverage, fails to renew coverage, or for any reason becomes uninsured during the Term, Contractor shall immediately notify the State. All insurance companies providing coverage must be: (a) acceptable to the State; (b) authorized by the Tennessee Department of Commerce and Insurance ("TDCI"); and (c) rated A- / VII or better by A.M. Best. All coverage must be on a primary basis and noncontributory with any other insurance or self-insurance carried by the State. Contractor agrees to name the State as an additional insured on any insurance policy with the exception of workers' compensation (employer liability) and professional liability (errors and omissions) insurance. All policies must contain an endorsement for a waiver of subrogation in favor of the State. Any deductible or self insured retention ("SIR") over fifty thousand dollars (\$50,000) must be approved by the State. The deductible or SIR and any premiums are the Contractor's sole responsibility. The Contractor agrees that the insurance requirements specified in this Section do not reduce any liability the Contractor has assumed under this Contract including any indemnification or hold harmless requirements.

To achieve the required coverage amounts, a combination of an otherwise deficient specific policy and an umbrella policy with an aggregate meeting or exceeding the required coverage amounts is acceptable. For example: If the required policy limit under this Contract is for two million dollars (\$2,000,000) in coverage, acceptable coverage would include a specific policy covering one million dollars (\$1,000,000) combined with an umbrella policy for an additional one million dollars (\$1,000,000). If the deficient underlying policy is for a coverage area without aggregate limits (generally Automobile Liability and Employers' Liability Accident), Contractor shall provide a copy of the umbrella insurance policy documents to ensure that no aggregate limit applies to the umbrella policy for that coverage area. In the event that an umbrella policy is being provided to achieve any required coverage amounts, the umbrella policy shall be accompanied by an endorsement at least as broad as the Insurance Services Office, Inc. (also known as "ISO") "Noncontributory—Other Insurance Condition" endorsement or shall be written on a policy form that addresses both the primary and noncontributory basis of the umbrella policy if the State is otherwise named as an additional insured.

Contractor shall provide the State a certificate of insurance ("COI") evidencing the coverages and amounts specified in this Section. The COI must be on a form approved by the TDCI (standard ACORD form preferred). The COI must list each insurer's National Association of Insurance Commissioners (NAIC) number and be signed by an authorized representative of the insurer. The COI must list the State of Tennessee – CPO Risk Manager, 312 Rosa L. Parks Ave., 3rd floor Central Procurement Office, Nashville, TN 37243 as the certificate holder. Contractor shall provide the COI ten (10) business days prior to the Effective Date and again thirty (30) calendar days before renewal or replacement of coverage. Contractor shall provide the State evidence that all subcontractors maintain the required insurance or that subcontractors are included under

the Contractor's policy. At any time, the State may require Contractor to provide a valid COI. The Parties agree that failure to provide evidence of insurance coverage as required is a material breach of this Contract. If Contractor self-insures, then a COI will not be required to prove coverage. Instead Contractor shall provide a certificate of self-insurance or a letter, on Contractor's letterhead, detailing its coverage, policy amounts, and proof of funds to reasonably cover such expenses. The State reserves the right to require complete, certified copies of all required insurance policies, including endorsements required by these specifications, at any time.

The State agrees that it shall give written notice to the Contractor as soon as practicable after the State becomes aware of any claim asserted or made against the State, but in no event later than thirty (30) calendar days after the State becomes aware of such claim. The failure of the State to give notice shall only relieve the Contractor of its obligations under this Section to the extent that the Contractor can demonstrate actual prejudice arising from the failure to give notice. This Section shall not grant the Contractor or its insurer, through its attorneys, the right to represent the State in any legal matter, as the right to represent the State is governed by Tenn. Code Ann. § 8-6-106.

The insurance obligations under this Contract shall be: (1)—all the insurance coverage and policy limits carried by the Contractor; or (2)—the minimum insurance coverage requirements and policy limits shown in this Contract; whichever is greater. Any insurance proceeds in excess of or broader than the minimum required coverage and minimum required policy limits, which are applicable to a given loss, shall be available to the State. No representation is made that the minimum insurance requirements of the Contract are sufficient to cover the obligations of the Contractor arising under this Contract. The Contractor shall obtain and maintain, at a minimum, the following insurance coverages and policy limits.

a. Commercial General Liability ("CGL") Insurance

- 1) The Contractor shall maintain CGL, which shall be written on an ISO Form CG 00 01 occurrence form (or a substitute form providing equivalent coverage) and shall cover liability arising from property damage, premises and operations products and completed operations, bodily injury, personal and advertising injury, and liability assumed under an insured contract (including the tort liability of another assumed in a business contract).

The Contractor shall maintain single limits not less than one million dollars (\$1,000,000) per occurrence. If a general aggregate limit applies, either the general aggregate limit shall apply separately to this policy or location of occurrence or the general aggregate limit shall be twice the required occurrence limit.

b. Workers' Compensation and Employer Liability Insurance

- 1) For Contractors statutorily required to carry workers' compensation and employer liability insurance, the Contractor shall maintain:
 - i. Workers' compensation in an amount not less than one million dollars (\$1,000,000) including employer liability of one million dollars (\$1,000,000) per accident for bodily injury by accident, one million dollars (\$1,000,000) policy limit by disease, and one million dollars (\$1,000,000) per employee for bodily injury by disease.
- 2) If the Contractor certifies that it is exempt from the requirements of Tenn. Code Ann. §§ 50-6-101 – 103, then the Contractor shall furnish written proof of such exemption for one or more of the following reasons:
 - i. The Contractor employs fewer than five (5) employees;

- ii. The Contractor is a sole proprietor;
- iii. The Contractor is in the construction business or trades with no employees;
- iv. The Contractor is in the coal mining industry with no employees;
- v. The Contractor is a state or local government; or
- vi. The Contractor self-insures its workers' compensation and is in compliance with the TDCI rules and Tenn. Code Ann. § 50-6-405.

c. Automobile Liability Insurance

- 1) The Contractor shall maintain automobile liability insurance which shall cover liability arising out of any automobile (including owned, leased, hired, and non-owned automobiles).
- 2) The Contractor shall maintain bodily injury/property damage with a limit not less than one million dollars (\$1,000,000) per occurrence or combined single limit.

D.34. Major Procurement Contract Sales and Use Tax. Pursuant to Tenn. Code Ann. § 4-39-102 and to the extent applicable, the Contractor and the Contractor's subcontractors shall remit sales and use taxes on the sales of goods or services that are made by the Contractor or the Contractor's subcontractors and that are subject to tax.

D.35. Confidentiality of Records. Strict standards of confidentiality of records and information shall be maintained in accordance with applicable state and federal law. All material and information, regardless of form, medium or method of communication, provided to the Contractor by the State or acquired by the Contractor on behalf of the State that is regarded as confidential under state or federal law shall be regarded as "Confidential Information." Nothing in this Section shall permit Contractor to disclose any Confidential Information, regardless of whether it has been disclosed or made available to the Contractor due to intentional or negligent actions or inactions of agents of the State or third parties. Confidential Information shall not be disclosed except as required or permitted under state or federal law. Contractor shall take all necessary steps to safeguard the confidentiality of such material or information in conformance with applicable state and federal law.

The obligations set forth in this Section shall survive the termination of this Contract.

E. SPECIAL TERMS AND CONDITIONS:

E.1. Conflicting Terms and Conditions. Should any of these special terms and conditions conflict with any other terms and conditions of this Contract, the special terms and conditions shall be subordinate to the Contract's other terms and conditions.

E.2. Statewide Contract. This Contract establishes a source or sources of supply for all Tennessee State Agencies. "Tennessee State Agency" refers to the various departments, institutions, boards, commissions, and agencies of the executive branch of government of the State of Tennessee with exceptions as addressed in Tenn. Comp. R. & Regs. 0690-03-01-.01. The Contractor shall provide all goods or services and deliverables as required by this Contract to all Tennessee State Agencies. The Contractor shall make this Contract available to the following entities, who are authorized to and who may purchase off of this Statewide Contract ("Authorized Users"):

- a. all Tennessee State governmental entities (this includes the legislative branch; judicial branch; and, commissions and boards of the State outside of the executive branch of government);
- b. Tennessee local governmental agencies;

- c. members of the University of Tennessee or Tennessee Board of Regents systems;
- d. any private nonprofit institution of higher education chartered in Tennessee; and,
- e. any corporation which is exempted from taxation under 26 U.S.C. Section 501(c) (3), as amended, and which contracts with the Department of Mental Health and Substance Abuse to provide services to the public (Tenn. Code Ann. § 33-2-1001).

These Authorized Users may utilize this Contract by purchasing directly from the Contractor according to their own procurement policies and procedures. The State is not responsible or liable for the transactions between the Contractor and Authorized Users.

E.3. Statewide Contract Reports. All reports shall be submitted electronically in Microsoft Excel format. Reports shall include the ability to sort or summarize data in accordance with the Contract Administrator's specifications. All reports shall be provided at no additional cost to the State.

a. Quarterly Reports: Contractor(s) will submit quarterly reports to the Contract Administrator no later than thirty (30) days after the end of the State's quarter (e.g. a fiscal year quarter 2 report for October - December is due no later than January 30th). At the Contract Administrator's sole discretion, the State may extend the time allowed to complete quarterly reports. Quarterly reports shall provide statistical data on all purchases under this Contract by Tennessee State Agencies and Authorized Users. At minimum, the quarterly report's statistical data shall be detailed and broken down by line item to include:

1. Edison contract number
2. Contract line item number
3. Invoice date
4. Invoice number
5. Supplier part number
6. Item or bundle description
7. Quantity purchased
8. Unit of measure
9. Unit of measure description
10. Name of State Agency or Authorized User
11. Identity of purchaser: State entity or non-State entity
12. State Agency location
13. Unit/Contract price per line item
14. List price as listed in supplier's catalog if catalog item
15. Subtotals for each category above
16. Grand totals for each category above

b. Custom Reports: When requested by the State, the Contractor shall submit custom reports to the Contract Administrator within thirty (30) days of the request.

E.4. State of Tennessee Administrative Fee. A one percent (1%) administrative fee will be included in the cost of all goods and/or services purchased under this Contract. This one percent (1%) administrative fee will be rebated back to the State of Tennessee based on quarterly contract usage of all Authorized Users. The administrative fee is due to the State no later than sixty (60) days after the end of the specified reporting period, as detailed below:

Calendar Quarter 1 (Jan 1-Mar 31)
 Calendar Quarter 2 (Apr 1-June 30)
 Calendar Quarter 3 (July 1-Sep 30)
 Calendar Quarter 4 (Oct 1-Dec 31)

Contractor shall submit payments to:
 Ron Plumb, Director of Financial Management
 Department of General Services
 22nd Floor, William R Snodgrass, Tennessee Tower
 312 Rosa L. Parks Avenue

Nashville, TN 37243

Contract usage reports shall be submitted to:
Contract Administrator
Department of General Services
3rd Floor, William R. Snodgrass, Tennessee Tower
312 Rosa L. Parks Avenue
Nashville, TN 37243
Email: CPO.SWC@tn.gov

- E.5. Intellectual Property Indemnity. The Contractor agrees to indemnify and hold harmless the State of Tennessee as well as its officers, agents, and employees from and against any and all claims or suits which may be brought against the State concerning or arising out of any claim of an alleged patent, copyright, trade secret or other intellectual property infringement. In any such claim or action brought against the State, the Contractor shall satisfy and indemnify the State for the amount of any settlement or final judgment, and the Contractor shall be responsible for all legal or other fees or expenses incurred by the State arising from any such claim. The State shall give the Contractor notice of any such claim or suit, however, the failure of the State to give such notice shall only relieve Contractor of its obligations under this Section to the extent Contractor can demonstrate actual prejudice arising from the State's failure to give notice. This Section shall not grant the Contractor, through its attorneys, the right to represent the State of Tennessee in any legal matter, as provided in Tenn. Code Ann. § 8-6-106.
- E.6. Software License Warranty. Contractor grants a license to the State to use all software provided under this Contract in the course of the State's business and purposes.
- E.7. Software Support and Maintenance Warranty. Contractor shall provide to the State all software upgrades, modifications, bug fixes, or other improvements in its software that it makes generally available to its customers.
- E.8. Prison Rape Elimination Act (PREA). The Contractor must comply with the Prison Rape Elimination Act (PREA) of 2003 (Federal law 42 U.S.C. 15601 et. seq.), with all applicable Federal PREA standards, and with all State policies and standards related to PREA for preventing, detecting, monitoring, investigating, and eradicating any form of sexual abuse within facilities/programs/offices owned, operated, or contracted.
- E.9. Lobbying. The Contractor certifies, to the best of its knowledge and belief, that:
- a. No federally appropriated funds have been paid or will be paid, by or on behalf of the Contractor, to any person for influencing or attempting to influence an officer or employee of an agency, a member of Congress, an officer or employee of Congress, or an employee of a member of Congress in connection with the awarding of any federal contract, the making of any federal grant, the making of any federal loan, the entering into of any cooperative agreement, and the extension, continuation, renewal, amendment, or modification of any federal contract, grant, loan, or cooperative agreement.
 - b. If any funds other than federally appropriated funds have been paid or will be paid to any person for influencing or attempting to influence an officer or employee of any agency, a member of Congress, an officer or employee of Congress, or an employee of a member of Congress in connection with any contract, grant, loan, or cooperative agreement, the Contractor shall complete and submit Standard Form-LLL, "Disclosure Form to Report Lobbying," in accordance with its instructions.
 - c. The Contractor shall require that the language of this certification be included in the award documents for all sub-awards at all tiers (including subcontracts, sub-grants, and contracts under grants, loans, and cooperative agreements) and that all subrecipients shall certify and disclose accordingly.

This certification is a material representation of fact upon which reliance was placed when this transaction was made or entered into and is a prerequisite for making or entering into this transaction imposed by 31 U.S.C. § 1352.

- E.10. Contractor Commitment to Diversity. The Contractor shall comply with and make reasonable business efforts to exceed the commitment to diversity represented by the Contractor's Response to this Participating Addendum (Attachment 2) and resulting in this Contract.

The Contractor shall assist the State in monitoring the Contractor's performance of this commitment by providing, as requested, a monthly report of participation in the performance of this Contract by small business enterprises and businesses owned by minorities, women, service-disabled veterans, and persons with disabilities. Such reports shall be provided to the State of Tennessee Governor's Office of Diversity Business Enterprise in the TN Diversity Software available online at:

<https://tn.diversitysoftware.com/FrontEnd/StartCertification.asp?TN=tn&XID=9810>.

- E.11. Partial Takeover of Contract. The State may, at its convenience and without cause, exercise a partial takeover of any service that the Contractor is obligated to perform under this Contract, including any service which is the subject of a subcontract between Contractor and a third party (a "Partial Takeover"). A Partial Takeover of this Contract by the State shall not be deemed a breach of contract. The Contractor shall be given at least thirty (30) days prior written notice of a Partial Takeover. The notice shall specify the areas of service the State will assume and the date the State will be assuming. The State's exercise of a Partial Takeover shall not alter the Contractor's other duties and responsibilities under this Contract. The State reserves the right to withhold from the Contractor any amounts the Contractor would have been paid but for the State's exercise of a Partial Takeover. The amounts shall be withheld effective as of the date the State exercises its right to a Partial Takeover. The State's exercise of its right to a Partial Takeover of this Contract shall not entitle the Contractor to any actual, general, special, incidental, consequential, or any other damages irrespective of any description or amount.

- E.12. Unencumbered Personnel. The Contractor shall not restrict its employees, agents, subcontractors or principals who perform services for the State under this Contract from performing the same or similar services for the State after the termination of this Contract, either as a State employee, an independent contractor, or an employee, agent, subcontractor or principal of another contractor with the State.

- E.13. Personally Identifiable Information. While performing its obligations under this Contract, Contractor may have access to Personally Identifiable Information held by the State ("PII"). For the purposes of this Contract, "PII" includes "Nonpublic Personal Information" as that term is defined in Title V of the Gramm-Leach-Bliley Act of 1999 or any successor federal statute, and the rules and regulations thereunder, all as may be amended or supplemented from time to time ("GLBA") and personally identifiable information and other data protected under any other applicable laws, rule or regulation of any jurisdiction relating to disclosure or use of personal information ("Privacy Laws"). Contractor agrees it shall not do or omit to do anything which would cause the State to be in breach of any Privacy Laws. Contractor shall, and shall cause its employees, agents and representatives to: (i) keep PII confidential and may use and disclose PII only as necessary to carry out those specific aspects of the purpose for which the PII was disclosed to Contractor and in accordance with this Contract, GLBA and Privacy Laws; and (ii) implement and maintain appropriate technical and organizational measures regarding information security to: (A) ensure the security and confidentiality of PII; (B) protect against any threats or hazards to the security or integrity of PII; and (C) prevent unauthorized access to or use of PII. Contractor shall immediately notify State: (1) of any disclosure or use of any PII by Contractor or any of its employees, agents and representatives in breach of this Contract; and (2) of any disclosure of any PII to Contractor or its employees, agents and representatives where the purpose of such disclosure is not known to Contractor or its employees, agents and representatives. The State reserves the right to review Contractor's policies and procedures

used to maintain the security and confidentiality of PII and Contractor shall, and cause its employees, agents and representatives to, comply with all reasonable requests or directions from the State to enable the State to verify or ensure that Contractor is in full compliance with its obligations under this Contract in relation to PII. Upon termination or expiration of the Contract or at the State's direction at any time in its sole discretion, whichever is earlier, Contractor shall immediately return to the State any and all PII which it has received under this Contract and shall destroy all records of such PII.

The Contractor shall report to the State any instances of unauthorized access to or potential disclosure of PII in the custody or control of Contractor ("Unauthorized Disclosure") that come to the Contractor's attention. Any such report shall be made by the Contractor within twenty-four (24) hours after the Unauthorized Disclosure has come to the attention of the Contractor. Contractor shall take all necessary measures to halt any further Unauthorized Disclosures. The Contractor, at the sole discretion of the State, shall provide no cost credit monitoring services for individuals whose PII was affected by the Unauthorized Disclosure. The Contractor shall bear the cost of notification to all individuals affected by the Unauthorized Disclosure, including individual letters and public notice. The remedies set forth in this Section are not exclusive and are in addition to any claims or remedies available to this State under this Contract or otherwise available at law. The obligations set forth in this Section shall survive the termination of this Contract.

- E.14. Federal Funding Accountability and Transparency Act (FFATA). This Contract requires the Contractor to provide supplies or services that are funded in whole or in part by federal funds that are subject to FFATA. The Contractor is responsible for ensuring that all applicable requirements, including but not limited to those set forth herein, of FFATA are met and that the Contractor provides information to the State as required.

The Contractor shall comply with the following:

a. Reporting of Total Compensation of the Contractor's Executives.

- (1) The Contractor shall report the names and total compensation of each of its five most highly compensated executives for the Contractor's preceding completed fiscal year, if in the Contractor's preceding fiscal year it received:
 - i. 80 percent or more of the Contractor's annual gross revenues from federal procurement contracts and federal financial assistance subject to the Transparency Act, as defined at 2 CFR 170.320 (and subawards); and
 - ii. \$25,000,000 or more in annual gross revenues from federal procurement contracts (and subcontracts), and federal financial assistance subject to the Transparency Act (and subawards); and
 - iii. The public does not have access to information about the compensation of the executives through periodic reports filed under section 13(a) or 15(d) of the Securities Exchange Act of 1934 (15 U.S.C. 78m(a), 78o(d)) or section 6104 of the Internal Revenue Code of 1986. (To determine if the public has access to the compensation information, see the U.S. Securities and Exchange Commission total compensation filings at <http://www.sec.gov/answers/execomp.htm>).

As defined in 2 C.F.R. § 170.315, "Executive" means officers, managing partners, or any other employees in management positions.

- (2) Total compensation means the cash and noncash dollar value earned by the executive during the Contractor's preceding fiscal year and includes the following (for more information see 17 C.F.R. § 229.402(c)(2)):
 - i. Salary and bonus.

- ii. Awards of stock, stock options, and stock appreciation rights. Use the dollar amount recognized for financial statement reporting purposes with respect to the fiscal year in accordance with the Statement of Financial Accounting Standards No. 123 (Revised 2004) (FAS 123R), Shared Based Payments.
 - iii. Earnings for services under non-equity incentive plans. This does not include group life, health, hospitalization or medical reimbursement plans that do not discriminate in favor of executives, and are available generally to all salaried employees.
 - iv. Change in pension value. This is the change in present value of defined benefit and actuarial pension plans.
 - v. Above-market earnings on deferred compensation which is not tax qualified.
 - vi. Other compensation, if the aggregate value of all such other compensation (e.g. severance, termination payments, value of life insurance paid on behalf of the employee, perquisites or property) for the executive exceeds \$10,000.
- b. The Contractor must report executive total compensation described above to the State by the end of the month during which this Contract is awarded.
 - c. If this Contract is amended to extend the Term, the Contractor must submit an executive total compensation report to the State by the end of the month in which the term extension becomes effective.
 - d. The Contractor will obtain a Data Universal Numbering System (DUNS) number and maintain its DUNS number for the term of this Contract. More information about obtaining a DUNS Number can be found at: <http://fedgov.dnb.com/webform/>

The Contractor's failure to comply with the above requirements is a material breach of this Contract for which the State may terminate this Contract for cause. The State will not be obligated to pay any outstanding invoice received from the Contractor unless and until the Contractor is in full compliance with the above requirements.

- E.15. Clean Air Act and Federal Water Pollution Control Act. If applicable, and as a condition for receipt of federal awards, the Contractor agrees to comply with the Clean Air Act, 42 U.S.C. § 7401 *et seq.* and the Federal Water Pollution Control Act, 33 U.S.C § 1251 *et seq.*, as those sections are amended from time to time during the term. Violations must be reported to FEMA and the Region 4 Office of the Environmental Protection Agency.
- E.16. Drug-Free Workplace. The Contractor shall provide a drug-free workplace pursuant to the Drug-Free Workplace Act of 1988, Title 41 U.S.C. §§ 701, *et seq.*, and the regulations in Title 41 U.S.C.A. §§ 8101 through 8106.
- E.17. Procurement of Recovered Materials. If applicable:
 - a) In the Performance of this contract, the Contractor shall make maximum use of products containing recovered materials that are EPA-designated items unless the product cannot be acquired competitively within a timeframe providing for compliance with the contract performance schedule; meeting contract performance requirements; or at a reasonable price.
 - b) Information about this requirement, along with the list of EPA-designated items, is available at EPA's Comprehensive.
 - c) Procurement Guidelines website, <https://www.epa.gov/smm/comprehensive-procurement-guideline-cpg-program>.

- d) The Contractor also agrees to comply with all other applicable requirements of Section 6002 of the Solid Waste Disposal Act.
- E.18. Access to Records. If FEMA funds are used in whole or in part:
- a) The Contractor agrees to provide the State, the FEMA Administrator, the Comptroller General of the United States, or any of their authorized representatives access to any books, documents, papers, and records of the Contractor which are directly pertinent to this contract for purposes of making audits, examinations, excerpts, and transcriptions.
- b) The Contractor agrees to permit any of the foregoing parties to reproduce by any means whatsoever or to copy excerpts and transcriptions as reasonably needed.
- c) The Contractor agrees to provide the FEMA Administrator or his authorized representatives access to construction or other work sites pertaining to the work being completed under the contract.
- d) In Compliance with the Disaster Recovery Act of 2018, the State and the Contractor acknowledge and agree that no language in this contract is intended to prohibit the audits or internal reviews by the FEMA Administrator or the Comptroller General of the United States.
- E.19. Use of DHS Logo. The contractor shall not use the DHS seal(s), logos, crests, or reproductions of flags or likenesses of DHS agency officials without specific FEMA pre-approval.
- E.20. Compliance with Federal Law, Regulations, and Executive Orders. This is an acknowledgement that FEMA financial assistance will be used to fund all or a portion of the contract. The contractor will comply with all applicable Federal law, regulations, executive orders, FEMA policies, procedures, and directives.
- E.21. Compliance with The False Claims Act. The Contractor acknowledges that 31 U.S.C. Chap. 38 (Administrative Remedies for False Claims and Statements) applies to the Contractor's actions pertaining to this contract.
- E.22. No Obligation by Federal Government. The Federal Government is not a party to this contract and is not subject to any obligations or liabilities to the non-Federal entity, contractor, or any other party pertaining to any matter resulting from the Contract.
- E.23. Equal Employment Opportunity. During the performance of this Contract, the Contractor agrees as follows:
- a. The Contractor will not discriminate against any employee or applicant for employment because of race, color, religion, sex, sexual orientation, gender identity, or national origin. The Contractor will take affirmative action to ensure that applicants are employed, and that employees are treated during employment, without regard to their race, color, religion, sex, sexual orientation, gender identity, or national origin. Such action shall include, but not be limited to the following: Employment, upgrading, demotion, or transfer, recruitment or recruitment advertising; layoff or termination; rates of pay or other forms of compensation; and selection for training, including apprenticeship. The Contractor agrees to post in conspicuous places, available to employees and applicants for employment, notices to be provided by the contracting officer setting forth the provisions of this nondiscrimination clause.
- b. The Contractor will, in all solicitations or advertisements for employees placed by or on behalf of the Contractor, state that all qualified applicants will receive consideration for employment without regard to race, color, religion, sex, sexual orientation, gender identity, or national origin.
- c. The Contractor will not discharge or in any other manner discriminate against any employee or applicant for employment because such employee or applicant has inquired about, discussed, or disclosed the compensation of the employee or applicant or another employee or applicant. This provision shall not apply to instances in which an employee who has access to the compensation information of other employees or applicants as a part of such employee's essential job functions

discloses the compensation of such other employees or applicants to individuals who do not otherwise have access to such information, unless such disclosure is in response to a formal complaint or charge, in furtherance of an investigation, proceeding, hearing, or action, including an investigation conducted by the employer, or is consistent with the contractor's legal duty to furnish information.

- d. The Contractor will send to each labor union or representative of workers with which it has a collective bargaining agreement or other contract or understanding, a notice to be provided by the agency contracting officer, advising the labor union or workers' representative of the contractor's commitments under section 202 of Executive Order 11246 of September 24, 1965, and shall post copies of the notice in conspicuous places available to employees and applicants for employment.
- e. The Contractor will comply with all provisions of Executive Order 11246 of September 24, 1965, and of the rules, regulations, and relevant orders of the Secretary of Labor.
- f. The Contractor will furnish all information and reports required by Executive Order 11246 of September 24, 1965, and by the rules, regulations, and orders of the Secretary of Labor, or pursuant thereto, and will permit access to his books, records, and accounts by the contracting agency and the Secretary of Labor for purposes of investigation to ascertain compliance with such rules, regulations, and orders.
- g. In the event of the Contractor's non-compliance with the nondiscrimination clauses of this contract or with any of such rules, regulations, or orders, this contract may be canceled, terminated or suspended in whole or in part and the contractor may be declared ineligible for further Government contracts in accordance with procedures authorized in Executive Order 11246 of September 24, 1965, and such other sanctions may be imposed and remedies invoked as provided in Executive Order 11246 of September 24, 1965, or by rule, regulation, or order of the Secretary of Labor, or as otherwise provided by law.
- h. The Contractor will include the portion of the sentence immediately preceding paragraph (1) and the provisions of paragraphs (1) through (8) in every subcontract or purchase order unless exempted by rules, regulations, or orders of the Secretary of Labor issued pursuant to section 204 of Executive Order 11246 of September 24, 1965, so that such provisions will be binding upon each subcontractor or vendor. The Contractor will take such action with respect to any subcontract or purchase order as the administering agency may direct as a means of enforcing such provisions, including sanctions for noncompliance:

Provided, however, that in the event a contractor becomes involved in, or is threatened with, litigation with a subcontractor or vendor as a result of such direction by the administering agency, the contractor may request the United States to enter into such litigation to protect the interests of the United States.

The applicant further agrees that it will be bound by the above equal opportunity clause with respect to its own employment practices when it participates in federally assisted construction work: Provided, That if the applicant so participating is a State or local government, the above equal opportunity clause is not applicable to any agency, instrumentality or subdivision of such government which does not participate in work on or under the contract.

The applicant agrees that it will assist and cooperate actively with the administering agency and the Secretary of Labor in obtaining the compliance of contractors and subcontractors with the equal opportunity clause and the rules, regulations, and relevant orders of the Secretary of Labor, that it will furnish the administering agency and the Secretary of Labor such information as they may require for the supervision of such compliance, and that it will otherwise assist the administering agency in the discharge of the agency's primary responsibility for securing compliance.

The applicant further agrees that it will refrain from entering into any contract or contract modification subject to Executive Order 11246 of September 24, 1965, with a contractor debarred

from, or who has not demonstrated eligibility for, Government contracts and federally assisted construction contracts pursuant to the Executive Order and will carry out such sanctions and penalties for violation of the equal opportunity clause as may be imposed upon contractors and subcontractors by the administering agency or the Secretary of Labor pursuant to Part II, Subpart D of the Executive Order. In addition, the applicant agrees that if it fails or refuses to comply with these undertakings, the administering agency may take any or all of the following actions: Cancel, terminate, or suspend in whole or in part this grant (contract, loan, insurance, guarantee); refrain from extending any further assistance to the applicant under the program with respect to which the failure or refund occurred until satisfactory assurance of future compliance has been received from such applicant; and refer the case to the Department of Justice for appropriate legal proceedings.

E.24. Contractor Hosted Services Confidential Data, Audit, and Other Requirements.

a. "Confidential State Data" is defined as data deemed confidential by State or Federal statute or regulation. The Contractor shall protect Confidential State Data as follows:

- (1) The Contractor shall ensure that all Confidential State Data is housed in the continental United States, inclusive of backup data.
- (2) The Contractor shall encrypt Confidential State Data at rest and in transit using the current version of Federal Information Processing Standard ("FIPS") 140-2 validated encryption technologies.
- (3) The Contractor and the Contractor's processing environment containing Confidential State Data shall either (1) be in accordance with at least one of the following security standards: (i) International Standards Organization ("ISO") 27001; (ii) Federal Risk and Authorization Management Program ("FedRAMP"); or (2) be subject to an annual engagement by a CPA firm in accordance with the standards of the American Institute of Certified Public Accountants ("AICPA") for a System and Organization Controls for service organizations ("SOC") Type II audit. The State shall approve the SOC audit control objectives. The Contractor shall provide proof of current ISO certification or FedRAMP authorization for the Contractor and Subcontractor(s), or provide the State with the Contractor's and Subcontractor's annual SOC Type II audit report within 30 days from when the CPA firm provides the audit report to the Contractor or Subcontractor. The Contractor shall submit corrective action plans to the State for any issues included in the audit report within 30 days after the CPA firm provides the audit report to the Contractor or Subcontractor.

If the scope of the most recent SOC audit report does not include all of the current State fiscal year, upon request from the State, the Contractor must provide to the State a letter from the Contractor or Subcontractor stating whether the Contractor or Subcontractor made any material changes to their control environment since the prior audit and, if so, whether the changes, in the opinion of the Contractor or Subcontractor, would negatively affect the auditor's opinion in the most recent audit report.

No additional funding shall be allocated for these certifications, authorizations, or audits as these are included in the Maximum Liability of this Contract.

- (4) The Contractor must annually perform Penetration Tests and Vulnerability Assessments against its Processing Environment. "Processing Environment" shall mean the combination of software and hardware on which the Application runs. "Application" shall mean the computer code that supports and accomplishes the State's requirements as set forth in this Contract. "Penetration Tests" shall be in the form of attacks on the Contractor's computer system, with

the purpose of discovering security weaknesses which have the potential to gain access to the Processing Environment's features and data. The "Vulnerability Assessment" shall be designed and executed to define, identify, and classify the security holes (vulnerabilities) in the Processing Environment. The Contractor shall allow the State, at its option, to perform Penetration Tests and Vulnerability Assessments on the Processing Environment.

- (5) Contractor shall be certified to host Payment Card Industry ("PCI") data in accordance with the current version of PCI DSS ("Data Security Standard"), maintained by the PCI Security Standards Council.
- (6) Upon termination of this Contract and in consultation with the State, the Contractor shall destroy all Confidential State Data it holds (including any copies such as backups) in accordance with the current version of National Institute of Standards and Technology ("NIST") Special Publication 800-88. The Contractor shall provide a written confirmation of destruction to the State within ten (10) business days after destruction.

b. Minimum Requirements

- (1) The Contractor and all data centers used by the Contractor to host State data, including those of all Subcontractors, must comply with the State's Enterprise Information Security Policies as amended periodically. The State's Enterprise Information Security Policies document is found at the following URL: <https://www.tn.gov/finance/strategic-technology-solutions/strategic-technology-solutions/sts-security-policies.html>.
- (2) The Contractor agrees to maintain the Application so that it will run on a current, manufacturer-supported Operating System. "Operating System" shall mean the software that supports a computer's basic functions, such as scheduling tasks, executing applications, and controlling peripherals.
- (3) If the Application requires middleware or database software, Contractor shall maintain middleware and database software versions that are at all times fully compatible with current versions of the Operating System and Application to ensure that security vulnerabilities are not introduced.

c. Comptroller Audit Requirements

Upon reasonable notice and at any reasonable time, the Contractor and Subcontractor(s) agree to allow the State, the Comptroller of the Treasury, or their duly appointed representatives to perform information technology control audits of the Contractor and all Subcontractors used by the Contractor. Contractor will maintain and cause its Subcontractors to maintain a complete audit trail of all transactions and activities in connection with this Contract. Contractor will provide to the State, the Comptroller of the Treasury, or their duly appointed representatives access to Contractor and Subcontractor(s) personnel for the purpose of performing the information technology control audit.

The information technology control audit may include a review of general controls and application controls. General controls are the policies and procedures that apply to all or a large segment of the Contractor's or Subcontractor's information systems and applications and include controls over security management, access controls, configuration management, segregation of duties, and contingency planning. Application controls are directly related to the application and help ensure that transactions are complete, accurate, valid, confidential, and available. The audit shall include the Contractor's and

Subcontractor's compliance with the State's Enterprise Information Security Policies and all applicable requirements, laws, regulations or policies.

The audit may include interviews with technical and management personnel, physical inspection of controls, and review of paper or electronic documentation.

For any audit issues identified, the Contractor and Subcontractor(s) shall provide a corrective action plan to the State within 30 days from the Contractor or Subcontractor receiving the audit report.

Each party shall bear its own expenses incurred while conducting the information technology controls audit.

- d. Business Continuity Requirements. The Contractor shall maintain set(s) of documents, instructions, and procedures which enable the Contractor to respond to accidents, disasters, emergencies, or threats without any stoppage or hindrance in its key operations ("Business Continuity Requirements"). Business Continuity Requirements shall include:
- (1) "Disaster Recovery Capabilities" refer to the actions the Contractor takes to meet the Recovery Point and Recovery Time Objectives defined below. Disaster Recovery Capabilities shall meet the following objectives:
 - i. Recovery Point Objective ("RPO"). The RPO is defined as the maximum targeted period in which data might be lost from an IT service due to a major incident: **[number of hours/minutes]**
 - ii. Recovery Time Objective ("RTO"). The RTO is defined as the targeted duration of time and a service level within which a business process must be restored after a disaster (or disruption) in order to avoid unacceptable consequences associated with a break in business continuity: **[number of hours/minutes]**
 - (2) The Contractor and any Subcontractor(s) shall perform at least one Disaster Recovery Test every three hundred sixty-five (365) days. A "Disaster Recovery Test" shall mean the process of verifying the success of the restoration procedures that are executed after a critical IT failure or disruption occurs. The Disaster Recovery Test shall use actual State Data Sets that mirror production data, and success shall be defined as the Contractor verifying that the Contractor can meet the State's RPO and RTO requirements. A "Data Set" is defined as a collection of related sets of information that is composed of separate elements but can be manipulated as a unit by a computer. The Contractor shall provide written confirmation to the State after each Disaster Recovery Test that its Disaster Recovery Capabilities meet the RPO and RTO requirements.

IN WITNESS WHEREOF,

CONTRACTOR LEGAL ENTITY NAME:

CONTRACTOR SIGNATURE

DATE

PRINTED NAME AND TITLE OF CONTRACTOR SIGNATORY (above)

STATE OF TENNESSEE, CENTRAL PROCUREMENT OFFICE:

MICHAEL F. PERRY, CHIEF PROCUREMENT OFFICER

DATE

ATTACHMENT 1

ATTESTATION RE PERSONNEL USED IN CONTRACT PERFORMANCE

If the attestation applies to more than one contract, modify this row accordingly.	
SUBJECT CONTRACT NUMBER:	
CONTRACTOR LEGAL ENTITY NAME:	
EDISON VENDOR IDENTIFICATION NUMBER:	

If the attestation applies to more than one contract, modify the following paragraph accordingly.

The Contractor, identified above, does hereby attest, certify, warrant, and assure that the Contractor shall not knowingly utilize the services of an illegal immigrant in the performance of this Contract and shall not knowingly utilize the services of any subcontractor who will utilize the services of an illegal immigrant in the performance of this Contract.

CONTRACTOR SIGNATURE

NOTICE: This attestation MUST be signed by an individual empowered to contractually bind the Contractor. Attach evidence documenting the individual's authority to contractually bind the Contractor, unless the signatory is the Contractor's chief executive or president.

PRINTED NAME AND TITLE OF SIGNATORY

DATE OF ATTESTATION

ATTACHMENT 2**GOVERNOR'S OFFICE OF DIVERSITY BUSINESS ENTERPRISE****Efforts to Achieve Diversity Business Participation**

The Governor's Office of Diversity Business Enterprise ("Go-DBE") is the State's central point of contact to attract and assist minority-owned, woman-owned, service-disabled veteran-owned, disabled-owned, and small business enterprises interested in competing in the State of Tennessee's procurement and contracting activities. These diversity business enterprises are defined as follows:

Minority Business Enterprise (MBE) and Woman Business Enterprise (WBE)

Businesses that are a continuing, independent, for-profit business which performs a commercially useful function, and is at least fifty-one percent (51%) owned and controlled by one (1) or more individuals in the minority or woman category who were impeded from normal entry into the economic mainstream because of past practices of discrimination based on race, ethnic background, or gender.

Service-Disabled Veteran Business Enterprise (SDVBE)

"Service-disabled veteran-owned business" means a service-disabled veteran-owned business located in the State of Tennessee that satisfies the criteria in Tenn. Code. Ann. § 12-3-1102(8).

"Service-disabled veteran" means any person who served honorably in active duty in the armed forces of the United States with at least a twenty percent (20%) disability that is service-connected, i.e., the disability was incurred or aggravated in the line of duty in the active military, naval or air service.

Small Business Enterprise (SBE)

"Small business" means a business that is a continuing, independent, for profit business which performs a commercially useful function with residence in Tennessee and has total gross receipts of no more than ten million dollars (\$10,000,000) averaged over a three-year period or employs no more than ninety-nine (99) persons on a full-time basis.

"Disabled Business Enterprise (DSBE)

"Disabled Business Enterprise" means a business owned by a person with a disability that is a continuing, independent, for-profit business that performs a commercially useful function, and is at least fifty-one (51%) owned and controlled by one (1) or more persons with a disability, or, in the case of any publicly-owned business, at least fifty one percent (51%) of the stock of which is owned and controlled by one(1) or more persons with a disability and whose management and daily business operations are under the control of one (1) or more persons with a disability.

For additional program eligibility information, visit:

<https://www.tn.gov/generalservices/procurement/central-procurement-office--cpo-/governor-s-office-of-diversity-business-enterprise--godbe--/program-eligibility.html>

Instructions

As part of this Invitation to Bid, the respondent should complete the Diversity Utilization Plan below. To assist in your effort to seek and solicit the participation of diversity businesses on this solicitation, a directory of certified Diversity Business Enterprise firms may be found on the State's website at: <https://tn.diversitysoftware.com/FrontEnd/VendorSearchPublic.asp?TN=tn&XID=1215> directory or by calling Go-DBE toll free at 866-894-5026.

RESPONDENT'S DIVERSITY UTILIZATION PLAN

Respondent's Company Name:		
Solicitation Event Name:		Event Number:
Respondent's Contact Name:	Phone: ()	Email:
Does the Respondent qualify as the diversity business enterprise? ___ Yes ___ No		
If yes, which designation does the Respondent qualify? ___ MBE ___ WBE ___ DSBE ___ SDVBE ___ SBE		
Certifying Agency:		

Estimated level of participation by DBEs if awarded a contract pursuant to this ITB:

Diversity Business Information (List all subcontractors, joint-ventures, and suppliers)	% of Contract	Estimated Amount	MBE/ WBE/ SDVBE/ SBE / DSBE Designation	Currently Certified (Yes or No)
Business Name:				
Contact Name:				
Contact Phone:				
Business Name:				
Contact Name:				
Contact Phone:				

If awarded a contract, we confirm our commitment to make reasonable business efforts to meet or exceed the commitment to diversity as represented in our Diversity Utilization Plan. We shall assist the State in monitoring our performance of this commitment by providing, as requested, a monthly report of participation in the performance of this Contract by small business enterprises and businesses owned by minorities, women, service-disabled veterans and persons with disabilities. Such reports shall be provided to the state of Tennessee Governor's Office of Diversity Business Enterprise in the TN Diversity Software available online at:

<https://tn.diversitysoftware.com/FrontEnd/StartCertification.asp?TN=tn&XID=9810>

We further agree to request in writing and receive prior approval from the Central Procurement Office for any changes to the use of the above listed diversity businesses.

Authorized Signature: _____ Date: _____

Printed Name and Title of Signatory _____



**NASPO ValuePoint
INTENT TO PARTICPATE
Cooperative Contract(s) for Small Package Delivery Services**

I. PURPOSE:

The purpose of this Agreement is to provide interested NASPO states with the opportunity to participate in multi-state cooperative contract(s) for the **Small Package Delivery Services SCOPE OF THE CONTRACT portfolio**

The State of **Utah** is authorized by agreement of the participants to act as the procurement officer in developing multi-state cooperative contract(s) for **Small Package Delivery Services**

The resulting contracts will be permissive contracts.

Administrative Fee

There will be a 0.25% NASPO ValuePoint administrative fee associated with these contracts. It is anticipated that the individual states will be able to add an administrative fee when the state executes its Participating Addendum.

II. TERM OF THE CONTRACT

The initial term of the contract will be established for **five years** from the date of award with options to extend the contract.

III. SOLICITATION AND CONTRACT DEVELOPMENT/ADDITIONAL INFORMATION

The solicitation and contract development shall be accomplished in compliance with the NASPO ValuePoint Process Guide and the NASPO Memorandum of Agreement for the NASPO cooperative purchasing program, incorporated herein by reference.

Solicitation Publication Period

Bidders/Offerors will be given at least 40 days after publication to submit proposals.

Solicitation Type and Evaluation Criteria

This RFP will be issued and evaluated in concert with the procurement laws and rules of the State of **Utah** by a sourcing team comprised of members from several states.

Award(s):

The solicitation will permit multiple awards.

Additional Requested Information

State Specific Terms and Conditions: If the participating state wishes to include any State specific terms and conditions with the release of this RFP, please attach those with this Intent to Participate.

[State of Ohio Standard Terms and Conditions](#)

Order of Priority: The State of Ohio Standard Contract Terms and Conditions are hereby incorporated into this Participating Addendum (PA) and shall be binding on the contractor. If there is any inconsistency or conflict between the PA Agreement and the Ohio Terms and Conditions, the Ohio Terms and Conditions will prevail. Notwithstanding anything to the contrary, all pricing shall be governed solely by the terms of the Consortium Contract.

Cooperative Purchasing Contract: This Contract may be relied upon by Ohio institutions of higher education and Ohio political subdivisions. Ohio political subdivisions include any county, township, municipal corporation, school district, conservancy district, township park district, park district created under Chapter 1545 of the Revised Code, regional transit authority, regional airport authority, regional water and sewer district, port authority or any other political subdivision as described in the Ohio Revised Code. To qualify to use this Contract the political subdivision must be currently enrolled in the State's Cooperative Purchasing Program. Purchases made from this Contract by a political subdivision that is not properly registered with the State's Cooperative Purchasing Program will be a violation of law and may be contrary to the political subdivision's competitive bidding requirements. If a political subdivision or institution of higher education relies upon this Contract to issue a purchase order or other ordering document, the political subdivision or institution of higher education "steps into the shoes" of the State under this Contract. The political division's or institution of higher education's order and this Contract are between the Contractor and the political subdivision or institution of higher education. The Contractor must look solely to the political subdivision or institution of higher education for performance, including payment. The Contractor agrees to hold the state of Ohio harmless with regard to political subdivisions and institution of higher education's orders and political subdivision's and institution of higher education's performance. DAS may cancel this Contract and may seek remedies if the Contractor fails to honor its obligations under an order from a political subdivision or institution of higher education.

Contractor Quarterly Sales Report: The Contractor must report the quarterly dollar value (in U.S. dollars and rounded to the nearest whole dollar) of the sales, to include both state agencies and political subdivisions, under this Contract by calendar quarter (e.g. January-March, April-June, July-September and October-December). The dollar value of the sale is the price paid by the Contract user for the products and/or services listed on the purchase order or other encumbering document, as recorded by the Contractor.

The Contractor will receive an email with a User ID and password and must report the quarterly dollar value of sales to the Department of Administrative Services (DAS) via the Internet using the web form at the Ohio DAS Contract Management Contractor Portal, <https://cm.ohio.gov/>. If no sales occur, the Contractor must show zero. The report must be submitted thirty (30) days following the completion of the reporting period. The Contractor is responsible for emailing the Analyst listed on page one of the contract with any company contact changes.

The Contractor shall also submit a close-out report within one hundred and twenty (120) days after the expiration of this Contract. The Contract expires upon the physical completion of the last outstanding task or delivery order of the Contract. The close-out report must cover all sales not shown in the final quarterly report and reconcile all errors and credits. If the Contractor reported all contract sales and reconciled all errors and credits on the final quarterly report, then the Contractor should show zero "0" sales in the close-out report.

The Contractor must forward the Quarterly Sales Report to one of the following addresses,

For same day or overnight deliveries:

Huntington National Bank
ATTN: L-3686
7 Easton Oval
Columbus, OH 43219

All other deliveries may be sent to the following address:

Department of Administrative Services
L-3686
Columbus, OH 43260-3686

If the Contractor fails to submit sales reports, falsifies reports or fails to submit sales reports in a timely manner, DAS may suspend, terminate or cancel this Contract.

Contractor Revenue Share: The Contractor must pay the Department of Administrative Services (DAS) a revenue share of the sales transacted under this contract. The Contractor must remit the revenue share in U.S. dollars within thirty (30) days after the end of the quarterly sales reporting period. The revenue share equals 0.75% of the total quarterly sales reported. Contractors must include the revenue share in their prices. The revenue share is included in the award price(s) and reflected in the total amount charged to ordering agencies which includes both state agencies and political subdivisions using this Contract.

The contractor must remit any monies due as the result of the close-out report at the time the close-out report is submitted to DAS. The Contractor must pay the revenue share amount due by check. To ensure the payment is credited properly, the Contractor must identify the check as a "Revenue Share" and include the Ohio Contract Management Remittance Report

The Contractor should make the check payable to: Treasurer, State of Ohio.

Use the following address for same day or overnight deliveries:

Huntington National Bank
ATTN: L-3686
7 Easton Oval
Columbus, OH 43219

All other deliveries may be sent to the following address:

Department of Administrative Services
L-3686
Columbus, OH 43260-3686

If the full amount of the revenue share is not paid within thirty (30) calendar days after the end of the applicable reporting period, the non-payment constitutes a contract debt to the State. The State may either initiate withholding or setting off payments or employ the remedies available under Ohio law for the non-payment of the revenue share.

If the Contractor fails to pay the revenue share in a timely manner, DAS may suspend, terminate or cancel this Contract.

Annual Estimated Volume: If your State has an existing contract for this commodity or service, please indicate your annual volume of spend (including any potential political subdivision usage if available).

Annual State Spend	\$1,012,622
Annual Political Subdivision Spend	\$2,912,092
Total Spend	\$3,924,714.64

State of Ohio

Kelly Sanders, State CPO

Director Name

614-466-5108

Director Phone

Teri.Purr@das.ohio.gov

Director Email

Director has approved submitting the ITP? Yes No
(Click appropriate box)

State Specific T&Cs to be included in RFP? Yes No
(Click appropriate box)

Megan Wampler

State Point of Contact Name and Title

614-752-0032

Phone

megan.wampler@das.ohio.gov

Email

Please email completed "Intent to Participate" document by March 11, 2021 to:

Tara Larwick

Cooperative Contract Coordinator

NASPO ValuePoint

tlarwick@naspovaluepoint.org



**NASPO ValuePoint
INTENT TO PARTICPATE
Cooperative Contract(s) for Small Package Delivery Services**

I. PURPOSE:

The purpose of this Agreement is to provide interested NASPO states with the opportunity to participate in multi-state cooperative contract(s) for the **Small Package Delivery Services SCOPE OF THE CONTRACT portfolio**

The State of **Utah** is authorized by agreement of the participants to act as the procurement officer in developing multi-state cooperative contract(s) for **Small Package Delivery Services**

The resulting contracts will be permissive contracts.

Administrative Fee

There will be a 0.25% NASPO ValuePoint administrative fee associated with these contracts. It is anticipated that the individual states will be able to add an administrative fee when the state executes its Participating Addendum.

II. TERM OF THE CONTRACT

The initial term of the contract will be established for **five years** from the date of award with options to extend the contract.

III. SOLICITATION AND CONTRACT DEVELOPMENT/ADDITIONAL INFORMATION

The solicitation and contract development shall be accomplished in compliance with the NASPO ValuePoint Process Guide and the NASPO Memorandum of Agreement for the NASPO cooperative purchasing program, incorporated herein by reference.

Solicitation Publication Period

Bidders/Offerors will be given at least 40 days after publication to submit proposals.

Solicitation Type and Evaluation Criteria

This RFP will be issued and evaluated in concert with the procurement laws and rules of the State of **Utah** by a sourcing team comprised of members from several states.

Award(s):

The solicitation will permit multiple awards.

Additional Requested Information

State Specific Terms and Conditions: If the participating state wishes to include any State specific terms and conditions with the release of this RFP, please attach those with this Intent to Participate.

Annual Estimated Volume: If your State has an existing contract for this commodity or service, please indicate your annual volume of spend (including any potential political subdivision usage if available).

Annual State Spend \$65,041.50

Annual Political Subdivision Spend \$13,980.40

Total Spend \$79,021.90

State of Delaware

Peter Korolyk

Deputy Director Name



302-857-4503

Director Phone

peter.korolyk@delaware.gov

Director Email

Director has approved submitting the ITP? Yes No
(Click appropriate box)

State Specific T&Cs to be included in RFP? Yes No
(Click appropriate box)

Takishia Kiah

State Point of Contact Name and Title

302-857-4551

Phone

Takishia.kiah@delaware.gov

Email

Please email completed "Intent to Participate" document by March 11, 2021 to:

Tara Larwick

Cooperative Contract Coordinator

NASPO ValuePoint

tlarwick@naspovaluepoint.org



**NASPO ValuePoint
INTENT TO PARTICPATE
Cooperative Contract(s) for Small Package Delivery Services**

I. PURPOSE:

The purpose of this Agreement is to provide interested NASPO states with the opportunity to participate in multi-state cooperative contract(s) for the **Small Package Delivery Services SCOPE OF THE CONTRACT portfolio**

The State of **Utah** is authorized by agreement of the participants to act as the procurement officer in developing multi-state cooperative contract(s) for **Small Package Delivery Services**

The resulting contracts will be permissive contracts.

Administrative Fee

There will be a 0.25% NASPO ValuePoint administrative fee associated with these contracts. It is anticipated that the individual states will be able to add an administrative fee when the state executes its Participating Addendum.

II. TERM OF THE CONTRACT

The initial term of the contract will be established for **five years** from the date of award with options to extend the contract.

III. SOLICITATION AND CONTRACT DEVELOPMENT/ADDITIONAL INFORMATION

The solicitation and contract development shall be accomplished in compliance with the NASPO ValuePoint Process Guide and the NASPO Memorandum of Agreement for the NASPO cooperative purchasing program, incorporated herein by reference.

Solicitation Publication Period

Bidders/Offerors will be given at least 40 days after publication to submit proposals.

Solicitation Type and Evaluation Criteria

This RFP will be issued and evaluated in concert with the procurement laws and rules of the State of **Utah** by a sourcing team comprised of members from several states.

Award(s):

The solicitation will permit multiple awards.

Additional Requested Information

State Specific Terms and Conditions: If the participating state wishes to include any State specific terms and conditions with the release of this RFP, please attach those with this Intent to Participate.

Annual Estimated Volume: If your State has an existing contract for this commodity or service, please indicate your annual volume of spend (including any potential political subdivision usage if available).

Annual State Spend \$150,000.00

Annual Political Subdivision Spend N/A

Total Spend \$150,000.00

State of New Mexico

Mark Hayden

Director Name

(505) 469-7653

Director Phone

Mark.Hayden@state.nm.us

Director Email

Director has approved submitting the ITP? Yes No
(Click appropriate box)

State Specific T&Cs to be included in RFP? Yes No
(Click appropriate box)

Natalie Martinez, Bureau Chief

State Point of Contact Name and Title

(505) 690-5977

Phone

Natalie.Martinez1@state.nm.us

Email

Please email completed "Intent to Participate" document by March 11, 2021 to:

Tara Larwick

Cooperative Contract Coordinator

NASPO ValuePoint

tlarwick@naspovaluepoint.org

State of New Mexico additional Terms & Conditions**1. Taxes:**

The Contractor shall be reimbursed by the Procuring Agency for applicable New Mexico gross receipts taxes, excluding interest or penalties assessed on the Contractor by any authority. **PLEASE NOTE NO PROPERTY TAX WILL BE PAID TO THE CONTRACTOR BY THE STATE.** The payment of taxes for any money received under this Agreement shall be the Contractor's sole responsibility and should be reported under the Contractor's Federal and State tax identification number(s).

Contractor and any and all subcontractors shall pay all Federal, state and local taxes applicable to its operation and any persons employed by the Contractor. Contractor shall require all subcontractors to hold the Procuring Agency harmless from any responsibility for taxes, damages and interest, if applicable, contributions required under Federal and/or state and local laws and regulations and any other costs, including transaction privilege taxes, unemployment compensation insurance, Social Security and Worker's Compensation.

D. Retainage.

Reserved

E. Performance Bond.

Reserved

2. Term:

THIS AGREEMENT SHALL NOT BECOME EFFECTIVE UNTIL APPROVED IN WRITING BY THE STATE PURCHASING AGENT. This Agreement shall begin on date approved by the State Purchasing Agent, if the State Purchasing Agent has signed this Agreement, and end on **DATE**. The agency reserves the right to renew the contract on an annual basis by mutual Agreement not exceed a total of 8 years in accordance with NMSA 1978 §13-1-150.

3. Termination:

A. Grounds. The Procuring Agency may terminate this Agreement for convenience or cause. The Contractor may only terminate this Agreement based upon the Procuring Agency's uncured, material breach of this Agreement.

B. Notice; Procuring Agency Opportunity to Cure.

1. Except as otherwise provided in sub-paragraph A of this Clause and the Appropriations Clause of this Agreement, the Procuring Agency shall give Contractor written notice of termination at least thirty (30) days prior to the intended date of termination.

2. Contractor shall give Procuring Agency written notice of termination at least thirty (30) days prior to the intended date of termination, which notice shall (i) identify all the Procuring Agency's material breaches of this Agreement upon which the termination is based and (ii) state what the Procuring Agency must do to cure such material breaches. Contractor's notice of termination shall only be effective (i) if the Procuring Agency does not cure all material breaches within the thirty (30) day notice period or (ii) in the case of material breaches that cannot be cured within thirty (30) days, the Procuring Agency does not, within the thirty (30) day notice period, notify the Contractor of its intent to cure and begin with due diligence to cure the material breach.

3. Notwithstanding the foregoing, this Agreement may be terminated immediately upon written notice to the Contractor (i) if the Contractor becomes unable to perform the services contracted for, as determined by the Procuring Agency; (ii) if, during the term of this Agreement, the Contractor is suspended or debarred by the State Purchasing Agent; or (iii) the Agreement is terminated pursuant to the Appropriations Clause of this Agreement.

C. **Liability.** Except as otherwise expressly allowed or provided under this Agreement, the Procuring Agency's sole liability upon termination shall be to pay for acceptable work performed prior to the Contractor's receipt or issuance of a notice of termination; provided, however, that a notice of termination shall not nullify or otherwise affect either party's liability for pre-termination defaults under or breaches of this Agreement. The Contractor shall submit an invoice for such work within thirty (30) days of receiving or sending the notice of termination. *THIS PROVISION IS NOT EXCLUSIVE AND DOES NOT WAIVE THE PROCURING AGENCY'S OTHER LEGAL RIGHTS AND REMEDIES CAUSED BY THE CONTRACTOR'S DEFAULT/BREACH OF THIS AGREEMENT.*

4. Appropriations:

The terms of this Agreement are contingent upon sufficient appropriations and authorization being made by the Legislature of New Mexico for the performance of this Agreement. If sufficient appropriations and authorization are not made by the Legislature, this Agreement shall terminate immediately upon written notice being given by the Procuring Agency to the Contractor. The Procuring Agency's decision as to whether sufficient appropriations are available shall be accepted by the Contractor and shall be final. If the Procuring Agency proposes an amendment to the Agreement to unilaterally reduce funding, the Contractor shall have the option to terminate the Agreement or to agree to the reduced funding, within thirty (30) days of receipt of the proposed amendment.

5. Status of Contractor:

The Contractor and its agents and employees are independent contractors performing professional or general services for the Procuring Agency and are not employees of the State of New Mexico. The Contractor and its agents and employees shall not accrue leave, retirement, insurance, bonding, use of state vehicles, or any other benefits afforded to employees of the State of New Mexico as a result of this Agreement. The Contractor acknowledges that all sums received hereunder are reportable by the Contractor for tax purposes, including without limitation, self-employment and business income tax. The Contractor agrees not to purport to bind the State of New Mexico unless the Contractor has express written authority to do so, and then only within the strict limits of that authority.

6. Conflict of Interest; Governmental Conduct Act:

A. The Contractor represents and warrants that it presently has no interest and, during the term of this Agreement, shall not acquire any interest, direct or indirect, which would conflict in any manner or degree with the performance or services required under the Agreement.

B. The Contractor further represents and warrants that it has complied with, and, during the term of this Agreement, will continue to comply with, and that this Agreement complies with all applicable provisions of the Governmental Conduct Act, Chapter 10, Article 16 NMSA 1978. Without in any way limiting the generality of the foregoing, the Contractor specifically represents and warrants that:

- 1) in accordance with NMSA 1978, § 10-16-4.3, the Contractor does not employ, has not employed, and will not employ during the term of this Agreement any Procuring Agency employee while such employee was or is employed by the Procuring Agency and participating directly or indirectly in the Procuring Agency's contracting process;
- 2) this Agreement complies with NMSA 1978, § 10-16-7(A) because (i) the Contractor is not a public officer or employee of the State; (ii) the Contractor is not a member of the family of a public officer or employee of the State; (iii) the Contractor is not a business in which a public officer or employee or the family of a public officer or employee has a substantial interest; or (iv) if the Contractor is a public officer or employee of the State, a member of the family of a public officer or employee of the State, or a business in which a public officer or employee of the State or the family of a public officer or employee of the State has a substantial interest, public notice was given as required by NMSA 1978, § 10-16-7(A) and this Agreement was awarded pursuant to a competitive process;

3) in accordance with NMSA 1978, § 10-16-8(A), (i) the Contractor is not, and has not been represented by, a person who has been a public officer or employee of the State within the preceding year and whose official act directly resulted in this Agreement and (ii) the Contractor is not, and has not been assisted in any way regarding this transaction by, a former public officer or employee of the State whose official act, while in State employment, directly resulted in the Procuring Agency's making this Agreement;

4) this Agreement complies with NMSA 1978, § 10-16-9(A) because (i) the Contractor is not a legislator; (ii) the Contractor is not a member of a legislator's family; (iii) the Contractor is not a business in which a legislator or a legislator's family has a substantial interest; or (iv) if the Contractor is a legislator, a member of a legislator's family, or a business in which a legislator or a legislator's family has a substantial interest, disclosure has been made as required by NMSA 1978, § 10-16-7(A), this Agreement is not a sole source or small purchase contract, and this Agreement was awarded in accordance with the provisions of the Procurement Code;

5) in accordance with NMSA 1978, § 10-16-13, the Contractor has not directly participated in the preparation of specifications, qualifications or evaluation criteria for this Agreement or any procurement related to this Agreement; and

6) in accordance with NMSA 1978, § 10-16-3 and § 10-16-13.3, the Contractor has not contributed, and during the term of this Agreement shall not contribute, anything of value to a public officer or employee of the Procuring Agency.

C. Contractor's representations and warranties in paragraphs A and B of this Clause are material representations of fact upon which the Procuring Agency relied when this Agreement was entered into by the parties. Contractor shall provide immediate written notice to the Procuring Agency if, at any time during the term of this Agreement, Contractor learns that Contractor's representations and warranties in paragraphs A and B of this Clause were erroneous on the effective date of this Agreement or have become erroneous by reason of new or changed circumstances. If it is later determined that Contractor's representations and warranties in paragraphs A and B of this Clause were erroneous on the effective date of this Agreement or have become erroneous by reason of new or changed circumstances, in addition to other remedies available to the Procuring Agency and notwithstanding anything in the Agreement to the contrary, the Procuring Agency may immediately terminate the Agreement.

D. All terms defined in the Governmental Conduct Act have the same meaning in this Agreement.

7.

Amendment:

A. This Agreement shall not be altered, changed or amended except by instrument in writing executed by the parties hereto and all other required signatories.

B. If the Procuring Agency proposes an amendment to the Agreement to unilaterally reduce funding due to budget or other considerations, the Contractor shall, within thirty (30) days of receipt of the proposed Amendment, have the option to terminate the Agreement, pursuant to the termination provisions as set forth in the Terminations Clause of this Agreement, or to agree to the reduced funding.

8. Merger:

This Agreement incorporates all the Agreements, covenants and understandings between the parties hereto concerning the subject matter hereof, and all such covenants, Agreements and understandings have been merged into this written Agreement. No prior Agreement or understanding, oral or otherwise, of the parties or their agents shall be valid or enforceable unless embodied in this Agreement.

9. Penalties for violation of law:

The Procurement Code, NMSA 1978 §§ 13-1-28 through 13-1-199, imposes civil and criminal penalties for violation of the statute. In addition, the New Mexico criminal statutes impose felony penalties for illegal acts, including bribes, gratuities and kickbacks.

10. Equal Opportunity Compliance:

The Contractor agrees to abide by all federal and state laws and rules and regulations, and executive orders of the Governor of the State of New Mexico, pertaining to equal employment opportunity. In accordance with all such laws of the State of New Mexico, the Contractor assures that no person in the United States shall, on the grounds of race, religion, color, national origin, ancestry, sex, age, physical or mental handicap, or serious medical condition, spousal affiliation, sexual orientation or gender identity, be excluded from employment with or participation in, be denied the benefits of, or be otherwise subjected to discrimination under any program or activity performed under this Agreement. If Contractor is found not to be in compliance with these requirements during the life of this Agreement, Contractor agrees to take appropriate steps to correct these deficiencies.

11. Workers Compensation:

The Contractor agrees to comply with state laws and rules applicable to workers compensation benefits for its employees. If the Contractor fails to comply with the Workers Compensation Act and applicable rules when required to do so, this Agreement may be terminated by the Procuring Agency.

12. Applicable Law:

The laws of the State of New Mexico shall govern this Agreement, without giving effect to its choice of law provisions. Venue shall be proper only in a New Mexico court of competent jurisdiction in accordance with NMSA 1978, § 38-3-1 (G). By execution of this Agreement, Contractor acknowledges and agrees to the jurisdiction of the courts of the State of New Mexico over any and all lawsuits arising under or out of any term of this Agreement.

13. Records and Financial Audit:

The Contractor shall maintain detailed time and expenditure records that indicate the date, time, nature and cost of services rendered during the Agreement's term and effect and retain them for a period of three (3) years from the date of final payment under this Agreement. The records shall be subject to inspection by the Procuring Agency, the Department of Finance and Administration and the State Auditor. The Procuring Agency shall have the right to audit billings both before and after payment. Payment under this Agreement shall not foreclose the right of the Procuring Agency to recover excessive or illegal payments.

14. Invalid Term or Condition:

If any term or condition of this Agreement shall be held invalid or unenforceable, the remainder of this Agreement shall not be affected and shall be valid and enforceable.

15. Enforcement of Agreement:

A party's failure to require strict performance of any provision of this Agreement shall not waive or diminish that party's right thereafter to demand strict compliance with that or any other provision. No waiver by a party of any of its rights under this Agreement shall be effective unless express and in writing, and no effective waiver by a party of any of its rights shall be effective to waive any other rights.

16. Non-Collusion:

In signing this Agreement, the Contractor certifies the Contractor has not, either directly or indirectly, entered into action in restraint of free competitive bidding in connection with this offer submitted to the State Purchasing Agent or agency or entity.

17. Notices:

Any notice required to be given to either party by this Agreement shall be in writing and shall be delivered in person, by courier service or by U.S. mail, either first class or certified, return receipt requested, postage prepaid, as follows:

To the Procuring Agency:

Mark Hayden, State Purchasing Agent
State Purchasing Division
1100 St. Francis Dr., Room 2016
Santa Fe, NM 87505

To the Contractor:

XXXXXXXXXXXXXXXXXXXXXXXXXXXX

18. Succession:

This Agreement shall extend to and be binding upon the successors and assigns of the parties.

19. Headings:

Any and all headings herein are inserted only for convenience and ease of reference and are not to be considered in the construction or interpretation of any provision of this Agreement. Numbered or lettered provisions, sections and subsections contained herein, refer only to provisions, sections and subsections of this Agreement unless otherwise expressly stated.

20. Default/Breach:

In case of Default and/or Breach by the Contractor, for any reason whatsoever, the Procuring Agency and the State of New Mexico may procure the goods or Services from another source and hold the Contractor responsible for any resulting excess costs and/or damages, including but not limited to, direct damages, indirect damages, consequential damages, special damages and the Procuring Agency and the State of New Mexico may also seek all other remedies under the terms of this Agreement and under law or equity.

21. Equitable Remedies:

Contractor acknowledges that its failure to comply with any provision of this Agreement will cause the Procuring Agency irrevocable harm and that a remedy at law for such a failure would be an inadequate remedy for the Procuring Agency, and the Contractor consents to the Procuring Agency's obtaining from a court of competent jurisdiction, specific performance, or injunction, or any other equitable relief in order to enforce such compliance. Procuring Agency's rights to obtain equitable relief pursuant to this Agreement shall be in addition to, and not in lieu of, any other remedy that Procuring Agency may have under applicable law, including, but not limited to, monetary damages.

22. New Mexico Employees Health Coverage:

A. If Contractor has, or grows to, six (6) or more employees who work, or who are expected to work, an average of at least 20 hours per week over a six (6) month period during the term of this Agreement, Contractor certifies, by signing this agreement, to have in place, and agree to maintain for the term of the Agreement, health insurance for those employees and offer that health insurance to those employees if the expected annual value in the aggregate of any and all contracts between Contractor and the State exceed \$250,000 dollars.

B. Contractor agrees to maintain a record of the number of employees who have (a) accepted health insurance; (b) declined health insurance due to other health insurance coverage already in place; or (c) declined health insurance for other reasons. These records are subject to review and audit by a representative of the state.

C. Contractor agrees to advise all employees of the availability of State publicly financed health care coverage programs by providing each employee with, as a minimum, the following web site link to additional information:
<http://bewellnm.com>.

23. Indemnification:

The Contractor shall defend, indemnify and hold harmless the Procuring Agency and the State of New Mexico from all actions, proceeding, claims, demands, costs, damages, attorneys' fees and all other liabilities and expenses of any kind from any source which may arise out of the performance of this Agreement, caused by the negligent act or failure to act of the Contractor, its officers, employees, servants, subcontractors or agents, resulting in injury or damage to persons or property during the time when the Contractor or any officer, agent, employee, servant or subcontractor thereof has or is performing services pursuant to this Agreement. In the event that any action, suit or proceeding related to the services performed by the Contractor or any officer, agent, employee, servant or subcontractor under this Agreement is brought against the Contractor, the Contractor shall, as soon as practicable but no later than two (2) days after it receives notice thereof, notify the legal counsel of the Procuring Agency and the Risk Management Division of the New Mexico General Services Department by certified mail.

24. Default and Force Majeure:

The State reserves the right to cancel all or any part of any orders placed under this Agreement without cost to the State, if the Contractor fails to meet the provisions of this Agreement and, except as otherwise provided herein, to hold the Contractor liable for any excess cost occasioned by the State due to the Contractor's default. The Contractor shall not be liable for any excess costs if failure to perform the order arises out of causes beyond the control and without the fault or negligence of the Contractor; such causes include, but are not restricted to, acts of God or the public enemy, acts of the State or Federal Government, fires, floods, epidemics, quarantine restrictions, strikes, freight embargoes, unusually severe weather and defaults of subcontractors due to any of the above, unless the State shall determine that the supplies or services to be furnished by the subcontractor were obtainable from other sources in sufficient time to permit the Contractor to meet the required delivery scheduled. The rights and remedies of the State provided in this Clause shall not be exclusive and are in addition to any other rights now being provided by law or under this Agreement.

25. Assignment:

The Contractor shall not assign or transfer any interest in this Agreement or assign any claims for money due or to become due under this Agreement without the prior written approval of the Procuring Agency.

26. Subcontracting:

The Contractor shall not subcontract any portion of the services to be performed under this Agreement without the prior written approval of the Procuring Agency. No such subcontract shall relieve the primary Contractor from its obligations and liabilities under this Agreement, nor shall any subcontract obligate direct payment from the Procuring Agency.

27. Inspection of Plant:

The State Purchasing Agent or agency or entity that is a party to this Agreement may inspect, at any reasonable time during Contractor's regular business hours and upon prior written notice, the Contractor's plant or place of business, or any subcontractor's plant or place of business, which is related to the performance of this Agreement.

28. Commercial Warranty:

The Contractor agrees that the tangible personal property or services furnished under this Agreement shall be covered by the most favorable commercial warranties the Contractor gives to any customer for such tangible personal property or services, and that the rights and remedies provided herein shall extend to the State and are in addition to and do not limit any rights afforded to the State by any other Clause of this Agreement or order. Contractor agrees not to disclaim warranties of fitness for a particular purpose or merchantability.

29. Condition of Proposed Items:

Where tangible personal property is a part of this Agreement, all proposed items are to be NEW and of most current production, unless otherwise specified.

30. Release:

Final payment of the amounts due under this Agreement shall operate as a release of the Procuring Agency, its officers and employees, and the State of New Mexico from all liabilities, claims and obligations whatsoever arising from or under this Agreement.

31. Confidentiality:

Any Confidential Information provided to the Contractor by the Procuring Agency or, developed by the Contractor based on information provided by the Procuring Agency in the performance of this Agreement shall be kept confidential and shall not be made available to any individual or organization by the Contractor without the prior written approval of the Procuring Agency. Upon termination of this Agreement, Contractor shall deliver all Confidential Information in its possession to the Procuring Agency within thirty (30) Business Days of such termination. Contractor acknowledges that failure to deliver such Confidential Information to the Procuring Agency will result in direct, special and incidental damages.

32. Contractor Personnel:

A. **Key Personnel.** Contractor's key personnel shall not be diverted from this Agreement without the prior written approval of the Procuring Agency. Key personnel are those individuals considered by the Procuring Agency to be mandatory to the work to be performed under this Agreement. Key personnel shall be:

[Insert Contractor Staff Name(s)]

B. **Personnel Changes.** Replacement of any personnel shall be made with personnel of equal ability, experience, and qualification and shall be approved by the Procuring Agency. For all personnel, the Procuring Agency reserves the right to require submission of their resumes prior to approval. If the number of Contractor's personnel assigned to the Project is reduced for any reason, Contractor shall, within ten (10) Business Days of the reduction, replace with the same or greater number of personnel with equal ability, experience, and qualifications, subject to Procuring Agency approval. The Procuring Agency, in its sole discretion, may approve additional time beyond the ten (10) Business Days for replacement of personnel. The Contractor shall include status reports of its efforts and progress in finding replacements and the effect of the absence of the personnel on the progress of the Project. The Contractor shall also make interim arrangements to assure that the Project progress is not affected by the loss of personnel. The Procuring Agency reserves the right to require a change in Contractor's personnel if the assigned personnel are not, in the sole opinion of the Procuring Agency, meeting the Procuring Agency's expectations.

33. Incorporation by Reference and Precedence:

If this Agreement has been procured pursuant to a request for proposals, this Agreement is derived from (1) the request for proposal, (including any written clarifications to the request for proposals and any agency response to questions); (2) the Contractor's best and final offer; and (3) the Contractor's response to the request for proposals.

In the event of a dispute under this Agreement, applicable documents will be referred to for the purpose of clarification or for additional detail in the following order of precedence: (1) amendments to the Agreement in reverse chronological order; (2) the Agreement, including the scope of work and all terms and conditions thereof; (3) the request for proposals, including attachments thereto and written responses to questions and written clarifications; (4) the Contractor's best and final offer if such has been made and accepted by the SPA or Procuring Agency or entity; and (5) the Contractor's response to the request for proposals.

34. Inspection:

If this Agreement is for the purchase of tangible personal property (goods), final inspection and acceptance shall be made at Destination. Tangible personal property rejected at Destination for non-conformance to specifications shall be removed at Contractor's risk and expense promptly after notice of rejection and shall not be allowable as billable items for payment.

35. Inspection of Services:

If this Agreement is for the purchase of services, the following terms shall apply.

A. Services, as used in this Clause, include services performed, workmanship, and material furnished or utilized in the performance of services.

B. The Contractor shall provide and maintain an inspection system acceptable to the State Purchasing Agent or other party to this Agreement covering the services under this Agreement. Complete records of all inspection work performed by the Contractor shall be maintained and made available to the State Purchasing Agent or other party to this Agreement during the term of performance of this Agreement and for as long thereafter as the Agreement requires.

C. The State Purchasing Agent or other party to this Agreement has the right to inspect and test all services contemplated under this Agreement to the extent practicable at all times and places during the term of the Agreement. The State Purchasing Agent or other party to this Agreement shall perform inspections and tests in a manner that will not unduly delay or interfere with Contractor's performance.

D. If the State Purchasing Agent or other party to this Agreement performs inspections or tests on the premises of the Contractor or a subcontractor, the Contractor shall furnish, and shall require subcontractors to furnish, at no increase in Agreement price, all reasonable facilities and assistance for the safe and convenient performance of such inspections or tests.

E. If any part of the services do not conform with the requirements of this Agreement, the State Purchasing Agent or other party to this Agreement may require the Contractor to re-perform the services in conformity with the requirements of this Agreement at no increase in Agreement amount. When the defects in services cannot be corrected by re-performance, the State Purchasing Agent or other party to this Agreement may:

(1) require the Contractor to take necessary action(s) to ensure that future performance conforms to the requirements of this Agreement; and

(2) reduce the Agreement price to reflect the reduced value of the services performed.

F. If the Contractor fails to promptly re-perform the services or to take the necessary action(s) to ensure future performance in conformity with the requirements of this Agreement, the State Purchasing Agent or other party to this Agreement may:

(1) by Agreement or otherwise, perform the services and charge to the Contractor any cost incurred by the State Purchasing Agent or other party to this Agreement that is directly related to the performance of such service; or

(2) terminate the Agreement for default.

THE PROVISIONS OF THIS CLAUSE ARE NOT EXCLUSIVE AND DO NOT WAIVE THE STATE PARTIES' TO THIS AGREEMENT OTHER LEGAL RIGHTS AND REMEDIES CAUSED BY THE CONTRACTOR'S DEFAULT/BREACH OF THIS AGREEMENT.

36. Insurance:

If the services contemplated under this Agreement will be performed on or in State facilities or property, Contractor shall maintain in force during the entire term of this Agreement, the following insurance coverage(s), naming the State of New Mexico, General Services Department or other party to this Agreement as additional insured.

A. Workers Compensation (including accident and disease coverage) at the statutory limit.

Employers liability: \$100,000.

B. Comprehensive general liability (including endorsements providing broad form property damage, personal injury coverage and contractual assumption of liability for all liability the Contractor has assumed under this Agreement). Limits shall not be less than the following:

a. Bodily injury: \$1,000,000 per person /\$1,000,000 per occurrence.

- b. Property damage or combined single limit coverage: \$1,000,000.
 - c. Automobile liability (including non-owned automobile coverage): \$1,000,000.
 - d. Umbrella: \$1,000,000.
- C. Contractor shall maintain the above insurance for the term of this Agreement and name the State of New Mexico, General Services Department or other party to this Agreement as an additional insured and provide for 30 days cancellation notice on any Certificate of Insurance form furnished by Contractor. Such certificate shall also specifically state the coverage provided under the policy is primary over any other valid and collectible insurance and provide a waiver of subrogation.

37. Arbitration:

Any controversy or claim arising between the parties shall be settled by arbitration pursuant to NMSA 1978 § 44-7A-1 *et seq.*

38. New Mexico Administration Reporting and Fees:

All contracts and Purchase Orders arising out of this agreement shall be deemed to include an Administrative Fee assessment at the rate of **percent (1.00 %)** for the gross total sales and other revenues (including commissions and fees charged). This assessment shall apply to all New Mexico state agencies and local public bodies. “**Gross total sales**” means any invoiced amount less any applicable state and local taxes.

For reporting purposes: list payments received for the issued invoice during the applicable quarter by state agency, local public body and invoice number. The Quarters are as follows:

<u>Quarter:</u>	<u>Period End:</u>	<u>Report Due:</u>
First	September 30	October 31
Second	December 31	January 31
Third	March 31	April 30
Fourth	June 30	July 31

Even if contractor experiences zero sales during the quarter, a report is still required. This will also apply if the contract starts partial within a Quarter. Reports and Administrative Fee shall be due no later than thirty (30) days following the end of the quarter. Only submit one payment and one report for each quarter, do not combine payments or reports.

Payment shall be made by check payable to the “*State Purchasing Division.*” This contract number **##-00000-##-#####** must be included on all payments and Quarterly Sales Reports.

Remit Checks to: State Purchasing Division
1100 St. Francis Drive, Room 2016
PO Box 6850
Santa Fe, NM 87505
Attn: Compliance Officer

Sample Reports can be found at:

<http://www.generalservices.state.nm.us/statepurchasing/resourcesandinformation.aspx#Vendors>

Email completed reports to: GSD.QuarterlyUsageR@state.nm.us

For questions regarding the Administrative Fees and Quarterly Sales Reports contact the Compliance Officer at (505) 469-2679 or (505) 795-4512



**NASPO ValuePoint
INTENT TO PARTICPATE
Cooperative Contract(s) for Small Package Delivery Services**

I. PURPOSE:

The purpose of this Agreement is to provide interested NASPO states with the opportunity to participate in multi-state cooperative contract(s) for the **Small Package Delivery Services SCOPE OF THE CONTRACT portfolio**

The State of **Utah** is authorized by agreement of the participants to act as the procurement officer in developing multi-state cooperative contract(s) for **Small Package Delivery Services**

The resulting contracts will be permissive contracts.

Administrative Fee

There will be a 0.25% NASPO ValuePoint administrative fee associated with these contracts. It is anticipated that the individual states will be able to add an administrative fee when the state executes its Participating Addendum.

II. TERM OF THE CONTRACT

The initial term of the contract will be established for **five years** from the date of award with **no** options to extend the contract.

III. SOLICITATION AND CONTRACT DEVELOPMENT/ADDITIONAL INFORMATION

The solicitation and contract development shall be accomplished in compliance with the NASPO ValuePoint Process Guide and the NASPO Memorandum of Agreement for the NASPO cooperative purchasing program, incorporated herein by reference.

Solicitation Publication Period

Bidders/Offerors will be given at least 40 days after publication to submit proposals.

Solicitation Type and Evaluation Criteria

This RFP will be issued and evaluated in concert with the procurement laws and rules of the State of **Utah** by a sourcing team comprised of members from several states.

Award(s):

The solicitation will permit multiple awards.

Additional Requested Information

State Specific Terms and Conditions: If the participating state wishes to include any State specific terms and conditions with the release of this RFP, please attach those with this Intent to Participate.

Annual Estimated Volume: If your State has an existing contract for this commodity or service, please indicate your annual volume of spend (including any potential political subdivision usage if available).

Annual State Spend \$5,374,255.97

Annual Political Subdivision Spend Unavailable

Total Spend \$5,374,255.97

State of Virginia

Pete Stamps

Director Name

804-786-0079

Director Phone

pete.stamps@dgs.virginia.gov

Director Email

Director has approved submitting the ITP? Yes No
(Click appropriate box)

State Specific T&Cs to be included in RFP? Yes No
(Click appropriate box)

Monique Curley

State Point of Contact Name and Title

804-786-5412

Phone

monique.curley@dgs.virginia.gov

Email

Please email completed "Intent to Participate" document by March 11, 2021 to:

Tara Larwick

Cooperative Contract Coordinator

NASPO ValuePoint

tlarwick@naspovaluepoint.org

**REQUIRED GENERAL TERMS AND CONDITIONS
GOODS AND NONPROFESSIONAL SERVICES**

These General Terms and Conditions are required for use in written solicitations issued by state agencies for procurements that are subject to this manual unless changed, deleted or revised by the legal advisor to your agency. You should edit the wording to fit the type of solicitation (IFB or RFP) by either deleting or lining out the inappropriate words in all parentheses. For service contracts clauses, Q, R, and S are normally not applicable and may be omitted. For goods contracts, omit clause T. For goods and services contracts, a written determination must be made in order to omit subparagraph 1.e of clause C (“ANTI-DISCRIMINATION”) see 3.13.c.

A.	<i>VENDORS MANUAL</i>	B-2
B.	APPLICABLE LAWS AND COURTS	B-2
C.	ANTI-DISCRIMINATION	B-2
D.	ETHICS IN PUBLIC CONTRACTING	B-3
E.	IMMIGRATION REFORM AND CONTROL ACT OF 1986	B-3
F.	DEBARMENT STATUS	B-3
G.	ANTITRUST	B-3
H.	MANDATORY USE OF STATE FORM AND TERMS AND CONDITIONS	B-3
I.	CLARIFICATION OF TERMS	B-4
J.	PAYMENT	B-4
K.	PRECEDENCE OF TERMS	B-5
L.	QUALIFICATIONS OF BIDDERS OR OFFERORS	B-5
M.	TESTING AND INSPECTION	B-5
N.	ASSIGNMENT OF CONTRACT	B-5
O.	CHANGES TO THE CONTRACT	B-5
P.	DEFAULT	B-6
Q.	TAXES	B-6
R.	USE OF BRAND NAMES	B-6
S.	TRANSPORTATION AND PACKAGING	B-6
T.	INSURANCE	B-6
U.	ANNOUNCEMENT OF AWARD	B-7
V.	DRUG-FREE WORKPLACE	B-7
W.	NONDISCRIMINATION OF CONTRACTORS	B-8
X.	eVA BUSINESS-TO-GOVERNMENT VENDOR REGISTRATION	B-8
Y.	AVAILABILITY OF FUNDS	B-8
Z.	SET-ASIDES IN ACCORDANCE WITH THE SMALL BUSINESS ENHANCEMENT AWARD PRIORITY	B-8
AA.	BID PRICE CURRENCY	B-9
BB.	AUTHORIZATION TO CONDUCT BUSINESS IN THE COMMONWEALTH	B-9
CC.	CIVILITY IN STATE WORKPLACES	B-9

A. **VENDORS MANUAL:** This solicitation is subject to the provisions of the Commonwealth of Virginia *Vendors Manual* and any changes or revisions thereto, which are hereby incorporated into this contract in their entirety. The process for filing a complaint about this solicitation is in section 7.13 of the *Vendors Manual*. (Note section 7.13 does not apply to protests of awards or formal contractual claims.) The procedure for filing contractual claims is in section 7.19 of the *Vendors Manual*. A copy of the manual is normally available for review at the purchasing office and is accessible on the Internet at www.eva.virginia.gov under “I Sell To Virginia”.

B. **APPLICABLE LAWS AND COURTS:** This solicitation and any resulting contract shall be governed in all respects by the laws of the Commonwealth of Virginia, without regard to its choice of law provisions, and any litigation with respect thereto shall be brought in the circuit courts of the Commonwealth. The agency and the contractor are encouraged to resolve any issues in controversy arising from the award of the contract or any contractual dispute using Alternative Dispute Resolution (ADR) procedures (*Code of Virginia*, § 2.2-4366). ADR procedures are described in Chapter 9 of the *Vendors Manual*. The contractor shall comply with all applicable federal, state and local laws, rules and regulations.

- C. **ANTI-DISCRIMINATION:** By submitting their (bids/proposals), (bidders/offerors) certify to the Commonwealth that they will conform to the provisions of the Federal Civil Rights Act of 1964, as amended, as well as the Virginia Fair Employment Contracting Act of 1975, as amended, where applicable, the Virginians With Disabilities Act, the Americans With Disabilities Act and § 2.2-4311 of the *Virginia Public Procurement Act (VPPA)*. If the award is made to a faith-based organization, the organization shall not discriminate against any recipient of goods, services, or disbursements made pursuant to the contract on the basis of the recipient's religion, religious belief, refusal to participate in a religious practice, or on the basis of race, age, color, gender sexual orientation, gender identity, or national origin and shall be subject to the same rules as other organizations that contract with public bodies to account for the use of the funds provided; however, if the faith-based organization segregates public funds into separate accounts, only the accounts and programs funded with public funds shall be subject to audit by the public body. (*Code of Virginia*, § 2.2-4343.1E).

In every contract over \$10,000 the provisions in 1. and 2. below apply:

1. During the performance of this contract, the contractor agrees as follows:
 - a. The contractor will not discriminate against any employee or applicant for employment because of race, religion, color, sex, sexual orientation, gender identity, national origin, age, disability, or any other basis prohibited by state law relating to discrimination in employment, except where there is a bona fide occupational qualification reasonably necessary to the normal operation of the contractor. The contractor agrees to post in conspicuous places, available to employees and applicants for employment, notices setting forth the provisions of this nondiscrimination clause.
 - b. The contractor, in all solicitations or advertisements for employees placed by or on behalf of the contractor, will state that such contractor is an equal opportunity employer.
 - c. Notices, advertisements and solicitations placed in accordance with federal law, rule or regulation shall be deemed sufficient for the purpose of meeting the requirements of this section.
 - d. If the contractor employs more than five employees, the contractor shall (i) provide annual training on the contractor's sexual harassment policy to all supervisors and employees providing services in the Commonwealth, except such supervisors or employees that are required to complete sexual harassment training provided by the Department of Human Resource Management, and (ii) post the contractor's sexual harassment policy in (a) a conspicuous public place in each building located in the Commonwealth that the contractor owns or leases for business purposes and (b) the contractor's employee handbook.
 - e. The requirements of these provisions 1. and 2. are a material part of the contract. If the Contractor violates one of these provisions, the Commonwealth may terminate the affected part of this contract for breach, or at its option, the whole contract. Violation of one of these provisions may also result in debarment from State contracting regardless of whether the specific contract is terminated.
 - f. In accordance with Executive Order 61 (2017), a prohibition on discrimination by the contractor, in its employment practices, subcontracting practices, and delivery of goods or services, on the basis of race, sex, color, national origin, religion, sexual orientation, gender identity, age, political affiliation, disability, or veteran status, is hereby incorporated in this contract.
 2. The contractor will include the provisions of 1. above in every subcontract or purchase order over \$10,000, so that the provisions will be binding upon each subcontractor or vendor.
- D. **ETHICS IN PUBLIC CONTRACTING:** By submitting their (bids/proposals), (bidders/offerors) certify that their (bids/proposals) are made without collusion or fraud and that they have not offered or received any kickbacks or inducements from any other (bidder/offeror), supplier, manufacturer or subcontractor in connection with their (bid/proposal), and that they have not conferred on any public employee having official responsibility for this procurement transaction any payment, loan, subscription, advance, deposit of money, services or

anything of more than nominal value, present or promised, unless consideration of substantially equal or greater value was exchanged.

- E. **IMMIGRATION REFORM AND CONTROL ACT OF 1986:** Applicable for all contracts over \$10,000: By entering into a written contract with the Commonwealth of Virginia, the Contractor certifies that the Contractor does not, and shall not during the performance of the contract for goods and services in the Commonwealth, knowingly employ an unauthorized alien as defined in the federal Immigration Reform and Control Act of 1986.
- F. **DEBARMENT STATUS:** By participating in this procurement, the vendor certifies that they are not currently debarred by the Commonwealth of Virginia from submitting a response for the type of goods and/or services covered by this solicitation. Vendor further certifies that they are not debarred from filling any order or accepting any resulting order, or that they are an agent of any person or entity that is currently debarred by the Commonwealth of Virginia.

If a vendor is created or used for the purpose of circumventing a debarment decision against another vendor, the non-debarred vendor will be debarred for the same time period as the debarred vendor.

- G. **ANTITRUST:** By entering into a contract, the contractor conveys, sells, assigns, and transfers to the Commonwealth of Virginia all rights, title and interest in and to all causes of action it may now have or hereafter acquire under the antitrust laws of the United States and the Commonwealth of Virginia, relating to the particular goods or services purchased or acquired by the Commonwealth of Virginia under said contract.
- H. **MANDATORY USE OF STATE FORM AND TERMS AND CONDITIONS FOR IFBs AND RFPs**
(Insert wording below appropriate to the solicitation type as indicated):

1. **(For Invitation For Bids):** Failure to submit a bid on the official state form provided for that purpose shall be a cause for rejection of the bid. Modification of or additions to any portion of the Invitation for Bids may be cause for rejection of the bid; however, the Commonwealth reserves the right to decide, on a case by case basis, in its sole discretion, whether to reject such a bid as nonresponsive. As a precondition to its acceptance, the Commonwealth may, in its sole discretion, request that the bidder withdraw or modify nonresponsive portions of a bid which do not affect quality, quantity, price, or delivery. No modification of or addition to the provisions of the contract shall be effective unless reduced to writing and signed by the parties.
2. **(For Request For Proposals):** Failure to submit a proposal on the official state form provided for that purpose may be a cause for rejection of the proposal. Modification of or additions to the General Terms and Conditions of the solicitation may be cause for rejection of the proposal; however, the Commonwealth reserves the right to decide, on a case by case basis, in its sole discretion, whether to reject such a proposal.

- I. **CLARIFICATION OF TERMS:** If any prospective (bidder/offeror) has questions about the specifications or other solicitation documents, the prospective (bidder/offeror) should contact the buyer whose name appears on the face of the solicitation no later than five working days before the due date. Any revisions to the solicitation will be made only by addendum issued by the buyer.

J. **PAYMENT:**

1. **To Prime Contractor:**
 - a. Invoices for items ordered, delivered and accepted shall be submitted by the contractor directly to the payment address shown on the purchase order/contract. All invoices shall show the state contract number and/or purchase order number; social security number (for individual contractors) or the federal employer identification number (for proprietorships, partnerships, and corporations).

- b. Any payment terms requiring payment in less than 30 days will be regarded as requiring payment 30 days after invoice or delivery, whichever occurs last. This shall not affect offers of discounts for payment in less than 30 days, however.
- c. All goods or services provided under this contract or purchase order, that are to be paid for with public funds, shall be billed by the contractor at the contract price, regardless of which public agency is being billed.
- d. The following shall be deemed to be the date of payment: the date of postmark in all cases where payment is made by mail, or when offset proceedings have been instituted as authorized under the Virginia Debt Collection Act.
- e. **Unreasonable Charges.** Under certain emergency procurements and for most time and material purchases, final job costs cannot be accurately determined at the time orders are placed. In such cases, contractors should be put on notice that final payment in full is contingent on a determination of reasonableness with respect to all invoiced charges. Charges which appear to be unreasonable will be resolved in accordance with *Code of Virginia*, § 2.2-4363 and -4364. Upon determining that invoiced charges are not reasonable, the Commonwealth shall notify the contractor of defects or improprieties in invoices within fifteen (15) days as required in *Code of Virginia*, § 2.2-4351. The provisions of this section do not relieve an agency of its prompt payment obligations with respect to those charges which are not in dispute (*Code of Virginia*, § 2.2-4363).

2. To Subcontractors:

- a. Within seven (7) days of the contractor's receipt of payment from the Commonwealth, a contractor awarded a contract under this solicitation is hereby obligated:
 - (1) To pay the subcontractor(s) for the proportionate share of the payment received for work performed by the subcontractor(s) under the contract; or
 - (2) To notify the agency and the subcontractor(s), in writing, of the contractor's intention to withhold payment and the reason.
- b. The contractor is obligated to pay the subcontractor(s) interest at the rate of one percent per month (unless otherwise provided under the terms of the contract) on all amounts owed by the contractor that remain unpaid seven (7) days following receipt of payment from the Commonwealth, except for amounts withheld as stated in (2) above. The date of mailing of any payment by U. S. Mail is deemed to be payment to the addressee. These provisions apply to each sub-tier contractor performing under the primary contract. A contractor's obligation to pay an interest charge to a subcontractor may not be construed to be an obligation of the Commonwealth.

3. Each prime contractor who wins an award in which provision of a SWaM procurement plan is a condition to the award, shall deliver to the contracting agency or institution, on or before request for final payment, evidence and certification of compliance (subject only to insubstantial shortfalls and to shortfalls arising from subcontractor default) with the SWaM procurement plan. Final payment under the contract in question may be withheld until such certification is delivered and, if necessary, confirmed by the agency or institution, or other appropriate penalties may be assessed in lieu of withholding such payment.

4. The Commonwealth of Virginia encourages contractors and subcontractors to accept electronic and credit card payments.

K. **PRECEDENCE OF TERMS:** The following General Terms and Conditions *VENDORS MANUAL*, *APPLICABLE LAWS AND COURTS*, *ANTI-DISCRIMINATION*, *ETHICS IN PUBLIC CONTRACTING*, *IMMIGRATION REFORM AND CONTROL ACT OF 1986*, *DEBARMENT STATUS*, *ANTITRUST*, *MANDATORY USE OF STATE FORM AND TERMS AND CONDITIONS*, *CLARIFICATION OF TERMS*, *PAYMENT* shall apply in all instances. In the event there is a conflict between any of the other General Terms

and Conditions and any Special Terms and Conditions in this solicitation, the Special Terms and Conditions shall apply.

- L. **QUALIFICATIONS OF (BIDDERS/OFFERORS)**: The Commonwealth may make such reasonable investigations as deemed proper and necessary to determine the ability of the (bidder/offeror) to perform the services/furnish the goods and the (bidder/offeror) shall furnish to the Commonwealth all such information and data for this purpose as may be requested. The Commonwealth reserves the right to inspect (bidder's/offeror's) physical facilities prior to award to satisfy questions regarding the (bidder's/offeror's) capabilities. The Commonwealth further reserves the right to reject any (bid/proposal) if the evidence submitted by, or investigations of, such (bidder/offeror) fails to satisfy the Commonwealth that such (bidder/offeror) is properly qualified to carry out the obligations of the contract and to provide the services and/or furnish the goods contemplated therein.
- M. **TESTING AND INSPECTION**: The Commonwealth reserves the right to conduct any test/inspection it may deem advisable to assure goods and services conform to the specifications.
- N. **ASSIGNMENT OF CONTRACT**: A contract shall not be assignable by the contractor in whole or in part without the written consent of the Commonwealth.
- O. **CHANGES TO THE CONTRACT**: Changes can be made to the contract in any of the following ways:
1. The parties may agree in writing to modify the terms, conditions, or scope of the contract. Any additional goods or services to be provided shall be of a sort that is ancillary to the contract goods or services, or within the same broad product or service categories as were included in the contract award. Any increase or decrease in the price of the contract resulting from such modification shall be agreed to by the parties as a part of their written agreement to modify the scope of the contract.
 2. The Purchasing Agency may order changes within the general scope of the contract at any time by written notice to the contractor. Changes within the scope of the contract include, but are not limited to, things such as services to be performed, the method of packing or shipment, and the place of delivery or installation. The contractor shall comply with the notice upon receipt, unless the contractor intends to claim an adjustment to compensation, schedule, or other contractual impact that would be caused by complying with such notice, in which case the contractor shall, in writing, promptly notify the Purchasing Agency of the adjustment to be sought, and before proceeding to comply with the notice, shall await the Purchasing Agency's written decision affirming, modifying, or revoking the prior written notice. If the Purchasing Agency decides to issue a notice that requires an adjustment to compensation, the contractor shall be compensated for any additional costs incurred as the result of such order and shall give the Purchasing Agency a credit for any savings. Said compensation shall be determined by one of the following methods:
 - a. By mutual agreement between the parties in writing; or
 - b. By agreeing upon a unit price or using a unit price set forth in the contract, if the work to be done can be expressed in units, and the contractor accounts for the number of units of work performed, subject to the Purchasing Agency's right to audit the contractor's records and/or to determine the correct number of units independently; or
 - c. By ordering the contractor to proceed with the work and keep a record of all costs incurred and savings realized. A markup for overhead and profit may be allowed if provided by the contract. The same markup shall be used for determining a decrease in price as the result of savings realized. The contractor shall present the Purchasing Agency with all vouchers and records of expenses incurred and savings realized. The Purchasing Agency shall have the right to audit the records of the contractor as it deems necessary to determine costs or savings. Any claim for an adjustment in price under this provision must be asserted by written notice to the Purchasing Agency within thirty (30) days from the date of receipt of the written order from the Purchasing Agency. If the parties fail to agree on an amount of adjustment, the question of an increase or decrease in the contract price or time for performance shall be resolved in accordance with the procedures for resolving disputes provided by

the Disputes Clause of this contract or, if there is none, in accordance with the disputes provisions of the Commonwealth of Virginia *Vendors Manual*. Neither the existence of a claim nor a dispute resolution process, litigation or any other provision of this contract shall excuse the contractor from promptly complying with the changes ordered by the Purchasing Agency or with the performance of the contract generally.

- P. **DEFAULT:** In case of failure to deliver goods or services in accordance with the contract terms and conditions, the Commonwealth, after due oral or written notice, may procure them from other sources and hold the contractor responsible for any resulting additional purchase and administrative costs. This remedy shall be in addition to any other remedies which the Commonwealth may have.
- Q. **TAXES:** Sales to the Commonwealth of Virginia are normally exempt from State sales tax. State sales and use tax certificates of exemption, Form ST-12, will be issued upon request. Deliveries against this contract shall usually be free of Federal excise and transportation taxes. The Commonwealth's excise tax exemption registration number is 54-73-0076K.

If sales or deliveries against the contract are not exempt, the contractor shall be responsible for the payment of such taxes unless the tax law specifically imposes the tax upon the buying entity and prohibits the contractor from offering a tax-included price.

(NOT NORMALLY REQUIRED FOR SERVICE CONTRACTS)

- R. **USE OF BRAND NAMES:** Unless otherwise provided in this solicitation, the name of a certain brand, make or manufacturer does not restrict (bidders/offerors) to the specific brand, make or manufacturer named, but conveys the general style, type, character, and quality of the article desired. Any article which the public body, in its sole discretion, determines to be the equivalent of that specified, considering quality, workmanship, economy of operation, and suitability for the purpose intended, shall be accepted. The (bidder/offeror) is responsible to clearly and specifically identify the product being offered and to provide sufficient descriptive literature, catalog cuts and technical detail to enable the Commonwealth to determine if the product offered meets the requirements of the solicitation. This is required even if offering the exact brand, make or manufacturer specified. Normally in competitive sealed bidding only the information furnished with the bid will be considered in the evaluation. Failure to furnish adequate data for evaluation purposes may result in declaring a bid nonresponsive. Unless the (bidder/offeror) clearly indicates in its (bid/proposal) that the product offered is an equivalent product, such (bid/proposal) will be considered to offer the brand name product referenced in the solicitation.

(NOT NORMALLY REQUIRED FOR SERVICE CONTRACTS)

- S. **TRANSPORTATION AND PACKAGING:** By submitting their (bids/proposals), all (bidders/offerors) certify and warrant that the price offered for FOB destination includes only the actual freight rate costs at the lowest and best rate and is based upon the actual weight of the goods to be shipped. Except as otherwise specified herein, standard commercial packaging, packing and shipping containers shall be used. All shipping containers shall be legibly marked or labeled on the outside with purchase order number, commodity description, and quantity.

(NOT NORMALLY REQUIRED FOR SERVICE CONTRACTS)

- T. **INSURANCE:** By signing and submitting a bid or proposal under this solicitation, the bidder or offeror certifies that if awarded the contract, it will have the following insurance coverage at the time the contract is awarded. For construction contracts, if any subcontractors are involved, the subcontractor will have workers' compensation insurance in accordance with §§ 2.2-4332 and 65.2-800 et seq. of the *Code of Virginia*. The bidder or offeror further certifies that the contractor and any subcontractors will maintain these insurance coverage during the entire term of the contract and that all insurance coverage will be provided by insurance companies authorized to sell insurance in Virginia by the Virginia State Corporation Commission.

MINIMUM INSURANCE COVERAGES AND LIMITS:

1. Workers' Compensation - Statutory requirements and benefits. Coverage is compulsory for employers of three or more employees, to include the employer. Contractors who fail to notify the Commonwealth of

increases in the number of employees that change their workers' compensation requirements under the Code of Virginia during the course of the contract shall be in noncompliance with the contract.

2. Employer's Liability - \$100,000.
3. Commercial General Liability - \$1,000,000 per occurrence and \$2,000,000 in the aggregate. Commercial General Liability is to include bodily injury and property damage, personal injury and advertising injury, products and completed operations coverage. The Commonwealth of Virginia shall be added as an additional insured to the policy by an endorsement.
4. Automobile Liability - \$1,000,000 combined single limit. (Required only if a motor vehicle not owned by the Commonwealth is to be used in the contract. Contractor must assure that the required coverage is maintained by the Contractor (or third party owner of such motor vehicle.)

<u>Profession/Service</u>	<u>Limits</u>
Accounting	\$1,000,000 per occurrence, \$3,000,000 aggregate
Architecture	\$2,000,000 per occurrence, \$6,000,000 aggregate
Asbestos Design, Inspection or Abatement Contractors	\$1,000,000 per occurrence, \$3,000,000 aggregate
Health Care Practitioner (to include Dentists, Licensed Dental Hygienists, Optometrists, Registered or Licensed Practical Nurses, Pharmacists, Physicians, Podiatrists, Chiropractors, Physical Therapists, Physical Therapist Assistants, Clinical Psychologists, Clinical Social Workers, Professional Counselors, Hospitals, or Health Maintenance Organizations.)	<i>Code of Virginia</i> § 8.01-581.15 https://law.lis.virginia.gov/vacode/title8.01/chapter21.1/section8.01-581.15/
Insurance/Risk Management	\$1,000,000 per occurrence, \$3,000,000 aggregate
Landscape/Architecture	\$1,000,000 per occurrence, \$1,000,000 aggregate
Legal	\$1,000,000 per occurrence, \$5,000,000 aggregate
Professional Engineer	\$2,000,000 per occurrence, \$6,000,000 aggregate
Surveying	\$1,000,000 per occurrence, \$1,000,000 aggregate

*** When Used: FOR CONSTRUCTION, SERVICE CONTRACTS AND GOODS CONTRACTS WHEN INSTALLATION IS REQUIRED - Required in all solicitations where a contractor will perform work or services in or on state facilities. The limits are minimums and may be increased. The Department of Treasury, Division of Risk Management (804-786-3152) should be contacted when other types of coverage may be required or when in doubt as to the need for other limits. When soliciting one of the Professions/Services listed above include the Professional Liability/Errors and Omissions coverage and limits as shown. When not soliciting one of these Professions/Services, omit the required coverages section from the General Terms and Conditions boilerplate.**

- U. **ANNOUNCEMENT OF AWARD:** Upon the award or the announcement of the decision to award a contract as a result of this solicitation, the purchasing agency will publicly post such notice on the DGS/DPS eVA VBO (www.eva.virginia.gov) for a minimum of 10 days.

- V. **DRUG-FREE WORKPLACE:** Applicable for all contracts over \$10,000:

During the performance of this contract, the contractor agrees to (i) provide a drug-free workplace for the contractor's employees; (ii) post in conspicuous places, available to employees and applicants for employment, a statement notifying employees that the unlawful manufacture, sale, distribution, dispensation, possession, or use of a controlled substance or marijuana is prohibited in the contractor's workplace and specifying the actions that will be taken against employees for violations of such prohibition; (iii) state in all solicitations or advertisements for employees placed by or on behalf of the contractor that the contractor maintains a drug-free

workplace; and (iv) include the provisions of the foregoing clauses in every subcontract or purchase order of over \$10,000, so that the provisions will be binding upon each subcontractor or vendor.

For the purposes of this section, “*drug-free workplace*” means a site for the performance of work done in connection with a specific contract awarded to a contractor, the employees of whom are prohibited from engaging in the unlawful manufacture, sale, distribution, dispensation, possession or use of any controlled substance or marijuana during the performance of the contract.

W. **NONDISCRIMINATION OF CONTRACTORS:** A bidder, offeror, or contractor shall not be discriminated against in the solicitation or award of this contract because of race, religion, color, sex, sexual orientation, gender identity, national origin, age, disability, faith-based organizational status, any other basis prohibited by state law relating to discrimination in employment or because the bidder or offeror employs ex-offenders unless the state agency, department or institution has made a written determination that employing ex-offenders on the specific contract is not in its best interest. If the award of this contract is made to a faith-based organization and an individual, who applies for or receives goods, services, or disbursements provided pursuant to this contract objects to the religious character of the faith-based organization from which the individual receives or would receive the goods, services, or disbursements, the public body shall offer the individual, within a reasonable period of time after the date of his objection, access to equivalent goods, services, or disbursements from an alternative provider.

X. **eVA BUSINESS-TO-GOVERNMENT VENDOR REGISTRATION, CONTRACTS, AND ORDERS:**

The eVA Internet electronic procurement solution, web site portal www.eVA.virginia.gov, streamlines and automates government purchasing activities in the Commonwealth. The eVA portal is the gateway for vendors to conduct business with state agencies and public bodies. All vendors desiring to provide goods and/or services to the Commonwealth shall participate in the eVA Internet e-procurement solution by completing the free eVA Vendor Registration. All bidders or offerors must register in eVA and pay the Vendor Transaction Fees specified below; failure to register will result in the bid/proposal being rejected.

Vendor transaction fees are determined by the date the original purchase order is issued and the current fees are as follows:

a. For orders issued July 1, 2014, and after, the Vendor Transaction Fee is:

- (i) DSBSD-certified Small Businesses: 1%, capped at \$500 per order.
- (ii) Businesses that are not DSBSD-certified Small Businesses: 1%, capped at \$1,500 per order.

b. Refer to Special Term and Condition “eVA Orders and Contracts” to identify the number of purchase orders that will be issued as a result of this solicitation/contract with the eVA transaction fee specified above assessed for each order.

For orders issued prior to July 1, 2014, the vendor transaction fees can be found at www.eVA.virginia.gov.

The specified vendor transaction fee will be invoiced, by the Commonwealth of Virginia Department of General Services, typically within 60 days of the order issue date. Any adjustments (increases/decreases) will be handled through purchase order changes.

Y. **AVAILABILITY OF FUNDS:** It is understood and agreed between the parties herein that the agency shall be bound hereunder only to the extent that the legislature has appropriated funds that are legally available or may hereafter become legally available for the purpose of this agreement.

Z. **SET-ASIDES IN ACCORDANCE WITH THE SMALL BUSINESS ENHANCEMENT AWARD**

PRIORITY: This solicitation is set-aside for award priority to DSBSD-certified micro businesses or small businesses when designated as “Micro Business Set-Aside Award Priority” or “Small Business Set-Aside Award Priority” accordingly in the solicitation. DSBSD-certified micro businesses or small businesses also includes DSBSD-certified women-owned and minority-owned businesses when they have received the

DSBSD small business certification. For purposes of award, bidders/offerors shall be deemed micro businesses or small businesses if and only if they are certified as such by DSBSD on the due date for receipt of bids/proposals.

- AA. **BID PRICE CURRENCY:** Unless stated otherwise in the solicitation, bidders/offerors shall state bid/offer prices in US dollars.
- BB. **AUTHORIZATION TO CONDUCT BUSINESS IN THE COMMONWEALTH:** A contractor organized as a stock or nonstock corporation, limited liability company, business trust, or limited partnership or registered as a registered limited liability partnership shall be authorized to transact business in the Commonwealth as a domestic or foreign business entity if so required by Title 13.1 or Title 50 of the *Code of Virginia* or as otherwise required by law. Any business entity described above that enters into a contract with a public body pursuant to the *Virginia Public Procurement Act* shall not allow its existence to lapse or its certificate of authority or registration to transact business in the Commonwealth, if so required under Title 13.1 or Title 50, to be revoked or cancelled at any time during the term of the contract. A public body may void any contract with a business entity if the business entity fails to remain in compliance with the provisions of this section.
- CC. **CIVILITY IN STATE WORKPLACES:** The contractor shall take all reasonable steps to ensure that no individual, while performing work on behalf of the contractor or any subcontractor in connection with this agreement (each, a “Contract Worker”), shall engage in 1) harassment (including sexual harassment), bullying, cyber-bullying, or threatening or violent conduct, or 2) discriminatory behavior on the basis of race, sex, color, national origin, religious belief, sexual orientation, gender identity or expression, age, political affiliation, veteran status, or disability.

The contractor shall provide each Contract Worker with a copy of this Section and will require Contract Workers to participate in agency training on civility in the State workplace if contractor’s (and any subcontractor’s) regular mandatory training programs do not already encompass equivalent or greater expectations. Upon request, the contractor shall provide documentation that each Contract Worker has received such training.

For purposes of this Section, “State workplace” includes any location, permanent or temporary, where a Commonwealth employee performs any work-related duty or is representing his or her agency, as well as surrounding perimeters, parking lots, outside meeting locations, and means of travel to and from these locations. Communications are deemed to occur in a State workplace if the Contract Worker reasonably should know that the phone number, email, or other method of communication is associated with a State workplace or is associated with a person who is a State employee.

The Commonwealth of Virginia may require, at its sole discretion, the removal and replacement of any Contract Worker who the Commonwealth reasonably believes to have violated this Section.

This Section creates obligations solely on the part of the contractor. Employees or other third parties may benefit incidentally from this Section and from training materials or other communications distributed on this topic, but the Parties to this agreement intend this Section to be enforceable solely by the Commonwealth and not by employees or other third parties.



**NASPO ValuePoint
INTENT TO PARTICPATE
Cooperative Contract(s) for Small Package Delivery Services**

I. PURPOSE:

The purpose of this Agreement is to provide interested NASPO states with the opportunity to participate in multi-state cooperative contract(s) for the **Small Package Delivery Services SCOPE OF THE CONTRACT portfolio**

The State of **Utah** is authorized by agreement of the participants to act as the procurement officer in developing multi-state cooperative contract(s) for **Small Package Delivery Services**

The resulting contracts will be permissive contracts.

Administrative Fee

There will be a 0.25% NASPO ValuePoint administrative fee associated with these contracts. It is anticipated that the individual states will be able to add an administrative fee when the state executes its Participating Addendum.

II. TERM OF THE CONTRACT

The initial term of the contract will be established for **five years** from the date of award with options to extend the contract.

III. SOLICITATION AND CONTRACT DEVELOPMENT/ADDITIONAL INFORMATION

The solicitation and contract development shall be accomplished in compliance with the NASPO ValuePoint Process Guide and the NASPO Memorandum of Agreement for the NASPO cooperative purchasing program, incorporated herein by reference.

Solicitation Publication Period

Bidders/Offerors will be given at least 40 days after publication to submit proposals.

Solicitation Type and Evaluation Criteria

This RFP will be issued and evaluated in concert with the procurement laws and rules of the State of **Utah** by a sourcing team comprised of members from several states.

Award(s):

The solicitation will permit multiple awards.

Additional Requested Information

State Specific Terms and Conditions: If the participating state wishes to include any State specific terms and conditions with the release of this RFP, please attach those with this Intent to Participate.

Annual Estimated Volume: If your State has an existing contract for this commodity or service, please indicate your annual volume of spend (including any potential political subdivision usage if available).

Annual State Spend \$275,000.00 (approximate)

Annual Political Subdivision Spend Not precisely known,

Total Spend \$275,000.00

State of Vermont

Deborah A. Damore

Director Name

802-828-5784

Director Phone

deborah.damore@vermont.gov

Director Email

Director has approved submitting the ITP? Yes No
(Click appropriate box)

State Specific T&Cs to be included in RFP? Yes No
(Click appropriate box)

Trevor R. Lewis, State Commodity Procurement Administrator

State Point of Contact Name and Title

802 828 2217

Phone

Trevor.R.Lewis@vermont.gov

Email

Please email completed "Intent to Participate" document by March 11, 2021 to:

Tara Larwick
Cooperative Contract Coordinator
NASPO ValuePoint
tlarwick@naspovaluepoint.org

**ATTACHMENT C: STANDARD STATE PROVISIONS
FOR CONTRACTS AND GRANTS
REVISED DECEMBER 15, 2017**

1. Definitions: For purposes of this Attachment, “Party” shall mean the Contractor, Grantee or Subrecipient, with whom the State of Vermont is executing this Agreement and consistent with the form of the Agreement. “Agreement” shall mean the specific contract or grant to which this form is attached.

2. Entire Agreement: This Agreement, whether in the form of a contract, State-funded grant, or Federally-funded grant, represents the entire agreement between the parties on the subject matter. All prior agreements, representations, statements, negotiations, and understandings shall have no effect.

3. Governing Law, Jurisdiction and Venue; No Waiver of Jury Trial: This Agreement will be governed by the laws of the State of Vermont. Any action or proceeding brought by either the State or the Party in connection with this Agreement shall be brought and enforced in the Superior Court of the State of Vermont, Civil Division, Washington Unit. The Party irrevocably submits to the jurisdiction of this court for any action or proceeding regarding this Agreement. The Party agrees that it must first exhaust any applicable administrative remedies with respect to any cause of action that it may have against the State with regard to its performance under this Agreement. Party agrees that the State shall not be required to submit to binding arbitration or waive its right to a jury trial.

4. Sovereign Immunity: The State reserves all immunities, defenses, rights or actions arising out of the State’s sovereign status or under the Eleventh Amendment to the United States Constitution. No waiver of the State’s immunities, defenses, rights or actions shall be implied or otherwise deemed to exist by reason of the State’s entry into this Agreement.

5. No Employee Benefits For Party: The Party understands that the State will not provide any individual retirement benefits, group life insurance, group health and dental insurance, vacation or sick leave, workers compensation or other benefits or services available to State employees, nor will the State withhold any state or Federal taxes except as required under applicable tax laws, which shall be determined in advance of execution of the Agreement. The Party understands that all tax returns required by the Internal Revenue Code and the State of Vermont, including but not limited to income, withholding, sales and use, and rooms and meals, must be filed by the Party, and information as to Agreement income will be provided by the State of Vermont to the Internal Revenue Service and the Vermont Department of Taxes.

6. Independence: The Party will act in an independent capacity and not as officers or employees of the State.

7. Defense and Indemnity: The Party shall defend the State and its officers and employees against all third party claims or suits arising in whole or in part from any act or omission of the Party or of any agent of the Party in connection with the performance of this Agreement. The State shall notify the Party in the event of any such claim or suit, and the Party shall immediately retain counsel and otherwise provide a complete defense against the entire claim or suit. The State retains the right to participate at its own expense in the defense of any claim. The State shall have the right to approve all proposed settlements of such claims or suits.

After a final judgment or settlement, the Party may request recoupment of specific defense costs and may file suit in Washington Superior Court requesting recoupment. The Party shall be entitled to recoup costs only upon a showing that such costs were entirely unrelated to the defense of any claim arising from an act or omission of the Party in connection with the performance of this Agreement.

The Party shall indemnify the State and its officers and employees if the State, its officers or employees become legally obligated to pay any damages or losses arising from any act or omission of the Party or an agent of the Party in connection with the performance of this Agreement.

Notwithstanding any contrary language anywhere, in no event shall the terms of this Agreement or any document furnished by the Party in connection with its performance under this Agreement obligate the State to (1) defend or indemnify the Party or any third party, or (2) otherwise be liable for the expenses or reimbursement, including attorneys’ fees, collection costs or other costs of the Party or any third party.

8. Insurance: Before commencing work on this Agreement the Party must provide certificates of insurance to show that the following minimum coverages are in effect. It is the responsibility of the Party to maintain current certificates of insurance on file with the State through the term of this Agreement. No warranty is made that the coverages and limits listed

herein are adequate to cover and protect the interests of the Party for the Party's operations. These are solely minimums that have been established to protect the interests of the State.

Workers Compensation: With respect to all operations performed, the Party shall carry workers' compensation insurance in accordance with the laws of the State of Vermont. Vermont will accept an out-of-state employer's workers' compensation coverage while operating in Vermont provided that the insurance carrier is licensed to write insurance in Vermont and an amendatory endorsement is added to the policy adding Vermont for coverage purposes. Otherwise, the party shall secure a Vermont workers' compensation policy, if necessary to comply with Vermont law.

General Liability and Property Damage: With respect to all operations performed under this Agreement, the Party shall carry general liability insurance having all major divisions of coverage including, but not limited to:

Premises - Operations

Products and Completed Operations

Personal Injury Liability

Contractual Liability

The policy shall be on an occurrence form and limits shall not be less than:

\$1,000,000 Each Occurrence

\$2,000,000 General Aggregate

\$1,000,000 Products/Completed Operations Aggregate

\$1,000,000 Personal & Advertising Injury

Automotive Liability: The Party shall carry automotive liability insurance covering all motor vehicles, including hired and non-owned coverage, used in connection with the Agreement. Limits of coverage shall not be less than \$500,000 combined single limit. If performance of this Agreement involves construction, or the transport of persons or hazardous materials, limits of coverage shall not be less than \$1,000,000 combined single limit.

Additional Insured. The General Liability and Property Damage coverages required for performance of this Agreement shall include the State of Vermont and its agencies, departments, officers and employees as Additional Insureds. If performance of this Agreement involves construction, or the transport of persons or hazardous materials, then the required Automotive Liability coverage shall include the State of Vermont and its agencies, departments, officers and employees as Additional Insureds. Coverage shall be primary and non-contributory with any other insurance and self-insurance.

Notice of Cancellation or Change. There shall be no cancellation, change, potential exhaustion of aggregate limits or non-renewal of insurance coverage(s) without thirty (30) days written prior written notice to the State.

9. Reliance by the State on Representations: All payments by the State under this Agreement will be made in reliance upon the accuracy of all representations made by the Party in accordance with this Agreement, including but not limited to bills, invoices, progress reports and other proofs of work.

10. False Claims Act: The Party acknowledges that it is subject to the Vermont False Claims Act as set forth in 32 V.S.A. § 630 *et seq.* If the Party violates the Vermont False Claims Act it shall be liable to the State for civil penalties, treble damages and the costs of the investigation and prosecution of such violation, including attorney's fees, except as the same may be reduced by a court of competent jurisdiction. The Party's liability to the State under the False Claims Act shall not be limited notwithstanding any agreement of the State to otherwise limit Party's liability.

11. Whistleblower Protections: The Party shall not discriminate or retaliate against one of its employees or agents for disclosing information concerning a violation of law, fraud, waste, abuse of authority or acts threatening health or safety, including but not limited to allegations concerning the False Claims Act. Further, the Party shall not require such employees or agents to forego monetary awards as a result of such disclosures, nor should they be required to report misconduct to the Party or its agents prior to reporting to any governmental entity and/or the public.

12. Location of State Data: No State data received, obtained, or generated by the Party in connection with performance under this Agreement shall be processed, transmitted, stored, or transferred by any means outside the continental United States, except with the express written permission of the State.

13. Records Available for Audit: The Party shall maintain all records pertaining to performance under this agreement. "Records" means any written or recorded information, regardless of physical form or characteristics, which is produced or

acquired by the Party in the performance of this agreement. Records produced or acquired in a machine readable electronic format shall be maintained in that format. The records described shall be made available at reasonable times during the period of the Agreement and for three years thereafter or for any period required by law for inspection by any authorized representatives of the State or Federal Government. If any litigation, claim, or audit is started before the expiration of the three-year period, the records shall be retained until all litigation, claims or audit findings involving the records have been resolved.

14. Fair Employment Practices and Americans with Disabilities Act: Party agrees to comply with the requirement of 21 V.S.A. Chapter 5, Subchapter 6, relating to fair employment practices, to the full extent applicable. Party shall also ensure, to the full extent required by the Americans with Disabilities Act of 1990, as amended, that qualified individuals with disabilities receive equitable access to the services, programs, and activities provided by the Party under this Agreement.

15. Set Off: The State may set off any sums which the Party owes the State against any sums due the Party under this Agreement; provided, however, that any set off of amounts due the State of Vermont as taxes shall be in accordance with the procedures more specifically provided hereinafter.

16. Taxes Due to the State:

- A. Party understands and acknowledges responsibility, if applicable, for compliance with State tax laws, including income tax withholding for employees performing services within the State, payment of use tax on property used within the State, corporate and/or personal income tax on income earned within the State.
- B. Party certifies under the pains and penalties of perjury that, as of the date this Agreement is signed, the Party is in good standing with respect to, or in full compliance with, a plan to pay any and all taxes due the State of Vermont.
- C. Party understands that final payment under this Agreement may be withheld if the Commissioner of Taxes determines that the Party is not in good standing with respect to or in full compliance with a plan to pay any and all taxes due to the State of Vermont.
- D. Party also understands the State may set off taxes (and related penalties, interest and fees) due to the State of Vermont, but only if the Party has failed to make an appeal within the time allowed by law, or an appeal has been taken and finally determined and the Party has no further legal recourse to contest the amounts due.

17. Taxation of Purchases: All State purchases must be invoiced tax free. An exemption certificate will be furnished upon request with respect to otherwise taxable items.

18. Child Support: (Only applicable if the Party is a natural person, not a corporation or partnership.) Party states that, as of the date this Agreement is signed, he/she:

- A. is not under any obligation to pay child support; or
- B. is under such an obligation and is in good standing with respect to that obligation; or
- C. has agreed to a payment plan with the Vermont Office of Child Support Services and is in full compliance with that plan.

Party makes this statement with regard to support owed to any and all children residing in Vermont. In addition, if the Party is a resident of Vermont, Party makes this statement with regard to support owed to any and all children residing in any other state or territory of the United States.

19. Sub-Agreements: Party shall not assign, subcontract or subgrant the performance of this Agreement or any portion thereof to any other Party without the prior written approval of the State. Party shall be responsible and liable to the State for all acts or omissions of subcontractors and any other person performing work under this Agreement pursuant to an agreement with Party or any subcontractor.

In the case this Agreement is a contract with a total cost in excess of \$250,000, the Party shall provide to the State a list of all proposed subcontractors and subcontractors' subcontractors, together with the identity of those subcontractors' workers compensation insurance providers, and additional required or requested information, as applicable, in accordance with Section 32 of The Vermont Recovery and Reinvestment Act of 2009 (Act No. 54).

Party shall include the following provisions of this Attachment C in all subcontracts for work performed solely for the State of Vermont and subcontracts for work performed in the State of Vermont: Section 10 ("False Claims Act"); Section 11 ("Whistleblower Protections"); Section 12 ("Location of State Data"); Section 14 ("Fair Employment Practices and

Americans with Disabilities Act”); Section 16 (“Taxes Due the State”); Section 18 (“Child Support”); Section 20 (“No Gifts or Gratuities”); Section 22 (“Certification Regarding Debarment”); Section 30 (“State Facilities”); and Section 32.A (“Certification Regarding Use of State Funds”).

20. No Gifts or Gratuities: Party shall not give title or possession of anything of substantial value (including property, currency, travel and/or education programs) to any officer or employee of the State during the term of this Agreement.

21. Copies: Party shall use reasonable best efforts to ensure that all written reports prepared under this Agreement are printed using both sides of the paper.

22. Certification Regarding Debarment: Party certifies under pains and penalties of perjury that, as of the date that this Agreement is signed, neither Party nor Party’s principals (officers, directors, owners, or partners) are presently debarred, suspended, proposed for debarment, declared ineligible or excluded from participation in Federal programs, or programs supported in whole or in part by Federal funds.

Party further certifies under pains and penalties of perjury that, as of the date that this Agreement is signed, Party is not presently debarred, suspended, nor named on the State’s debarment list at: <http://bgs.vermont.gov/purchasing/debarment>

23. Conflict of Interest: Party shall fully disclose, in writing, any conflicts of interest or potential conflicts of interest.

24. Confidentiality: Party acknowledges and agrees that this Agreement and any and all information obtained by the State from the Party in connection with this Agreement are subject to the State of Vermont Access to Public Records Act, 1 V.S.A. § 315 et seq.

25. Force Majeure: Neither the State nor the Party shall be liable to the other for any failure or delay of performance of any obligations under this Agreement to the extent such failure or delay shall have been wholly or principally caused by acts or events beyond its reasonable control rendering performance illegal or impossible (excluding strikes or lock-outs) (“Force Majeure”). Where Force Majeure is asserted, the nonperforming party must prove that it made all reasonable efforts to remove, eliminate or minimize such cause of delay or damages, diligently pursued performance of its obligations under this Agreement, substantially fulfilled all non-excused obligations, and timely notified the other party of the likelihood or actual occurrence of an event described in this paragraph.

26. Marketing: Party shall not refer to the State in any publicity materials, information pamphlets, press releases, research reports, advertising, sales promotions, trade shows, or marketing materials or similar communications to third parties except with the prior written consent of the State.

27. Termination:

A. Non-Appropriation: If this Agreement extends into more than one fiscal year of the State (July 1 to June 30), and if appropriations are insufficient to support this Agreement, the State may cancel at the end of the fiscal year, or otherwise upon the expiration of existing appropriation authority. In the case that this Agreement is a Grant that is funded in whole or in part by Federal funds, and in the event Federal funds become unavailable or reduced, the State may suspend or cancel this Grant immediately, and the State shall have no obligation to pay Subrecipient from State revenues.

B. Termination for Cause: Either party may terminate this Agreement if a party materially breaches its obligations under this Agreement, and such breach is not cured within thirty (30) days after delivery of the non-breaching party’s notice or such longer time as the non-breaching party may specify in the notice.

C. Termination Assistance: Upon nearing the end of the final term or termination of this Agreement, without respect to cause, the Party shall take all reasonable and prudent measures to facilitate any transition required by the State. All State property, tangible and intangible, shall be returned to the State upon demand at no additional cost to the State in a format acceptable to the State.

28. Continuity of Performance: In the event of a dispute between the Party and the State, each party will continue to perform its obligations under this Agreement during the resolution of the dispute until this Agreement is terminated in accordance with its terms.

29. No Implied Waiver of Remedies: Either party's delay or failure to exercise any right, power or remedy under this Agreement shall not impair any such right, power or remedy, or be construed as a waiver of any such right, power or remedy. All waivers must be in writing.

30. State Facilities: If the State makes space available to the Party in any State facility during the term of this Agreement for purposes of the Party's performance under this Agreement, the Party shall only use the space in accordance with all policies and procedures governing access to and use of State facilities which shall be made available upon request. State facilities will be made available to Party on an "AS IS, WHERE IS" basis, with no warranties whatsoever.

31. Requirements Pertaining Only to Federal Grants and Subrecipient Agreements: If this Agreement is a grant that is funded in whole or in part by Federal funds:

- A. Requirement to Have a Single Audit:** The Subrecipient will complete the Subrecipient Annual Report annually within 45 days after its fiscal year end, informing the State of Vermont whether or not a Single Audit is required for the prior fiscal year. If a Single Audit is required, the Subrecipient will submit a copy of the audit report to the granting Party within 9 months. If a single audit is not required, only the Subrecipient Annual Report is required. For fiscal years ending before December 25, 2015, a Single Audit is required if the subrecipient expends \$500,000 or more in Federal assistance during its fiscal year and must be conducted in accordance with OMB Circular A-133. For fiscal years ending on or after December 25, 2015, a Single Audit is required if the subrecipient expends \$750,000 or more in Federal assistance during its fiscal year and must be conducted in accordance with 2 CFR Chapter I, Chapter II, Part 200, Subpart F. The Subrecipient Annual Report is required to be submitted within 45 days, whether or not a Single Audit is required.
- B. Internal Controls:** In accordance with 2 CFR Part II, §200.303, the Party must establish and maintain effective internal control over the Federal award to provide reasonable assurance that the Party is managing the Federal award in compliance with Federal statutes, regulations, and the terms and conditions of the award. These internal controls should be in compliance with guidance in "Standards for Internal Control in the Federal Government" issued by the Comptroller General of the United States and the "Internal Control Integrated Framework", issued by the Committee of Sponsoring Organizations of the Treadway Commission (COSO).
- C. Mandatory Disclosures:** In accordance with 2 CFR Part II, §200.113, Party must disclose, in a timely manner, in writing to the State, all violations of Federal criminal law involving fraud, bribery, or gratuity violations potentially affecting the Federal award. Failure to make required disclosures may result in the imposition of sanctions which may include disallowance of costs incurred, withholding of payments, termination of the Agreement, suspension/debarment, etc.

32. Requirements Pertaining Only to State-Funded Grants:

- A. Certification Regarding Use of State Funds:** If Party is an employer and this Agreement is a State-funded grant in excess of \$1,001, Party certifies that none of these State funds will be used to interfere with or restrain the exercise of Party's employee's rights with respect to unionization.
- B. Good Standing Certification (Act 154 of 2016):** If this Agreement is a State-funded grant, Party hereby represents: (i) that it has signed and provided to the State the form prescribed by the Secretary of Administration for purposes of certifying that it is in good standing (as provided in Section 13(a)(2) of Act 154) with the Agency of Natural Resources and the Agency of Agriculture, Food and Markets, or otherwise explaining the circumstances surrounding the inability to so certify, and (ii) that it will comply with the requirements stated therein.

(End of Standard Provisions)

ATTACHMENT D**OTHER PROVISIONS****1. CONTRACTOR'S REPRESENTATIONS AND WARRANTIES**

1.1 General Representations and Warranties. The Contractor represents, warrants and covenants that:

- (i) The Contractor has all requisite power and authority to execute, deliver and perform its obligations under this Contract and the execution, delivery and performance of this Contract by the Contractor has been duly authorized by the Contractor.
- (ii) There is no pending litigation, arbitrated matter or other dispute to which the Contractor is a party which, if decided unfavorably to the Contractor, would reasonably be expected to have a material adverse effect on the Contractor's ability to fulfill its obligations under this Contract.
- (iii) The Contractor will comply with all laws applicable to its performance of the services and otherwise to the Contractor in connection with its obligations under this Contract.
- (iv) The Contractor (a) owns, or has the right to use under valid and enforceable agreements, all intellectual property rights reasonably necessary for and related to delivery of the services and provision of the services as set forth in this Contract; (b) shall be responsible for and have full authority to license all proprietary and/or third party software modules, including algorithms and protocols, that Contractor incorporates into its product; and (c) none of the services or other materials or technology provided by the Contractor to the State will infringe upon or misappropriate the intellectual property rights of any third party.
- (v) The Contractor has adequate resources to fulfill its obligations under this Contract.
- (vi) Neither Contractor nor Contractor's subcontractors has past state or federal violations, convictions or suspensions relating to miscoding of employees in NCCI job codes for purposes of differentiating between independent contractors and employees

1.2 Contractor's Performance Warranties. Contractor represents and warrants to the State that:

- (i) Each and all of the services shall be performed in a timely, diligent, professional and skillful manner, in accordance with the highest professional or technical standards applicable to such services, by qualified persons with the technical skills, training and experience to perform such services in the planned environment.
- (ii) Any time software is delivered to the State, whether delivered via electronic media or the internet, no portion of such software or the media upon which it is stored or delivered will have any type of software routine or other element which is designed to facilitate unauthorized access to or intrusion upon; or unrequested disabling or erasure of; or unauthorized interference with the operation of any hardware, software, data or peripheral equipment of or utilized by the State. Without limiting the generality of the foregoing, if the State believes that harmful code may be present in any software delivered hereunder,

Contractor will, upon State's request, provide a new or clean install of the software. Notwithstanding the foregoing, Contractor assumes no responsibility for the State's negligence or failure to protect data from viruses, or any unintended modification, destruction or disclosure.

- (iii) To the extent Contractor resells commercial hardware or software it purchased from a third party, Contractor will, to the extent it is legally able to do so, pass through any such third party warranties to the State and will reasonably cooperate in enforcing them. Such warranty pass-through will not relieve the Contractor from Contractor's warranty obligations set forth herein.

2. REMEDIES FOR DEFAULT: In the event either party is in default under this Contract, the nondefaulting party may, at its option, pursue any or all of the remedies available to it under this Contract, including termination for cause, and at law or in equity.

3. SOV Cybersecurity Standard 19-01: All products and service provided to or for the use of the State under this Contract shall be in compliance with State of Vermont Cybersecurity Standard 19-01, which Contractor acknowledges has been provided to it, and is available on-line at the following URL: <https://digitalservices.vermont.gov/cybersecurity/cybersecurity-standards-and-directives>

4. PROFESSIONAL LIABILITY AND CYBER LIABILITY INSURANCE COVERAGE

In addition to the insurance required in Attachment C to this Contract, before commencing work on this Contract and throughout the term of this Contract, Contractor agrees to procure and maintain (a) Technology Professional Liability insurance for any and all services performed under this Contract, with minimum third party coverage of \$1,000,000.00 per claim, \$1,000,000.00 aggregate; and (b) first party Breach Notification Coverage of not less than \$1,000,000.00.

Before commencing work on this Contract the Contractor must provide certificates of insurance to show that the foregoing minimum coverages are in effect.



**NASPO ValuePoint
INTENT TO PARTICPATE
Cooperative Contract(s) for Small Package Delivery Services**

I. PURPOSE:

The purpose of this Agreement is to provide interested NASPO states with the opportunity to participate in multi-state cooperative contract(s) for the **Small Package Delivery Services SCOPE OF THE CONTRACT portfolio**

The State of **Utah** is authorized by agreement of the participants to act as the procurement officer in developing multi-state cooperative contract(s) for **Small Package Delivery Services**

The resulting contracts will be permissive contracts.

Administrative Fee

There will be a 0.25% NASPO ValuePoint administrative fee associated with these contracts. It is anticipated that the individual states will be able to add an administrative fee when the state executes its Participating Addendum.

II. TERM OF THE CONTRACT

The initial term of the contract will be established for **five years** from the date of award with **no** options to extend the contract.

III. SOLICITATION AND CONTRACT DEVELOPMENT/ADDITIONAL INFORMATION

The solicitation and contract development shall be accomplished in compliance with the NASPO ValuePoint Process Guide and the NASPO Memorandum of Agreement for the NASPO cooperative purchasing program, incorporated herein by reference.

Solicitation Publication Period

Bidders/Offerors will be given at least 40 days after publication to submit proposals.

Solicitation Type and Evaluation Criteria

This RFP will be issued and evaluated in concert with the procurement laws and rules of the State of **Utah** by a sourcing team comprised of members from several states.

Award(s):

The solicitation will permit multiple awards.

Additional Requested Information

State Specific Terms and Conditions: If the participating state wishes to include any State specific terms and conditions with the release of this RFP, please attach those with this Intent to Participate.

Annual Estimated Volume: If your State has an existing contract for this commodity or service, please indicate your annual volume of spend (including any potential political subdivision usage if available).

Annual State Spend	6,000,000
Annual Political Subdivision Spend	11,000,000
Total Spend	\$17,000,000

State of Pennsylvania

Ms. Janice Pistor
Director Name

717-787-5862
Director Phone

jpistor@pa.gov
Director Email

Director has approved submitting the ITP? Yes No
(Click appropriate box)

State Specific T&Cs to be included in RFP? Yes No
(Click appropriate box)

James (Ben) Huffine
State Point of Contact Name and Title

717-346-3847
Phone

jahuffine@pa.gov
Email

Please email completed "Intent to Participate" document by March 11, 2021 to:

Tara Larwick
Cooperative Contract Coordinator
NASPO ValuePoint
tlarwick@naspovaluepoint.org

Business Request for GRAMA Business Confidentiality Claim

use by contractors or private providers to identify protected records or information

Note: Utah Code § 63G-2-305(1) states that trade secrets can be protected if the person submitting the trade secret provides the governmental entity with a confidentiality claim. Likewise, Utah Code § 63G-2-305(2) states that commercial financial information can be protected if disclosure could reasonably be expected to result in unfair competitive injury to the person submitting the information, and that person has provided a confidentiality claim. Confidentiality claims are described in Utah Code § 63G-2-309. A claim must include a concise statement of reasons supporting the claim and must be submitted with the information requested to be protected.

Claimant information:

Company name:

Address:

City:

State:

ZIP code:

Name of company representative:

Telephone number:

Email address:

Details about confidentiality claim:

This claim applies to records submitted to:

Date:

Reason for submission:

Confidentiality request applies to:

page paragraph reason

Following is a concise statement of reasons supporting this confidentiality claim:

Is a public (redacted) copy of the records also being provided? yes no

Note: Making a confidentiality claim does not guarantee protected classification if government receives a records request.

Signed: _____

Date: _____

Utah Supplier Portal: Changing Your Time Zone

Update the time zone in your vendor profile to reflect the time zone you are in.

VENDOR REGISTRATION

- Review your vendor profile
 - Go to the top right corner and click on your company name
 - Select "Return to SciQuest Supplier Network"

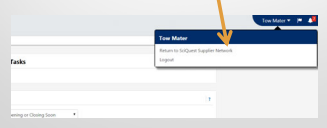

VENDOR REGISTRATION

- Your screen will look something like this:

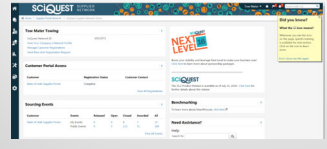

VENDOR REGISTRATION: Time Zone

- Go to the top right corner and click on your company name
 - Select "View My Profile"
 - Click on "Language, Time Zone, and ..."
- Click on "Language, Time Zone, and ..."

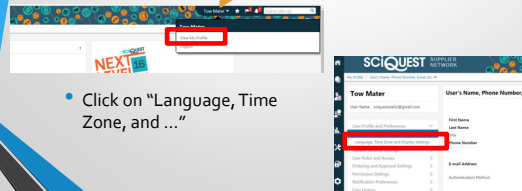

VENDOR REGISTRATION: Time Zone

- Find the "Time Zone" and click in the drop down box
 - The System defaults all registrations to EASTERN TIME
 - Select the Time Zone you would like ALL sourcing event times to show in
 - The STATE OF UTAH is **MDT/MST MOUNTAIN STANDARD TIME**



Click "Save Changes"

Additional Questions?

Contact:
sciquestadmin@Utah.gov



Response to NASPO ValuePoint Utah Solicitation # CH21-36 April 26, 2021



Redacted Version



Executive Summary

UPS is uniquely qualified to continue to meet the small package delivery and logistic needs of the State Governments and their entities.

Some highlights of our offer include:

- Dedicated Sales Team with significant experience and knowledge in state government, transportation and logistics
- In-depth Portfolio of Services
- UPS Customer Solutions that align with state needs
- Single Driver Advantage
- Business Process improvements that are designed to reduce cost and increase efficiency for UPS customers

Auxiliary solutions in addition to the services solicited include UPS Technology & Visibility Solutions, Hazardous Materials, including Category A shipments, and Healthcare Premier. These and any other auxiliary solutions are provided under separate terms and conditions, as applicable.

We offer an unmatched portfolio of domestic and international services with service to every address (100% of zip codes) in the 50 states and Puerto Rico. Our comprehensive portfolio offers industry-leading guaranteed, time-definite delivery options. UPS has the capacity and experience to develop customized shipping and logistics solutions for those state government agencies and entities with specialized needs.

UPS's Enterprise Sales Resources have worked closely with state agencies implementing solutions that align with state needs. Throughout 2020, we worked closely with states to transport PPE, vaccines and other COVID-related shipments.

UPS owns the world's largest transportation network. And UPS alone offers an integrated Ground and Air network, without the use of sub-contractors in the domestic US. This operational advantage allows States and their Agencies to use the single driver advantage. Because one driver picks up all of your ground and air packages, the shipper can use UPS's shipping system, the Time-in-Transit and the Cost Comparison tool to determine how much they want to pay to meet their delivery deadlines. Empowering users to make these smart decisions can result in significant savings to the consumer.

We understand the budgetary constraints States are under. UPS can put its industry leading technology and business process solutions expertise to work to help the states overcome these challenges. These solutions enable State Agencies to exercise varying degrees of control, oversight and efficiencies to reduce the added costs associated with the over usage of premium air services and surcharges. These auxiliary solutions assist our customers in managing their overall transportation spend. For example, to assist agencies in realizing maximized cost savings, we work with agencies to select the right service level through the concept of mode optimization. This concept empowers users to take advantage of the maximum cost savings by selecting the best and most cost effective service level, UPS Ground or Next Day Air, for every package.



Response to Solicitation

#CH21-36

UPS has been at the forefront of transportation and logistics breakthroughs for over 100 years; and we are a great American success story. We look forward to continuing our mutually beneficial partnership which provides the best value to NASPO ValuePoint, state agencies and other participating entities. We believe our proposal will demonstrate our capabilities through the service we provide.



Response to Solicitation
#CH21-36

Technical Response



Response to Solicitation
#CH21-36

SERVICE DAT

NOV 20 1987

INTERSTATE COMMERCE COMMISSION

CERTIFICATE

No. MC-115495 (Sub-No. 45)X*

UNITED PARCEL SERVICE, INC.
AN OHIO CORPORATION
DOWNERS GROVE, ILLINOIS

This Certificate is evidence of the carrier's authority to engage in transportation as a common carrier by motor vehicle.

This authority will be effective as long as the carrier maintains compliance with the requirements pertaining to insurance coverage for the protection of the public (49 CFR 1043); the designation of agents upon whom process may be served (49 CFR 1044); and tariffs or schedules (49 CFR 1300 through 1310, revised). The carrier shall also render reasonably continuous and adequate service to the public. Failure to meet these conditions will constitute sufficient grounds for the suspension, change, or revocation of this authority.

This authority is subject to any terms, conditions, and limitations as are now, or may later be, attached to this privilege.

For common carriers with irregular route authority: Any irregular route authority authorized in this Certificate may not be tacked or joined with your other irregular route authority unless joinder is specifically authorized.

The transportation service to be performed is described on the reverse side of this document.

By the Commission.

(SEAL)

Noreta R. McGee
Secretary

NOTE: If there are any discrepancies regarding this document, please notify the Commission within 30 days.

*Supersedes: Certificate No. MC-115495 (Sub-No. 43)X



Response to Solicitation

#CH21-36

To operate as a common carrier, by motor vehicle, in interstate or foreign commerce, over irregular routes, transporting general commodities (except those of unusual value, commodities in bulk, classes A and B explosives, household goods as defined by the Commission, and those requiring special equipment), between points in Alabama, Arizona, Arkansas, California, Colorado, Florida, Georgia, Idaho, Illinois, Indiana, Iowa, Kansas, Kentucky, Louisiana, Michigan, Minnesota, Mississippi, Missouri, Montana, Nebraska, Nevada, New Mexico, North Carolina, North Dakota, Ohio, Oklahoma, Oregon, South Carolina, South Dakota, Tennessee, Texas, Utah, Washington, Wisconsin, Wyoming, Pennsylvania, West Virginia, and Virginia, restricted to the following condition: No service shall be rendered in the transportation of any package or article weighing more than 70 pounds or exceeding 130 inches in length and girth combined or exceeding 108 inches in length, and each package or article shall be considered as a separate and distinct shipment.



US Department
of Transportation
Federal Aviation
Administration

Air Carrier Operating Certificate

This certifies that

UNITED PARCEL SERVICE CO.
1400 North Hurstbourne Parkway
Louisville, Kentucky 40223

has met the requirements of the Federal Aviation Act of 1958, as amended, and the rules, regulations, and standards prescribed thereunder for the issuance of this certificate, and is hereby authorized to operate as an air carrier in accordance with said Act and the rules, regulations and standards prescribed thereunder, and the terms, conditions, and limitations contained in the operations specifications.

This certificate is not transferable and, unless sooner surrendered, suspended or revoked, shall continue in effect indefinitely.

By Direction of the Administrator

CHARLES E. WHITLOCK

(Signature)

MANAGER, SO FSDO-01

(Title)

Certificate number: IPXA097B

Effective date: October 10, 1986

Reissued: July 30, 2004

Issued at: Louisville, Kentucky



Response to Solicitation

#CH21-36

- b. Offeror shall provide represent and warrant that it is authorized pursuant to permits issued to transport shipments, as described in this Master Agreement in interstate and foreign commerce from, to, or between all points and places in the United States and international points and to lawfully furnish to the Authorized User all related services provided for herein.

UPS represents that it is duly authorized and licensed by the appropriate regulatory agencies to operate and provide services as set forth in the UPS Rate & Service Guide and UPS Tariff/Terms & Conditions of Service.

- c. The Offeror shall certify that it agrees to immediately notify the Authorized User of any threatened or actual suspension or revocation of any such permit or operating authority during the course of any awarded price agreement.

If UPS is unable to deliver in certain geographic areas, it notifies its customers through www.ups.com. UPS does not inform customers of “threatened” limitations to its operating authority. During the pandemic, UPS was able to maintain its ability to deliver through an ever-changing environment of federal, state and local restrictions that directly affected its business.

- d. The Offeror shall represent and warrant that it has not, and during the term of this Master Agreement, will not request, pursuant to 49 U.S. C. Section 14501 (c) (B) (ii), to be subject to any law, regulation or provision that purports to create any right or obligation that is inconsistent with the provision of this Master Agreement.

UPS can comply with this request.

- e. The Offeror must provide its calendar or fiscal year 2019 Operating Ratio (operating expenses divided by operating revenues multiplied by 100 give the percentage of the operating revenues which are required to pay the operating expenses, this being the operating ratio).

In 2019, the percentage of Operating Revenues required to pay Operating Expenses was 89.48.

Indices	Revenue (B)
Revenue	\$74,094
Operating Expenses	\$66,296

- f. The Offeror must provide its Shipment Claims Ratio for calendar or fiscal year 2019. The ratio shall be the ratio of claims for shipment loss or damage to total shipments for both express small package air and expedited ground service shipments.

See Section 3 - Confidential, Protected or Proprietary Information.

- g. The Offeror shall provide the following information specific to the Offeror’s company:

1. Company’s full legal name, and 2. Primary business address

United Parcel Service, Inc., an Ohio corporation
55 Glenlake Parkway
Atlanta, GA 30328



3. Description of company ownership structure

United Parcel Service, Inc., an Ohio corporation, is a wholly-owned subsidiary of United Parcel Service, Inc., a Delaware corporation.

4. Number of employees

UPS has more than 495,000 employees globally.

5. Website address

www.ups.com

6. Sales contact information

Felicia Hall
Contract Manager
Enterprise Sales, State Government
Email: fhall@ups.com
316 Pennsylvania Ave, SE, Suite 300
Washington, DC 20003

1. Ability to Meet the Scope of Work

- a. Offeror to respond to the seven points listed in Attachment B: Scope and describe in detail their ability to meet or execute those points to this technical criteria.

UPS provides best-in-class small package delivery service to the general public and is pleased to make this offer for State and local governments to enjoy the same best-in-class service with the added value of customized transportation rates. The UPS Rate & Service Guide and UPS Tariff/Terms & Conditions of Service contain information shippers need to ship packages – from services to packaging and payment. Essential information regarding the general terms and conditions of service governing UPS is provided in the UPS Tariff/Terms and Conditions of Service.

1. Exclusion of Listed Charges:

Offeror certifies the following regarding the exclusion of listed charges:

- a. The Offeror shall not propose or apply pick-up charges or weekly service in addition to the contracted rates due to aggregate NASPO ValuePoint volume anticipated.

UPS can comply with this requirement. UPS agrees that it will not bill pick-up charges for small package air or ground shipments. UPS will also not assess pick-up fees for state government accounts utilizing a drop box or a UPS facility for tender of packages. In order to support NASPO ValuePoint's and the participating States' Green Initiatives, UPS will encourage the use of Smart Pick-up Service where practicable. By utilizing Smart Pick-ups, a shipping location can request a pick-up automatically at point of shipment processing only on those dates when an actual shipment is being tendered. There is also no charge for Smart Pick-up Services.



- b. The Offeror shall not require a minimum number of packages per trip, per day, per week or per month.

UPS can comply with this requirement.

2. Carrier Pick-Up:

Offeror will pick-up packages directly from all requesting agencies and political subdivisions upon request. Offeror must bill each Authorized User for shipments the Authorized User tenders to the Carrier. Packages must be scanned when picked up at the location.

Upon request, UPS drivers will pick up packages directly from all requesting agencies and political subdivisions. Shipments will be billed to the UPS account number indicated by the authorized user. UPS makes the first scan when the package arrives at the UPS origin location.

3. Money Back Guarantee

- a. Offeror must provide a 100% Money Back Guarantee. The Carrier shall fully refund or credit the Authorized User account for the packages that are not delivered or picked up in accordance with the guaranteed delivery service. Authorized User shall decide between a refund or a credit to their account. Packages that are delivered over 60 seconds after the guaranteed delivery time are considered late. The Authorized User shall request the refund or credit within 30 days of the scheduled delivery time. Carriers are encouraged to offer automatic refunds. If the late package meets one or more of the Carrier's exception criteria, as stated in the Service Guide, the Carrier is not obligated to issue a refund to the Authorized User.

UPS small package delivery services are subject to a money-back guarantee as set forth in the UPS Rate & Service Guide and UPS Tariff/Terms & Conditions of Service in effect at the time of shipping. If UPS fails to attempt delivery within the guaranteed time, we will, on request, refund or credit the account with the shipping charges (or the proportionate part of those where only some of the packages in a shipment fail to meet the applicable time), provided that the conditions identified in our UPS Rate & Service Guide and UPS Tariff/Terms & Conditions of Service at www.ups.com and www.ups.com/terms are met. The guarantee does not apply when late delivery results from the package not complying with the service restrictions and conditions set out in our terms and conditions of carriage, from events beyond our control (force majeure) or due to any suspension of carriage or the exercise of any lien in accordance with our terms and conditions. The authorized user must request a guaranteed service refund within the timeframe required under our standard commercial terms and conditions.

Note that our current standard commercial timeframe to request a guarantee service refund is 15 days from the date of the scheduled delivery.

- b. Carrier must provide clearly marked money back guaranteed zone based price sheets (schedules of rates and charges) for each service showing rates and charges by weight and zone for all contiguous 48 state domestic shipping. Separate rates in pages may be provided and clearly marked for Hawaii and Alaska and Puerto Rico services. Carriers offering pricing for intrastate ground services only must provide separate clearly marked zone based pricing for the designated state. Rates will be in dollars and cents per pound.



Response to Solicitation

#CH21-36

UPS can comply with this requirement. As part of our response UPS has provided a complete set of rate charts for all services offered. UPS will only offer Money Back Guarantee rates, as described in response to subsection (a) of this Money Back Guarantee Section. UPS will not offer origin discounted rates for Alaska, Hawaii and Puerto Rico.

UPS offers customized rate sheets identifying its firm offer of rates and prices for transportation rates and prices. The rates and prices identified in the rate sheets will be guaranteed for 12-month periods and increase only with approval by the Lead State. Other fees and charges that may impact an authorized user's invoice are identified in UPS's Rate and Service Guide and as described in UPS's Tariff/Terms and Conditions of Service, in effect at the time of shipping. These fees and charges are subject to change without notice. In accordance with the conditions of the solicitation, UPS has waived all pick-up charges, including on-call/on-demand, and capped fuel surcharges at 7%. Fuel surcharge information is posted on UPS's website, www.ups.com.

- c. **Non-Money Back Guarantee:** Offerors must propose a money back guarantee. If an Offeror opts to additionally propose a non-money back guarantee option, the offeror must clearly delineate between the money back guarantee cost and the non-money back guarantee cost. (This portion of the Scope may be updated depending on the vendor's submission and their Money Back guarantee the offeror provides.)

UPS will offer only Money Back Guarantee rates.

4. Carrier Capabilities:

Offerors providing interstate services must serve every zip code in the United States or if providing interstate services in certain states only, offer services in every zip code in the states in which services are provided. Offerors providing intrastate services shall serve every zip code within the boundaries of the Participating State requesting intra-state services as identified in this RFP.

UPS can comply with this requirement. We offer an unmatched portfolio of domestic and international services with service to every address (100% of zip codes) in the 50 states and Puerto Rico. Our comprehensive portfolio offers industry-leading guaranteed, time-definite delivery options.

UPS is constantly improving its portfolio to better address the needs of customers world-wide. UPS is proud to provide all commercially available services at the time of shipping to our government customers. Below is a list of services from our current 2021 Rate and Service Guide.

Product Name	Service Description	Guaranteed	Time in Transit	Area Coverage
UPS Next Day Air Early	Guaranteed overnight, first of day service, as early as 8:00 A.M., to the 48 contiguous U.S. states and limited addresses in Anchorage, Alaska.	Yes	1 Business Day, as early as 8:00 A.M., depending on origin/destination	US 48 contiguous states and limited addresses in Anchorage, Alaska
UPS Next Day Air	Guaranteed next business day delivery by 10:30 a.m., 12:00 p.m. or end of day, depending on destination, to all 50 states and Puerto Rico. UPS Next Day Intra is the name for this service in	Yes	1 Business Day, 10:30 a.m. (some extended areas by noon and end of day)	US 50 states and Puerto Rico



Response to Solicitation

#CH21-36

Product Name	Service Description	Guaranteed	Time in Transit	Area Coverage
	Puerto Rico.			
UPS Next Day Air Saver	Guaranteed overnight afternoon delivery throughout the U.S. 48 contiguous states.	Yes	1 Business Day, 3:00 p.m. or 4:30 p.m. to commercial destinations where UPS Next Day Air delivery is committed by 10:30 a.m. or noon, respectively; residential by end of day	US 48 contiguous states
UPS 2nd Day Air A.M.	Guaranteed delivery, by the morning of the second business day, to commercial destinations in the U.S. 48 contiguous states and selected locations in Anchorage, Alaska.	Yes	2 Business Days, 10:30 a.m. (some extended areas by 12:00 p.m.)	US 48 contiguous states
UPS 2nd Day Air	Guaranteed delivery, by the end of the second business day, throughout the U.S. and Puerto Rico.	Yes	2 Business Days, End of Day	US 50 states and Puerto Rico
UPS 3 Day Select	Guaranteed delivery, by the end of the third business day, throughout the U.S. 48 contiguous states.	Yes	3 Business Days, End of Day	US 48 contiguous states
3 Day Select (Canada to US)	A guaranteed, day-definite service. Shipments are typically delivered by the end of the third business day. Service is only valid from Canada to the US 48 contiguous states.	Yes	3 Business Days, End of Day	Canada to US 48 contiguous states (Import Only)
UPS Ground	Guaranteed, cost-effective, day-definite delivery typically within one to five business days to all 50 states and Puerto Rico. UPS Ground is an economical choice for all routine shipments.	Yes	1 to 5 Business Days, End of Day, depending on origin/destination	US 50 states and Puerto Rico
UPS Ground on Saturday	UPS Ground delivery and pickup service on Saturday to eligible postal zips within the United States. UPS Ground on Saturday is an economical choice for all routine shipments.	Yes	1 – 5 Business Days, End of Day	Available in select destination zip codes
UPS Hundredweight Service	Guaranteed, reliable, cost-effective delivery for non-palletized, multiple package shipments sent to a single address on the same day. Time-definite or day-definite delivery within 1 to 5 business days depending on level of service. Ideal for scheduled pickup customers with frequent shipments of more than 100 pounds. Available with UPS Next Day Air®, UPS Next Day Air Saver®, UPS 2nd Day Air A.M.®, UPS 2nd Day Air®, UPS 3 Day Select®, and UPS Ground.	Yes	1-5 Business Days, Matches single package service offerings	Matches single package service offerings
UPS Worldwide Express Plus	UPS Express Plus is UPS's premier international express shipping solution, available to major cities in 56 countries around the world. It guarantees customers will have their shipment early in their business day. It is an ideal service for customers who need their shipment as soon as possible.	Yes	To Canada: 1 Business Day, 8:30, 9:00, or 11:00 a.m.; To Europe: 2 Business Days, 9:00 or 11:00 a.m.; To Asia: 2-3 Business Days, 9:00 or 11:00 a.m.	All UPS origins to 56 countries
UPS Worldwide Express	UPS Express is UPS's premium, time-committed small package express service, serving 121 countries worldwide. Time-definite delivery is guaranteed in 1-3 business days, typically by 10:30 a.m. or noon. In limited areas, the time commit is 2pm. For worldwide shipments to Europe, UPS has a competitive advantage of delivering by 10:30 a.m. in 29 cities, while DHL and FedEx express services have noon or EOD commitments in those cities.	Yes	1-3 Business Days, 10:30 a.m. or 12:00 p.m. (limited areas 2 p.m.)	All UPS origins to 121 countries
UPS Worldwide Express Saver	UPS Express Saver is UPS's day-definite small package express service. Whether worldwide, transborder or domestic, service is guaranteed by end-of-day in typically 1-3 business days.	Yes	1-3 Business Days, End of Day, depending on origin/destination	All UPS origins to all UPS destinations
UPS Expedited	UPS Expedited is a deferred, international small package service that is guaranteed in 2-5 business days by end of day (guarantee applicable to U.S. and Canada payors only).	Yes	2-5 Business Days, End of Day, depending on origin/destination	From 80 countries to more than 220 countries and territories
UPS Standard / Worldwide Standard	UPS Standard is a small package, "non-express", "deferred", day-definite, ground service available in North America and Europe.	Yes	1-8 Business Days, End of Day, depending on origin/destination	North America (between US, Canada and Mexico), Europe domestic, transborder, and worldwide lanes between



Response to Solicitation #CH21-36

Product Name	Service Description	Guaranteed	Time in Transit	Area Coverage
				Norway, Switzerland, and the EU

UPS® PREMIER

To further compliment our capabilities, UPS is pleased to offer UPS® PREMIER. This value added service is ideal for customers shipping critical, high value time- or temperature-sensitive products that require an additional layer of protection.

CUSTOMER BENEFITS



Benefits:

- Next generation technology enables real-time physical visibility and a priority path throughout the network
- UPS Premier accessories and functionality provide the shipper the opportunity to add special handling instructions when manifesting a shipment such as a temperature requirement and recovery directives
- These special handling instructions are contained within the Package Level Detail (PLD) and travel with the package from pickup to delivery
- Predetermined Recovery Plans - Proprietary database links recovery instructions to help ensure remediation

UPS® PREMIER is a contractual offering that is available under separate terms and conditions.



5. Software:

Offerors shall provide a description of how the software is accessed in the solicitation response. Including, if an online application is available instead of or along with the software needed to run the shipping system. All software whether online or separate software must have the Master Agreement Rates pre-loaded and the Offeror maintains the software and website free of charge to the Participating Users and Master Agreement.

UPS provides several no-cost technology solutions for its customers' convenience. An account holder can request negotiated rates to be shown in UPS provided shipping platforms. There are many options for automated shipping, tracking, address book utilization, and label creation. The account holder's UPS team will guide them to the appropriate UPS solution for shipping. For [ups.com/Internet Shipping and Worldship](https://www.ups.com/Internet Shipping and Worldship), authorized users can activate their contracted rates. For CampuShip, the user's sales representative can authorize visibility of the negotiated rates.

UPS's technology solutions are available to increase efficiencies for customers in their use of paid transportation services that are the focus of this solicitation. Use of UPS technology solutions are subject to terms and conditions applicable to the solution used, in effect at the time of shipping. For those customers that find these extras unnecessary, UPS provides transportation services for customers who prefer to use manual shipping documents.

The following section details UPS's no-cost Shipping and Visibility solutions.



UPS Technology Solutions Comparison

	UPS Internet Shipping » Create a Shipment Now	UPS CampusShip® » Request More Information	WorldShip® » Download WorldShip Now
Decision Points			
Shipper Profile			
Low-volume or occasional	✓		
High-volume/distribution warehouse			✓
Employees are spread across multiple campuses, office buildings, or locations worldwide		✓	
Need to ship packages and freight	✓	✓	✓
Key Features			
Send shipment notifications with UPS Quantum View Notify	✓	✓	✓
Assign shipping privileges at a user level		✓	
Share address books across multiple user IDs		✓	
Connect to internal business systems (ODBC/XML)			✓
Application Format			
Web-based	✓	✓	
Windows-based shipping software			✓
Common Features			
Batch import shipment and/or address detail	✓	✓	✓
Export shipping history	✓	✓	✓
Create distribution lists	✓	✓	✓



Response to Solicitation #CH21-36

Following are highlights of UPS Shipping Solutions:

Shipping on ups.com (Low Volume or Occasional Shipping)



[Log Out](#)

Create a Shipment

** Indicates required field*

Guided Steps **Off** On

Choose an Account

Ship From *

Ship To *

Saved Addresses [Search Contacts](#)

Country or Territory *

United States

Name * Contact Name

Address *

[Edit Address - Add Suite/Apt](#)

Is this a residential address?

Email Phone Extension

UPS may use the email address and/or mobile number provided to update your receiver about the status of their package.

Save As New Entry

No



Response to Solicitation

#CH21-36

Online shipping has been redesigned for user efficiency, which means the classic version of ups.com will be going away soon. Agencies and Authorized Users may want to begin using the new shipping experience right away. Enhancements include:

- All payment options, address book, and preferences automatically transition to the new experience
- Balance speed and price with a live price estimate that automatically updates as you ship
- Address packages faster than ever with enhanced address book search and predictive text entry
- Take advantage of new UPS services or new online options like Dangerous Goods
- Ship to multiple people at once with improved distribution list and batch import capabilities

With your My UPS login, Shipping on ups.com lets you prepare air, ground and international shipments using a UPS account number or credit card. Not only can you ship individual packages, you can also create bill of lading and air waybills. Determine package and freight rates; schedule pickups; find drop-off locations; track shipments; store recipient contacts; store billing, notification and printing references; view shipping history; and receive email notifications - all online at ups.com®. Features include:

- **Online shipping** — With no software to install, quickly process your small package shipments in one convenient location on ups.com®. Ship up to 20 packages at one time to a single receiver or create batch shipments through Distribution List processing or Import Batch Shipping. Minimal navigation between entry screens saves you valuable time so you can focus on other critical business tasks.
- **Address book convenience** — Speed shipment processing by selecting from the built-in Address Book each time you ship a package. Store up to 2,000 addresses, individually or batch imported in CSV format, and add residential or commercial classifications. Eliminating repeated key entry will reduce the chance for errors resulting in potential delivery problems or costly delays.
- **Flexible shipping options** — Take advantage of a variety of day- and time-definite UPS package and freight services and value-added solutions such as UPS Returns®, Declared Value and Quantum View Notify® e-mail notifications for up to five people. Visit ups.com to learn more about our domestic and international service portfolio serving over 220 countries and territories and tailor shipments to your specific business and customer needs.
- **Full visibility** — Keep you and your customers informed of package progress by tracking a shipment from pickup to delivery on ups.com.



UPS CampusShip® (High Volume Shipping)

UPS CampusShip® is a secure, web based shipping system that enables multiple users within an organization to ship UPS packages and letters and to perform other shipping-related tasks – all by using any computer with Internet access.

Log In

Welcome to UPS CampusShip. To begin, please enter your User ID and Password.
Note: User ID and Password fields are case sensitive.

Returning Users [Help](#)

User ID

Password

Remember Me o
(Do not check for shared computers.)

Change the language of this page:
 ↔

[Log In](#)

[Forgot User ID or Password](#)

Perfect for desktop users spread across locations at State agencies, and college campuses, CampusShip delivers both streamlined shipment management and increased shipment visibility.

GENERAL RESOURCES	
UPS Tracking UPS Locations Export Documentation Order Supplies Packaging Advisor UPS Customer Service Legal Agreement UPS CampusShip Support UPS CampusShip Help User Guides	UPS TradeAbility™ International Tools <ul style="list-style-type: none"> • Screen for Denied Parties • Find Harmonized Codes • Estimate Landed Cost • Detect Export Licenses • Check Import Compliance • Access International Forms <p>Other Features</p> <ul style="list-style-type: none"> • Create and manage a Product List • View your Transaction History
FREIGHT RESOURCES	
Create a Freight Shipment View Freight History	Manage Commodity List Schedule a Freight Pickup View Freight Pickup History



From any desktop, users within an organization can:

- Use corporate and personal address books to speed processing and reduce errors
- Select from multiple billing options
- Prepare shipping labels
- Download or view shipment history data online
- Allow users to create, manage and ship to a distribution list
- Allow users to import shipment data to process up to 250 shipments at once
- Ship domestic and international packages and freight using one system
- Administrative features allow management to:
 - Customize, require, validate and lock reference fields used for reference information such as client/matter codes, cost codes, purchase order numbers and department codes
 - References can be used for tracking and billing as a solution for cost center allocation.
 - Share and update common address information across the organization with a corporate address book, or utilize recipient info from Outlook®
 - Restrict or grant access to the corporate address book, recipient addresses and address groups, ship-to countries, UPS service levels, optional UPS services, payment methods or other shipping and administrative features
- Allow users to see no rates, published rates or account-specific negotiated rates
- Use shipping history reporting capabilities or export data into a comma separated value file format to integrate data into your enterprise systems or analysis tools
- Notify up to five recipients of a shipment's status using email notifications
- Allow or grant access for users to charge shipments to credit cards
- Produce detailed reports on usage

UPS CampusShip® offers significant benefits for both employees and management. By putting this fast, easy-to-use shipping system at everyone's fingertips, organizations can:

- Reduce costly shipping errors
- Lower shipping costs by eliminating the need for a centralized mailroom
- Better allocate shipping charges
- Improve customer/client service



UPS WorldShip® (High Volume Shipping)

UPS WorldShip Software is UPS' full-featured, Windows-based shipping used primarily by customers with a mail room or warehouse shipping environment.

Key features include:

The screenshot displays the UPS WorldShip software interface. The top navigation bar includes 'Home', 'My Services', 'Tools', 'Printing Activities', 'Import-Export', 'UPS.com', and 'Support'. Below this is a 'Navigate' section with icons for 'History', 'Create a Return', 'Multi-piece Shipment', 'Save Shipment', 'Repeat', 'Undo', 'Void', 'Track', 'Addresses', 'End of Day', 'Pickup Information', and 'Messaging Center'. The main form is divided into several sections: 'Ship To' (Customer ID, Company or Name, Attention, Address 1-3, Country/Territory, Postal Code, City/Town, State/Province/Country, Telephone, E-mail Address, UPS Account Number, Tax ID Number), 'Ship From' (Update Address Book, Residential), 'Service' (Freight, World Ease, UPS Service: Ground, Need it there sooner?), 'Package' (Package Type, Length, Width, Height, Declared Value, Customer PO # / RMA #, Outbound GL Act #), 'Bill Transportation To' (Shipper), 'With Return Services', 'Shipper's Cost (USD)' (0.00), 'Weight (lb)' (Package: 0.0, Shipment: 0.0), 'Electronic Scale Activated', and 'Detail Cost'. At the bottom, there are buttons for 'Add', 'Delete Pkg', and 'Process Shipment F10'.

- Access to full portfolio of UPS shipping services (including link to freight shipping)
- Ability to print “smart” shipping labels with two printed reference numbers and one bar-coded reference number or a company logo
- Import and export of shipping data to/from other business applications with Online Connect functionality including a “hands-off” shipping option
- Shipping profiles to customize preferences and defaults
- Full export documentation support
- Street-level address validation
- Reference field capability of over 20 characters
- Shipping history with tracking and signature proof of delivery through ups.com
- Ability to process shipments with a future pickup date
- Configurable shipment detail report



- Display of UPS published rates or custom rates
- Ability to print shipment/package documentation labels.
- Ability to order supplies
- Distribution list processing.
- Local Area Network installation to support multiple workstations
- Users can easily track UPS packages through their UPS WorldShip shipping software or hardware.

While UPS's core technology offerings are filled with features that meet most shipping needs, occasionally a more robust solution is needed. For more specialized needs the following solutions are available for a fee:

iShip®

When your organization spans a number of different locations, managing shipping activities across the enterprise can seem particularly challenging. iShip can eliminate these challenges with shipping solutions that can be used at any location, yet have centralized data. iShip is a software as a service model with several different corporate shipping solutions that support UPS shipping. All rates, business rules, route data and fuel surcharges are updated automatically and coincide with carriers' effective dates.

No matter where users are located, iShip provides managers and administrators complete control and visibility into their shipping activity and allows you to define shipping procedures, approve carriers and rates and set shipping rules. iShip becomes the centralized "mailroom" that serves everyone in your multi-location organization.

iShip's highly configurable solutions are an important advantage for any industry. It will help reduce shipping costs by:

- Limiting specific services and options available for selection
- Reducing delays and charges due to incorrect addresses
- Accurately determining shipping costs that can be later billed to customers
- Ensuring discounts and special rates are used

iShip provides you shipping insight. You see your shipping costs upfront before printing a shipping label. You can track shipments to delivery. Integrated reports and data extracts across the entire enterprise help you audit and manage shipping practices.

ConnectShip®

Businesses with locations across the country and around the globe find managing enterprise wide shipping activities increasingly complex and challenging.

ConnectShip, a UPS subsidiary, offers customers a way to integrate and centrally manage their organization's shipping decisions. Products within ConnectShip are designed to meet the specific needs of companies in a range of shipping environments.



Response to Solicitation

#CH21-36

ConnectShip® Toolkit is a set of Application Programming Interface (API)-based tools that delivers total order visibility for companies with complex, growing, multi-carrier shipping environments. This centrally administered and server-based global solution for international origin and destination support provides visibility from order entry to carrier pickup. ConnectShip Toolkit also generates and prints documents and labels required by users and integrated carriers.

The ConnectShip suite of applications gives customers the range of tools they need to manage a multi-carrier environment efficiently. ConnectShip makes it possible for companies to take full advantage of the shipping options available to them by making it easier for users to:

- Make informed choices about carriers
- Integrate individual carrier compliance into existing systems
- Improve shipping system functionality across an organization

Backed by the UPS global network, ConnectShip helps companies make sense of a complex, challenging shipping environment.

UPS no-cost Visibility tools help you to see more so that you can do more.

UPS Tracking provides shipment status at ups.com, via the UPS Mobile™ app or by calling 1-800-PICK-UPS®. Keep you and your customers informed of package progress by tracking a shipment from pickup to delivery on ups.com. With UPS Tracking, you can get instant status on up to 25 package shipments at once, free of charge. Use your UPS tracking number or a reference number of your choice to determine the status of your shipments in the UPS system.

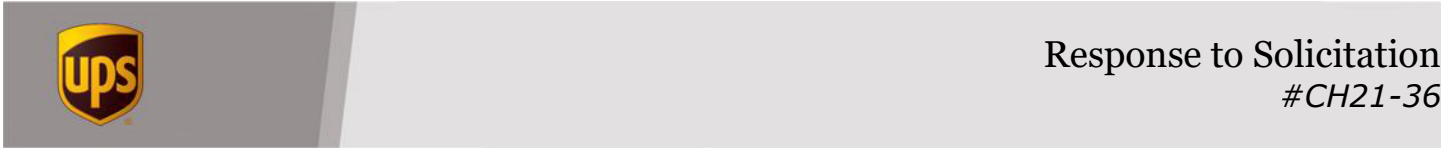

Log Out | Locations

ups QUICK START Tracking Shipping Services

Home > Tracking > Track & Tracking History

Tracking

TRACK PACKAGES & FREIGHT UPS MY CHOICE® QUANTUM VIEW FLEX GLOBAL VIEW

Track by Number —

Tracking or InfoNotice Numbers: ⓘ

Enter up to 25 tracking or InfoNotice numbers, one per line.

Track

Track by Reference +

Track by E-mail +

Import Tracking Numbers +

SMS Tracking +

RECENTLY TRACKED LAST UPDATED: 6:56 A.M., 10/26/2017

Tracking Number	Description	Status
1Z070AE20369495354	Click to add a description	Delivered ⓘ
1Z1888006679134238	Click to add a description	Delivered ⓘ
1Z1888000383070274	Click to add a description	Returning to Sender ⓘ
1Z1888000378731042	Click to add a description	Delivered ⓘ
1Z2578600100110175	Click to add a description	Delivered ⓘ
1Z2578600300000647	Click to add a description	In Transit ⓘ
1Z2578600300000638	Click to add a description	In Transit ⓘ
1Z2578600300000629	Click to add a description	In Transit ⓘ
1Z2578600300000610	Click to add a description	In Transit ⓘ
1Z2578600300000601	Click to add a description	In Transit ⓘ
1Z2578600300000594	Click to add a description	In Transit ⓘ
1Z2578600300000585	Click to add a description	Delivered ⓘ
1Z2578600300000576	Click to add a description	Delivered ⓘ
1Z0147W4847747303	Click to add a description	Delivered ⓘ

Track Selected Save Selected Remove Selected

UPS Quantum View®

Quantum View is a suite of visibility services with proactive email updates, available at no cost to U.S.-based UPS accounts. Easily monitor the status of outbound or inbound UPS shipments from the time the shipment is initiated until final delivery. Retain shipment information after delivery so you are able to review your recent history of UPS shipments.

To better meet the needs of customers, UPS has developed three applications under the Quantum View umbrella which can be mixed to tailor the needs of its users.



Response to Solicitation #CH21-36

UPS Quantum View® Manage is a web-based application that allows customers to view shipment information for multiple accounts without a tracking number. Users can create customized views of shipment history for outbound and 3rd party billed shipments (inbound is available using LIDS-Locations ID's or UPS addressing matching solution) and can receive e-mail shipment status and/or download selected shipment data.

UPS Account	Manifest	In Transit	Out for Delivery	Ready for Pickup	Exception	Delivered	Void	Total
	1282	196	68	0	4	5001	0	6551
	2	0	0	0	0	5	0	7
	27	143	15	0	7	3113	1	3306
	41	10	0	0	0	185	0	236
Totals:	1352	349	83	0	11	8304	1	10100

UPS Quantum View® Data delivers proactive critical package status updates via data files over the Internet for a customer's or a supplier's inbound and/or outbound packages. Data files are delivered via the web in .csv, .txt, or XML formats and are easy to integrate into internal software applications or databases. This service targets large customers who want to integrate this data into their own ERP, CRM or other systems.

UPS Quantum View® Notify delivers proactive critical package status updates via e-mail. This service targets our customers who want UPS to proactively notify interested parties about critical package status updates for some or all of their packages.



Log Out | Locations

QUICK START ▼ Tracking Shipping Services

Quantum View Manage

SHIPMENT DETAILS

Displaying 1821

Add/Remove Fields ⓘ E-mail Download as CSV Grid Expand/Collapse

Reference Number(s)	Status	Manifest Date	Ship To	Service	Scheduled Delivery
51988133	Delivered	09/29/2017	GRAYBAR ELECT CO 5818836, CLEVELAND, OH, US	UPS Next Day Air	10/02/2017
51995211	Delivered	09/29/2017	AMERICAN ELECTRIC CO, WICHITA, KS, US	UPS Next Day Air	10/02/2017
51995206	Delivered	09/29/2017	VALLEN DISTRIBUTION INC, NORCROSS, GA, US	UPS Next Day Air	10/02/2017
51995202	Delivered	09/29/2017	MEMO CHARGE ACCOUNT, KINGSFORD, MI, US	UPS Next Day Air	10/02/2017
51995209	Delivered	09/29/2017	INDUSTRIAL COMBUSTION, MONROE, WI, US	UPS Next Day Air	10/02/2017
51995207	Delivered	09/29/2017	ALL PHASE ELEC SUP CO, SPRINGFIELD, OH, US	UPS Next Day Air	10/02/2017

Quantum View® Manage for Importers provides visibility for all UPS Small Package, international and domestic package delivery services by both ground and air.

Quantum View® API is a Web-based service that provides shipment manifest information, status updates, and event alerts for your inbound and outbound shipments. You can see UPS packages sent by multiple vendors to receiving locations across your organization and information about shipments sent using your UPS Accounts. Integration of the Quantum View API requires information technology resources familiar with XML.

UPS My Choice® – As more employees continue to work from home, UPS offers UPS My Choice®. We will let you know when your home deliveries are on the way. UPS My Choice® service gives you more flexibility over eligible home deliveries, with delivery alerts to give you status updates and the ability to change the delivery date or address to fit your needs.

6. Shipment of Materials:

- a. Describe the process for picking up dangerous, Hazardous or Otherwise Restricted Materials: Carrier shall be capable of shipping a variety of hazardous, dangers or other restricted types of materials. Offeror shall provide its policy for dangerous, hazardous, and restricted materials.

UPS has an online [Guide to Shipping Ground and Air Hazardous Materials](#) to help streamline the process. The guide is meant to accomplish the following:



- This online UPS Guide for Shipping Ground and Air Hazardous Materials replaces previously printed publications
- Inform you of chemical additions, deletions, and changes in classification
- Allow you to download the entire hazardous materials chemical table
- Present information regarding UPS's contract-only hazardous materials service
- Provide the latest updates required of all shippers who send hazardous materials through UPS

UPS accepts hazardous materials on a [contract basis only](#), servicing the U.S. and [specific locations outside the U.S.](#) Within the U.S. and Puerto Rico, UPS accepts non-bulk quantities of hazardous materials for transport by highway and rail, or air modes when prepared in accordance with the U.S. Department of Transportation (DOT) Hazardous Materials Regulations (HMR). UPS also accepts air shipments in accordance with regulations issued by International Civil Aviation Association (ICAO) and published as the Dangerous Goods Regulations (DGR) by the International Air Transport Association (IATA). For the purposes of regulatory compliance, U.S. air service levels include UPS Next Day Air, UPS 2nd Day Air, UPS 3 Day Select, within the U.S. and International Express and Expedited Services internationally. This UPS Guide for Shipping Ground and Air Hazardous Materials should always be used in conjunction with the most current version of the HMR in Title 49 of the Code of Federal Regulations (49 CFR), and the most current version of the IATA DGR. Shippers must also comply with the [UPS Tariff Terms & Conditions of Service](#).

UPS transports hazardous materials within and between the 50 United States and Puerto Rico. Hazardous Materials Contract Service is available for customers with a Scheduled Pickup account. Scheduled Pickup options include: Daily Pickup, Daily On-Route Pickup, Day-Specific Pickup, and UPS Smart Pickup® service. UPS does not accept hazardous materials shipments requiring shipping papers at UPS® Customer Centers, The UPS Store® locations, air letter centers, authorized shipping outlets, commercial counters, or using Internet shipping. Ground shipments of ORM-D and limited quantity materials in the 48 contiguous United States may be accepted at some locations. For more information regarding restrictions, hazardous materials shipping, and shipping dangerous goods beyond the United States and Puerto Rico, please see the UPS Guide for Shipping Ground and Air Hazardous Materials and the UPS Tariff/Terms and Conditions of Service available online at [ups.com](#).

The shipper may ship hazardous materials identified in the [UPS Hazardous Material Chemical Tables](#) in compliance with all applicable DOT and/or IATA regulations, as well as the specific UPS Limitations identified within this Guide for Shipping Ground and Air Hazardous Materials. Details on requirements for shipments with an origin or destination outside the U.S. are available through the [Shipping Dangerous Goods Globally](#).

In some cases, UPS requirements are more restrictive than those of the DOT and IATA. UPS's "conditions incident to transportation" may differ from those of other carriers' systems due to the distinct UPS methods for sorting, handling, and moving packages. Accordingly, UPS expects all shipments to be capable of passing the International Safe Transit Association (ISTA) Procedure 3A.

Time-in-transit guarantees do apply to hazardous material packages.



General Information:

- All hazardous materials shippers must process their shipments using a UPS-compliant shipping solution in conjunction with hazardous materials shipment preparation software. Shippers may use the current version of UPS-provided [WorldShip](#) in order to be compliant with existing regulatory requirements, or purchase approved [third-party software](#). Customers who do not comply with regulations or UPS variations may no longer be able to ship hazardous materials packages via UPS.
- UPS accepts both "Passenger Aircraft" quantities (PAX) of hazardous materials and "Cargo Aircraft Only" (CAO) quantities offered for transport in UPS Air Service levels. Refer to the most recent copy of the [UPS Chemical Tables](#) for additional requirements. CAO shipments of materials outside of Class 9 require a specific, additional contract agreement.
- For each hazardous materials package, UPS requires shippers to affix an authorized UPS Shipping Paper or Shipper's Declaration (for IATA shipments, three copies of the DG Dec are required) to each package, and to complete an entry in the UPS Shipper's Certification of Hazardous Materials (end of day manifest for hazardous materials). Each UPS driver receiving hazardous materials must also receive a hard copy of the Shipper's Certification representing those hazardous materials shipments. The transfer of electronic data about the hazardous materials shipments does not replace the UPS Shipper's Certification of Hazardous Materials.
- Fully regulated hazardous materials packages in domestic U.S. service must not exceed 70 lbs. gross weight. Shipments with origin or destination outside the U.S. must not exceed 30 kg gross weight. The [UPS Chemical Tables](#) may apply lower package limits in some circumstances.
- To conform to DOT standards, the "Emergency Contact Number" field on a shipping paper is limited to the numeric telephone number, including any applicable country code or international access codes. The only alphabetical characters allowed in this field are "EXT" when an extension must be included, or "OPT" when a caller must select an option number. Additional non-alphabetical characters that may be included are: period (.), dash (-), plus sign (+) and conventional parentheses. All other information relevant to the emergency telephone number must be presented in the "ER Registrant" field.

Mode-Specific Requirements:

- For the purposes of regulatory compliance within the U.S., **air** service levels eligible for dangerous goods include all UPS Next Day Air services, all UPS 2nd Day Air services, and UPS 3 Select service. **Air** service levels for export packages are UPS Express and UPS Expedited services. Accordingly, all packages offered at these service levels must comply with applicable air regulations.
- While hazardous materials service (including carriage of PAX quantities and Class 9 in CAO quantities) is offered by contract only, UPS requires a specific additional contract for acceptance of "cargo aircraft only" shipments outside of Class 9. Refer to the current [UPS Chemical Tables](#) for additional detailed requirements.
- Pickup service for hazardous materials is restricted in some areas of Alaska and Hawaii. Delivery of hazardous materials is not possible in some areas of Hawaii. Delivery of CAO shipments is not possible in some areas of Alaska. Refer to the [Approved Countries or](#)



[Territories List](#) for more detail.

- Ground Service level for Hazardous Materials, including Limited Quantity, combustible materials and Lithium Batteries (Fully and Lightly Regulated), is not available for shipments to or from the following areas: Alaska; Hawaii; Puerto Rico; Avalon, CA; Catalina Island, CA; Beaver Island, MI; Mackinac Island, MI (winter only); The Bass Islands, OH; Kelley's Island, OH; and San Juan Islands, WA. All non-hazardous Ground service level packages to or from these locations must be suitable for carriage aboard aircraft.

Class-Specific or Commodity-Specific Limitations:

- For cigarette lighters or similar devices, UPS does not permit the use of the exception stated in 49 CFR 173.308(e). To be transported in the UPS system, these devices must be fully declared, requiring shipping papers, proper packaging, marking, and labeling.
- The DOT's exceptions for combustible liquids, including those identified in 49 CFR 175.310, do not apply for any **air** service level shipments in the UPS system.
- **Ground** service level shipments of Division 4.3 (Dangerous When Wet) prepared under Limited Quantity provisions will not be accepted with the "DANGEROUS WHEN WET" hazard label.
- Materials in Division 5.2 (Organic Peroxides) are not accepted in any UPS **air** service level.
- For many materials, UPS requires the use of appropriate DOT special permit packages or packaging complying with 49 CFR 173.13. Affected classes are:
 - All fully regulated shipments assigned to P.G. I or II of Division 6.1 (Toxic Substances), when offered at **air** or **ground** service levels, and
 - All fully regulated shipments of Division 4.3 (Dangerous When Wet) materials, when offered at **air** or **ground** service levels.

Ground service level shipments assigned to Division 6.1 (Toxic Substances), prepared under Limited Quantity provisions, will not be accepted with "TOXIC" or "POISON" hazard label.

Air and **ground** service level shipments of Division 6.1 (Toxic Substances), PG III must be labeled in one of the following methods:

- With the notation "PG III" appearing on the diamond hazard label in accordance with 49 CFR 172.405(c); or
- With the notation "PG III" appearing immediately adjacent to a "TOXIC" or "POISON" label.

Air service level shipments of Division 6.2, Category A Infectious Substances are accepted upon completion of a contract dedicated to this particular class of material. UPS can accept Category A Infectious Substances only in U.S. domestic Next Day Air services.

UPS does not accept any shipments of materials described as Toxic Inhalation Hazard materials. See 49 CFR 171.8 for more details about such materials.

Air service level shipments of UN3090, Lithium metal batteries or cells can be accepted only from approved shippers. To apply for approval, follow the pre-approval instructions found on ups.com Lithium Metal Battery Shipper Pre-Approval. In addition to the approval, UPS requires the Cargo Aircraft Only (CAO) Handling Label on all **air** service level shipments of UN3090, Lithium Metal Batteries or Cells.



Air service level shipments of UN3480 (Lithium ion batteries) or UN 3090 (Lithium metal batteries) must be presented as fully regulated hazardous materials.

Air service level shipments of UN3171 (Battery-powered vehicle) will only be accepted under the following conditions:

- Restricted to PAX quantities only, not accepted as CAO.
- Each package is limited to a maximum gross weight of 30kg.
- For a vehicle containing one or more lithium batteries that would separately be classified as UN3480 (Lithium ion battery) or UN 3090 (lithium metal battery), the battery or batteries contained in the vehicle are limited to 5kg maximum net weight per package.
- For shipments of UN3171 powered by lithium batteries, UPS requires the additional marking, "Contains Lithium Batteries." The marking must meet the requirements as stated in 49 CFR 172.301(a)(1) and be near the proper shipping name.
- For shipments of UN3171 containing one or more wet, non-spillable batteries that would separately be classified as UN2800 (Battery, wet, non-spillable), the battery or batteries contained in the vehicle are limited to 25kg maximum net weight per package.

Damaged, Defective, or Recalled (DDR) Lithium Batteries are prohibited from **air** service level shipments. This includes batteries shipped alone, packed with the equipment, contained in equipment, or battery powered vehicles (UN3171). UPS ground service of DDR lithium batteries is offered in the contiguous 48 U.S. only; this service requires a specialized service agreement and shipper pre-approval. Please contact your UPS Business Development representative for support.

Packaging:

UPS requires that all packages, including those containing hazardous materials, be *capable* of meeting the requirements of the ISTA Procedure 3A testing protocol. Hazardous materials packages must also satisfy applicable specification and performance requirements of 49 CFR parts 173 and 178, or IATA Section 5.

Hazardous materials may not be shipped in UPS-provided packaging, such as Letters, Boxes, Paks and Tubes.

Dedicated UPS Paks are available to use as overpacks for UN3373 (Biological substances, category B) and for Exempt human *or* animal specimens.

Packages containing hazardous materials must not be banded, taped or strapped together.

For many materials, UPS requires the use of appropriate DOT special permit packages or packaging complying with 49 CFR 173.13. Affected classes are:

- All fully regulated shipments assigned to Division 6.1 (Toxic Substances - PG I or II), when offered at **air** or **ground** service levels, and
- All fully regulated shipments of Division 4.3 (Dangerous When Wet) materials, when offered at **air** or **ground** service levels.

To avoid confusion about the type of packaging used for fully regulated shipments of Division 4.3 (Dangerous When Wet) or 6.1 (Toxic Substances - P.G. I or II), UPS does not allow these packages to be overpacked.



Response to Solicitation

#CH21-36

Hazardous materials shipments authorized for strong (i.e., non-specification) outer packaging that require a shipping paper must be in outer packages at the following minimum levels (overpacks are excluded from this requirement):

- Packages must be in a minimum 200 lbs. Burst Strength or 32 Edge Crush Test (ECT) certified box. The box must also be of sufficient strength to protect the contents while in transit; or
- Any non-specification package that displays the ISTA seal indicating the package has been tested and certified to ISTA Procedure 3A is not subject to the minimum ECT or burst strength requirements.

Hazardous materials may be offered in authorized single packaging, subject to the following conditions:

- May be offered for **ground** service level only in the 48 contiguous States.
- May be offered for **air** service level only as Cargo Aircraft Only (CAO) shipments. (Applies to commodities other than Dry Ice.)
- Bags and other single packaging constructed of light gauge metal will not be accepted.
- Orientation arrows not required on single packaging.
- Additional handling charges may apply.

Note: Cylinders must be overpacked in a container of suitable strength to retain its shape and protect operating mechanisms. Round tubes or overpacks are not accepted.

Please call the Hazardous Materials Support Center at 1-800-554-9964 for any questions about shipping hazardous materials with UPS.

- b. **Evidentiary Materials:** Describe the process and tracking for evidentiary materials. Also, describe an instance and detail the approach taken when the Carrier's process needed to be modified for a participating state's laws, policies, or procedures. Alternatively, describe how Carrier would approach modifying their process for an Authorized User based on the user's laws, policies, or procedures. Note: Offeror must be able to provide services for shipments of evidentiary materials in compliance with any participating state's laws, policies or procedures.

UPS appreciates state and local law enforcement's needs of reliable transportation for evidentiary materials and is proud to serve as it is able. However, there are legal, ethical, size, and safety considerations that may hinder our ability to carry certain items. UPS reserves the right to refuse to provide service for any package, which by reason of the dangerous or other character of its contents, may, in the sole judgment of UPS, soil, taint, or otherwise damage other packages or UPS's equipment, or harm or otherwise affect the safety and/or security of UPS employees, or which is improperly or insecurely packed or wrapped. Packages must be packed or wrapped to meet UPS's published standards (found in the UPS Rate & Service Guide and UPS Tariff/Terms & Conditions of Service available online at ups.com). UPS does not accept for transportation any shipment that contain:

- Articles of unusual value
- Hazardous waste
- Human remains, fetal remains, human body parts, or components thereof
- Common fireworks
- Packages that exceed size limitations



- Packages presented for shipment at authorized shipping outlets that contain firearms, ammunition, or any hazardous materials requiring shipping papers.

For details regarding other limitations on shipping, please see the UPS Tariff/Terms and Conditions of Service available online at ups.com.

For State Agencies and Authorized Users that require more secure options, UPS Express Critical is available under separate terms and conditions.

7. Deliver as Addressed:

When requested, Offerors must return undeliverable packages to senders, rather than performing an address correction and forwarding the package to an address. Offerors shall work with Authorized User's to adequately identify these items as "deliver as addressed" or something similar in language mutually agreed upon between the State and the Offeror rather than forwarding an undeliverable package. Authorized Users shall notify Offerors of such packages.

An address validated by UPS to be incorrect or incomplete for purposes of completing delivery may be corrected and delivered by UPS. The shipper will be assessed an address correction fee. UPS will provide the available address on the shipper's weekly invoice so that databases can be updated.

Using the value added service, Direct Delivery Only, Agencies and Authorized Users can apply delivery restrictions on an individual package at the time of shipping. UPS will make three delivery attempts at the consignee address. After a third unsuccessful delivery attempt, the package will be returned to sender. Additional details and restrictions are located in the UPS Rate & Service Guide and UPS Tariff/Terms & Conditions of Service.

Domestic packages refused by the consignee, or which are undeliverable for any reason, will be returned to the shipper at the shipper's expense. Return service level will be UPS 3 Day Select for Air Services and UPS Ground for UPS Ground shipments at the applicable rate. All applicable surcharges apply to any return.

The UPS Service Guarantee does not apply to undeliverable packages returned to the shipper.

2. Prior Experience

- a. Offeror must submit a list of states where they have done business in the last twelve (12) months along with Account point of contact information for each state/area. This includes their name, phone number and email. The State reserves the right to reach out to any state and collect past performance information that can be used to evaluate past performance.

See Section 3 - Confidential, Protected or Proprietary Information.

- b. Offeror shall demonstrate an established, successful track record of past performance in duties and responsibilities related to domestic and if applicable international transportation services specified herein. This can be established by providing a copy of reports such as a Carrier annual report, report to Surface Transportation Board, or balance sheets and income and expense statements.



UPS 2019 Annual Report has been provided.

- c. Offeror shall provide documentation of on time and late delivery performance for express small package air and small parcel ground services for the past twelve (12) months.

See Section 3 - Confidential, Protected or Proprietary Information. This information is specific to each of the participating states we have executed agreements.

It is against our corporate policy to provide our total company shipment integrity rate, however, reliability is the cornerstone of the UPS® brand promise. UPS guarantees on-schedule delivery of each package shipped. UPS has been ranked very high in customer satisfaction for domestic air, ground, and international delivery according to JD Power and Associates® Small Package Delivery Service Business Customer Satisfaction Study.

On request, we will provide this data directly to the states and Authorized Users during quarterly performance reviews.

4. Dispute Resolution

a. Package Security

- i. Describe the procedures in place to ensure packages are secure and tracked during transport. Explain a situation where the package being shipped needs special handling due to the contents being shipped. How did the Offerors' policies, driver training, customer service all assist in that process? If there were challenges explain those too.

For a more detailed overview, please refer to the UPS Package Security Profile.

Each package shipped through the UPS network is assigned a dedicated UPS tracking number when the shipper creates the UPS label. This barcoded tracking number allows UPS to scan the package throughout its transit within the UPS network.

We capture package movement information each time we scan a tracking label in the UPS delivery system. Common scans include the following:

- Order Processed: Ready for UPS – UPS has received the electronic transmission of package detail from the shipper (This does not necessarily mean that we have taken possession of the package.)
- Origin – We scan the package at the origin UPS location
- Departure – We scan the package as it leaves its present location and is on its way toward the destination address
- Arrival – We scan the package as it arrives at an intermediate sort facility or the destination facility
- Out for Delivery – We scan the package when it reaches the facility that is responsible for delivering the package – this is a package's last stop before delivery
- Delivery – When we deliver the package, we record the date and time of delivery
- Exception – If we cannot deliver the package, or its delivery is delayed, we note the reason



When shipping certain electronic media containing sensitive, personal information (such as personal, financial or health information), we recommend that you do not use an envelope, letter packaging, UPS Express® Envelope, UPS Express® Pak, or UPS Express® Pad Pak. Package the electronic media with a duplicate shipping label in an inner container that can be securely sealed. Place the inner container in a new outer corrugated box (double box). Seal all flaps securely. Prior to packaging, mark the electronic media with identifiable information such as your company name, reference number, or your UPS shipping number. Additionally, you should retain a copy of the data and secure the data on the electronic media through encryption or other technological means.

- ii. Offeror shall demonstrate how sensitive packages are kept secure and are delivered properly and timely.

Sensitive packages are kept within the UPS package car until it is brought to the UPS facility. Once at the UPS facility the packages are unloaded, accounted for, and introduced to the UPS network to flow to final destination. Time in transit is designated based on the service level requested by the shipper.

b. Security Protocols

- i. Offeror shall provide all security protocols followed and how they shall conform to security protocols by State Agencies.

UPS delivery personnel are issued UPS authorized uniforms. Delivery personnel are not allowed to make scheduled pick-ups or stops without the proper UPS uniform. The issuance and use of UPS uniforms is strictly monitored and controlled. UPS personnel follow established security protocol that does not interfere with the safety of our employees.

- ii. Describe the security protocols in place if a package or a driver runs in to a Security issue, i.e., the package is an issue or any other scenario.

UPS drivers will immediately notify law enforcement (if necessary) and direct management team. Management team will involve additional support as needed.

c. Offeror to describe how they handle issues and disputes.

We have provided guidance on how to raise concerns regarding service issues, claims and invoice disputes online and through contact with our Enterprise Support team. Disputes regarding contractual issues should be raised with the Enterprise Sales Resource or UPS's contract manager. Concerns will be reviewed against the terms and order of precedence agreed upon. It is our goal to arrive at a solution that supports both parties' interests.

- i. Offeror shall provide a 24/7 customer service center and escalation contacts for States. Offeror shall detail how users would dispute and/or submit a complaint to customer service.

UPS Enterprise Support team can be reached:

(800) 877-1497

Monday- Friday 7:00 am – 12:00 am EST

Saturday 7:30 am – 6:00 pm EST

enterprisesupport@ups.com



Each state's Enterprise Sales Resource serves as the emergency escalation contact.

Users can email or contact our Enterprise Support team. A support representative will assist with any disputes and customer complaints. This customer support team will provide full coverage so that NASPO ValuePoint Authorized Users will not encounter gaps in coverage that may occur due to for vacations, illness, etc. This has proven to be a better option than having one dedicated person.

ii. Offeror to describe how they handle issues and disputes with customers including billing issues.

UPS offers several ways to request a shipping charge adjustment. Notification to UPS of a request for an invoice adjustment must be made in writing within 180 days of receiving the contested invoice, using one of the following methods:

- Submit a request through the UPS Billing Center at ups.com/billing.
 - Log in to the UPS Billing Center
 - Select the invoice number for which an adjustment is needed
 - Select the invoice summary
 - Select the shipment/charge detail
 - Select total amount
- Email the request for an invoice adjustment to UPS through ups.com® using the "Support Category" "billing"; or
- Mail UPS a written request to United Parcel Service, P.O. Box 7247-0244 Philadelphia, PA 19170-0001. The notification to UPS must include the date of shipment and tracking number for each disputed charge as well as the reason for the disputed charge.

The notification to UPS must include the date of shipment and tracking number for each disputed charge, as well as the reason for the disputed charge. A partial payment against an invoice is not considered a request for an invoice adjustment or notice to UPS of a disputed invoice. UPS reserves the right to refuse to issue any invoice adjustment until all outstanding charges owing to UPS have been paid in full.

View Adjustments/Disputes

- You can view adjustments made on any invoice: Select Invoice from the Invoice drop-down menu. An icon will appear in the Dispute column if a dispute has been requested.
- Select the dispute icon to view dispute details.
- How Adjustments/Disputes are Applied to Your Account
- Adjustments on Delivery Service Invoices will be applied to the next invoice. International Package Service invoice adjustments will be applied to the current invoice.

Note: After adjusting a shipping charge, you will be required to pay the total outstanding amount due. The adjustment will be reviewed by a UPS Representative. If the UPS Representative approves the adjusted amount, the following will occur:

Delivery Service Invoices (Domestic/Export invoices) - Your next invoice will be reduced by the approved adjusted amount.



International Package Services Invoices (Import invoices) - Your current invoice will be reduced by the approved adjusted amount.

The ability to challenge the amount invoiced is conditioned upon full compliance with all the requirements regarding set forth in the UPS Tariff/Terms and Conditions of Service.

5. Handling State Emergencies

- a. Describe how the Offeror's company has responded to any state that had a specific emergency or if an emergency has affected the nation. Include an example that includes but not limited to when the Offeror's company needed to adjust operations to accommodate a need, how communications with the customer worked, some challenges that were worked through and how well the outcome was for the Offeror and the end user.

The global pandemic has driven UPS to accelerate the development of new and creative solutions to ensure our customers get what they need, when and where they need it. This has been UPS's response as we continue to support federal and state governments, big box and small businesses. On a national level, an example of a challenge and how we responded occurred just prior to the vaccine rollout. Just when it seemed everything was in place for UPS's plans to help distribute COVID-19 vaccines, one more logistical problem had to be solved.

Putting the cold in cold chain

It's been widely publicized that certain COVID-19 vaccines must be kept at ultra-cold temperatures during transit. But what's rarely mentioned is many facilities expected to distribute these vaccines are not set up to maintain the doses at the required temperature once they arrive.

One solution? Send supplemental shipments of dry ice within 24 hours of vaccine delivery, so the doses can be re-iced – something easier said than done.

No time to lose

When a UPS manager in thermal packaging, was asked to develop a re-icing solution for ultra-cold vaccines, it was the week before Thanksgiving. And there were plenty of obstacles to overcome to put a plan in place by November 30th.

That meant the immediate acquisition of thermal coolers, dry ice and corrugate, which were already in high demand due to the pandemic. Working with our strategic partners, we were able to negotiate with companies to obtain the needed materials including printing branded packaging, a process that normally takes two to three weeks, had to be completed in days.

Location, location, location

Another hurdle was ensuring that shipments of dry ice could be delivered to dosing locations in every state and territory within one day. UPS is the only common carrier capable of making that happen.

But sending all the shipments via Next Day Air wasn't an option due to limits on how much dry ice is allowed on each flight. Therefore, hubs in Louisville, Dallas/Ft. Worth and Fontana, California were selected so UPS could move the re-ice packages through its air and ground network meeting next day commitments. Setting up three packing centers in a short amount of time is a uniquely demanding challenge.



Precious cargo

Communication is critical. On a call with the project's operators and suppliers, the Project Lead stressed the importance of what they were doing together. Failure could mean that people don't get vaccinated or have to wait. Even the small decisions could have an impact on people's lives.

To ensure they're highly visible, UPS's re-icing shipments feature UPS Healthcare branded packaging and UPS Premier gold tags to ensure special handling and detailed tracking.

In good hands

This re-icing service will continue to evolve as feedback comes in from dosing centers and as carriers learn more about how vaccines need to be handled.

UPS's Enterprise Sales Resource, Healthcare and our local operations teams worked closely with the states' Departments of Health to distribute PPE and vaccines to hospitals, nursing homes and designated distribution sites. While the majority of these shipments went off without a hitch, there were some lessons learned. Understanding the customer's specific need continues to be critical to a successful outcome.

- b. Offeror shall agree to provide next day pick up/shipping on any pick-ups or deliveries on packages deemed critically necessary to meet the needs and demands of declared State emergencies.

UPS can generally comply with this requirement, as demonstrated by the recent pandemic. To the extent UPS is able at the time of shipping, UPS will make commercially reasonable efforts to serve its customers in their most critical times of need.

- c. Offeror shall agree to provide a dedicated point of contact to assist State emergency contact persons in determining the best shipping method and any additional shipping requirements needed for being shipped.

State representatives work directly with their Enterprise Sales Resource to share critical details, i.e. how soon the shipment is needed and the location where the shipment will be delivered.

- d. Offeror shall work alongside State emergency contact persons to provide any needed reports for Federal Emergency Management Agency reporting requirements.

UPS is proud to serve as a federal contractor and understands the importance of compliance with the requirements of federal agencies. The Enterprise Sales Resource assigned to the state contract will work with state contacts to provide commercially available reports as UPS generally provides to its customers.



6. Data Security

- a. Offeror shall describe in detail what measures are taken to protect sensitive customer information.

We understand the importance of customer confidentiality and data security. UPS manages and secures data, including personally identifiable information (PII), in a manner that complies with applicable laws and regulations.

For information concerning UPS information practices, please review the UPS Privacy Notice at ups.com. UPS complies with its Information Privacy program as set out in this Notice. We have also provided more in-depth detail in the submitted document, UPS Information Security Program Overview.

Extra steps should always be taken when tendering sensitive information to carriers. Section 8, Packaging, in the UPS Tariff/Terms & Conditions of Service contains the rights and obligations of the carrier and shipper in regard to package contents. Following packaging best practices helps to minimize risk of exposure as the contents of the shipment are not protected. When shipping certain electronic media containing sensitive, personal information (such as personal, financial or health information), we recommend that you do not use an envelope, letter packaging, UPS Express® Envelope, UPS Express® Pak, or UPS Express® Pad Pak. Package the electronic media with a duplicate shipping label in an inner container that can be securely sealed. Place the inner container in a new outer corrugated box (double box). Seal all flaps securely. Prior to packaging, mark the electronic media with identifiable information such as your company name, reference number, or your UPS shipping number. Additionally, you should retain a copy of the data and secure the data on the electronic media through encryption or other technological means.

UPS's InfoSec organization oversees all information security issues for UPS's business operations. The InfoSec organization establishes security policies and standards, make sure UPS is compliant with security regulations, and maintains security controls designed to prevent accidental, unauthorized or unlawful access, destruction, disclosure, alteration, or loss of UPS's Information assets and infrastructure. The UPS InfoSec organization is headed by the Chief Information Security Officer (CISO). For more specific detail, please refer to UPS Information Security Program Overview.

- b. Demonstrate the data security policies in place if data was breached. How is the customer notified and if the customer finds a breach, how do they notify the Offeror?

See Section 3 - Confidential, Protected or Proprietary Information.

- c. 'Click-through' or Terms of Use Agreement

If access to the Offerors' system or partnering system requires users to agree to Terms of Use or similar 'Click-Through' style agreements, copies of those agreements must be included in the RFP response.

Please see attached the current version of the terms and conditions of use for UPS no-cost technology, UPS Technology Agreement, and website, Website Terms of Use. Use of no-cost



technology is an auxiliary solution provided under separate terms and conditions, which are subject to change without notice.

7. Drop Boxes and Shipping Supplies

- a. Offerors must agree to place package collection receptacles in convenient locations within Participating States and describe other centralized package collection procedures available. Collection receptacles must be of sufficient size to contain 8 1/2" x 11" sheets of paper, without folding, up to the weight limit for various categories. The Offeror shall provide express pack boxes and express tubes to Participating States at no cost. The Offeror shall provide requested materials and supplies within 48 hours of request, except for pre-printed shipping forms. Pre-printed shipping forms are the Offeror's shipping forms pre-printed with an Authorized User's address and billing information. Note: Any pre-printed Terms and Conditions on any Offeror forms, which are inconsistent with the Terms and Conditions of the Master Agreement and any Participating Addendum are rejected and do not modify, change or replace the Terms and Conditions of this Master Agreement or subsequent Participating Addenda.

In addition to our 91,000 drivers, UPS currently offers customers over 48,000 access points through drop boxes, retail outlets, and customer centers. Customers can find local access points by calling 1-800-PICK-UPS or accessing the UPS Drop-Off Locator online at ups.com.

- 1,000 UPS Customer Centers
 - 3,600 Authorized Shipping Outlets
 - 38,000+ UPS Drop Boxes
 - 1,200 Alliances (Staples)
 - 4,700+ The UPS Store locations. The UPS Stores are retail outlets that offer state agency consumers a wide range of products and services in one convenient location. Other services include:
 - Convenient drop off site for customers on the go, with the ability to have shipments delivered to the store to be held for pick-up
 - Document and Mailbox Services
 - Packing Services & Packaging Supplies
 - Notary Service
- b. Offeror must agree to place receptacles in convenient locations within Participating States and describe other centralized collection procedures available. Containers must be of sufficient size to contain 8 1/2" x 11" sheets of paper, without folding, up to the weight limit for various categories. The Carrier shall provide express pack boxes and express tubes to Participating States at no cost. Carrier shall provide requested materials and supplies within 48 hours of request, except for pre-printed shipping forms. Pre-printed shipping forms are Carrier's shipping forms pre-printed with users address and billing information. Note: Any pre-printed terms and conditions on any Carrier forms, which are inconsistent with the terms and conditions of the Master Agreement and any Participating Addendum are rejected and do not modify, change or replace the terms and conditions of this Master Agreement or subsequent Participating Addenda.

UPS will comply with this requirement.



Response to Solicitation

#CH21-36

UPS® Drop Boxes accept all service levels, and many have late pickups to accommodate the busy schedules of state agencies and Authorized Users. UPS® Drop Boxes are within easy reach whenever its needed— 24 hours a day, seven days a week. Benefits to Authorized Users include:

- *Convenience* — Most locations allow for drop off at curbside or inside office buildings
- *Pick-up indicator* — A handy indicator tells you if the daily pickup has been made
- *Supplies* — Drop boxes are stocked with what you need to label and ship letters and packages
- *Returns* — Return shipments, including ground packages, are accepted
- *Protection* — Shipments are automatically covered against loss up to \$100; if needed, additional coverage may be purchased
- *Late pickups* — Specific times for the location nearest you can be found on www.ups.com

UPS Drop Box shipments are scanned at pickup, making true end to-end visibility possible when combined with these solutions:

- *Quantum View®* — A suite of visibility services with proactive email updates, available at no cost to U.S.-based UPS accounts
- *UPS® Tracking* — Check shipment status at ups.com, via the UPS Mobile™ app or by calling 1-800-PICK-UPS®

ACCESS POINTS

Locating a UPS Access point is quick and easy at: <https://www.ups.com/dropoff>

United States New User | Log-In | Changing Languages | Contact UPS | The UPS Store

My UPS Shipping Tracking Freight Locations Support UPS Solutions Search

Find Locations Looking for your package? Enter tracking or InfoNotice number Track »

Near: Use my current location

United States

Narrow your search

- Find a drop off location
- Pay for a UPS shipping label
- Help with packaging my shipment

See All Options Clear Filters Find

TIP: A UPS driver can accept your package if it already has a UPS label.

Find UPS Locations on the go with SMS. Learn More »



SUPPLIES

UPS offers a variety of labels, boxes, paks and other supplies at no charge for Next Day, Second Day, Three Day and International Service shipments. Users can be order them directly through an authorized shipping solution, via www.ups.com or by calling 1-800-PICK-UPS. Delivery is available only within the United States and will take two business days.

- c. The Offeror shall, at no additional charge, provide Authorized Users with label printers, labels, etc. or the ability to print labels that are required to prepare articles for shipment. The Offeror shall describe its program for providing such printers, including its lease terms and conditions or the ability to print labels.

State agencies and Authorized Users can log onto ups.com to create and print UPS labels directly from their desktop.

- d. Offeror shall provide online services ordering capability as well as online printing of shipment documentation and labels. Online ordering and printing services shall be available to Authorized Users via access through the Internet and be capable of being accessed utilizing standard Internet Web Browsers. Offeror shall describe its online ordering and shipment documentation printing services, including a description of the security and privacy protection features that will be applicable to online services. The system shall accommodate a reference field for internal tracking numbers for invoice payment. The reference field shall accommodate up to 20 characters. Explain the process for modification of the online system if the Authorized user needs a change to the online order system. Is the system customizable?

UPS can comply with this requirement. UPS offers several core solutions for facilitating online shipping and label production. Our tools and technologies are built to make service selection, document printing, and tracking of packages easier for Authorized Users. Our solutions create efficiencies, centralize control, cut costs, and increase productivity. All UPS shipping solutions exceed the 20 character reference field requirement at 35 characters, to track invoice alignment to purchase orders and contract numbers. They let customers ship faster, with more flexibility and better insight. And, most importantly, they give customers more time to spend on their core business.

8. Marketing Plan

- a. Offerors shall provide a marketing plan explaining how an Offeror will market its relationship with NASPO ValuePoint, the Lead State, and Participating Entities in future marketing material and campaigns. The NASPO ValuePoint Master Agreement Terms and Conditions include program provisions governing participation in the cooperative, reporting and payment of administrative fees, and marketing/education relating to the NASPO ValuePoint cooperative procurement program. In this regard, the Offeror should address the following:

- b. Briefly describe how the Offeror intends to promote the use of the Master Agreement.

UPS comprehends that effective services and value-rich solutions must be supported by a Marketing Plan that contains effective awareness and communications and a sales team that supports state agencies.



UPS SERVICES AND SOLUTIONS

UPS services and solutions can be tailored to meet the needs of each state and agency. UPS possesses a vast, highly trained network of solutions experts, who offer flexible pick-up, delivery and logistic services tailored for each client.

UPS understands that government agencies are always looking for ways to improve efficiencies for its residents. Agencies and CPOs desire vendors who share best practices from both industry and government. UPS has developed solutions to support:

- Integration of technology to provide outbound and inbound visibility, ease of shipping, and simplified accounting reconciliation
- Responsiveness to the needs of the Department of Health
- Inbound optimization
- Warehouse planning and optimization
- Hazardous materials transportation
- International shipping
- Cost management

While States and Commonwealths have logistics challenges, UPS is there to offer support and expertise. UPS has experts across all of these areas to augment the capabilities of the UPS Enterprise Sales Resource, CPOs, and their staff as logistic challenges arise.

AWARENESS AND COMMUNICATIONS

Awareness and communications, throughout any business facet, are essential in operating with a high level of efficiency and effectiveness. Good ideas often fall short due to ineffective communication.

UPS External Communication

- COVID has taught us that we can still communicate using modern day technology such as Zoom or webinars. UPS Enterprise Sales Resources are available to work with stakeholders to share information on solutions that may be of interest to NASPO ValuePoint members.
- UPS Enterprise Sales Resources will schedule reviews with CPOs or their designee to identify organizational and process improvement goals and the UPS services and tools that can support those goals.



Response to Solicitation #CH21-36

- Searching on “state government” or “NASPO” on ups.com results in the State Government industry solutions page. The hyperlink connects the buyer with the UPS landing page on NASPO ValuePoint’s website.

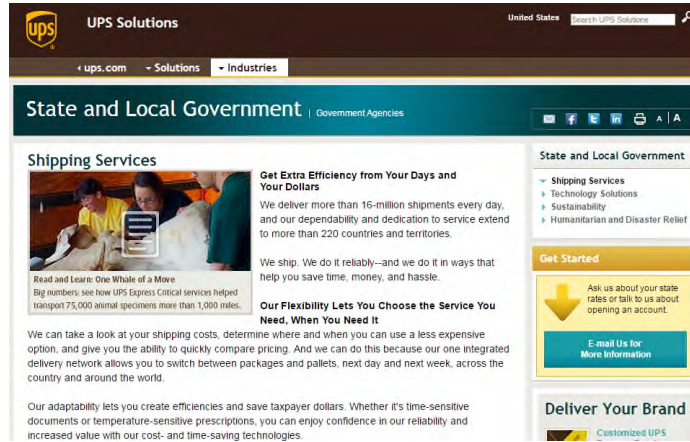

- UPS will work together with communications or marketing specialists at NASPO ValuePoint or state agencies to develop informative case studies that can be shared with CPO’s and agencies. These case studies highlight current industry innovations and trends.

DEDICATED PEOPLE

We value the opportunity to support NASPO ValuePoint members and recognize that training and equipping our Sales team with industry specific knowledge and tools to support the agreement is essential in UPS’s success.

- Each State or Commonwealth will be assigned an Enterprise Sales Resource. Not only are they adept in optimizing logistics, each one is trained on essential government procurement and compliance guidelines.
 - The Enterprise Sales Resources are supported by an Inside Sales Enterprise account team trained to position the value of the NASPO ValuePoint agreement. UPS connects its sales representatives via a “Contract Implementation” technology tool that provides the appropriate UPS solution experts with information and direction regarding the implementation of the NASPO ValuePoint award or the specific instructions of the CPO.
- c. Knowing that state procurement officials (CPO) must permit use of the Master Agreement in their state, how will you integrate the CPO’s permission into your plan for promoting the agreement?

UPS assigns an Enterprise Sales Resource to each state. The primary role of the UPS Enterprise Sales Resource is to support the CPOs in their aim to support the functional agencies. They do this by meeting with CPOs, CPO’s direct reports, and function areas of the state in order to offer insight into new solutions and changes in the industry and government. Agreements will be reviewed with the CPO or their designee.

- d. Public entities are sensitive to “scope” issues, whether performance is within the intended scope of the solicitation as awarded. In the context of the Offeror’s method of promoting Master Agreements of this nature, how would the Offeror clarify any questions regarding the scope of the Master Agreement with respect to any potential order?



UPS Enterprise Sales Resources are familiar with the scope of the agreement and can respond to questions. Additionally, UPS has a contract manager that is responsible for the NASPO ValuePoint agreement and is a published contact for both internal and external questions.

e. **How will the Offeror's company manage due dates for administrative fee payments and usage reports?**

Felicia Hall, Contract Manager and primary point of contact for NASPO ValuePoint, has a team that supports her on submitting administrative fee payments and usage reports. To be prepared for changes in staffing, cross training and an internal Standard Operating Plan and desk level procedures have been developed.

f. **Offeror to describe report customizations they can provide.**

UPS's prefers that its efficiencies be maintained by providing data for end users to manipulate to identify trends and usage. This thought practice applies to customer data as well as data that accompanies administrative fee payments.

g. **Through its Cooperative Development Coordinators and Education & Outreach team, NASPO ValuePoint assists Lead States by engaging vendors in strategies aimed at promoting master agreements. The Offeror should describe the opportunities and/or challenges you as an Offeror see in working with NASPO ValuePoint staff in this way.**

The NASPO ValuePoint staff are crucial to the success of providing services which benefit NASPO members. The NASPO ValuePoint staff ensures that members maximize the benefits of vendor agreements. UPS sees this as an opportunity to work with designated staff to gain insight to best support members. By fostering this relationship, NASPO staff will help to ensure that communications for CPOs, States, and agencies are appropriate and effective. Therefore, working with the NASPO staff will in turn ensure the best services be offered to its members. UPS will formally meet with the appropriate NASPO staff members to explore support needs and growth strategies.

NASPO ValuePoint staff will be able to provide insight as for the best way to communicate and implement solutions which benefit the states. NASPO ValuePoint staff will be able to provide introductions to key people responsible for solving particular problems at the state level.

9. Green Transportation Plan

a. **The Offeror shall outline its green transportation plan.**

Since 2003, UPS has been reporting on our sustainability efforts, offering a comprehensive look into our progress, challenges and opportunities. Our latest Sustainability Report, Accelerating Sustainable Solutions, showcases efforts during 2019. Some of the highlights include:

- Achieving four of our 2020 community and workforce goals one year early
- Expanding our fleet of 10,300 lower-emission delivery vehicles
- Making the largest-ever U.S. investment in renewable natural gas, which will reduce emissions by 1+ million metric tonnes – the equivalent of taking 216,000 cars off the road



- Continued innovating last-mile delivery options by launching UPS Flight Forward™ drone airline, one of the first certified by the U.S. Federal Aviation Administration (FAA)
 - Published our first-ever Sustainability Accounting Standards Board (SASB) Report, enhancing ESG disclosure for investors
- b. Offeror must describe what green transportation plans the Offeror has in place and any future plans.

UPS strives not only to be a leader in global logistics, but also a leader in sustainability. We constantly review our processes to make sure we are reducing our environmental impact, which includes examining how we drive, fly and conduct business worldwide. UPS does more every year to be sustainable and demonstrate leadership in ways that matter to our stakeholders and the world at large. Our complete **Sustainability Report** can be viewed online at [ups.com](https://www.ups.com).

UPS takes a comprehensive view of our carbon inventory. We take a comprehensive approach to reducing greenhouse gas emissions, including all our operations as well as major portions of our value chain (including customers and suppliers) where we can help reduce GHG emissions in meaningful ways. Our GHG reduction strategy includes three components:

Global transportation network:

- Reducing the miles we travel to accomplish any given level of shipping
- Reducing the fuel required for that travel
- Shifting travel to vehicles employing low-emission alternative fuels and advanced technology

Global facilities network:

- Reducing energy use in our facilities
- Increasing the use of renewable energy

Customers and Suppliers:

- Operating an eco-efficient service network that reduces supply chain carbon emissions for an average of 9.4 million customers daily
- Providing customers with related services that help them reduce their carbon impact
- Working with suppliers to increase their emissions awareness and reduction capabilities.

The transportation component of our GHG reduction strategy includes a number of strategies that UPS has developed and refined for decades, including the six summarized below.

Intermodal shifting – The various transport modes used in our sector have different energy intensities (energy required per unit of volume transported), ranging from aircraft at the high end to ships at the low end. UPS has focused for decades on using the most fuel-efficient transport mode or combination of modes to meet service requirements—and on being able to fluidly shift modes in real time to reduce energy intensity whenever possible. For emission reduction details from intermodal shifting, see our UPS Corporate Sustainability Report at www.ups.com/sustainabilityreport



Response to Solicitation

#CH21-36

Optimized network - The UPS global logistics network handles all categories of service (express, ground, domestic, international, commercial and residential) through one integrated pickup and delivery service system. For comparison, some of our competitors employ parallel service networks in their operating regions to handle different categories of services, which means they may dispatch multiple vehicles to a customer location on the same day. The UPS network eliminates this redundancy and its associated environmental impact.

Air fleet efficiencies - Because air transport is more energy intensive than other modes, it contributes the largest portion of our carbon footprint. Measuring, managing and mitigating the environmental impact of air transport is critical to overall carbon impact, just as transparent reporting on these activities is critical to a full understanding of environmental responsibility in our industry.

Ground fleet efficiencies - We have spent decades honing our ability to optimize fuel efficiency for our vehicles and optimize the behavior of our drivers. Owning our fleet enables us to multiply these gains by tens of thousands of vehicles every business day.

Full integration of technology and human factors - We empower everyone to make greenhouse gas reduction a successful priority, so that our investments in technology can pay off. We train each other constantly in how to use our assets more efficiently, we share ideas from the ground up and the top down and we apply innovations throughout our business once we know they work.

Continual innovation - UPS has dedicated teams focused on engineering innovations that help reduce energy consumption and emissions. UPS's smart logistics network refers to our digitally and physically connected facilities, fleet, and information systems. Using real-time data, artificial intelligence, machine learning, and other technology, we will optimize tracking and processing of packages and freight, and synchronize our transportation fleet. The Smart Global Logistics Network enables us to drive operational and sustainable improvements for our business, and provide greater accuracy and speed for our customers from pickup to the final mile. Good ideas keep coming, because we never stop looking for them.

Customers, including NASPO ValuePoint Authorized Users, often want to make their shipping more environmentally sustainable, but often are unsure which move to make. UPS's Enterprise Sales Resources and their team will work with states to explore UPS's initiatives and solutions that support their green transportation plan goals.



Driving Solutions for Sustainable Shipping

Customers often want to make their shipping more environmentally sustainable, but often are unsure which move to make. We offer a range of solutions that customers can choose to ensure a lower-carbon journey.



Start Here: Choose UPS

We deploy initiatives to lower the CO₂e emissions of our global logistics network. By simply choosing UPS, packages travel a more sustainable journey.

Initiatives

- Alternative fuel & advanced technology fleet
- Global, integrated, and optimized logistics network
- Use of carbon-efficient transportation modes, such as rail, sea, and cargo bikes
- Route optimization to ensure more efficient delivery
- Green building certifications and renewable energy for facilities

Next Step: Choose Sustainable Solutions

We provide solutions that offset carbon emissions entirely or lower them through more efficient trips that optimize routes and/or increase package density.

Solutions

- Carbon impact analysis
- UPS carbon neutral shipping
- UPS My Choice® service for home
- UPS My Choice® service for business
- UPS Access Point® network
- UPS Smart Pickup® service¹
- UPS Synchronized Delivery™ service²



The Extra Mile: Choose to Collaborate

We work with customers to measure and manage the carbon emissions of their shipping and to design more sustainable packaging.

Initiatives

- Supply chain optimization analysis
- Eco Responsible packaging program
- Packsize on-demand packaging³
- UPS Co-Innovation workshops

- c. Offeror shall describe in detail how it will meet the scope of work provided below:
- i. The scope of this RFP includes US domestic and international door-to-door express small package air services covering interstate, intrastate and international service. This RFP will cover both inbound and outbound shipments. Outbound shipments will move prepaid and inbound shipments will ship collect for each Participating State. Domestic expedited ground parcel shipments will also ship outbound prepaid and inbound collect by each participating state. Domestic shipment service includes the contiguous 48 states, Alaska, Hawaii, American Virgin Islands, and Puerto Rico, for both commercial and residential shipments.

UPS has the capacity and experience to provide US domestic and international door-to-door express small package air services covering interstate, intrastate and international service. We have developed and implement customized shipping (and logistics) solutions to address participating states' departments, agencies, and subsidiary political subdivisions. Our



Response to Solicitation

#CH21-36

approach also includes providing technology solutions that assist each customer in managing their overall transportation process and spend. UPS understands the performance expectations, deliverables, and outcomes of this RFP. We're ready to meet and exceed these requirements with our comprehensive portfolio which offers industry-leading guaranteed, time-definite delivery options than any other service provider. Our account management approach leverages best practices to ensure the timely implementation and on-going support of our services. Our quality assurance practices ensures we will meet and exceed NASPO ValuePoint service requirements. Finally, our experience allows us to understand your needs and in turn be a formidable partner with NASPO ValuePoint.

UPS has an unmatched portfolio of domestic and international services with service to every address (100% of zip codes) in the 50 states and Puerto Rico, along with Alaska and Hawaii. UPS also offers services to Canada, Mexico and other U.S. territories.

We will bill each UPS package as the customer specifies at the time of shipping, for example:

- Bill Shipper (Prepaid): UPS bills shipping charges to the shipper's UPS account
- Bill Receiver (Collect Billing): UPS bills shipping charges to the receiver's UPS account
- Bill Third Party (3rd Party): UPS bills shipping charges to an account held by a party other than the shipper or receiver
- Bill Credit Card: UPS bills shipping charges to a major credit card (this option is available when using an air shipping document)

We bill shipping charges to the shipper, unless otherwise specified at the time of shipping. UPS accepts shipments for collect and third party billing as long as the receiver or third party has a valid UPS account number and has agreed to accept the charges. We bill charges back to the shipper if the receiver or third party does not make payment.

- ii. Offerors desiring to offer intrastate ground or other related services for a specific state only must clearly designate each rate table and schedule of rates and charges accordingly. Those rates and service must apply to all points and places within the designated state and Offeror must document its ability to provide statewide pick-up and delivery service in its Proposal.

UPS agrees with this request.

- iii. The scope of work for this RFP only includes small package delivery and does not include courier services, LTL freight or freight.

UPS agrees with this request.

10. Point of Contact

- a. General Point of Contact: Carrier must provide the name of the person who will work with the NASPO ValuePoint Contract Administrator during the term of the Master Agreement. This person must be authorized to coordinate with other Offeror representatives in each Participating State to ensure an efficient implementation of the Master Price Agreement. These representatives will be able to quickly assign agency account numbers and insure the NASPO ValuePoint contract rates are attached accordingly. Offeror must describe the process required to obtain agency account numbers and Offeror personnel assigned must have full knowledge of the NASPO ValuePoint Master Agreement. Offeror shall provide to each Participating State the name, address and telephone number of such person and shall keep this



Response to Solicitation

#CH21-36

information current at all times. Should contact with such person require long distance calls, Offeror will provide a toll free number to be used during normal business hours.

Felicia Hall	Richard Wegner
Contract Manager	Contract Manager
Enterprise Sales, Government	Enterprise Sales, Government
fhall@ups.com and state@ups.com	rwegner@ups.com and state@ups.com
(240) 417-4773	(618) 406-3543

- b. **Problem Resolution Contact:** Offeror shall be available to Authorized Users via local or toll free phone number for normal problem resolution including but not limited to problems of shipment pickup, delivery, claims handling or incorrect billing. Requests for on-site problem resolution shall be on an as needed basis per request by the Authorized User. Offeror will not charge any travel costs to the Authorized User if on-site resolution is requested. Offeror shall respond to the on-site problem resolution within 24 hours of Authorized User's request. Offeror to describe the escalation process.

We find that most problems can be resolved without on-site support. On-site support is not covered by the pricing offered.

For problem resolution, NASPO ValuePoint customers can contact:

(800) 877-1497

Monday- Friday 7:00 am – 12:00 am EST;

Saturday 7:30 am – 6:00 pm EST

Email: enterprisesupport@ups.com

Common requests supported through Enterprise Support:

- Urgent package status
- Billing adjustment
- Claim and Damage inquiries
- Assistance with setting up Consolidated Payment Plans
- Delivery Intercepts
- Guaranteed Service Refunds
- Scheduling pickups
- Supply requests
- Tracking and Tracing
- Account updates

- c. Offerors shall have trained personnel that can research and maintain a quality assurance program through tracking and monitoring deliveries. Offerors must describe its ongoing quality control program along with how often staff is trained in protocols for quality control.



To ensure the quality of our service, UPS has assigned an operational excellence manager to every UPS region and district throughout the U.S., as well as internationally. These individuals are responsible for monitoring performance indices such as time-in-transit, shipment integrity, tracking data accuracy, as well as damage and claim occurrences. Operational excellence managers are responsible for identifying problem areas and then working with our operational groups to resolve and eliminate problems. We hold them accountable for generating improvements in all of the indices that they track. Customer-focused service results have improved year-to-year in part due to the involvement of the Operational Excellence staff.

Total Quality Management

We have instilled the UPS approach to total quality management within all levels of management and non-management through a program called “Think like a Customer.” This philosophy applies to both internal and external customers. Every UPS employee is the customer of the preceding operation, so every employee’s goal is to “Think like a Customer” and to ensure that the quality of his or her work meets the expectations of the next operation. By generating this behavior throughout the distribution chain, we assure the satisfaction of the ultimate customer.

Balanced Scorecard

UPS uses a variety of internal indices that measure the quality of our work. The main internal control is the balanced scorecard. This is a comprehensive measurement system used to monitor overall company performance in four perspectives: customer, people, financial and internal business. We select specific, measured elements for all organizational levels and functions.

The following are some of UPS’s measured indices on the scorecard:

- Delivery claim frequency
- Origin damages
- On-time delivery (index)
- Origin scan frequency (scans in UPS facility after we have made the pickup)
- Delivery scan frequency (service provider scan)
- Total time-in-transit
- Next Day Air time-in-transit
- End to end service
- International time-in-transit
- Part time employee turnover
- Volume plan versus actual
- Expense plan versus actual
- Profitability
- Operation productivity

Based on the results of these metrics and assessments, UPS operational excellence managers work with our operations group to isolate and correct any recognized issues in our system.

Consolidated Service Center Quality Control Group

The Consolidated Service Center Quality Control Group works with our phone center operations and is the control element for phone center service levels. Their responsibilities include:



Call Monitoring – This group has an active schedule of call monitoring to help evaluate the overall effectiveness of our customer service representatives.

Transaction Assessment – This procedure provides constant feedback about documented customer transactions. We return documentation with errors to the Consolidated Service Center sites to allow management an opportunity to follow up on inaccurate information.

Data Integrity Reports – These reports provide a monthly assessment on the quality of information captured and released in our operations.

Service Recovery Program

Our Service Recovery Program is a quarterly sampling that uses the UPS Customer Concerns Resolution Survey (CCRS). We use the results to provide a top-down comparison from corporate to region to individual district level. This is vital for making quality gains in customer satisfaction.

Customer Satisfaction Program

The UPS Customer Satisfaction Index (CSI) facilitates the continuous monitoring and measurement of customer satisfaction, relationship, loyalty, and value.

We use CSI results to define specific actions to improve our service to our customers. More than 45 key elements are grouped into 13 major categories, all defined by the “voice of the customer.” Our customers decide which key attributes make up the elements that best determine customer satisfaction.

Each year, an independent service collects more than 2,000 customer interviews upon which we base our CSI results. We closely track and monitor these results and can further categorize the thirteen major categories into three key areas of customer perception. These areas are:

- *Core Services* – delivery and pick up reliability, visibility of shipments and technology solutions
- *Personnel* – account representatives, drivers and customer service representatives
- *Price and Value* – competitive rates, quality services at reasonable prices and flexibility

- d. Offerors describe security measures in place such as having uniformed personnel, with carrier identification, vehicles that have the Carrier’s name on the side and can follow security procedures required by Authorized Users. Describe how Authorized Users can confirm the identity of Carrier staff and escalation procedures.

UPS will review individual security protocols related to delivery processes as presented by Authorized Users and work towards mutually agreeable solutions as necessary. Please reference UPS Package Security Profile for an overview of UPS’s general security practices.

- e. Describe the training and pick up procedures for drivers, processing staff, and delivery staff. At a minimum, Offeror must have trained personnel that can research and maintain a quality assurance program through tracking and monitoring deliveries.



Please reference UPS Package Security Profile for an overview of UPS's general security practices.

Section 4: Administrative and Technical Response Requirements

4.1 Insurance

To be eligible for award, the Offeror agrees to acquire insurance from an insurance carrier or carriers licensed to conduct business in each Participating Entity's state at the prescribed levels set forth in Section 21 of the NASPO ValuePoint Master Agreement Terms and Conditions. Describe your insurance or plans to obtain insurance satisfying the requirements in Section 21.

UPS can comply with is requirement. UPS can provide proof of insurance to NASPO for all drivers, employees, agents and vehicles. UPS does not bond our employees, but we have a strict crime policy that covers employee theft. Performance bonding is available under special circumstances. The following coverage detail has been provided for demonstration purposes only as a part of our proposal submission.

Severability Liability Notice - The subscribing insurers' obligations under contracts of insurance, to which they subscribe, are several and not joint, and are limited solely to the extent of their individual subscriptions. The subscribing insurers are not responsible for the subscription of any co-subscribing insurer who, for any reason, does not satisfy all or part of its obligation.

Auto Liability Insurance

This verification is issued for informational purposes only. The coverage afforded by the policies listed below are subject to the policy terms, conditions, limitations, exclusions and deductibles. This verification does not amend, extend or alter the coverage afforded by such policies.

Auto Liability Insurance for UPS

Includes Coverage for: UPS Capital, Customer Solutions, and MBE

UPS	Limits of Liability	Policy Period	Insurance Companies and Policy Numbers
Auto Liability (All owned, non-owned, and hired) undefined	\$1,000,000	01/01/2021- 01/01/2022	Policy # AS2-C21-004175-331; Liberty Mutual Fire Insurance Company Policy # AS2-C21-092036-911; Liberty Mutual Fire Insurance Company Policy # AS5-C21-004335-261; LM Insurance Corp.



Response to Solicitation

#CH21-36

Auto Liability Insurance for UPS

Includes Coverage for: UPS Capital, Customer Solutions, and MBE

			Policy # AS2-C21-092036-211; Liberty Mutual Fire Insurance Company
Excess Auto Liability undefined		01/01/2021- 01/01/2022	Liberty Mutual Fire Insurance Company EU2-C21-092036-931

Auto Liability Insurance for UPS Supply Chain Solutions

Includes Coverage for: UPS Ground Freight, UPS Cartage, UPS Capital, Coyote, and Marken

UPS Supply Chain Solutions	Limits of Liability	Policy Period	Insurance Companies and Policy Numbers
Auto Liability (All owned, non-owned, and hired) undefined	\$1,000,000	01/01/2021- 01/01/2022	Policy # AI2-C21-092036-581; Liberty Mutual Fire Insurance Company Policy # AI2-C21-092036-941; Liberty Mutual Fire Insurance Company Policy # AI2-C21-092036-021; Liberty Mutual Fire Insurance Company Policy # AI5-C21-092036-871; LM Insurance Corp.



Response to Solicitation

#CH21-36

Auto Liability Insurance for UPS Supply Chain Solutions

Includes Coverage for: UPS Ground Freight, UPS Cartage, UPS Capital, Coyote, and Marken

Coyote Logistics, LLC undefined		01/01/2021- 01/01/2022	Policy# AS2-C21-092036-991; Liberty Mutual Fire Insurance Company
Excess Auto Liability undefined		01/01/2021- 01/01/2022	Policy# EU2-C21-092036-921; Liberty Mutual Fire Insurance Company

Severability Liability Notice - The subscribing insurers' obligations under contracts of insurance, to which they subscribe, are several and not joint, and are limited solely to the extent of their individual subscriptions. The subscribing insurers are not responsible for the subscription of any co-subscribing insurer who, for any reason, does not satisfy all or part of its obligation.

General Liability Insurance

This verification is issued for informational purposes only. The coverage afforded by the policies listed below are subject to the policy terms, conditions, limitations, exclusions, and deductibles. This verification does not amend, extend, or alter the coverage afforded by such policies.



Response to Solicitation

#CH21-36

General Liability Insurance for UPS

Includes Coverage for: UPS Ground Freight, UPS Cartage, UPS Capital, Coyote, and Marken

UPS	Limits of Liability	Policy Period	Insurance Companies and Policy Numbers
General Liability Includes: Products/Completed Operations, Bodily Injury and Property Damage Liability, and Personal Injury undefined	\$1,000,000	01/01/2021- 01/01/2022 (Occurrence Basis)	Policy # TB2-C21- 004175-281; Liberty Mutual Fire Insurance Company Policy # TB2-C21- 092036-141; Liberty Mutual Fire Insurance Company Policy # TB5-C21- 092036-861; LM Insurance Corp.

General Liability Insurance for UPS Supply Chain Solutions

Includes Coverage for: UPS Ground Freight, and UPS Cartage Services

UPS Supply Chain Solutions	Limits of Liability	Policy Period	Insurance Companies and Policy Numbers
General Liability Includes: Products/Completed Operations,	\$1,000,000	01/01/2021- 01/01/2022 (Occurrence Basis)	Policy #TB2-C21-004335- 501; Liberty Mutual Fire Insurance Company



Response to Solicitation

#CH21-36

General Liability Insurance for UPS Supply Chain Solutions

Includes Coverage for: UPS Ground Freight, and UPS Cartage Services

<p>Bodily Injury and Property Damage Liability, and Personal Injury</p> <p>undefined</p>			<p>Policy #TB2-C21-092036-571; Liberty Mutual Fire Insurance Company</p> <p>Policy # TB5-C21-092036-881; LM Insurance Corp.</p>
--	--	--	---

Severability Liability Notice - The subscribing insurers' obligations under contracts of insurance, to which they subscribe, are several and not joint, and are limited solely to the extent of their individual subscriptions. The subscribing insurers are not responsible for the subscription of any co-subscribing insurer who, for any reason, does not satisfy all or part of its obligation.

Upon the execution of a contract, we will work with our Risk Management department to send copies of our insurance certificates reflecting the negotiated coverage as they pertain to the operation/services performed.

4.2. NASPO ValuePoint Requirements

To be eligible for award, the Offeror agrees to comply with Sections 6 ((Administrative fees), Section 7 (NASPO ValuePoint Summary and Detailed Usage Reports), and Section 8 (NASPO ValuePoint Cooperative Program Marketing, Training, and Performance Reviews) as specified in the NASPO ValuePoint Master Agreement Terms and Conditions.

UPS can agree generally to these sections subject to negotiation of these clauses. UPS has provided a redline of the Attachment A, Master Agreement Terms and Conditions as instructed.

Offeror shall identify the person responsible for providing the mandatory usage reports. This information must be kept current during the contract period. Contractor will be required to provide reporting contact within 15 days of Master Agreement execution.



Response to Solicitation

#CH21-36

Felicia Hall

Contract Manager

Enterprise Sales, Government

fhall@ups.com

Additional Agreement with NASPO: Upon request by NASPO ValuePoint, awarded Contractor shall enter into a direct contractual relationship with NASPO ValuePoint related to Reseller's obligations to NASPO ValuePoint under the terms of the Master Agreement, the terms of which shall be the same or similar (and not less favorable) than the terms set forth in the Master Agreement.

UPS does not intend to enter into a relationship with a reseller under this contract. If there is a change in approach, a written memorialization among the parties is preferred by UPS.

4.4 Participating State Terms and Conditions

For informational purposes only, some Participating State specific Terms and Conditions are provided in Attachments E – V (Lead State and Additional Participating States' Terms and Conditions) to this solicitation and will be negotiated with other Participating States after award of the Master Agreement. Each State reserves the right to negotiate additional terms and conditions in its Participating Addenda. Offeror shall submit a statement that they understand they may be required to negotiate these additional terms and conditions when executing a Participating Addendum.

UPS understands we may be required to negotiate additional terms and conditions when executing a Participating Addendum with individual Participating States. UPS takes no issue with laws of general applicability, nor with standard commercial terms that balance the interests of value to both parties. We do not support specific terms that do not come directly from the state's law when those terms result in adverse regulatory burdens and/or administrative costs.

2021 UPS Rate & Service Guide

Daily Rates

Updated April 5, 2021



This is the current UPS Rate & Service Guide at the time of submission. The Rate & Service Guide is subject to change without notice. The UPS Rate & Service Guide, in effect at the time of shipping, and the UPS Tariff/Terms and Conditions of Service, in effect at the time of shipping must be incorporated by reference into the resulting contract if UPS is awarded.,

Essential Contacts

Support

UPS Customer Service

[ups.com](https://www.ups.com)

1-800-PICK-UPS® (1-800-742-5877)

1-800-877-1548 En Español

1-800-782-7892 International

1-800-811-1648 Billing

1-800-554-9964 Hazardous Materials

1-800-833-0056 Hearing Impaired – TTY/TDD

customer.service@ups.com

International Shipping

[ups.com/international](https://www.ups.com/international)

1-800-782-7892

Zone Charts

View or download at [ups.com/rates](https://www.ups.com/rates)

WorldShip® Technical Support

[ups.com/worldshipsupport](https://www.ups.com/worldshipsupport)

1-888-553-1118

UPS Package Design and Test Lab

1-877-877-7229

UPS CampusShip® Support

Help Desk: 1-877-289-6418 (United States)

[campusship.ups.com/techsupport](https://www.campusship.ups.com/techsupport)

UPS® Ground Time in Transit

[ups.com/maps](https://www.ups.com/maps)

Freight Services

UPS offers multiple options for shipments over 150 pounds. For more information on these services, go to pages 4-6.

Air Freight Services

[ups-scs.com/airfreight](https://www.ups-scs.com/airfreight)

1-800-443-6379

Ocean Freight Services

[ups-scs.com/ocean](https://www.ups-scs.com/ocean)

1-800-443-6379

UPS Express Critical®

[upsexpresscritical.com](https://www.upsexpresscritical.com)

1-800-714-8779

UPS Freight® – LTL (Less-Than-Truckload)

[upsfreight.com](https://www.upsfreight.com)

1-800-333-7400

UPS Trade Direct®

[ups.com/tradedirect](https://www.ups.com/tradedirect)

1-800-742-5727

UPS Worldwide Express Freight® Services

[UPS Worldwide Express Freight](https://www.ups.com) at [ups.com](https://www.ups.com)

1-800-782-7892

UPS Worldwide Expedited® Ground Freight

[UPS Worldwide Expedited Ground Freight](https://www.ups.com) at [ups.com](https://www.ups.com)

1-800-443-6379

Coyote Logistics® – Truckload and Intermodal

[coyote.com](https://www.coyote.com)

1-877-626-9683

UPS Solutions

Visit [ups.com/services](https://www.ups.com/services) to view the full portfolio of UPS services.

The UPS Store®

[theupsstore.com](https://www.theupsstore.com)

1-800-789-4623

UPS Capital®

[upscapital.com](https://www.upscapital.com)

1-877-263-8772

Parcel Pro®

[parcelpro.com](https://www.parcelpro.com)

1-888-683-2300

Coyote® Collaborative Transportation Management

[coyote.com](https://www.coyote.com)

1-877-626-9683

UPS Mail Innovations®

[upsmailinnovations.com](https://www.upsmailinnovations.com)

1-800-500-2224

UPS Supply Chain Solutions®

[ups-scs.com](https://www.ups-scs.com)

1-800-742-5727

Stay on top of the latest UPS news, announcements and critical updates via e-mail at [ups.com/subscribe](https://www.ups.com/subscribe).

2021 Updates

Updates to this guide are as follows:

April 5	■ Service Restrictions
	Tobacco and Vaping Products update..... page 9
	■ Other Charges
	Additional Handling description update..... page 122

ups.com

How To Use This Guide

Find what you need to ship your packages – from services and rates to packaging and payment – in the following pages. For your convenience, the “UPS® Rate and Service Guide” is divided into four sections that cover each of the primary steps involved in preparing and processing a shipment. At the beginning of each section, further detail as to what is covered in that section is provided. Essential information regarding the general terms and conditions of service governing UPS and its affiliates in the transportation of packages and UPS Worldwide Express Freight® Midday and UPS Worldwide Express Freight® pallets in the United States is provided in the “UPS Tariff/Terms and Conditions of Service – United States” available at [ups.com/terms](https://www.ups.com/terms).

Section 1

CHOOSING A SERVICE

PAGES [3-9](#)

Determine the service that best meets your needs for domestic, export and import shipping. Also, learn about certain service restrictions that may apply.

Section 2

PREPARING A SHIPMENT

PAGES [10-24](#)

Information about how you package a shipment, determine the rate and get the shipment to UPS is provided.

Section 3

DETERMINING THE RATE

PAGES [25-138](#)

Determine the rates and zones for domestic, export and import shipments. Also, learn about value-added services that are available.

Section 4

TRACKING AND PAYMENT

PAGES [139-144](#)

Convenient and up-to-the-minute ways to track shipments are reviewed, as well as an explanation of the UPS invoice, its presentation and various billing and payment options.

Table of Contents

In this “UPS® Rate and Service Guide,” you will find the combined 2021 UPS Package Daily and Standard List Rates for the 48 contiguous states, referred to as “Daily Rates,” effective April 5, 2021 (unless otherwise noted). Daily Rates apply to UPS account holders who received Daily Rates prior to July 11, 2016, to shippers who establish a six-digit UPS account on or after July 11, 2016, or as UPS may otherwise agree in writing. You will also find service and rate information for UPS Freight® services, including Air Freight and Less-Than-Truckload. The most current version of this Guide can be downloaded at ups.com/rates.

Choosing a Service		Determining the Rate (continued)	
UPS® Services	4	Export (continued)	
Service Restrictions	7	UPS Worldwide Saver®	82
Preparing a Shipment		UPS Worldwide Expedited®	85
Special Packaging Needs	11	UPS® Standard	
Packaging Guidelines	13	To Canada	88
Determine the Weight and Size	16	To Mexico	91
Shipping Solutions	21	Import	94
Pickup and Drop-off Availability	23	Shipment Pricing	94
Determining the Rate		UPS Worldwide Express Plus	95
Determine the Rate	26	UPS Worldwide Express NA1®	95
Determine the Rate and Zone	27	UPS Worldwide Express	95
West and East State Classifications	28	UPS Worldwide Express Freight Midday	98
Export	29	UPS Worldwide Express Freight	99
Worldwide Zone Chart	29	UPS Worldwide Saver	100
Canada Zone Chart	33	UPS Worldwide Expedited	103
UPS® Standard Zone Chart (to Mexico)	38	UPS 3 Day Select® from Canada	106
Import	39	UPS® Standard	
Worldwide Zone Chart	39	From Canada	107
UPS 3 Day Select® and		From Mexico	109
UPS® Standard Zone Chart (from Canada)	42	Value-Added Services	112
UPS® Standard Zone Chart (from Mexico)	43	Package	114
Domestic	44	UPS Returns®	119
UPS Next Day Air® Early	44	Freight	126
UPS Next Day Air®	48	Air Freight	128
UPS Next Day Air Saver®	52	UPS Freight® LTL (Less-Than-Truckload)	130
UPS 2nd Day Air A.M.®	56	UPS Worldwide Expedited® Ground Freight	132
UPS 2nd Day Air®	60	Other Charges	113
UPS 3 Day Select	64	Package	122
UPS® Ground	68	Freight	127
UPS® Simple Rate	72	Air Freight	129
UPS Next Day Air® Freight	74	UPS Freight LTL (Less-Than-Truckload)	131
UPS 2nd Day Air® Freight	74	UPS Worldwide Expedited Ground Freight	133
UPS 3 Day Freight®	74	Customs Brokerage	134
UPS Next Day Air® Freight NGS	75	Tracking and Payment	
UPS 2nd Day Air® Freight NGS	75	Track Your Shipment	140
UPS 3 Day Freight® NGS	75	Reviewing Your Invoice	142
Export	76	Index	145
Shipment Pricing	76		
UPS Worldwide Express Plus®	77		
UPS Worldwide Express®	77		
UPS Worldwide Express Freight® Midday	80		
UPS Worldwide Express Freight®	81		

How To Use This Guide

Section 1

CHOOSING A SERVICE

Determine the service that best meets your needs for domestic, export and import shipping. Also, learn about certain service restrictions that may apply.

- Overview of UPS® services. Pages [4-6](#)
 - Review service restrictions for domestic, export and import shipments. Pages [7-9](#)
-

Section 2

PREPARING A SHIPMENT

PAGES [10-24](#)

Section 3

DETERMINING THE RATE

PAGES [25-136](#)

Section 4

TRACKING AND PAYMENT

PAGES [139-144](#)

UPS® Services



United States – Package

	Same Day	1 Day	2 Days	3 Days	Within 5 Days	Page
UPS Express Critical®	●					*
UPS Next Day Air® Early		●				44
UPS Next Day Air®		●				48
UPS Next Day Air Saver®		●				52
UPS 2nd Day Air A.M.®			●			56
UPS 2nd Day Air®			●			60
UPS 3 Day Select®				●		64
UPS® Ground					●	68
UPS® Simple Rate		●	●	●	●	72
UPS® Ground with Freight Pricing					●	6



International – Package and Freight

	Best Available Flight	1-3 Days	2-5 Days	Within 3 Days	3-5 Days	Day-Definite	Export Page	Import Page
UPS Express Critical	●						*	*
UPS Worldwide Express Plus®		●					77	95
UPS Worldwide Express NA1®		●					N/A	95
UPS Worldwide Express®		●					77	95
UPS Worldwide Express Freight® Midday		●					80	98
UPS Worldwide Express Freight®		●					81	99
UPS Worldwide Saver®		●					82	100
UPS Worldwide Expedited®			●				85	103
UPS 3 Day Select® from Canada				●			N/A	106
UPS® Standard to/from Canada						●	88	107
UPS® Standard to/from Mexico						●	91	109
UPS® Air Freight Premium Direct		●					**	**
UPS Air Freight Direct®		●					**	**
UPS Air Freight Consolidated®					●		**	**

*Visit upsexpresscritical.com or call 1-800-714-8779 for rates and information.

**Call 1-800-443-6379 for rates and additional information.

Notes:

– Some shipments to and from certain locations may require additional time in transit. For guarantee details, service availability and time commitments, visit ups.com for packages and ups-scs.com (or call 1-800-443-6379) for Air Freight.

– Visit ups.com/holidays for time in transit changes effective during the holiday season.

UPS® Services

North American Freight

	Same Day	1 Day	2 Days	2-3 Days	3-5 Days	Within 3-4 Days	Day-Definite	Page
UPS Express Critical®	●							*
UPS Next Day Air® Freight		●						74
UPS Next Day Air® Freight NGS		●						75
UPS 2nd Day Air® Freight			●					74
UPS 2nd Day Air® Freight NGS			●					75
UPS Worldwide Expedited® Air Freight (U.S.-Mexico)				●				**
UPS Worldwide Expedited® Ground Freight (U.S.-Mexico)					●			**
UPS Worldwide Expedited® Truckload (U.S.-Mexico)					●			**
UPS 3 Day Freight®						●		74
UPS 3 Day Freight® NGS						●		75
Coyote Logistics® Truckload and Intermodal							●	6
Coyote® Collaborative Transportation Management							●	6
UPS Freight® LTL (Less-Than-Truckload)							●	6
UPS Freight® LTL Guaranteed							●	6
UPS Freight® LTL Guaranteed A.M.							●	6
UPS Freight® LTL Urgent							●	6
UPS Freight® Dedicated Contract Carriage							●	6
UPS Freight® Trade Show Services							●	6
UPS Freight® Temperature Protection Services							●	6
UPS® Standard LTL (U.S.-Mexico)							●	***
UPS® Standard Truckload (U.S.-Mexico)							●	***



*Visit upsexpresscritical.com or call 1-800-714-8779 for rates and information.

**Delivery is guaranteed when UPS is the customs broker. Call 1-800-443-6379 for rates and additional information.

***Call 1-800-333-7400 for UPS Standard LTL or 1-888-682-4652 for UPS Standard Truckload rates and additional information.

Ocean Freight

Full-Container Load (FCL) NVOCC Service	Multiple sailings weekly <ul style="list-style-type: none"> • Dedicated service in all major global ports and markets • Door-to-door service available; customs clearance optional
Less-Than-Container Load (LCL) NVOCC Service	Weekly fixed-day sailings <ul style="list-style-type: none"> • Service in all major global ports and markets • Customs clearance optional
UPS Preferred® Multimodal Freight Services†	Better balance of speed and cost via: <ul style="list-style-type: none"> • UPS Preferred LCL to North America • UPS Preferred FCL and LCL between China and Europe • UPS Preferred Sea/Air from Asia
Ocean Freight Forwarding	Carrier booking, document processing, load coordination and container yard management
Project Cargo Management	Specialized multimodal transport for breakbulk with document processing <ul style="list-style-type: none"> • Service in all major global ports and markets • Customized single-project solutions • Charter vehicles/vessels available



†UPS Preferred Multimodal Freight Services subject to applicable tariff rules.

Notes:

- UPS Freight® Services are governed by the UPS Freight Rules Tariff for Less-Than-Truckload transportation. For full details and updates, refer to upsfreight.com/tariff.
- Some shipments to and from certain locations may require additional time in transit. For guarantee details, service availability and time commitments, visit ups.com for packages and ups-scs.com (or call 1-800-443-6379) for Air Freight and UPS Worldwide Expedited Ground Freight.
- Visit ups.com/holidays for time in transit changes effective during the holiday season.
- Ocean Freight services are provided pursuant to the “UPS Supply Chain Solutions® (Ocean Freight Forwarding) Terms and Conditions” and the “Non-Vessel Operating Common Carrier (NVOCC) Terms and Conditions,” each available at ups-scs.com/terms. Services listed above are available in most major markets. Please refer to the Terms and Conditions for more details.

UPS® Services

Service	Delivered By	Destinations	Other Information
UPS FREIGHT® SERVICES			
LTL (Less-Than-Truckload)*	<ul style="list-style-type: none"> – End of scheduled business day – Backed by day-definite, on-time guarantee at no additional charge in the 48 contiguous states, and to and from Canada 	<ul style="list-style-type: none"> – All 50 states, Canada, Mexico, Puerto Rico, U.S. Virgin Islands and Guam 	<ul style="list-style-type: none"> – Regional, interregional and long-haul LTL services – More than 35,000 one- and two-day lanes nationwide – No Fee Guarantee applies to current UPS Freight Tariff customers only
LTL Guaranteed*	<ul style="list-style-type: none"> – End of scheduled business day 	<ul style="list-style-type: none"> – Direct service points in the 48 contiguous states and between the 48 contiguous states and Canada or Mexico 	<ul style="list-style-type: none"> – Guaranteed service available for customers with contracts and/or pricing other than the current UPS Freight Tariff
LTL Guaranteed A.M.*	<ul style="list-style-type: none"> – 12:00 p.m. of scheduled business day 	<ul style="list-style-type: none"> – Select destination points in the 48 contiguous states 	<ul style="list-style-type: none"> – Guaranteed service with up-charge applied to existing LTL pricing provisions
LTL Urgent	<ul style="list-style-type: none"> – Guaranteed capabilities for shipments that require faster delivery than standard LTL service or specific time-definite delivery 	<ul style="list-style-type: none"> – All 50 states, Canada, Mexico, Puerto Rico, U.S. Virgin Islands and Guam 	<ul style="list-style-type: none"> – Customized solutions for unique LTL transportation needs – Call 1-800-644-0900 for rates and to schedule service
Trade Show Services	<p>Our Trade Show specialists help you select package and freight shipping solutions for your exhibit and supporting materials to and from the show:</p> <ul style="list-style-type: none"> – Advance warehousing, round-the-clock tracking and on-time performance guarantee** provide peace of mind for your trade show shipping – On-site UPS Trade Show representatives to assist with return shipping needs – Customs Brokerage and Air Freight services available when exhibiting internationally – Call 1-800-988-9889 to speak to a trade show specialist about your show 		
Temperature Protection Services	<ul style="list-style-type: none"> – Seasonal protection (October through April) for commodities with a freeze point of 32 degrees Fahrenheit or lower – Refrigerated unit service available – Call 1-800-644-0900 for fees and more information 		
Dedicated Contract Carriage	<ul style="list-style-type: none"> – Secure the capacity and rigorous service levels of your own customized private fleet with the peace of mind and operational efficiencies of being managed by experts at UPS with exclusive use of dedicated equipment, drivers, systems and management domiciled on-site. – Highly customized and engineered dedicated fleet solutions to meet unique client needs for automotive parts, retail, perishables, medical and any industry where rigorous delivery service levels are required. – Send an e-mail to dedicatedtruckload@ups.com to request information. 		
UPS CAPITAL® SERVICES			
Insurance Services	<p>Protect your in-transit freight shipments as well as warehoused goods against loss or damage with higher coverage limits than standard, non-insurance declared value programs.</p> <ul style="list-style-type: none"> – Worldwide coverage for package and freight shipments regardless of mode and carrier – Coverage options for unique commodities, including wine and other time- and temperature-sensitive goods – Coverage and advanced risk mitigation protocols for jewelry, loose stones and watches through Parcel Pro® – Call 1-877-263-8772 or visit upscapital.com 		
Payments	<p>Accept payments securely and easily with UPS Capital® Merchant Services.</p> <ul style="list-style-type: none"> – Multiple payment options – Next-business-day funding <p>– Call 1-877-263-8772 or visit upscapital.com</p>		
COYOTE LOGISTICS®			
Truckload and Intermodal	<ul style="list-style-type: none"> – Coyote Logistics, a UPS company, provides truckload and intermodal brokerage and transportation management services across a wide range of industries. – Services include asset utilization, dry van, temperature-controlled and open-deck, using a network of more than 50,000 carriers. Areas of service include North America and Europe. – Our intermodal solution is a cost-efficient option for long-haul moves and will help you reduce your carbon footprint. You'll benefit from transparent technology, including real-time visibility, tracking updates and access to load details on all of your shipments. – Call 1-877-626-9683 or visit coyote.com to request a quote or for more information. 		
Collaborative Transportation Management	<ul style="list-style-type: none"> – Coyote's Collaborative Transportation Management program offers comprehensive solutions for supply chain planning and optimization, transportation management and strategic sourcing of capacity. – Shippers can leverage advanced analytics and custom reporting on a web-based Collaborative Transportation Management portal, driven by Coyote's constantly evolving, proprietary technology. – Send an e-mail to managementsolutions@coyote.com for more information. 		
MULTIPLE-PACKAGE SHIPMENTS			
These offerings are ideal for multiple-package shipments where a pallet is not required. Each package has its own shipping label and unique tracking number.			
UPS® Ground with Freight Pricing	<ul style="list-style-type: none"> – Guaranteed day-definite UPS® Ground delivery within one to five business days in the 48 contiguous states for shipments over 150 pounds. – With UPS Ground with Freight Pricing, customers have the ability to rate and ship UPS Ground service using LTL shipment characteristics, such as Freight Class. Visit ups.com/gfp for more information about shipment eligibility and rates. 		
UPS Hundredweight Service®	<ul style="list-style-type: none"> – Contractual service for shipments with two or more packages going to the same destination on the same business day and having a minimum shipment weight of 100 pounds for Air Services and 200 pounds for UPS Ground. – Available with UPS Next Day Air®, UPS Next Day Air Saver®, UPS 2nd Day Air A.M.®, UPS 2nd Day Air®, UPS 3 Day Select® and UPS Ground shipments. – Guaranteed day-definite delivery within one to five business days in all 50 states and Puerto Rico. 		

*Contact 1-800-333-7400 for all your UPS Freight® LTL (Less-Than-Truckload) needs.

**For inbound trade show shipments only.

Notes:

– UPS Freight Services are governed by the UPS Freight Rules Tariff for Less-Than-Truckload transportation. For full details and updates, refer to upsfreight.com/tariff.

– Visit ups.com/holidays for time in transit changes effective during the holiday season.

Domestic, Export and Import Service Restrictions

PACKAGE

Hazardous Materials and International Dangerous Goods

UPS will accept domestic Air Dangerous Goods shipments prepared under D.O.T. 49 C.F.R. or the International Air Transport Association (IATA) regulation sets. The domestic Hazardous Materials and International Dangerous Goods (IDG) functionality is integrated into the current version of WorldShip® software. Contact the Hazardous Materials Support Center at 1-800-554-9964 for more information.

Select Hazardous Materials, as defined and regulated under Title 49 of the Code of Federal Regulations (49 C.F.R.), and Dangerous Goods, as defined under the International Civil Aviation Organization (ICAO) and published in the IATA “Dangerous Goods Regulations,” are accepted for transportation only as a contractual service domestically within and between all 50 states and Puerto Rico, and internationally within or between defined service areas. Effective April 3, 2017, a separate contract is required to ship Cargo Aircraft Only (CAO) quantities for classes 1-8 (contact the Hazardous Materials Support Center at 1-800-554-9964 for more information).

Setting Up Service for Hazardous Materials and Dangerous Goods

To receive Hazardous Materials or Dangerous Goods service, including UPS® Standard to Canada, the shipper must have a Scheduled Pickup account and agree to the provisions set forth in the online “UPS Dangerous Goods Agreement Checklist” or an approved prior domestic or international agreement or have these same provisions incorporated into their existing customized contract.

Location Restrictions for Ground and Air Services

UPS does not accept hazardous materials, including Consumer Commodities, Limited Quantities (Ltd Qty) and combustibles, via UPS® Ground service to and from Alaska; Hawaii; Puerto Rico; Avalon, CA; Catalina Island, CA; Beaver Island, MI; Mackinac Island, MI (winter only); the Bass Islands, OH; Kelleys Island, OH; and San Juan Islands, WA. Many products that are not regulated or do not

require shipping papers via UPS Ground are fully regulated when transported via aircraft. Hazardous Materials are accepted for transportation via UPS Air Services to and from Alaska, Hawaii, Puerto Rico and Catalina Island only in passenger aircraft quantities without an additional contract granting access to Cargo Aircraft Only (CAO) quantities for classes 1-8 (contact the Hazardous Materials Support Center at 1-800-554-9964 for more information). Shipments must be prepared according to the requirements set forth in either Title 49 of the Code of Federal Regulations (49 C.F.R.) or in the IATA regulations and the “UPS Guide for Shipping Ground and Air Hazardous Materials” at ups.com/hazmat.

UPS 3 Day Select®

When preparing Hazardous Materials packages for UPS 3 Day Select shipping, packages must be prepared in accordance with the applicable air regulations. Many products that are not regulated or do not require shipping papers via UPS Ground are fully regulated when transported via aircraft. Hazardous Materials are accepted for transportation in UPS 3 Day Select shipments only in passenger aircraft quantities without an additional contract granting access to Cargo Aircraft Only (CAO) quantities for classes 1-8 (contact the Hazardous Materials Support Center at 1-800-554-9964 for more information). Shipments must be prepared according to the requirements set forth in either Title 49 of the Code of Federal Regulations (49 C.F.R.) or in the IATA regulations and the “UPS Guide for Shipping Ground and Air Hazardous Materials,” available at ups.com/hazmat.

Limited Quantities (Ltd Qty)

Ltd Qty shipments prepared under HM-215K are accepted for transportation without Hazardous Materials shipping papers and without a contract, only within the 48 contiguous states via UPS Ground, UPS Ground with Freight Pricing and UPS Hundredweight Service® shipping for UPS Ground shipments, and via UPS Standard to Canada and UPS Ground Intra-Alaska

and Intra-Oahu services, when properly classified, packaged and marked, provided the shipper has reviewed the service restrictions with a UPS representative.

UPS Ground, UPS Ground with Freight Pricing and UPS Hundredweight Service shipping for UPS Ground shipments are not available for Ltd Qty shipments to and from Avalon, CA; Catalina Island, CA; Beaver Island, MI; Mackinac Island, MI (winter only); the Bass Islands, OH; Kelleys Island, OH; and San Juan Islands, WA.

Ltd Qty (HM-215K) packages shipped via UPS domestic Air Services and UPS 3 Day Select shipping within the U.S. and Puerto Rico, and Consumer Commodity and Ltd Qty shipments to IDG destinations, are accepted for transportation on a contractual basis only.

UPS Express Critical®

UPS Express Critical service accepts Hazardous Materials and International Dangerous Goods shipments via ground transportation or air charter service only (certain restrictions apply).

Dry Ice

UPS accepts most non-Dangerous Goods shipments containing dry ice within the U.S. without requiring the shipper to enter into the UPS Dangerous Goods Agreement. Refer to page 123 for more information. International dry ice shipping is available on a contractual basis only.

International Dangerous Goods (IDG)

UPS accepts IDGs on a contract basis only. The “UPS Guide for Shipping International Dangerous Goods” should always be used in conjunction with the most current IATA “Dangerous Goods Regulations.” UPS only transports Dangerous Goods to and from IDG countries and territories. The Dangerous Goods Service handling charge applies to all packages and palletized shipments that require a “Shipper’s Declaration for Dangerous Goods.” Refer to page 123 for fees.

Notes:

- UPS Worldwide Express Freight® Midday and UPS Worldwide Express Freight services are included unless otherwise noted.
- Hazardous Materials are not accepted for transportation using UPS® Simple Rate, UPS Ground with Freight Pricing or UPS Worldwide Expedited Ground Freight.
- For shipping Dangerous Goods and Hazardous Materials via Air Freight, refer to the “UPS Air Freight Terms and Conditions of Contract for UPS Air Freight Services in the United States, Canada and International” at ups-scs.com/terms or call 1-800-443-6379 for more information.
- UPS Freight® Services are governed by the UPS Freight Rules Tariff for Less-Than-Truckload transportation. For full details and updates, refer to upsfreight.com/tariff.
- For additional service restrictions, refer to the “UPS Tariff/Terms and Conditions of Service – United States” available at ups.com/terms.

Domestic, Export and Import Service Restrictions

PACKAGE

Prohibited and Restricted Goods

Alcoholic Beverages

Packages containing alcoholic beverages (beer, wine or spirits) are accepted for transportation only on a contractual basis. Shippers must be licensed and authorized under applicable law to ship alcoholic beverages.

Alcoholic beverages are accepted for transportation only to certain states. To receive service for packages containing alcoholic beverages, the shipper must enter into, and agree to, the provisions set forth in the approved UPS agreement for the transportation of alcoholic beverages shipments. Shipments containing alcoholic beverages can be delivered to an alternate address via UPS Delivery Intercept® service or redirected to a UPS Access Point® Location via the UPS My Choice® tool.

C.O.D.

Collect on Delivery (C.O.D.) service is not available for UPS Express Critical® or international services except for U.S. imports from Canada. C.O.D. service is not available for UPS Worldwide Express Freight MIDDAY and UPS Worldwide Express Freight services. C.O.D. service is also not available when using a UPS 3 Day Select® or a UPS® Ground shipping document.

Firearms, Ammunition and Weapons

Firearms, ammunition and weapons (including inert and replica explosive weapons) will be accepted for transportation only according to the "UPS Tariff/Terms and Conditions of Service – United States" available at [ups.com/terms](https://www.ups.com/terms).

Jewelry, Unset Precious Stones and Industrial Diamonds

International jewelry shipments, and shipments of unset precious stones or industrial diamonds, are subject to maximum declared value restrictions that vary by destination as set forth at [ups.com/jewelry](https://www.ups.com/jewelry).

Maximum Length

The maximum length per domestic, export or import package is 108 inches. There are no maximum length restrictions for UPS Express Critical packages.

Maximum Size

The maximum size per domestic, export or import package is 165 inches in length plus girth [(2 x width) + (2 x height)] combined. The maximum size per UPS® Simple Rate package is 1,728 cubic inches. For irregularly shaped packages, refer to page 17 for instructions. UPS Worldwide Express Freight MIDDAY and UPS Worldwide Express Freight pallets are subject to maximum size restrictions (which vary by origin and destination) as set forth at [ups.com/assets/resources/media/wwef_max_dim.pdf](https://www.ups.com/assets/resources/media/wwef_max_dim.pdf). Prior approval is required to ship UPS Worldwide Express Freight MIDDAY and UPS Worldwide Express Freight shipments exceeding maximum size and weight restrictions. There are no maximum size restrictions for UPS Express Critical packages.

Maximum Declared Values

Shippers are prohibited from shipping, and UPS does not accept for transportation, packages having a value of more than \$50,000.00 except for a package eligible for the Enhanced Maximum Declared Value of \$70,000.00 per package, as set forth in the "UPS Tariff/Terms and Conditions of Service – United States" available at [ups.com/terms](https://www.ups.com/terms). A package is eligible only if it is a domestic UPS Next Day Air® delivery service shipment, is tendered pursuant to shipper's scheduled pickup service, is processed for shipment using a UPS Shipping System (declarations of value on paper source documents are not eligible) and does not contain hazardous materials or a perishable commodity. For UPS Worldwide Express Freight MIDDAY and UPS Worldwide Express Freight services, UPS does not accept for transportation pallets having a value of more than

\$100,000.00 per pallet. Additionally, more restrictive value limits apply for certain packages and pallets.

Refer to the "UPS Tariff/Terms and Conditions of Service – United States" available at [ups.com/terms](https://www.ups.com/terms) for more information on maximum allowable values and liability limitations.

Maximum Weight

For domestic package shipments, the maximum actual weight per package is 150 pounds. The maximum actual weight per UPS Simple Rate package is 50 pounds.

For international shipments, the maximum weight of a package may vary by destination or origin. UPS Worldwide Express Freight MIDDAY and UPS Worldwide Express Freight pallets are subject to maximum weight restrictions (which vary by origin and destination) as set forth at [ups.com/assets/resources/media/wwef_max_dim.pdf](https://www.ups.com/assets/resources/media/wwef_max_dim.pdf). Prior approval is required to ship UPS Worldwide Express Freight MIDDAY and UPS Worldwide Express Freight shipments exceeding maximum size or weight restrictions. There are no maximum weight restrictions for UPS Express Critical packages. Call the UPS International Customer Service Center at 1-800-782-7892 for more information.

Maximum Weight for a Hazardous Materials and International Dangerous Goods Package

The maximum weight for a Hazardous Materials and International Dangerous Goods package is 70 pounds, unless further restricted by the regulations set forth in 49 C.F.R. or IATA regulations. Maximum weight for a non-Hazardous Materials package shipment containing dry ice is 150 pounds. Consult the "UPS Guide for Shipping Ground and Air Hazardous Materials" at [ups.com/hazmat](https://www.ups.com/hazmat) or call the Hazardous Materials Support Center at 1-800-554-9964 for more information.

Notes:

- UPS Worldwide Express Freight® MIDDAY and UPS Worldwide Express Freight® services are included unless otherwise noted.
- For Air Freight or UPS Worldwide Expedited® Ground Freight service restrictions, refer to [ups-scs.com/terms](https://www.ups.com/terms).
- UPS Freight® Services are governed by the UPS Freight Rules Tariff for Less-Than-Truckload transportation. For full details and updates, refer to [upsfreight.com/tariff](https://www.upsfreight.com/tariff).
- For additional service restrictions, refer to the "UPS Tariff/Terms and Conditions of Service – United States" available at [ups.com/terms](https://www.ups.com/terms).

Domestic, Export and Import Service Restrictions

PACKAGE

Prohibited and Restricted Goods (continued)

Restricted and Prohibited Articles (Export and Import)

It is the shipper's responsibility to comply with current government regulations or laws applicable in each country.

Shipments are subject to inspection and possible delay by customs officials or representatives of other government agencies. Certain countries and territories have additional prohibited or restricted articles. For more information, call the UPS International Customer Service Center at 1-800-782-7892.

The following items are restricted for international shipping. They may be shipped into the U.S., and to countries and territories outside the U.S., only where service is allowed on a contractual basis:

- Alcoholic beverages
- Animal products, non-domesticated (e.g., mother of pearl inlay, snakeskin watch bands)
- Articles of high/unusual value
- Biological substances, Category B and exempt human or animal specimens
- Dangerous goods
- Firearms and weapons (including inert and replica explosive weapons)
- Furs
- Gold or other precious metals
- Live animals*
- Perishables
- Personal effects**
- Plants
- Seeds
- Tobacco and Vaping Products

The following items are not accepted for transportation by UPS into the U.S. or to countries and territories outside the U.S.:

- Ammunition (except as expressly provided in the "UPS Tariff/Terms and Conditions of Service – United States" available at [ups.com/terms](https://www.ups.com/terms).)
- Bank bills, notes or currency (other than coin)
- Corpses, cremated or disinterred remains

- Fireworks
- Hazardous waste
- Ivory
- Marijuana, including marijuana intended for medicinal use
- Postage stamps
- Shark fins
- Shipments prohibited by law

Tobacco and Vaping Products

Shipments containing tobacco products ("Tobacco Product Shipments") are accepted for transportation only from shippers who are licensed and authorized to ship tobacco products pursuant to applicable laws. UPS does not provide service to any person or entity listed in the Bureau of Alcohol, Tobacco, Firearms and Explosives PACT Act – Non-Compliant List.

The term "Tobacco Products" is defined at [ups.com/tobacco](https://www.ups.com/tobacco). Shippers should consult [ups.com/tobacco](https://www.ups.com/tobacco) for the current definition of tobacco products, as the definition may change periodically. At present, and without limiting the complete definition posted at [ups.com/tobacco](https://www.ups.com/tobacco), the term "Tobacco Products" includes any product made or derived from tobacco that is intended for human consumption, including any component, part or accessory of a tobacco product; the term includes, without limitation, e-cigarettes, e-hookah, e-cigars, vape pens, advanced refillable personal vaporizers and electronic pipes.

UPS prohibits the shipment of Cigarettes or Little Cigars (as those terms are defined at [ups.com/tobacco](https://www.ups.com/tobacco)) to consumers. UPS also prohibits the shipment of all Vaping Products (as the term is defined at [ups.com/tobacco](https://www.ups.com/tobacco)) throughout its U.S. domestic network, including import and export, regardless of nicotine content and destination state. To make other Tobacco Product Shipments, the shipper must sign, agree to and comply with the provisions set forth in an approved UPS agreement for

the transportation of Tobacco Products. Shippers and receivers must comply with all applicable federal, state, provincial or local laws or regulations, and all Tobacco Product Shipments must conform to the terms, conditions, restrictions and prohibitions set forth at [ups.com/tobacco](https://www.ups.com/tobacco) at the time of shipping. It is the responsibility of the shipper to ensure that a shipment tendered to UPS, including a Tobacco Product Shipment, does not violate any federal, state, provincial or local laws or regulations applicable to the shipment.

All shipments, including shipments containing Tobacco Products, will be accepted for transportation only according to the "UPS Tariff/Terms and Conditions of Service – United States" available at [ups.com/terms](https://www.ups.com/terms).

Tobacco Products may not be shipped from a UPS Drop Box, UPS Customer Center, UPS Alliance Location (Staples), locations of The UPS Store®, any UPS Authorized Shipping Outlet or UPS Access Point® location. Please visit [ups.com/tobacco](https://www.ups.com/tobacco) for more information.

UPS Returns®

UPS Returns Services are not provided via UPS Next Day Air Saver® or UPS 2nd Day Air A.M.® service levels. UPS Returns Service options for UPS® Simple Rate are limited to UPS Print Return Label Service only. Hazardous Materials or Dangerous Goods packages, pallets requiring shipping papers and packages containing firearms cannot be retrieved via UPS Returns Services. Biological substances and dry ice can be retrieved via UPS Returns Services. No other restricted or prohibited articles may be retrieved with UPS Returns Services. Refer to [ups.com/terms](https://www.ups.com/terms) for value limits on UPS Returns Services shipments. Multiple-piece shipments are not available for UPS Returns Services shipped within the 50 states and Puerto Rico.

Notes:

- UPS Worldwide Express Freight® Midday and UPS Worldwide Express Freight® services are included unless otherwise noted.
- For Air Freight or UPS Worldwide Expedited® Ground Freight service restrictions, refer to [ups.com/terms](https://www.ups.com/terms).
- UPS Freight® Services are governed by the UPS Freight Rules Tariff for Less-Than-Truckload transportation. For full details and updates, refer to [upsfreight.com/tariff](https://www.upsfreight.com/tariff).
- For additional service restrictions, refer to the "UPS Tariff/Terms and Conditions of Service – United States" available at [ups.com/terms](https://www.ups.com/terms).
- *Select live animals may be shipped only pursuant to the restrictions and conditions set forth at [ups.com/animals](https://www.ups.com/animals).
- **Limited shipping of personal effects is available at The UPS Store and any UPS Customer Center.

How To Use This Guide

Section 1 CHOOSING A SERVICE

PAGES [3-9](#)

Section 2

PREPARING A SHIPMENT

Information about how you package a shipment, determine the rate and get the shipment to UPS are provided.

- Review tips for special packaging. Pages [11-15](#)
 - Determine the weight and size. Pages [16-20](#)
 - Select automated or manual processing options, including online shipping solutions, shipping documents and the UPS Waybill. Pages [21-22](#)
 - Arrange for a UPS pickup or drop-off at a variety of locations that accept UPS packages. Pages [23-24](#)
-

Section 3 DETERMINING THE RATE

PAGES [25-136](#)

Section 4 TRACKING AND PAYMENT

PAGES [139-144](#)

Special Packaging Needs

PACKAGE

If you ship the following items, consider their special packaging needs.

Batteries

A variety of batteries are regulated as hazardous materials by the U.S. Department of Transportation (DOT) and International Air Transport Association (IATA). For assistance in determining whether or not your battery shipment is regulated, please call the DOT's Hazardous Materials Info-line at 1-800-467-4922. Batteries requiring shipping papers may only be tendered by contract hazmat shippers. (See the "UPS Guide for Shipping Ground and Air Hazardous Materials" at [ups.com/hazmat](https://www.ups.com/hazmat).) Any device with batteries installed must have its on/off switch protected from being activated or have the batteries removed with the terminals protected. Simple devices like flashlights or rechargeable drills can generate a dangerous amount of heat if accidentally activated. Electronic items sent for repair, such as computers and cell phones, should be sent without batteries. For additional information regarding the shipment of batteries, please go to [ups.com](https://www.ups.com) and enter "Batteries" in the search field. For current lithium battery regulations, please refer to [ups.com/batteries](https://www.ups.com/batteries).



Bundled or Strapped Boxes

Only same-sized boxes may be strapped together. Use a minimum of four crisscrossed bands, two in each direction. An address label must be placed on each box. When strapping boxes together, each box must be strong enough to hold the total weight of the strapped bundle. For example, if two 15-pound boxes are banded together into a 30-pound package, both components should be in boxes with at least a 30-pound weight capacity. An Additional Handling charge may apply. Refer to page [122](#) for more information.



Electronic Media

To ship electronic media that contain sensitive personal information (such as personal financial or health information), we recommend that you do not use an envelope, letter packaging, UPS Express® Envelope, UPS Express® Envelope – Reusable, UPS Express® Pak or UPS Express® Pad Pak. UPS provides special packaging, the UPS Express® Hard Pak – Secure, which is designed to help you ship sensitive electronic media. Call 1-800-PICK-UPS® (1-800-742-5877) or your sales representative for more information. You can also ship electronic media containing sensitive personal information by packaging it with a duplicate shipping label in an inner container that can be securely sealed. Place the inner container in a new outer corrugated box. Seal all flaps securely. Prior to packaging, mark the electronic media with identifiable information, such as your company name, reference number or your UPS shipping number. Additionally, the shipper should retain a copy of the data and secure the data on the electronic media through encryption or other technological means.



Fabric and Wallpaper

Rolled goods travel best when shipped in corrugated boxes. If a fabric or wallpaper roll is shipped in a bag, UPS recommends a bag with a minimum thickness of six mils. Make sure the bag is tightly wrapped and taped against the roll to reduce the risk of tearing. A tail on an item shipped in a bag must be compressed to the body of the item using tape. Place the address label on a flat surface of the item being shipped. Place duplicate address labels inside cores or between top layers of material. An Additional Handling charge may apply. Refer to page [122](#) for more information.



If you have highly sensitive or confidential material, UPS Express Critical® shipping offers a same-day service to handle your specialized needs. To get more information, please call 1-800-714-8779 or speak with your sales representative.

Special Packaging Needs

PACKAGE

Irregularly Shaped Items and Bare Metals

Tape the address label on a flat surface of the item being shipped. Cover the label with clear tape. Do not use “flying tags” attached by string or metal. Blunt all sharp or protruding edges with taped-on, corrugated cardboard pieces. Protect the surface of the item as needed. An Additional Handling charge will apply. Refer to page [122](#) for more information.

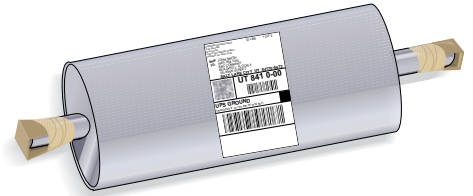

Large and/or Heavy Packages

Packaging materials need to be evaluated carefully for packages weighing more than 70 pounds.

A UPS Heavy Package sticker is required whenever you ship packages weighing more than 70 pounds. Place the sticker to the right of the address label and write the package's weight in the white box. It also helps to highlight every side of your package with Heavy Package highlight tape. This sends a warning to those who risk lifting your package, both your employees and ours. Customers with a UPS account can request supplies, free of charge. [Order Supplies and Forms](#) by visiting [ups.com](#). Refer to page [122](#) for fees.



Tires

Apply a wide band of pressure-sensitive tape through the center and completely around the body of the tire so that the tape is attached to itself. Attach your address label to the tape band where it covers the tread. Cover the entire label with clear tape. An Additional Handling charge will apply. Refer to page [122](#) for more information.



Packaging Assistance

Packaging Advisor

The Packaging Advisor is an online tool that takes the guesswork out of packing and helps you determine just what you need by walking you through industry guidelines. Depending on your entries, the Packaging Advisor will provide guidelines about exterior carton, interior cushioning, product placement, closure and shipping label placement. Visit [ups.com/packaging](#).

UPS Package Design and Test Lab

The UPS Package Design and Test Lab helps customers find effective, sustainable and cost-efficient packaging for products. Packaging engineers evaluate the current or proposed package, conduct a variety of industry-accepted tests and prepare a written report that recommends modifications to improve performance, economy and efficient use of materials. The UPS Package Design and Test Lab also monitors the latest developments in package-testing research worldwide. And the UPS Package Design and Test Lab can assist in finding environmentally friendly packaging solutions that provide adequate product protection. Contact the UPS Package Design and Test Lab at 1-877-877-7229 for more details and pricing information.

Packing Services

Have your items organized and expertly packed at your nearest location of The UPS Store®. Many locations of The UPS Store also offer custom handling and packaging for large items – from blanket wrap to custom cartons and crating. Regardless of the size and shape of your items, locations of The UPS Store can handle your shipping needs, including LTL shipments. With the Pack & Ship Guarantee, participating locations will pack your item, ship via UPS, and if that item is damaged or lost in transit, you'll be reimbursed. Visit [theupsstore.com/guarantee](#) for details. For more information on all the services available at The UPS Store or to find a location near you, please visit [theupsstore.com](#).

Packaging Guidelines

UPS WORLDWIDE EXPRESS FREIGHT® MIDDAY, UPS WORLDWIDE EXPRESS FREIGHT®, UPS WORLDWIDE EXPEDITED® GROUND FREIGHT, AIR FREIGHT AND LESS-THAN-TRUCKLOAD

Preparing Your Freight Shipment

UPS Worldwide Express Freight Midday and UPS Worldwide Express Freight (“UPS Worldwide Express Freight Services”)

UPS Worldwide Express Freight Services are for palletized shipments. Pre-authorization is required for all pallets exceeding maximum size or weight restrictions (which vary by origin and destination) as set forth at [ups.com/assets/resources/media/wwef_max_dim.pdf](https://www.ups.com/assets/resources/media/wwef_max_dim.pdf). For UPS Worldwide Express Freight Services, scheduling a pickup or drop-off is required on all shipments through WorldShip®, [ups.com](https://www.ups.com) shipping and UPS CampusShip® systems, a UPS Ready® solution, UPS® Developer Kit, [ups.com](https://www.ups.com) or by calling 1-800-782-7892.

Air Freight, LTL and UPS Worldwide Expedited Ground Freight

Air Freight, LTL and UPS Worldwide Expedited Ground Freight shipments can include combinations of palletized items or boxes that are too large to ship using other UPS services. They can also include multiple non-palletized pieces. UPS will accept freight shipments of any weight. However, minimum weight charges apply. Pre-authorization is required for Air Freight and UPS Worldwide Expedited Ground Freight shipments that exceed 120 inches in length, 84 inches in width, 76 inches in height or 5,000 pounds in weight.

Palletized Freight

Palletizing freight helps multiple-piece shipments remain together and provides increased protection from damage. Each pallet, including its contents, is considered one piece.

Non-Palletized Freight

Loose items, such as boxes or containers that have not been secured to a pallet, are considered non-palletized freight. Each loose item is considered one piece and can be shipped via Air Freight, LTL or UPS Worldwide Expedited Ground Freight services.

Palletizing Your Shipment

Pallets are portable rigid platforms used to consolidate shipments and allow for ease of freight movement. Quality pallets are commonly made of either wood or plastic and can weigh between 20 and 70 pounds. Pallets should be large enough to accommodate the shipment without

overhang. Anything overhanging the pallet edges may be damaged from punctures, abrasions and compression.

UPS Worldwide Express Freight Midday and UPS Worldwide Express Freight shipments must be palletized, stackable, able to be lifted by forklift

and shrink-wrapped or banded to the pallet. For Air Freight or UPS Worldwide Expedited Ground Freight shipments, if your non-palletized shipment does not meet the minimum billable weight per piece, consider palletizing prior to UPS pickup.

Step-by-Step

The following are basic step-by-step instructions for palletizing your freight shipments.

1. Select Pallets.

- Choose pallets large enough to prevent overhang of shipment pieces
- Pallets must be sturdy enough to support the load
 - Select pallets with closely spaced pallet deck boards
 - Never exceed the rated capacity of your pallet
- Do not select pallets with broken boards or protruding nail heads

Palletizing Your Shipment

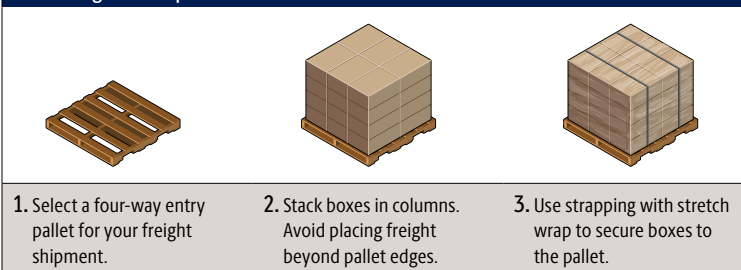

1. Select a four-way entry pallet for your freight shipment.

2. Stack boxes in columns. Avoid placing freight beyond pallet edges.

3. Use strapping with stretch wrap to secure boxes to the pallet.

- Pallets with four-way forklift entry are preferred as they help to improve handling and reduce damage to the shipment

2. Stack Boxes on Pallet.

For shipments that contain boxes or stackable pieces:

- Ensure cartons are new and of proper strength to withstand stacking

Many of The UPS Store® locations can handle LTL freight packaging and shipping for you. Visit theupsstore.com for more information.

Packaging Guidelines

UPS WORLDWIDE EXPRESS FREIGHT® MIDDAY, UPS WORLDWIDE EXPRESS FREIGHT®, UPS WORLDWIDE EXPEDITED® GROUND FREIGHT, AIR FREIGHT AND LESS-THAN-TRUCKLOAD

Step-by-Step (continued)

- Securely close, staple and/or seal cartons
- Protect product from internal vibration with proper amounts of dunnage within cartons; no void areas/spaces between product or on top of carton
- Remove old labels from shipping cartons and product
- Affix labels, with complete address information for the shipper and the consignee, to each piece
- Align boxes in columns, corner to corner, for the greatest stacking strength
- Avoid interlocking or rotating layer patterns
- Do not align corners over the spaces between pallet deck boards
- Boxes should not extend past the pallet edges
- Do not pyramid the boxes; keep the top layer flat to prevent damage from top loads
- Use a slip sheet under the load and every third layer when possible to

help distribute the weight evenly and protect the bottom layer

3. Secure Shipment to Pallet.

- Use a minimum of 60 gauge stretch wrap, five revolutions recommended; tie to pallet and across top to prevent shifting
- For Air Freight, LTL and UPS Worldwide Expedited Ground Freight, label all handling units with shipper/consignee information and PRO Numbers (at minimum all four vertical sides, interior and exterior of the stretch wrapping); use markers if having adhesion issues
- To ensure stability, corner boards and banding are recommended
- Use three-way locking – nailed corners (not staples) on crates; angle board must extend from the deck board to the top of the pallet load
- Insert layers of cardboard between layers of freight to absorb vibration; distribute the weight evenly

4. Label Shipment.

- For UPS Worldwide Express Freight Midday and UPS Worldwide Express Freight shipments, apply labels to each side of the pallet and on top of the pallet. Each label should have telephone numbers and complete address information, including postal code of the shipper and the consignee
- For Air Freight and UPS Worldwide Expedited Ground Freight, label each pallet with telephone numbers and complete address information, including postal code of the shipper and the consignee
- Ensure information on the Bill of Lading (BOL) matches the shipment
- Indicate in proper location on the BOL and check contract/tariff for liability limits if excess declared value is needed
- Do not pyramid, ship or accept prohibited items or freight that overhangs the pallet

Protecting Your Palletized Shipment from Damage

Solution	Description
Corner/Edge Boards	<ul style="list-style-type: none"> – Increase vertical stacking strength, prevent damage to corner edges and stabilize the load. – Should extend to the full height and length of the load and should be used on all corners.
Strapping or Banding	<ul style="list-style-type: none"> – Prevents pieces from getting lost or separated from the load. – Should be drawn tightly to the load, possibly requiring running it underneath the top deck boards of the pallet.
Stretch Wrapping	<ul style="list-style-type: none"> – Use as an effective way to keep all pieces of a shipment together. – Should first be applied around the pallet and continued upward around the load. – Must be tight to prevent load shifting. – Capture the pallet when wrapping bottom layer. – Designed to stabilize the load, not to secure it to the pallet. – Strapping or banding should be used in conjunction with stretch wrap to secure the load to the pallet.
Top/Bottom Load Protector	<ul style="list-style-type: none"> – Layers of corrugated fiberboard or heavy paperboard. – Use to help evenly distribute the weight of shipments that can be stacked upon one another.

For any additional assistance with freight packaging, contact the UPS Package Design and Test Lab at freight_testing@ups-psi.com or call 1-877-877-7229.

Packaging Guidelines

UPS WORLDWIDE EXPEDITED® GROUND FREIGHT, AIR FREIGHT AND LESS-THAN-TRUCKLOAD

Preparing Non-Palletized Freight

If you do not plan to secure your shipment to pallets, follow the steps below.

1. Ship freight in corrugated boxes (avoid reusing boxes), crates or shipping containers.
2. Use a container strong enough to support the weight of contents.

3. Use at least two inches of appropriate cushioning material to protect internal items from each other and the corners, sides, top and bottom of containers. Appropriate cushioning material would include corrugated fiberboard, multiple layers of folded newspaper, styrofoam sheets, packing blankets, etc.

4. Reinforce edges to protect from bending.

5. Securely seal closures and seams with reinforced tape.

6. Label each piece with telephone numbers and complete address information, including postal code of the shipper and the consignee.

Preparing for Pickup

Your freight pickup request is initiated when you Create a Shipment for freight using [ups.com](https://www.ups.com), WorldShip® or MyFreight shipping tools.

Some Air Freight and UPS Worldwide Expedited Ground Freight shipment pickup requests require pre-authorization.

Pickups for UPS Freight® LTL shipments can be requested using [ups.com](https://www.ups.com), [upsfreight.com](https://www.upsfreight.com) or WorldShip.

How to Label

Each piece of palletized or non-palletized freight must be clearly marked with telephone numbers and complete address information, including postal code of the shipper and the consignee. Indicate on freight labels if any pieces require C.O.D. service.

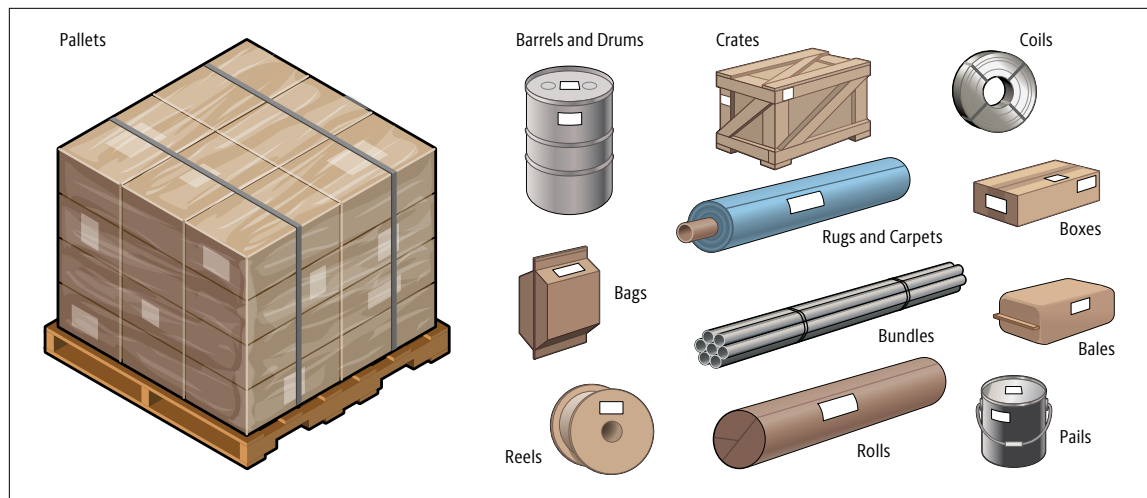

Note: UPS Worldwide Express Freight Services do not accept non-palletized freight shipments.

Determine the Weight and Size

PACKAGE

For All Domestic and International Shipments

The Determine the Weight and Size information on this page and the next page are for package shipments only. For information on how to determine the weight and size for UPS Worldwide Express Freight® Midday and UPS Worldwide Express Freight® shipments refer to page 18. For information on how to determine the weight and size for UPS® Simple Rate shipments, refer to page 72.

Shipping rates are based on package weight and size (explained below and on the following page) and origin-to-destination distance (refer to page 27 for Domestic, Export and Import).

Billable weight is the weight used to calculate the rate. For domestic and international services, the billable weight will be the greater of the dimensional weight compared to the actual weight.

How to determine billable weight.

1. Determine actual weight.

Actual weight is the package weight rounded up to the next whole pound.

Use a scale to determine the weight of the package. Round any fraction of a pound to the next whole pound for UPS Express® Envelopes (letters) over eight ounces and all other packages.

2. Determine dimensional weight.

Dimensional weight reflects package density, which is the amount of space a package occupies in relation to its actual weight. Dimensional weight may apply to all UPS domestic and international package services.

Determine the package dimensions in inches. For each dimension, measure at the longest point, rounding each measurement to the nearest whole number (for example, 1.00 to 1.49 will be considered 1, and 1.50 to 1.99 will be considered 2). The minimum measurement for each dimension is 1 inch.

Multiply the package length (longest side of the package) by the width by the height. The result is the cubic size in inches.

Divide the cubic size in inches by 139 to determine the dimensional weight in pounds. Increase any fraction to the next whole pound.

3. Determine billable weight.

Compare the package's actual weight to its dimensional weight. The greater of the two is the billable weight and should be used to calculate the rate.

For multiple-package shipments eligible for shipment pricing, total the billable weight of all packages in the shipment.

Notes:

- Shipment pricing is not available for a service unless specifically noted.
- For information on how to determine the rate applicable to UPS® Ground with Freight Pricing, see page 6 and visit ups.com/gfp.
- For information on how to determine the rate applicable to UPS Simple Rate shipments, see pages 72-73 and visit ups.com/simplerate.

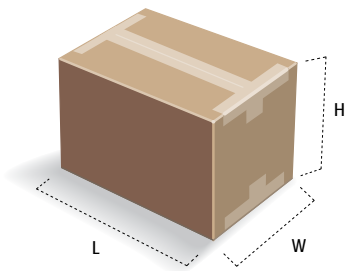

Dimensional Weight Calculation

$$\left[\begin{array}{l} \text{Dimensional Weight} \\ \text{in Pounds} \end{array} \right] = \frac{L \times W \times H}{139}$$

L = Length in inches

W = Width in inches

H = Height in inches

Determine the Weight and Size

PACKAGE

For All Domestic and International Shipments (continued)

Additional Information on Determining Weight and Size.

– **Letter rates** apply for domestic and international documents, correspondence and electronic media shipments that do not exceed eight ounces sent in a UPS Express® Envelope. Domestic Letters greater than eight ounces will be billed by weight (rounded up to the next whole pound). Export Letters greater than eight ounces and up to two pounds will be billed at UPS Express® Pak rates. Export Letters greater than two pounds and import Letters greater than eight ounces will be billed by weight (rounded up to the next whole pound).

– **UPS Express Pak rates** apply for export shipments that weigh two pounds or less, do not exceed \$100.00 in customs value and UPS Express Pak is selected at the time of shipping.

– Irregularly Shaped Packages:

If the package has a bulge or is irregularly shaped, measure the length, width and height of the package at its extreme points, which may include the bulge or irregular aspects of the package.

Treat the irregularly shaped package as if it were in a regular rectangular box. Measure the length, width and height of the package from its extreme points.

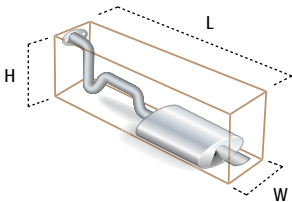

– Items Shipped in Bags:

Shape – When multiple items are shipped in a flexible container (e.g., burlap or plastic bag), the package measurements will be determined when the exterior is at rest. As this shape will differ from placement to placement, cubic size or package measurements will be made at the sole discretion of UPS.

Tails – A tail on an item shipped in a bag should be measured for the amount of space it takes up in a reasonably compressed fashion. Any tail that is created by placing an item in a bag must be compressed and taped to the body of the item.

– Packages that exceed UPS weight and size limits are not accepted for transportation. If found in the UPS system, they are subject to an Over Maximum Limits charge. UPS reserves the right in its sole and unlimited discretion to return such packages to the shipper at the shipper's expense. Refer to page 124 for more information. For Maximum Weight service restrictions, refer to page 8. For shipments over 150 pounds other than UPS Worldwide Express Freight® services, refer to pages 74-75 for Air Freight, page 6 for UPS Freight® Less-Than-Truckload or Coyote Logistics® Truckload and page 5 for UPS Worldwide Expedited® Ground Freight for more information.

– **A Large Package Surcharge** may apply to domestic and international shipments.

For domestic shipments, a package is considered a "Large Package" when its length (longest side of the package)

plus girth [(2 x width) + (2 x height)] combined exceeds 130 inches or its length exceeds 96 inches.

For international shipments, a package is considered a "Large Package" when its length (longest side of the package) plus girth [(2 x width) + (2 x height)] combined exceeds 130 inches.

Large Packages are subject to a minimum billable weight of 90 pounds. An Additional Handling charge will not be assessed when a Large Package Surcharge is applied.

– Shippers are responsible for providing accurate and complete shipment information on the shipping document or in the automated processing system used, including service selected, number, weight and dimensions of packages. UPS reserves the right to audit any package and/or invoice to verify service selection, package dimensions or weight and applicability of any charges. As part of that audit, UPS may weigh and measure any package tendered to UPS using any method UPS deems appropriate, including, but not limited to, multi-dimensional measuring devices. If any aspect of the shipment information provided by the shipper is incomplete or incorrect as determined by UPS in its sole and unlimited discretion, UPS may in its sole and unlimited discretion adjust charges at any time.

Follow the instructions on this page and the previous page to determine the billable weight for your package shipments. Refer to page 18 for UPS Worldwide Express Freight Services.

Notes:

- Size limits indicated by a box manufacturer may not reflect exterior dimensions of a package, including where a package may have bulges or otherwise may not be uniform across each plane, and should not be used as a substitute for actual length, width and height measurements in determining dimensional weight.
- Improper packaging may result in the alteration of a package's dimensions during transit which can affect the package's dimensional weight and result in a shipping charge correction.

To Destinations Worldwide

Determine the Weight and Size

UPS WORLDWIDE EXPRESS FREIGHT® MIDDAY AND UPS WORLDWIDE EXPRESS FREIGHT®

For International Palletized Shipments

Shipping rates are based on the shipment weight, including the weight of the pallet, and size and origin-to-destination distance (refer to page 27 for Export and Import).

Billable weight is the weight used to calculate the rate. The billable weight will be the greater of the dimensional weight as compared to the actual weight.

How to determine billable weight.

1. Determine actual weight.

Actual weight is the weight of the items on the pallet and the weight of the pallet, rounded up to the next whole pound.

Use a scale to determine the weight. Round any fraction of a pound to the next whole pound.

2. Determine dimensional weight.

Dimensional weight reflects pallet density, which is the amount of space a pallet occupies in relation to its actual weight. Dimensional weight may apply to all UPS Worldwide Express Freight Midday or UPS Worldwide Express Freight shipments.

Determine the pallet dimensions in inches. For each dimension, measure at the longest point, rounding each measurement to the nearest whole number (for example, 1.00 to 1.49 will be considered 1, and 1.50 to 1.99 will be considered 2). The minimum measurement for each dimension is 1 inch.

Multiply the pallet length by the width and by the height. The result is the cubic size in inches.

For export and import shipments, divide the cubic size in inches by 139 to determine the dimensional weight. Increase any fraction to the next whole pound.

3. Determine billable weight.

Compare the pallet's actual weight to its dimensional weight. The greater of the two is the billable weight and should be used to calculate the rate.

Additional Information on Determining Size and Weight.

– Pallets that exceed maximum size or weight restrictions (which vary by origin and destination) as set forth at [ups.com/assets/resources/media/wwef_max_dim.pdf](https://www.ups.com/assets/resources/media/wwef_max_dim.pdf) require prior approval, and are subject to an Oversize Pallet Handling Surcharge. Refer to page 124 for more information.

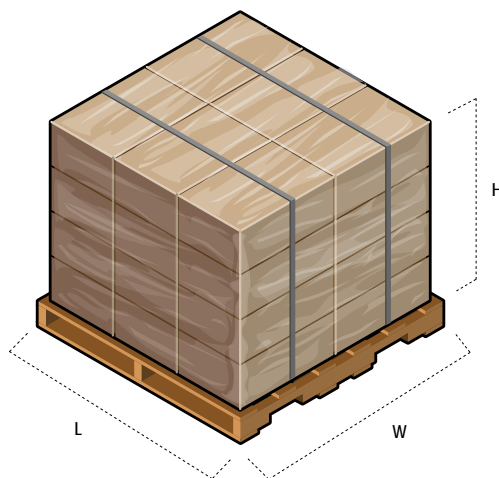

U.S. Export and Import

$$\left[\begin{array}{l} \text{Dimensional Weight} \\ \text{in Pounds} \end{array} \right] = \frac{L \times W \times H}{139}$$

L = Length in inches

W = Width in inches

H = Height in inches

Billable Weight Calculation

Customer has a shipment with 3 pallets weighing 600 pounds, 800 pounds and 1,000 pounds. All pallets are the same size with the following dimensions: 48 in. x 40 in. x 60 in.

1. Determine actual weight.

$$\text{Actual Weight} = 600 \text{ lbs.} + 800 \text{ lbs.} + 1,000 \text{ lbs.} = 2,400 \text{ lbs.}$$

2. Determine dimensional weight.

$$\text{Pallet Dimensional Weight} = \frac{48 \text{ in.} \times 40 \text{ in.} \times 60 \text{ in.}}{139} = 829 \text{ lbs.}$$

$$\text{Shipment Dimensional Weight} = 829 \text{ lbs.} + 829 \text{ lbs.} + 1,000 \text{ lbs.} = 2,658 \text{ lbs.}$$

3. Determine billable weight.

$$\text{Shipment Billable Weight} = 2,658 \text{ lbs.}$$

To Destinations Worldwide

Determine the Weight and Size

AIR FREIGHT AND UPS WORLDWIDE EXPEDITED® GROUND FREIGHT

How to Determine Billable Weight*

Compare the freight shipment's minimum billable weight, actual weight and dimensional weight. The greatest of the three is the billable weight and should be used to calculate the rate.

1. Determine minimum billable shipment weight.*

- Minimum billable weight for loose items is the greater of minimum weight per shipment multiplied by the minimum weight per piece as set forth in the table below.

Service	Minimum Weight per Piece	Minimum Weight per Shipment
UPS Next Day Air® Freight	20 Pounds	151 Pounds
UPS Next Day Air® Freight NGS		
UPS 2nd Day Air® Freight		
UPS 2nd Day Air® Freight NGS		
UPS 3 Day Freight®		
UPS 3 Day Freight® NGS		
UPS Worldwide Expedited Ground Freight	N/A	551 Pounds

*The minimum billable shipment weight applies to all Air Freight services within and between the U.S., Canada and Puerto Rico. For UPS Worldwide Expedited Ground Freight, use minimum weight per shipment as defined above. For UPS Air Freight Direct® and UPS Air Freight Consolidated® services, a minimum shipment dollar amount is applied. Refer to the "UPS Air Freight Terms and Conditions of Contract for UPS Air Freight Services in the United States, Canada and International" at [ups-scs.com/terms](https://www.ups.com/terms) for more information or call 1-800-443-6379.

2. Determine actual weight and round up any fraction of a pound or kilo to the next whole pound or kilo.

3. Determine dimensional weight.

For each dimension, measure at the longest point, rounding each measurement to the nearest whole number. The minimum measurement for each dimension is 1 inch. Multiply the shipment length by the width by the height. The result is the cubic size. Divide the cubic size by the dimensional weight factor located in the matrix below to determine the dimensional weight.

Service	Origin	Destination	Dimensional Weight Factor (Inches/Pounds)	Dimensional Weight Factor (Centimeters/Kilos)
UPS® Air Freight Premium Direct	All	All	139	5,000
UPS Air Freight Direct UPS Air Freight Consolidated	All	All	166	6,000
UPS Next Day Air Freight UPS Next Day Air Freight NGS UPS 2nd Day Air Freight UPS 2nd Day Air Freight NGS UPS 3 Day Freight UPS 3 Day Freight NGS	PR, CA and U.S.	PR, CA and U.S.	139	5,000
UPS Worldwide Expedited® Air Freight	U.S.	MX	139	5,000
	MX	U.S.		
UPS Worldwide Expedited Ground Freight	U.S.	MX		
	MX	U.S.		

To convert metric measurements into pounds, multiply the result by 2.20462. To convert imperial measurements into kilos, multiply the result by 0.453592. Increase any fraction to the next whole pound or kilo.

The chart on the next page provides examples of billable weight calculations for Air Freight shipments.

To Destinations Worldwide

Determine the Weight and Size

AIR FREIGHT

Examples on How to Determine Billable Weight for Air Freight Shipments*

Freight Billable Weight: Minimum Billable Shipment Weight – Within and between the U.S., Canada and Puerto Rico											
Number of Pieces	Type	Length Each	Width Each	Height Each	Weight Each	Min. Billable Weight	Actual Weight	Dimensional Weight @ 139	Billable Weight		
5	Loose items	10"	10"	10"	20 lbs.	151 lbs.	100 lbs.	36 lbs.	151 lbs.		
Freight Billable Weight: Minimum Billable Weight Per Piece – Within and between the U.S., Canada and Puerto Rico**											
Number of Pieces	Type	Length Each	Width Each	Height Each	Weight Each	Min. Billable Weight	Actual Weight	Dimensional Weight @ 139	Billable Weight		
20	Loose items	10"	10"	10"	15 lbs.	20 lbs.	300 lbs.	144 lbs.	400 lbs.		
Freight Billable Weight: Actual Weight											
Number of Pieces	Type	Length Each	Width Each	Height Each	Weight Each	Min. Billable Weight	Actual Weight	Dimensional Weight @ 166	Dimensional Weight @ 139	Billable Weight	
20	Loose items	10"	10"	10"	25 lbs.	151 lbs.	500 lbs.	121 lbs.	144 lbs.	500 lbs.	
Freight Billable Weight: Dimensional Weight											
Number of Pieces	Type	Length Each	Width Each	Height Each	Weight Each	Min. Billable Weight	Actual Weight	Dimensional Weight @ 166	Dimensional Weight @ 139	Billable Weight	
2	Loose items	30"	25"	20"	70 lbs.	151 lbs.	140 lbs.	181 lbs.	216 lbs.	216 lbs.	
Freight Billable Weight: Using a Pallet***											
Number of Pieces	Type	Length Each	Width Each	Height Each	Shipment Weight	Pallet Weight	Min. Billable Weight	Actual Weight	Dimensional Weight @ 166	Dimensional Weight @ 139	Billable Weight
1	Pallet	35"	35"	35"	315 lbs.	40 lbs.	151 lbs.	355 lbs.	259 lbs.	309 lbs.	355 lbs.

*The minimum billable shipment weight applies to all Air Freight services within and between the U.S., Canada and Puerto Rico. For UPS Air Freight Direct® and UPS Air Freight Consolidated® services, a minimum shipment dollar amount is applied. Refer to the "UPS Air Freight Terms and Conditions of Contract for UPS Air Freight Services in the United States, Canada and International" at [ups.com/terms](https://www.ups.com/terms) for more information or call 1-800-443-6379.

**The minimum billable weight of 20 pounds per loose piece applies to Air Freight within and between the U.S., Canada and Puerto Rico only. If your non-palletized shipment does not meet the minimum weight of 20 pounds per piece, consider palletizing. Palletizing will ensure your shipment does not fall below the per-piece minimum billable charge.

***Pallet billable weight is equal to the shipment weight (315 pounds) plus the weight of a pallet (approximately 40 pounds).

Note: Each pallet with its secured contents is entered as one piece.

Shipping Solutions

Solution	Shipping Environment	Features and Benefits
AUTOMATED PROCESSING		
WorldShip® ups.com/worldship	Centralized Shipping (shipping room, warehouse)*	Full-featured Windows®-based software for Scheduled Pickup customers with high-volume shipping needs: <ul style="list-style-type: none"> – Process UPS package and freight shipments using a single application to obtain a rate quote, schedule pickups, process paperless trade documentation and track shipments. – Choose from several options for inputting shipment data, ranging from manual entry to fully automated, hands-free shipping. – Streamline shipment processing by customizing default settings to match your shipping preferences. – Connect WorldShip software to your accounting and customer service systems for seamless cross-functional communication. – Create custom labels with your company logo or promotional information.
ups.com shipping	Decentralized Shipping (distributed employees, front office, administrative staff, etc.)*	Print UPS labels from your PC via a secure online environment: <ul style="list-style-type: none"> – Web-based shipping system allows anyone in your company to ship from anywhere. – Process UPS package and freight shipments using a single application to obtain a rate quote, schedule pickups, process paperless trade documentation and track shipments. – One-step shipping with shipping preferences and the UPS address book. – View history, track and reprint your Air Freight and UPS Worldwide Expedited® Ground Freight waybill from one page. – Export your history to integrate with other systems. – No software or setup required. – Ship using a UPS account or a credit card or debit card or PayPal® account. – Complete a shipment without registering at ups.com.
UPS CampusShip®	Decentralized Shipping with Centralized Control (distributed employees, front office, administrative staff, etc., with administrator controls)*	Gain control and reporting of your employees' shipping activities in a secure environment, controlled by an administrator: <ul style="list-style-type: none"> – A customized web-based shipping system allows anyone in your company to ship or track from anywhere, but gives complete visibility and control to the shipping decision-maker. – Process UPS package and freight shipments using a single application to obtain a rate quote, schedule pickups, process paperless trade documentation and track shipments. – View history, track and reprint your Air Freight and UPS Worldwide Expedited Ground Freight waybill from one page. – Export your history to integrate with other systems. – No software required. – Visit ups.com/campusship, contact your local representative or call 1-800-PICK-UPS® (1-800-742-5877).
UPS marketplace shipping**	Decentralized Shipping solution powered by ups.com shipping (individual and small to medium businesses that sell on marketplaces)	A secure web-based shipping solution to easily view and ship all your online store orders from one location: <ul style="list-style-type: none"> – Automatically imports online orders from Marketplaces or direct web stores to UPS marketplace shipping. – Simplified shipment processing (Amazon support limited to Professional sellers only). – Ability to sequentially process multiple shipments and combine orders from same buyer and marketplace. – Automatically uploads tracking information back to the online store after processing. – For more information on UPS marketplace shipping visit ups.com.
MyFreight ups-scs.com	Decentralized Air Freight and UPS Worldwide Expedited Ground Freight Shipping (occasional)	A web-based Air Freight and UPS Worldwide Expedited Ground Freight shipping system: <ul style="list-style-type: none"> – A one-stop source to book shipments, request a pickup, create export documents and track shipments. – Perform online shipment initiation, rate quotes, tracking and event notification. – Track shipments using shipment or account numbers.
My LTL Freight upsfreight.com/forms	Decentralized LTL Shipping	Secure website for LTL shipping: <ul style="list-style-type: none"> – Create an electronic Bill of Lading, get account-specific negotiated rates and view shipping images. – Enables you to schedule a pickup, request delivery and pickup notifications and track a shipment.
Coyote Logistics® coyote.com	Truckload and Intermodal Freight Management Portal	Provides direct access for customers to create, view, track and settle their own loads, and for carriers to find, accept and update loads. <ul style="list-style-type: none"> – Network map includes filters to provide a focused, filtered view and ability to hover over lane to see lane information. – Streamlined accounting features allows for uploading paperwork, viewing invoices and checking accounting status. – Customizable load board allows users to add or remove columns to view the most valuable information. – Call 1-877-626-9683 or coyote.com/technology for more information.

*Applies to all UPS services except UPS Express Critical®, Truckload, Intermodal, Ocean Freight shipping. UPS® Simple Rate shipments may not be available through all UPS shipping systems.

**UPS marketplace shipping is not sponsored or endorsed by participating third-party marketplaces. Your use of the third-party marketplace remains subject to any applicable policies and terms and conditions of that third-party marketplace.

Notes:

- Hazardous Materials requiring shipping papers and International Dangerous Goods requiring a "Shipper's Declaration for Dangerous Goods" are not accepted through the UPS CampusShip shipping system.
- For Air Freight and UPS Worldwide Expedited Ground Freight services accessed through UPS CampusShip or ups.com shipping systems, a UPS call center or UPS Customer Center, a valid UPS six-character account number or a nine-digit UPS Supply Chain Solutions® account number is required for all shipments.
- The UPS Ready Program allows third-party business and shipping applications to integrate UPS technology, providing customers access to UPS products and services through out-of-the-box integrated solutions.

Shipping Solutions

Solution	Shipping Environment	Features and Benefits
AUTOMATED PROCESSING (continued)		
UPS® Mobile App for Android® and iOS® Devices*	Decentralized Mobile Package Shipping (distributed employees, professionals on the road)	Supports shipments originating from 83 countries and territories. Create shipments when you are on the go: <ul style="list-style-type: none"> – Process package shipments using supported smartphones. – Same login as ups.com. – Access to ups.com shipping optimized for mobile users. – Use the stored information from your UPS address book, shipping and payment preferences. – Shipping label options include: e-mail a shipping label, print from phone and mobile barcode. – Use your UPS account, credit card, debit card or electronic payment method. – Visit ups.com/mobile to learn more or to download the app.
Coyote Logistics® CoyoteHOWL® Mobile App for Shippers	Mobile Truckload and Intermodal Shipping	CoyoteHOWL® mobile app is an internally developed, constantly evolving customer support tool that allows shippers to easily connect with their Coyote reps and access shipments, documents and business trends right from their mobile phones. It offers ability to receive load updates via push notifications and provides shippers free, on-the-go visibility 24/7. Visit noexcuses.coyote.com/CoyoteHOWL to learn more.
UPS® Developer Kit	Integrated Enterprise and e-Commerce Applications**	– Suite of Application Programming Interfaces or APIs that provides your programmers and integrators flexibility when integrating UPS shipping functionality directly into your business systems and websites. APIs improve efficiencies through automation of business processes: <ul style="list-style-type: none"> • Utilizes XML and web services technologies. • Gives you access to as many UPS services as you choose. – Other UPS Developer Kit APIs include: Address Validation, Locator (and Plug In), Pickup, Quantum View®, Rating, Tracking (Signature Tracking®), Time in Transit and UPS TradeAbility®.
UPS Smart Label®	Provided by WorldShip®, ups.com shipping, UPS CampusShip® shipping systems, the UPS® Developer Kit and UPS Ready® solutions.	UPS Smart Label data includes barcodes and routing codes that help ensure accurate routing and prompt delivery of your shipments. In addition, the use of UPS Smart Label technology allows for fast access to tracking and delivery information. We also offer printers for UPS Smart Label thermal printing. UPS account holders can rent a thermal label printer for \$3.00 per week by calling 1-800-PICK-UPS® (1-800-742-5877).
Solution Features and Benefits		
MANUAL PROCESSING – PACKAGE		
Air Shipping Documents (ASDs)		– Available for UPS Next Day Air® Early, UPS Next Day Air®, UPS Next Day Air Saver®, UPS 2nd Day Air A.M.® and UPS 2nd Day Air® services. May also be used for UPS Worldwide Express® service. Does not apply to UPS® Simple Rate shipments. <ul style="list-style-type: none"> – To request an ASD, visit “Order Supplies” from the left side of the ups.com homepage. – For Saturday Delivery, each UPS Express® Envelope or package must bear a Saturday Delivery routing label.
UPS 3 Day Select® and UPS® Ground Shipping Documents		– Attach the completed form to the package and schedule a pickup via ups.com . <ul style="list-style-type: none"> – A \$5.00 per-package shipping document processing (S.D.P.) fee applies whenever a shipping document is used for UPS 3 Day Select or UPS Ground shipments. – To request a shipping document, visit “Order Supplies” at ups.com. – Does not apply to UPS® Simple Rate shipments.
UPS Worldwide Services Waybill		– Designed for international shipments: <ul style="list-style-type: none"> • Detailed information fields to fully address your shipment. • Various billing options to specify how payment of charges is handled. • Shipment-level detail enables shipment pricing and shipment tracking. • With proper authorization, U.S. Electronic Export Information (E.E.I.) will be filed electronically by UPS on your behalf. Refer to page 116 for fees. – When you use a UPS Worldwide Services Waybill for UPS Worldwide Express Freight® Midday or UPS Worldwide Express Freight® shipments, use one per shipment. <ul style="list-style-type: none"> • Packages within the pallet do not require an address label or UPS Worldwide Services Tracking Label. • For all shipments, call 1-800-782-7892 or go to ups.com to schedule pickup or drop-off. – When you use a UPS Worldwide Services Waybill for multiple-package or multiple-pallet shipments to the same recipient, only the lead package or pallet requires a waybill. <ul style="list-style-type: none"> • Each additional package or pallet must have an address label and a UPS Worldwide Services Tracking Label. • Detailed preparation instructions are printed on the reverse side of the waybill. – To request a UPS Worldwide Services Waybill, visit ups.com .
MANUAL PROCESSING – LTL		
Bill of Lading		– The Bill of Lading, usually prepared by the shipper, serves as a contract and provides all the information that UPS needs to transport the shipment. You can use ups.com shipping, WorldShip, UPS CampusShip or My LTL Freight shipping tools to process LTL shipments and quickly create an electronic Bill of Lading.

*Not available for UPS Worldwide Express Freight Services or UPS Simple Rate.

**Applies to all UPS services except UPS Express Critical®, Truckload, Intermodal, Ocean Freight or UPS Simple Rate shipments.

Note: Hazardous Materials and Dangerous Goods service is not available when using manual documentation (Air Freight and LTL are supported).

Pickup and Drop-off Availability

Arrange for a UPS Pickup

Method	Description
PACKAGE	
Scheduled Pickup*	<ul style="list-style-type: none"> – UPS offers the greatest number of reliable and convenient pickup options: <ul style="list-style-type: none"> • Daily Pickup • Daily On-Route Pickup • UPS Smart Pickup® service • Day-Specific Pickup – Refer to page 120 (domestic shipments). – Not available for UPS Worldwide Express Freight® Services.
UPS On-Call Pickup®	<ul style="list-style-type: none"> – With one pickup request, UPS will pick up all of your packages – Air, International, UPS 3 Day Select® and Ground services. – Schedule a same-day or future-day pickup. – UPS On-Call Pickup service gives you the convenience of having your shipment picked up at your home or office by scheduling a pickup via ups.com. – Fees are applied per pickup request regardless of the number of packages being picked up. – Refer to page 118 for domestic and export shipment fees. <p>UPS Worldwide Express Freight® Midday and UPS Worldwide Express Freight</p> <ul style="list-style-type: none"> – Pickup or drop-off must be scheduled for each UPS Worldwide Express Freight Midday or UPS Worldwide Express Freight shipment via WorldShip® or UPS CampusShip® shipping systems, ups.com shipping, a UPS Ready® solution, UPS® Developer Kit, ups.com or by calling 1-800-782-7892. – UPS Worldwide Express Freight Midday and UPS Worldwide Express Freight pickups cannot be combined with Air, International or UPS 3 Day Select services package pickup. – No additional fees are applied for pickup requests.
AIR FREIGHT AND UPS WORLDWIDE EXPEDITED® GROUND FREIGHT	
UPS Supply Chain Solutions® Call Centers	– Call 1-800-443-6379 to schedule a pickup.
UPS FREIGHT® SERVICES	
UPS Freight® LTL	<ul style="list-style-type: none"> <li style="width: 50%;">– UPS Freight LTL 1-800-333-7400 <li style="width: 50%;">– UPS® Standard LTL 1-800-333-7400 <li style="width: 50%;">– LTL Guaranteed 1-800-333-7400 <li style="width: 50%;">– Trade Show 1-800-988-9889 <li style="width: 50%;">– LTL Guaranteed A.M. 1-800-333-7400 <li style="width: 50%;">– Temperature Protection 1-800-644-0900 <li style="width: 50%;">– LTL Urgent 1-800-644-0900
Pickup Notifications for LTL	<ul style="list-style-type: none"> – UPS Freight LTL pickups scheduled via WorldShip shipping system, ups.com and upsfreight.com include the option to receive Pickup Notifications at no additional cost. Pickup Notifications provide near real-time visibility of the status of a scheduled pickup, providing vital supply chain information to the pickup scheduler and shipper. – Available for direct point service areas within the 48 contiguous states. – When scheduling a pickup, users can choose up to five e-mail addresses to receive notifications for any and all of the following: <ul style="list-style-type: none"> • Pickup Scheduled • Driver en Route • Pickup Completed • Pickup Exception
COYOTE LOGISTICS®	
Truckload and Intermodal	Call 1-877-626-9683 or visit coyote.com .

*Service for Hazardous Materials and International Dangerous Goods requiring shipping papers or "Shipper's Declaration for Dangerous Goods" is offered on a contractual basis. Only customers with a Scheduled Pickup account are eligible for these services. Such shipments may not be tendered to a Third-Party Retailer or UPS Access Point® location. Please consult the Hazardous Materials Support Center at 1-800-554-9964 for specific regulatory and service level requirements.

Pickup and Drop-off Availability

Find Locations for Package, UPS Worldwide Express Freight® Midday and UPS Worldwide Express Freight® Shipments

Location	Description
UPS Access Point® (in select areas only)	<p>UPS Access Point locations are independently owned businesses or locations, including local businesses, participating The UPS Store® locations and lockers, that offer package pickup and, where available, drop-off of pre-paid UPS packages.</p> <ul style="list-style-type: none"> – After a first unsuccessful delivery attempt to a consumer's home address, UPS may deliver eligible packages to a nearby UPS Access Point location for the consumer to pick up. – Hours of operation vary by location (many UPS Access Point locations offer evening and weekend hours; visit ups.com for specific details). – Receiving packages: A government-issued photo ID will be required to collect the package. <p>Ship to a UPS Access Point Location Service:</p> <ul style="list-style-type: none"> – Available to all shippers with a valid UPS small package account number. – Available with all UPS small package shipping services* and most value-added services. – Shippers can integrate a UPS Locator into their e-commerce platforms, allowing their customers to select the UPS Access Point delivery location that is most convenient for them. – Only shippers with an approved UPS agreement for transportation of wine/beer/tobacco may ship wine/beer/tobacco to a UPS Access Point location, subject to limitations set forth at ups.com/wine, ups.com/beer and ups.com/tobacco. – For more information and restrictions, go to: ups.com/media/en/ShiptoUPSAccessPointlocation_US_EN.pdf. <p>Additional Service Options for Shipment to a UPS Access Point Location:</p> <ul style="list-style-type: none"> – Deliver to Addressee Only – For added security, the shipment may only be picked up by the person identified on the shipping label (pickup by any third party is not permitted). – Package Release Code – For combined flexibility and security, enter a four- to six-digit numerical code when preparing a shipment and provide the code to the person you want to pick it up. The code is known only to you and the person you provide it to. <p>UPS Access Point Location Restrictions:</p> <ul style="list-style-type: none"> – Packages delivered to a UPS Access Point locker must not exceed 22 inches by 21 inches by 16 inches. Drop-off packages at a UPS Access Point locker are subject to the same dimensional requirement and cannot exceed 44 pounds in weight. – All other packages cannot exceed 44 pounds in weight and the longest side must not exceed 38 inches, and the package must not exceed 130 inches in length plus girth combined. Drop-off packages at The UPS Store locations are subject to the maximum size and weight restrictions set forth in the "UPS Tariff/Terms and Conditions of Service – United States" available at ups.com/terms. For a broader set of shipping solutions, visit your local The UPS Store. – Packages may not have a value of \$5,000.00 or more if delivered or shipped to a UPS Access Point location or a value of \$1,000.00 or more if dropped off as pre-paid UPS packages. – Packages containing restricted or prohibited articles (e.g., hazardous materials requiring shipping papers, firearms, ammunition or weapons). Same restrictions apply to delivered packages, except for ammunition that meets requirements for Limited Quantity (Ltd Qty) packages and all other UPS requirements for ammunition shipments. – Except in limited circumstances, packages requiring an adult signature are not permitted. – Shipper instructions may restrict eligibility.
The UPS Store®**	<ul style="list-style-type: none"> – Offers domestic and international shipping as well as packing services and packaging supplies. – Accepts UPS® Simple Rate shipments with a prepaid label. – More than 4,800 staffed locations. – Full portfolio of business services: packing services, packaging supplies, copying, printing, document finishing, mailbox services and office supplies. – International shipping expertise. – For details on the Pack & Ship Guarantee, visit theupsstore.com/guarantee. – Visit theupsstore.com to find a location.
UPS Drop Box	<ul style="list-style-type: none"> – Use for all domestic and international packages. – Offers latest possible pickup times. – Approximately 36,182 locations. – Ground and Air packages shipped using UPS Returns® and UPS Import Control® services are accepted in any UPS Drop Box. – Packages and UPS Express® Envelopes with a value of more than \$500.00 cannot be shipped via a UPS Drop Box. – Maximum acceptable size for each UPS Drop Box package is 16" x 13" x 3". UPS Simple Rate shipments with a prepaid label are accepted. – Hazardous Materials/Dangerous Goods, including, but not limited to, Ltd Qty shipments prepared under HM-215K, are not accepted in any UPS Drop Box. – Self-service locations available 24 hours a day, seven days a week for your convenience.
UPS Customer Center	<ul style="list-style-type: none"> – UPS-staffed customer shipping locations. – More than 1,000 locations. – Accepts UPS Simple Rate shipments with a prepaid label. – Offers UPS domestic and international shipping as well as packaging supplies and packing services. – Hold for Pickup services available.
UPS Worldwide Express Freight® Center	<ul style="list-style-type: none"> – UPS-staffed locations where shippers may tender international UPS Worldwide Express Freight Midday and UPS Worldwide Express Freight pallets to UPS for transportation and a consignee or other recipient may receive pallets. – UPS Worldwide Express Freight Midday and UPS Worldwide Express Freight shipments must be international, stackable, secured on a pallet and compliant with UPS packaging guidelines. – Pickup or drop-off must be scheduled for each UPS Worldwide Express Freight Midday or UPS Worldwide Express Freight shipment using WorldShip® or UPS CampusShip® shipping systems, ups.com shipping, a UPS Ready® solution, UPS® Developer Kit, ups.com or by calling 1-800-782-7892. – Hours of operation may vary by location. – Only UPS Worldwide Express Freight Midday and UPS Worldwide Express Freight shipments are accepted at these centers.
UPS Alliance Location (Staples)	<ul style="list-style-type: none"> – Offers exclusive access to UPS® services. – More than 1,000 Staples® locations. – Offers UPS domestic and international shipping. – Accepts UPS Simple Rate shipments with a prepaid label.
UPS Authorized Shipping Outlet	<ul style="list-style-type: none"> – Third-party pack-and-ship retailers that offer UPS domestic and international shipping. – Accepts UPS Simple Rate shipments with a prepaid label. – More than 3,400 locations. – Certain restrictions apply; refer to the "UPS Tariff/Terms and Conditions of Service – United States" available at ups.com/terms for more information.

*Not available for UPS Worldwide Express Freight Services.

**The UPS Store locations are independently owned and operated by licensed franchisees of The UPS Store, Inc., a subsidiary of United Parcel Service, Inc.

Notes:

– Visit "Locations" at [ups.com](https://www.ups.com).

– UPS Worldwide Express Freight Midday and UPS Worldwide Express Freight shipments are only accepted at UPS Worldwide Express Freight Centers.

How To Use This Guide

Section 1 CHOOSING A SERVICE

PAGES [3-9](#)

Section 2 PREPARING A SHIPMENT

PAGES [10-24](#)

Section 3

DETERMINING THE RATE

Determine the rates and zones for domestic, export and import shipments. Also, learn about value-added services that are available.

- Review the steps on how to determine the rates for your shipments. Pages [26-27](#)
 - Domestic, Export and Import – Determine the zone destination or origin for your shipment. Pages [28-43](#)
 - Domestic – Determine the UPS service rate for your domestic shipment. Pages [44-73](#)
 - Export – Determine the UPS service rate for your export shipment. Pages [76-93](#)
 - Import – Determine the UPS service rate for your import shipment. Pages [94-111](#)
 - Value-added services, other charges and customs brokerage services for domestic, export and import. Pages [112-138](#)
-

Section 4 TRACKING AND PAYMENT

PAGES [139-144](#)

Domestic, Export and Import

Determine the Rate

All UPS rates are per package for domestic services and per shipment for international services, unless otherwise noted. The following information applies to the rate charts that appear on pages 44-71 for domestic and pages 77-109 for export and import. (Refer to pages 72-73 for UPS® Simple Rate shipments.)

Domestic, Export and Import

- Visit ups.com for guarantee details, service availability, delivery time commitments or to request a pickup.
- Dimensional weight may apply. Refer to pages 16-17 for more information.
- For large or heavy packages, additional charges may apply. Refer to pages 16-17 for large packages and page 12 for heavy packages.
- A Heavy Package sticker is required for any package weighing more than 70 pounds.
- UPS Worldwide Express Freight® services are available for shipments over 150 pounds that are palletized. See pages 80-81 or 98-99 for more information. For additional freight services refer to ups.com/freight.
- Rates do not include a fuel surcharge. For current fuel surcharge rates, visit ups.com/fuelsurcharge. Fuel surcharges do not apply to UPS Simple Rate shipments.
- Peak Surcharges apply to certain packages tendered during Peak Periods. See ups.com/peaksurcharges for details.

Domestic

- For each UPS Next Day Air® Early package with a weight of more than 150 pounds, multiply the weight by the price per pound and add \$30.00. For all other UPS domestic services with a weight of more than 150 pounds, multiply the weight by the price per pound.
- The Letter rate applies only to documents, correspondence and electronic media shipments that do not exceed eight ounces sent in a UPS Express® Envelope. UPS Express Envelopes exceeding eight ounces are subject

to the rate corresponding to the weight of the UPS Express Envelope. UPS Express Envelopes are not recommended for shipments of electronic media containing sensitive personal information.

- Shipments of Hazardous Materials using UPS 3 Day Select® service must be prepared in accordance with the appropriate Air Dangerous Goods requirements. Hazardous Materials contract service is available with a Scheduled Pickup.
- UPS does not accept Hazardous Materials [including but not limited to Limited Quantity (Ltd Qty) and combustibles] in UPS® Ground service destined to and from Alaska; Hawaii; Puerto Rico; Avalon, CA; Catalina Island, CA; Beaver Island, MI; Mackinac Island, MI (winter only); the Bass Islands, OH; Kelleys Island, OH; and San Juan Islands, WA.

Export and Import

- Delivery times may vary by origin and destination postal code.
- The rates shown on pages 77-111 are for shipments originating in the U.S. (export) or destined to the U.S. (import) and billed to a U.S. UPS account number.
- Any fraction of a pound more than the weight shown in the rate chart is rounded up to the next listed weight.
- To determine the rate for international multiple-package shipments, refer to page 76 for export and page 94 for import.
- For UPS Worldwide Express Freight® Middy and UPS Worldwide Express Freight shipments, additional charges may apply to larger pallets. Refer to page 124 for more information. Shipments exceeding maximum size or weight restrictions require prior authorization.
- All UPS Worldwide Express Freight Middy and UPS Worldwide Express Freight shipments require a scheduled pickup or drop-off using WorldShip® or UPS CampusShip® shipping systems, ups.com shipping, a UPS Ready®

solution, UPS® Developer Kit, ups.com or by calling 1-800-782-7892.

- When using a UPS® 10 KG Box or UPS® 25 KG Box, shipments that exceed the maximum weights (10 KG/22 pounds and 25 KG/55 pounds) will be charged the regular UPS Worldwide Express Plus®, UPS Worldwide Express® or UPS Worldwide Saver® rate. Available only when the shipper is paying the shipping charges.

Export

- UPS Express® Pak rates will apply to Letters weighing more than eight ounces, but less than two pounds. UPS Express Pak rates also apply when all the following are met:
 - The shipment weighs two pounds or less. Shipments above two pounds are rated by weight;
 - UPS Express Pak is selected at the time of shipping; and
 - The customs value of the shipment is less than \$100.00.
- The Letter rate applies only to documents, correspondence and electronic media shipments of no commercial value that do not exceed eight ounces sent in a UPS Express Envelope. UPS Express Envelopes containing items other than those listed above or exceeding eight ounces up to two pounds are subject to the UPS Express Pak rate. Shipments greater than two pounds are subject to the rate corresponding to the weight. UPS Express Envelopes are not recommended for shipments of electronic media containing sensitive personal information.

Import

The Letter rate applies only to documents, correspondence and electronic media shipments of no commercial value that do not exceed eight ounces sent in a UPS Express Envelope. Shipments greater than eight ounces are subject to the rate corresponding to the weight. UPS Express Envelopes are not recommended for shipments of electronic media containing sensitive personal information.

Domestic, Export and Import

Determine the Rate and Zone

PACKAGE AND AIR FREIGHT

Determine the Rate

To determine the rate for domestic, export and import packages, including UPS Worldwide Express Freight® Midday, UPS Worldwide Express Freight® and Air Freight shipments, follow the steps below:

	Domestic	Export	Import	Air Freight
1. Choose service	page 4	page 4	page 4	page 5
2. Compute billable weight	pages 16-17	pages 16-18	pages 16-18	pages 19-20
3. Look up shipping zone	page 27	pages 27-38	pages 27-28 , pages 39-43	page 27

4. Calculate the rate: Use WorldShip® or UPS CampusShip® shipping systems, [ups.com](https://www.ups.com) shipping, the UPS® App (package only), the UPS® Developer Kit, a UPS Ready® solution or the “Calculate Time and Cost” application on [ups.com/ctc](https://www.ups.com/ctc) to see the rate for your shipment.*

OR

Follow the steps in the table below to use the rate charts in this guide:

	Domestic	Export	Import	Air Freight
1. Go to applicable rates for service option selected	pages 44-73	pages 77-93	pages 94-111	pages 74-75
2. Match billable weight to appropriate zone	page 27	pages 28-38	pages 28 , 39-43	pages 74-75
3. Additional charges may apply**	pages 112-125	pages 112-125	pages 112-125	pages 126-129

*Rates provided through UPS's shipping systems are estimates only, and other shipping charges, surcharges and value-added service charges may apply based on your shipper characteristics and the characteristics of, and services requested for, shipments actually tendered to UPS.

**Including, but not limited to, surcharges if special options or value-added services are selected. Other surcharges, including surcharges imposed by carriers, also may apply for Air Freight. Contact your local UPS Supply Chain Solutions® service center for details (refer to [ups-scs.com/returns/UPS_GFF_Global%20Directory.pdf](https://www.ups-scs.com/returns/UPS_GFF_Global%20Directory.pdf)).

Determine the Zone

Domestic (including Puerto Rico)

Use your UPS Zone Chart to determine the destination zone for the domestic package or Air Freight service option you've selected.

View or download your UPS Zone Chart at [ups.com/rates](https://www.ups.com/rates).

Export and Import

To find the destination zone that matches the service option you've selected refer to the chart below.

Origin/Destination	Export	Import
48 Contiguous States	pages 28-32	pages 28 , 39-41
Canada	pages 28 , 33-37	page 42
Mexico	page 38	page 43

An Extended Area Surcharge may apply to certain destinations or origins within a country. Extended Area origins are subject to change.

For the most current information, refer to [ups.com/rates](https://www.ups.com/rates) or call 1-800-782-7892.

Notes:

- Not applicable for UPS Express Critical®, UPS Worldwide Expedited® Ground Freight, LTL, Truckload, Intermodal, Ocean Freight, UPS Air Freight Direct®, UPS Air Freight Consolidated® or UPS® Simple Rate services.
- For information regarding pricing for UPS® Ground with Freight Pricing service, refer to page [6](#) and visit [ups.com/gfp](https://www.ups.com/gfp).
- For information regarding pricing for UPS Simple Rate, refer to pages [72-73](#) and visit [ups.com/simplerate](https://www.ups.com/simplerate).

West and East State Classifications

UPS WORLDWIDE EXPEDITED® AND UPS® STANDARD TO CANADA



Use the map above to:

- Determine West and East origin state classifications for UPS Worldwide Expedited shipments.
- Identify state abbreviations for UPS Standard to Canada shipments.

Export

Worldwide Zone Chart

Destination	Zones						Destination	Zones							
	UPS Worldwide Express Plus®	UPS Worldwide Express®	UPS Worldwide Express Freight® Midday	UPS Worldwide Express Freight®	UPS Worldwide Saver®	UPS Worldwide Expedited®		UPS Worldwide Express Plus®	UPS Worldwide Express®	UPS Worldwide Express Freight® Midday	UPS Worldwide Express Freight®	UPS Worldwide Saver®	UPS Worldwide Expedited®		
						WEST	EAST						WEST	EAST	
Afghanistan/AF					408	638	608	Bulgaria/BG	907	907			407	637	607
Aland Islands/AX					403	633	603	Burkina Faso/BF					408	638	608
Albania/AL	908	908			408	638	608	Burundi/BI					408	638	608
Algeria/DZ		908			408	638	608	Cambodia/KH		908			408	638	608
American Samoa/AS		908			408	638	608	Cameroon/CM					408	638	608
Andorra/AD		903			403	633	603	Canada/CA							
Angola/AO					408	638	608	<i>For Canada's zone chart, refer to pages 33 to 37.</i>							
Anguilla/At†					402	632	602	Canary Islands (Spain)/ES					403	633	603
Antigua and Barbuda/AG†					402	632	602	Cape Verde/CV					408	638	608
Argentina/AR†		906		406	406	636	606	Cayman Islands/KY†					402	632	602
Armenia/AM	908	908			408	638	608	Central African Republic/CF					408	638	608
Aruba/AW†		902			402	632	602	Chad/TD					408	638	608
Australia/AU	904	904	404	404	404	634	604	Channel Islands Guernsey/GG, Jersey/JE					403	633	603
Austria/AT	903	903	403	403	403	633	603	Chile/CL†		906	406	406	406	636	606
Azerbaijan/AZ					408	638	608	China, People's Republic of/CN	912	912		412	412	642	612
Azores (Portugal)/PT					403	633	603	Colombia/CO†		906		406	406	636	606
Bahamas/BS†		902			402	632	602	Comoros/KM					408	638	608
Bahrain/BH	905	905		405	405	635	605	Congo, Democratic Republic of/CD					408	638	608
Bangladesh/BD		911		411	411	641	611	Congo, Republic of/CG					408	638	608
Barbados/BB†		902			402	632	602	Cook Islands/CK					408	638	608
Belarus/BY	908	908			408	638	608	Costa Rica/CR†		906	406	406	406	636	606
Belgium/BE	901	901	401	401	401	631	601	Côte d'Ivoire (Ivory Coast)/CI					408	638	608
Belize/BZ†					406	636	606	Croatia/HR		908			408	638	608
Benin/BJ					408	638	608	Curaçao/CW†		902			402	632	602
Bermuda/BM†		902			402	632	602	Cyprus/CY	905	905			405	635	605
Bhutan/BT		911			411	641	611	Czech Republic/CZ	907	907	407	407	407	637	607
Bolivia/BO†		906			406	636	606	Denmark/DK	903	903	403	403	403	633	603
Bonaire/BQ†					402	632	602	Djibouti/DJ					408	638	608
Bosnia/BA	908	908			408	638	608	Dominica/DM†					402	632	602
Botswana/BW					408	638	608	Dominican Republic/DO†		902		402	402	632	602
Brazil/BR†	906	906		406	406	636	606	East Timor (Timor-Leste)/TL					408	638	608
British Virgin Islands/VG†					402	632	602	Ecuador/EC†		906		406	406	636	606
Brunei/BN		905			405	635	605	Egypt/EG		905			405	635	605

†For shipments from Dade or Broward County, Florida, to South America, use zone:

- 921 for UPS Worldwide Express
- 421 for UPS Worldwide Express Freight Midday
- 421 for UPS Worldwide Express Freight
- 421 for UPS Worldwide Saver
- 621 for UPS Worldwide Expedited

For shipments from Dade or Broward County, Florida, to the Caribbean, use zone:

- 920 for UPS Worldwide Express
- 420 for UPS Worldwide Express Freight Midday
- 420 for UPS Worldwide Express Freight
- 420 for UPS Worldwide Saver
- 620 for UPS Worldwide Expedited

Export

Worldwide Zone Chart

Destination	Zones						Destination	Zones							
	UPS Worldwide Express Plus®	UPS Worldwide Express®	UPS Worldwide Express Freight® Midday	UPS Worldwide Express Freight®	UPS Worldwide Saver®	UPS Worldwide Expedited®		UPS Worldwide Express Plus®	UPS Worldwide Express®	UPS Worldwide Express Freight® Midday	UPS Worldwide Express Freight®	UPS Worldwide Saver®	UPS Worldwide Expedited®		
						WEST							EAST	WEST	EAST
El Salvador/SV†				406	406	636	606	Hong Kong/HK	909	909	409	409	409	639	609
England (United Kingdom)/GB	901	901	401	401	401	631	601	Hungary/HU	907	907	407	407	407	637	607
Equatorial Guinea/GQ					408	638	608	Iceland/IS		903			403	633	603
Eritrea/ER					408	638	608	India/IN	911	911	411	411	411	641	611
Estonia/EE		907			407	637	607	Indonesia/ID	904	904		404	404	634	604
Ethiopia/ET					408	638	608	Iraq/IQ					408	638	608
Faeroe Islands (Denmark)/FO					403	633	603	Ireland, Republic of/IE	901	901	401	401	401	631	601
Fiji/FJ		908			408	638	608	Israel/IL		905	405	405	405	635	605
Finland/FI	903	903	403	403	403	633	603	Italy/IT	901	901	401	401	401	631	601
France/FR	901	901	401	401	401	631	601	Ivory Coast (Côte d'Ivoire)/CI					408	638	608
French Guiana/GF†		907			406	636	606	Jamaica/JM†		902			402	632	602
French Polynesia/PF					408	638	608	Japan/JP	913	913	413	413	413	643	613
Gabon/GA					408	638	608	Jersey/JE		903			403	633	603
Gambia/GM		908			408	638	608	Jordan/JO		905			405	635	605
Georgia/GE	908	908			408	638	608	Kazakhstan/KZ		908			408	638	608
Germany/DE	901	901	401	401	401	631	601	Kenya/KE		908			408	638	608
Ghana/GH					408	638	608	Kiribati/KI					408	638	608
Gibraltar/GI					408	638	608	Korea, South/KR	913	913	413	413	413	643	613
Great Britain (United Kingdom)/GB	901	901	401	401	401	631	601	Kosovo/KV	908	908			408	638	608
Greece/GR		903	403	403	403	633	603	Kosrae (Micronesia, Federated States of)/FM					408	638	608
Greenland (Denmark)/GL					403	633	603	Kuwait/KW	905	905		405	405	635	605
Grenada/GD†					402	632	602	Kyrgyzstan/KG		908			408	638	608
Guadeloupe/GP†		902			402	632	602	Laos/LA		908			408	638	608
Guam/GU		904			404	634	604	Latvia/LV		907			407	637	607
Guatemala/GT†		906		406	406	636	606	Lebanon/LB		905		405	405	635	605
Guernsey/GG		903			403	633	603	Lesotho/LS					408	638	608
Guinea/GN					408	638	608	Liberia/LR					408	638	608
Guinea-Bissau/GW					408	638	608	Libya/LY					408	638	608
Guyana/GY†					406	636	606	Liechtenstein/LI		903		403	403	633	603
Haiti/HT†					402	632	602	Lithuania/LT		907			407	637	607
Holland (Netherlands)/NL	901	901	401	401	401	631	601	Luxembourg/LU	901	901		401	401	631	601
Honduras/HN†		906		406	406	636	606	Macau/MO		904			404	634	604

†For shipments from Dade or Broward County, Florida, to South America, use zone:

- 921 for UPS Worldwide Express
- 421 for UPS Worldwide Express Freight Midday
- 421 for UPS Worldwide Express Freight
- 421 for UPS Worldwide Saver
- 621 for UPS Worldwide Expedited

†For shipments from Dade or Broward County, Florida, to the Caribbean, use zone:

- 920 for UPS Worldwide Express
- 420 for UPS Worldwide Express Freight Midday
- 420 for UPS Worldwide Express Freight
- 420 for UPS Worldwide Saver
- 620 for UPS Worldwide Expedited

Export

Worldwide Zone Chart

Destination	Zones						Destination	Zones									
	UPS Worldwide Express Plus®	UPS Worldwide Express®	UPS Worldwide Express Freight® Middy	UPS Worldwide Express Freight®	UPS Worldwide Saver®	UPS Worldwide Expedited®		WEST	EAST	UPS Worldwide Express Plus®	UPS Worldwide Express®	UPS Worldwide Express Freight® Middy	UPS Worldwide Express Freight®	UPS Worldwide Saver®	UPS Worldwide Expedited®	WEST	EAST
Macedonia (FYROM)/MK	908	908			408	638	608	Niger/NE		908			408	638	608		
Madagascar/MG		908			408	638	608	Nigeria/NG	908	908		408	408	638	608		
Madeira (Portugal)/PT					403	633	603	Norfolk Island/NF					408	638	608		
Malawi/MW		908			408	638	608	Northern Ireland (United Kingdom)/GB	901	901		401	401	631	601		
Malaysia/MY		904	404	404	404	634	604	Northern Mariana Islands/MP					408	638	608		
Maldives/MV		908			408	638	608	Norway/NO	903	903		403	403	633	603		
Mali/ML					408	638	608	Oman/OM		905		405	405	635	605		
Malta/MT		908		408	408	638	608	Pakistan/PK		911		411	411	641	611		
Marshall Islands/MH					408	638	608	Palau/PW					408	638	608		
Martinique/MQ†					402	632	602	Panama/PA†		906		406	406	636	606		
Mauritania/MR		908			408	638	608	Papua New Guinea/PG		908			408	638	608		
Mauritius/MU		908			408	638	608	Paraguay/PY†					406	636	606		
Mayotte/YT					408	638	608	Peru/PE†		906			406	636	606		
Mexico/MX	84	84	484	484	484	74	74	Philippines/PH		904		404	404	634	604		
Micronesia (Federated States of)/FM		908			408	638	608	Poland/PL	907	907	407	407	407	637	607		
Moldova/MD	908	908			408	638	608	Ponape (Micronesia, Federated States of)/FM					408	638	608		
Monaco/MC		901		401	401	631	601	Portugal/PT	903	903	403	403	403	633	603		
Mongolia/MN					408	638	608	Puerto Rico/PR									
Montenegro/ME	908	908			408	638	608	<i>Refer to the UPS domestic rates beginning on page 44.</i>									
Montserrat/MS†					402	632	602	Qatar/QA	905	905		405	405	635	605		
Morocco/MA		908		408	408	638	608	Réunion/RE		908			408	638	608		
Mozambique/MZ					408	638	608	Romania/RO	907	907			407	637	607		
Myanmar/MM		911			411	641	611	Rota (Northern Mariana Islands)/MP					408	638	608		
Namibia/NA		908			408	638	608	Russia/RU	907	907			407	637	607		
Nepal/NP		911			411	641	611	Rwanda/RW					408	638	608		
Netherlands (Holland)/NL	901	901	401	401	401	631	601	Saba/BQ†					402	632	602		
Netherlands Antilles/AN† <i>Refer to Bonaire, St. Eustatius, Saba, Curaçao, St. Martin or St. Maarten for zone information.</i>								Saipan (Northern Mariana Islands)/MP		908			408	638	608		
New Caledonia/NC		908			408	638	608	Samoa/WS		908			408	638	608		
New Zealand/NZ		904		404	404	634	604	San Marino/SM				401	401	631	601		
Nicaragua/NI†				406	406	636	606	Saudi Arabia/SA	905	905		405	405	635	605		
								Scotland (United Kingdom)/GB	901	901	401	401	401	631	601		

†For shipments from Dade or Broward County, Florida, to South America, use zone:

- 921 for UPS Worldwide Express
- 421 for UPS Worldwide Express Freight Middy
- 421 for UPS Worldwide Express Freight
- 421 for UPS Worldwide Saver
- 621 for UPS Worldwide Expedited

For shipments from Dade or Broward County, Florida, to the Caribbean, use zone:

- 920 for UPS Worldwide Express
- 420 for UPS Worldwide Express Freight Middy
- 420 for UPS Worldwide Express Freight
- 420 for UPS Worldwide Saver
- 620 for UPS Worldwide Expedited

Export

Worldwide Zone Chart

Destination	Zones						Destination	Zones									
	UPS Worldwide Express Plus®	UPS Worldwide Express®	UPS Worldwide Express Freight® Midday	UPS Worldwide Express Freight®	UPS Worldwide Saver®	UPS Worldwide Expedited®		WEST	EAST	UPS Worldwide Express Plus®	UPS Worldwide Express®	UPS Worldwide Express Freight® Midday	UPS Worldwide Express Freight®	UPS Worldwide Saver®	UPS Worldwide Expedited®	WEST	EAST
Senegal/SN		908			408	638	608	Tinian (Northern Mariana Islands)/MP					408	638	608		
Serbia/RS	908	908			408	638	608	Togo/TG					408	638	608		
Seychelles/SC					408	638	608	Tonga/TO					408	638	608		
Sierra Leone/SL					408	638	608	Tortola (British Virgin Islands)/VG†					402	632	602		
Singapore/SG	909	909		409	409	639	609	Trinidad and Tobago/TT†		902			402	632	602		
Slovakia/SK	907	907		407	407	637	607	Truk (Micronesia, Federated States of)/FM					408	638	608		
Slovenia/SI	907	907		407	407	637	607	Tunisia/TN		908		408	408	638	608		
Solomon Islands/SB		908			408	638	608	Turkey/TR	905	905	405	405	405	635	605		
South Africa/ZA	907	907		407	407	637	607	Turkmenistan/TM					408	638	608		
Spain/ES	903	903	403	403	403	633	603	Turks and Caicos Islands/TC†					402	632	602		
Sri Lanka/LK		911		411	411	641	611	Tuvalu/TV					408	638	608		
St. Barthélemy/BL†					402	632	602	Uganda/UG					408	638	608		
St. Christopher (St. Kitts and Nevis)/KN†					402	632	602	Ukraine/UA	908	908			408	638	608		
St. Croix (U.S. Virgin Islands)/VI†					402	632	602	Union Island (St. Vincent and the Grenadines)/VC†					402	632	602		
St. Eustatius/BQ†					402	632	602	United Arab Emirates/AE	905	905	405	405	405	635	605		
St. John (U.S. Virgin Islands)/VI†					402	632	602	United Kingdom/GB	901	901	401	401	401	631	601		
St. Kitts and Nevis/KN†		902			402	632	602	Uruguay/UY†					406	636	606		
St. Lucia/LC†		902			402	632	602	U.S. Virgin Islands/VI†					402	632	602		
St. Maarten/SX†					402	632	602	Uzbekistan/UZ					408	638	608		
St. Martin/SX†					402	632	602	Vanuatu/VU		908			408	638	608		
St. Thomas (U.S. Virgin Islands)/VI†					402	632	602	Vatican City (Italy)/VA	901	901		401	401	631	601		
St. Vincent and the Grenadines/VC†					402	632	602	Venezuela/VE†					406	636	606		
Suriname/SR†		906			406	636	606	Vietnam/VN	904	904		404	404	634	604		
Swaziland/SZ					408	638	608	Virgin Gorda (British Virgin Islands)/VG†					402	632	602		
Sweden/SE	903	903	403	403	403	633	603	Wales (United Kingdom)/GB	901	901		401	401	631	601		
Switzerland/CH	903	903	403	403	403	633	603	Wallis and Futuna Islands/WF		908			408	638	608		
Tahiti (French Polynesia)/PF		908			408	638	608	Yap (Micronesia, Federated States of)/FM					408	638	608		
Taiwan/TW	909	909	409	409	409	639	609	Zaire (Congo, Democratic Republic of)/CD					408	638	608		
Tajikistan/TJ					408	638	608	Zambia/ZM					408	638	608		
Tanzania/TZ					408	638	608	Zimbabwe/ZW					408	638	608		
Thailand/TH	904	904	404	404	404	634	604										
Timor-Leste (East Timor)/TL					408	638	608										

†For shipments from Dade or Broward County, Florida, to South America, use zone:

- 921 for UPS Worldwide Express
- 421 for UPS Worldwide Express Freight Midday
- 421 for UPS Worldwide Express Freight
- 421 for UPS Worldwide Saver
- 621 for UPS Worldwide Expedited

†For shipments from Dade or Broward County, Florida, to the Caribbean, use zone:

- 920 for UPS Worldwide Express
- 420 for UPS Worldwide Express Freight Midday
- 420 for UPS Worldwide Express Freight
- 420 for UPS Worldwide Saver
- 620 for UPS Worldwide Expedited

Export

Canada Zone Chart

Destination Postal Code Range	UPS Worldwide Express Plus® and UPS Worldwide Express®*	UPS Worldwide Express Freight® Midday and UPS Worldwide Express Freight®	UPS Worldwide Saver®	UPS Worldwide Expedited®	UPS® Standard to Canada by Origin State									
					CT, DC, DE, MA, MD, ME, NH, NJ, NY, PA, RI, VT, WV	AZ, CA, NV, UT	IL, IN, KY	IA, MN, WI	MI, OH	CO, MT, WY	ID, OR, WA	ND, NE, SD	NM, TX	AL, AR, FL, GA, KS, LA, MO, MS, NC, OK, SC, TN, VA
Newfoundland														
A0A - A0Z		481	481	71	54	56	55	55	54	56	56	55	56	55
A1A - A1N	82	482	482	72	54	56	55	55	54	56	56	55	56	55
A1P - A9Z		481	481	71	54	56	55	55	54	56	56	55	56	55
Nova Scotia														
B0A - B2T	81	481	481	71	54	56	55	55	54	56	56	55	56	55
B2V - B3B		482	482	72	54	56	55	55	54	56	56	55	56	55
B3C - B3G		481	481	71	54	56	55	55	54	56	56	55	56	55
B3H - B4B		482	482	72	54	56	55	55	54	56	56	55	56	55
B4C - B9Z		481	481	71	54	56	55	55	54	56	56	55	56	55
Prince Edward Island														
C0A - C0Z		481	481	71	54	56	55	55	54	56	56	55	56	55
C1A - C1E		482	482	72	54	56	55	55	54	56	56	55	56	55
C1G - C9Z		481	481	71	54	56	55	55	54	56	56	55	56	55
New Brunswick														
E0A - E0Z		481	481	71	54	56	55	55	54	56	56	55	56	55
E1A - E1G	82	482	482	72	54	56	55	55	54	56	56	55	56	55
E1H - E2G	81	481	481	71	54	56	55	55	54	56	56	55	56	55
E2H - E2S		482	482	72	54	56	55	55	54	56	56	55	56	55
E2T - E2Z		481	481	71	54	56	55	55	54	56	56	55	56	55
E3A - E3E		482	482	72	54	56	55	55	54	56	56	55	56	55
E3G - E9Z		481	481	71	54	56	55	55	54	56	56	55	56	55
Quebec														
G0A		482	482	72	51	53	52	52	51	53	53	52	53	52
G0B - G0J		481	481	71	54	56	55	55	54	56	56	55	56	55
G0K - G0L		482	482	72	54	56	55	55	54	56	56	55	56	55
G0M - G0S		482	482	72	51	53	52	52	51	53	53	52	53	52
G0T - G0W		481	481	71	54	56	55	55	54	56	56	55	56	55
G0X - G0Z		482	482	72	51	53	52	52	51	53	53	52	53	52
G1A - G3A	81	481	481	71	51	53	52	52	51	53	53	52	53	52
G3B - G3K		482	482	72	51	53	52	52	51	53	53	52	53	52
G3L - G4P		482	482	72	54	56	55	55	54	56	56	55	56	55
G4R - G4S		481	481	71	54	56	55	55	54	56	56	55	56	55
G4T - G4V		482	482	72	54	56	55	55	54	56	56	55	56	55

*To determine whether UPS Worldwide Express Plus and UPS Worldwide Express Services are available to your destination postal code, refer to ups.com or call 1-800-782-7892.

Export

Canada Zone Chart

Destination Postal Code Range	UPS Worldwide Express Plus® and UPS Worldwide Express®*	UPS Worldwide Express Freight® Midday and UPS Worldwide Express Freight®	UPS Worldwide Saver®	UPS Worldwide Expedited®	UPS® Standard to Canada by Origin State									
					CT, DC, DE, MA, MD, ME, NH, NJ, NY, PA, RI, VT, WV	AZ, CA, NV, UT	IL, IN, KY	IA, MN, WI	MI, OH	CO, MT, WY	ID, OR, WA	ND, NE, SD	NM, TX	AL, AR, FL, GA, KS, LA, MO, MS, NC, OK, SC, TN, VA
Quebec (cont.)														
G4W - G4Z		481	481	71	54	56	55	55	54	56	56	55	56	55
G5A		482	482	72	51	53	52	52	51	53	53	52	53	52
G5B - G5T		481	481	71	54	56	55	55	54	56	56	55	56	55
G5V - G6A		482	482	72	51	53	52	52	51	53	53	52	53	52
G6B		481	481	71	51	53	52	52	51	53	53	52	53	52
G6C - G6J		482	482	72	51	53	52	52	51	53	53	52	53	52
G6K		481	481	71	51	53	52	52	51	53	53	52	53	52
G6L - G6T		482	482	72	51	53	52	52	51	53	53	52	53	52
G6V - G6Z		481	481	71	51	53	52	52	51	53	53	52	53	52
G7A		481	481	71	54	56	55	55	54	56	56	55	56	55
G7B - G8P		481	481	71	54	56	55	55	54	56	56	55	56	55
G8R - G8S		482	482	72	54	56	55	55	54	56	56	55	56	55
G8T - G9Z		482	482	72	51	53	52	52	51	53	53	52	53	52
H0A - H0L		481	481	71	51	53	52	52	51	53	53	52	53	52
H0M		481	481	71	54	56	55	55	54	56	56	55	56	55
H0N - H9Z	81	481	481	71	51	53	52	52	51	53	53	52	53	52
J0A - J0L		482	482	72	51	53	52	52	51	53	53	52	53	52
J0M		481	481	71	54	56	55	55	54	56	56	55	56	55
J0N - J0V		482	482	72	51	53	52	52	51	53	53	52	53	52
J0W - J0Z		481	481	71	54	56	55	55	54	56	56	55	56	55
J1A - J3C	82	482	482	72	51	53	52	52	51	53	53	52	53	52
J3E		481	481	71	51	53	52	52	51	53	53	52	53	52
J3G - J3S		482	482	72	51	53	52	52	51	53	53	52	53	52
J3T - J3V		481	481	71	51	53	52	52	51	53	53	52	53	52
J3W - J3X		482	482	72	51	53	52	52	51	53	53	52	53	52
J3Y - J5R	81	481	481	71	51	53	52	52	51	53	53	52	53	52
J5S - J5X		482	482	72	51	53	52	52	51	53	53	52	53	52
J5Y - J7H	81	481	481	71	51	53	52	52	51	53	53	52	53	52
J7J - J7N	82	482	482	72	51	53	52	52	51	53	53	52	53	52
J7P - J7W	81	481	481	71	51	53	52	52	51	53	53	52	53	52
J7X - J8N	82	482	482	72	51	53	52	52	51	53	53	52	53	52
J8P - J9C	81	481	481	71	51	53	52	52	51	53	53	52	53	52
J9E		482	482	72	54	56	55	55	54	56	56	55	56	55
J9G - J9J		482	482	72	51	53	52	52	51	53	53	52	53	52
J9K - J9Z		481	481	71	54	56	55	55	54	56	56	55	56	55

*To determine whether UPS Worldwide Express Plus and UPS Worldwide Express Services are available to your destination postal code, refer to [ups.com](https://www.ups.com) or call 1-800-782-7892.

Export

Canada Zone Chart

Destination Postal Code Range	UPS Worldwide Express Plus® and UPS Worldwide Express®*	UPS Worldwide Express Freight® Midday and UPS Worldwide Express Freight®	UPS Worldwide Saver®	UPS Worldwide Expedited®	UPS® Standard to Canada by Origin State									
					CT, DC, DE, MA, MD, ME, NH, NJ, NY, PA, RI, VT, WV	AZ, CA, NV, UT	IL, IN, KY	IA, MN, WI	MI, OH	CO, MT, WY	ID, OR, WA	ND, NE, SD	NM, TX	AL, AR, FL, GA, KS, LA, MO, MS, NC, OK, SC, TN, VA
Ontario														
K0A - K0H		482	482	72	51	53	51	52	51	53	53	52	53	52
K0J		481	481	71	54	56	54	55	54	56	56	55	56	55
K0K - K0Z		482	482	72	51	53	51	52	51	53	53	52	53	52
K1A - K4A	81	481	481	71	51	53	51	52	51	53	53	52	53	52
K4B - K7T	82	482	482	72	51	53	51	52	51	53	53	52	53	52
K7V - K8H		482	482	72	54	56	54	55	54	56	56	55	56	55
K8J - L1E	82	482	482	72	51	53	51	52	51	53	53	52	53	52
L1F - L1Z	81	481	481	71	51	53	51	52	51	53	53	52	53	52
L2A - L2C		482	482	72	51	53	51	52	51	53	53	52	53	52
L2E - L2W	81	481	481	71	51	53	51	52	51	53	53	52	53	52
L2X - L3N		482	482	72	51	53	51	52	51	53	53	52	53	52
L3P - L3T	81	481	481	71	51	53	51	52	51	53	53	52	53	52
L3V - L3W		482	482	72	51	53	51	52	51	53	53	52	53	52
L3X - L4L	81	481	481	71	51	53	51	52	51	53	53	52	53	52
L4M - L4R	82	482	482	72	51	53	51	52	51	53	53	52	53	52
L4S - L9T	81	481	481	71	51	53	51	52	51	53	53	52	53	52
L9V - L9Z		482	482	72	51	53	51	52	51	53	53	52	53	52
M0A - M9Z	81	481	481	71	51	53	51	52	51	53	53	52	53	52
N0A - N1A	82	482	482	72	51	53	51	52	51	53	53	52	53	52
N1B - N2Y	81	481	481	71	51	53	51	52	51	53	53	52	53	52
N2Z		482	482	72	51	53	51	52	51	53	53	52	53	52
N3A - N3V	81	481	481	71	51	53	51	52	51	53	53	52	53	52
N3W - N5T	82	482	482	72	51	53	51	52	51	53	53	52	53	52
N5V - N6N	81	481	481	71	51	53	51	52	51	53	53	52	53	52
N6P - N8M		482	482	72	51	53	51	52	51	53	53	52	53	52
N8N - N9K	81	481	481	71	51	53	51	52	51	53	53	52	53	52
N9L - N9Z		482	482	72	51	53	51	52	51	53	53	52	53	52
P0A - P0Z		481	481	71	54	56	54	55	54	56	56	55	56	55
P1A - P2M		482	482	72	54	56	54	55	54	56	56	55	56	55
P2N		481	481	71	54	56	54	55	54	56	56	55	56	55
P2P - P3K		482	482	72	54	56	54	55	54	56	56	55	56	55
P3L		481	481	71	54	56	54	55	54	56	56	55	56	55
P3M		482	482	72	54	56	54	55	54	56	56	55	56	55
P3N - P3P		481	481	71	54	56	54	55	54	56	56	55	56	55

*To determine whether UPS Worldwide Express Plus and UPS Worldwide Express Services are available to your destination postal code, refer to [ups.com](https://www.ups.com) or call 1-800-782-7892.

Export

Canada Zone Chart

Destination Postal Code Range	UPS Worldwide Express Plus® and UPS Worldwide Express®*	UPS Worldwide Express Freight® Midday and UPS Worldwide Express Freight®	UPS Worldwide Saver®	UPS Worldwide Expedited®	UPS® Standard to Canada by Origin State									
					CT, DC, DE, MA, MD, ME, NH, NJ, NY, PA, RI, VT, WV	AZ, CA, NV, UT	IL, IN, KY	IA, MN, WI	MI, OH	CO, MT, WY	ID, OR, WA	ND, NE, SD	NM, TX	AL, AR, FL, GA, KS, LA, MO, MS, NC, OK, SC, TN, VA
Ontario (cont.)														
P3R - P4M	82	482	482	72	54	56	54	55	54	56	56	55	56	55
P4N - P4R		481	481	71	54	56	54	55	54	56	56	55	56	55
P4S - P4Z		482	482	72	54	56	54	55	54	56	56	55	56	55
P5A		481	481	71	54	56	54	55	54	56	56	55	56	55
P5B - P5M		482	482	72	54	56	54	55	54	56	56	55	56	55
P5N		481	481	71	54	56	54	55	54	56	56	55	56	55
P5P - P8M		482	482	72	54	56	54	55	54	56	56	55	56	55
P8N		481	481	71	54	56	54	55	54	56	56	55	56	55
P8P - P8S		482	482	72	54	56	54	55	54	56	56	55	56	55
P8T		481	481	71	54	56	54	55	54	56	56	55	56	55
P8V - P8Z		482	482	72	54	56	54	55	54	56	56	55	56	55
P9A		481	481	71	54	56	54	55	54	56	56	55	56	55
P9B - P9M		482	482	72	54	56	54	55	54	56	56	55	56	55
P9N		481	481	71	54	56	54	55	54	56	56	55	56	55
P9P - P9Z		482	482	72	54	56	54	55	54	56	56	55	56	55
Manitoba														
R0A - R2B		481	481	71	55	56	54	54	54	55	55	54	55	55
R2C - R4A	81	481	481	71	52	53	51	51	51	52	52	51	52	52
R4B - R9Z		481	481	71	55	56	54	54	54	55	55	54	55	55
Saskatchewan														
S0A - S0Z		481	481	71	55	56	54	54	54	55	55	54	55	55
S1A - S3M		482	482	72	55	56	54	54	54	55	55	54	55	55
S3N		481	481	71	55	56	54	54	54	55	55	54	55	55
S3P - S3Z		482	482	72	55	56	54	54	54	55	55	54	55	55
S4A		481	481	71	55	56	54	54	54	55	55	54	55	55
S4B - S4G		482	482	72	55	56	54	54	54	55	55	54	55	55
S4H		481	481	71	55	56	54	54	54	55	55	54	55	55
S4J - S4M		482	482	72	55	56	54	54	54	55	55	54	55	55
S4N - S4Z		482	482	72	52	53	51	51	51	52	52	51	52	52
S5A - S7G		481	481	71	55	56	54	54	54	55	55	54	55	55
S7H - S7V		481	481	71	52	53	51	51	51	52	52	51	52	52
S7W - S9Z		481	481	71	55	56	54	54	54	55	55	54	55	55

*To determine whether UPS Worldwide Express Plus and UPS Worldwide Express Services are available to your destination postal code, refer to [ups.com](https://www.ups.com) or call 1-800-782-7892.

Export

Canada Zone Chart

Destination Postal Code Range	UPS Worldwide Express Plus® and UPS Worldwide Express®*	UPS Worldwide Express Freight® Midday and UPS Worldwide Express Freight®	UPS Worldwide Saver®	UPS Worldwide Expedited®	UPS® Standard to Canada by Origin State									
					CT, DC, DE, MA, MD, ME, NH, NJ, NY, PA, RI, VT, WV	AZ, CA, NV, UT	IL, IN, KY	IA, MN, WI	MI, OH	CO, MT, WY	ID, OR, WA	ND, NE, SD	NM, TX	AL, AR, FL, GA, KS, LA, MO, MS, NC, OK, SC, TN, VA
Alberta														
T0A - T0B		481	481	71	56	55	56	56	56	55	54	55	56	56
T0C		482	482	72	53	52	53	53	53	52	51	52	53	53
T0E - T1W		481	481	71	56	55	56	56	56	55	54	55	56	56
T1X		481	481	71	56	55	56	56	56	55	54	55	56	56
T1Y - T3Z	81	481	481	71	53	52	53	53	53	52	51	52	53	53
T4A - T4Z	82	482	482	72	53	52	53	53	53	52	51	52	53	53
T5A - T6V		481	481	71	53	52	53	53	53	52	51	52	53	53
T6W - T6X		481	481	71	56	55	56	56	56	55	54	55	56	56
T6Y - T7W		481	481	71	56	55	56	56	56	55	54	55	56	56
T7X - T8N		482	482	72	53	52	53	53	53	52	51	52	53	53
T8P - T8Z		481	481	71	56	55	56	56	56	55	54	55	56	56
T9A - T9E		482	482	72	53	52	53	53	53	52	51	52	53	53
T9G - T9Z		481	481	71	56	55	56	56	56	55	54	55	56	56
British Columbia														
V0A - V0L		481	481	71	56	55	56	56	56	55	54	55	56	56
V0M		481	481	71	53	52	53	53	53	52	51	52	53	53
V0N - V1L		481	481	71	56	55	56	56	56	55	54	55	56	56
V1M		481	481	71	53	52	53	53	53	52	51	52	53	53
V1N - V2R		481	481	71	56	55	56	56	56	55	54	55	56	56
V2S - V2V		481	481	71	56	55	56	56	56	55	54	55	56	56
V2W - V3E	81	481	481	71	53	52	53	53	53	52	51	52	53	53
V3G		481	481	71	56	55	56	56	56	55	54	55	56	56
V3H - V7Z	81	481	481	71	53	52	53	53	53	52	51	52	53	53
V8A - V8K		481	481	71	56	55	56	56	56	55	54	55	56	56
V8L - V9E	82	482	482	72	53	52	53	53	53	52	51	52	53	53
V9G - V9Z		481	481	71	56	55	56	56	56	55	54	55	56	56
Nunavut														
X0A - X0C		481	481		-	-	-	-	-	-	-	-	-	-
Northwest Territories														
X0E - X9Z		481	481		-	-	-	-	-	-	-	-	-	-
Yukon														
Y0A - Y9Z		481	481		-	-	-	-	-	-	-	-	-	-

*To determine whether UPS Worldwide Express Plus and UPS Worldwide Express Services are available to your destination postal code, refer to [ups.com](https://www.ups.com) or call 1-800-782-7892.

Note: UPS Standard is not available to Nunavut, the Northwest Territories or Yukon.

Export

UPS® Standard Zone Chart

SHIPMENTS TO MEXICO

U.S. Origin ZIP Code	Standard Zone
00400-00599	37
01000-03999	37
04000-04999	38
05000-08999	37
10000-14699	37
14700-14799	36
14800-14999	37
15000-16899	36
16900-17299	37
17300-17499	36
17500-19999	37
20000-21799	36
21800-21999	37
22000-28699	36
28700-28999	35
29000-29599	36
29600-29699	35
29700-29799	36
29800-29899	35
29900-29999	36
30000-31299	35
31300-31499	36
31500-32699	35
32700-33499	36
33500-33899	35
33900-33999	36
34100-34199	36
34200-34699	35
34700-34999	36
35000-36499	35
36500-36699	34
36700-36899	35
36900-36999	34
37000-37599	35
37600-37699	36
37700-38699	35
38700-38799	34
38800-38899	35
38900-39699	34
39700-40999	35
41000-41299	36

U.S. Origin ZIP Code	Standard Zone
41300-41499	35
41500-41899	36
42000-42799	35
43000-45999	36
46000-46299	35
46300-46899	36
46900-46999	35
47000-47099	36
47100-47299	35
47300-47399	36
47400-47999	35
48000-49999	36
50000-52099	35
52100-52199	36
52200-52899	35
53000-53799	36
53800-53899	35
53900-56099	36
56100-56199	35
56200-56799	36
57000-57199	35
57200-57299	36
57300-57399	35
57400-59399	36
59400-59699	37
59700-59799	36
59800-59999	37
60000-60899	36
60900-60999	35
61000-61199	36
61200-64799	35
64800-64899	34
64900-65599	35
65600-65999	34
66000-66699	35
66700-66799	34
66800-66999	35
67000-67399	34
67400-67799	35
67800-67999	34
68000-69399	35

U.S. Origin ZIP Code	Standard Zone
70000-70599	34
70600-70699	33
70700-72299	34
72300-72499	35
72500-73299	34
73300-73399	32
73400-74999	34
75000-75499	33
75500-75599	34
75600-76499	33
76500-76599	32
76600-77799	33
77800-78499	32
78500-78599	33
78600-78999	32
79000-79499	34
79500-79799	33
79800-79999	34
80000-82099	35
82100-82199	36
82200-82399	35
82400-83499	36
83500-83599	37
83600-83799	36
83800-83899	37
84000-84499	36
84500-84599	35
84600-84799	36
85000-86399	35
86400-86499	36
86500-87599	35
87700-88599	34
88900-93899	36
93900-96099	37
96100-96199	36
97000-97899	37
97900-97999	36
98000-98699	37
98800-99499	37

Import

Worldwide Zone Chart

Origin	Zones						Origin	Zones							
	UPS Worldwide Express Plus®	UPS Worldwide Express®	UPS Worldwide Express Freight® Midday	UPS Worldwide Express Freight®	UPS Worldwide Saver®	UPS Worldwide Expedited®		UPS Worldwide Express Plus®	UPS Worldwide Express®	UPS Worldwide Express Freight® Midday	UPS Worldwide Express Freight®	UPS Worldwide Saver®	UPS Worldwide Expedited®		
						WEST	EAST						WEST	EAST	
Afghanistan/AF	958	958			458			Canada/CA							
Aland Islands/AX	953	953			453			For UPS 3 Day Select® and UPS® Standard zones, refer to page 42.	91	91	491	491	491	61	61
Albania/AL	958	958			458			Canary Islands (Spain)/ES	953	953			453		
Algeria/DZ	958	958			458			Cape Verde/CV	958	958			458		
American Samoa/AS	958	958			458			Cayman Islands/KY†	952	952			452		
Angola/AO	958	958			458			Chad/TD	958	958			458		
Anguilla/AI†	952	952			452			Channel Islands Guernsey/GG, Jersey/JE	953	953			453	683	653
Antigua and Barbuda/AG†	952	952			452			Chile/CL†	956	956	456	456	456	686	656
Argentina/AR†	956	956	456	456	456	686	656	China, People's Republic of/CN	962	962	462	462	462	692	662
Armenia/AM	958	958			458			Colombia/CO†	956	956	456	456	456	686	656
Aruba/AW†	952	952			452			Comoros/KM	958	958			458		
Australia/AU	954	954	454	454	454	684	654	Congo, Democratic Republic of/CD	958	958			458		
Austria/AT	953	953	453	453	453	683	653	Congo, Republic of/CG	958	958			458		
Azerbaijan/AZ	958	958			458			Costa Rica/CR†	956	956	456	456	456	686	656
Azores (Portugal)/PT	953	953			453	683	653	Côte d'Ivoire (Ivory Coast)/CI	958	958			458		
Bahamas/BS†	952	952			452			Croatia/HR	958	958			458		
Bahrain/BH	955	955	455	455	455	685	655	Curaçao/CW†	952	952			452		
Bangladesh/BD	961	961	461	461	461			Cyprus/CY	955	955			455		
Barbados/BB†	952	952			452			Czech Republic/CZ	957	957	457	457	457	687	657
Belarus/BY	958	958			458			Denmark/DK	953	953	453	453	453	683	653
Belgium*/BE	951	951	451	451	451	681	651	Djibouti/DJ	958	958			458		
Benin/BJ	958	958			458			Dominica/DM†	952	952			452		
Bermuda/BM†	952	952			452			Dominican Republic/DO†	952	952	452	452	452	682	652
Bhutan/BT	961	961			461			Ecuador/EC†	956	956	456	456	456	686	656
Bolivia/BO†	956	956			456			Egypt/EG	955	955			455	685	655
Bonaire/BQ†	952	952			452			El Salvador/SV†	956	956	456	456	456	686	656
Bosnia/BA	958	958			458			England (United Kingdom)*/GB	951	951	451	451	451	681	651
Botswana/BW	958	958			458			Eritrea/ER	958	958			458		
Brazil/BR†	956	956	456	456	456	686	656	Estonia/EE	957	957			457	687	657
British Virgin Islands/VG†	952	952			452			Ethiopia/ET	958	958			458		
Brunei/BN	955	955			455			Fiji/FJ	958	958			458		
Bulgaria/BG	957	957	457	457	457	687	657	Finland/FI	953	953	453	453	453	683	653
Burkina Faso/BF	958	958			458			France/FR	951	951	451	451	451	681	651
Burundi/BI	958	958			458			French Polynesia/PF	958	958			458		
Cambodia/KH	958	958			458			Gabon/GA	958	958			458		
Cameroon/CM	958	958			458			Gambia/GM	958	958			458		
								Georgia/GE	958	958			458		
								Germany*/DE	951	951	451	451	451	681	651

*UPS Worldwide Express NAI® service is available from this country.

†For shipments from South America to Dade or Broward County, Florida, use zone:
 – 971 for UPS Worldwide Express
 – 471 for UPS Worldwide Express Freight Midday
 – 471 for UPS Worldwide Express Freight
 – 471 for UPS Worldwide Saver
 – 671 for UPS Worldwide Expedited

For shipments from the Caribbean to Dade or Broward County, Florida, use zone:
 – 970 for UPS Worldwide Express
 – 470 for UPS Worldwide Express Freight Midday
 – 470 for UPS Worldwide Express Freight
 – 470 for UPS Worldwide Saver
 – 670 for UPS Worldwide Expedited

Import

Worldwide Zone Chart

Origin	Zones						UPS Worldwide Expedited*	WEST	EAST	Origin	Zones						UPS Worldwide Expedited*	WEST	EAST							
	UPS Worldwide Express Plus®	UPS Worldwide Express®	UPS Worldwide Express Freight® Midday	UPS Worldwide Express Freight®	UPS Worldwide Saver®	UPS Worldwide Express Freight®					UPS Worldwide Express Plus®	UPS Worldwide Express®	UPS Worldwide Express Freight® Midday	UPS Worldwide Express Freight®	UPS Worldwide Saver®	UPS Worldwide Express Freight®										
Ghana/GH	958	958			458				Liberia/LR	958	958			458												
Gibraltar/GI	958	958			458				Libya/LY	958	958			458												
Great Britain (United Kingdom)*/GB	951	951	451	451	451	681	651		Liechtenstein/LI	953	953	453	453	453	683	653										
Greece/GR	953	953	453	453	453	683	653		Lithuania/LT	957	957	457	457	457	687	657										
Grenada/GD†	952	952			452				Luxembourg/LU	951	951	451	451	451	681	651										
Guadeloupe/GP†	952	952			452				Macau/MO	954	954			454	684	654										
Guam/GU	954	954			454				Macedonia (FYROM)/MK	958	958			458												
Guatemala/GT†	956	956	456	456	456	686	656		Madagascar/MG	958	958			458												
Guernsey/GG	953	953			453	683	653		Madeira (Portugal)/PT	953	953			453	683	653										
Guinea/GN	958	958			458				Malawi/MW	958	958			458												
Guinea-Bissau/GW	958	958			458				Malaysia/MY	954	954	454	454	454	684	654										
Guyana/GY†	956	956			456				Maldives/MV	958	958			458	688	658										
Haiti/HT†	952	952			452	682	652		Mali/ML	958	958			458												
Holland (Netherlands)/NL	951	951	451	451	451	681	651		Malta/MT	958	958	458	458	458												
Honduras/HN†	956	956	456	456	456	686	656		Martinique/MQ†	952	952			452												
Hong Kong/HK	959	959	459	459	459	689	659		Mauritania/MR	958	958			458												
Hungary/HU	957	957	457	457	457	687	657		Mauritius/MU	958	958			458												
Iceland/IS	958	958			458				Mayotte/YT	958	958			458												
India/IN	961	961	461	461	461	691	661		Mexico/MX	94	94	494	494	494	64	64										
Indonesia/ID	954	954	454	454	454	684	654		<i>For UPS® Standard zones, refer to page 43.</i>																	
Iraq/IQ	958	958			458	688	658		Moldova/MD	958	958			458												
Ireland, Republic of/IE	951	951	451	451	451	681	651		Monaco/MC	951	951	451	451	451	681	651										
Israel/IL	955	955	455	455	455	685	655		Mongolia/MN	958	958			458												
Italy/IT	951	951	451	451	451	681	651		Montenegro/ME	958	958			458												
Ivory Coast (Côte d'Ivoire)/CI	958	958			458				Montserrat/MS†	952	952			452												
Jamaica/JM†	952	952			452				Morocco/MA	958	958	458	458	458	688	658										
Japan/JP	963	963	463	463	463	693	663		Mozambique/MZ	958	958			458												
Jersey/JE	953	953			453	683	653		Myanmar/MM	961	961			461	691	661										
Jordan/JO	955	955			455				Namibia/NA	958	958			458												
Kazakhstan/KZ	958	958			458	688	658		Nepal/NP	961	961			461												
Kenya/KE	958	958			458	688	658		Netherlands (Holland)*/NL	951	951	451	451	451	681	651										
Korea, South/KR	959	959	459	459	459	689	659		Netherlands Antilles/AN†																	
Kosovo/KV	958	958			458				<i>Refer to Bonaire, St. Eustatius, Saba, Curaçao, St. Martin or St. Maarten for zone information.</i>																	
Kuwait/KW	955	955			455	685	655		New Caledonia/NC	958	958			458												
Kyrgyzstan/KG	958	958			458				New Zealand/NZ	954	954	454	454	454	684	654										
Laos/LA	958	958			458				Nicaragua/NI†	956	956	456	456	456	686	656										
Latvia/LV	957	957	457	457	457	687	657		Niger/NE	958	958			458												
Lesotho/LS	958	958			458				Nigeria/NG	958	958		458	458	688	658										

*UPS Worldwide Express NA1® service is available from this country.

†For shipments from South America to Dade or Broward County, Florida, use zone:
 – 971 for UPS Worldwide Express
 – 471 for UPS Worldwide Express Freight Midday
 – 471 for UPS Worldwide Express Freight
 – 471 for UPS Worldwide Saver
 – 671 for UPS Worldwide Expedited

For shipments from the Caribbean to Dade or Broward County, Florida, use zone:
 – 970 for UPS Worldwide Express
 – 470 for UPS Worldwide Express Freight Midday
 – 470 for UPS Worldwide Express Freight
 – 470 for UPS Worldwide Saver
 – 670 for UPS Worldwide Expedited

Import

Worldwide Zone Chart

Origin	Zones						Origin	Zones									
	UPS Worldwide Express Plus®	UPS Worldwide Express®	UPS Worldwide Express Freight® Middy	UPS Worldwide Express Freight®	UPS Worldwide Saver®	UPS Worldwide Expedited®		WEST	EAST	UPS Worldwide Express Plus®	UPS Worldwide Express®	UPS Worldwide Express Freight® Middy	UPS Worldwide Express Freight®	UPS Worldwide Saver®	UPS Worldwide Expedited®	WEST	EAST
Northern Ireland (United Kingdom)/GB	951	951	451	451	451	681	651	St. Lucia/LC†	952	952			452	682	652		
Northern Mariana Islands/MP	958	958			458			St. Maarten/SX†	952	952			452				
Norway/NO	953	953	453	453	453	683	653	St. Martin/SX†	952	952			452				
Oman/OM	955	955		455	455	685	655	St. Thomas (U.S. Virgin Islands)/VI†	952	952			452				
Pakistan/PK	961	961	461	461	461	691	661	St. Vincent and the Grenadines/VC†	952	952			452				
Panama/PA†	956	956	456	456	456	686	656	Suriname/SR†	956	956			456				
Paraguay/PY†	956	956			456			Swaziland/SZ	958	958			458				
Peru/PE†	956	956			456	686	656	Sweden/SE	953	953	453	453	453	683	653		
Philippines/PH	959	959	459	459	459	689	659	Switzerland/CH	953	953	453	453	453	683	653		
Poland/PL	957	957	457	457	457	687	657	Taiwan/TW	954	954	454	454	454	684	654		
Portugal/PT	953	953	453	453	453	683	653	Tajikistan/TJ	958	958			458				
Qatar/QA	955	955	455	455	455	685	655	Tanzania/TZ	958	958			458				
Réunion/RE	958	958			458			Thailand/TH	954	954	454	454	454	684	654		
Romania/RO	957	957	457	457	457	687	657	Tinian (Northern Mariana Islands)/MP	958	958			458				
Rota (Northern Mariana Islands)/MP	958	958			458			Togo/TG	958	958			458				
Russia/RU	957	957		457	457	687	657	Tortola (British Virgin Islands)/VG†	952	952			452				
Rwanda/RW	958	958			458			Trinidad and Tobago/TT†	952	952			452				
Saba/BQ†	952	952			452			Tunisia/TN	958	958	458	458	458				
Saipan (Northern Mariana Islands)/MP	958	958			458			Turkey/TR	955	955	455	455	455	685	655		
Samoa/WS	958	958			458			Turkmenistan/TM	958	958			458				
San Marino/SM	951	951	451	451	451	681	651	Turks and Caicos Islands/TC†	952	952			452				
Saudi Arabia/SA	955	955	455	455	455	685	655	Uganda/UG	958	958			458				
Scotland (United Kingdom)/GB	951	951	451	451	451	681	651	Ukraine/UA	958	958			458				
Senegal/SN	958	958			458			Union Island (St. Vincent and the Grenadines)/VC†	952	952			452				
Serbia/RS	958	958	458	458	458			United Arab Emirates/AE	955	955	455	455	455	685	655		
Seychelles/SC	958	958			458			United Kingdom*/GB	951	951	451	451	451	681	651		
Sierra Leone/SL	958	958			458			Uruguay/UY†	956	956			456				
Singapore/SG	954	954	454	454	454	684	654	U.S. Virgin Islands/VI†	952	952			452				
Slovakia/SK	957	957	457	457	457	687	657	Uzbekistan/UZ	958	958			458				
Slovenia/SI	957	957		457	457	687	657	Vatican City (Italy)/VA	951	951	451	451	451	681	651		
South Africa/ZA	957	957	457	457	457	687	657	Venezuela/VE†	956	956			456	686	656		
Spain/ES	953	953	453	453	453	683	653	Vietnam/VN	954	954	454	454	454	684	654		
Sri Lanka/LK	961	961	461	461	461			Virgin Gorda (British Virgin Islands)/VG†	952	952			452				
St. Barthélemy/BL†	952	952			452			Wales (United Kingdom)/GB	951	951	451	451	451	681	651		
St. Christopher (St. Kitts and Nevis)/KN†	952	952			452			Zambia/ZM	958	958			458				
St. Croix (U.S. Virgin Islands)/VI†	952	952			452			Zimbabwe/ZW	958	958			458				
St. Eustatius/BQ†	952	952			452												
St. John (U.S. Virgin Islands)/VI†	952	952			452												
St. Kitts and Nevis/KN†	952	952			452	682	652										

*UPS Worldwide Express NA1® service is available from this country.

†For shipments from South America to Dade or Broward County, Florida, use zone:
 – 971 for UPS Worldwide Express
 – 471 for UPS Worldwide Express Freight Middy
 – 471 for UPS Worldwide Express Freight
 – 471 for UPS Worldwide Saver
 – 671 for UPS Worldwide Expedited

For shipments from the Caribbean to Dade or Broward County, Florida, use zone:
 – 970 for UPS Worldwide Express
 – 470 for UPS Worldwide Express Freight Middy
 – 470 for UPS Worldwide Express Freight
 – 470 for UPS Worldwide Saver
 – 670 for UPS Worldwide Expedited

Import

UPS 3 Day Select® and UPS® Standard Zone Chart

SHIPMENTS FROM CANADA

Destination State	Origin Province					
	Alberta British Columbia		Manitoba Saskatchewan		New Brunswick Newfoundland Nova Scotia Ontario Prince Edward Island Quebec	
	3 Day Zone	Standard Zone	3 Day Zone	Standard Zone	3 Day Zone	Standard Zone
Alabama	477	380	477	380	476	378
Alaska	—	—	—	—	—	—
Arizona	476	378	476	378	477	380
Arkansas	477	380	476	378	476	378
California	476	378	477	380	477	380
Colorado	476	378	476	378	477	380
Connecticut	477	380	476	378	475	376
Delaware	477	380	476	378	475	376
District of Columbia	477	380	476	378	475	376
Florida	477	380	477	380	476	378
Georgia	477	380	477	380	476	378
Hawaii	—	—	—	—	—	—
Idaho	475	376	476	378	477	380
Illinois	477	380	476	378	476	378
Indiana	477	380	476	378	476	378
Iowa	477	380	475	376	476	378
Kansas	477	380	476	378	476	378
Kentucky	477	380	476	378	476	378
Louisiana	477	380	477	380	476	378
Maine	477	380	476	378	475	376
Maryland	477	380	476	378	475	376
Massachusetts	477	380	476	378	475	376
Michigan	477	380	476	378	475	376
Minnesota	477	380	475	376	476	378
Mississippi	477	380	477	380	476	378
Missouri	477	380	476	378	476	378
Montana	475	376	475	376	477	380
Nebraska	476	378	475	376	476	378
Nevada	476	378	476	378	477	380
New Hampshire	477	380	476	378	475	376
New Jersey	477	380	476	378	475	376
New Mexico	476	378	476	378	477	380
New York	477	380	476	378	475	376
North Carolina	477	380	477	380	476	378
North Dakota	476	378	475	376	476	378
Ohio	477	380	476	378	475	376
Oklahoma	477	380	476	378	476	378
Oregon	475	376	476	378	477	380
Pennsylvania	477	380	476	378	475	376
Rhode Island	477	380	476	378	475	376
South Carolina	477	380	477	380	476	378
South Dakota	476	378	475	376	476	378
Tennessee	477	380	476	378	476	378
Texas	477	380	477	380	477	380
Utah	476	378	476	378	477	380
Vermont	477	380	476	378	475	376
Virginia	477	380	476	378	476	378
Washington	475	376	476	378	477	380
West Virginia	477	380	476	378	475	376
Wisconsin	477	380	475	376	476	378
Wyoming	476	378	475	376	477	380

Import

UPS® Standard Zone Chart

SHIPMENTS FROM MEXICO

Destination ZIP Code	Standard Zone
00400-00599	367
01000-03999	367
04000-04999	368
05000-08999	367
10000-14699	367
14700-14799	366
14800-14999	367
15000-16899	366
16900-17299	367
17300-17499	366
17500-19999	367
20000-21799	366
21800-21999	367
22000-28699	366
28700-28999	365
29000-29599	366
29600-29699	365
29700-29799	366
29800-29899	365
29900-29999	366
30000-31299	365
31300-31499	366
31500-32699	365
32700-33499	366
33500-33899	365
33900-33999	366
34100-34199	366
34200-34699	365
34700-34999	366
35000-36499	365
36500-36699	364
36700-36899	365
36900-36999	364
37000-37599	365
37600-37699	366
37700-38699	365
38700-38799	364
38800-38899	365
38900-39699	364
39700-40999	365
41000-41299	366

Destination ZIP Code	Standard Zone
41300-41499	365
41500-41899	366
42000-42799	365
43000-45999	366
46000-46299	365
46300-46899	366
46900-46999	365
47000-47099	366
47100-47299	365
47300-47399	366
47400-47999	365
48000-49999	366
50000-52099	365
52100-52199	366
52200-52899	365
53000-53799	366
53800-53899	365
53900-56099	366
56100-56199	365
56200-56799	366
57000-57199	365
57200-57299	366
57300-57399	365
57400-59399	366
59400-59699	367
59700-59799	366
59800-59999	367
60000-60899	366
60900-60999	365
61000-61199	366
61200-64799	365
64800-64899	364
64900-65599	365
65600-65999	364
66000-66699	365
66700-66799	364
66800-66999	365
67000-67399	364
67400-67799	365
67800-67999	364
68000-69399	365

Destination ZIP Code	Standard Zone
70000-70599	364
70600-70699	363
70700-72299	364
72300-72499	365
72500-73299	364
73300-73399	362
73400-74999	364
75000-75499	363
75500-75599	364
75600-76499	363
76500-76599	362
76600-77799	363
77800-78499	362
78500-78599	363
78600-78999	362
79000-79499	364
79500-79799	363
79800-79999	364
80000-82099	365
82100-82199	366
82200-82399	365
82400-83499	366
83500-83599	367
83600-83799	366
83800-83899	367
84000-84499	366
84500-84599	365
84600-84799	366
85000-86399	365
86400-86499	366
86500-87599	365
87700-88599	364
88900-93899	366
93900-96099	367
96100-96199	366
97000-97899	367
97900-97999	366
98000-98699	367
98800-99499	367

Domestic

UPS Next Day Air[®] Early

Guaranteed on-time overnight delivery on business days by 8:00 a.m. to major cities in the 48 contiguous states and by 8:30 a.m., 9:00 a.m. or 9:30 a.m. to most other cities in the U.S., including Anchorage, Alaska. Additional extended delivery locations are guaranteed up to 2:00 p.m. Optional Saturday Delivery and pickup available in select locations.

Zones	102	103	104	105	106	107	108	124*
Letter**	\$56.59	\$62.30	\$71.56	\$74.92	\$75.82	\$80.89	\$83.21	\$92.14
1 Lbs.	62.09	77.51	92.72	100.26	103.98	114.01	116.30	123.72
2	62.51	77.79	98.49	105.44	107.69	117.47	126.44	132.85
3	65.47	83.00	105.85	116.22	122.72	131.80	135.41	140.83
4	68.71	84.14	114.84	124.41	127.85	140.57	144.72	155.50
5	69.02	84.44	116.61	125.25	128.74	141.98	145.21	165.83
6	74.72	90.09	127.40	141.41	146.53	158.56	164.10	175.66
7	75.31	93.23	131.76	146.88	151.32	164.18	173.26	185.30
8	75.50	93.56	135.63	151.42	157.04	172.12	177.72	194.69
9	75.70	94.00	139.98	151.88	157.62	172.92	178.20	205.34
10	76.11	94.82	141.19	152.96	159.38	174.30	179.47	215.61
11	84.16	106.31	165.58	186.07	193.99	201.89	205.35	227.62
12	85.44	108.84	168.64	193.37	201.47	205.49	209.02	237.25
13	85.64	109.61	171.35	198.66	202.21	221.08	224.93	247.59
14	86.77	110.60	177.54	199.04	202.43	222.64	226.50	248.64
15	86.99	111.07	179.68	200.11	203.52	223.62	227.51	264.35
16	90.67	120.77	190.65	220.12	225.08	243.22	247.49	273.63
17	94.05	121.75	199.63	222.89	227.33	245.18	249.50	279.03
18	94.56	122.25	200.65	223.10	227.55	245.38	249.69	285.20
19	94.98	122.44	200.84	223.25	227.75	245.59	249.90	293.68
20	95.31	122.85	200.89	224.25	228.35	246.21	250.13	298.86
21	98.18	127.09	215.99	229.94	240.47	258.11	271.74	305.05
22	101.28	132.48	221.56	237.58	241.95	269.86	280.94	311.22
23	101.69	133.02	227.25	246.75	259.05	282.97	288.06	318.86
24	103.59	133.46	230.08	255.51	260.77	287.75	293.26	324.32
25	103.97	133.87	236.92	256.39	265.26	288.80	293.93	333.59
26	108.50	142.11	248.91	272.02	283.92	295.24	307.06	338.19
27	108.80	142.95	253.89	273.12	289.42	301.71	319.47	344.60
28	110.45	143.34	259.91	280.26	290.47	307.75	326.65	350.48
29	110.86	143.91	265.15	280.99	291.00	314.81	328.21	355.58
30	111.21	144.13	265.68	283.19	291.87	316.06	328.26	361.48
31	114.47	147.34	275.70	294.50	313.60	326.78	339.83	367.44
32	116.72	150.15	280.90	296.07	316.39	328.22	343.25	373.85
33	118.80	156.92	285.48	312.07	321.86	344.75	356.91	381.61
34	120.71	157.59	290.43	315.20	322.38	352.42	358.88	386.49
35	122.64	157.98	291.45	315.50	322.89	355.42	361.95	387.29

*Zone 124 includes metro Alaska.

**The Letter rate applies only to documents, correspondence and electronic media shipments that do not exceed eight ounces sent in a UPS Express[®] Envelope.

Note: For additional information, refer to page [26](#).

Domestic

UPS Next Day Air[®] Early

Zones	102	103	104	105	106	107	108	124*
36 Lbs.	\$126.49	\$160.49	\$301.30	\$321.26	\$333.15	\$359.47	\$368.99	\$403.16
37	127.15	169.23	308.14	339.35	347.82	371.08	380.50	411.16
38	127.48	170.11	311.96	340.51	353.02	372.17	381.66	418.21
39	127.86	170.48	316.86	340.70	353.54	380.79	387.92	425.81
40	128.11	170.86	317.35	341.68	354.45	381.66	388.70	433.75
41	132.45	177.56	327.33	350.66	372.40	386.65	404.26	441.70
42	133.94	178.22	331.13	355.55	374.19	387.97	411.29	450.05
43	136.74	180.60	338.84	364.27	380.46	404.20	432.48	458.53
44	139.13	188.50	343.99	371.71	386.58	410.28	434.74	467.81
45	143.64	194.65	348.01	376.86	387.21	417.69	435.39	474.73
46	146.33	195.27	353.17	384.52	398.63	422.11	451.29	482.47
47	148.02	197.70	353.75	385.90	401.12	423.27	453.52	489.76
48	149.35	198.03	354.51	389.92	401.50	430.41	454.07	498.37
49	149.40	198.24	354.61	390.02	401.71	430.64	454.30	501.00
50	149.46	199.18	354.87	390.47	403.18	431.51	455.53	506.57
51	162.45	216.14	376.45	420.70	428.65	461.31	475.54	525.72
52	164.49	225.89	401.23	428.35	443.25	478.16	500.10	551.86
53	165.93	226.88	403.71	437.20	444.70	499.71	509.80	554.47
54	166.35	227.29	404.11	441.03	445.13	501.86	510.77	568.58
55	166.85	230.71	406.81	442.04	446.15	501.91	511.17	574.00
56	176.77	241.95	407.22	449.19	457.58	501.96	511.57	576.28
57	178.03	244.08	407.93	450.31	459.53	502.52	511.97	581.65
58	178.46	244.97	408.38	450.71	468.32	503.79	513.27	601.36
59	178.87	245.40	417.38	457.05	469.21	505.92	538.90	603.34
60	179.30	245.82	418.28	457.69	470.11	536.40	541.47	616.96
61	187.08	253.43	433.89	470.07	487.94	547.10	557.45	627.08
62	188.89	260.35	440.04	475.53	489.81	554.49	570.15	628.11
63	189.34	261.06	443.73	476.16	491.93	561.97	572.61	628.92
64	197.33	268.38	444.13	488.67	506.22	571.58	592.69	644.92
65	198.13	269.99	447.70	493.69	509.22	579.98	599.02	646.52
66	198.56	270.66	465.09	508.13	523.91	580.82	600.19	647.48
67	200.18	283.75	466.82	512.81	525.38	581.22	600.59	666.39
68	204.01	285.22	467.22	519.07	525.81	581.62	603.90	668.28
69	204.42	285.65	467.67	520.37	526.62	582.02	614.86	669.65
70	204.85	286.07	468.07	522.11	527.04	583.20	615.96	690.62
71	209.84	286.49	469.50	523.00	527.96	606.55	618.09	706.23
72	210.99	294.03	497.82	539.55	544.65	631.65	660.49	712.73
73	211.42	299.54	500.65	541.20	546.32	634.16	664.74	714.11
74	211.85	300.10	501.09	541.62	546.74	634.56	665.20	741.77
75	212.70	300.95	501.89	542.46	547.58	635.37	666.00	744.54

*Zone 124 includes metro Alaska.

Note: For additional information, refer to page 26.

Domestic

UPS Next Day Air® Early

Zones	102	103	104	105	106	107	108	124*
76 Lbs.	\$222.12	\$308.48	\$504.42	\$546.83	\$552.00	\$651.36	\$666.80	\$751.67
77	223.07	317.80	506.36	563.37	573.13	652.96	667.60	755.93
78	223.92	318.73	523.83	570.51	587.30	659.94	668.40	762.42
79	224.76	319.57	525.58	578.57	595.55	670.75	677.17	800.18
80	225.61	320.43	526.38	580.32	597.16	673.41	679.86	804.39
81	234.36	324.19	541.08	614.02	627.23	689.66	697.01	805.39
82	235.24	325.05	543.78	617.39	630.24	691.28	698.72	806.28
83	236.10	325.90	544.61	618.22	631.07	692.13	699.58	807.16
84	236.94	326.76	545.45	619.06	631.93	705.60	713.63	807.96
85	237.80	327.61	546.28	619.89	632.73	705.65	715.17	816.67
86	247.07	344.53	547.75	627.33	633.87	707.84	716.03	817.85
87	248.21	349.56	566.33	630.35	636.57	708.88	717.11	841.36
88	249.06	350.41	568.20	631.18	638.12	711.46	720.58	857.96
89	249.91	351.25	590.37	651.76	669.00	758.43	789.96	859.63
90	250.76	352.10	612.13	655.39	676.99	789.28	804.36	861.40
91	260.85	363.98	614.33	656.21	677.81	792.37	805.79	862.19
92	261.87	365.18	615.13	657.01	678.95	793.23	806.73	862.98
93	262.76	365.99	615.93	657.81	679.77	794.07	807.65	863.77
94	263.56	366.81	616.73	658.61	680.59	795.22	808.59	864.57
95	270.84	367.62	617.53	663.12	681.44	796.06	809.52	865.36
96	271.64	371.84	618.33	667.36	686.44	798.51	810.34	866.15
97	272.73	372.67	619.30	672.61	693.22	799.34	811.39	867.83
98	273.60	373.47	638.69	674.54	706.36	801.17	813.26	901.49
99	275.62	374.30	648.06	709.65	731.08	837.78	850.49	934.98
100	277.26	375.42	655.19	725.89	740.03	875.22	912.00	1,034.85
101	279.73	378.89	661.46	732.86	747.14	883.45	920.82	1,044.90
102	282.20	382.35	667.71	739.82	754.24	891.90	929.64	1,054.95
103	284.68	385.80	673.96	746.77	761.33	900.35	938.46	1,065.00
104	287.15	389.25	680.20	753.73	768.45	908.80	947.28	1,075.05
105	289.84	392.70	686.45	760.70	775.54	917.25	956.10	1,085.10
106	292.08	396.16	692.71	767.65	782.63	925.70	964.92	1,095.15
107	294.56	399.61	698.97	774.61	789.75	934.15	973.74	1,105.19
108	297.03	403.06	705.22	781.57	796.84	942.60	982.56	1,115.24
109	299.50	406.51	711.47	788.53	803.94	951.05	991.38	1,125.29
110	301.99	409.97	717.72	795.49	811.05	959.50	1,000.20	1,135.34
111	304.47	413.42	723.96	802.45	818.14	967.95	1,009.02	1,145.39
112	306.94	416.88	730.22	809.40	825.24	976.40	1,017.84	1,155.44
113	308.87	420.33	736.48	816.37	832.35	984.85	1,026.66	1,163.81
114	311.88	423.80	742.73	823.33	839.45	993.30	1,035.48	1,173.85
115	314.36	427.25	748.98	830.28	846.54	1,001.75	1,044.30	1,185.58

*Zone 124 includes metro Alaska.

Note: For additional information, refer to page 26.

Domestic

UPS Next Day Air[®] Early

Zones	102	103	104	105	106	107	108	124*
116 Lbs.	\$316.82	\$430.70	\$755.23	\$837.24	\$853.64	\$1,010.20	\$1,053.12	\$1,195.63
117	319.29	434.15	761.48	844.21	860.75	1,018.65	1,061.94	1,205.68
118	321.21	437.61	767.73	851.16	867.84	1,027.10	1,070.76	1,215.73
119	324.24	441.06	773.99	858.12	874.95	1,035.55	1,079.58	1,224.01
120	326.71	444.51	780.24	865.08	882.05	1,044.00	1,088.40	1,235.82
121	329.18	447.96	786.49	872.04	889.14	1,052.45	1,097.22	1,245.87
122	331.65	451.42	792.74	879.00	896.25	1,060.90	1,106.04	1,255.92
123	334.13	454.88	798.99	885.96	903.35	1,069.35	1,114.86	1,265.97
124	336.60	458.33	805.25	892.91	910.45	1,077.80	1,123.68	1,274.19
125	339.07	461.79	811.51	899.86	917.55	1,086.25	1,132.50	1,284.22
126	341.54	465.24	817.75	906.84	924.65	1,094.70	1,141.32	1,294.25
127	343.41	468.69	824.00	913.79	931.75	1,103.15	1,150.14	1,304.29
128	345.88	472.14	830.25	920.74	938.84	1,111.60	1,158.96	1,314.31
129	348.96	475.61	836.50	927.71	945.96	1,120.05	1,167.78	1,324.33
130	351.43	479.06	842.76	934.67	953.05	1,128.50	1,176.60	1,334.38
131	353.28	482.51	849.01	941.62	960.14	1,136.95	1,185.42	1,344.41
132	355.75	485.96	855.27	948.59	967.25	1,145.40	1,194.24	1,354.43
133	358.22	489.42	861.51	955.54	974.35	1,153.85	1,203.06	1,364.49
134	360.68	492.88	867.76	962.50	981.45	1,162.30	1,211.88	1,374.53
135	363.80	496.33	874.01	969.47	988.55	1,170.75	1,220.70	1,384.54
136	365.62	499.78	880.27	976.42	995.65	1,179.20	1,229.52	1,394.60
137	368.09	503.24	886.52	983.37	1,002.75	1,187.65	1,238.34	1,404.63
138	371.21	506.69	892.78	990.35	1,009.85	1,196.10	1,247.16	1,414.66
139	373.03	510.14	899.03	997.30	1,016.96	1,204.55	1,255.98	1,424.68
140	375.51	513.59	905.27	1,004.25	1,024.05	1,213.00	1,264.80	1,434.72
141	378.63	517.05	911.52	1,011.22	1,031.15	1,221.45	1,273.62	1,444.76
142	381.10	520.50	917.78	1,018.18	1,038.26	1,229.90	1,282.44	1,454.79
143	382.90	523.96	924.03	1,025.13	1,045.35	1,238.35	1,291.26	1,464.82
144	385.38	527.41	930.29	1,032.10	1,052.46	1,246.80	1,300.08	1,474.86
145	387.84	530.88	936.54	1,039.05	1,059.55	1,255.25	1,308.90	1,484.89
146	390.31	534.33	942.79	1,046.01	1,066.65	1,263.70	1,317.72	1,494.92
147	392.77	537.78	949.03	1,052.98	1,073.76	1,272.15	1,326.54	1,504.97
148	395.25	541.23	955.29	1,059.93	1,080.85	1,280.60	1,335.36	1,514.99
149	398.41	544.69	961.54	1,066.88	1,087.96	1,289.05	1,344.18	1,525.03
150	400.88	548.14	967.79	1,073.86	1,095.06	1,297.50	1,353.00	1,535.06
More Than 150 Pounds**								
Price Per Pound	\$2.47	\$3.45	\$6.25	\$6.96	\$7.10	\$8.45	\$8.82	\$10.03

*Zone 124 includes metro Alaska.

**For each UPS Next Day Air Early package with a weight of more than 150 pounds, multiply the weight by the price per pound and add \$30.00.

Note: For additional information, refer to page [26](#).

Domestic

UPS Next Day Air®

Guaranteed on-time delivery to all 50 states and Puerto Rico by 10:30 a.m., 12:00 p.m. or end of next business day, depending on destination, with some limitations to Alaska and Hawaii. Optional Saturday Delivery and pickup available.

Zones	102	103	104	105	106	107	108	124*	125*	126*
Letter**	\$26.59	\$32.30	\$41.56	\$44.92	\$45.82	\$50.89	\$53.21	\$62.14	\$45.00	\$67.76
1 Lbs.	32.09	47.51	62.72	70.26	73.98	84.01	86.30	93.72	72.77	93.77
2	32.51	47.79	68.49	75.44	77.69	87.47	96.44	102.85	79.45	102.95
3	35.47	53.00	75.85	86.22	92.72	101.80	105.41	110.83	88.54	127.10
4	38.71	54.14	84.84	94.41	97.85	110.57	114.72	125.50	96.72	142.74
5	39.02	54.44	86.61	95.25	98.74	111.98	115.21	135.83	104.75	152.96
6	44.72	60.09	97.40	111.41	116.53	128.56	134.10	145.66	112.32	163.68
7	45.31	63.23	101.76	116.88	121.32	134.18	143.26	155.30	120.35	174.41
8	45.50	63.56	105.63	121.42	127.04	142.12	147.72	164.69	126.92	182.60
9	45.70	64.00	109.98	121.88	127.62	142.92	148.20	175.34	135.04	192.59
10	46.11	64.82	111.19	122.96	129.38	144.30	149.47	185.61	143.73	193.88
11	54.16	76.31	135.58	156.07	163.99	171.89	175.35	197.62	151.86	219.36
12	55.44	78.84	138.64	163.37	171.47	175.49	179.02	207.25	159.24	224.16
13	55.64	79.61	141.35	168.66	172.21	191.08	194.93	217.59	166.35	230.26
14	56.77	80.60	147.54	169.04	172.43	192.64	196.50	218.64	173.88	230.87
15	56.99	81.07	149.68	170.11	173.52	193.62	197.51	234.35	180.04	242.22
16	60.67	90.77	160.65	190.12	195.08	213.22	217.49	243.63	187.06	252.48
17	64.05	91.75	169.63	192.89	197.33	215.18	219.50	249.03	191.20	259.43
18	64.56	92.25	170.65	193.10	197.55	215.38	219.69	255.20	196.10	269.44
19	64.98	92.44	170.84	193.25	197.75	215.59	219.90	263.68	202.62	276.49
20	65.31	92.85	170.89	194.25	198.35	216.21	220.13	268.86	206.60	294.05
21	68.18	97.09	185.99	199.94	210.47	228.11	241.74	275.05	211.30	301.81
22	71.28	102.48	191.56	207.58	211.95	239.86	250.94	281.22	216.09	308.50
23	71.69	103.02	197.25	216.75	229.05	252.97	258.06	288.86	221.96	313.52
24	73.59	103.46	200.08	225.51	230.77	257.75	263.26	294.32	226.15	319.31
25	73.97	103.87	206.92	226.39	235.26	258.80	263.93	303.59	233.22	321.18
26	78.50	112.11	218.91	242.02	253.92	265.24	277.06	308.19	236.75	331.06
27	78.80	112.95	223.89	243.12	259.42	271.71	289.47	314.60	241.80	336.44
28	80.45	113.34	229.91	250.26	260.47	277.75	296.65	320.48	246.30	343.40
29	80.86	113.91	235.15	250.99	261.00	284.81	298.21	325.58	250.13	350.95
30	81.21	114.13	235.68	253.19	261.87	286.06	298.26	331.48	254.62	352.25
31	84.47	117.34	245.70	264.50	283.60	296.78	309.83	337.44	259.23	363.44
32	86.72	120.15	250.90	266.07	286.39	298.22	313.25	343.85	264.07	370.99
33	88.80	126.92	255.48	282.07	291.86	314.75	326.91	351.61	270.09	378.75
34	90.71	127.59	260.43	285.20	292.38	322.42	328.88	356.49	275.58	385.73
35	92.64	127.98	261.45	285.50	292.89	325.42	331.95	357.29	281.20	393.12

*Zone 124 is metro Alaska and Hawaii, zone 125 is Puerto Rico and zone 126 is remote Alaska and Hawaii. Zone 126 for remote Hawaii is not delivered the next business day. Delivery to this zone requires an additional day.

**The Letter rate applies only to documents, correspondence and electronic media shipments that do not exceed eight ounces sent in a UPS Express® Envelope.

Note: For additional information, refer to page 26.

Domestic

UPS Next Day Air[®]

Zones	102	103	104	105	106	107	108	124*	125*	126*
36 Lbs.	\$96.49	\$130.49	\$271.30	\$291.26	\$303.15	\$329.47	\$338.99	\$373.16	\$286.64	\$401.62
37	97.15	139.23	278.14	309.35	317.82	341.08	350.50	381.16	292.91	407.93
38	97.48	140.11	281.96	310.51	323.02	342.17	351.66	388.21	298.22	414.20
39	97.86	140.48	286.86	310.70	323.54	350.79	357.92	395.81	304.02	414.85
40	98.11	140.86	287.35	311.68	324.45	351.66	358.70	403.75	310.18	415.98
41	102.45	147.56	297.33	320.66	342.40	356.65	374.26	411.70	316.29	438.29
42	103.94	148.22	301.13	325.55	344.19	357.97	381.29	420.05	322.71	440.53
43	106.74	150.60	308.84	334.27	350.46	374.20	402.48	428.53	329.27	441.51
44	109.13	158.50	313.99	341.71	356.58	380.28	404.74	437.81	336.38	461.09
45	113.64	164.65	318.01	346.86	357.21	387.69	405.39	444.73	341.75	463.37
46	116.33	165.27	323.17	354.52	368.63	392.11	421.29	452.47	347.65	476.29
47	118.02	167.70	323.75	355.90	371.12	393.27	423.52	459.76	353.15	477.59
48	119.35	168.03	324.51	359.92	371.50	400.41	424.07	468.37	359.72	477.97
49	119.40	168.24	324.61	360.02	371.71	400.64	424.30	471.00	366.19	480.43
50	119.46	169.18	324.87	360.47	373.18	401.51	425.53	476.57	366.29	486.10
51	132.45	186.14	346.45	390.70	398.65	431.31	445.54	495.72	380.07	515.90
52	134.49	195.89	371.23	398.35	413.25	448.16	470.10	521.86	387.75	532.29
53	135.93	196.88	373.71	407.20	414.70	469.71	479.80	524.47	394.26	534.97
54	136.35	197.29	374.11	411.03	415.13	471.86	480.77	538.58	401.64	549.35
55	136.85	200.71	376.81	412.04	416.15	471.91	481.17	544.00	407.89	554.89
56	146.77	211.95	377.22	419.19	427.58	471.96	481.57	546.28	414.36	557.21
57	148.03	214.08	377.93	420.31	429.53	472.52	481.97	551.65	421.23	562.69
58	148.46	214.97	378.38	420.71	438.32	473.79	483.27	571.36	428.65	582.80
59	148.87	215.40	387.38	427.05	439.21	475.92	508.90	573.34	430.47	584.82
60	149.30	215.82	388.28	427.69	440.11	506.40	511.47	586.96	441.48	598.71
61	157.08	223.43	403.89	440.07	457.94	517.10	527.45	597.08	451.22	609.03
62	158.89	230.35	410.04	445.53	459.81	524.49	540.15	598.11	458.26	610.08
63	159.34	231.06	413.73	446.16	461.93	531.97	542.61	598.92	465.77	610.91
64	167.33	238.38	414.13	458.67	476.22	541.58	562.69	614.92	473.24	627.21
65	168.13	239.99	417.70	463.69	479.22	549.98	569.02	616.52	473.39	628.86
66	168.56	240.66	435.09	478.13	493.91	550.82	570.19	617.48	481.74	653.30
67	170.18	253.75	436.82	482.81	495.38	551.22	570.59	636.39	496.63	655.74
68	174.01	255.22	437.22	489.07	495.81	551.62	573.90	638.28	497.89	656.13
69	174.42	255.65	437.67	490.37	496.62	552.02	584.86	639.65	513.34	660.28
70	174.85	256.07	438.07	492.11	497.04	553.20	585.96	660.62	520.21	674.56
71	179.84	256.49	439.50	493.00	497.96	576.55	588.09	676.23	529.71	689.94
72	180.99	264.03	467.82	509.55	514.65	601.65	630.49	682.73	529.86	696.39
73	181.42	269.54	470.65	511.20	516.32	604.16	634.74	684.11	538.85	697.81
74	181.85	270.10	471.09	511.62	516.74	604.56	635.20	711.77	539.05	726.00
75	182.70	270.95	471.89	512.46	517.58	605.37	636.00	714.54	539.15	728.83

*Zone 124 is metro Alaska and Hawaii, zone 125 is Puerto Rico, and zone 126 is remote Alaska and Hawaii. Zone 126 for remote Hawaii is not delivered the next business day. Delivery to this zone requires an additional day.

Note: For additional information, refer to page 26.

Domestic

UPS Next Day Air®

Zones	102	103	104	105	106	107	108	124*	125*	126*
76 Lbs.	\$192.12	\$278.48	\$474.42	\$516.83	\$522.00	\$621.36	\$636.80	\$721.67	\$561.52	\$736.10
77	193.07	287.80	476.36	533.37	543.13	622.96	637.60	725.93	574.24	754.84
78	193.92	288.73	493.83	540.51	557.30	629.94	638.40	732.42	581.73	785.98
79	194.76	289.57	495.58	548.57	565.55	640.75	647.17	770.18	583.49	789.09
80	195.61	290.43	496.38	550.32	567.16	643.41	649.86	774.39	596.77	789.89
81	204.36	294.19	511.08	584.02	597.23	659.66	667.01	775.39	596.92	790.91
82	205.24	295.05	513.78	587.39	600.24	661.28	668.72	776.28	606.92	791.82
83	206.10	295.90	514.61	588.22	601.07	662.13	669.58	777.16	607.07	792.72
84	206.94	296.76	515.45	589.06	601.93	675.60	683.63	777.96	613.07	793.96
85	207.80	297.61	516.28	589.89	602.73	675.65	685.17	786.67	613.18	818.62
86	217.07	314.53	517.75	597.33	603.87	677.84	686.03	787.85	613.33	824.60
87	218.21	319.56	536.33	600.35	606.57	678.88	687.11	811.36	641.26	827.60
88	219.06	320.41	538.20	601.18	608.12	681.46	690.58	827.96	641.36	844.52
89	219.91	321.25	560.37	621.76	639.00	728.43	759.96	829.63	661.81	846.24
90	220.76	322.10	582.13	625.39	646.99	759.28	774.36	831.40	661.96	848.04
91	230.85	333.98	584.33	626.21	647.81	762.37	775.79	832.19	678.89	848.84
92	231.87	335.18	585.13	627.01	648.95	763.23	776.73	832.98	686.30	855.65
93	232.76	335.99	585.93	627.81	649.77	764.07	777.65	833.77	686.50	858.47
94	233.56	336.81	586.73	628.61	650.59	765.22	778.59	834.57	686.55	858.84
95	240.84	337.62	587.53	633.12	651.44	766.06	779.52	835.36	688.97	859.47
96	241.64	341.84	588.33	637.36	656.44	768.51	780.34	836.15	691.45	904.44
97	242.73	342.67	589.30	642.61	663.22	769.34	781.39	837.83	707.51	909.03
98	243.60	343.47	608.69	644.54	676.36	771.17	783.26	871.49	707.61	910.02
99	245.62	344.30	618.06	679.65	701.08	807.78	820.49	904.98	717.31	923.09
100	247.26	345.42	625.19	695.89	710.03	845.22	882.00	1,004.85	766.59	1,025.64
101	249.73	348.89	631.46	702.86	717.14	853.45	890.82	1,014.90	774.26	1,035.90
102	252.20	352.35	637.71	709.82	724.24	861.90	899.64	1,024.95	781.93	1,046.16
103	254.68	355.80	643.96	716.77	731.33	870.35	908.46	1,035.00	789.60	1,056.41
104	257.15	359.25	650.20	723.73	738.45	878.80	917.28	1,045.05	797.26	1,066.67
105	259.84	362.70	656.45	730.70	745.54	887.25	926.10	1,055.10	804.93	1,076.93
106	262.08	366.16	662.71	737.65	752.63	895.70	934.92	1,065.15	812.60	1,087.18
107	264.56	369.61	668.97	744.61	759.75	904.15	943.74	1,075.19	820.26	1,097.44
108	267.03	373.06	675.22	751.57	766.84	912.60	952.56	1,085.24	827.92	1,107.70
109	269.50	376.51	681.47	758.53	773.94	921.05	961.38	1,095.29	835.59	1,117.95
110	271.99	379.97	687.72	765.49	781.05	929.50	970.20	1,105.34	843.26	1,128.21
111	274.47	383.42	693.96	772.45	788.14	937.95	979.02	1,115.39	850.93	1,138.47
112	276.94	386.88	700.22	779.40	795.24	946.40	987.84	1,125.44	858.59	1,148.72
113	278.87	390.33	706.48	786.37	802.35	954.85	996.66	1,133.81	866.25	1,158.98
114	281.88	393.80	712.73	793.33	809.45	963.30	1,005.48	1,143.85	873.93	1,169.23
115	284.36	397.25	718.98	800.28	816.54	971.75	1,014.30	1,155.58	881.58	1,179.49

*Zone 124 is metro Alaska and Hawaii, zone 125 is Puerto Rico, and zone 126 is remote Alaska and Hawaii. Zone 126 for remote Hawaii is not delivered the next business day. Delivery to this zone requires an additional day.

Note: For additional information, refer to page 26.

Domestic

UPS Next Day Air®

Zones	102	103	104	105	106	107	108	124*	125*	126*
116 Lbs.	\$286.82	\$400.70	\$725.23	\$807.24	\$823.64	\$980.20	\$1,023.12	\$1,165.63	\$889.25	\$1,189.75
117	289.29	404.15	731.48	814.21	830.75	988.65	1,031.94	1,175.68	896.92	1,200.00
118	291.21	407.61	737.73	821.16	837.84	997.10	1,040.76	1,185.73	904.58	1,210.26
119	294.24	411.06	743.99	828.12	844.95	1,005.55	1,049.58	1,194.01	912.26	1,220.52
120	296.71	414.51	750.24	835.08	852.05	1,014.00	1,058.40	1,205.82	919.91	1,230.77
121	299.18	417.96	756.49	842.04	859.14	1,022.45	1,067.22	1,215.87	927.58	1,241.03
122	301.65	421.42	762.74	849.00	866.25	1,030.90	1,076.04	1,225.92	935.25	1,251.29
123	304.13	424.88	768.99	855.96	873.35	1,039.35	1,084.86	1,235.97	942.92	1,261.54
124	306.60	428.33	775.25	862.91	880.45	1,047.80	1,093.68	1,244.19	950.58	1,271.80
125	309.07	431.79	781.51	869.86	887.55	1,056.25	1,102.50	1,254.22	958.26	1,282.05
126	311.54	435.24	787.75	876.84	894.65	1,064.70	1,111.32	1,264.25	965.91	1,292.31
127	313.41	438.69	794.00	883.79	901.75	1,073.15	1,120.14	1,274.29	973.57	1,302.57
128	315.88	442.14	800.25	890.74	908.84	1,081.60	1,128.96	1,284.31	981.25	1,312.82
129	318.96	445.61	806.50	897.71	915.96	1,090.05	1,137.78	1,294.33	988.90	1,323.08
130	321.43	449.06	812.76	904.67	923.05	1,098.50	1,146.60	1,304.38	996.58	1,333.34
131	323.28	452.51	819.01	911.62	930.14	1,106.95	1,155.42	1,314.41	1,004.24	1,343.59
132	325.75	455.96	825.27	918.59	937.25	1,115.40	1,164.24	1,324.43	1,011.90	1,353.85
133	328.22	459.42	831.51	925.54	944.35	1,123.85	1,173.06	1,334.49	1,019.58	1,364.11
134	330.68	462.88	837.76	932.50	951.45	1,132.30	1,181.88	1,344.53	1,027.23	1,374.36
135	333.80	466.33	844.01	939.47	958.55	1,140.75	1,190.70	1,354.54	1,034.90	1,384.62
136	335.62	469.78	850.27	946.42	965.65	1,149.20	1,199.52	1,364.60	1,042.57	1,394.88
137	338.09	473.24	856.52	953.37	972.75	1,157.65	1,208.34	1,374.63	1,050.24	1,405.13
138	341.21	476.69	862.78	960.35	979.85	1,166.10	1,217.16	1,384.66	1,057.91	1,415.39
139	343.03	480.14	869.03	967.30	986.96	1,174.55	1,225.98	1,394.68	1,065.57	1,425.64
140	345.51	483.59	875.27	974.25	994.05	1,183.00	1,234.80	1,404.72	1,073.23	1,435.90
141	348.63	487.05	881.52	981.22	1,001.15	1,191.45	1,243.62	1,414.76	1,080.91	1,446.16
142	351.10	490.50	887.78	988.18	1,008.26	1,199.90	1,252.44	1,424.79	1,088.57	1,456.41
143	352.90	493.96	894.03	995.13	1,015.35	1,208.35	1,261.26	1,434.82	1,096.22	1,466.67
144	355.38	497.41	900.29	1,002.10	1,022.46	1,216.80	1,270.08	1,444.86	1,103.90	1,476.93
145	357.84	500.88	906.54	1,009.05	1,029.55	1,225.25	1,278.90	1,454.89	1,111.56	1,487.18
146	360.31	504.33	912.79	1,016.01	1,036.65	1,233.70	1,287.72	1,464.92	1,119.24	1,497.44
147	362.77	507.78	919.03	1,022.98	1,043.76	1,242.15	1,296.54	1,474.97	1,126.90	1,507.70
148	365.25	511.23	925.29	1,029.93	1,050.85	1,250.60	1,305.36	1,484.99	1,134.56	1,517.95
149	368.41	514.69	931.54	1,036.88	1,057.96	1,259.05	1,314.18	1,495.03	1,142.23	1,528.21
150	370.88	518.14	937.79	1,043.86	1,065.06	1,267.50	1,323.00	1,505.06	1,149.90	1,538.46
More Than 150 Pounds**										
Price Per Pound	\$2.47	\$3.45	\$6.25	\$6.96	\$7.10	\$8.45	\$8.82	\$10.03	\$7.67	\$10.26

*Zone 124 is metro Alaska and Hawaii, zone 125 is Puerto Rico, and zone 126 is remote Alaska and Hawaii. Zone 126 for remote Hawaii is not delivered the next business day. Delivery to this zone requires an additional day.

**For each UPS Next Day Air package with a weight of more than 150 pounds, multiply the weight by the price per pound.

Note: For additional information, refer to page 26.

Domestic

UPS Next Day Air Saver[®]

Guaranteed on-time delivery to commercial destinations within the 48 contiguous states and select locations in Alaska and Hawaii by 3:00 p.m. or 4:30 p.m. the next business day where UPS Next Day Air[®] delivery is committed by 10:30 a.m. or 12:00 p.m., respectively. Shipments to residential locations within the UPS Next Day Air Saver area are delivered by end of day. Not available to destinations where UPS Next Day Air service is committed by end of day. Optional Saturday pickup available. Saturday Delivery is not available.

Zones	132	133	134	135	136	137	138
Letter*	\$26.07	\$31.66	\$39.44	\$42.76	\$43.61	\$47.80	\$49.98
1 Lbs.	29.35	40.63	54.90	61.02	66.13	72.19	75.78
2	31.29	42.79	63.13	68.85	76.13	82.32	87.84
3	34.01	45.70	70.02	76.33	82.09	90.89	96.03
4	36.69	48.45	75.85	83.58	92.21	98.73	105.14
5	37.33	48.87	80.69	90.88	95.17	101.75	107.48
6	39.80	55.14	89.76	97.83	106.56	113.67	119.75
7	40.69	57.53	96.06	105.28	114.15	121.03	127.96
8	42.82	59.17	101.44	112.10	121.83	129.61	135.96
9	44.28	61.73	108.12	119.27	125.56	138.18	144.76
10	44.51	63.54	110.08	122.34	128.08	141.34	147.99
11	47.95	67.55	120.69	136.33	146.11	156.31	161.05
12	49.79	70.39	127.33	142.56	153.27	165.00	169.64
13	50.34	73.92	133.39	149.17	159.48	173.55	177.82
14	51.78	76.80	140.18	153.96	165.64	181.12	186.63
15	53.77	79.47	144.45	160.16	170.37	187.12	193.63
16	54.91	80.75	152.01	167.71	177.49	191.99	198.55
17	56.63	83.44	156.33	171.42	181.59	196.35	202.80
18	59.41	83.78	161.03	174.98	185.59	200.56	208.22
19	61.01	87.34	164.87	178.66	189.77	205.06	213.58
20	62.14	89.93	170.07	187.40	192.85	211.73	216.57
21	63.82	91.66	180.23	193.56	206.25	221.61	233.94
22	66.06	93.60	184.88	203.51	207.79	235.15	243.65
23	67.19	95.39	190.01	208.63	215.10	238.98	244.85
24	68.86	96.99	192.20	211.30	219.17	240.79	247.81
25	69.79	99.00	194.34	211.97	220.13	243.61	248.77
26	69.99	101.97	205.57	225.34	238.77	250.07	261.91
27	73.17	104.61	211.02	229.22	243.84	256.56	274.31
28	73.49	107.33	217.11	235.76	245.62	262.58	281.48
29	74.91	109.34	222.42	237.13	245.84	270.58	283.05
30	78.32	110.54	222.95	239.34	246.98	271.82	283.61
31	79.77	111.80	232.54	250.72	266.32	281.63	294.72
32	81.43	113.73	237.60	251.86	271.60	283.06	299.71
33	83.23	116.00	242.46	262.77	276.71	297.94	312.25
34	84.67	118.60	247.97	267.49	277.24	304.44	314.80
35	87.09	120.94	248.53	271.83	277.76	310.28	319.92

*The Letter rate applies only to documents, correspondence and electronic media shipments that do not exceed eight ounces sent in a UPS Express[®] Envelope.

Note: For additional information, refer to page [26](#).

Domestic

UPS Next Day Air Saver®

Zones	132	133	134	135	136	137	138
36 Lbs.	\$87.63	\$123.54	\$258.92	\$277.61	\$288.02	\$315.05	\$327.04
37	87.83	126.44	265.31	285.22	302.77	322.40	335.84
38	89.38	127.73	269.71	292.04	307.88	327.02	336.84
39	91.65	128.02	274.67	297.05	308.40	332.81	342.76
40	95.80	133.87	275.18	297.55	309.30	336.51	343.55
41	97.45	135.60	285.30	305.56	327.26	341.50	359.11
42	99.26	137.62	290.35	310.46	329.05	342.82	370.30
43	100.91	140.55	296.88	319.19	335.30	360.26	383.70
44	102.65	144.15	302.08	328.33	341.44	366.35	390.53
45	104.32	147.59	306.90	331.73	342.06	372.53	391.84
46	105.89	150.10	312.07	341.19	354.64	376.95	407.10
47	108.16	152.51	312.59	342.60	356.71	378.10	409.27
48	109.75	154.69	312.82	345.36	356.91	385.25	410.43
49	111.42	157.76	313.02	345.64	357.13	385.99	410.48
50	113.61	160.07	313.87	347.19	358.32	387.63	410.67
51	116.36	164.93	327.58	379.46	387.50	420.45	434.83
52	118.69	167.41	351.47	387.20	402.25	429.52	459.64
53	120.85	170.91	356.87	395.13	403.72	438.82	468.05
54	122.44	174.29	362.72	397.88	404.15	448.68	472.74
55	124.46	177.92	365.47	398.89	405.18	455.06	473.14
56	127.10	180.98	365.85	408.25	416.72	461.43	473.19
57	129.84	184.81	366.57	409.38	418.69	462.08	473.94
58	131.25	189.05	367.03	409.78	427.57	463.36	475.18
59	131.64	193.91	376.12	416.19	428.47	464.70	498.82
60	132.01	196.30	377.03	416.83	429.38	491.29	501.42
61	135.96	201.93	392.80	429.34	447.38	507.11	520.11
62	138.44	204.82	399.01	434.86	449.27	514.57	532.99
63	140.89	208.87	402.73	435.50	451.41	522.12	533.04
64	146.17	209.75	403.14	448.13	465.86	531.83	553.15
65	150.60	216.23	406.76	453.19	468.88	540.31	562.30
66	153.31	216.90	424.31	467.79	483.72	541.16	563.49
67	154.79	225.47	426.06	469.25	485.21	541.57	563.54
68	156.27	229.64	426.49	475.23	485.64	541.97	564.47
69	156.32	232.50	426.94	478.78	486.45	542.37	576.93
70	162.90	235.92	427.34	479.36	486.88	543.57	579.49
71	166.01	239.67	428.77	480.26	487.80	567.15	581.65
72	166.41	243.39	457.38	496.88	504.67	590.20	610.11
73	167.13	248.86	460.24	498.55	506.36	594.96	624.63
74	167.80	249.42	460.69	498.97	506.78	595.44	626.39
75	177.33	255.60	461.48	499.83	507.63	596.25	627.19

Note: For additional information, refer to page 26.

Domestic

UPS Next Day Air Saver[®]

Zones	132	133	134	135	136	137	138
76 Lbs.	\$178.29	\$256.47	\$464.03	\$507.36	\$512.75	\$613.74	\$629.62
77	181.19	259.89	465.99	518.29	534.41	615.73	630.85
78	182.11	269.11	483.64	531.73	548.92	620.92	631.69
79	182.92	270.29	485.41	539.99	557.39	634.22	640.88
80	183.79	278.45	486.22	541.78	559.05	636.94	643.63
81	184.60	283.17	501.07	576.33	589.86	653.55	660.40
82	196.87	287.73	503.79	579.78	592.95	655.21	662.09
83	198.11	290.11	504.62	580.64	593.81	656.07	662.95
84	198.91	290.94	505.47	581.49	594.69	667.05	676.86
85	199.72	293.16	506.31	582.34	595.51	667.10	678.38
86	204.06	300.53	507.79	590.44	596.68	672.19	679.23
87	205.07	302.77	526.57	592.92	599.43	673.25	680.30
88	205.90	307.50	528.46	593.77	600.95	674.73	683.74
89	212.68	311.99	550.85	614.77	630.26	721.21	752.43
90	215.64	312.46	571.59	618.46	640.77	751.76	766.69
91	216.51	312.94	573.68	619.28	641.59	754.82	768.10
92	223.47	322.76	574.57	620.10	642.52	755.67	769.03
93	225.78	323.74	576.64	620.92	643.33	756.50	769.95
94	226.65	332.25	577.45	621.74	644.14	757.64	770.88
95	227.52	333.09	578.26	623.60	644.99	758.47	771.80
96	228.33	333.27	579.07	630.99	649.94	759.30	772.61
97	229.13	333.68	580.05	634.05	656.65	760.13	773.65
98	230.69	338.38	599.63	638.15	669.73	762.58	775.50
99	231.50	339.08	609.10	669.98	694.13	799.84	812.36
100	232.30	339.13	610.04	681.80	697.81	836.28	872.64
101	234.64	341.75	616.16	688.60	702.23	844.65	881.37
102	236.95	345.13	622.26	695.43	709.17	853.01	890.10
103	239.27	348.51	628.35	702.25	716.13	861.37	898.82
104	241.60	351.90	634.45	709.07	723.09	869.74	907.55
105	243.92	355.28	640.55	715.88	730.04	878.10	916.28
106	246.24	358.66	646.65	722.71	737.00	886.46	925.00
107	248.57	362.04	652.75	729.52	743.95	894.82	933.73
108	250.89	365.42	658.86	736.33	750.90	903.19	942.46
109	253.21	368.81	664.96	743.16	757.84	911.55	951.18
110	255.53	372.20	671.06	749.97	764.81	919.91	959.91
111	257.86	375.58	677.15	756.79	771.76	928.28	968.64
112	260.18	378.96	683.25	763.60	778.70	936.64	977.36
113	262.50	382.34	689.35	770.43	785.67	945.00	986.09
114	264.83	385.72	695.45	777.24	792.61	953.36	994.81
115	267.15	389.11	701.56	784.05	799.57	961.73	1,003.54

Note: For additional information, refer to page 26.

Domestic

UPS Next Day Air Saver®

Zones	132	133	134	135	136	137	138
116 Lbs.	\$269.47	\$392.50	\$707.66	\$790.88	\$806.51	\$970.09	\$1,012.27
117	271.80	395.89	713.76	797.70	813.48	978.45	1,020.99
118	274.12	399.27	719.86	804.51	820.43	986.82	1,029.72
119	276.44	402.65	725.96	811.33	827.37	995.18	1,038.45
120	278.76	406.03	732.05	818.15	834.33	1,003.54	1,047.17
121	281.09	409.41	738.15	824.96	841.28	1,011.90	1,055.90
122	283.41	412.80	744.26	831.79	848.23	1,020.27	1,064.63
123	285.73	416.18	750.36	838.59	855.18	1,028.63	1,073.35
124	288.06	419.56	756.46	845.41	862.14	1,036.99	1,082.08
125	290.38	422.94	762.56	852.24	869.09	1,045.35	1,090.80
126	292.70	426.33	768.66	859.05	876.05	1,053.72	1,099.53
127	295.03	429.71	774.76	865.88	883.00	1,062.08	1,108.26
128	297.35	433.09	780.86	872.69	889.95	1,070.44	1,116.98
129	299.67	436.49	786.96	879.51	896.91	1,078.81	1,125.71
130	301.99	439.87	793.06	886.34	903.85	1,087.17	1,134.44
131	304.32	443.25	799.17	893.15	910.80	1,095.53	1,143.16
132	306.64	446.63	805.27	899.96	917.76	1,103.89	1,151.89
133	308.96	450.01	811.36	906.78	924.71	1,112.26	1,160.62
134	311.29	453.40	817.46	913.59	931.65	1,120.62	1,169.34
135	313.61	456.79	823.56	920.42	938.63	1,128.98	1,178.07
136	315.93	460.17	829.67	927.24	945.58	1,137.35	1,186.80
137	318.26	463.55	835.76	934.04	952.52	1,145.71	1,195.52
138	320.58	466.93	841.86	940.87	959.48	1,154.07	1,204.25
139	322.90	470.31	847.97	947.70	966.43	1,162.43	1,212.97
140	325.22	473.69	854.07	954.50	973.38	1,170.80	1,221.70
141	327.55	477.08	860.17	961.32	980.33	1,179.16	1,230.43
142	329.87	480.47	866.26	968.14	987.28	1,187.52	1,239.15
143	332.19	483.86	872.37	974.96	994.24	1,195.89	1,247.88
144	334.52	487.24	878.47	981.78	1,001.19	1,204.25	1,256.61
145	336.84	490.62	884.57	988.59	1,008.15	1,212.61	1,265.33
146	339.16	494.00	890.66	995.40	1,015.10	1,220.97	1,274.06
147	341.49	497.39	896.77	1,002.23	1,022.06	1,229.34	1,282.79
148	343.81	500.77	902.87	1,009.05	1,029.00	1,237.70	1,291.51
149	346.13	504.15	908.97	1,015.86	1,035.95	1,246.06	1,300.24
150	348.45	507.53	915.08	1,021.11	1,042.92	1,254.42	1,308.96
More Than 150 Pounds*							
Price Per Pound	\$2.32	\$3.38	\$6.10	\$6.81	\$6.95	\$8.36	\$8.73

*For each UPS Next Day Air Saver package with a weight of more than 150 pounds, multiply the weight by the price per pound.

Note: For additional information, refer to page [26](#).

Domestic

UPS 2nd Day Air A.M.^{®*}

Guaranteed on-time delivery by 10:30 a.m. or 12:00 p.m. on the second business day to metropolitan commercial destinations in the 48 contiguous states and limited addresses in Alaska and Hawaii where UPS Next Day Air[®] delivery is committed by 10:30 a.m. or 12:00 p.m., respectively. Not available to destinations where UPS Next Day Air service is committed by end of day. Also not available to residential destinations. Optional Saturday pickup available. Saturday Delivery is not available.

Zones	242	243	244	245	246	247	248
Letter**	\$20.57	\$21.39	\$22.34	\$25.86	\$31.77	\$35.45	\$36.19
1 Lbs.	21.71	22.61	24.54	29.43	36.16	38.60	39.43
2	22.09	23.06	24.76	31.35	40.01	44.47	46.79
3	22.45	23.81	26.22	34.54	45.96	51.50	54.64
4	23.13	24.62	28.40	40.21	52.91	59.87	61.94
5	23.81	25.45	31.55	44.47	58.90	66.35	70.31
6	24.84	26.40	34.38	48.57	66.30	73.67	77.00
7	25.90	29.84	37.30	52.75	73.19	81.82	84.43
8	26.93	32.29	39.89	57.54	81.27	90.17	93.33
9	28.37	34.78	43.11	61.77	89.73	96.59	101.96
10	29.71	35.96	46.27	65.98	93.60	105.06	109.51
11	31.04	37.00	47.08	67.30	96.88	109.65	111.87
12	33.70	41.18	51.05	75.19	110.91	123.02	127.71
13	34.99	42.48	52.00	78.62	115.95	126.34	132.19
14	36.71	44.35	56.45	83.53	123.03	135.76	138.58
15	39.28	46.66	59.20	86.76	131.72	141.41	146.84
16	40.82	48.22	61.79	89.58	137.50	148.66	153.05
17	41.44	49.65	64.47	95.64	141.07	156.61	159.43
18	44.08	52.43	66.79	98.94	149.64	163.49	167.08
19	44.50	52.71	68.45	102.99	155.14	171.03	175.71
20	44.73	54.95	71.08	105.31	157.68	173.67	178.94
21	49.12	56.81	73.75	110.91	166.35	182.97	190.08
22	49.69	58.22	78.32	114.01	171.79	185.78	196.98
23	51.68	62.92	81.15	117.26	177.98	196.20	205.08
24	53.82	63.76	83.35	121.82	181.02	203.90	212.41
25	54.32	65.09	84.11	126.02	190.46	211.04	219.01
26	55.98	66.87	88.49	130.13	196.94	217.47	224.85
27	56.90	69.83	91.55	134.74	203.62	225.65	231.23
28	58.29	70.60	92.29	137.91	208.84	231.45	237.72
29	61.26	70.81	94.23	141.22	210.49	236.37	242.18
30	62.58	74.36	95.68	145.57	216.23	240.49	245.30
31	63.55	76.81	98.24	148.82	225.36	248.94	257.52
32	63.74	81.21	101.04	149.60	231.96	253.40	259.32
33	66.30	81.87	107.34	155.68	238.16	259.69	264.90
34	68.37	81.99	108.14	158.15	245.36	267.19	278.02
35	69.75	82.96	108.30	160.47	248.09	268.90	279.72

*Visit [ups.com/holidays](https://www.ups.com/holidays) for time in transit changes effective during the holiday season.

**The Letter rate applies only to documents, correspondence and electronic media shipments that do not exceed eight ounces sent in a UPS Express[®] Envelope.

Note: For additional information, refer to page [26](#).

Domestic

UPS 2nd Day Air A.M.^{®*}

Zones	242	243	244	245	246	247	248
36 Lbs.	\$72.07	\$86.47	\$110.56	\$164.53	\$254.73	\$277.40	\$291.81
37	72.31	87.49	111.74	167.01	261.64	283.60	294.68
38	74.16	88.71	115.93	167.18	273.36	290.06	295.88
39	77.10	90.07	116.36	170.70	280.00	302.62	314.50
40	77.45	92.43	120.85	183.02	286.35	307.29	321.97
41	81.08	95.70	122.26	184.44	292.83	321.21	330.64
42	83.31	99.82	125.77	190.32	293.54	329.12	338.96
43	84.66	100.24	129.05	193.51	301.88	335.25	346.03
44	85.57	101.30	133.88	196.94	312.07	340.91	352.83
45	85.80	103.70	137.88	199.70	317.78	347.30	358.09
46	86.04	108.66	141.19	202.73	322.75	354.25	368.17
47	89.56	109.85	141.60	205.56	323.34	358.35	373.13
48	91.34	109.94	145.57	208.58	335.23	364.48	373.18
49	91.80	113.46	146.72	211.20	341.02	364.53	374.15
50	92.76	119.53	149.96	215.68	346.85	374.49	380.92
51	98.04	120.94	151.20	220.26	365.62	387.22	410.46
52	102.69	125.15	154.61	221.04	370.53	393.98	410.51
53	103.35	125.60	162.54	221.56	371.03	400.89	410.56
54	103.80	128.41	163.33	231.72	371.48	404.32	415.99
55	104.23	128.81	163.73	232.75	371.88	412.64	416.77
56	105.97	129.20	164.13	233.38	372.28	415.66	419.82
57	107.40	129.60	164.52	244.81	372.83	420.38	424.59
58	107.87	130.48	164.92	245.96	373.23	425.34	436.84
59	110.37	133.25	168.49	246.44	377.51	429.49	436.89
60	111.07	137.95	169.18	255.78	391.83	441.26	446.77
61	111.47	138.68	169.59	256.73	393.60	442.20	458.35
62	111.86	139.13	173.24	257.23	395.72	446.62	459.51
63	114.82	144.06	177.27	267.21	438.09	456.47	461.04
64	118.78	145.70	180.24	268.22	442.33	470.17	491.86
65	119.18	146.14	184.76	268.61	454.43	497.29	513.77
66	119.57	149.34	188.73	272.66	455.64	499.99	515.97
67	120.59	150.57	189.17	273.10	456.09	500.39	516.07
68	120.70	151.70	189.62	273.56	456.50	500.91	516.17
69	122.49	152.16	190.11	273.99	461.16	502.27	521.69
70	123.73	160.14	196.40	274.44	461.62	516.38	522.55
71	126.54	162.55	199.02	277.66	474.73	523.02	528.33
72	129.37	162.95	204.77	279.02	475.95	532.84	538.19
73	130.55	163.35	207.68	281.36	480.92	533.83	539.18
74	131.13	163.75	208.13	281.82	481.42	545.05	550.52
75	131.18	164.78	208.93	282.73	482.22	547.07	552.56

*Visit [ups.com/holidays](https://www.ups.com/holidays) for time in transit changes effective during the holiday season.

Note: For additional information, refer to page 26.

Domestic

UPS 2nd Day Air A.M.^{®*}

Zones	242	243	244	245	246	247	248
76 Lbs.	\$140.46	\$165.58	\$209.73	\$287.40	\$483.02	\$547.87	\$562.86
77	141.40	166.38	210.53	299.32	483.82	548.71	563.89
78	142.29	167.25	211.33	301.33	494.43	549.78	565.14
79	143.18	168.12	212.69	324.18	514.88	565.42	589.94
80	143.98	170.69	213.33	326.47	516.93	598.60	604.61
81	144.78	171.57	213.73	327.27	519.01	601.52	618.90
82	145.85	183.85	227.07	333.93	554.82	614.18	620.33
83	149.36	186.18	228.41	334.84	562.70	619.12	630.01
84	151.23	186.98	229.21	335.75	570.09	619.92	630.98
85	153.56	187.78	230.59	342.71	571.58	621.01	631.78
86	154.37	188.58	231.46	343.93	571.92	621.82	632.58
87	154.88	189.45	232.54	364.09	572.24	622.63	633.38
88	156.34	190.41	233.34	366.12	572.89	626.23	634.18
89	157.14	191.21	234.14	367.02	576.64	628.32	635.62
90	157.45	195.73	234.94	367.92	577.55	638.71	664.42
91	158.04	196.53	235.81	368.81	578.46	655.70	667.32
92	159.92	197.33	249.18	369.25	579.36	671.10	680.30
93	160.82	198.13	250.52	369.68	580.27	672.45	681.61
94	162.69	198.93	257.70	370.13	581.18	673.39	682.55
95	163.50	200.17	258.50	370.57	591.96	676.69	683.47
96	164.31	200.97	259.30	373.36	627.83	680.87	687.70
97	165.12	201.95	260.10	373.41	631.40	682.84	689.69
98	165.93	202.75	260.90	373.46	632.58	698.63	713.50
99	169.98	203.55	261.96	375.38	657.07	720.07	729.04
100	181.00	216.84	283.00	419.00	681.31	731.00	764.67
101	182.81	219.01	285.83	423.19	688.13	738.31	772.34
102	184.62	221.18	288.66	427.38	694.94	745.62	779.97
103	186.43	223.35	291.49	431.57	701.74	752.93	787.61
104	188.24	225.51	294.32	435.76	708.57	760.24	795.26
105	190.05	227.67	297.15	439.95	715.37	767.55	802.91
106	191.86	229.85	299.98	444.14	722.19	774.86	810.56
107	193.67	232.02	302.81	448.33	729.02	782.17	818.20
108	195.48	234.18	305.64	452.52	735.81	789.48	825.85
109	197.29	236.35	308.47	456.71	742.63	796.79	833.49
110	199.10	238.53	311.30	460.90	749.44	804.10	841.14
111	200.91	240.69	314.13	465.09	756.27	811.41	848.79
112	202.72	242.86	316.96	469.28	763.06	818.72	856.43
113	204.53	245.04	319.79	473.47	769.88	826.03	864.07
114	206.34	247.20	322.62	477.66	776.68	833.34	871.72
115	208.15	249.37	325.45	481.85	783.51	840.65	879.37

*Visit [ups.com/holidays](https://www.ups.com/holidays) for time in transit changes effective during the holiday season.

Note: For additional information, refer to page 26.

Domestic

UPS 2nd Day Air A.M.^{®*}

Zones	242	243	244	245	246	247	248
116 Lbs.	\$209.96	\$251.54	\$328.28	\$486.04	\$790.32	\$847.96	\$887.03
117	211.77	253.71	331.11	490.23	797.12	855.27	894.68
118	213.58	255.87	333.94	494.42	803.95	862.58	902.31
119	215.39	258.03	336.77	498.61	810.76	869.89	909.96
120	217.20	260.20	339.60	502.80	817.58	877.20	917.61
121	219.01	262.38	342.43	506.99	824.38	884.51	925.26
122	220.82	264.54	345.26	511.18	831.21	891.82	932.91
123	222.63	266.71	348.09	515.37	838.00	899.13	940.55
124	224.44	268.89	350.92	519.56	844.82	906.44	948.19
125	226.25	271.05	353.75	523.75	851.64	913.75	955.84
126	228.06	273.22	356.58	527.94	858.45	921.06	963.48
127	229.87	275.39	359.41	532.13	865.26	928.37	971.12
128	231.68	277.56	362.24	536.32	872.07	935.68	978.77
129	233.49	279.73	365.07	540.51	878.90	942.99	986.42
130	235.30	281.90	367.90	544.70	885.70	950.30	994.07
131	237.11	284.07	370.73	548.89	892.51	957.61	1,001.72
132	238.92	286.23	373.56	553.08	899.32	964.92	1,009.38
133	240.73	288.39	376.39	557.27	906.14	972.23	1,017.03
134	242.54	290.56	379.22	561.46	912.95	979.54	1,024.66
135	244.35	292.74	382.05	565.65	919.76	986.85	1,032.30
136	246.16	294.90	384.88	569.84	926.58	994.16	1,039.95
137	247.97	297.07	387.71	574.03	933.40	1,001.47	1,047.60
138	249.78	299.24	390.54	578.22	940.21	1,008.78	1,055.24
139	251.59	301.41	393.37	582.41	947.01	1,016.09	1,062.89
140	253.40	303.58	396.20	586.60	953.83	1,023.40	1,070.54
141	255.21	305.75	399.03	590.79	960.64	1,030.71	1,078.19
142	257.02	307.92	401.86	594.98	967.46	1,038.02	1,085.84
143	258.83	310.09	404.69	599.17	974.27	1,045.33	1,093.49
144	260.64	312.26	407.52	603.36	981.08	1,052.64	1,101.11
145	262.45	314.42	410.35	607.55	987.89	1,059.98	1,108.76
146	264.26	316.59	413.18	611.74	994.72	1,067.26	1,116.41
147	266.07	318.75	416.01	615.93	1,001.53	1,074.57	1,124.07
148	267.88	320.92	418.84	620.12	1,008.34	1,081.88	1,131.72
149	269.69	323.10	421.67	624.31	1,015.14	1,089.19	1,139.36
150	271.50	325.26	424.50	628.50	1,021.96	1,096.50	1,147.01
More Than 150 Pounds**							
Price Per Pound	\$1.81	\$2.17	\$2.83	\$4.19	\$6.81	\$7.31	\$7.65

*Visit [ups.com/holidays](https://www.ups.com/holidays) for time in transit changes effective during the holiday season.

**For each UPS 2nd Day Air A.M. package with a weight of more than 150 pounds, multiply the weight by the price per pound.

Note: For additional information, refer to page [26](#).

Domestic

UPS 2nd Day Air^{®*}

Guaranteed delivery to all 50 states and Puerto Rico with some limitations in Alaska and Hawaii by the end of the second business day.
Optional Saturday Delivery and pickup available.

Zones	202	203	204	205	206	207	208	224**	225**	226**
Letter***	\$20.12	\$20.98	\$21.88	\$25.16	\$30.63	\$52.67	\$33.34	\$48.27	\$42.67	\$57.96
1 Lbs.	20.24	21.10	22.00	25.41	30.94	33.00	33.67	48.76	43.72	59.29
2	20.86	22.02	22.86	27.38	34.82	38.63	40.63	54.43	48.96	72.50
3	21.20	22.69	24.19	30.21	40.02	44.77	46.61	62.11	55.77	75.75
4	21.84	23.48	26.19	35.20	46.15	51.01	52.95	66.17	59.45	79.16
5	22.50	24.24	28.48	39.03	51.54	56.72	60.11	71.78	64.55	82.24
6	23.48	25.23	31.03	42.62	57.18	63.02	65.82	80.71	68.68	87.05
7	24.47	27.54	33.65	46.57	64.32	69.69	72.37	82.12	74.02	91.27
8	25.44	30.03	35.99	50.81	71.03	76.77	79.65	91.50	77.86	96.10
9	26.74	31.36	38.89	54.54	77.13	84.17	87.32	93.01	83.26	101.68
10	26.96	33.44	41.87	58.27	82.65	91.57	94.55	106.22	90.40	108.49
11	29.34	35.26	43.80	62.30	89.03	98.30	102.36	108.20	95.71	112.86
12	30.89	37.33	46.22	65.81	95.93	105.43	108.33	110.50	99.21	113.38
13	33.06	39.26	48.01	69.76	102.18	110.56	115.83	120.82	102.81	123.08
14	34.71	41.30	51.12	73.78	108.42	116.16	120.98	125.55	106.82	127.81
15	36.02	42.25	53.61	76.62	114.17	121.30	126.47	131.34	111.67	133.59
16	36.87	43.64	55.83	79.12	118.96	127.52	131.83	136.73	116.32	138.99
17	38.00	44.94	58.10	82.91	124.32	134.33	137.96	143.26	121.89	145.52
18	39.28	46.43	60.37	85.78	129.46	140.26	144.62	147.52	129.14	149.46
19	40.83	47.70	62.00	89.29	134.12	146.71	150.88	156.74	133.30	158.99
20	42.24	49.76	64.40	93.45	138.90	151.75	156.51	162.29	138.17	164.54
21	44.21	51.69	66.82	96.60	139.45	156.96	161.87	165.11	144.49	165.25
22	45.57	54.18	68.66	99.32	148.52	162.95	168.15	171.50	150.00	176.23
23	46.69	55.38	71.13	102.15	153.89	168.31	173.91	177.39	155.50	177.54
24	47.76	57.57	73.40	106.12	159.49	172.29	175.74	179.27	161.17	183.63
25	49.31	59.22	74.79	109.76	164.69	181.05	188.62	196.05	166.79	198.31
26	50.78	60.85	77.56	113.36	170.28	187.27	193.82	201.16	171.08	203.94
27	52.40	62.63	79.54	117.36	176.05	193.57	199.90	207.67	176.71	209.96
28	54.09	64.68	81.37	120.16	180.56	198.55	204.74	214.34	182.46	217.71
29	55.48	65.88	83.78	123.01	185.40	203.53	210.83	219.74	186.96	224.07
30	55.70	67.67	86.67	127.03	190.49	209.02	216.18	226.72	192.85	230.03
31	55.92	69.94	89.01	129.88	194.84	213.56	221.97	232.28	197.62	237.24
32	56.16	71.49	91.55	133.04	200.56	219.49	227.32	239.59	203.93	243.37
33	60.81	73.36	94.10	135.87	205.93	224.54	233.10	240.97	209.32	250.15
34	62.70	74.71	96.07	140.63	212.16	230.12	238.84	244.96	214.94	251.50
35	63.98	76.98	98.14	143.40	218.54	235.89	242.28	245.45	220.67	251.78

*Visit [ups.com/holidays](https://www.ups.com/holidays) for time in transit changes effective during the holiday season.

**Zone 224 is metro Alaska and Hawaii, zone 225 is Puerto Rico and zone 226 is remote Alaska and Hawaii.

***The Letter rate applies only to documents, correspondence and electronic media shipments that do not exceed eight ounces sent in a UPS Express[®] Envelope.

Note: For additional information, refer to page [26](#).

Domestic

UPS 2nd Day Air^{®*}

Zones	202	203	204	205	206	207	208	224**	225**	226**
36 Lbs.	\$64.97	\$78.67	\$100.17	\$146.35	\$224.41	\$243.34	\$248.54	\$251.72	\$225.92	\$257.22
37	66.18	79.80	102.59	150.14	230.50	249.81	257.60	272.25	231.64	274.07
38	67.29	81.02	105.19	153.17	236.38	256.30	264.63	275.78	237.05	276.04
39	69.42	83.15	106.96	156.22	242.09	263.13	271.51	285.22	242.61	290.93
40	69.64	85.35	109.53	159.73	247.59	269.57	277.51	290.91	247.53	298.07
41	73.02	87.42	110.79	162.67	253.18	276.61	285.00	297.28	252.88	300.82
42	74.22	89.55	113.05	166.11	258.61	283.42	292.17	304.10	258.61	307.55
43	75.76	91.40	114.77	168.87	264.70	288.69	298.26	309.72	263.60	315.29
44	77.04	92.53	117.37	171.87	269.85	293.60	304.14	315.88	268.71	320.75
45	77.39	94.80	119.08	174.28	274.77	299.09	308.66	320.47	272.70	326.98
46	79.78	95.86	121.47	176.04	279.41	303.91	316.15	322.89	279.31	327.73
47	80.02	96.08	123.49	176.57	279.92	304.40	319.16	323.18	284.62	327.96
48	81.70	99.94	125.71	177.08	289.93	313.86	321.74	328.05	289.49	328.18
49	81.92	100.34	125.94	177.19	294.86	314.84	322.01	328.46	294.90	328.74
50	82.14	100.56	129.88	177.31	299.91	316.15	322.48	328.93	295.01	329.21
51	82.89	101.00	132.75	183.03	314.34	325.02	331.53	338.14	304.96	340.39
52	88.75	106.42	137.02	193.09	319.12	344.74	356.31	360.15	305.60	362.42
53	90.52	108.57	138.96	194.51	319.60	350.77	358.75	362.36	310.16	364.62
54	91.81	109.88	141.12	194.97	320.30	352.20	359.20	362.81	313.99	368.23
55	93.49	110.32	142.35	195.41	334.01	352.64	359.65	363.26	323.47	371.37
56	94.25	110.76	142.80	195.97	335.40	353.07	360.11	363.72	324.43	371.43
57	94.69	115.54	147.18	207.05	346.32	360.20	367.37	371.06	330.31	378.31
58	95.13	116.02	147.62	208.16	352.89	360.93	368.11	371.79	335.83	378.44
59	95.57	116.71	152.73	208.62	358.24	365.41	372.73	380.15	340.37	382.41
60	96.01	117.15	153.59	214.44	360.15	373.52	381.00	388.57	344.55	390.84
61	96.44	117.59	154.04	215.02	365.26	376.59	384.13	391.19	350.71	393.45
62	96.88	118.03	154.48	215.48	366.06	377.28	384.84	392.10	362.11	394.35
63	97.32	118.47	154.93	219.93	381.89	390.73	398.55	406.45	368.26	408.72
64	103.43	120.79	155.37	220.38	384.39	392.09	399.94	407.89	368.48	410.16
65	107.31	123.98	155.81	226.23	384.81	392.51	400.37	408.34	374.90	410.60
66	107.75	124.42	157.55	226.82	385.47	393.19	401.06	409.02	381.31	411.30
67	108.19	126.91	157.94	227.28	385.90	393.62	401.50	409.49	382.65	412.71
68	108.63	127.94	162.35	227.72	386.33	394.06	401.94	409.98	392.75	412.76
69	109.07	130.77	162.80	228.71	387.64	395.40	403.31	411.39	398.38	412.81
70	109.51	142.53	168.49	248.11	404.66	421.00	429.43	437.99	403.20	440.24
71	116.15	144.45	168.60	250.06	405.97	425.20	433.72	442.33	404.33	444.60
72	116.82	144.89	168.70	250.50	417.00	425.64	434.15	442.79	405.28	445.05
73	117.22	145.33	169.48	254.62	417.71	426.07	434.60	443.25	409.52	445.50
74	117.62	145.77	169.92	255.07	418.30	426.67	435.20	443.91	431.10	445.55
75	118.43	146.66	170.80	260.21	429.87	438.48	447.25	456.16	431.18	458.42

*Visit [ups.com/holidays](https://www.ups.com/holidays) for time in transit changes effective during the holiday season.

**Zone 224 is metro Alaska and Hawaii, zone 225 is Puerto Rico and zone 226 is remote Alaska and Hawaii.

Note: For additional information, refer to page [26](#).

Domestic

UPS 2nd Day Air^{®*}

Zones	202	203	204	205	206	207	208	224**	225**	226**
76 Lbs.	\$120.68	\$147.54	\$171.67	\$262.08	\$436.60	\$445.33	\$454.24	\$463.28	\$431.35	\$465.55
77	121.56	148.42	175.17	262.97	445.59	459.05	468.23	477.30	432.74	479.54
78	122.44	149.30	178.55	275.59	446.82	462.64	501.56	509.78	434.15	512.05
79	123.33	150.18	179.43	276.86	449.21	495.00	504.90	514.96	450.56	517.22
80	124.21	151.06	180.31	277.75	473.65	498.42	508.40	518.46	450.66	523.06
81	128.51	151.86	181.19	278.65	476.11	499.28	509.27	519.39	451.30	524.80
82	129.78	152.65	183.89	279.55	477.01	500.14	510.15	520.29	471.15	524.99
83	131.52	155.04	184.77	280.44	484.52	501.00	511.02	521.19	474.73	525.89
84	132.40	155.92	187.53	281.34	489.72	509.45	519.65	529.99	474.91	532.26
85	138.51	159.47	195.17	292.85	490.62	510.31	520.54	530.90	478.15	533.49
86	139.40	164.39	196.13	294.00	491.52	511.12	521.35	532.03	478.53	534.27
87	140.28	166.39	197.01	294.89	492.42	514.56	524.86	535.32	484.12	537.58
88	141.16	167.78	197.89	295.79	493.31	518.55	528.92	539.40	492.98	541.66
89	142.03	167.95	198.77	296.69	499.40	519.41	529.80	540.30	493.46	542.57
90	142.91	168.00	199.65	297.59	504.59	520.28	530.69	541.21	500.84	543.48
91	143.79	168.79	200.52	298.48	505.48	521.14	531.57	542.11	501.26	544.38
92	144.67	169.67	201.40	299.38	506.38	522.00	532.45	543.10	505.66	544.43
93	145.55	170.55	203.76	300.27	507.28	522.85	533.32	543.99	505.82	544.48
94	146.44	171.43	203.90	301.17	508.17	523.73	534.21	544.90	522.89	545.34
95	147.32	172.31	204.64	302.07	509.73	528.38	538.95	549.74	523.00	550.19
96	149.79	173.11	209.88	307.41	518.86	529.24	539.83	550.64	525.46	551.09
97	150.60	174.08	214.95	308.31	529.76	540.37	551.18	562.21	525.89	562.67
98	151.40	174.96	215.83	309.21	542.17	553.02	564.03	569.67	526.20	582.80
99	152.20	175.84	220.92	327.21	546.03	572.17	596.03	607.91	526.58	612.81
100	153.00	191.00	245.00	346.00	555.59	629.09	655.61	668.83	566.04	676.30
101	154.53	192.91	247.45	349.46	563.36	640.34	660.54	674.68	571.69	683.04
102	156.06	194.82	249.90	352.92	567.33	646.68	667.08	681.36	577.35	689.77
103	157.59	196.73	252.35	356.38	572.89	653.02	673.62	688.04	583.02	696.52
104	159.12	198.64	254.80	359.84	577.20	659.36	680.16	694.72	588.68	703.25
105	160.65	200.55	257.25	363.30	584.03	665.70	686.70	701.40	594.33	710.00
106	162.18	202.46	259.70	366.76	589.59	672.04	693.24	708.08	599.98	716.74
107	163.71	204.37	262.15	370.22	593.85	678.38	699.78	714.76	605.66	723.48
108	165.24	206.28	264.60	373.68	599.40	684.72	706.32	721.44	611.32	730.22
109	166.77	208.19	267.05	377.14	604.95	691.06	712.86	728.12	616.98	736.96
110	168.30	210.10	269.50	380.60	611.82	697.40	719.40	734.80	622.64	743.70
111	169.83	212.01	271.95	384.06	616.05	703.74	725.94	741.48	628.30	750.44
112	171.36	213.92	274.40	387.52	622.95	710.08	732.48	748.16	633.97	757.18
113	172.89	215.83	276.85	390.98	627.15	716.42	739.02	754.84	639.61	763.92
114	174.42	217.74	279.30	394.44	632.70	722.76	745.56	761.52	645.27	770.66
115	175.95	219.65	281.75	397.90	638.25	729.10	752.10	768.20	650.94	777.40

*Visit [ups.com/holidays](https://www.ups.com/holidays) for time in transit changes effective during the holiday season.

**Zone 224 is metro Alaska and Hawaii, zone 225 is Puerto Rico and zone 226 is remote Alaska and Hawaii.

Note: For additional information, refer to page [26](#).

Domestic

UPS 2nd Day Air^{®*}

Zones	202	203	204	205	206	207	208	224**	225**	226**
116 Lbs.	\$177.48	\$221.56	\$284.20	\$401.36	\$645.20	\$735.44	\$758.64	\$774.88	\$656.62	\$784.14
117	179.01	223.47	286.65	404.82	649.35	741.78	765.18	781.56	662.25	790.88
118	180.54	225.38	289.10	408.28	654.90	748.12	771.72	788.24	667.92	797.62
119	182.07	227.29	291.55	411.74	660.45	754.46	778.26	794.92	673.59	804.36
120	183.60	229.20	294.00	415.20	666.00	760.80	784.80	801.60	679.22	811.10
121	185.13	231.11	296.45	418.66	671.55	767.14	791.34	808.28	684.90	817.84
122	186.66	233.02	298.90	422.12	677.10	773.48	797.88	814.96	690.57	824.58
123	188.19	234.93	301.35	425.58	682.65	779.82	804.42	821.64	696.23	831.32
124	189.72	236.84	303.80	429.04	689.70	786.16	810.96	828.32	701.87	838.07
125	191.25	238.75	306.25	432.50	693.75	792.50	817.50	835.00	707.55	844.80
126	192.78	240.66	308.70	435.96	700.83	798.84	824.04	841.68	713.21	851.55
127	194.31	242.57	311.15	439.42	704.85	805.18	830.58	848.36	718.87	858.28
128	195.84	244.48	313.60	442.88	710.40	811.52	837.12	855.04	724.52	865.02
129	197.37	246.39	316.05	446.34	715.95	817.86	843.66	861.72	730.17	871.76
130	198.90	248.30	318.50	449.80	721.50	824.20	850.20	868.40	735.85	878.50
131	200.43	250.21	320.95	453.26	730.69	830.54	856.74	875.08	741.51	885.24
132	201.96	252.12	323.40	456.72	734.19	836.88	863.28	881.76	747.16	891.98
133	203.49	254.03	325.85	460.18	738.15	843.22	869.82	888.44	752.83	898.73
134	205.02	255.94	328.30	463.64	743.70	849.56	876.36	895.12	758.49	905.46
135	206.55	257.85	330.75	467.10	749.25	855.90	882.90	901.80	764.16	912.21
136	208.08	259.76	333.20	470.56	754.80	862.24	889.44	908.48	769.82	918.94
137	209.61	261.67	335.65	474.02	760.35	868.58	895.98	915.16	775.47	925.69
138	211.14	263.58	338.10	477.48	767.55	874.92	902.52	921.84	781.12	932.42
139	212.67	265.49	340.55	480.94	771.45	881.26	909.06	928.52	786.78	939.17
140	214.20	267.40	343.00	484.40	777.00	887.60	915.60	935.20	792.45	945.90
141	215.73	269.31	345.45	487.86	782.55	893.94	922.14	941.88	798.10	952.64
142	217.26	271.22	347.90	491.32	788.10	900.28	928.68	948.56	803.77	959.39
143	218.79	273.13	350.35	494.78	793.65	906.62	935.22	955.24	809.43	966.12
144	220.32	275.04	352.80	498.24	799.20	912.96	941.76	961.92	815.10	972.87
145	221.85	276.95	355.25	501.70	804.75	919.30	948.30	968.60	820.75	979.60
146	223.38	278.86	357.70	505.16	810.30	925.64	954.84	975.28	826.41	986.35
147	224.91	280.77	360.15	508.62	815.85	931.98	961.38	981.96	832.07	993.08
148	226.44	282.68	362.60	512.08	823.17	938.32	967.92	988.64	837.73	999.83
149	227.97	284.59	365.05	515.54	828.74	944.66	974.46	995.32	843.40	1,006.56
150	229.50	286.50	367.50	519.00	832.50	951.00	981.00	1,002.00	849.05	1,013.31
More Than 150 Pounds***										
Price Per Pound	\$1.53	\$1.91	\$2.45	\$3.46	\$5.55	\$6.34	\$6.54	\$6.68	\$5.66	\$6.76

*Visit [ups.com/holidays](https://www.ups.com/holidays) for time in transit changes effective during the holiday season.

**Zone 224 is metro Alaska and Hawaii, zone 225 is Puerto Rico and zone 226 is remote Alaska and Hawaii.

***For each UPS 2nd Day Air package with a weight of more than 150 pounds, multiply the weight by the price per pound.

Note: For additional information, refer to page [26](#).

Domestic

UPS 3 Day Select^{®*}

Guaranteed delivery by the end of the third business day to the 48 contiguous states. Saturday Delivery and pickup available in select areas.

Zones	302	303	304	305	306	307	308
1 Lbs.	\$12.35	\$14.30	\$15.32	\$18.38	\$22.75	\$25.01	\$27.11
2	12.49	15.16	16.65	20.30	25.16	28.03	31.86
3	13.97	15.93	18.20	22.59	29.31	31.35	36.34
4	15.35	17.60	18.98	25.31	30.99	35.52	40.24
5	16.30	18.88	20.73	27.66	34.57	39.25	44.42
6	17.20	20.36	22.82	30.21	39.69	43.57	48.10
7	17.84	22.02	24.75	32.18	42.98	49.21	52.93
8	18.72	23.76	26.74	34.48	46.18	52.85	57.63
9	19.82	24.83	28.41	35.14	47.74	56.23	62.01
10	20.72	25.60	28.99	37.31	50.20	60.52	66.47
11	21.95	26.29	31.60	39.07	55.40	63.75	70.47
12	23.08	29.01	32.92	43.05	58.99	66.88	74.74
13	24.39	30.32	33.49	43.42	59.92	67.59	79.43
14	24.98	32.17	35.79	45.34	62.85	70.99	83.50
15	25.97	32.33	37.15	46.27	66.29	77.80	88.26
16	26.61	33.44	38.53	49.62	69.11	81.81	91.91
17	26.66	33.55	40.05	50.16	71.63	81.86	96.17
18	27.71	34.10	41.49	52.39	74.37	89.04	99.41
19	28.36	35.14	42.89	54.30	76.75	91.07	102.91
20	29.10	35.65	43.49	56.44	79.49	91.31	106.60
21	30.37	38.71	45.10	58.51	81.17	97.54	110.29
22	31.28	39.19	46.22	60.11	84.87	97.99	114.35
23	32.10	40.19	49.26	61.61	87.34	106.05	118.15
24	32.26	41.27	50.43	63.82	90.34	106.85	121.87
25	33.46	41.97	52.24	66.04	92.73	113.47	125.91
26	35.70	44.31	53.88	68.01	95.52	117.37	129.68
27	36.80	45.32	55.83	71.87	99.30	121.49	134.12
28	37.96	45.78	57.20	72.02	102.59	125.15	138.01
29	38.01	45.95	58.79	73.85	105.52	128.92	142.86
30	38.63	46.65	59.15	76.18	109.03	129.00	146.46
31	40.63	50.68	61.97	79.73	114.45	136.22	150.51
32	40.68	50.73	62.28	79.93	115.08	136.27	151.00
33	41.41	51.05	65.01	82.32	118.57	136.32	151.05
34	42.17	52.09	65.20	84.02	121.44	140.13	162.07
35	42.94	54.29	66.98	86.11	124.09	141.77	166.65

*Visit [ups.com/holidays](https://www.ups.com/holidays) for time in transit changes effective during the holiday season.

Notes:

- For additional information, refer to page 26.
- Shipments of Hazardous Materials using UPS 3 Day Select service must be prepared in accordance with the appropriate Air Dangerous Goods requirements. Hazardous Materials contract service is available with a Scheduled Pickup.

Domestic

UPS 3 Day Select^{®*}

Zones	302	303	304	305	306	307	308
36 Lbs.	\$44.57	\$55.67	\$69.57	\$88.13	\$127.60	\$146.69	\$170.49
37	45.20	56.05	69.88	90.39	130.19	149.64	170.97
38	45.56	56.55	71.77	92.61	132.93	151.81	171.51
39	46.84	57.01	73.19	94.41	135.98	159.82	181.08
40	47.22	57.10	73.91	95.20	139.02	160.32	184.23
41	49.74	61.54	75.81	98.44	141.42	160.84	188.15
42	50.53	63.25	78.59	101.18	144.49	164.14	192.14
43	51.57	64.83	80.09	102.99	147.41	167.79	196.73
44	52.02	65.59	82.05	105.20	150.14	171.32	196.78
45	52.69	66.33	83.57	107.28	152.70	174.44	197.69
46	53.29	67.27	87.07	111.13	157.34	181.48	209.37
47	53.47	67.39	87.55	111.57	159.36	181.64	210.61
48	53.56	68.63	87.90	115.42	163.73	193.33	217.59
49	53.94	69.62	89.32	115.82	165.05	196.62	219.05
50	54.11	69.88	89.71	115.92	165.89	198.39	219.41
51	58.75	70.11	92.43	119.82	173.62	198.92	229.90
52	59.78	74.85	92.97	121.84	176.38	198.97	232.26
53	60.50	76.89	94.54	123.30	179.35	203.84	238.04
54	61.27	77.56	96.51	125.59	182.03	207.84	242.32
55	61.68	79.05	97.89	127.84	184.93	211.75	242.37
56	62.55	79.33	99.34	129.80	185.05	215.55	242.78
57	62.82	80.01	101.06	131.74	187.54	221.85	243.79
58	63.24	80.71	102.30	133.83	191.57	223.73	247.82
59	63.51	81.49	103.84	135.66	193.76	227.45	252.28
60	65.62	84.35	104.46	135.84	197.48	228.76	256.85
61	65.67	85.64	106.86	140.58	201.43	235.02	261.16
62	65.72	87.48	108.25	142.53	205.07	239.08	265.16
63	66.99	88.51	109.64	144.55	207.99	242.93	269.54
64	67.98	90.40	110.82	146.93	212.16	247.55	273.85
65	68.35	91.57	111.08	147.52	215.52	250.44	280.36
66	70.51	93.27	113.74	150.65	217.89	254.56	286.23
67	70.58	93.32	115.31	152.93	221.12	258.49	286.92
68	70.67	93.89	118.29	154.87	224.29	262.15	299.18
69	71.00	94.97	119.38	156.57	226.30	263.31	304.59
70	71.76	95.29	119.50	157.94	226.50	266.14	304.64
71	73.14	97.58	122.12	160.34	235.76	272.86	308.28
72	75.36	98.94	123.62	162.46	235.90	276.66	309.41
73	77.70	100.54	125.74	164.49	238.73	279.46	310.47
74	78.36	101.55	127.42	167.01	242.67	281.11	314.03
75	78.74	101.68	128.95	169.10	244.89	281.23	315.04

*Visit [ups.com/holidays](https://www.ups.com/holidays) for time in transit changes effective during the holiday season.

Notes:

- For additional information, refer to page 26.
- Shipments of Hazardous Materials using UPS 3 Day Select service must be prepared in accordance with the appropriate Air Dangerous Goods requirements. Hazardous Materials contract service is available with a Scheduled Pickup.

Domestic

UPS 3 Day Select^{®*}

Zones	302	303	304	305	306	307	308
76 Lbs.	\$79.24	\$101.96	\$129.52	\$171.67	\$249.09	\$291.89	\$337.46
77	82.51	102.63	131.35	173.64	252.20	295.60	337.51
78	82.56	102.87	132.67	174.94	252.32	300.58	337.56
79	83.45	104.26	132.86	175.91	253.18	301.81	337.61
80	83.50	105.58	134.31	176.04	253.30	302.87	337.66
81	83.90	107.24	135.06	177.79	253.64	303.59	339.59
82	84.57	109.19	137.20	180.79	269.15	312.87	343.45
83	85.83	110.39	137.90	182.86	269.42	313.78	347.57
84	86.73	116.20	139.85	185.21	269.75	314.49	350.90
85	87.12	116.25	142.95	189.28	278.42	322.86	356.32
86	91.07	117.70	146.01	191.05	282.53	326.05	360.84
87	92.14	122.88	147.93	192.51	283.80	333.33	364.84
88	92.21	124.54	148.71	195.13	284.07	333.46	368.37
89	92.26	126.33	150.17	197.14	288.13	337.69	371.88
90	92.33	128.09	155.18	199.80	292.13	339.07	375.67
91	99.11	128.97	156.17	201.56	292.24	340.77	381.86
92	99.34	129.02	157.53	204.23	293.77	341.94	386.32
93	99.53	130.40	159.67	205.66	293.96	351.29	390.57
94	99.69	131.57	161.41	210.44	300.45	353.24	395.40
95	99.81	132.18	162.49	214.42	303.04	357.83	419.02
96	100.01	132.87	162.54	218.40	305.43	358.02	421.30
97	100.45	133.95	163.89	221.12	309.06	365.15	428.10
98	101.00	134.06	167.25	222.01	309.26	370.49	431.45
99	107.55	135.29	169.40	229.83	324.14	381.57	436.33
100	107.60	138.64	175.13	235.72	338.26	401.54	449.15
101	108.08	140.03	177.96	238.62	342.58	405.61	454.23
102	109.49	141.40	180.92	240.45	344.98	409.61	458.65
103	110.90	142.18	182.64	243.37	348.51	413.47	463.21
104	111.63	142.84	184.34	245.05	351.78	417.55	467.56
105	113.04	143.51	186.06	248.26	355.10	421.56	472.26
106	113.81	144.04	188.03	249.87	358.49	426.79	476.67
107	114.89	145.06	189.27	252.10	361.95	429.70	481.11
108	115.91	146.95	191.47	254.66	365.42	433.58	485.65
109	117.28	148.54	193.80	257.62	369.71	437.66	490.22
110	117.85	149.51	195.09	260.00	373.05	441.65	494.64
111	118.94	150.89	196.67	261.63	375.46	445.59	499.12
112	120.02	152.27	198.64	263.93	378.85	449.67	503.55
113	120.46	153.53	200.36	266.24	382.12	453.59	508.10
114	122.68	154.90	202.79	269.50	385.57	457.68	512.73
115	123.78	156.30	203.85	271.80	390.13	461.70	517.01

*Visit [ups.com/holidays](https://www.ups.com/holidays) for time in transit changes effective during the holiday season.

Notes:

- For additional information, refer to page 26.
- Shipments of Hazardous Materials using UPS 3 Day Select service must be prepared in accordance with the appropriate Air Dangerous Goods requirements. Hazardous Materials contract service is available with a Scheduled Pickup.

Domestic

UPS 3 Day Select^{®*}

Zones	302	303	304	305	306	307	308
116 Lbs.	\$124.81	\$158.15	\$205.65	\$274.20	\$392.35	\$465.69	\$521.69
117	125.91	158.93	207.42	275.78	395.75	469.76	526.18
118	126.63	160.26	209.05	278.94	399.01	473.63	530.47
119	126.85	161.77	209.48	279.36	403.68	477.79	535.09
120	127.42	163.15	212.80	282.94	405.92	481.78	539.50
121	129.29	163.88	213.99	285.17	409.25	485.79	544.07
122	129.39	165.79	214.68	286.26	413.82	489.87	548.56
123	129.80	166.70	217.46	289.92	415.97	493.86	553.06
124	133.06	168.08	219.17	292.21	419.44	497.74	557.53
125	133.17	169.32	221.02	294.52	422.70	501.88	561.95
126	133.76	170.70	222.72	297.09	426.15	505.88	566.52
127	133.90	172.08	222.98	297.76	428.40	508.51	571.07
128	134.60	173.41	224.23	301.10	432.88	513.98	575.49
129	135.51	174.85	226.92	302.05	436.41	517.84	580.04
130	136.34	176.60	227.68	306.35	439.60	521.90	584.53
131	137.41	177.42	227.79	306.77	443.13	525.92	589.04
132	138.85	178.92	231.25	310.36	446.52	530.06	591.88
133	139.66	180.31	231.86	312.64	449.78	534.05	597.86
134	140.89	182.00	233.09	314.63	453.30	537.93	602.43
135	141.71	182.86	233.67	316.10	456.49	542.00	605.39
136	142.74	183.49	235.97	318.32	460.02	546.01	609.65
137	143.69	185.70	237.00	318.44	463.42	550.08	615.96
138	144.79	186.88	238.77	320.15	466.68	554.15	620.58
139	145.88	188.32	240.68	322.44	470.27	557.96	624.93
140	146.96	189.71	242.32	324.81	473.45	562.03	627.69
141	147.85	191.57	243.95	327.03	476.98	566.03	633.84
142	148.95	191.69	245.77	328.34	480.18	570.12	638.46
143	150.16	192.99	247.42	331.76	483.57	574.12	642.95
144	151.25	194.37	249.06	333.98	487.11	578.04	647.45
145	152.28	194.53	251.02	336.22	490.35	582.13	651.87
146	153.23	194.71	252.73	338.65	492.49	586.15	656.55
147	154.32	199.75	255.09	340.94	495.66	590.21	660.91
148	155.41	199.86	256.08	343.25	500.55	595.90	667.36
149	156.44	199.97	257.84	344.76	502.55	598.00	669.87
150	157.45	200.72	259.55	346.97	507.26	602.23	674.37
More Than 150 Pounds**							
Price Per Pound	\$1.05	\$1.34	\$1.73	\$2.31	\$3.38	\$4.01	\$4.50

*Visit [ups.com/holidays](https://www.ups.com/holidays) for time in transit changes effective during the holiday season.

**For each UPS 3 Day Select package with a weight of more than 150 pounds, multiply the weight by the price per pound.

Notes:

- For additional information, refer to page 26.
- Shipments of Hazardous Materials using UPS 3 Day Select service must be prepared in accordance with the appropriate Air Dangerous Goods requirements. Hazardous Materials contract service is available with a Scheduled Pickup.

Domestic UPS® Ground*

Guaranteed day-definite delivery typically in one to five business days to all 50 states and Puerto Rico. Refer to UPS Ground Time in Transit maps at [ups.com/maps](https://www.ups.com/maps) to determine scheduled delivery. Saturday Delivery and pickup available in select areas.

Zones	2	3	4	5	6	7	8	44**	45**	46**
1 Lbs.	\$8.76	\$9.09	\$9.91	\$10.35	\$10.71	\$10.83	\$11.01	\$32.71	\$33.63	\$43.09
2	9.42	10.48	11.33	11.58	12.08	12.54	12.75	36.39	37.66	46.76
3	9.90	11.04	11.94	12.43	12.94	13.38	14.03	39.54	42.90	49.79
4	10.19	11.11	12.32	13.12	13.48	14.36	15.03	43.42	45.73	54.01
5	10.46	11.62	12.75	13.70	14.29	15.02	16.02	47.07	49.65	57.45
6	10.65	11.77	12.87	13.90	14.41	15.19	16.09	50.79	52.83	59.66
7	11.25	12.05	13.21	14.34	14.68	15.60	16.70	54.23	56.94	62.71
8	11.58	12.49	13.68	14.75	15.27	16.23	17.43	56.03	59.89	65.77
9	11.76	12.66	13.86	14.88	15.59	16.90	18.36	59.98	64.05	69.70
10	11.92	12.79	14.00	15.29	15.77	17.71	19.57	63.72	69.54	73.44
11	12.52	13.04	14.28	15.35	16.28	19.16	20.83	66.99	73.62	76.74
12	12.73	13.59	14.42	15.57	16.85	19.93	21.80	69.86	76.32	79.58
13	12.79	13.65	14.59	15.87	17.38	21.34	23.00	72.76	79.08	82.43
14	13.25	14.02	14.74	16.26	18.39	22.66	24.74	75.77	82.17	85.41
15	13.26	14.32	14.95	16.83	19.41	23.38	26.04	78.56	85.90	88.15
16	13.60	14.73	15.22	17.12	20.04	24.59	27.02	82.07	89.48	91.66
17	13.70	15.03	15.39	17.60	20.88	25.85	27.58	85.57	93.76	94.56
18	13.84	15.26	15.55	18.45	21.98	26.62	29.47	89.11	99.34	98.06
19	14.19	15.94	16.33	19.26	22.54	27.35	30.48	92.62	102.54	101.55
20	14.29	16.07	16.42	20.01	23.31	28.36	31.89	95.72	106.28	104.60
21	14.81	16.70	17.29	20.24	24.27	29.44	32.87	97.91	111.15	106.79
22	14.85	16.87	17.76	20.99	25.25	30.52	34.31	100.98	115.38	109.85
23	14.91	17.19	18.33	21.59	26.46	31.54	35.66	104.03	119.62	112.89
24	15.31	17.89	19.10	22.49	27.46	32.30	37.71	107.44	123.98	116.29
25	15.49	18.09	19.32	22.93	27.97	33.70	38.45	110.77	128.30	119.64
26	16.23	18.71	20.13	23.87	28.99	35.09	40.03	114.27	131.60	123.40
27	16.63	19.15	20.34	24.26	30.13	35.73	40.71	117.43	135.93	126.63
28	17.08	19.61	21.48	25.83	31.62	37.33	42.66	120.60	140.35	129.81
29	17.12	19.99	21.88	25.93	32.53	38.54	43.39	123.54	143.82	132.41
30	17.45	20.47	22.72	26.95	33.02	38.73	45.20	126.50	148.35	135.42
31	18.06	20.96	23.00	27.09	33.74	39.85	46.73	126.52	152.02	135.50
32	18.07	20.97	23.01	27.10	34.06	39.88	47.68	127.57	156.87	136.45
33	18.18	21.28	24.04	28.38	35.86	41.19	48.51	130.24	161.02	139.17
34	18.29	21.76	24.81	29.37	36.28	42.43	50.84	133.15	165.34	142.02
35	18.63	22.91	25.38	30.08	36.82	43.52	51.69	136.45	169.75	145.31

*Visit [ups.com/holidays](https://www.ups.com/holidays) for time in transit changes effective during the holiday season.

**Zone 44 is metro Alaska and Hawaii, zone 45 is Puerto Rico and zone 46 is remote Alaska and Hawaii.

Notes:

– For additional information, refer to page 26.

– UPS does not accept Hazardous Materials (including but not limited to Ltd Qty and combustibles) in UPS Ground services destined to and from Alaska; Hawaii; Puerto Rico; Avalon, CA; Catalina Island, CA; Beaver Island, MI; Mackinac Island, MI (winter only); The Bass Islands, OH; Kelleys Island, OH; and San Juan Islands, WA.

Domestic UPS® Ground*

Zones	2	3	4	5	6	7	8	44**	45**	46**
36 Lbs.	\$18.91	\$22.92	\$25.83	\$31.11	\$38.37	\$45.00	\$53.21	\$139.37	\$173.78	\$148.52
37	19.18	23.22	26.34	31.79	38.54	46.45	53.73	142.56	178.18	151.77
38	19.48	23.58	26.93	32.56	39.42	47.07	54.73	145.98	182.35	155.19
39	20.13	24.50	27.81	33.25	40.82	48.47	55.86	149.12	186.62	158.08
40	20.15	24.60	27.90	33.31	41.26	48.48	56.25	152.32	190.41	161.19
41	20.41	25.41	28.64	34.45	42.57	49.98	57.99	154.92	194.52	164.11
42	20.53	25.74	29.75	34.56	43.17	50.82	58.28	157.84	198.93	167.03
43	21.00	26.11	29.80	36.31	45.08	52.66	59.86	161.06	202.77	170.25
44	21.30	26.51	30.55	36.96	45.47	53.79	60.49	163.37	206.70	173.52
45	21.32	26.52	30.56	36.97	45.79	55.37	60.92	166.52	209.77	176.70
46	21.79	26.79	31.54	38.02	46.99	55.96	62.53	169.73	214.85	179.94
47	21.88	27.14	32.05	38.30	47.63	57.05	63.53	172.99	218.94	183.18
48	21.89	27.19	32.35	39.32	48.34	57.57	64.54	175.94	222.68	186.19
49	21.90	27.24	32.44	39.33	48.70	58.58	64.92	178.96	226.85	189.25
50	21.91	27.29	32.45	39.38	48.71	58.73	65.28	181.97	226.93	192.28
51	21.97	27.34	32.53	39.45	48.77	58.80	66.04	184.97	234.58	197.12
52	21.98	27.39	32.55	39.46	48.78	58.81	66.05	185.35	235.08	197.48
53	21.99	27.44	32.56	39.51	48.79	58.82	66.69	188.14	238.58	200.30
54	22.00	27.49	32.62	39.76	48.80	58.83	66.74	190.81	241.53	203.32
55	22.01	27.53	32.63	39.96	48.85	58.84	66.79	193.37	248.82	206.38
56	22.02	27.58	32.68	39.97	48.86	58.89	67.54	195.98	249.56	209.38
57	22.41	27.67	32.75	41.17	48.91	58.94	68.23	198.68	254.08	212.62
58	22.42	27.68	32.80	41.21	48.92	58.99	69.46	201.29	258.33	215.63
59	22.61	27.70	33.20	41.22	49.65	59.04	69.96	204.35	261.82	218.84
60	23.06	28.77	33.76	42.66	50.10	59.31	70.40	207.54	265.04	222.06
61	23.07	28.86	33.80	42.79	50.55	59.65	70.83	210.09	269.78	224.71
62	24.02	30.90	34.65	44.01	50.88	60.57	71.27	213.55	275.40	228.23
63	24.03	30.91	34.99	44.02	51.23	60.68	71.70	217.04	279.90	231.81
64	24.67	31.22	35.56	44.07	52.07	61.08	72.80	220.65	283.45	235.53
65	24.94	32.06	35.57	44.12	52.52	61.22	72.93	224.26	288.38	239.27
66	25.29	32.07	35.58	44.14	52.55	61.41	73.24	227.73	293.32	242.81
67	25.30	32.12	35.63	44.19	52.97	61.71	73.29	231.18	294.35	246.39
68	25.59	32.98	37.73	45.10	53.25	62.07	73.34	234.52	302.12	249.79
69	25.87	32.99	37.74	45.46	53.54	62.12	73.64	237.93	306.45	253.29
70	26.00	33.44	38.56	47.16	54.61	62.17	74.27	242.93	310.15	256.41
71	26.06	33.51	39.24	47.25	55.58	63.79	74.42	247.14	311.02	261.47
72	26.80	33.52	40.06	47.26	55.98	65.90	74.94	250.82	311.75	265.21
73	26.97	33.85	40.07	47.96	56.05	65.91	75.08	254.49	315.02	268.96
74	27.95	33.86	40.08	47.97	57.45	66.63	75.24	256.94	330.71	269.82
75	29.26	34.20	40.09	48.81	57.99	67.31	75.26	259.85	331.68	271.75

*Visit [ups.com/holidays](https://www.ups.com/holidays) for time in transit changes effective during the holiday season.

**Zone 44 is metro Alaska and Hawaii, zone 45 is Puerto Rico and zone 46 is remote Alaska and Hawaii.

Notes:

– For additional information, refer to page 26.

– UPS does not accept Hazardous Materials (including but not limited to Ltd Qty and combustibles) in UPS Ground services destined to and from Alaska; Hawaii; Puerto Rico; Avalon, CA; Catalina Island, CA; Beaver Island, MI; Mackinac Island, MI (winter only); the Bass Islands, OH; Kelleys Island, OH; and San Juan Islands, WA.

Domestic UPS® Ground*

Zones	2	3	4	5	6	7	8	44**	45**	46**
76 Lbs.	\$31.22	\$36.10	\$40.34	\$49.56	\$58.73	\$68.41	\$75.31	\$263.06	\$331.81	\$275.00
77	32.45	36.63	41.19	49.78	59.07	69.71	75.36	265.22	332.88	276.59
78	32.48	38.01	42.41	50.31	59.43	70.88	75.41	266.65	333.96	278.60
79	34.26	39.22	43.05	51.10	60.67	71.98	76.52	266.70	343.26	279.38
80	34.87	40.34	43.66	52.32	61.69	72.29	77.10	269.48	346.66	280.82
81	35.71	40.67	44.71	52.67	62.49	73.40	78.08	271.73	347.15	282.26
82	36.87	41.98	46.58	53.67	62.65	75.29	78.09	273.09	351.51	283.56
83	37.24	42.06	46.74	54.03	63.42	75.31	78.10	276.08	355.36	284.65
84	38.71	43.44	48.10	54.55	64.38	76.21	78.70	279.26	359.45	287.84
85	39.38	43.73	48.13	55.42	65.37	77.04	79.56	282.51	363.62	291.07
86	41.21	45.73	50.02	56.47	66.16	78.47	81.23	285.48	367.46	294.07
87	41.66	45.75	50.03	56.48	67.03	78.54	81.36	288.69	371.58	297.25
88	43.80	47.22	52.09	58.30	67.90	79.35	83.03	291.88	375.67	300.47
89	45.33	48.09	52.62	58.49	68.74	80.17	84.76	294.93	379.58	303.51
90	47.65	50.17	54.37	60.21	69.72	81.27	85.63	297.96	383.45	307.70
91	47.66	50.18	54.38	60.30	69.87	81.28	85.64	301.15	385.58	309.66
92	49.18	50.64	54.66	60.31	70.70	81.29	85.83	304.02	388.97	312.55
93	49.82	51.62	56.24	60.87	71.33	81.30	86.71	306.97	389.09	315.53
94	50.07	52.48	56.50	61.67	72.16	81.31	87.61	309.83	398.80	318.42
95	51.24	53.45	56.89	62.50	72.65	81.60	88.55	312.88	402.31	321.45
96	52.88	53.80	58.97	63.80	73.06	82.16	90.25	315.75	404.20	324.28
97	54.10	55.38	59.83	64.12	73.85	82.77	91.19	318.76	404.53	327.28
98	54.82	55.74	59.84	64.88	74.68	82.78	91.23	321.54	404.77	330.14
99	56.02	56.62	62.09	65.69	75.55	83.61	92.12	324.60	405.06	333.15
100	56.50	57.07	62.14	66.75	76.47	84.45	93.03	327.61	421.62	336.17
101	56.99	57.57	62.19	66.76	76.48	84.46	93.08	327.66	425.49	336.22
102	57.03	57.61	62.44	67.03	76.67	84.47	93.13	327.71	429.43	336.32
103	58.41	59.00	63.40	67.42	77.45	85.31	93.53	329.20	433.29	336.37
104	58.76	59.29	63.72	68.13	77.69	85.57	94.08	330.02	437.40	337.54
105	60.29	60.78	65.06	69.54	78.89	86.89	95.81	333.75	441.28	340.47
106	60.70	61.08	65.18	69.55	78.91	86.94	95.82	336.84	445.34	343.56
107	61.60	62.02	66.58	70.93	79.61	87.58	97.49	339.96	449.48	346.66
108	62.48	62.91	66.68	70.96	80.34	88.35	97.50	341.96	453.55	349.43
109	63.14	63.78	67.41	71.66	81.05	89.10	98.35	344.96	457.46	352.45
110	64.77	65.33	68.83	72.35	82.53	90.79	100.16	348.91	461.31	355.55
111	64.87	65.41	70.29	73.75	82.58	91.42	101.36	352.88	466.57	360.41
112	66.20	66.78	70.36	73.76	83.23	91.43	101.37	356.87	471.83	365.31
113	66.26	66.84	71.14	74.44	83.98	92.18	103.21	359.95	475.93	368.39
114	66.96	68.23	72.44	75.89	85.40	93.73	103.89	363.09	480.06	371.53
115	67.70	69.00	72.45	76.09	85.41	93.74	103.90	366.18	484.16	374.64

*Visit [ups.com/holidays](https://www.ups.com/holidays) for time in transit changes effective during the holiday season.

**Zone 44 is metro Alaska and Hawaii, zone 45 is Puerto Rico and zone 46 is remote Alaska and Hawaii.

Notes:

– For additional information, refer to page 26.

– UPS does not accept Hazardous Materials (including but not limited to Ltd Qty and combustibles) in UPS Ground services destined to and from Alaska; Hawaii; Puerto Rico; Avalon, CA; Catalina Island, CA; Beaver Island, MI; Mackinac Island, MI (winter only); the Bass Islands, OH; Kelleys Island, OH; and San Juan Islands, WA.

Domestic UPS® Ground*

Zones	2	3	4	5	6	7	8	44**	45**	46**
116 Lbs.	\$68.40	\$69.23	\$74.04	\$76.44	\$85.97	\$95.82	\$104.54	\$368.46	\$487.17	\$377.62
117	69.08	69.99	74.23	77.85	86.66	95.87	106.22	370.51	491.06	380.55
118	69.81	71.39	74.31	78.08	87.37	95.92	107.16	374.33	494.93	383.50
119	70.77	71.48	75.79	78.52	88.12	96.58	108.45	379.73	502.11	390.89
120	72.47	73.20	76.43	79.80	88.83	97.85	108.92	381.94	506.23	394.04
121	72.51	73.24	76.63	79.81	89.40	97.86	109.06	385.42	509.59	397.40
122	73.16	74.62	77.38	80.52	90.10	99.42	109.96	388.69	513.93	400.68
123	73.94	74.69	79.70	81.95	90.81	100.62	111.60	391.99	518.30	404.00
124	74.49	75.43	79.79	82.00	91.55	100.63	112.23	395.26	522.63	407.32
125	74.69	75.44	79.80	82.66	92.25	100.91	112.50	398.57	526.97	410.65
126	76.16	76.93	82.14	83.21	92.80	102.20	115.11	400.08	530.23	413.93
127	76.76	77.49	82.16	83.92	93.50	102.21	115.12	404.30	534.57	417.24
128	76.77	77.50	82.96	84.65	94.92	104.05	116.84	406.61	538.93	420.54
129	78.45	79.24	83.58	85.17	94.93	104.06	116.85	409.88	543.25	423.89
130	78.48	79.27	84.34	85.83	95.63	105.42	119.55	417.13	547.59	431.29
131	78.95	79.75	85.59	86.62	96.14	105.44	119.56	418.62	553.47	434.69
132	80.47	81.30	85.60	87.32	96.86	105.71	119.85	420.88	557.84	438.04
133	80.62	81.43	85.96	88.02	97.33	106.18	119.98	428.48	562.18	444.79
134	81.23	82.05	86.80	88.56	98.07	106.91	120.11	429.55	566.55	444.85
135	82.83	83.67	87.78	89.51	99.87	108.74	121.82	430.72	570.86	448.06
136	83.37	84.67	89.16	90.06	99.92	108.79	121.86	433.99	575.21	451.39
137	83.98	84.68	90.66	91.58	100.23	109.17	122.67	437.30	579.60	454.78
138	84.74	86.01	91.79	92.32	102.25	111.12	124.89	440.57	583.91	458.14
139	85.51	86.88	91.80	92.34	102.31	111.13	124.90	443.85	588.28	461.44
140	86.28	87.13	92.15	93.08	102.84	111.60	125.87	446.95	592.36	464.63
141	87.04	87.70	92.88	93.82	103.40	112.16	125.89	450.25	595.34	467.79
142	88.15	89.32	93.56	95.10	104.17	113.71	127.26	452.36	599.54	471.03
143	88.16	89.33	94.39	95.33	104.96	113.72	127.57	455.42	603.58	474.16
144	89.79	91.88	96.16	97.13	105.76	115.28	128.95	458.54	607.72	477.35
145	90.09	92.79	96.49	97.46	107.33	116.49	130.11	462.90	612.02	480.70
146	90.10	92.84	97.13	97.88	107.35	116.80	130.16	465.08	616.38	484.07
147	91.35	92.89	97.91	98.40	108.11	116.85	130.70	468.33	620.69	487.39
148	92.47	93.51	98.20	99.19	109.97	117.59	133.46	477.30	625.06	495.48
149	92.65	94.33	98.71	99.71	109.98	118.05	133.51	478.32	632.40	498.86
150	92.66	95.21	101.57	103.28	110.53	119.16	134.24	481.64	636.77	507.04
More Than 150 Pounds***										
Price Per Pound	\$0.62	\$0.64	\$0.68	\$0.70	\$0.74	\$0.80	\$0.90	\$3.24	\$4.29	\$3.41

*Visit [ups.com/holidays](https://www.ups.com/holidays) for time in transit changes effective during the holiday season.

**Zone 44 is metro Alaska and Hawaii, zone 45 is Puerto Rico and zone 46 is remote Alaska and Hawaii.

***For each UPS Ground package with a weight of more than 150 pounds, multiply the weight by the price per pound.

Notes:

- For additional information, refer to page 26.
- UPS does not accept Hazardous Materials (including but not limited to Ltd Qty and combustibles) in UPS Ground services destined to and from Alaska; Hawaii; Puerto Rico; Avalon, CA; Catalina Island, CA; Beaver Island, MI; Mackinac Island, MI (winter only); the Bass Islands, OH; Kelleys Island, OH; and San Juan Islands, WA.

Domestic UPS® Simple Rate

Notes:

- Size limits indicated by a box manufacturer may not reflect exterior dimensions of a package and should not be used as a substitute for actual length, width and height measurements in determining cubic inches.
- Packaging must meet all standard UPS packaging guidelines. Refer to page 17 for applicable information on measuring the length, width and height of irregularly shaped packages and items shipped in bags.
- UPS Simple Rate is limited to single-piece, prepaid, small package shipments. UPS Returns® Service options for UPS Simple Rate are limited to UPS Print Return Label Service only.
- UPS Simple Rate is not available for use with UPS Hundredweight Service®, Hazardous Materials shipments, third-party payor or freight collect shipments.
- UPS Express® packaging can be used with UPS Simple Rate for UPS Next Day Air Saver and UPS 2nd Day Air shipments.

Preparing a UPS Simple Rate Shipment

UPS Simple Rate offers flat rate pricing between the U.S. 50 states. The applicable rate is determined by package size and service option. Certain standard surcharges do not apply. Separate UPS Simple Rate pricing applies to shipments originating in or destined to Alaska and Hawaii.

Maximum Weight and Size

The maximum actual weight per UPS Simple Rate package is 50 pounds. The maximum size per UPS Simple Rate package is 1,728 cubic inches.

Service Options

Choose from four service options: UPS Next Day Air Saver®, UPS 2nd Day Air®, UPS 3 Day Select® and UPS® Ground. UPS 3 Day Select and UPS Next Day Air Saver are not available for UPS Simple Rate shipments destined to Alaska and Hawaii.

Determining the UPS Simple Rate Package Size

Follow the steps below to determine the package's UPS Simple Rate size.

1. Package the item in a box or poly mailer.

UPS Simple Rate is designed to be used with the shipper's own box or poly mailer.

2. Measure the package dimensions in inches.

For each dimension, measure at the longest point, rounding each measurement to the nearest whole number (for example, 1.00 to 1.49 will be considered 1, and 1.50 to 1.99 will be considered 2). The minimum measurement for each dimension is 1 inch.

3. Calculate the package size in cubic inches.

Multiply the package length (longest side of the package) by the width by the height. The result is the size in cubic inches.

4. Determine the package's UPS Simple Rate size.

Determine the UPS Simple Rate size, according to the package's size in cubic inches, using the chart below.

Shipping a UPS Simple Rate Package

Prepare and process UPS Simple Rate shipments at ups.com/simplerate or through another UPS automated shipping system, where available. Shippers do not need to open an account or enter into a contract to use UPS Simple Rate.

Pickup and Drop-off Availability

All standard pickup and drop-off options are available for use with UPS Simple Rate shipments. Refer to pages 23-24 for details.

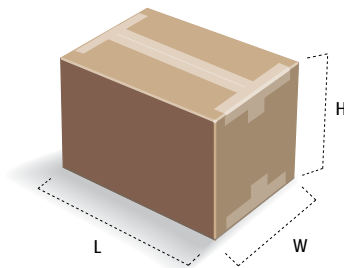

Length (L) x Width (W) x Height (H) = Cubic Inches

Cubic Inches	UPS Simple Rate Size
1-100	Extra Small
101-250	Small
251-650	Medium
651-1,050	Large
1,051-1,728	Extra Large

Domestic

UPS® Simple Rate

To determine the rate for a UPS Simple Rate shipment, refer to the applicable chart below:

UPS Simple Rate for Shipments Between the 48 Contiguous States

UPS Simple Rate Size	UPS® Ground	UPS 3 Day Select®	UPS 2nd Day Air®	UPS Next Day Air Saver®
Extra Small	\$8.80	\$14.65	\$17.70	\$25.75
Small	11.50	17.70	21.10	32.75
Medium	13.90	25.20	27.00	36.80
Large	18.40	33.75	48.15	55.15
Extra Large	22.85	42.40	62.40	71.40

UPS Simple Rate for Shipments from the 48 Contiguous States to Metro Alaska and Hawaii

UPS Simple Rate Size	UPS Ground	UPS 2nd Day Air
Extra Small	\$31.80	\$35.15
Small	34.20	37.70
Medium	42.25	46.10
Large	54.90	59.05
Extra Large	67.70	71.90



UPS Simple Rate for Shipments from the 48 Contiguous States to Remote Alaska and Hawaii

UPS Simple Rate Size	UPS Ground	UPS 2nd Day Air
Extra Small	\$41.70	\$65.35
Small	43.85	70.65
Medium	52.35	79.60
Large	64.10	92.55
Extra Large	77.85	109.85

Common Box Dimensions by UPS Simple Rate Size

UPS Simple Rate Size	Extra Small	Small	Medium	Large	Extra Large
Cubic Inch Range	1-100	101-250	251-650	651-1,050	1,051-1,728
Common Box Dimensions	8 x 6 x 2 6 x 4 x 4 11 x 9 x 1 4 x 4 x 4	8 x 6 x 5 12 x 9 x 2 9 x 7 x 3 6 x 6 x 6	13 x 11 x 2 12 x 9 x 6 13 x 12 x 4 8 x 8 x 8	12 x 12 x 7 15 x 11 x 6 14 x 10 x 7 10 x 10 x 10	16 x 12 x 9 12 x 10 x 9 18 x 12 x 6 12 x 12 x 12

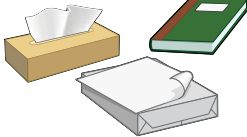
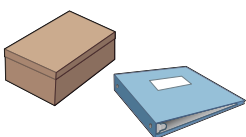
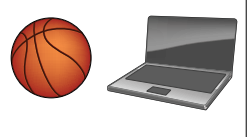
Example Products by UPS Simple Rate Size

Extra Small	Small	Medium	Large	Extra Large
1-100 Cubic Inches	101-250	251-650	651-1,050	1,051-1,728
 <p>Accessories Small Electronics T-shirt / Coffee Mug</p>	 <p>Hardcover Book Tissue Box Ream of Paper</p>	 <p>Shoebox Three-Inch Three-Ring Binder</p>	 <p>Regulation Basketball 14-Inch Laptop</p>	 <p>Small Appliances Tennis Racket</p>

Notes:

- The following surcharges do not apply to UPS Simple Rate shipments: Residential Surcharge, Delivery Area Surcharge, Delivery Area Surcharge Extended and fuel surcharges. Fees for other charges and value-added services set forth on pages 112-125 apply to UPS Simple Rate shipments.
- To determine which ZIP Codes are included in metro Alaska and Hawaii and remote Alaska and Hawaii, enter your origin ZIP Code and download a zone chart at: [ups.com/us/en/shipping/daily-rates.page](https://www.ups.com/us/en/shipping/daily-rates.page).
- The common box dimensions and example products listed below are provided by way of example only. All UPS Simple Rate shipments must conform to the terms, conditions, restrictions and prohibitions applicable to UPS Simple Rate.

Originating Within the U.S. 48 Contiguous States

Air Freight

Weight Breaks (Lbs.)	Destination U.S. 48							Destination			Destination Canada			
								AK/HI Metro	PR	AK/HI Extended				

UPS Next Day Air® Freight												
Guaranteed next-business-day delivery by 12:00 p.m. or 5:00 p.m., depending on destination, to most major metropolitan areas within and between the 48 contiguous states, Puerto Rico and Canada (excluding intra-Canada). For UPS zone information, refer to the 48 Contiguous States Zone Charts at ups.com/rates for UPS Next Day Air® service.											For UPS zone information, refer to pages 33-37 for UPS Worldwide Express® service.	
Zones	102	103	104	105	106	107	108	125			81	82
151-499	\$1.51	\$2.51	\$4.55	\$6.42	\$6.52	\$7.99	\$8.82	For Next Business Day Service to AK/HI Metro, UPS Next Day Air® Freight NGS is available.	\$7.25	For Next Business Day Service to AK/HI Extended, UPS Next Day Air Freight NGS is available.	\$6.22	\$6.60
500-999	1.45	2.40	3.95	6.00	6.11	7.97	8.65		7.22		6.19	6.58
1,000-1,999	1.40	2.28	3.66	5.76	6.01	7.94	8.33		6.77		5.80	6.17
2,000 or More	1.31	2.23	3.30	4.92	5.74	7.61	7.80		6.75		5.78	6.15
Minimum Charge	150.18	249.56	375.57	472.77	502.78	524.37	585.58		1,089.38		624.07	683.59

UPS 2nd Day Air® Freight												
Guaranteed delivery by 12:00 p.m. or 5:00 p.m. on the second business day, depending on destination, to most major metropolitan areas within and between the 48 contiguous states, Puerto Rico and Canada (excluding intra-Canada). For UPS zone information, refer to the 48 Contiguous States Zone Charts at ups.com/rates for UPS 2nd Day Air® service.											For UPS zone information, refer to pages 33-37 for UPS Worldwide Expedited® service.	
Zones	202	203	204	205	206	207	208	225			71	72
151-499	\$1.46	\$2.42	\$3.05	\$3.18	\$4.73	\$6.33	\$7.43	For Second Business Day Service to AK/HI Metro, UPS 2nd Day Air® Freight NGS is available.	\$5.17	For Second Business Day Service to AK/HI Extended, UPS 2nd Day Air Freight NGS is available.	\$4.46	\$4.67
500-999	1.42	2.27	2.86	3.11	4.59	6.11	6.98		5.15		4.44	4.66
1,000-1,999	1.29	2.22	2.73	3.07	4.45	6.04	6.76		4.81		4.12	4.32
2,000 or More	1.24	2.08	2.70	2.76	4.00	5.22	6.00		4.79		4.10	4.31
Minimum Charge	145.43	235.88	292.16	356.92	402.18	481.60	520.78		721.52		482.91	511.07

UPS 3 Day Freight®																		
Guaranteed day-definite delivery within three to four business days by 5:00 p.m. to most major metropolitan areas within and between the 48 contiguous states and Canada. For UPS zone information, refer to the 48 Contiguous States Zone Charts at ups.com/rates for UPS 3 Day Select® service.											For UPS zone information, refer to pages 33-37 for UPS® Standard to Canada.							
Zones	302	303	304	305	306	307	308				51	52	53	54	55	56		
151-499	\$1.23	\$2.13	\$2.61	\$2.85	\$4.06	\$5.09	\$5.89	For Services to AK/HI Metro, UPS Next Day Air Freight NGS and UPS 2nd Day Air Freight NGS are available.				For Services to AK/HI Extended, UPS Next Day Air Freight NGS and UPS 2nd Day Air Freight NGS are available.	\$1.79	\$2.29	\$2.67	\$3.28	\$3.64	\$4.02
500-999	1.11	1.99	2.57	2.77	3.79	4.96	5.78						1.76	2.25	2.63	3.20	3.53	3.92
1,000-1,999	1.08	1.86	2.37	2.69	3.69	4.67	5.68						1.71	2.15	2.55	3.11	3.41	3.78
2,000 or More	0.98	1.82	2.36	2.53	3.50	4.62	5.49						1.65	2.07	2.43	2.98	3.31	3.64
Minimum Charge	127.97	128.96	152.87	162.87	184.48	210.53	237.33						236.53	302.18	355.24	434.09	478.18	530.24

For guarantee details, service availability, delivery time commitments, to request a pickup or to view the "UPS Air Freight Terms and Conditions of Contract for UPS Air Freight Services in the United States, Canada and International," visit [ups-scs.com/terms](https://www.ups-scs.com/terms).

Notes:

- Door-to-door delivery for shipments of more than 150 pounds.
- All of the rates above are per pound and minimum charges are per shipment unless otherwise specified.
- A.M., P.M., B1, B2 and B3 points are defined by the current version of UPS Supply Chain Solutions® Quick Zip program, available at forwarding.ups-scs.com/quickzip. UPS Supply Chain Solutions service points are subject to change without prior notice.

Originating Within the U.S. 48 Contiguous States Air Freight

Weight Breaks (Lbs.)	Destination U.S. 48			Destination			Destination Canada			
				AK/HI Metro	PR	AK/HI Extended				

UPS Next Day Air® Freight NGS												
Delivery the next business day by 12:00 p.m. or 5:00 p.m., depending on destination to most areas within and between all 50 states, Puerto Rico and Canada. For UPS zone information, refer to the 48 Contiguous States Zone Charts at ups.com/rates for UPS Next Day Air® service.											For UPS zone information, refer to pages 33-37 for UPS Worldwide Express® service.	
Zones	102	103	104	105	106	107	108	124	125	126	81	82
151-499	\$1.49	\$2.39	\$4.29	\$6.08	\$6.17	\$7.56	\$8.35	\$9.14	\$6.85	\$9.59	\$5.88	\$6.25
500-999	1.43	2.27	3.74	5.69	5.79	7.55	8.19	8.86	6.81	9.27	5.85	6.22
1,000-1,999	1.37	2.16	3.60	5.66	5.68	7.53	7.88	8.51	6.40	9.21	5.49	5.85
2,000 or More	1.29	2.12	3.24	4.82	5.63	7.19	7.37	8.41	6.35	9.03	5.45	5.82
Minimum Charge	137.26	235.95	355.09	446.98	475.34	495.75	553.63	1,045.41	1,029.94	1,145.28	590.02	646.30

UPS 2nd Day Air® Freight NGS												
Delivery by 12:00 p.m. or 5:00 p.m. on the second business day, depending on destination to major areas within and between the 50 states, Puerto Rico and Canada. For UPS zone information, refer to the 48 Contiguous States Zone Charts at ups.com/rates for UPS 2nd Day Air® service.											For UPS zone information, refer to pages 33-37 for UPS Worldwide Expedited® service.	
Zones	202	203	204	205	206	207	208	224	225	226	71	72
151-499	\$1.35	\$2.24	\$2.83	\$2.96	\$4.42	\$5.93	\$6.96	\$7.91	\$5.13	\$8.49	\$4.20	\$4.40
500-999	1.31	2.11	2.66	2.90	4.29	5.72	6.53	7.83	5.10	8.31	4.17	4.38
1,000-1,999	1.18	2.06	2.54	2.85	4.16	5.65	6.33	7.44	4.75	8.18	3.89	4.07
2,000 or More	1.14	1.91	2.51	2.57	3.74	4.90	5.62	7.12	4.72	8.15	3.85	4.05
Minimum Charge	136.97	222.14	275.15	336.15	378.77	453.57	490.47	908.59	679.55	962.47	454.82	481.33

UPS 3 Day Freight® NGS																	
Day-definite delivery within three to four business days by 5:00 p.m. to most areas within and between the 48 contiguous states and Canada. For UPS zone information, refer to the 48 Contiguous States Zone Charts at ups.com/rates for UPS 3 Day Select® service.											For UPS zone information, refer to pages 33-37 for UPS® Standard to Canada.						
Zones	302	303	304	305	306	307	308					51	52	53	54	55	56
151-499	\$1.15	\$2.00	\$2.46	\$2.68	\$3.84	\$4.80	\$5.55	For Services to AK and HI, UPS Next Day Air Freight NGS and UPS 2nd Day Air Freight NGS are available.				\$1.69	\$2.18	\$2.52	\$3.11	\$3.45	\$3.82
500-999	1.03	1.86	2.41	2.60	3.58	4.69	5.46					1.67	2.15	2.50	3.04	3.35	3.72
1,000-1,999	0.99	1.75	2.22	2.53	3.48	4.40	5.36					1.63	2.03	2.43	2.97	3.24	3.59
2,000 or More	0.94	1.69	2.21	2.39	3.30	4.36	5.17					1.57	1.98	2.31	2.83	3.13	3.45
Minimum Charge	121.21	122.15	144.79	154.27	174.75	199.42	224.79					224.03	286.22	336.48	411.15	452.92	502.24

For service availability, delivery time commitments, to request a pickup or to view the "UPS Air Freight Terms and Conditions of Contract for UPS Air Freight Services in the United States, Canada and International," visit [ups-scs.com/terms](https://www.ups-scs.com/terms).

Notes:

- Door-to-door delivery for shipments of more than 150 pounds.
- All of the rates above are per pound and minimum charges are per shipment unless otherwise specified.
- A.M., P.M., B1, B2 and B3 points are defined by the current version of UPS Supply Chain Solutions® Quick Zip program, available at forwarding.ups-scs.com/quickzip. UPS Supply Chain Solutions service points are subject to change without prior notice.

Export Shipment Pricing

UPS Worldwide Express Plus[®], UPS Worldwide Express[®], UPS Worldwide Express Freight[®] Midday, UPS Worldwide Express Freight[®], UPS Worldwide Saver[®], UPS Worldwide Expedited[®] and UPS[®] Standard

Shipment pricing is advantageous because rates are based on the total weight of a shipment, not the sum of the rates for each package in a shipment.

What Qualifies

1. The shipment consists of multiple packages, using the same service, shipped on the same day to a single consignee.
2. For shipments processed with WorldShip[®] or UPS CampusShip[®] shipping systems, [ups.com](https://www.ups.com) shipping, the UPS[®] Developer Kit or a UPS Ready[®] solution that supports full international service, or a UPS Worldwide Services Waybill. **Note:** For shipments processed with UPS Developer Kit – Shipping API, in order to obtain the best rate, customers are responsible for aggregating shipments for shipment pricing prior to requesting labels (UPS Developer Kit – Shipping API does not run End of Day).

What Does Not Qualify

Shipment pricing does not apply to UPS Express[®] Envelopes, UPS Express[®] Paks, the UPS[®] 10 KG Box, the UPS[®] 25 KG Box or packages recorded in a UPS Shipping Record book; they are each considered separate shipments.

Rates

Rates are based on the total billable weight of all packages in the shipment. Compare each package's actual weight to its dimensional weight. The greater of the two is the billable weight and should be used to calculate the rate. For multiple-package shipments, total the billable weight of all packages in the shipment. Refer to pages 16-17 for instructions on calculating dimensional and billable weight.

If the payer of the shipping charges is located in the origin country, the shipment will be charged the export rate (Origin Country Export Rates). When the payer of the shipping charges is located in the destination country,

the shipment will be charged the import rate (Destination Country Import Rates). If the destination country does not have import rates, the shipment will be charged the export rate (Origin Country Export Rates). When the payer of the shipping charges is located in a third country (neither origin nor destination country), the shipment will be charged the Origin Country Export Rates, except as otherwise agreed to by UPS and the contracting party.

For shipments weighing 150 pounds or less, locate the rate for the total weight of the shipment on the appropriate rate chart.

For shipments weighing more than 150 pounds, multiply the total weight (rounded to the next whole pound) by the appropriate price per pound. The amount billed will be the result of this calculation or the minimum rate shown, whichever is greater.

For a multiple-package UPS Standard shipment, the minimum charge will be based on an average weight of 15 pounds per package.

Customs Brokerage

For UPS Worldwide Express Plus, UPS Worldwide Express, UPS Worldwide

Express Freight Midday, UPS Worldwide Express Freight, UPS Worldwide Saver, UPS Worldwide Expedited and UPS[®] Standard to Mexico, rates include routine, in-house, customs clearance by UPS Supply Chain Solutions. Additional charges will apply if customs clearance is performed by customs brokerage offices other than those designated by UPS for clearing the services listed above.

Customs clearance for the services listed is provided by the UPS Supply Chain Solutions customs brokerage offices designated by UPS for handling package customs clearance. Other UPS Supply Chain Solutions customs brokerage offices charge fees for clearance of packages and freight.

For UPS[®] Standard to Canada, charges for customs clearance are not included in the rate. UPS will provide Customs Brokerage Services, unless otherwise specified by the importer. Customs brokerage charges, duties and taxes will be billed to the importer, unless otherwise indicated by the shipper. Canada brokerage rates are available at [ups.com/ca/en/shipping/zones-and-rates/customs-clearance.page](https://www.ups.com/ca/en/shipping/zones-and-rates/customs-clearance.page).

Useful Information – International Shipping

Import/Export Support Information on international shipping and trade	Visit ups.com/international
Shipping Forms Import/export documents	Visit ups.com/intl_forms
UPS Paperless[®] Invoice Send Commercial Invoices and other customs documents electronically, saving time and paper	Visit ups.com/paperlessinvoice
UPS TradeAbility[®] Services Harmonizer, landed cost and compliance tools	Visit ups.com/tradeability
International Customer Service Assistance with international shipments	Call 1-800-782-7892

Export

UPS Worldwide Express®

UPS Worldwide Express Plus®

Guaranteed delivery by 8:30 a.m., 9:00 a.m. or 11:00 a.m. to major cities in 59 countries and territories. Delivery is guaranteed on the next business day to Canada, on the second business day to Europe and Latin America and on the second or third business day to Asia. Rates include door-to-door delivery with routine, in-house customs clearance by UPS Supply Chain Solutions®. Add \$40.00 to the appropriate UPS Worldwide Express rate for each UPS Worldwide Express Plus shipment.

UPS Worldwide Express

Guaranteed delivery by 10:30 a.m., 12:00 p.m. or 2:00 p.m. to 140 countries and territories. Delivery is guaranteed on the next business day to Canada and for documents to Mexico, the second business day to Europe and Latin America and the second or third business day to Asia. Rates include door-to-door delivery with routine, in-house customs clearance by UPS Supply Chain Solutions.

Zones	81	82	84	901	902	903	904	905	906	907	908	909	911	912	913	920	921
Letter*	\$49.02	\$50.48	\$53.14	\$66.99	\$62.02	\$73.20	\$78.93	\$77.53	\$99.51	\$140.40	\$149.90	\$64.48	\$78.38	\$74.67	\$65.78	\$58.25	\$71.02
Pak 1 Lbs.**	81.32	84.95	72.70	90.77	81.42	102.07	106.28	101.68	116.12	159.83	156.99	85.28	104.33	100.16	87.89	77.23	87.36
Pak 2 Lbs.**	89.28	93.59	76.33	95.93	90.44	104.83	115.71	108.43	155.79	189.64	187.38	93.13	121.47	110.00	97.21	87.59	117.02
10 KG Box†	160.51	180.68	194.97	248.86	250.78	287.58	309.01	307.67	416.60	402.78	417.69	247.20	302.25	290.55	259.94	218.91	318.30
25 KG Box†	252.27	280.82	307.83	372.55	378.38	439.95	520.09	548.05	697.00	773.97	739.42	384.20	472.97	478.39	415.89	372.32	551.22
1 Lbs.	92.97	101.32	93.63	113.82	108.23	135.15	123.08	118.11	146.03	182.02	189.95	104.90	127.92	121.57	109.21	102.81	110.58
2	102.26	111.76	105.60	129.29	116.76	159.46	150.35	137.02	175.63	207.33	209.57	119.26	144.92	139.67	125.66	109.30	134.41
3	114.63	122.03	117.46	150.20	127.95	177.77	172.70	158.97	205.45	249.90	238.32	141.06	161.64	157.31	144.01	121.56	144.60
4	126.49	134.32	132.02	174.52	143.72	202.11	200.45	181.19	242.03	291.73	283.25	164.00	177.70	177.46	167.67	136.53	163.13
5	141.33	161.83	150.47	203.63	162.10	219.02	226.06	215.35	266.26	323.77	317.86	198.97	215.55	215.42	210.99	153.99	182.36
6	146.01	169.49	168.82	216.35	176.01	236.66	247.41	226.79	300.81	343.04	338.11	210.65	236.66	235.44	221.48	167.22	212.35
7	149.05	173.59	179.81	228.81	188.45	259.44	269.30	246.86	334.15	368.92	377.23	223.45	257.58	260.35	233.46	180.77	235.71
8	153.42	176.09	188.96	238.84	199.35	277.64	290.04	274.92	397.79	386.73	403.91	234.29	283.94	275.17	240.38	191.22	257.94
9	154.52	179.88	190.39	239.86	200.38	283.49	294.99	279.23	404.10	393.62	419.40	235.40	292.35	277.70	243.24	194.06	287.93
10	155.58	180.99	193.93	241.37	203.68	286.20	304.87	280.31	405.46	395.28	427.69	236.80	293.73	278.64	244.36	197.26	302.32
11	159.23	183.12	200.09	243.71	213.48	289.25	308.38	291.40	421.29	401.84	428.68	245.17	298.64	286.92	250.20	202.81	318.08
12	161.10	185.09	206.85	251.53	222.38	293.56	314.18	296.48	424.38	414.32	444.51	252.29	308.67	293.00	254.81	211.26	341.00
13	197.32	231.28	244.44	291.88	233.61	340.33	382.61	352.53	514.28	491.39	535.02	308.47	353.72	360.34	303.62	221.93	356.19
14	212.28	243.32	271.21	326.02	244.01	375.85	433.24	382.80	553.04	552.52	594.95	331.98	428.77	401.67	324.48	231.82	370.62
15	220.52	251.51	290.27	337.24	270.83	398.94	462.81	441.36	581.79	598.99	602.48	344.01	439.45	421.39	342.43	257.29	392.02
16	228.72	257.93	291.31	349.78	286.71	413.62	481.48	448.19	650.74	682.65	653.90	357.78	456.63	443.32	359.74	273.71	410.71
17	235.30	265.48	292.41	356.38	288.69	415.27	495.68	449.17	655.97	691.00	697.68	369.81	458.61	454.03	360.67	275.58	426.03
18	239.68	266.58	293.52	357.36	290.48	416.38	497.08	450.15	678.93	711.98	735.10	371.74	459.60	455.15	361.74	277.31	436.25
19	240.72	269.30	294.62	358.34	309.83	417.42	498.15	451.13	688.02	749.65	737.11	372.87	460.58	456.26	362.83	295.78	454.91
20	241.74	270.39	295.72	359.32	321.36	418.48	499.20	452.12	689.39	758.26	740.72	373.98	461.57	457.30	363.94	306.78	469.53
21	242.77	271.48	296.79	360.29	324.99	419.53	500.26	452.20	690.42	759.31	741.71	375.02	462.55	458.38	372.65	310.25	476.55
22	243.80	272.54	297.86	361.27	326.14	420.55	501.32	453.18	691.43	760.34	742.70	376.06	463.54	459.47	381.78	311.35	490.64
23	244.84	273.60	298.93	362.25	331.81	421.58	502.38	454.16	692.46	761.74	750.85	377.10	464.52	460.56	391.72	316.76	501.54
24	247.12	276.05	302.07	367.77	334.30	423.84	504.76	474.29	711.36	762.72	791.15	378.93	474.94	461.55	393.21	319.13	516.50
25	249.37	278.43	306.03	372.03	341.52	435.11	512.83	484.22	720.64	766.81	809.17	386.84	484.80	471.10	397.83	326.03	533.02

*The Letter rate applies only to documents, correspondence and electronic media shipments of no commercial value that do not exceed eight ounces sent in a UPS Express® Envelope.

**UPS Express® Pak rates apply to shipments weighing two pounds or less, with a customs value of less than \$100.00 and UPS Express Pak is selected at the time of shipping.

†Shipments exceeding the maximum weights (10 KG/22 pounds and 25 KG/55 pounds) will be charged the regular UPS Worldwide Express Plus or UPS Worldwide Express rate. Available only when the shipper is paying the shipping charges.

Note: For additional information, refer to page 26.

Export

UPS Worldwide Express®

Zones	81	82	84	901	902	903	904	905	906	907	908	909	911	912	913	920	921
26 Lbs.	\$303.87	\$347.99	\$353.97	\$482.20	\$369.20	\$574.02	\$652.92	\$580.87	\$854.18	\$921.40	\$829.43	\$490.42	\$594.56	\$600.37	\$465.14	\$352.45	\$550.42
27	323.52	363.02	395.89	519.14	376.77	595.96	677.49	622.47	919.52	1,044.10	1,027.86	517.81	657.01	637.29	516.28	359.68	557.72
28	334.71	377.90	415.56	534.06	377.94	598.17	702.56	626.80	926.05	1,091.66	1,053.49	533.00	663.33	648.92	527.90	360.79	571.81
29	340.94	382.38	417.55	544.03	379.12	601.46	722.67	679.49	967.69	1,119.38	1,056.06	534.25	665.33	680.20	528.90	361.92	585.88
30	347.67	385.74	418.65	555.45	387.93	634.62	725.55	696.19	975.30	1,125.16	1,058.52	538.77	667.78	683.92	545.98	370.33	598.81
31	356.00	399.39	419.76	567.21	401.15	641.72	767.75	702.74	977.59	1,126.34	1,062.48	557.07	716.85	706.25	568.69	377.37	614.46
32	363.34	406.05	420.74	570.28	418.78	645.19	790.90	703.72	982.32	1,128.92	1,063.90	588.46	744.21	721.30	580.75	393.96	628.56
33	370.70	414.20	443.90	600.69	427.85	656.19	809.00	719.68	1,055.08	1,146.78	1,120.01	600.00	746.95	724.18	600.02	402.49	642.33
34	378.05	420.87	447.46	608.55	443.56	657.36	826.53	736.62	1,062.38	1,152.92	1,125.62	609.77	750.09	745.86	609.45	417.27	655.83
35	384.27	427.54	448.49	629.39	445.47	676.65	844.63	738.53	1,125.39	1,227.45	1,126.81	611.03	813.23	754.73	610.58	419.07	676.74
36	384.94	430.46	449.66	645.05	483.21	679.30	858.22	739.51	1,165.75	1,234.64	1,150.74	612.20	819.54	804.76	623.65	454.57	683.26
37	397.29	442.23	450.77	647.59	510.14	681.97	890.11	740.50	1,183.46	1,236.14	1,172.94	648.76	820.52	816.27	648.64	479.91	698.24
38	402.41	448.32	451.89	649.28	512.86	703.16	917.46	769.40	1,197.88	1,237.28	1,175.17	660.09	826.05	819.91	660.38	482.46	712.16
39	409.73	454.25	459.69	685.60	523.37	712.23	936.66	783.23	1,198.86	1,238.40	1,185.85	672.47	827.40	854.33	672.43	492.35	725.51
40	417.10	461.83	460.80	699.01	524.53	745.14	938.30	784.64	1,199.85	1,239.56	1,236.16	674.27	828.53	855.67	681.53	493.44	740.30
41	424.47	464.70	465.39	711.03	534.51	748.45	956.35	812.25	1,200.84	1,240.82	1,317.39	694.23	872.00	858.32	683.09	510.26	755.39
42	431.25	474.92	485.37	720.34	536.76	752.56	974.55	828.43	1,218.53	1,242.01	1,338.93	705.19	891.70	897.15	705.30	512.41	769.76
43	436.93	483.72	497.49	734.73	537.92	798.56	992.59	830.26	1,226.72	1,324.55	1,387.73	716.72	929.24	909.56	717.20	513.52	796.67
44	443.17	491.13	501.43	744.47	547.46	842.78	1,011.09	866.80	1,227.71	1,358.05	1,392.62	727.60	941.61	927.90	727.49	522.63	802.64
45	449.95	497.09	504.90	755.90	549.32	864.02	1,029.31	933.87	1,228.69	1,362.20	1,398.95	739.17	943.31	947.11	739.10	524.40	825.28
46	455.05	507.97	523.42	767.75	586.24	871.38	1,052.00	940.57	1,229.68	1,445.29	1,525.47	746.86	977.34	955.59	746.78	559.66	840.56
47	461.83	513.06	532.17	781.12	589.94	878.58	1,065.54	992.09	1,230.68	1,508.73	1,538.19	759.04	980.78	968.85	759.40	563.18	857.92
48	468.03	522.49	539.14	792.79	591.12	905.21	1,083.74	997.25	1,242.90	1,515.10	1,539.47	770.57	981.76	984.50	769.14	564.31	875.32
49	473.14	527.72	541.31	804.07	613.61	907.90	1,101.36	1,013.35	1,246.93	1,585.73	1,540.58	782.75	982.75	985.78	782.56	585.77	892.55
50	479.94	535.37	546.05	805.13	615.89	910.05	1,118.07	1,016.49	1,268.14	1,592.81	1,541.70	793.83	984.94	987.13	793.71	587.95	910.35
52	491.62	545.85	549.08	829.63	658.11	955.22	1,161.88	1,077.51	1,430.94	1,597.97	1,594.11	807.77	1,063.55	995.45	807.76	628.24	919.32
54	499.18	552.53	576.59	847.45	665.77	976.00	1,183.90	1,084.21	1,440.59	1,601.42	1,599.84	821.77	1,109.59	1,046.19	819.30	635.58	949.21
56	509.29	563.12	587.14	873.89	693.06	994.01	1,226.51	1,087.45	1,507.78	1,678.40	1,612.98	847.40	1,124.88	1,083.76	846.18	661.62	977.49
58	519.97	573.57	598.49	900.35	720.34	1,003.87	1,270.03	1,090.67	1,565.69	1,767.37	1,626.10	873.03	1,140.16	1,121.19	874.77	687.66	1,008.80
60	535.94	586.37	601.52	930.05	723.84	1,077.13	1,324.36	1,095.85	1,578.69	1,824.46	1,708.84	906.79	1,262.22	1,207.37	907.20	691.01	1,039.27
62	546.11	597.25	615.02	941.22	765.56	1,093.29	1,367.70	1,141.34	1,581.91	1,831.36	1,712.96	930.55	1,266.19	1,231.08	937.05	730.82	1,070.74
64	556.34	606.11	618.05	982.22	770.13	1,096.69	1,411.67	1,204.69	1,585.15	1,834.81	1,746.66	954.30	1,269.54	1,270.34	957.30	735.19	1,104.86
66	563.71	615.99	628.19	1,007.21	776.07	1,100.11	1,445.82	1,209.29	1,663.04	1,838.24	1,750.24	978.04	1,331.92	1,283.43	976.21	740.86	1,134.53
68	574.87	626.43	656.43	1,033.05	828.58	1,160.03	1,460.92	1,283.09	1,805.67	1,841.27	1,905.57	1,001.77	1,335.35	1,293.89	1,012.65	790.99	1,174.28
70	586.34	638.01	666.18	1,057.57	832.10	1,176.53	1,530.84	1,298.00	1,818.72	1,867.27	1,922.39	1,025.48	1,338.37	1,330.25	1,028.79	794.35	1,205.06

Note: For additional information, refer to page 26.

Export

UPS Worldwide Express®

Zones	81	82	84	901	902	903	904	905	906	907	908	909	911	912	913	920	921
72 Lbs.	\$592.56	\$641.64	\$669.60	\$1,080.17	\$864.07	\$1,227.91	\$1,570.40	\$1,371.97	\$1,821.74	\$1,909.67	\$1,968.87	\$1,032.89	\$1,393.10	\$1,350.73	\$1,037.46	\$824.87	\$1,238.29
74	600.54	657.07	672.63	1,104.36	867.69	1,272.73	1,600.45	1,380.65	1,827.16	1,982.93	2,016.44	1,071.03	1,427.66	1,373.65	1,050.06	828.32	1,272.50
76	616.91	667.38	675.66	1,107.57	931.06	1,284.52	1,607.55	1,478.18	1,957.67	2,047.35	2,019.86	1,094.74	1,467.45	1,420.10	1,098.01	875.88	1,303.85
78	622.56	676.07	692.89	1,138.65	937.71	1,288.82	1,648.69	1,481.42	1,961.08	2,055.96	2,033.01	1,118.48	1,471.49	1,506.58	1,121.97	882.13	1,337.70
80	629.87	684.51	699.28	1,155.29	943.57	1,351.88	1,663.36	1,509.78	1,982.68	2,065.40	2,051.27	1,142.17	1,474.52	1,535.46	1,148.26	887.64	1,361.06
82	636.29	692.92	726.44	1,189.88	947.06	1,355.29	1,666.59	1,513.02	1,985.71	2,068.96	2,089.77	1,145.43	1,478.58	1,549.88	1,151.76	890.93	1,367.20
84	642.04	701.20	733.61	1,215.50	1,011.78	1,358.70	1,747.22	1,516.24	1,988.73	2,105.60	2,092.81	1,148.69	1,557.11	1,552.96	1,169.02	951.81	1,400.74
86	649.24	707.40	737.24	1,234.40	1,018.88	1,361.71	1,777.27	1,544.66	1,991.76	2,124.33	2,217.96	1,203.92	1,562.22	1,556.03	1,203.51	958.49	1,428.72
88	656.43	719.99	740.68	1,258.31	1,022.70	1,401.81	1,807.14	1,547.89	1,994.79	2,174.00	2,299.61	1,206.97	1,656.22	1,559.11	1,223.68	962.08	1,460.61
90	663.64	726.34	758.39	1,267.08	1,037.89	1,459.63	1,836.90	1,632.24	1,997.82	2,177.03	2,363.89	1,238.84	1,673.53	1,562.18	1,243.97	976.37	1,494.27
92	670.80	734.15	767.78	1,284.45	1,059.97	1,468.54	1,867.10	1,655.25	2,000.84	2,191.29	2,370.70	1,257.39	1,676.73	1,565.26	1,264.10	997.15	1,527.27
94	678.00	742.31	770.81	1,311.36	1,076.56	1,566.05	1,889.74	1,725.02	2,003.87	2,324.63	2,374.15	1,279.98	1,759.94	1,568.34	1,278.76	1,012.75	1,557.01
96	683.38	744.58	773.84	1,319.36	1,107.10	1,598.75	1,910.16	1,739.12	2,006.90	2,513.20	2,494.89	1,304.89	1,771.18	1,610.47	1,304.61	1,056.87	1,583.73
98	685.87	747.87	777.19	1,322.43	1,130.29	1,601.76	1,919.40	1,742.13	2,009.93	2,597.66	2,508.92	1,307.94	1,774.20	1,620.18	1,313.63	1,063.31	1,612.03
100	695.73	754.35	780.53	1,325.60	1,182.39	1,605.24	1,922.60	1,836.23	2,150.97	2,678.85	2,890.88	1,311.31	1,777.23	1,623.53	1,325.66	1,128.84	1,617.83
105	727.72	788.81	811.23	1,390.77	1,266.16	1,688.67	2,006.34	1,910.75	2,258.52	2,812.79	3,032.56	1,372.84	1,852.03	1,709.92	1,390.76	1,191.12	1,681.32
110	762.37	826.36	849.67	1,456.99	1,326.44	1,768.15	2,101.89	2,001.73	2,366.07	2,946.73	3,176.83	1,438.20	1,940.24	1,791.36	1,455.86	1,247.83	1,694.85
115	797.03	863.92	887.51	1,523.23	1,386.73	1,848.18	2,197.43	2,092.71	2,473.62	3,080.67	3,318.09	1,503.58	2,028.43	1,872.77	1,520.71	1,304.54	1,748.43
120	831.68	901.49	926.05	1,589.44	1,447.02	1,928.54	2,292.98	2,183.71	2,581.15	3,214.62	3,459.04	1,568.96	2,116.61	1,954.20	1,585.43	1,361.26	1,818.25
125	866.33	939.04	963.67	1,655.68	1,507.31	2,008.13	2,388.51	2,274.70	2,688.71	3,348.56	3,599.77	1,634.31	2,204.81	2,035.62	1,651.29	1,417.97	1,888.53
130	899.71	976.60	1,008.42	1,721.90	1,567.61	2,087.51	2,484.04	2,365.68	2,796.25	3,482.50	3,743.61	1,699.69	2,292.99	2,117.05	1,717.27	1,474.70	1,939.52
135	934.29	1,014.16	1,047.02	1,788.12	1,627.90	2,167.62	2,579.59	2,456.67	2,903.80	3,616.45	3,884.06	1,765.06	2,381.18	2,198.47	1,791.07	1,531.42	1,988.93
140	968.75	1,051.72	1,085.72	1,854.35	1,688.19	2,245.90	2,675.12	2,547.66	3,011.36	3,750.39	4,027.77	1,830.43	2,469.39	2,279.89	1,857.36	1,588.13	2,054.18
145	1,002.55	1,089.28	1,124.46	1,920.58	1,748.48	2,325.00	2,770.67	2,638.64	3,118.89	3,884.32	4,167.79	1,895.81	2,557.57	2,361.31	1,923.66	1,644.85	2,120.12
150	1,036.83	1,126.84	1,163.16	1,986.81	1,808.77	2,415.36	2,866.21	2,729.62	3,226.45	4,018.26	4,311.38	1,961.19	2,645.75	2,442.75	1,989.97	1,701.57	2,185.64

Determining the Rate

Shipments of More Than 150 Pounds (non-pallet)

Zones	81	82	84	901	902	903	904	905	906	907	908	909	911	912	913	920	921
Price Per Pound	\$6.92	\$7.52	\$7.76	\$13.25	\$12.06	\$16.11	\$19.11	\$18.20	\$21.51	\$26.79	\$28.75	\$13.08	\$17.64	\$16.29	\$13.27	\$11.35	\$14.58
Minimum Rate	1,036.83	1,126.84	1,163.16	1,986.81	1,808.77	2,415.36	2,866.21	2,729.62	3,226.45	4,018.26	4,311.38	1,961.19	2,645.75	2,442.75	1,989.97	1,701.57	2,185.64

Note: For additional information, refer to page 26.

Export

UPS Worldwide Express Freight® Midday

Guaranteed delivery by 12:00 p.m. or 2:00 p.m. to 39 countries and territories. Delivery is guaranteed on the next business day to Canada, the second business day to Europe and Latin America and within two to three business days to Asia. Rates include door-to-door and non door-to-door delivery with routine, in-house customs clearance by UPS Supply Chain Solutions® for palletized shipments of more than 150 pounds.

Door-to-Door

Zones	481	482	484	401	402	403	404	405
151-999 Lbs. (Price per Lb.)	\$7.69	\$8.18	\$8.40	\$15.41	\$12.65	\$15.88	\$22.39	\$19.73
1,000 Lbs. or More (Price per Lb.)	7.15	7.65	7.86	14.41	11.71	14.85	20.94	18.44
Minimum Rate	1,161.19	1,235.18	1,268.40	2,326.91	1,910.15	2,397.88	3,380.89	2,979.23

Zones	406	407	408	409	411	412	413	420	421
151-999 Lbs. (Price per Lb.)	\$23.53	\$29.57	\$32.34	\$13.80	\$17.04	\$17.81	\$14.30	\$12.65	\$16.12
1,000 Lbs. or More (Price per Lb.)	21.88	27.35	30.24	12.90	15.84	16.66	13.37	11.71	14.99
Minimum Rate	3,553.03	4,465.07	4,883.34	2,083.80	2,573.04	2,689.31	2,159.30	1,910.15	2,434.12

Non Door-to-Door: Drop-off, Hold at Location,
Drop-off and Hold at Location

Zones	481	482	484	401	402	403	404	405
151-999 Lbs. (Price per Lb.)	\$6.87	\$7.35	\$7.59	\$14.54	\$11.85	\$15.08	\$21.51	\$18.93
1,000 Lbs. or More (Price per Lb.)	6.33	6.82	7.05	13.54	10.91	14.04	20.06	17.64
Minimum Rate	1,037.37	1,109.85	1,146.09	2,195.54	1,789.35	2,277.08	3,248.01	2,858.43

Zones	406	407	408	409	411	412	413	420	421
151-999 Lbs. (Price per Lb.)	\$22.75	\$28.76	\$31.53	\$12.96	\$16.24	\$16.97	\$13.48	\$11.85	\$15.32
1,000 Lbs. or More (Price per Lb.)	21.10	26.54	29.43	12.06	15.04	15.82	12.55	10.91	14.19
Minimum Rate	3,435.25	4,342.76	4,761.03	1,956.96	2,452.24	2,562.47	2,035.48	1,789.35	2,313.32

Notes:

- Door-to-door refers to shipments picked up and delivered to addresses designated by the shipper.
- Drop-off refers to shipments that are dropped off at a UPS Worldwide Express Freight Center and delivered to a designated address.
- Hold at Location refers to shipments picked up at a designated address and held at a UPS Worldwide Express Freight Center for pickup.
- Drop-off and Hold at Location refers to shipments that are dropped off and held at a UPS Worldwide Express Freight Center for pickup.
- For UPS Worldwide Express Freight Midday shipments, additional charges may apply to larger pallets. Pallets exceeding maximum size or weight restrictions (which vary by origin and destination) as set forth at [ups.com/assets/resources/media/wwef_max_dim.pdf](https://www.ups.com/assets/resources/media/wwef_max_dim.pdf) require prior authorization. Refer to page [124](#) for more information.
- For additional information, refer to page [26](#).

Export

UPS Worldwide Express Freight®

Guaranteed delivery by end of day to 76 countries and territories. Delivery is guaranteed on the next business day to Canada, the second business day to Europe and Latin America and within two to three business days to Asia. Rates include door-to-door and non door-to-door delivery with routine, in-house customs clearance by UPS Supply Chain Solutions for palletized shipments of more than 150 pounds.

Door-to-Door

Zones	481	482	484	401	402	403	404	405
151-999 Lbs. (Price per Lb.)	\$6.52	\$6.93	\$7.30	\$12.33	\$11.00	\$13.81	\$17.91	\$17.16
1,000 Lbs. or More (Price per Lb.)	6.06	6.48	6.83	11.53	10.18	12.91	16.75	16.04
Minimum Rate	984.52	1,046.43	1,102.30	1,861.83	1,661.00	2,085.31	2,704.41	2,591.16

Zones	406	407	408	409	411	412	413	420	421
151-999 Lbs. (Price per Lb.)	\$21.01	\$25.71	\$28.12	\$11.50	\$14.82	\$14.84	\$12.12	\$11.00	\$14.02
1,000 Lbs. or More (Price per Lb.)	19.54	23.78	26.29	10.75	13.78	13.88	11.33	10.18	13.04
Minimum Rate	3,172.51	3,882.21	4,246.12	1,736.50	2,237.82	2,240.84	1,830.12	1,661.00	2,117.02

Non Door-to-Door: Drop-off, Hold at Location,
Drop-off and Hold at Location

Zones	481	482	484	401	402	403	404	405
151-999 Lbs. (Price per Lb.)	\$5.82	\$6.23	\$6.60	\$11.63	\$10.30	\$13.11	\$17.21	\$16.46
1,000 Lbs. or More (Price per Lb.)	5.36	5.78	6.13	10.83	9.48	12.21	16.05	15.34
Minimum Rate	878.82	940.73	996.60	1,756.13	1,555.30	1,979.61	2,598.71	2,485.46

Zones	406	407	408	409	411	412	413	420	421
151-999 Lbs. (Price per Lb.)	\$20.31	\$25.01	\$27.42	\$10.80	\$14.12	\$14.14	\$11.42	\$10.30	\$13.32
1,000 Lbs. or More (Price per Lb.)	18.84	23.08	25.59	10.05	13.08	13.18	10.63	9.48	12.34
Minimum Rate	3,066.81	3,776.51	4,140.42	1,630.80	2,132.12	2,135.14	1,724.42	1,555.30	2,011.32

Notes:

- Door-to-door refers to shipments picked up and delivered to addresses designated by the shipper.
- Drop-off refers to shipments that are dropped off at a UPS Worldwide Express Freight Center and delivered to a designated address.
- Hold at Location refers to shipments picked up at a designated address and held at a UPS Worldwide Express Freight Center for pickup.
- Drop-off and Hold at Location refers to shipments that are dropped off and held at a UPS Worldwide Express Freight Center for pickup.
- For UPS Worldwide Express Freight shipments, additional charges may apply to larger pallets. Pallets exceeding maximum size or weight restrictions (which vary by origin and destination) as set forth at [ups.com/media/en/wwef_max_dim.pdf](https://www.ups.com/media/en/wwef_max_dim.pdf) require prior authorization. Refer to page 124 for more information.
- For additional information, refer to page 26.

Export

UPS Worldwide Saver®

Guaranteed delivery by end of business day to more than 220 countries and territories. Delivery is guaranteed on the next business day to Canada and for documents to Mexico, the second business day to Europe and Latin America and within two to three business days to Asia. Rates include door-to-door delivery with routine, in-house customs clearance by UPS Supply Chain Solutions.

Zones	481	482	484	401	402	403	404	405	406	407	408	409	411	412	413	420	421
Letter*	\$48.27	\$49.73	\$51.84	\$66.24	\$59.52	\$72.11	\$77.15	\$76.15	\$97.55	\$138.05	\$146.96	\$63.15	\$77.22	\$73.20	\$62.94	\$56.55	\$68.28
Pak 1 Lbs.**	80.51	83.69	70.92	90.02	78.92	100.56	103.89	99.88	113.84	156.69	153.16	83.52	102.28	98.19	84.10	74.98	84.00
Pak 2 Lbs.**	88.39	92.20	74.46	95.16	87.80	103.28	113.10	106.51	152.73	185.92	183.70	91.21	118.85	107.42	93.02	83.41	112.51
10 KG Box†	154.33	173.73	187.47	239.28	241.13	276.51	297.12	295.83	400.57	387.28	401.62	237.69	290.62	279.37	249.94	210.49	306.05
25 KG Box†	242.56	270.01	295.99	358.22	363.82	423.02	500.08	526.97	670.19	744.20	710.98	369.42	454.77	459.99	399.89	358.00	530.01
1 Lbs.	92.04	99.82	92.70	112.91	105.07	133.15	120.66	116.02	143.73	178.97	186.22	102.84	125.41	119.18	106.54	99.81	104.32
2	101.24	110.10	104.24	127.04	113.35	157.10	147.40	134.59	172.86	203.86	205.46	116.92	142.77	136.57	122.59	107.68	129.24
3	112.91	120.22	115.95	147.25	124.22	175.14	169.31	155.54	202.21	245.72	233.64	137.86	159.25	153.57	140.49	118.01	139.03
4	124.35	132.15	130.32	171.11	139.53	199.12	196.31	177.10	236.30	286.85	277.69	159.82	175.07	172.28	163.58	132.55	156.85
5	138.95	157.58	148.53	199.64	157.37	215.78	221.41	210.51	262.06	318.35	311.62	193.92	209.30	208.96	206.85	149.50	175.34
6	143.54	164.42	164.24	211.32	170.88	233.16	242.31	221.68	296.07	337.30	331.48	206.51	230.69	228.39	217.13	162.34	204.18
7	147.23	168.38	175.36	223.49	182.96	255.60	263.75	241.31	328.88	362.75	369.83	219.06	249.25	252.55	228.88	173.81	226.64
8	151.90	173.48	186.53	233.29	193.54	273.53	284.06	270.05	391.52	380.26	395.99	228.91	274.65	266.93	235.66	183.86	248.01
9	152.99	177.22	187.94	234.36	194.54	279.30	289.20	274.29	397.73	389.72	411.17	229.92	288.02	269.39	238.47	184.81	276.85
10	154.03	178.31	191.44	238.32	197.74	281.97	298.89	275.35	399.07	391.36	419.30	232.15	289.38	271.76	239.56	187.86	290.69
11	157.65	181.66	197.52	241.77	207.26	284.97	302.33	286.24	414.65	397.86	420.27	240.36	292.78	281.29	244.09	196.90	305.84
12	159.50	183.62	204.19	249.53	215.90	289.22	308.01	292.96	417.69	410.21	435.79	247.34	302.61	286.97	248.59	205.10	327.88
13	195.36	227.86	241.30	284.81	226.80	335.30	375.10	346.29	506.18	476.66	524.52	298.07	346.78	349.55	296.21	215.46	342.49
14	210.17	239.72	267.72	323.43	236.90	370.29	424.74	376.03	544.33	543.28	583.28	324.51	422.43	392.25	316.56	225.06	356.36
15	218.33	247.79	286.54	334.56	262.94	393.04	453.73	433.55	572.62	588.97	590.66	336.27	430.83	411.51	334.07	249.79	376.94
16	226.45	255.88	288.42	346.31	279.71	409.52	472.03	442.87	640.49	671.23	641.07	349.73	447.67	432.92	349.94	265.73	394.91
17	232.97	263.37	289.51	353.55	281.64	411.15	485.96	443.84	645.63	679.44	684.00	361.49	451.83	444.69	351.87	267.55	409.64
18	237.77	264.46	290.61	354.52	283.39	412.25	487.33	444.81	668.23	700.07	720.68	364.45	452.80	445.78	352.91	269.23	419.47
19	238.80	267.16	291.70	355.49	302.27	413.28	488.38	445.78	677.18	737.11	722.65	365.55	453.77	446.87	353.98	287.16	437.41
20	239.82	268.24	292.79	356.46	313.52	414.33	489.41	446.75	678.53	745.58	726.19	366.64	454.74	447.89	355.06	297.84	451.47
21	240.84	269.32	293.85	357.43	317.06	415.37	490.45	447.72	679.54	746.61	727.16	367.66	455.71	448.95	363.56	301.21	458.22
22	241.86	270.37	294.91	358.40	318.18	416.38	491.49	448.69	680.54	747.63	728.13	368.68	456.68	450.01	372.46	302.28	471.76
23	242.89	271.42	295.97	359.37	323.71	417.40	492.52	449.66	681.55	749.00	736.12	369.70	457.65	451.08	382.16	307.53	482.25
24	245.15	273.85	299.07	364.85	326.14	419.64	494.86	469.59	700.15	749.97	783.31	371.50	467.92	452.05	383.61	309.83	496.63
25	247.39	276.22	303.00	368.34	333.19	430.80	502.77	478.47	709.29	753.99	801.15	379.25	475.29	461.41	388.12	316.53	512.51

*The Letter rate applies only to documents, correspondence and electronic media shipments of no commercial value that do not exceed eight ounces sent in a UPS Express® Envelope.

**UPS Express® Pak rates apply to shipments weighing two pounds or less, with a customs value of less than \$100.00 and UPS Express Pak is selected at the time of shipping.

†Shipments exceeding the maximum weights (10 KG/22 pounds and 25 KG/55 pounds) will be charged the regular UPS Worldwide Saver rate. Available only when the shipper is paying the shipping charges.

Note: For additional information, refer to page 26.

Export

UPS Worldwide Saver®

Zones	481	482	484	401	402	403	404	405	406	407	408	409	411	412	413	420	421
26 Lbs.	\$301.11	\$343.52	\$350.46	\$478.37	\$360.19	\$568.33	\$640.74	\$573.98	\$840.72	\$905.99	\$821.21	\$479.39	\$585.77	\$581.75	\$453.79	\$342.18	\$529.25
27	320.64	355.29	391.97	514.00	367.58	590.05	664.85	615.08	905.03	1,026.64	1,007.70	506.16	647.30	617.52	502.21	349.20	536.26
28	331.84	373.05	411.44	528.77	368.72	592.24	689.46	619.36	911.46	1,073.41	1,032.83	521.01	653.52	628.79	513.52	350.28	549.81
29	338.04	377.47	413.41	538.64	369.87	595.50	709.19	671.43	952.45	1,100.66	1,035.35	522.23	655.49	659.10	514.49	351.37	563.34
30	344.66	382.67	414.50	549.95	378.46	628.33	712.02	687.93	959.94	1,106.35	1,037.76	526.65	657.91	662.71	531.10	359.54	575.77
31	352.86	394.26	415.60	561.59	391.36	635.36	753.43	694.40	962.19	1,107.51	1,041.64	544.54	706.25	684.35	553.20	371.79	590.82
32	360.21	400.83	416.57	564.63	408.56	638.80	776.15	695.37	966.85	1,110.04	1,043.03	575.22	733.21	698.93	564.93	388.13	604.38
33	367.54	408.88	439.50	594.74	417.41	649.69	793.91	711.14	1,038.46	1,135.42	1,098.04	586.51	735.91	701.72	583.67	396.54	617.62
34	374.86	415.46	443.02	602.52	432.74	650.85	811.11	727.88	1,045.64	1,141.50	1,103.54	596.06	739.00	722.73	592.85	411.10	630.60
35	380.91	422.05	444.04	623.15	434.60	669.95	828.88	729.77	1,107.66	1,206.93	1,104.71	597.29	801.21	731.32	593.94	412.87	650.71
36	381.88	427.04	445.20	638.66	471.42	672.57	842.21	730.74	1,147.39	1,214.00	1,128.17	598.43	807.42	779.80	606.66	447.85	656.98
37	393.72	436.55	446.30	641.17	497.69	675.21	873.51	731.71	1,164.82	1,215.47	1,149.94	634.17	808.39	790.95	630.97	472.81	671.38
38	399.02	442.56	447.41	642.85	500.35	696.19	900.35	760.27	1,179.01	1,216.59	1,152.12	645.24	813.84	794.48	642.39	475.33	684.76
39	406.07	448.42	455.13	672.15	510.60	705.17	919.19	773.94	1,179.98	1,217.69	1,162.59	657.35	815.17	827.83	654.11	485.07	697.60
40	413.42	455.90	456.23	685.30	511.73	737.76	920.80	775.33	1,180.95	1,218.83	1,211.92	661.04	816.28	829.13	662.96	486.14	711.82
41	420.75	458.73	460.78	697.08	521.47	741.03	938.51	802.61	1,181.92	1,220.07	1,291.55	678.62	859.11	831.70	664.48	495.39	726.33
42	427.51	468.82	480.56	706.21	523.66	745.10	956.37	818.60	1,199.34	1,221.24	1,312.67	689.33	878.52	869.33	686.08	497.48	740.15
43	432.98	477.51	489.17	720.32	524.80	790.65	974.08	820.41	1,207.40	1,302.40	1,360.51	700.60	915.50	881.35	697.66	498.56	766.02
44	439.31	484.82	493.04	729.87	534.10	834.43	992.23	856.52	1,208.37	1,335.34	1,365.31	711.24	927.69	899.12	707.67	507.40	771.76
45	445.94	490.71	499.90	741.07	535.92	855.46	1,010.11	922.79	1,209.34	1,339.42	1,371.51	722.55	929.36	917.74	718.96	509.12	793.53
46	451.11	501.45	514.67	752.69	571.94	862.75	1,032.38	929.41	1,210.31	1,421.13	1,495.55	730.06	962.89	925.95	726.43	543.35	808.23
47	457.72	506.47	523.27	765.80	575.55	869.88	1,045.67	980.32	1,211.29	1,483.51	1,508.02	741.97	966.28	938.80	738.71	546.77	824.92
48	463.91	515.78	530.12	777.24	576.70	896.24	1,063.53	985.42	1,223.32	1,489.77	1,509.28	753.24	967.25	953.97	748.19	547.87	841.65
49	469.08	520.94	535.95	788.30	598.64	898.91	1,080.82	1,001.33	1,233.36	1,559.22	1,510.37	765.15	968.22	955.21	761.24	568.70	858.22
50	475.85	528.49	536.92	789.34	600.86	901.03	1,097.22	1,004.43	1,254.34	1,566.18	1,511.47	775.98	970.38	956.52	772.09	570.82	875.33
52	487.71	538.84	539.90	821.41	642.05	945.76	1,140.21	1,066.84	1,415.37	1,571.25	1,562.85	789.60	1,047.83	964.58	785.75	609.94	883.96
54	495.21	545.43	566.95	839.05	649.53	966.33	1,161.82	1,073.47	1,424.91	1,574.65	1,568.47	803.29	1,093.19	1,013.75	796.98	617.06	912.70
56	505.24	555.89	577.32	865.23	676.15	984.16	1,203.64	1,076.68	1,491.37	1,650.34	1,581.35	828.34	1,108.25	1,050.15	823.13	642.34	939.89
58	515.84	566.20	588.48	891.43	702.77	993.93	1,246.34	1,079.87	1,533.88	1,737.82	1,594.21	853.40	1,123.31	1,086.42	850.94	667.63	970.00
60	531.22	578.84	591.46	920.84	706.18	1,066.46	1,299.66	1,085.00	1,561.51	1,793.96	1,675.33	886.40	1,243.56	1,169.93	882.49	670.88	999.29
62	541.28	589.58	608.93	931.90	746.88	1,082.46	1,342.19	1,130.03	1,564.69	1,800.74	1,679.37	909.62	1,247.47	1,192.90	918.67	709.53	1,029.55
64	551.36	598.33	611.93	972.49	751.34	1,085.83	1,385.34	1,192.76	1,567.90	1,804.13	1,712.41	932.84	1,250.77	1,230.94	938.52	713.77	1,062.36
66	558.69	608.08	621.97	997.23	757.14	1,089.21	1,418.86	1,197.31	1,644.94	1,807.51	1,715.92	956.05	1,312.23	1,243.63	957.06	719.28	1,090.89
68	570.30	618.39	645.45	1,022.82	808.37	1,148.54	1,429.89	1,270.38	1,777.23	1,810.49	1,868.20	979.24	1,315.61	1,253.76	985.06	767.95	1,129.11
70	581.29	629.82	655.04	1,047.09	811.80	1,164.88	1,502.29	1,285.14	1,790.07	1,836.05	1,884.69	1,002.42	1,318.59	1,289.00	1,008.61	771.21	1,158.71

Note: For additional information, refer to page 26.

Export

UPS Worldwide Saver®

Zones	481	482	484	401	402	403	404	405	406	407	408	409	411	412	413	420	421
72 Lbs.	\$587.19	\$633.40	\$658.40	\$1,069.47	\$842.99	\$1,215.75	\$1,541.11	\$1,358.38	\$1,793.05	\$1,877.74	\$1,930.26	\$1,009.66	\$1,372.51	\$1,308.84	\$1,017.11	\$800.84	\$1,190.66
74	595.16	648.63	661.38	1,093.42	846.52	1,260.12	1,570.60	1,366.98	1,798.38	1,949.78	1,976.90	1,046.95	1,406.56	1,341.45	1,029.47	804.19	1,223.55
76	611.35	658.81	664.36	1,096.60	908.35	1,271.80	1,577.57	1,463.54	1,926.84	2,013.12	1,980.25	1,070.12	1,445.76	1,376.06	1,076.48	862.93	1,253.70
78	616.96	667.39	686.02	1,127.37	914.83	1,276.05	1,617.94	1,466.75	1,930.19	2,021.59	1,993.14	1,093.33	1,449.74	1,459.86	1,099.97	869.09	1,286.25
80	624.15	675.72	692.35	1,146.12	920.55	1,338.49	1,632.34	1,494.83	1,951.45	2,030.87	2,011.04	1,116.49	1,452.72	1,487.84	1,125.74	874.52	1,308.71
82	630.62	684.02	714.29	1,178.09	923.96	1,341.87	1,635.51	1,498.03	1,954.43	2,034.37	2,048.79	1,119.67	1,456.72	1,501.82	1,129.17	877.76	1,314.61
84	636.38	692.20	721.34	1,203.46	987.10	1,345.24	1,714.64	1,501.22	1,957.41	2,070.40	2,051.77	1,122.86	1,534.09	1,504.80	1,137.17	937.74	1,346.86
86	643.42	698.32	724.91	1,222.17	994.02	1,348.22	1,744.13	1,529.36	1,960.39	2,088.82	2,174.47	1,176.85	1,539.13	1,507.78	1,179.91	944.32	1,373.76
88	650.61	710.75	728.29	1,245.85	997.75	1,387.93	1,773.44	1,532.56	1,963.37	2,137.65	2,254.51	1,179.83	1,631.74	1,510.76	1,199.68	947.86	1,404.43
90	657.81	717.01	745.71	1,254.53	1,012.57	1,445.17	1,802.64	1,616.07	1,966.35	2,140.63	2,317.53	1,210.98	1,648.79	1,513.74	1,219.57	961.94	1,436.79
92	664.72	724.72	754.94	1,271.73	1,034.11	1,454.00	1,832.28	1,619.05	1,969.33	2,154.66	2,324.21	1,229.12	1,651.95	1,516.72	1,239.31	982.41	1,468.52
94	671.91	732.78	757.92	1,298.37	1,050.30	1,550.54	1,854.50	1,707.94	1,972.31	2,285.77	2,327.59	1,251.20	1,733.93	1,519.70	1,253.68	997.78	1,497.12
96	677.31	738.67	760.90	1,308.88	1,080.09	1,582.92	1,874.54	1,721.90	1,975.29	2,471.18	2,445.97	1,275.55	1,745.00	1,577.34	1,279.02	1,026.08	1,522.81
98	680.42	741.93	764.19	1,311.93	1,102.72	1,585.90	1,883.61	1,724.88	1,978.27	2,554.23	2,459.72	1,278.53	1,747.98	1,586.85	1,287.87	1,047.59	1,550.02
100	690.20	748.36	767.48	1,315.07	1,170.68	1,589.34	1,886.75	1,818.04	2,117.09	2,634.07	2,862.25	1,281.82	1,750.96	1,590.13	1,299.66	1,112.15	1,555.60
105	721.94	782.54	803.19	1,377.00	1,235.27	1,671.95	1,968.93	1,891.83	2,222.95	2,765.77	3,002.53	1,345.92	1,824.66	1,674.75	1,363.49	1,173.51	1,616.65
110	756.31	819.80	841.25	1,442.56	1,294.08	1,750.64	2,062.69	1,981.91	2,328.80	2,897.47	3,145.37	1,410.00	1,911.56	1,754.51	1,427.31	1,229.38	1,629.66
115	790.70	857.06	878.72	1,508.14	1,352.90	1,829.88	2,156.45	2,071.99	2,434.66	3,029.17	3,285.23	1,474.09	1,998.45	1,834.25	1,490.89	1,285.26	1,681.18
120	825.07	894.33	916.88	1,573.70	1,411.72	1,909.44	2,250.22	2,162.08	2,540.50	3,160.88	3,424.79	1,538.19	2,085.33	1,914.00	1,554.34	1,341.14	1,748.31
125	859.45	931.58	954.12	1,639.28	1,470.54	1,988.24	2,343.97	2,252.17	2,646.36	3,292.58	3,564.12	1,602.26	2,172.22	1,993.75	1,618.91	1,397.01	1,815.89
130	892.56	968.84	991.56	1,704.85	1,529.37	2,066.84	2,437.72	2,342.25	2,752.21	3,424.28	3,706.54	1,666.36	2,259.10	2,073.50	1,683.59	1,452.90	1,864.92
135	926.87	1,006.11	1,029.51	1,770.41	1,588.19	2,146.15	2,531.49	2,432.34	2,858.07	3,555.99	3,845.60	1,730.45	2,345.99	2,153.25	1,755.95	1,508.78	1,912.43
140	961.06	1,043.37	1,067.57	1,835.99	1,647.01	2,223.66	2,625.24	2,522.43	2,963.93	3,687.69	3,987.89	1,794.53	2,432.89	2,232.99	1,820.94	1,564.66	1,975.17
145	994.59	1,080.63	1,105.66	1,901.56	1,705.83	2,301.98	2,719.00	2,612.51	3,069.77	3,819.39	4,126.52	1,858.63	2,519.77	2,312.74	1,885.94	1,620.54	2,038.57
150	1,028.60	1,117.89	1,143.71	1,967.13	1,764.65	2,391.44	2,812.76	2,702.59	3,175.63	3,951.09	4,268.69	1,922.73	2,606.65	2,392.50	1,950.95	1,676.42	2,101.57

Shipments of More Than 150 Pounds

Zones	481	482	484	401	402	403	404	405	406	407	408	409	411	412	413	420	421
Price Per Pound	\$6.86	\$7.46	\$7.63	\$13.12	\$11.77	\$15.95	\$18.76	\$18.02	\$21.18	\$26.35	\$28.46	\$12.82	\$17.38	\$15.95	\$13.01	\$11.18	\$14.02
Minimum Rate	1,028.60	1,117.89	1,143.71	1,967.13	1,764.65	2,391.44	2,812.76	2,702.59	3,175.63	3,951.09	4,268.69	1,922.73	2,606.65	2,392.50	1,950.95	1,676.42	2,101.57

Note: For additional information, refer to page [26](#).

Export

UPS Worldwide Expedited[®]

Guaranteed delivery by end of business day to more than 220 countries and territories. Delivery is guaranteed in two business days to Canada, three business days to Mexico, three to four business days to Europe and four to five business days to Asia and Latin America. Rates include door-to-door delivery with routine, in-house customs clearance by UPS Supply Chain Solutions.

Zones	71	72	74	601/631	602/632	603/633	604/634	605/635	606/636	607/637	608/638	609/639	611/641	612/642	613/643	620	621
1 Lbs.	\$86.91	\$93.49	\$82.27	\$103.96	\$89.08	\$117.04	\$114.42	\$109.05	\$135.65	\$126.30	\$114.42	\$96.60	\$113.55	\$111.22	\$97.22	\$85.58	\$94.49
2	93.46	102.72	91.52	121.44	102.35	136.74	140.68	127.48	162.18	158.09	148.08	109.79	126.54	129.22	115.23	98.85	116.39
3	100.65	112.04	104.70	142.02	114.27	153.80	158.95	144.51	183.09	189.32	167.73	131.41	149.95	146.09	131.34	110.77	130.06
4	107.37	122.04	110.44	160.51	126.08	169.65	175.20	163.59	213.72	236.00	214.35	147.62	158.87	160.78	148.22	122.58	145.61
5	122.43	141.24	128.31	190.32	137.74	201.16	200.36	188.61	235.01	266.10	242.79	177.73	179.79	181.29	174.65	134.24	157.52
6	126.81	144.80	134.78	202.73	153.86	213.78	217.26	206.34	274.84	299.24	281.92	191.69	197.74	197.51	188.44	150.36	188.79
7	131.77	150.39	150.11	213.43	164.73	229.95	239.02	224.48	297.26	332.20	295.22	196.06	218.73	221.32	192.29	161.23	196.37
8	137.83	155.47	162.47	218.59	168.99	250.37	255.85	241.76	338.34	341.79	329.86	204.16	239.55	229.79	197.59	165.49	224.69
9	139.10	163.06	163.24	225.95	177.06	256.74	273.48	255.26	365.41	376.27	378.76	207.58	258.25	242.44	222.63	173.56	239.31
10	143.33	165.79	166.30	228.05	180.46	260.42	274.34	256.03	370.66	377.04	379.82	220.88	266.83	260.00	224.70	176.96	254.48
11	146.66	168.15	185.30	230.38	187.22	262.72	277.83	259.89	385.48	377.81	390.36	224.72	274.61	263.97	227.97	183.72	259.07
12	148.20	170.98	186.07	232.41	192.63	266.31	283.16	262.35	392.45	382.77	394.41	225.49	281.11	264.74	231.97	189.13	273.27
13	159.70	196.08	196.55	261.64	203.88	300.44	352.37	306.79	457.28	417.57	429.72	250.78	298.31	315.12	273.92	200.38	297.88
14	165.16	202.19	197.39	280.73	210.77	330.45	375.13	334.98	488.22	479.16	509.45	252.97	343.45	326.58	277.55	207.27	311.64
15	170.60	212.82	203.48	286.40	225.16	335.40	391.10	355.43	500.15	541.06	510.22	269.58	391.55	334.05	281.30	221.66	313.90
16	178.58	217.61	206.01	312.81	236.03	350.91	415.80	385.03	520.32	556.88	510.99	287.71	400.98	360.10	284.98	232.53	334.04
17	179.97	218.48	216.46	314.25	241.82	358.47	426.42	390.21	544.94	569.66	511.76	302.17	407.35	374.90	291.73	238.32	355.78
18	184.71	223.59	221.16	319.06	251.57	364.62	429.80	401.09	581.42	593.14	560.95	304.15	420.93	380.41	315.84	248.07	366.76
19	189.40	229.10	242.12	320.18	259.96	381.12	453.74	423.43	602.65	620.79	572.15	320.21	428.08	392.83	329.02	256.46	378.47
20	194.12	234.57	249.43	325.48	268.40	383.17	455.72	424.82	604.63	656.24	606.07	331.45	428.86	421.17	329.29	264.90	390.84
21	214.48	254.21	250.20	339.99	278.16	386.94	463.44	426.49	629.54	697.11	681.97	340.26	429.64	423.23	329.31	274.66	403.41
22	219.56	254.98	251.38	340.76	286.74	387.71	464.31	427.26	641.71	700.76	690.57	341.03	430.42	425.13	349.00	283.24	414.94
23	224.03	256.32	257.44	341.53	292.41	388.51	466.44	428.03	642.48	715.88	698.74	341.80	431.19	426.06	355.57	288.91	419.40
24	232.70	257.15	265.82	346.90	295.36	394.94	469.38	430.25	648.07	716.65	699.51	342.57	438.10	429.04	358.04	291.86	426.58
25	233.47	261.68	266.62	349.22	299.05	405.13	473.48	434.89	651.81	723.56	721.81	349.32	442.30	433.30	359.31	295.55	444.17
26	257.06	288.41	277.14	448.24	318.81	518.32	582.78	521.64	713.45	797.52	747.83	429.18	550.65	523.16	408.66	315.31	461.26
27	262.16	313.86	277.99	459.78	332.17	540.27	611.61	531.91	732.26	812.54	822.36	457.22	595.26	553.11	416.87	328.67	461.40
28	271.97	316.19	285.60	471.70	333.04	551.20	636.85	583.63	744.36	857.94	823.13	457.99	616.53	556.65	418.86	329.54	478.09
29	276.10	317.17	293.50	481.73	337.10	565.58	667.78	604.29	782.91	916.86	841.03	464.63	619.05	620.88	447.70	333.60	494.63
30	276.97	329.12	303.41	482.60	342.42	578.78	673.36	605.94	789.09	921.35	841.95	465.40	619.88	621.94	475.67	338.92	506.66
31	282.43	330.34	307.28	492.84	353.79	597.27	706.73	621.03	839.75	922.22	857.42	472.44	633.71	634.61	485.19	350.29	522.34
32	288.54	343.53	308.05	493.61	367.00	598.14	709.23	627.09	856.80	923.10	858.26	489.45	636.69	635.49	511.39	363.50	536.69
33	294.64	349.71	308.82	494.38	373.91	605.67	721.69	634.58	864.17	942.91	859.09	491.03	671.13	654.79	519.77	370.41	543.36
34	300.75	350.60	311.76	495.70	379.83	607.43	735.46	636.15	865.79	955.95	859.92	534.02	694.93	656.72	520.24	376.33	550.48
35	306.89	356.04	312.60	496.59	386.72	614.50	755.20	637.20	868.03	959.17	860.74	543.94	708.09	658.97	523.21	383.22	564.76

Note: For additional information, refer to page 26.

Export

UPS Worldwide Expedited[®]

Zones	71	72	74	601/631	602/632	603/633	604/634	605/635	606/636	607/637	608/638	609/639	611/641	612/642	613/643	620	621
36 Lbs.	\$312.98	\$362.34	\$314.29	\$497.44	\$392.71	\$626.91	\$777.27	\$638.05	\$869.07	\$973.04	\$861.57	\$544.90	\$720.36	\$703.64	\$558.04	\$389.21	\$568.48
37	319.03	369.22	320.14	498.32	398.65	630.82	779.48	638.87	876.38	1,002.66	862.38	553.92	721.46	739.88	560.15	395.15	582.24
38	325.16	376.08	320.98	510.54	405.48	645.77	805.22	650.24	932.35	1,028.02	920.58	577.43	728.41	753.80	580.43	401.98	596.87
39	331.28	382.93	323.99	544.05	412.72	657.90	827.80	696.98	952.18	1,028.79	927.01	579.75	729.44	756.78	584.61	409.22	606.17
40	337.42	393.31	324.83	546.38	419.92	688.95	830.83	735.56	960.95	1,060.78	928.81	580.63	732.15	759.26	586.11	416.42	611.29
41	343.54	394.37	325.67	557.16	425.48	691.00	851.90	742.64	961.87	1,076.19	941.08	595.59	770.75	779.90	600.68	419.10	620.72
42	349.72	400.06	326.64	558.77	429.75	692.73	854.01	751.35	968.30	1,170.20	1,013.05	597.22	785.12	782.00	603.70	423.30	632.30
43	355.87	407.48	329.01	566.95	435.67	732.21	881.79	762.35	975.98	1,200.99	1,088.25	612.26	843.48	784.02	614.64	429.14	645.47
44	362.04	413.17	331.34	590.16	441.15	767.97	893.86	773.27	1,001.04	1,217.32	1,096.24	613.03	844.25	824.07	617.06	434.53	657.01
45	368.24	418.92	344.48	592.48	446.64	769.94	911.23	801.04	1,004.80	1,219.73	1,129.89	613.80	845.02	842.87	639.18	439.94	670.78
46	374.38	424.08	349.29	595.27	453.04	770.83	912.97	810.81	1,006.84	1,221.80	1,157.16	614.57	845.79	844.77	642.77	446.25	683.99
47	384.59	430.35	350.06	596.14	467.74	789.07	913.86	811.65	1,020.64	1,272.61	1,159.14	618.43	879.61	845.85	650.24	460.72	697.84
48	385.62	440.23	350.83	596.91	471.33	802.83	925.44	817.96	1,073.56	1,329.91	1,161.22	619.20	882.31	853.50	653.95	464.26	712.32
49	390.13	441.26	353.22	600.15	472.15	803.71	953.58	853.64	1,106.23	1,340.60	1,202.76	645.68	908.57	854.39	656.19	465.07	726.01
50	395.21	446.96	354.06	608.99	475.95	805.15	956.40	857.65	1,107.23	1,346.40	1,206.92	649.63	909.34	855.27	657.11	468.81	740.77
52	413.00	462.97	361.20	617.80	493.83	820.64	980.20	885.56	1,146.72	1,349.30	1,285.13	660.73	910.63	868.72	682.00	486.43	756.06
54	416.82	468.60	364.33	638.23	499.87	833.09	1,000.55	886.85	1,161.09	1,406.16	1,286.42	662.02	950.81	870.01	690.46	492.38	783.38
56	426.46	479.14	376.76	654.60	511.38	842.99	1,026.46	968.51	1,162.47	1,413.75	1,287.71	700.09	952.24	875.76	706.97	503.71	811.63
58	436.11	489.67	379.50	679.83	522.47	853.55	1,052.43	982.91	1,163.84	1,415.24	1,289.00	716.85	960.01	878.26	725.29	514.64	840.07
60	445.91	513.31	380.91	702.05	532.13	864.50	1,054.59	995.03	1,165.22	1,416.72	1,290.29	728.30	980.55	891.28	749.88	524.15	868.47
62	456.02	522.70	392.70	703.50	543.58	884.42	1,073.05	1,007.73	1,174.43	1,418.17	1,291.58	746.15	981.84	893.00	770.18	535.43	897.05
64	474.98	528.10	396.75	704.97	560.96	891.07	1,080.33	1,009.07	1,175.81	1,487.05	1,311.28	747.44	1,023.25	897.20	776.47	552.55	924.69
66	480.76	533.25	403.53	708.26	567.18	972.49	1,087.84	1,010.36	1,177.19	1,497.12	1,312.57	778.53	1,037.38	901.44	793.20	558.67	952.29
68	486.27	542.95	410.33	733.52	578.57	973.98	1,095.32	1,011.65	1,197.55	1,498.50	1,343.67	779.82	1,047.66	905.69	804.99	569.89	980.74
70	487.56	552.94	417.02	753.90	590.14	975.46	1,102.83	1,049.83	1,238.94	1,499.89	1,373.20	785.56	1,050.83	909.93	816.66	581.28	1,008.65
72	501.98	562.79	423.82	782.81	602.35	977.11	1,110.29	1,059.24	1,284.53	1,501.26	1,374.49	798.74	1,153.45	912.29	828.28	593.31	1,036.50
74	523.36	576.54	430.59	784.34	613.13	978.59	1,117.78	1,060.53	1,285.82	1,502.64	1,424.69	816.14	1,154.74	918.40	839.90	603.94	1,064.41
76	529.66	578.48	437.31	785.89	624.59	980.08	1,125.27	1,061.82	1,287.11	1,504.02	1,476.46	868.36	1,161.88	922.70	851.55	615.22	1,092.52
78	533.97	579.82	444.10	787.18	635.15	1,025.52	1,132.74	1,091.69	1,288.40	1,505.39	1,481.85	882.21	1,163.38	923.99	863.15	625.62	1,120.37
80	538.31	581.16	454.59	790.61	644.51	1,026.81	1,140.25	1,093.05	1,382.71	1,511.96	1,483.35	896.07	1,164.88	928.86	874.77	634.84	1,147.56
82	542.63	582.50	463.69	792.73	661.55	1,028.10	1,147.75	1,108.06	1,384.00	1,523.60	1,484.78	898.51	1,168.91	930.15	886.40	651.62	1,169.84
84	546.96	583.84	465.11	794.02	663.24	1,029.39	1,155.24	1,109.35	1,385.29	1,631.73	1,486.07	899.80	1,170.40	931.44	898.02	653.29	1,191.76
86	551.17	585.18	483.47	806.48	672.59	1,030.68	1,162.71	1,123.01	1,386.58	1,633.02	1,490.84	937.65	1,171.91	932.73	909.62	662.50	1,201.68
88	552.46	586.52	494.82	826.70	682.02	1,031.97	1,167.24	1,124.35	1,387.87	1,634.31	1,492.22	943.81	1,231.49	934.02	921.28	671.79	1,231.48
90	553.75	587.86	496.25	836.95	698.59	1,033.26	1,168.53	1,125.99	1,389.16	1,646.96	1,496.15	945.10	1,246.63	935.31	923.98	688.11	1,258.60

Note: For additional information, refer to page 26.

Export

UPS Worldwide Expedited[®]

Zones	71	72	74	601/631	602/632	603/633	604/634	605/635	606/636	607/637	608/638	609/639	611/641	612/642	613/643	620	621
92 Lbs.	\$559.40	\$589.19	\$501.04	\$849.33	\$700.71	\$1,034.55	\$1,169.82	\$1,139.00	\$1,390.45	\$1,658.96	\$1,580.49	\$946.39	\$1,252.86	\$936.60	\$933.10	\$690.20	\$1,285.64
94	562.77	590.53	502.63	862.29	713.69	1,035.84	1,171.11	1,140.29	1,391.74	1,660.37	1,592.70	947.68	1,254.23	937.89	933.90	702.99	1,312.55
96	564.56	591.87	513.51	869.15	719.47	1,037.13	1,172.40	1,141.75	1,393.03	1,661.89	1,595.23	953.96	1,255.54	939.18	938.13	708.68	1,327.19
98	565.97	593.21	530.68	870.51	728.90	1,038.42	1,178.65	1,144.62	1,394.32	1,663.34	1,596.52	955.26	1,256.91	940.47	940.57	717.97	1,329.00
100	567.37	594.55	575.09	876.23	806.33	1,039.71	1,180.03	1,159.57	1,418.06	1,748.74	1,662.47	956.57	1,358.61	941.76	959.58	794.24	1,389.62
105	593.78	608.89	590.67	909.09	829.25	1,080.65	1,238.06	1,217.49	1,531.95	1,818.78	1,738.84	1,047.90	1,413.73	976.75	978.57	814.33	1,436.21
110	622.07	637.89	618.79	952.27	868.74	1,132.11	1,297.01	1,275.29	1,604.90	1,905.38	1,821.64	1,097.81	1,481.05	1,023.26	1,025.28	853.10	1,446.65
115	650.34	666.89	646.91	995.64	908.23	1,183.57	1,355.97	1,323.65	1,677.85	1,991.99	1,904.44	1,147.69	1,548.38	1,069.78	1,073.76	891.88	1,508.07
120	678.62	695.87	675.04	1,038.80	947.71	1,235.03	1,414.92	1,378.78	1,750.80	2,078.59	1,987.24	1,197.60	1,615.69	1,116.28	1,119.25	930.65	1,568.66
125	706.89	724.87	703.17	1,082.17	987.20	1,286.49	1,473.88	1,449.39	1,823.75	2,165.19	2,070.04	1,247.50	1,683.02	1,162.80	1,163.96	969.43	1,617.43
130	735.17	753.87	731.30	1,125.33	1,026.69	1,337.95	1,532.83	1,473.51	1,896.70	2,251.81	2,152.86	1,297.40	1,750.34	1,209.31	1,212.95	1,008.21	1,666.23
135	763.45	782.85	759.42	1,168.71	1,066.18	1,389.41	1,591.79	1,513.95	1,969.65	2,338.42	2,235.66	1,347.29	1,764.24	1,255.83	1,257.69	1,046.99	1,712.08
140	791.72	811.85	787.55	1,211.86	1,105.67	1,440.87	1,650.74	1,559.54	2,042.60	2,425.03	2,318.45	1,397.20	1,820.63	1,302.33	1,303.14	1,085.77	1,770.59
145	820.00	840.85	815.68	1,254.82	1,145.15	1,490.20	1,709.70	1,571.38	2,115.55	2,511.63	2,401.25	1,447.09	1,882.40	1,348.85	1,352.34	1,124.53	1,828.14
150	848.27	869.85	843.80	1,295.94	1,184.65	1,543.77	1,768.64	1,580.99	2,188.50	2,598.23	2,484.05	1,497.00	1,943.96	1,395.36	1,396.70	1,163.32	1,884.89

Shipments of More Than 150 Pounds

Zones	71	72	74	601/631	602/632	603/633	604/634	605/635	606/636	607/637	608/638	609/639	611/641	612/642	613/643	620	621
Price Per Pound	\$5.66	\$5.80	\$5.63	\$8.64	\$7.90	\$10.30	\$11.80	\$10.54	\$14.59	\$17.33	\$16.57	\$9.98	\$12.96	\$9.31	\$9.32	\$7.76	\$12.57
Minimum Rate	848.27	869.85	843.80	1,295.94	1,184.65	1,543.77	1,768.64	1,580.99	2,188.50	2,598.23	2,484.05	1,497.00	1,943.96	1,395.36	1,396.70	1,163.32	1,884.89

Note: For additional information, refer to page 26.

Export

UPS® Standard to Canada*

Guaranteed delivery to all Canadian provinces by end of day within two to seven business days. Rates include door-to-door delivery. Customs clearance is not included. For rates, see [ups.com/cacustomsclearance](https://www.ups.com/cacustomsclearance). UPS will provide Customs Brokerage Services by UPS Supply Chain Solutions unless a different broker is specified. Customs Brokerage charges will be billed to the importer unless otherwise indicated by the shipper.

Zones	51	52	53	54	55	56
1 Lbs.	\$22.58	\$22.85	\$23.14	\$35.84	\$36.34	\$36.77
2	24.42	24.70	25.02	37.69	38.22	38.67
3	25.19	25.47	25.89	39.51	40.07	40.55
4	26.97	27.29	27.64	41.65	42.23	42.73
5	28.60	28.93	29.31	42.24	42.78	43.36
6	30.06	30.41	30.80	44.24	44.86	45.39
7	31.44	31.81	32.21	44.94	45.57	46.11
8	32.88	33.26	33.69	46.55	47.20	47.77
9	34.24	34.64	35.07	47.17	47.83	48.39
10	35.67	36.08	36.54	48.70	49.38	49.97
11	36.27	36.84	37.31	50.58	51.30	51.90
12	37.47	38.10	38.59	51.98	52.70	53.33
13	38.97	39.63	40.13	53.27	54.39	55.05
14	39.54	40.20	40.70	53.90	55.01	55.66
15	40.10	40.77	41.43	54.65	55.56	56.21
16	41.43	42.13	42.83	56.54	57.33	58.28
17	42.53	43.24	43.90	58.13	58.94	60.02
18	44.06	44.79	45.40	59.86	60.71	61.65
19	45.44	46.19	46.82	61.60	62.46	63.53
20	46.56	47.33	48.11	63.28	64.17	65.17
21	47.94	48.48	49.61	65.00	65.93	66.72
22	49.37	49.95	51.10	66.90	67.84	68.72
23	50.58	51.18	52.18	68.57	69.53	70.36
24	51.89	52.50	53.42	70.22	71.22	72.09
25	52.90	53.52	54.34	71.91	72.93	73.79
26	54.15	54.77	55.68	73.91	74.95	75.84
27	55.67	56.32	57.17	75.71	76.78	77.68
28	57.00	57.67	58.53	77.59	78.67	79.61
29	58.33	59.00	59.97	79.38	80.51	81.45
30	59.64	60.34	61.44	81.19	82.34	83.32
31	60.59	61.48	62.86	82.99	84.32	85.31
32	61.90	62.80	64.15	84.83	86.20	87.22
33	63.43	64.37	65.65	86.65	88.04	89.09
34	64.63	65.57	66.85	88.46	89.87	90.94
35	65.88	66.84	68.58	89.64	91.09	92.70

*Visit [ups.com/holidays](https://www.ups.com/holidays) for time in transit changes effective during the holiday season.

Notes:

- For additional information, refer to pages 26 and 76.
- For a multiple-package shipment, the minimum charge will be based on an average weight of 15 pounds per package.

Export

UPS® Standard to Canada*

Zones	51	52	53	54	55	56
36 Lbs.	\$67.07	\$68.04	\$69.40	\$91.72	\$93.21	\$94.30
37	68.59	69.60	70.95	93.58	95.08	96.21
38	69.83	70.86	72.42	95.19	96.71	97.99
39	71.42	72.47	73.78	96.72	98.26	99.43
40	72.62	73.68	75.22	98.57	100.17	101.36
41	73.88	74.97	76.42	100.25	101.86	103.07
42	75.06	76.16	77.69	101.73	103.38	104.59
43	76.46	77.58	79.11	103.46	105.13	106.37
44	77.43	78.57	80.03	104.79	106.48	107.74
45	78.89	80.05	81.52	106.74	108.45	109.74
46	80.16	81.34	83.00	108.26	110.01	111.31
47	81.40	82.59	84.28	109.93	111.69	113.03
48	82.47	83.67	85.44	111.59	113.39	114.72
49	83.85	85.07	86.62	113.13	114.96	116.33
50	85.24	86.47	88.11	114.94	116.78	118.17
52	87.83	89.12	90.72	117.35	119.23	121.78
54	90.27	91.60	93.25	119.61	121.54	124.34
56	92.38	93.73	95.43	122.08	124.13	127.86
58	98.69	102.02	104.65	124.56	127.43	131.19
60	100.73	103.36	105.69	126.75	129.69	133.80
62	101.88	104.40	106.73	129.50	132.52	137.26
64	102.92	105.43	107.76	131.90	134.08	139.19
66	103.96	106.47	108.80	134.05	137.00	142.25
68	105.00	107.50	109.83	136.45	138.63	145.56
70	106.04	108.53	110.87	139.19	141.44	147.90
72	107.07	109.56	111.90	142.37	143.73	152.77
74	108.11	110.60	112.94	145.06	146.44	156.86
76	109.15	111.63	113.97	148.43	149.84	160.97
78	110.19	112.67	115.01	149.48	150.99	163.79
80	111.23	113.70	116.04	152.84	154.30	167.73
82	112.27	114.74	117.08	155.67	157.15	171.00
84	113.31	115.77	118.11	158.44	159.94	174.20
86	114.35	116.81	119.15	161.99	163.53	177.29
88	115.39	117.85	120.19	164.67	166.23	180.61
90	116.42	118.88	121.22	167.29	168.89	183.64

*Visit [ups.com/holidays](https://www.ups.com/holidays) for time in transit changes effective during the holiday season.

Note: For additional information, refer to pages [26](#) and [76](#).

Export

UPS® Standard to Canada*

Zones	51	52	53	54	55	56
92 Lbs.	\$117.46	\$119.92	\$122.26	\$170.43	\$172.06	\$186.97
94	118.50	120.95	123.29	173.12	174.78	190.00
96	119.54	121.99	125.02	176.03	177.71	193.13
98	120.58	123.02	127.55	179.11	180.82	196.11
100	121.62	124.06	130.15	181.66	183.40	199.43
105	122.66	125.09	132.72	182.71	185.29	205.12
110	123.66	126.63	137.48	186.06	193.20	213.26
115	124.66	132.04	143.08	193.38	201.39	222.00
120	127.75	136.28	149.52	200.70	209.19	230.52
125	130.73	141.47	155.13	208.03	217.26	238.87
130	133.42	145.13	161.28	215.42	224.29	246.25
135	136.30	149.27	167.11	221.30	229.11	253.06
140	139.12	152.55	172.09	228.39	236.12	261.09
145	141.79	156.23	176.83	238.39	242.65	266.75
150	144.71	159.55	181.79	243.29	247.67	270.19

Shipments of More Than 150 Pounds

Zones	51	52	53	54	55	56
Shipments of 151 to 199 Pounds						
Price Per Pound	\$0.97	\$1.07	\$1.22	\$1.63	\$1.66	\$1.81
Minimum Rate	144.71	159.55	181.79	243.29	247.67	270.19
Shipments of 200 to 499 Pounds						
Price Per Pound	\$0.96	\$1.02	\$1.15	\$1.53	\$1.60	\$1.74
Minimum Rate	193.03	212.93	242.78	324.37	330.34	360.19
Shipments of 500 Pounds or More						
Price Per Pound	\$0.81	\$0.96	\$1.12	\$1.42	\$1.49	\$1.69
Minimum Rate	479.04	508.98	573.85	763.47	798.40	868.26

*Visit [ups.com/holidays](https://www.ups.com/holidays) for time in transit changes effective during the holiday season.

Note: For additional information, refer to pages [26](#) and [76](#).

Export

UPS® Standard to Mexico*

Guaranteed delivery to all of Mexico by end of day within four to eight business days. Rates include routine, in-house, customs clearance. Customs clearance by UPS Supply Chain Solutions is required.**

Zones	32	33	34	35	36	37	38
1 Lbs.	\$54.98	\$55.40	\$56.68	\$57.17	\$57.65	\$57.90	\$58.03
2	58.65	59.72	60.22	61.12	61.23	61.64	61.74
3	62.85	64.44	64.77	65.17	65.28	66.28	66.35
4	66.20	66.52	66.94	67.34	67.64	69.66	69.85
5	66.53	68.04	68.49	69.67	70.64	72.14	72.26
6	70.65	70.85	71.24	72.55	75.02	75.03	75.04
7	72.17	72.42	72.88	74.12	75.08	76.99	77.21
8	72.37	73.91	74.16	75.62	76.68	81.36	81.70
9	75.00	76.69	76.78	77.24	79.24	82.48	84.68
10	76.99	78.63	78.75	79.23	81.16	84.34	86.60
11	80.62	80.78	81.02	82.67	84.99	88.29	90.48
12	81.42	83.19	83.33	83.73	85.65	88.70	91.00
13	83.60	85.36	85.57	86.00	87.87	90.91	93.23
14	87.38	87.60	87.87	88.16	89.98	94.95	95.72
15	87.91	89.96	90.18	91.63	92.75	96.02	98.87
16	88.43	90.57	90.95	92.23	93.77	99.11	100.21
17	90.58	92.89	93.18	94.71	96.69	101.31	103.33
18	91.46	94.17	94.41	95.22	98.23	101.90	105.27
19	91.67	94.48	94.89	95.71	98.50	102.23	105.83
20	92.55	94.65	95.06	99.03	100.23	104.02	107.92
21	97.65	99.18	99.49	99.70	103.34	107.28	111.32
22	100.61	102.30	102.79	105.38	106.63	110.81	115.13
23	103.04	104.82	105.35	108.06	109.63	113.79	118.36
24	105.53	107.23	108.10	110.85	112.47	117.00	121.64
25	105.75	107.65	108.43	113.26	115.02	119.54	124.67
26	110.17	112.30	113.16	115.68	117.43	124.31	127.78
27	112.21	114.40	114.95	115.91	119.92	124.97	130.56
28	113.56	116.57	117.62	120.35	126.04	128.88	133.57
29	113.73	117.64	119.61	120.50	126.44	130.11	136.86
30	114.07	118.26	120.37	120.80	127.06	130.72	137.72
31	114.27	118.71	120.43	120.95	127.38	131.23	138.11
32	114.88	118.85	121.27	121.81	127.97	133.45	140.48
33	116.98	121.25	123.72	125.89	130.72	136.26	143.61
34	118.70	121.41	125.67	126.59	132.96	138.65	146.28
35	120.70	126.03	127.81	128.76	135.34	141.20	149.02

*Visit [ups.com/holidays](https://www.ups.com/holidays) for time in transit changes effective during the holiday season.

**In cases where the shipment cannot be imported, the shipment will be automatically returned to the exporter.

Notes:

- For additional information, refer to pages [26](#) and [76](#).
- For a multiple-package shipment, the minimum charge will be based on an average weight of 15 pounds per package.

Export

UPS® Standard to Mexico*

Zones	32	33	34	35	36	37	38
36 Lbs.	\$122.79	\$128.13	\$130.30	\$133.73	\$137.91	\$143.87	\$151.94
37	128.58	131.58	133.96	137.22	140.85	146.36	153.66
38	132.12	135.10	137.44	139.74	144.36	149.88	157.21
39	133.41	136.66	138.08	140.25	146.64	152.15	159.44
40	133.63	137.58	138.75	142.13	148.29	153.89	161.24
41	135.92	141.85	143.97	144.37	150.73	156.37	163.74
42	138.19	143.36	144.36	146.61	152.96	158.56	165.70
43	139.50	143.76	144.76	150.79	154.31	159.86	167.12
44	141.62	145.54	148.59	151.85	155.11	160.71	168.05
45	142.49	146.78	148.96	152.24	155.60	161.21	168.57
46	144.86	146.96	150.07	152.40	156.63	162.27	169.49
47	147.06	150.03	152.42	152.72	158.89	164.50	171.72
48	147.20	151.42	153.62	154.90	161.09	166.72	173.98
49	148.82	151.79	154.00	156.97	163.23	168.78	176.00
50	150.42	153.38	155.64	158.68	164.79	170.43	177.61
52	153.89	156.39	159.81	161.72	168.61	173.18	180.39
54	158.72	161.80	165.71	167.22	173.97	175.73	181.04
56	163.15	165.31	170.52	171.12	179.23	179.94	186.71
58	164.79	167.23	171.47	173.17	181.76	184.25	191.01
60	168.48	171.16	173.70	177.20	182.59	188.20	195.04
62	172.06	174.87	177.35	180.79	187.83	191.78	198.61
64	178.18	180.49	181.17	184.47	190.81	198.27	204.26
66	178.56	181.27	183.98	188.02	191.46	201.72	207.73
68	181.83	184.73	187.44	191.45	194.76	204.99	211.15
70	185.58	188.23	193.01	195.03	198.19	208.56	214.58
72	189.11	191.73	194.70	198.45	201.75	211.99	217.89
74	193.65	198.86	199.42	202.00	204.95	215.43	221.30
76	194.60	199.30	200.17	205.27	208.32	220.02	225.18
78	196.65	199.40	206.66	208.84	213.43	222.05	227.25
80	198.34	201.09	207.77	209.29	215.27	223.86	229.10

*Visit [ups.com/holidays](https://www.ups.com/holidays) for time in transit changes effective during the holiday season.

Note: For additional information, refer to pages [26](#) and [76](#).

Export

UPS® Standard to Mexico*

Zones	32	33	34	35	36	37	38
82 Lbs.	\$200.59	\$203.20	\$208.73	\$211.23	\$217.16	\$225.79	\$230.87
84	203.86	206.60	209.18	214.52	220.41	228.79	234.02
86	207.30	213.16	215.26	218.70	223.66	232.16	237.24
88	210.50	213.32	215.85	220.80	226.74	235.18	240.21
90	213.79	216.56	219.20	224.04	229.92	238.70	243.30
92	216.26	224.25	224.51	226.59	232.21	241.02	245.80
94	219.89	225.48	227.91	229.76	235.35	244.10	248.89
96	222.86	225.78	228.32	232.33	237.67	246.41	251.18
98	225.83	227.83	230.95	234.70	239.89	248.56	253.58
100	229.30	230.68	234.23	237.49	242.65	251.36	256.43
105	238.03	239.74	242.78	245.89	250.84	259.47	264.46
110	247.55	248.95	251.31	254.28	259.17	268.00	273.26
115	254.64	256.21	258.82	261.41	266.44	275.37	280.62
120	261.95	263.62	266.17	268.46	273.78	282.88	288.23
125	269.48	270.96	273.78	275.59	280.90	290.03	295.47
130	276.75	278.54	281.33	282.92	288.06	297.35	302.81
135	284.04	286.24	289.07	290.06	295.28	304.51	309.86
140	291.57	294.10	296.91	297.71	302.79	311.71	317.34
145	299.60	302.36	305.40	305.59	310.59	319.48	325.27
150	307.38	310.72	313.81	314.89	318.56	327.27	333.11

Shipments of More Than 150 Pounds

Zones	32	33	34	35	36	37	38
Shipments of 151 to 199 Pounds							
Price Per Pound	\$2.05	\$2.08	\$2.10	\$2.10	\$2.13	\$2.19	\$2.23
Minimum Rate	307.38	310.72	313.81	314.89	318.56	327.27	333.11
Shipments of 200 Pounds or More							
Price Per Pound	\$1.99	\$2.02	\$2.04	\$2.04	\$2.07	\$2.12	\$2.16
Minimum Rate	407.95	413.92	417.90	417.90	423.87	435.81	443.77

*Visit [ups.com/holidays](https://www.ups.com/holidays) for time in transit changes effective during the holiday season.

Note: For additional information, refer to pages [26](#) and [76](#).

Import Shipment Pricing

UPS Worldwide Express Plus[®], UPS Worldwide Express NA1[®], UPS Worldwide Express[®], UPS Worldwide Express Freight[®] Midday, UPS Worldwide Express Freight[®], UPS Worldwide Saver[®], UPS Worldwide Expedited[®], UPS 3 Day Select[®] from Canada and UPS[®] Standard

Shipment pricing is advantageous because rates are based on the total weight of a shipment, not the sum of the rates for each package in a shipment.

What Qualifies

1. The shipment consists of multiple packages, using the same service, shipped on the same day to a single consignee.
2. For shipments processed with WorldShip[®] or UPS CampusShip[®] shipping systems, [ups.com](https://www.ups.com) shipping, the UPS[®] Developer Kit or a UPS Ready[®] solution that supports full international service or a UPS Worldwide Services Waybill. **Note:** For shipments processed with UPS Developer Kit – Shipping API, in order to obtain the best rate, customers are responsible for aggregating shipments for shipment pricing prior to requesting labels (UPS Developer Kit – Shipping API does not run End of Day).

What Does Not Qualify

Shipment pricing does not apply to UPS Express[®] Envelopes, the UPS[®] 10 KG Box or the UPS[®] 25 KG Box; they are each considered separate shipments.

Rates

Rates are based on the total billable weight of all packages in the shipment. Compare each package's actual weight to its dimensional weight. The greater of the two is the billable weight and should be used to calculate the rate. For multiple-package shipments, total the billable weight of all packages in the shipment. Refer to pages [16-17](#) for instructions on calculating dimensional weight.

If the payer of the shipping charges is located in the origin country, the shipment will be charged the export rate (Origin Country Export Rates). When

the payer of the shipping charges is located in the destination country, the shipment will be charged the import rate (Destination Country Import Rates). If the destination country does not have import rates, the shipment will be charged the export rate (Origin Country Export Rates). When the payer of the shipping charges is located in a third country (neither origin nor destination country), the shipment will be charged the Origin Country Export Rates, except as otherwise agreed to by UPS and the contracting party.

Unless otherwise specified at the time of shipping, shipping charges are billed to the shipper. In the event of non-payment by consignee or third party, the charges are billed to the shipper. Refer to page [114](#) for more information on billing options.

For shipments weighing 150 pounds or less, locate the rate for the total weight of the shipment on the appropriate rate chart.

To determine the rate for a shipment weighing more than 150 pounds, multiply the total weight (rounded to the next whole pound) by the appropriate price per pound as shown under the shipment weight designations above 150 pounds. The amount billed will be the result of this calculation or the minimum rate shown, whichever is greater.

For a multiple-package UPS Standard shipment, the minimum charge will be based on an average weight of 15 pounds per package.

All rates for UPS international services, except UPS[®] Standard from Canada, include routine, in-house, customs brokerage. For more information on customs brokerage for import shipments, refer to pages [134-136](#).

Useful Information – International Shipping

Import/Export Support Information on international shipping and trade	Visit ups.com/international
Shipping Forms Import/export documents	Visit ups.com/intl_forms
UPS Paperless[®] Invoice Send Commercial Invoices and other customs documents electronically, saving time and paper	Visit ups.com/paperlessinvoice
UPS TradeAbility[®] Services Harmonizer, landed cost and compliance tools	Visit ups.com/tradeability
International Customer Service Assistance with international shipments	Call 1-800-782-7892
UPS Import Control[®] Services Take control of your imports	Visit UPS Import Control[®]

Import

UPS Worldwide Express®

UPS Worldwide Express Plus®

Guaranteed delivery as early as 8:00 a.m. or 8:30 a.m. on the next business day from Canada and one to two business days from Asia, Europe and Latin America. Delivery from all valid UPS origins. Rates include door-to-door delivery with routine, in-house customs clearance by UPS Supply Chain Solutions® Add \$40.00 to the appropriate UPS Worldwide Express rate for each UPS Worldwide Express Plus shipment.

UPS Worldwide Express NA1®

Overnight delivery to the U.S., Canada and Latin America from select cities in Germany, the United Kingdom and the Netherlands. Guaranteed delivery by 10:30 a.m. or 12 p.m. where UPS Worldwide Express service is available or end of day if UPS Worldwide Saver® is the only available service to the destination postal code. UPS Worldwide Express rates apply, which include door-to-door delivery with routine, in-house customs clearance by UPS Supply Chain Solutions. Service requires an early pickup at origin.

UPS Worldwide Express

Guaranteed delivery as early as 10:30 a.m., 12:00 p.m. or 2:00 p.m. from all valid UPS origins. Delivery is guaranteed on the next business day from Canada and Mexico and one to two business days from Asia, Europe and Latin America. Rates include door-to-door delivery with routine, in-house customs clearance by UPS Supply Chain Solutions.

Letter/Document

Zones	91	94	951	952	953	954	955	956	957	958	959	961	962	963	970	971
Letter*	\$56.32	\$56.52	\$97.48	\$82.31	\$104.80	\$78.98	\$113.42	\$79.44	\$97.20	\$106.53	\$81.44	\$91.04	\$70.61	\$81.44	\$77.44	\$74.58
1 Lbs.	82.11	60.73	113.49	91.62	135.21	99.49	133.39	90.46	122.64	133.92	102.96	99.10	87.95	103.07	89.61	89.44
2	83.65	61.37	116.32	94.47	137.51	105.54	168.73	114.11	146.71	169.24	107.86	120.80	96.48	115.83	92.09	112.83
3	113.57	85.77	172.47	146.95	200.82	157.70	279.46	167.08	212.19	266.36	162.72	165.27	156.38	162.72	137.20	147.61
4	124.84	92.81	194.47	161.83	222.76	178.03	322.03	192.02	236.97	320.16	184.33	187.76	180.35	184.33	155.67	169.50
5	136.20	100.39	217.36	176.72	244.70	198.89	364.57	220.06	269.85	349.87	201.20	218.73	198.12	201.20	167.77	190.78
6	150.89	106.85	234.81	193.80	270.20	217.48	405.29	244.06	294.43	390.74	217.88	236.93	219.39	217.88	185.93	206.44
7	158.20	115.00	249.55	208.50	291.34	236.31	447.15	265.32	320.66	437.18	236.37	261.01	240.12	236.37	201.03	226.30
8	169.18	118.72	265.58	222.94	310.00	255.98	496.06	289.60	346.21	483.95	255.34	278.19	259.42	255.34	213.97	242.30
9	179.67	124.66	277.71	237.43	331.65	275.68	527.44	311.24	368.21	525.60	275.14	299.97	279.08	275.14	228.08	262.01
10	190.46	129.24	285.60	251.91	351.54	283.05	548.94	323.52	394.85	571.04	284.40	316.89	292.04	284.40	242.14	265.93

Non-document

Zones	91	94	951	952	953	954	955	956	957	958	959	961	962	963	970	971
1 Lbs.	\$95.78	\$71.02	\$163.23	\$114.60	\$176.53	\$133.73	\$200.79	\$126.26	\$169.58	\$189.30	\$135.39	\$146.63	\$125.03	\$135.39	\$106.73	\$114.04
2	108.41	79.60	186.25	137.34	201.81	156.75	240.26	151.47	197.67	227.94	154.49	171.93	144.23	155.74	128.37	132.28
3	120.87	88.96	204.39	153.38	222.68	181.17	291.32	174.09	236.41	283.02	180.04	194.14	163.93	180.04	143.14	151.10
4	132.58	96.24	228.83	169.22	255.27	207.15	335.91	200.27	272.28	326.17	198.64	216.21	183.28	198.64	158.18	171.00
5	144.30	104.11	248.29	185.34	275.74	228.53	380.29	227.46	299.85	362.47	216.89	238.48	201.25	216.89	172.93	193.67
6	156.53	110.82	264.47	199.16	293.39	251.71	422.74	251.57	324.64	402.93	235.12	256.20	221.89	235.12	190.48	209.77
7	164.02	118.72	279.30	214.40	311.06	275.03	466.41	276.57	349.43	453.28	250.43	275.21	242.40	250.43	201.14	229.36
8	175.11	123.13	293.88	230.12	335.01	297.58	517.42	298.52	375.05	493.08	267.37	303.09	262.88	267.37	215.29	245.71
9	185.96	129.27	306.99	244.27	356.54	317.51	550.16	321.03	399.75	539.81	287.07	322.16	283.41	287.07	231.61	265.30
10	197.49	133.62	313.62	259.58	379.25	319.70	563.26	333.52	426.98	592.08	296.37	334.50	301.28	296.37	243.52	269.24

*The Letter rate applies only to documents, correspondence and electronic media shipments of no commercial value that do not exceed eight ounces sent in a UPS Express® Envelope.

Note: For additional information, refer to page 26.

Import

UPS Worldwide Express®

Non-document

Zones	91	94	951	952	953	954	955	956	957	958	959	961	962	963	970	971
11 Lbs.	\$208.83	\$137.15	\$314.29	\$261.51	\$388.63	\$322.00	\$574.83	\$336.57	\$450.22	\$593.76	\$297.04	\$346.60	\$302.86	\$297.04	\$245.18	\$272.71
12	213.75	137.45	316.72	263.45	393.24	330.38	581.83	339.40	465.49	602.52	299.94	349.72	313.16	304.32	253.50	274.88
13	224.89	156.01	363.49	302.20	452.29	389.99	700.19	394.07	500.34	689.21	350.57	393.04	361.85	350.57	283.00	311.12
14	237.42	162.57	376.99	316.27	463.80	411.43	733.72	410.99	524.21	707.04	371.88	410.44	388.95	371.88	292.87	329.87
15	245.67	166.17	389.10	330.35	482.77	433.92	766.51	435.48	547.55	741.00	387.04	429.53	409.03	387.04	308.77	346.02
16	252.54	174.08	402.63	343.85	502.55	448.12	795.25	450.11	574.07	783.43	398.70	436.91	434.01	398.70	321.35	366.11
17	261.46	179.65	414.77	357.29	522.36	468.00	826.57	457.43	597.40	808.56	414.17	452.98	440.21	414.17	334.03	379.38
18	268.88	188.23	426.92	370.79	542.16	484.52	853.14	474.97	619.65	837.17	421.93	472.08	472.93	421.93	343.30	397.44
19	276.59	189.71	439.08	384.28	574.88	502.72	888.64	487.21	643.55	862.22	439.02	486.84	492.96	439.02	355.60	412.21
20	285.08	193.65	449.61	397.76	581.77	516.09	911.06	499.44	660.60	871.18	447.62	504.15	514.88	447.62	368.16	428.37
21	290.49	199.13	457.05	411.10	615.41	521.20	911.46	505.36	689.13	919.29	456.82	506.61	532.46	456.82	383.87	435.13
22	297.62	203.19	460.89	421.70	621.38	521.66	913.04	508.91	712.18	933.59	457.09	509.10	539.06	457.09	393.88	436.83
23	304.67	203.59	461.14	422.30	635.45	522.22	916.23	513.27	729.66	934.16	479.67	519.85	539.40	479.67	394.32	448.08
24	308.78	203.84	461.39	423.01	636.86	525.39	916.58	513.78	752.31	934.78	479.94	521.71	541.62	479.94	404.37	460.85
25	310.44	205.77	464.35	425.35	641.96	539.74	923.49	517.21	762.03	956.07	483.60	525.38	554.33	485.41	406.15	463.37
26	323.54	229.83	521.07	468.15	697.46	622.65	1,061.67	563.59	799.30	1,026.59	516.97	589.20	618.28	516.97	437.13	497.25
27	328.94	240.69	534.89	489.31	716.50	669.49	1,084.90	599.63	820.82	1,062.62	527.70	606.43	640.81	527.70	457.39	530.07
28	336.08	247.07	546.77	502.23	752.44	675.32	1,108.10	613.49	841.38	1,071.45	538.35	619.16	656.90	538.35	469.42	542.80
29	342.43	253.48	556.62	515.11	771.81	693.30	1,140.91	635.13	859.95	1,118.81	554.74	633.08	680.62	554.74	481.32	555.56
30	349.05	255.04	568.44	528.04	773.76	704.96	1,162.76	648.40	878.12	1,136.39	566.81	646.26	691.55	566.81	493.35	567.76
31	355.55	262.81	580.23	539.78	786.26	720.52	1,182.77	654.94	894.15	1,142.10	578.69	660.59	694.39	578.69	504.44	579.41
32	361.82	268.59	589.93	551.53	817.29	727.33	1,208.87	677.67	907.90	1,143.88	584.22	677.10	721.23	584.22	515.43	591.63
33	367.06	270.74	597.47	553.39	822.71	762.84	1,231.92	690.37	921.37	1,179.09	595.23	688.13	731.77	595.23	517.15	601.50
34	372.36	275.96	607.15	574.34	824.32	766.84	1,247.21	694.51	933.80	1,211.22	607.75	699.00	753.77	607.75	536.76	613.57
35	377.59	284.11	618.16	579.16	856.26	787.26	1,270.37	707.80	944.77	1,256.20	616.59	707.85	776.59	616.59	541.13	623.44
36	382.85	288.89	628.61	598.49	865.78	811.56	1,293.56	721.16	955.84	1,262.45	621.68	725.93	793.08	621.68	559.33	637.16
37	388.96	294.81	638.45	610.24	866.77	829.26	1,319.51	734.44	966.54	1,269.16	632.56	738.67	795.47	632.56	570.32	649.63
38	389.58	300.32	648.20	621.54	885.88	854.52	1,339.92	749.20	978.41	1,290.35	661.35	752.73	810.33	661.35	580.76	660.47
39	398.60	305.70	657.87	625.61	887.80	872.84	1,368.65	762.55	989.63	1,308.22	685.89	772.29	832.99	685.89	584.62	672.14
40	403.84	310.89	667.57	634.11	900.49	890.38	1,390.82	782.01	1,000.46	1,340.46	696.88	786.48	840.01	696.88	592.62	683.52
41	408.60	313.77	677.06	656.37	932.82	908.28	1,411.19	795.43	1,021.71	1,362.92	713.05	796.25	858.12	713.05	612.87	694.61
42	413.41	321.62	686.49	668.43	944.52	921.43	1,433.39	814.24	1,032.66	1,389.31	728.71	808.07	869.74	728.71	624.67	706.16
43	421.67	327.11	695.93	669.28	952.69	961.19	1,456.34	823.04	1,044.94	1,405.87	737.01	821.49	884.59	737.01	624.94	717.68
44	423.04	332.33	705.36	688.48	953.50	970.42	1,475.52	835.74	1,055.48	1,414.43	762.17	834.61	887.21	762.17	643.81	728.35
45	427.88	338.26	714.88	690.05	957.56	971.74	1,500.81	840.41	1,067.50	1,442.68	767.81	848.37	939.49	767.81	644.32	740.02
46	432.69	343.33	724.32	701.69	987.59	997.87	1,531.12	862.97	1,088.09	1,490.79	768.30	855.62	946.22	768.30	657.96	749.88
47	437.52	348.84	731.10	725.72	994.06	1,010.57	1,560.23	866.85	1,100.37	1,495.60	768.63	868.42	947.44	768.63	682.78	760.32
48	442.32	350.10	743.21	731.55	995.43	1,039.71	1,582.62	880.08	1,111.98	1,497.83	769.45	893.16	971.25	769.45	684.44	772.51
49	444.60	358.16	744.41	747.30	1,022.71	1,051.65	1,606.00	893.28	1,122.82	1,542.25	785.52	895.53	973.64	785.52	694.46	781.84
50	445.20	363.10	745.63	753.01	1,025.44	1,069.53	1,627.05	906.51	1,135.11	1,614.22	797.29	910.97	988.52	797.29	696.41	793.76

Note: For additional information, refer to page 26.

Import

UPS Worldwide Express®

Non-document

Zones	91	94	951	952	953	954	955	956	957	958	959	961	962	963	970	971
52 Lbs.	\$459.12	\$380.14	\$791.75	\$780.86	\$1,077.57	\$1,111.38	\$1,673.67	\$946.32	\$1,166.33	\$1,684.03	\$839.31	\$948.14	\$1,063.41	\$839.31	\$722.16	\$810.64
54	463.24	381.24	797.03	803.62	1,080.63	1,141.15	1,725.72	958.83	1,194.54	1,732.21	870.97	976.25	1,083.00	870.97	744.42	833.39
56	477.77	393.20	815.90	825.34	1,093.29	1,171.71	1,771.01	990.58	1,221.92	1,734.27	881.68	1,002.91	1,105.06	881.68	772.33	855.60
58	492.58	405.14	834.77	847.06	1,105.92	1,202.27	1,817.11	1,025.56	1,248.09	1,736.33	914.57	1,029.70	1,127.13	914.57	792.56	877.54
60	494.95	417.03	853.54	868.85	1,150.82	1,249.54	1,857.39	1,037.27	1,273.62	1,746.63	950.37	1,053.62	1,200.77	950.37	812.95	899.65
62	513.74	430.10	879.61	876.20	1,154.98	1,283.27	1,903.65	1,075.35	1,299.39	1,808.33	984.55	1,079.72	1,235.09	984.55	818.13	922.67
64	525.47	449.42	892.36	919.93	1,172.93	1,321.50	1,949.54	1,096.72	1,327.04	1,870.05	1,009.44	1,110.27	1,257.96	1,009.44	858.97	945.29
66	536.02	456.66	918.64	922.26	1,222.46	1,352.29	2,012.35	1,115.48	1,352.34	1,919.11	1,011.38	1,136.92	1,282.25	1,011.38	861.14	951.62
68	538.13	480.48	928.02	938.93	1,226.14	1,382.59	2,042.94	1,146.25	1,378.33	1,921.75	1,012.28	1,163.88	1,354.09	1,012.28	876.71	969.97
70	555.47	493.90	945.89	959.82	1,257.52	1,409.41	2,098.58	1,178.64	1,404.11	1,963.36	1,077.21	1,190.52	1,380.23	1,077.21	896.21	1,011.81
72	569.73	507.26	986.94	996.29	1,261.31	1,445.98	2,138.25	1,211.19	1,431.37	2,026.44	1,114.38	1,224.12	1,382.49	1,114.38	932.07	1,054.03
74	580.85	519.01	988.56	1,001.69	1,308.58	1,481.65	2,226.56	1,233.30	1,455.39	2,072.49	1,122.06	1,242.94	1,420.11	1,122.06	935.30	1,073.94
76	591.85	525.51	996.06	1,038.80	1,324.87	1,516.11	2,273.34	1,241.56	1,488.42	2,116.49	1,146.95	1,281.78	1,496.52	1,146.95	971.89	1,079.98
78	603.36	534.95	1,022.10	1,055.05	1,327.63	1,550.54	2,297.83	1,265.32	1,510.03	2,219.83	1,181.68	1,326.41	1,530.99	1,181.68	985.12	1,088.77
80	604.85	548.01	1,036.26	1,083.48	1,375.62	1,585.10	2,345.67	1,286.60	1,536.35	2,272.69	1,207.67	1,346.96	1,536.78	1,207.67	1,011.68	1,111.39
82	610.09	567.53	1,056.87	1,101.99	1,385.94	1,620.22	2,401.85	1,310.73	1,565.64	2,310.62	1,223.76	1,368.96	1,583.83	1,223.76	1,029.65	1,133.88
84	619.18	575.59	1,073.67	1,110.79	1,412.29	1,650.66	2,447.72	1,324.45	1,592.00	2,368.52	1,258.31	1,386.68	1,587.20	1,258.31	1,037.16	1,155.29
86	630.40	598.78	1,086.48	1,130.23	1,424.98	1,670.52	2,453.69	1,328.19	1,619.97	2,414.61	1,296.66	1,409.73	1,634.30	1,296.66	1,055.34	1,177.50
88	639.08	599.44	1,113.17	1,150.50	1,444.50	1,671.23	2,497.66	1,334.49	1,653.83	2,418.87	1,297.31	1,426.55	1,667.83	1,297.31	1,074.24	1,199.30
90	647.16	605.91	1,141.55	1,152.18	1,446.47	1,681.51	2,558.01	1,347.97	1,680.29	2,483.17	1,323.26	1,454.39	1,722.69	1,323.26	1,075.83	1,217.12
92	656.89	618.03	1,150.95	1,163.05	1,447.06	1,695.65	2,590.51	1,387.61	1,681.93	2,493.98	1,365.77	1,493.28	1,732.14	1,365.77	1,085.99	1,234.68
94	665.85	620.14	1,157.75	1,177.43	1,447.74	1,709.09	2,604.22	1,401.36	1,719.69	2,499.06	1,381.40	1,503.56	1,747.33	1,381.40	1,105.18	1,252.78
96	674.56	640.28	1,171.91	1,192.96	1,452.63	1,719.54	2,653.05	1,415.21	1,754.25	2,615.02	1,384.15	1,520.37	1,764.26	1,384.15	1,113.90	1,275.55
98	685.34	646.19	1,194.02	1,203.13	1,454.81	1,720.96	2,704.62	1,416.83	1,776.56	2,624.68	1,399.17	1,531.99	1,786.99	1,399.17	1,153.85	1,295.98
100	696.26	677.07	1,227.07	1,303.07	1,523.52	1,721.45	2,741.82	1,456.07	1,812.59	2,627.02	1,433.07	1,578.60	1,796.61	1,433.07	1,172.56	1,317.03
105	728.31	732.37	1,288.50	1,364.84	1,600.28	1,850.63	2,883.96	1,525.84	1,907.61	2,757.63	1,527.99	1,657.92	1,894.78	1,527.99	1,256.22	1,371.54
110	761.07	767.24	1,349.85	1,429.84	1,674.78	1,938.75	3,015.61	1,598.30	1,995.54	2,886.10	1,585.63	1,732.78	1,985.00	1,585.63	1,344.60	1,425.10
115	797.15	802.12	1,411.20	1,494.82	1,750.33	2,026.87	3,149.19	1,669.92	2,064.07	3,014.83	1,673.48	1,809.79	2,075.23	1,673.48	1,401.78	1,485.62
120	828.12	836.99	1,472.56	1,559.81	1,822.41	2,101.86	3,285.24	1,741.53	2,132.99	3,142.93	1,737.44	1,897.91	2,165.18	1,737.44	1,462.65	1,549.29
125	859.00	871.85	1,533.91	1,624.80	1,895.57	2,188.94	3,425.34	1,811.61	2,202.75	3,272.98	1,808.55	1,990.21	2,254.40	1,808.55	1,523.26	1,608.34
130	889.59	906.74	1,595.26	1,689.78	1,980.79	2,272.00	3,559.83	1,884.07	2,271.28	3,402.50	1,875.59	2,062.92	2,329.65	1,875.59	1,583.98	1,665.58
135	921.54	941.60	1,656.62	1,754.77	2,051.79	2,355.88	3,695.05	1,955.12	2,339.26	3,532.57	1,938.85	2,138.59	2,394.49	1,938.85	1,644.73	1,724.76
140	951.44	976.48	1,717.97	1,819.77	2,121.47	2,440.32	3,830.13	2,027.03	2,426.34	3,661.56	2,006.89	2,207.04	2,466.47	2,006.89	1,705.08	1,784.62
145	982.90	1,011.34	1,779.32	1,884.76	2,193.67	2,525.73	3,964.10	2,099.90	2,494.72	3,790.70	2,076.78	2,275.65	2,545.55	2,076.78	1,765.94	1,842.94
150	1,031.65	1,041.86	1,840.68	1,949.75	2,264.43	2,609.20	4,098.20	2,172.63	2,563.39	3,916.54	2,135.49	2,353.21	2,624.80	2,135.49	1,816.99	1,903.63

Shipments of More Than 150 Pounds (non-pallet)

Zones	91	94	951	952	953	954	955	956	957	958	959	961	962	963	970	971
Price Per Pound	\$6.88	\$6.95	\$12.28	\$13.00	\$15.10	\$17.40	\$27.33	\$14.49	\$17.09	\$26.12	\$14.24	\$15.69	\$17.50	\$14.24	\$12.12	\$12.70
Minimum Rate	1,031.65	1,041.86	1,840.68	1,949.75	2,264.43	2,609.20	4,098.20	2,172.63	2,563.39	3,916.54	2,135.49	2,353.21	2,624.80	2,135.49	1,816.99	1,903.63

Note: For additional information, refer to page 26.

Import

UPS Worldwide Express Freight® Midday

Guaranteed delivery by 12:00 p.m. or 2:00 p.m. from 81 countries and territories. Delivery is guaranteed on the next business day to Canada, the second business day to Europe and Latin America, and within two to three business days to Asia. Rates include door-to-door and non door-to-door delivery with routine, in-house customs clearance by UPS Supply Chain Solutions® for palletized shipments of more than 150 pounds.

Door-to-Door

Zones	491	494	451	452	453	454	455
151-999 Lbs. (Price per Lb.)	\$7.87	\$8.20	\$14.44	\$15.10	\$17.77	\$19.73	\$28.75
1,000 Lbs. or More (Price per Lb.)	7.48	7.90	13.91	14.54	17.12	18.99	27.03
Minimum Rate	1,188.37	1,238.20	2,180.44	2,280.10	2,683.27	2,979.23	4,341.25

Zones	456	457	458	459	461	462	463	470	471
151-999 Lbs. (Price per Lb.)	\$16.05	\$18.87	\$29.21	\$16.75	\$17.84	\$19.90	\$16.75	\$14.13	\$15.11
1,000 Lbs. or More (Price per Lb.)	15.61	17.39	27.51	16.10	17.32	18.89	16.14	13.58	14.52
Minimum Rate	2,423.55	2,849.37	4,410.71	2,529.25	2,693.84	3,004.90	2,529.25	2,133.63	2,281.61

Non Door-to-Door: Drop-off, Hold at Location, Drop-off and Hold at Location

Zones	491	494	451	452	453	454	455
151-999 Lbs. (Price per Lb.)	\$7.55	\$7.61	\$13.50	\$13.72	\$16.92	\$18.34	\$26.84
1,000 Lbs. or More (Price per Lb.)	7.17	7.32	13.00	13.20	16.30	17.63	25.22
Minimum Rate	1,140.05	1,149.11	2,038.50	2,071.72	2,554.92	2,769.34	4,052.84

Zones	456	457	458	459	461	462	463	470	471
151-999 Lbs. (Price per Lb.)	\$14.89	\$18.01	\$27.30	\$15.64	\$16.16	\$18.43	\$16.00	\$12.81	\$13.95
1,000 Lbs. or More (Price per Lb.)	14.48	16.56	25.70	15.03	15.68	17.47	15.41	12.31	13.39
Minimum Rate	2,248.39	2,719.51	4,122.30	2,361.64	2,440.16	2,782.93	2,416.00	1,934.31	2,106.45

Notes:

- Door-to-door refers to shipments picked up and delivered to addresses designated by the shipper.
- Drop-off refers to shipments that are dropped off at a UPS Worldwide Express Freight Center and delivered to a designated address.
- Hold at Location refers to shipments picked up at a designated address and held at a UPS Worldwide Express Freight Center for pickup.
- Drop-off and Hold at Location refers to shipments that are dropped off and held at a UPS Worldwide Express Freight Center for pickup.
- For UPS Worldwide Express Freight Midday shipments, additional charges may apply to larger pallets. Pallets exceeding maximum size or weight restrictions (which vary by origin and destination) as set forth at [ups.com/assets/resources/media/wwef_max_dim.pdf](https://www.ups.com/assets/resources/media/wwef_max_dim.pdf) require prior authorization. Refer to page 124 for more information.
- For additional information, refer to page 26.

Import

UPS Worldwide Express Freight®

Guaranteed delivery by end of day from 76 and to 81 countries and territories. Delivery is guaranteed on the next business day from Canada and Mexico and one to two business days from Asia, Europe and Latin America. Rates include door-to-door and non door-to-door delivery with routine, in-house customs clearance by UPS Supply Chain Solutions® for palletized shipments of more than 150 pounds.

Door-to-Door

Zones	491	494	451	452	453	454	455
151-999 Lbs. (Price per Lb.)	\$6.85	\$6.56	\$12.03	\$12.58	\$14.81	\$16.44	\$26.14
1,000 Lbs. or More (Price per Lb.)	6.51	6.32	11.59	12.11	14.27	15.82	24.58
Minimum Rate	1,033.28	990.56	1,816.53	1,899.58	2,236.31	2,482.44	3,947.14

Zones	456	457	458	459	461	462	463	470	471
151-999 Lbs. (Price per Lb.)	\$13.96	\$16.41	\$25.40	\$13.40	\$14.87	\$15.92	\$13.40	\$12.29	\$13.14
1,000 Lbs. or More (Price per Lb.)	13.58	15.12	23.92	12.88	14.44	15.11	12.91	11.82	12.63
Minimum Rate	2,107.96	2,477.91	3,835.40	2,023.40	2,245.37	2,403.92	2,023.40	1,855.40	1,984.07

Non Door-to-Door: Drop-off, Hold at Location,
Drop-off and Hold at Location

Zones	491	494	451	452	453	454	455
151-999 Lbs. (Price per Lb.)	\$6.57	\$6.09	\$11.25	\$11.43	\$14.10	\$15.28	\$24.40
1,000 Lbs. or More (Price per Lb.)	6.24	5.86	10.83	11.00	13.58	14.69	22.93
Minimum Rate	991.00	919.59	1,698.75	1,725.93	2,129.10	2,307.28	3,684.40

Zones	456	457	458	459	461	462	463	470	471
151-999 Lbs. (Price per Lb.)	\$12.95	\$15.66	\$23.74	\$12.51	\$13.47	\$14.74	\$12.80	\$11.14	\$12.13
1,000 Lbs. or More (Price per Lb.)	12.59	14.40	22.35	12.02	13.07	13.97	12.33	10.71	11.64
Minimum Rate	1,955.45	2,364.66	3,584.74	1,889.01	2,033.97	2,225.74	1,932.80	1,681.75	1,831.56

Notes:

- Door-to-door refers to shipments picked up and delivered to addresses designated by the shipper.
- Drop-off refers to shipments that are dropped off at a UPS Worldwide Express Freight Center and delivered to a designated address.
- Hold at Location refers to shipments picked up at a designated address and held at a UPS Worldwide Express Freight Center for pickup.
- Drop-off and Hold at Location refers to shipments that are dropped off and held at a UPS Worldwide Express Freight Center for pickup.
- For UPS Worldwide Express Freight shipments, additional charges may apply to larger pallets. Pallets exceeding maximum size or weight restrictions (which vary by origin and destination) as set forth at [ups.com/assets/resources/media/wwef_max_dim.pdf](https://www.ups.com/assets/resources/media/wwef_max_dim.pdf) require prior authorization. Refer to page 124 for more information.
- For additional information, refer to page 26.

Import

UPS Worldwide Saver[®]

Guaranteed delivery by end of day from more than 185 countries and territories. Delivery is guaranteed on the next business day from Canada and Mexico and one to two business days from Asia, Europe and Latin America. Rates include door-to-door delivery with routine, in-house customs clearance by UPS Supply Chain Solutions[®].

Letter/Document

Zones	491	494	451	452	453	454	455	456	457	458	459	461	462	463	470	471
Letter*	\$54.75	\$55.42	\$95.11	\$79.91	\$101.74	\$76.31	\$112.23	\$77.12	\$91.79	\$101.63	\$75.51	\$87.87	\$68.80	\$76.43	\$73.74	\$70.59
1 Lbs.	76.59	58.68	110.27	88.62	130.32	95.70	123.42	88.38	115.78	121.79	100.68	95.23	81.68	100.68	83.13	84.06
2	79.95	59.29	111.90	90.29	132.47	97.35	153.09	111.51	138.69	153.32	103.79	117.27	90.35	112.22	87.29	102.87
3	110.25	82.87	168.25	144.06	196.88	152.28	273.97	163.80	208.04	259.86	157.05	160.45	148.27	157.05	128.69	137.27
4	121.20	89.66	189.73	158.65	218.38	171.96	315.70	188.25	232.32	312.35	177.90	182.28	170.98	177.90	146.40	161.10
5	132.23	96.98	212.05	173.24	239.90	192.12	357.42	215.74	264.56	341.06	194.23	212.35	187.84	194.23	159.37	181.67
6	143.05	103.23	229.07	189.99	264.90	210.74	397.33	239.27	288.65	379.13	213.00	230.02	207.22	213.00	178.66	197.31
7	153.58	111.10	243.46	204.41	285.62	230.49	438.38	260.12	314.37	426.50	231.14	253.41	226.75	231.14	193.92	215.85
8	163.96	114.71	259.10	218.56	303.91	249.52	486.33	283.91	339.42	472.14	249.69	270.08	245.19	249.69	204.27	230.97
9	174.43	120.43	270.93	232.77	325.15	268.98	517.10	305.13	361.00	512.77	269.05	291.22	264.44	269.05	219.55	249.75
10	184.91	124.86	278.63	246.95	344.65	275.96	538.18	317.17	387.10	557.10	278.04	307.66	276.79	278.04	235.04	250.17

Non-document

Zones	491	494	451	452	453	454	455	456	457	458	459	461	462	463	470	471
1 Lbs.	\$90.52	\$68.95	\$158.28	\$109.43	\$173.06	\$129.74	\$194.72	\$122.41	\$164.73	\$184.68	\$127.10	\$137.87	\$118.72	\$130.53	\$100.12	\$105.07
2	102.53	77.28	180.61	131.11	197.84	153.38	232.83	146.97	191.69	222.37	149.24	162.53	135.75	149.24	119.16	124.85
3	114.31	86.36	198.20	146.43	218.31	177.29	282.33	168.80	228.61	273.27	170.73	183.42	154.58	170.73	134.31	142.96
4	125.66	93.43	221.92	161.55	250.26	200.80	325.78	193.94	262.17	315.34	188.75	204.30	172.63	188.75	148.01	162.41
5	137.11	101.07	240.80	176.96	270.33	223.62	368.67	220.62	288.66	353.62	205.60	223.94	189.82	205.60	163.30	184.56
6	148.32	107.59	256.48	191.00	287.64	246.30	410.01	244.56	312.51	393.09	224.29	237.20	209.48	224.29	181.81	199.81
7	159.24	115.26	270.87	205.49	304.96	269.12	452.37	268.47	336.48	442.22	239.24	260.30	228.51	239.24	194.50	218.65
8	170.00	119.54	285.02	219.71	328.44	288.42	496.76	289.89	362.06	475.87	254.60	284.08	247.54	254.60	205.26	234.32
9	180.54	125.50	297.73	234.01	349.54	307.83	533.60	311.55	386.03	525.85	273.45	302.09	266.80	273.45	222.83	252.87
10	191.73	129.72	304.16	248.26	371.81	309.86	541.99	323.85	412.28	577.64	281.84	315.72	281.79	281.84	235.25	253.85
11	201.96	130.59	306.38	252.31	381.01	314.44	551.79	326.76	434.86	579.28	282.32	320.55	286.45	285.46	237.28	254.35
12	203.97	131.77	308.75	254.17	383.99	322.62	562.23	329.50	448.80	583.89	289.58	326.25	297.27	295.05	244.53	262.12
13	217.48	151.47	354.36	291.57	443.41	380.86	673.12	382.59	483.27	662.92	335.02	374.09	342.54	335.02	271.43	296.56
14	229.61	157.83	367.51	305.15	454.70	398.71	705.35	399.02	506.27	689.78	354.42	388.62	361.03	354.42	282.22	314.18
15	237.59	161.33	379.32	318.74	473.31	420.58	736.74	420.02	528.73	722.92	366.57	408.31	379.73	366.57	298.84	330.07
16	244.23	169.01	392.51	331.75	492.70	434.30	763.39	434.10	554.41	750.81	379.79	415.93	402.62	379.79	311.37	349.02
17	252.86	174.41	404.35	344.73	512.12	453.58	793.45	444.02	576.88	780.35	391.96	427.06	416.59	391.96	322.92	361.82
18	260.03	182.74	416.20	357.77	531.54	469.75	818.96	458.79	594.92	805.19	400.32	446.41	439.18	400.32	330.52	379.18
19	267.49	184.17	428.04	370.78	563.60	487.14	854.10	469.92	616.89	835.11	413.02	463.45	457.67	413.02	342.63	393.16
20	275.70	188.01	438.32	383.79	570.36	500.20	874.57	484.14	635.30	849.93	425.26	476.51	478.02	425.26	354.82	408.50

*The Letter rate applies only to documents, correspondence and electronic media shipments of no commercial value that do not exceed eight ounces sent in a UPS Express[®] Envelope.

Note: For additional information, refer to page 26.

Import

UPS Worldwide Saver®

Non-document

Zones	491	494	451	452	453	454	455	456	457	458	459	461	462	463	470	471
21 Lbs.	\$280.92	\$193.33	\$443.00	\$396.75	\$603.35	\$500.56	\$876.12	\$490.40	\$665.53	\$880.63	\$431.33	\$477.84	\$488.76	\$431.33	\$371.73	\$415.25
22	287.83	197.26	449.31	406.89	609.19	501.53	877.79	490.64	675.69	910.81	433.92	482.07	492.00	438.78	380.59	416.73
23	294.64	197.66	449.56	407.90	622.98	508.95	879.53	493.49	691.86	911.38	434.74	482.30	501.23	452.66	381.44	423.33
24	298.62	197.90	449.80	408.15	624.36	513.01	880.08	498.82	708.03	911.91	434.97	482.83	504.66	463.11	390.47	439.50
25	300.23	199.35	452.68	410.40	627.20	526.99	886.50	502.14	710.15	920.89	439.91	486.78	516.15	470.65	391.45	441.85
26	312.90	223.14	507.99	453.70	683.79	609.24	1,019.16	547.17	752.30	1,001.55	487.82	553.79	581.75	489.94	422.41	465.66
27	318.12	233.66	521.46	472.13	702.44	635.01	1,041.45	582.15	759.25	1,027.93	502.32	573.98	597.77	502.78	440.20	491.79
28	325.03	239.87	533.05	484.60	737.69	651.28	1,063.72	595.61	793.98	1,045.31	512.74	586.47	612.89	515.42	451.36	503.77
29	331.17	246.10	542.65	497.03	756.68	668.50	1,096.64	612.11	807.62	1,071.97	524.26	599.04	634.25	526.80	462.26	515.78
30	337.58	247.61	554.18	509.50	758.58	685.71	1,117.84	624.84	812.24	1,097.07	535.23	611.57	645.07	537.87	472.08	527.10
31	343.85	255.15	565.67	520.83	770.84	694.63	1,135.41	635.87	836.84	1,114.24	548.63	624.09	660.16	548.63	481.49	537.75
32	349.93	260.77	575.13	532.17	801.25	711.67	1,162.33	652.67	862.91	1,115.98	560.48	636.60	672.73	560.48	491.98	549.09
33	354.99	262.85	582.49	533.97	806.57	732.37	1,182.59	668.48	868.44	1,150.33	570.68	649.14	682.86	570.68	496.00	558.01
34	360.11	267.93	591.92	554.19	808.15	743.72	1,197.27	674.28	869.69	1,181.68	582.33	661.68	703.16	582.33	514.53	569.44
35	365.17	275.82	602.65	558.83	839.46	760.71	1,219.49	687.18	894.36	1,203.57	588.44	670.51	728.54	588.44	516.67	578.62
36	370.26	280.47	612.84	577.48	848.81	783.91	1,241.76	700.15	902.02	1,225.60	596.77	686.75	740.54	596.77	538.24	591.57
37	376.17	286.22	622.44	588.82	849.77	799.00	1,271.01	713.04	918.17	1,238.19	607.21	699.58	742.02	607.21	548.73	603.05
38	376.76	291.57	631.94	599.74	868.50	816.60	1,286.27	727.38	934.35	1,258.86	625.26	713.19	755.91	625.26	557.23	613.04
39	385.49	296.78	641.37	603.65	870.39	832.38	1,315.76	740.33	955.63	1,276.31	633.98	724.30	776.08	633.98	559.84	623.55
40	390.55	301.84	650.83	611.87	882.84	848.72	1,337.24	757.84	966.23	1,307.76	643.36	736.82	783.42	643.36	566.96	634.33
41	395.17	304.63	660.08	636.09	914.52	864.92	1,358.74	771.00	986.86	1,329.66	657.85	745.94	800.51	657.85	587.88	644.73
42	399.81	312.25	669.28	644.98	925.99	881.42	1,380.37	784.14	997.32	1,355.41	661.15	758.40	811.33	661.15	599.98	655.51
43	407.80	317.59	678.48	645.91	934.01	909.66	1,402.82	797.16	1,009.11	1,360.71	685.11	770.84	825.09	685.11	600.14	666.31
44	409.13	322.64	687.68	664.33	934.81	920.47	1,420.16	811.40	1,019.40	1,379.93	712.32	779.70	838.99	712.32	616.25	676.41
45	413.81	328.40	696.95	666.18	938.78	937.64	1,445.38	815.93	1,031.21	1,407.50	722.86	784.69	872.90	722.86	617.57	686.66
46	418.46	333.33	706.16	677.08	968.22	953.98	1,474.15	837.83	1,051.04	1,454.42	727.48	803.75	882.51	727.48	629.31	695.85
47	423.13	338.67	712.77	700.27	974.57	971.29	1,502.54	841.59	1,062.81	1,459.12	731.25	815.40	883.60	731.25	651.60	705.69
48	427.77	339.90	724.59	702.59	975.91	982.20	1,523.57	854.44	1,074.08	1,461.29	737.24	826.12	905.90	737.24	653.57	717.01
49	429.98	347.72	725.76	722.39	1,002.65	999.70	1,546.75	867.27	1,084.54	1,504.64	745.34	837.08	912.17	745.34	662.76	725.78
50	430.55	352.52	726.94	729.55	1,005.33	1,016.22	1,566.57	880.10	1,096.18	1,574.85	758.36	848.56	921.28	758.36	663.90	736.82
52	448.27	362.01	765.32	754.42	1,037.03	1,049.57	1,594.38	905.46	1,126.59	1,578.82	784.47	894.81	967.46	784.47	689.20	752.61
54	449.46	373.76	781.04	775.44	1,059.44	1,083.84	1,639.05	930.90	1,153.64	1,675.49	813.84	912.25	1,006.18	813.84	708.63	773.38
56	462.34	385.49	799.53	796.40	1,071.84	1,116.32	1,695.77	961.72	1,180.33	1,690.86	836.87	937.30	1,030.76	836.87	739.82	794.01
58	475.20	397.20	818.02	817.35	1,084.24	1,148.26	1,746.86	987.74	1,205.37	1,692.87	845.37	962.35	1,051.46	845.37	758.52	814.78
60	476.49	408.85	836.41	838.39	1,128.24	1,180.24	1,763.57	1,007.06	1,230.04	1,702.91	887.91	974.55	1,108.75	887.91	778.04	835.03

Note: For additional information, refer to page 26.

Import

UPS Worldwide Saver®

Non-document

Zones	491	494	451	452	453	454	455	456	457	458	459	461	462	463	470	471
62 Lbs.	\$493.81	\$421.66	\$861.97	\$848.86	\$1,132.33	\$1,212.19	\$1,807.79	\$1,035.71	\$1,255.08	\$1,763.07	\$920.18	\$998.69	\$1,143.16	\$920.18	\$783.37	\$856.47
64	502.83	440.61	874.46	888.03	1,149.93	1,248.98	1,877.14	1,059.23	1,281.75	1,823.24	943.39	1,046.51	1,167.53	943.39	817.17	877.64
66	511.89	447.70	900.22	893.63	1,198.49	1,278.02	1,894.88	1,077.11	1,306.16	1,871.07	963.90	1,053.58	1,190.31	963.90	819.72	883.45
68	514.90	464.68	909.40	909.62	1,202.09	1,306.37	1,954.02	1,104.79	1,331.16	1,873.65	971.75	1,087.67	1,246.25	971.75	835.29	900.68
70	526.45	478.09	926.92	929.90	1,232.86	1,331.60	2,012.37	1,134.88	1,356.10	1,914.22	1,030.00	1,122.29	1,275.63	1,030.00	854.84	939.14
72	540.18	490.95	961.67	961.37	1,236.58	1,366.16	2,022.10	1,166.31	1,382.49	1,975.73	1,041.31	1,149.68	1,298.00	1,041.31	889.80	978.51
74	550.66	502.74	968.73	970.50	1,282.91	1,399.49	2,119.76	1,196.11	1,405.53	2,020.63	1,062.06	1,173.05	1,332.12	1,062.06	893.16	997.14
76	561.14	515.20	976.09	1,002.39	1,298.88	1,432.38	2,138.46	1,201.71	1,445.06	2,063.53	1,087.85	1,214.29	1,372.12	1,087.85	928.26	1,002.52
78	571.85	524.45	1,001.61	1,022.22	1,301.59	1,464.91	2,199.91	1,218.50	1,458.45	2,164.28	1,089.82	1,256.54	1,403.78	1,089.82	937.77	1,010.78
80	572.47	537.26	1,015.49	1,049.84	1,348.65	1,497.25	2,251.76	1,249.11	1,483.77	2,192.12	1,154.39	1,274.09	1,434.93	1,154.39	966.85	1,031.95
82	586.06	554.50	1,035.69	1,063.36	1,358.76	1,530.45	2,258.75	1,262.26	1,509.48	2,229.07	1,171.41	1,293.18	1,466.64	1,171.41	986.07	1,052.57
84	597.44	564.30	1,052.15	1,075.52	1,384.59	1,561.30	2,317.34	1,275.57	1,534.82	2,293.95	1,199.25	1,307.28	1,468.80	1,199.25	1,004.75	1,072.55
86	608.36	578.88	1,064.71	1,094.02	1,397.03	1,600.68	2,319.38	1,288.57	1,561.61	2,339.59	1,219.52	1,333.22	1,509.57	1,219.52	1,023.90	1,093.20
88	619.59	585.60	1,090.86	1,114.85	1,416.18	1,613.08	2,359.05	1,295.62	1,587.06	2,358.35	1,235.17	1,333.79	1,530.98	1,235.17	1,042.44	1,113.54
90	630.39	594.03	1,112.20	1,115.91	1,418.11	1,628.37	2,415.92	1,308.71	1,612.65	2,421.05	1,250.10	1,369.84	1,577.58	1,250.10	1,043.75	1,130.14
92	641.65	605.90	1,127.87	1,122.91	1,418.69	1,637.68	2,445.39	1,347.20	1,614.14	2,431.58	1,289.16	1,381.24	1,597.76	1,289.16	1,053.87	1,146.05
94	651.81	607.97	1,134.55	1,136.17	1,419.36	1,647.54	2,447.91	1,360.53	1,650.46	2,436.52	1,305.72	1,404.69	1,607.64	1,305.72	1,071.73	1,163.33
96	662.84	627.72	1,148.42	1,155.72	1,424.14	1,657.68	2,497.38	1,373.98	1,683.65	2,544.24	1,309.05	1,415.55	1,629.45	1,309.05	1,080.65	1,184.21
98	673.38	633.51	1,170.09	1,160.96	1,426.28	1,659.97	2,563.93	1,375.56	1,705.05	2,550.53	1,341.07	1,417.04	1,647.06	1,341.07	1,104.96	1,203.22
100	683.56	662.61	1,202.46	1,257.41	1,493.63	1,676.42	2,613.20	1,408.08	1,739.68	2,555.25	1,370.63	1,495.46	1,672.73	1,370.63	1,126.15	1,222.80
105	713.74	703.76	1,262.61	1,320.27	1,568.90	1,760.01	2,743.87	1,469.52	1,830.65	2,682.20	1,441.16	1,570.70	1,741.22	1,441.16	1,206.19	1,273.32
110	744.31	737.27	1,322.73	1,383.16	1,641.93	1,841.18	2,874.53	1,539.37	1,915.19	2,807.25	1,494.82	1,641.38	1,821.52	1,494.82	1,291.47	1,323.02
115	775.79	770.78	1,382.85	1,446.02	1,716.01	1,924.38	3,005.19	1,608.22	1,980.93	2,932.44	1,574.53	1,714.39	1,894.47	1,574.53	1,347.48	1,379.17
120	806.04	801.76	1,442.97	1,508.89	1,786.68	1,992.36	3,135.85	1,677.38	2,047.24	3,057.10	1,626.92	1,797.91	1,966.77	1,626.92	1,405.64	1,438.45
125	835.92	829.53	1,503.10	1,571.76	1,858.40	2,074.90	3,266.50	1,744.83	2,114.07	3,183.62	1,693.33	1,885.09	2,049.23	1,693.33	1,459.08	1,493.43
130	865.97	859.26	1,563.22	1,634.63	1,941.94	2,147.08	3,397.17	1,814.28	2,179.95	3,309.63	1,756.16	1,954.19	2,113.17	1,756.16	1,514.00	1,546.61
135	896.82	890.60	1,623.34	1,697.50	2,011.55	2,226.09	3,527.83	1,883.01	2,245.02	3,436.17	1,815.46	2,025.92	2,176.43	1,815.46	1,567.74	1,601.45
140	926.12	923.18	1,683.46	1,760.37	2,079.86	2,306.01	3,658.49	1,952.29	2,328.79	3,561.61	1,878.89	2,090.75	2,239.53	1,878.89	1,625.48	1,657.32
145	956.63	955.89	1,743.58	1,823.25	2,150.66	2,386.65	3,789.15	2,022.27	2,394.38	3,687.08	1,944.63	2,155.72	2,311.47	1,944.63	1,680.15	1,711.08
150	986.52	982.95	1,803.69	1,886.11	2,220.03	2,465.63	3,919.80	2,092.54	2,460.22	3,809.45	2,009.15	2,229.22	2,387.59	2,009.15	1,730.37	1,767.50

Shipments of More Than 150 Pounds

Zones	491	494	451	452	453	454	455	456	457	458	459	461	462	463	470	471
Price Per Pound	\$6.58	\$6.56	\$12.03	\$12.58	\$14.81	\$16.44	\$26.14	\$13.96	\$16.41	\$25.40	\$13.40	\$14.87	\$15.92	\$13.40	\$11.54	\$11.79
Minimum Rate	986.52	982.95	1,803.69	1,886.11	2,220.03	2,465.63	3,919.80	2,092.54	2,460.22	3,809.45	2,009.15	2,229.22	2,387.59	2,009.15	1,730.37	1,767.50

Note: For additional information, refer to page 26.

Import

UPS Worldwide Expedited®

Guaranteed delivery by end of business day from more than 80 countries and territories. Delivery is guaranteed in two business days from Canada, two to three business days from Mexico and four to five business days from Asia, Europe and Latin America. Rates include door-to-door delivery with routine, in-house customs clearance by UPS Supply Chain Solutions®

Zones	61	64	651/681	652/682	653/683	654/684	655/685	656/686	657/687	658/688	659/689	661/691	662/692	663/693	670	671
1 Lbs.	\$81.22	\$59.86	\$143.41	\$92.12	\$162.47	\$108.77	\$140.28	\$112.22	\$140.85	\$171.91	\$112.30	\$110.82	\$103.84	\$115.77	\$87.17	\$93.56
2	91.70	67.35	163.03	110.36	185.47	128.63	176.88	135.00	172.36	205.99	132.98	128.97	119.58	132.98	103.76	114.10
3	102.40	75.05	179.13	123.18	204.71	148.52	208.88	157.20	198.66	239.54	150.61	145.48	135.87	150.61	116.96	126.44
4	111.90	81.98	200.91	137.19	227.99	171.63	236.99	183.14	229.76	276.49	163.04	162.06	151.85	163.04	128.87	144.35
5	120.70	88.78	217.00	150.13	250.37	187.52	264.38	201.93	252.92	329.78	181.37	175.53	166.89	181.37	142.19	158.45
6	130.16	96.19	232.29	163.70	270.34	213.75	291.15	228.01	273.90	366.72	187.50	193.41	186.99	187.50	154.93	170.97
7	138.56	99.58	245.28	175.09	285.94	229.28	312.60	250.83	294.80	383.86	211.44	213.31	204.03	211.44	168.94	186.92
8	146.86	105.91	258.06	187.16	304.31	246.67	335.76	265.31	317.29	437.07	227.88	223.32	221.49	227.88	181.31	200.50
9	155.59	109.18	270.38	196.60	324.82	263.25	355.77	285.08	338.35	506.08	240.07	240.30	238.94	240.07	190.40	215.16
10	164.02	119.83	282.14	210.70	344.88	279.86	384.52	310.72	361.02	553.48	255.40	252.61	255.67	255.40	204.34	227.80
11	169.62	120.50	295.60	220.13	364.09	295.19	398.01	319.83	379.54	562.79	270.83	259.10	272.83	270.83	213.19	238.54
12	174.05	127.45	305.22	229.12	367.32	306.67	430.51	325.07	399.47	566.04	285.97	273.05	274.35	285.97	224.63	242.97
13	180.11	132.34	319.21	244.96	402.16	330.60	455.53	349.75	421.70	627.23	298.80	286.60	304.36	298.80	235.76	260.40
14	185.03	138.86	331.05	254.04	419.04	345.87	481.04	371.68	442.09	627.73	310.99	296.62	320.66	310.99	246.06	275.87
15	189.86	140.24	340.99	267.49	442.55	356.59	496.70	386.96	461.65	686.24	323.67	305.18	337.31	323.67	259.60	289.83
16	194.00	146.21	353.58	278.79	460.45	369.30	519.90	387.52	483.95	741.07	336.21	321.58	355.65	336.21	270.45	304.71
17	197.97	150.44	363.58	286.74	478.43	402.29	541.46	401.28	503.50	758.90	346.08	331.07	369.60	346.08	277.14	316.35
18	203.76	159.25	374.95	303.24	489.58	407.75	561.71	412.27	522.74	783.31	355.90	341.72	386.18	355.90	291.84	325.81
19	205.74	163.33	385.57	311.37	516.01	426.95	581.79	435.69	537.59	791.35	363.65	361.13	402.87	363.65	302.06	345.22
20	209.48	168.51	394.90	319.43	535.98	438.62	603.64	444.60	557.12	791.85	373.40	365.77	419.08	373.40	308.66	358.70
21	214.38	172.91	405.86	330.30	551.08	453.95	622.42	457.32	584.13	793.72	381.71	369.80	441.48	381.71	317.08	370.63
22	220.76	177.68	416.40	344.31	567.55	469.25	651.05	477.61	603.44	806.88	391.40	389.46	457.51	391.40	332.95	381.73
23	226.52	180.58	425.29	353.53	591.51	488.26	674.96	487.46	613.39	858.37	414.23	408.89	475.77	414.23	341.47	390.92
24	229.82	187.24	437.20	366.84	603.33	499.72	684.60	489.19	637.22	883.31	422.56	409.39	486.48	422.56	352.69	400.90
25	231.24	193.38	446.65	372.41	605.80	513.69	688.48	492.73	652.54	893.93	426.24	415.43	501.98	432.24	363.44	403.96
26	235.40	200.57	456.33	388.95	639.79	535.82	702.59	518.86	676.87	920.59	436.13	430.55	516.52	437.81	373.50	423.50
27	239.56	207.16	468.39	400.35	658.20	543.36	719.27	522.95	694.70	958.11	446.01	445.53	530.88	452.55	382.37	430.77
28	247.03	211.58	478.77	410.64	678.18	558.16	737.20	551.21	711.92	958.61	449.80	459.16	542.50	465.11	392.07	441.27
29	247.78	214.09	486.46	417.85	695.56	573.38	754.48	557.78	726.88	959.11	459.52	460.02	556.77	477.36	401.53	451.80
30	251.92	219.97	496.77	423.42	716.34	587.81	769.98	572.26	736.66	968.01	473.76	461.51	573.20	488.49	409.95	461.72
31	256.66	225.44	508.04	437.30	729.66	602.59	788.54	591.13	756.96	987.44	480.27	473.09	587.84	498.83	418.23	471.04
32	259.52	230.27	516.54	451.23	741.72	624.55	810.84	593.03	768.81	987.94	500.92	487.25	598.54	506.17	427.35	480.97
33	263.31	232.59	523.14	460.48	753.35	630.86	824.13	608.14	780.06	1,010.46	507.01	499.64	611.46	514.08	438.56	488.76
34	270.65	236.25	531.58	470.10	771.36	647.05	836.33	616.09	790.11	1,085.91	507.89	503.11	629.86	520.90	447.42	498.81
35	271.40	240.71	541.22	480.98	772.99	671.88	858.70	627.70	799.53	1,108.02	520.07	518.57	647.33	528.96	454.67	506.83

Note: For additional information, refer to page 26.

Import

UPS Worldwide Expedited®

Zones	61	64	651/681	652/682	653/683	654/684	655/685	656/686	657/687	658/688	659/689	661/691	662/692	663/693	670	671
36 Lbs.	\$274.67	\$247.48	\$550.39	\$491.04	\$786.15	\$688.73	\$863.33	\$645.11	\$808.87	\$1,112.26	\$524.27	\$533.53	\$649.17	\$536.52	\$467.53	\$518.19
37	279.62	252.97	559.10	499.49	799.02	707.94	877.62	657.20	817.86	1,128.02	538.58	542.08	666.58	546.82	476.63	528.22
38	282.26	257.39	567.60	511.22	804.93	716.23	891.28	675.10	828.16	1,140.58	547.85	563.86	673.38	555.08	484.34	536.96
39	289.14	263.57	576.10	520.88	821.17	721.10	904.97	678.12	837.64	1,149.21	559.33	574.45	689.37	563.05	492.65	546.18
40	289.84	265.60	584.60	530.12	837.45	754.08	918.42	689.75	846.91	1,157.70	560.99	574.95	695.91	572.56	501.29	555.64
41	293.97	270.02	592.07	539.00	856.02	765.40	939.99	706.47	859.94	1,177.09	570.92	594.31	709.12	580.26	511.46	564.71
42	303.80	274.80	598.42	545.47	867.29	768.36	958.94	719.61	863.34	1,197.62	586.40	604.74	720.21	586.40	521.14	574.18
43	305.98	279.94	606.93	558.00	875.08	780.34	969.31	723.29	875.70	1,217.80	606.98	605.24	732.77	606.98	529.44	583.62
44	306.54	283.61	619.13	568.24	885.73	793.17	975.38	724.44	884.79	1,240.96	617.57	605.74	747.26	617.57	537.51	584.12
45	310.42	286.74	621.76	574.03	893.16	794.69	987.32	747.01	893.90	1,272.19	618.81	609.64	763.66	618.81	546.04	601.47
46	314.54	291.88	635.17	578.24	900.25	824.81	1,008.11	768.72	906.66	1,282.42	641.29	616.75	773.44	641.29	550.54	609.51
47	319.27	297.67	640.59	589.84	908.84	842.71	1,022.32	770.91	914.43	1,301.88	645.85	630.04	783.34	645.85	559.39	618.12
48	327.25	302.64	648.20	607.93	909.73	844.52	1,037.90	782.72	923.89	1,319.29	646.42	643.32	798.33	646.42	574.78	628.06
49	328.06	308.42	654.27	612.02	915.96	852.82	1,049.35	794.07	933.12	1,332.20	656.79	643.87	807.21	656.79	582.34	635.73
50	332.77	313.43	658.85	612.52	923.79	884.01	1,058.90	821.77	946.25	1,364.67	666.52	650.64	815.93	666.52	582.84	645.43
52	341.06	325.42	678.64	639.85	941.07	911.92	1,071.29	835.57	968.80	1,370.75	687.56	671.54	858.35	687.56	607.38	659.24
54	348.15	335.22	686.64	660.97	975.10	925.50	1,081.87	836.67	988.43	1,383.99	716.17	702.01	890.42	716.17	625.70	677.43
56	356.03	347.68	701.51	675.83	991.19	964.08	1,090.96	868.10	993.89	1,421.39	733.76	719.75	918.01	733.76	642.64	695.50
58	363.92	358.95	716.38	692.06	999.07	1,002.66	1,123.25	899.51	1,004.38	1,458.85	751.37	740.92	942.33	751.37	658.87	713.71
60	375.19	370.77	736.28	715.37	1,022.26	1,037.22	1,134.15	925.26	1,030.93	1,617.22	777.99	753.39	974.66	777.99	675.82	731.43
62	384.26	382.61	755.89	727.98	1,040.55	1,066.61	1,157.96	950.84	1,065.93	1,638.03	787.14	791.11	999.26	787.14	688.51	748.88
64	393.25	394.40	766.84	752.89	1,066.23	1,100.59	1,170.06	980.49	1,080.43	1,710.61	823.87	808.23	1,015.39	823.87	706.98	761.38
66	401.48	405.13	788.17	769.27	1,091.05	1,129.86	1,181.20	1,002.59	1,095.29	1,714.02	856.90	837.07	1,035.04	856.90	721.36	773.84
68	416.96	417.66	796.02	784.57	1,121.54	1,130.45	1,194.64	1,012.20	1,118.13	1,714.52	862.18	847.53	1,066.21	862.18	738.54	790.73
70	425.99	429.26	811.93	802.21	1,132.84	1,131.47	1,206.49	1,054.57	1,129.33	1,715.02	896.50	874.22	1,094.70	896.50	755.84	822.63
72	435.90	439.45	829.58	802.71	1,164.44	1,208.19	1,218.45	1,078.38	1,136.06	1,742.78	908.82	891.23	1,099.13	908.82	756.34	846.26
74	438.90	449.45	846.43	837.51	1,170.34	1,221.35	1,231.81	1,083.21	1,151.92	1,781.62	919.99	904.26	1,124.59	919.99	789.71	869.61
76	445.90	461.62	862.23	838.01	1,171.21	1,234.07	1,243.96	1,083.79	1,152.56	1,784.23	966.66	928.81	1,154.32	966.66	790.21	878.15
78	456.14	472.56	873.50	858.85	1,194.01	1,266.62	1,256.49	1,084.36	1,173.82	1,842.24	988.93	945.88	1,179.81	988.93	807.61	885.37
80	457.42	482.92	887.00	865.02	1,225.05	1,297.62	1,268.58	1,087.51	1,195.24	1,897.89	1,010.12	987.24	1,206.71	1,010.12	816.41	903.91

Note: For additional information, refer to page 26.

Import

UPS Worldwide Expedited®

Zones	61	64	651/681	652/682	653/683	654/684	655/685	656/686	657/687	658/688	659/689	661/691	662/692	663/693	670	671
82 Lbs.	\$465.09	\$495.03	\$901.53	\$880.11	\$1,233.26	\$1,329.97	\$1,281.32	\$1,098.21	\$1,206.74	\$1,916.03	\$1,023.29	\$1,010.28	\$1,236.31	\$1,023.29	\$832.64	\$921.99
84	475.92	496.11	908.89	887.36	1,234.01	1,361.67	1,294.00	1,119.71	1,218.20	1,921.32	1,033.85	1,026.28	1,242.30	1,033.85	849.33	939.47
86	479.72	502.19	927.72	928.12	1,242.57	1,393.60	1,306.35	1,142.62	1,229.58	1,950.86	1,058.42	1,050.19	1,271.20	1,058.42	889.72	957.55
88	487.38	503.67	935.34	944.87	1,250.95	1,414.55	1,318.84	1,146.84	1,241.14	1,995.29	1,084.36	1,066.01	1,291.15	1,084.36	906.27	975.39
90	495.33	528.09	939.70	945.37	1,254.47	1,433.72	1,331.96	1,173.67	1,252.26	2,022.56	1,100.91	1,072.61	1,319.40	1,100.91	906.77	989.92
92	498.13	528.64	954.71	947.69	1,257.95	1,434.28	1,344.17	1,174.35	1,262.91	2,066.57	1,101.46	1,085.66	1,341.38	1,101.46	913.93	1,003.81
94	505.05	547.50	967.35	952.62	1,265.75	1,434.84	1,356.11	1,195.13	1,274.28	2,108.51	1,114.51	1,108.76	1,360.91	1,114.51	916.12	1,018.55
96	513.89	557.87	969.04	969.46	1,269.38	1,435.34	1,368.05	1,221.93	1,285.57	2,132.33	1,123.26	1,131.81	1,386.88	1,123.26	931.24	1,030.16
98	531.65	560.01	978.76	971.33	1,270.38	1,435.84	1,394.22	1,223.87	1,294.66	2,175.36	1,136.02	1,158.62	1,413.80	1,136.02	931.74	1,043.71
100	533.29	563.87	992.20	1,017.25	1,281.56	1,454.46	1,407.37	1,248.06	1,307.05	2,413.38	1,145.96	1,171.45	1,440.33	1,145.96	957.92	1,063.50
105	559.96	593.20	1,041.83	1,072.20	1,336.55	1,504.11	1,472.16	1,310.46	1,345.22	2,534.06	1,187.88	1,223.51	1,519.35	1,187.88	1,018.30	1,098.80
110	586.62	621.23	1,090.55	1,121.23	1,406.29	1,571.31	1,503.12	1,372.88	1,371.77	2,654.40	1,240.41	1,272.49	1,582.83	1,240.41	1,051.84	1,134.99
115	613.29	648.88	1,128.43	1,170.21	1,464.48	1,642.74	1,545.02	1,435.27	1,410.21	2,774.50	1,296.79	1,327.57	1,651.66	1,296.79	1,089.34	1,175.93
120	639.96	675.47	1,160.52	1,220.28	1,522.57	1,714.16	1,588.92	1,497.68	1,437.17	2,892.42	1,353.17	1,361.77	1,716.37	1,353.17	1,146.21	1,219.25
125	666.60	703.64	1,220.72	1,270.74	1,582.98	1,785.57	1,631.63	1,560.08	1,462.85	3,012.90	1,407.81	1,390.81	1,786.97	1,407.81	1,191.88	1,260.57
130	693.27	734.52	1,273.00	1,320.79	1,651.17	1,857.00	1,674.36	1,622.47	1,502.91	3,130.44	1,439.18	1,419.28	1,822.56	1,439.18	1,238.84	1,300.02
135	719.94	760.67	1,316.63	1,371.57	1,695.77	1,928.42	1,703.20	1,684.88	1,528.53	3,250.86	1,468.85	1,448.53	1,878.66	1,468.85	1,285.20	1,345.58
140	746.16	790.21	1,344.74	1,423.37	1,724.57	1,981.27	1,735.95	1,747.28	1,568.83	3,367.92	1,471.74	1,451.39	1,941.02	1,471.74	1,319.67	1,382.32
145	772.75	817.57	1,380.47	1,475.22	1,775.31	2,025.28	1,765.23	1,809.69	1,619.69	3,488.26	1,500.93	1,480.22	1,980.55	1,500.93	1,349.79	1,412.99
150	799.26	843.77	1,418.11	1,526.13	1,803.57	2,071.29	1,796.01	1,872.09	1,647.75	3,601.69	1,528.48	1,508.64	2,047.24	1,528.48	1,379.94	1,444.25

Shipments of More Than 150 Pounds

Zones	61	64	651/681	652/682	653/683	654/684	655/685	656/686	657/687	658/688	659/689	661/691	662/692	663/693	670	671
Price Per Pound	\$5.33	\$5.63	\$9.46	\$10.18	\$12.03	\$13.81	\$11.98	\$12.49	\$10.99	\$24.02	\$10.19	\$10.06	\$13.65	\$10.19	\$9.20	\$9.63
Minimum Rate	799.26	843.77	1,418.11	1,526.13	1,803.57	2,071.29	1,796.01	1,872.09	1,647.75	3,601.69	1,528.48	1,508.64	2,047.24	1,528.48	1,379.94	1,444.25

Note: For additional information, refer to page 26.

Import

UPS 3 Day Select® from Canada

Guaranteed delivery by the end of the third business day to the 48 contiguous states from all Canadian provinces. Rates include door-to-door delivery with routine, in-house customs clearance by UPS Supply Chain Solutions®

Zones	475	476	477
1 Lbs.	\$49.58	\$49.79	\$51.25
2	53.30	54.31	56.54
3	56.87	58.94	61.59
4	59.84	63.39	66.90
5	63.32	68.15	71.57
6	67.00	72.78	76.87
7	69.94	77.41	82.10
8	73.60	81.73	87.26
9	77.00	86.25	92.39
10	80.51	90.53	97.02
11	83.76	94.09	101.35
12	86.81	97.59	105.55
13	90.29	100.88	109.45
14	93.42	104.31	113.43
15	96.84	107.38	116.90
16	100.09	110.39	120.58
17	103.07	113.63	123.99
18	106.22	116.82	127.66
19	109.20	119.52	131.03
20	112.26	122.30	134.38
21	115.21	124.53	137.02
22	117.91	126.74	139.14
23	122.90	128.77	141.47
24	125.45	131.05	143.32
25	128.27	133.05	145.44
26	130.91	135.27	147.31
27	134.84	137.43	149.35
28	137.49	139.41	151.38
29	139.96	141.47	153.33
30	142.51	143.81	155.53
31	144.83	145.67	160.71
32	147.07	147.71	162.98
33	149.57	149.75	165.09
34	151.42	151.87	167.22
35	152.63	153.84	172.07

Zones	475	476	477
36 Lbs.	\$154.95	\$155.96	\$174.36
37	156.62	158.19	175.63
38	157.88	160.16	178.47
39	159.55	162.32	180.54
40	161.83	164.82	182.84
41	162.87	167.23	184.96
42	165.30	169.29	187.15
43	166.72	171.27	189.19
44	168.46	173.69	190.58
45	170.25	175.31	193.38
46	171.27	177.49	195.23
47	173.06	179.55	197.36
48	175.53	181.40	199.75
49	176.65	183.47	201.73
50	178.92	185.14	203.98
52	182.60	189.67	207.95
54	183.58	193.78	212.15
56	188.87	197.94	216.74
58	192.47	202.05	220.86
60	196.92	205.43	225.35
62	199.93	210.56	229.58
64	203.50	214.55	233.91
66	207.04	218.88	238.13
68	211.29	222.99	242.31
70	214.97	226.97	246.72
72	218.66	231.13	251.16
74	222.21	235.24	255.08
76	225.81	239.16	259.63
78	229.27	243.31	263.68
80	233.01	247.55	270.45
82	236.34	251.53	272.35
84	240.00	255.55	276.54
86	242.80	259.86	280.56
88	247.00	263.78	284.63
90	250.72	267.81	288.78

Zones	475	476	477
92 Lbs.	\$254.25	\$271.98	\$292.91
94	257.67	276.15	297.09
96	261.07	280.02	301.18
98	264.59	284.56	305.05
100	268.22	288.72	309.10
105	277.49	298.77	325.75
110	286.68	309.21	341.83
115	295.92	319.77	357.88
120	305.03	330.10	373.69
125	313.01	340.48	389.67
130	322.03	350.73	405.49
135	332.31	361.11	421.63
140	341.43	371.44	437.35
145	350.55	381.82	453.37
150	360.04	392.38	469.40

Shipments of More Than 150 Pounds

Zones	475	476	477
Price Per Pound	\$2.41	\$2.62	\$3.13
Minimum Rate	360.04	392.38	469.40

Note: For additional information, refer to page [26](#).

Import

UPS® Standard from Canada*

Guaranteed delivery by end of day to the 48 contiguous states within two to seven business days from all Canadian provinces. Rates include door-to-door delivery. Customs clearance is not included. See pages 135-136 for U.S. Entry Preparation rates. UPS will provide Customs Brokerage Services by UPS Supply Chain Solutions® unless a different broker is specified. Charges will be billed to the importer unless otherwise indicated by the shipper. Saturday Delivery available in select areas.

Zones	376	378	380
1 Lbs.	\$26.20	\$26.67	\$27.52
2	27.52	27.88	29.27
3	28.57	29.15	30.96
4	29.27	30.61	32.97
5	30.42	32.00	34.41
6	31.28	32.59	36.11
7	32.13	33.57	37.81
8	33.14	35.02	39.57
9	33.82	36.42	41.26
10	34.90	37.76	43.08
11	35.01	38.53	44.17
12	35.68	39.98	45.92
13	36.24	41.45	47.49
14	36.59	42.66	49.20
15	37.01	43.98	50.88
16	37.91	45.08	52.34
17	38.92	46.22	54.16
18	39.98	47.44	55.61
19	40.69	48.59	57.36
20	41.31	49.50	59.12
21	43.47	52.14	62.11
22	43.96	52.82	63.66
23	45.01	54.25	65.33
24	45.71	55.17	66.88
25	46.50	56.24	68.61
26	47.38	57.30	70.34
27	48.19	58.59	71.89
28	50.18	60.59	74.76
29	50.28	60.90	75.29
30	51.47	62.48	77.35

Zones	376	378	380
31 Lbs.	\$52.21	\$62.94	\$79.06
32	53.47	64.19	80.77
33	54.15	65.30	82.44
34	55.88	67.12	84.99
35	56.30	67.30	85.72
36	57.24	68.66	87.59
37	58.24	70.35	89.03
38	59.30	71.97	90.83
39	60.70	74.40	93.51
40	61.23	75.19	94.18
41	62.26	76.69	95.87
42	64.26	79.55	99.42
43	64.87	80.67	100.29
44	65.30	81.42	100.97
45	66.69	83.87	103.17
46	67.16	84.40	104.19
47	67.98	85.90	105.63
48	69.77	88.43	108.51
49	70.03	88.88	108.81
50	71.14	90.30	109.94
52	73.26	93.47	113.53
54	75.44	96.83	117.11
56	77.73	99.80	120.72
58	79.89	102.86	124.12
60	82.13	105.92	127.41
62	84.30	108.76	130.81
64	86.67	111.70	134.10
66	88.89	114.42	137.76
68	92.54	119.52	143.89
70	94.85	122.13	146.92

*Visit [ups.com/holidays](https://www.ups.com/holidays) for time in transit changes effective during the holiday season.

Notes:

- For additional information, refer to pages 26 and 94.
- For a multiple-package shipment, the minimum charge will be based on an average weight of 15 pounds per package.

Import

UPS® Standard from Canada*

Zones	376	378	380
72 Lbs.	\$96.95	\$125.05	\$150.64
74	98.63	126.93	153.39
76	100.81	129.66	157.19
78	102.96	132.82	161.17
80	103.78	133.94	162.67
82	105.09	135.94	165.40
84	108.74	140.79	171.37
86	109.05	141.11	172.24
88	112.47	144.45	176.83
90	112.96	146.13	179.07
92	114.77	148.38	182.64
94	116.89	150.43	186.05
96	119.29	152.72	189.34
98	122.47	157.44	195.86
100	122.58	157.51	196.03
105	125.31	159.86	201.26
110	128.91	162.73	206.18
115	132.21	165.57	211.07
120	135.49	168.25	216.12
125	138.55	170.98	221.20
130	141.60	173.78	226.13
135	144.75	176.98	231.10
140	147.62	179.67	236.24
145	150.78	182.45	241.03
150	153.59	185.14	246.09

Shipments of More Than 150 Pounds

Zones	376	378	380
Price Per Pound	\$1.02	\$1.23	\$1.64
Minimum Rate	153.59	185.14	246.09

*Visit [ups.com/holidays](https://www.ups.com/holidays) for time in transit changes effective during the holiday season.

Note: For additional information, refer to pages [26](#) and [94](#).

Import

UPS® Standard from Mexico*

Guaranteed delivery by end of day to the 48 contiguous states within three to seven business days from all of Mexico. Rates include routine, in-house customs clearance by UPS Supply Chain Solutions®. Saturday Delivery available in select areas.

Zones	362	363	364	365	366	367	368
1 Lbs.	\$45.54	\$45.89	\$46.26	\$47.06	\$47.56	\$47.90	\$48.43
2	51.76	52.34	52.57	53.90	54.47	54.87	55.16
3	57.87	58.33	58.55	59.76	59.99	60.57	61.21
4	63.33	63.73	64.02	65.45	66.03	67.19	68.04
5	69.78	70.19	70.45	71.47	74.15	74.61	74.99
6	75.47	75.82	76.25	77.51	80.26	80.83	81.15
7	78.82	79.39	79.66	79.77	83.63	84.21	85.09
8	81.27	81.73	82.17	83.52	86.14	89.82	91.00
9	84.30	84.84	85.26	86.73	89.29	92.80	95.48
10	86.12	86.47	86.95	88.31	90.94	94.42	97.13
11	88.64	89.04	89.42	90.82	93.40	96.95	99.64
12	90.74	91.09	91.46	92.80	95.43	99.05	101.68
13	92.72	93.07	93.61	94.86	97.48	101.03	103.67
14	95.06	95.64	96.19	97.24	100.05	103.32	106.31
15	97.86	98.51	98.94	100.10	103.49	107.00	110.33
16	99.62	100.37	100.75	102.14	105.95	109.87	113.25
17	102.03	103.07	103.32	104.95	108.98	112.89	116.75
18	103.70	104.94	105.25	107.22	111.39	115.64	119.68
19	105.80	107.45	107.88	109.87	114.42	118.74	123.07
20	107.11	108.96	109.59	111.79	116.34	120.91	125.46
21	107.64	109.50	109.98	112.33	116.94	121.45	126.16
22	109.32	111.43	111.96	114.54	119.40	124.12	129.20
23	111.71	113.82	114.42	117.16	122.19	127.03	132.25
24	114.36	116.68	117.23	120.26	125.51	130.49	135.98
25	116.74	119.03	119.61	122.77	128.33	133.35	139.32
26	118.55	120.90	122.00	125.15	130.95	136.03	142.40
27	120.84	123.11	124.23	127.67	133.87	139.08	145.68
28	122.99	125.57	126.80	130.32	136.63	142.05	148.96
29	125.69	128.20	129.55	133.11	139.79	145.27	152.58
30	127.45	130.02	130.78	134.40	141.36	146.91	154.55
31	128.26	130.88	132.76	136.50	143.81	149.47	157.49
32	129.96	132.23	134.16	137.90	145.50	151.23	159.29
33	131.00	133.94	135.79	139.95	147.43	153.33	161.69
34	133.28	136.43	138.43	142.64	150.23	156.38	165.13
35	135.98	139.30	141.36	145.73	153.63	159.76	168.71

*Visit [ups.com/holidays](https://www.ups.com/holidays) for time in transit changes effective during the holiday season.

Notes:

- For additional information, refer to pages [26](#) and [94](#).
- For a multiple-package shipment, the minimum charge will be based on an average weight of 15 pounds per package.

Import

UPS® Standard from Mexico*

Zones	362	363	364	365	366	367	368
36 Lbs.	\$136.48	\$139.80	\$141.86	\$146.23	\$154.13	\$160.26	\$169.21
37	140.97	144.32	146.45	150.75	158.35	164.27	172.34
38	143.62	147.07	149.24	153.28	161.23	166.98	175.05
39	146.16	149.54	151.56	155.86	163.60	169.46	177.52
40	148.23	151.39	153.56	157.81	165.61	171.30	179.59
41	150.87	154.15	156.26	160.39	168.25	174.24	182.23
42	153.80	157.26	159.30	163.56	171.24	177.17	185.28
43	155.99	159.44	161.60	165.75	173.72	179.42	187.87
44	158.00	160.36	162.52	166.77	174.76	180.50	188.72
45	158.53	161.63	163.79	168.09	175.90	181.76	189.99
46	160.08	163.36	165.56	169.70	177.64	183.62	191.79
47	160.61	163.89	166.09	170.23	178.43	184.20	192.47
48	162.72	166.06	168.21	172.29	180.04	185.86	194.02
49	165.96	169.12	171.19	175.50	183.16	189.03	197.06
50	168.38	171.53	173.73	177.98	185.69	191.57	199.65
52	172.63	175.96	178.49	183.49	191.22	197.03	205.06
54	179.89	183.27	185.74	190.66	198.40	204.22	212.36
56	187.88	191.16	193.72	198.59	206.47	212.16	220.23
58	193.00	196.28	198.77	203.76	211.53	217.22	225.34
60	198.23	201.40	203.94	208.87	216.72	222.41	230.42
62	203.24	206.57	209.00	213.94	221.84	227.54	235.58
64	207.27	210.56	213.53	219.10	227.82	236.11	243.24
66	212.29	215.62	218.59	224.27	233.01	241.23	248.30
68	217.47	220.69	223.65	229.44	238.13	246.23	253.42
70	222.69	225.92	228.76	234.50	243.30	251.41	258.63
72	227.76	230.98	233.86	239.56	248.30	256.54	263.76
74	233.01	236.22	239.10	244.73	253.56	261.72	268.87
76	236.39	239.68	242.61	249.84	258.68	268.56	274.86
78	241.58	245.02	247.82	255.36	264.07	274.03	280.50
80	242.72	246.06	248.85	256.32	265.17	275.01	281.36
82	246.64	249.97	252.77	260.12	268.97	278.88	285.10
84	251.76	254.98	257.82	265.29	273.92	283.87	290.15
86	257.00	260.34	262.98	270.33	279.22	289.00	295.33
88	262.12	265.34	268.23	275.57	284.17	294.23	300.51
90	267.29	270.75	273.39	280.74	289.45	299.70	305.50

*Visit ups.com/holidays for time in transit changes effective during the holiday season.

Note: For additional information, refer to pages [26](#) and [94](#).

Import

UPS® Standard from Mexico*

Zones	362	363	364	365	366	367	368
92 Lbs.	\$273.01	\$276.22	\$278.89	\$285.85	\$294.40	\$304.60	\$310.63
94	278.75	281.69	284.54	291.02	299.35	309.54	315.62
96	284.10	287.04	289.98	296.14	304.25	314.32	320.51
98	289.00	291.35	294.58	300.33	308.33	318.64	324.89
100	293.95	295.73	299.34	304.63	312.71	323.01	329.42
105	295.05	296.87	300.04	305.16	313.69	323.82	329.95
110	304.66	306.26	308.31	312.97	320.48	330.49	336.72
115	315.59	317.72	319.98	324.23	331.93	342.24	348.58
120	328.65	330.33	332.95	336.92	344.87	355.58	362.09
125	333.20	335.10	337.72	341.17	349.25	359.73	366.16
130	345.12	347.47	350.06	353.24	361.35	371.93	378.53
135	356.97	359.79	362.59	365.18	373.37	383.79	390.78
140	360.14	363.06	365.75	367.76	375.84	385.91	392.73
145	375.97	379.35	382.24	383.79	391.96	402.04	409.17
150	389.43	393.34	396.36	397.47	405.61	415.62	422.92

Shipments of More Than 150 Pounds

Zones	362	363	364	365	366	367	368
Shipments of 151 to 199 Pounds							
Price Per Pound	\$2.60	\$2.63	\$2.65	\$2.65	\$2.71	\$2.78	\$2.82
Minimum Rate	389.43	393.34	396.36	397.47	405.61	415.62	422.92
Shipments of 200 Pounds or More							
Price Per Pound	\$2.49	\$2.49	\$2.49	\$2.51	\$2.56	\$2.62	\$2.68
Minimum Rate	516.64	521.83	525.84	527.30	538.10	551.39	561.08

*Visit [ups.com/holidays](https://www.ups.com/holidays) for time in transit changes effective during the holiday season.

Note: For additional information, refer to pages [26](#) and [94](#).

Value-Added Services

Value-added services are available for the UPS services indicated. For additional information and rates, refer to pages [114-119](#).

	Domestic							International							Page			
	UPS Next Day Air® Early	UPS Next Day Air®	UPS Next Day Air Saver®	UPS 2nd Day Air A.M.®	UPS 2nd Day Air®	UPS 3 Day Select®	UPS® Ground	UPS® Ground with Freight Pricing	UPS Worldwide Express Plus®	UPS Worldwide Express NA1®	UPS Worldwide Express®	UPS Worldwide Express Freight® Midday	UPS Worldwide Express Freight®	UPS Worldwide Saver®	UPS Worldwide Expedited®	UPS 3 Day Select® from Canada	UPS® Standard to/from Canada	UPS® Standard to/from Mexico

Delivery Instructions and Notification																		
Adult Signature Required	●	●	●	●	●	●	●	●	●	●	●	●	●	●	●	●	●	118
Collect on Delivery (C.O.D.) Services	●	●	●	●	●	●	●	●										114
Delivery Change Request	●	●	●	●	●	●	●	●	●	●	●	●	●	●	●	●	●	115
UPS Delivery Confirmation		●	●	●	●	●	●	●										115
UPS Delivery Intercept®	●	●	●	●	●	●	●	●										115
Direct Delivery Only	●	●	●	●	●	●	●	●	●	●	●	●	●	●	●	●	●	116
Hold at Location											●	●						116
Hold for Pickup	●	●	●	●	●	●	●	●										116
UPS My Choice® for Business	●	●	●	●	●	●	●	●	●	●	●	●	●	●	●	●	●	117
UPS My Choice®	●	●	●	●	●	●	●	●	●	●	●	●	●	●	●	●	●	117
Proof of Delivery (P.O.D.)	●	●	●	●	●	●	●	●	●	●	●	●	●	●	●	●	●	118
Saturday Delivery*	●	●		●	●	●	●	●	●	●	●	●	●					118
Shipper Release	●	●	●	●	●	●	●	●										121
Signature Required		●	●	●	●	●	●	●	●	●	●	●	●	●	●	●	●	118
International Shipping																		
Billing Options									●	●	●	●	●	●	●	●	●	114
Certificate of Origin									●	●	●	●	●	●	●	●	●	114
Currency Conversion Rate									●	●	●	●	●	●	●	●	●	115
Electronic Export Information (E.E.I.)									●	●	●	●	●	●	●	●	●	116
UPS Import Control®									●	●	●	●	●	●	●	●	●	116
Non-Resident Importer (NRI)									●	●	●	●	●	●	●	●	●	118
World Ease®									●	●	●	●	●	●	●	●	●	121
Pickup																		
Daily On-Route Pickup	●	●	●	●	●	●	●	●	●	●	●		●	●	●	●	●	120
Daily Pickup	●	●	●	●	●	●	●	●	●	●	●		●	●	●	●	●	120
Day-Specific Pickup	●	●	●	●	●	●	●	●	●	●	●		●	●	●	●	●	120
Saturday Air Processing Fee (Saturday Pickup)	●	●	●	●														120
Saturday Export Processing Fee									●				●					120
Saturday Stop Charge** – UPS Smart Pickup®	●	●	●	●	●	●	●	●										120
Saturday Stop Charge** – Scheduled Pickup	●	●	●	●	●	●	●	●										120
Saturday Stop Charge** – UPS On-Call Pickup®	●	●	●	●	●	●	●	●										120
UPS On-Call Pickup®	●	●	●	●	●	●	●	●	●	●	●	●	●	●	●	●	●	118
UPS Smart Pickup®	●	●	●	●	●	●	●	●	●	●	●		●	●	●	●	●	120
Returns***																		
1 UPS Pickup Attempt Label	●	●		●	●	●	●	●	●	●	●	●	●	●	●	●	●	119
3 UPS Pickup Attempts Label	●	●		●	●	●	●	●	●	●			●	●	●	●	●	119
UPS Authorized Return Service®		●		●	●	●	●											119
Electronic Return Label	●	●		●	●	●	●	●	●	●	●	●	●	●	●	●	●	119
Print and Mail Return Label	●	●		●	●	●	●	●	●	●	●	●	●	●	●	●	●	119
Print Return Label	●	●		●	●	●	●	●	●	●	●	●	●	●	●	●	●	119
Returns and The UPS Store®	●	●		●	●	●	●	●	●	●			●	●	●	●	●	119
UPS Returns® Exchange	●	●		●	●	●	●	●	●	●			●	●	●	●	●	119
Additional Options																		
Branded Tracking from UPS	●	●	●	●	●	●	●	●	●	●	●	●	●	●	●	●	●	114
UPS carbon neutral	●	●	●	●	●	●	●	●	●	●	●	●	●	●	●	●	●	114
Declared Value for Carriage	●	●	●	●	●	●	●	●	●	●	●	●	●	●	●	●	●	115
UPS® Premier	●	●	●															118
Ship to a UPS Access Point® Location	●	●	●	●	●	●	●	●	●	●	●	●	●	●	●	●	●	118
Third Party Billing Service	●	●	●	●	●	●	●	●	●	●	●	●	●	●	●	●	●	121

*Saturday Delivery is only available for UPS 3 Day Select, UPS Ground, UPS Ground with Freight Pricing, UPS Standard from Canada and UPS Standard from Mexico services in select areas. Saturday Delivery is not available for UPS Standard to Canada or UPS Standard to Mexico services.

**Saturday Pickup is only available for UPS 3 Day Select, UPS Ground and UPS Ground with Freight Pricing services in select areas.

***UPS Returns® Service options for UPS® Simple Rate are limited to UPS Print Return Label Service only.

Other Charges

Additional charges may apply to your shipment. For additional information and rates, refer to pages [122-125](#).

	Domestic										International										Page
	UPS Next Day Air® Early	UPS Next Day Air®	UPS Next Day Air Saver®	UPS 2nd Day Air A.M.®	UPS 2nd Day Air®	UPS 3 Day Select®	UPS® Ground	UPS® Ground with Freight Pricing	UPS Worldwide Express Plus®	UPS Worldwide Express NA1®	UPS Worldwide Express®	UPS Worldwide Express Freight® Midday	UPS Worldwide Express Freight®	UPS Worldwide Express Saver®	UPS Worldwide Expedited®	UPS 3 Day Select® from Canada	UPS® Standard to/from Canada	UPS® Standard to/from Mexico			
Additional Handling	●	●	●	●	●	●	●	●	●	●	●	●	●	●	●	●	●	●	122		
Address Correction	●	●	●	●	●	●	●	●	●	●	●	●	●	●	●	●	●	●	122		
Chargeback for Consignee Billing Shipments	●	●	●	●	●	●	●	●	●	●	●	●	●	●	●	●	●	●	122		
Dangerous Goods																					
– International Dangerous Goods								●	●	●	●	●	●	●	●	●	●	●	123		
– Hazardous Materials	●	●	●	●	●	●	●												123		
– Dry Ice	●	●	●	●	●	●	●	●	●	●	●	●	●	●					123		
Delivery Area Surcharge	●	●	●	●	●	●	●	●	●	●				●	●	●	●	●	122		
Delivery Reattempt												●	●						122		
Destination Outside Service Area	●																		122		
Extended Area Surcharge								●	●	●	●	●	●	●	●	●	●	●	123		
Large Package Surcharge	●	●	●	●	●	●	●	●	●	●				●	●	●	●	●	123		
Missing PLD Fee	●	●	●	●	●	●	●	●	●	●	●	●	●	●	●	●	●	●	124		
Missing/Invalid Account Number or Refusal Fee	●	●	●	●	●	●	●	●	●	●	●	●	●	●	●	●	●	●	124		
UPS On-Call Pickup® Area Surcharge	●	●	●	●	●	●	●	●		●				●	●		●	●	124		
Over Maximum Limits	●	●	●	●	●	●	●	●	●	●				●	●	●	●	●	124		
Oversize Pallet Handling Surcharge												●	●						124		
Package Tracking, Tracing and Refund Requests	●	●	●	●	●	●	●	●	●	●	●	●	●	●	●	●	●	●	124		
Pickup Area Surcharge												●	●						124		
Prohibited Item Fee	●	●	●	●	●	●	●	●	●	●	●	●	●	●	●	●	●	●	124		
Rebill Fee	●	●	●	●	●	●	●	●	●	●	●	●	●	●	●	●	●	●	124		
Remote Area Surcharge	●	●	●	●	●	●	●	●	●	●	●	●	●	●	●	●	●	●	125		
Residential Surcharge	●	●	●	●	●	●	●	●	●	●	●	●	●	●	●	●	●	●	125		
Shipping Charge Correction Audit Fee*	●	●	●	●	●	●	●	●		●	●	●	●	●		●	●	125			
Special Handling of Undeliverable Shipments	●	●	●	●	●	●	●												125		
Undeliverable Shipment Surcharge								●	●	●	●	●	●	●	●	●	●	●	125		

*Shipping Charge Correction Audit Fee does not apply to import shipments.

Notes:

- Peak Surcharges also apply to certain packages tendered during Peak Periods. See [ups.com/peaksurcharges](https://www.ups.com/peaksurcharges) for details.
- The following surcharges do not apply to UPS® Simple Rate shipments: Delivery Area Surcharge, Delivery Area Surcharge Extended, Residential Surcharge and fuel surcharges. All other charges apply to UPS Simple Rate shipments.

Domestic, Export and Import Value-Added Services

PACKAGE

Unless otherwise noted, UPS rates are per package for domestic services and per shipment for international services.

Available Options	Description	Fee
Billing Options	<ul style="list-style-type: none"> – If the duties or the duties and taxes are billed outside the destination country, a Duty and Tax Forwarding Charge will be applied. – UPS can bill shipping charges to the shipper, the receiver or a third party to and from most countries. Check your UPS Shipping System or contact UPS for service availability. 	\$15.00
Branded Tracking from UPS	<ul style="list-style-type: none"> – A turn-key solution that merges UPS® tracking with your company's branding to help re-engage customers and promote sales. – Create a custom shipment tracking page that looks like your website but is hosted by UPS. – Easy to set up and start quickly. – Learn more at solutions.ups.com/ups-branded-tracking-lp.html. 	Contractual service
UPS carbon neutral	<ul style="list-style-type: none"> – UPS calculates the CO₂ emissions associated with the transport of your package and purchases carbon offsets to balance out the CO₂ impact. – Available to shippers using a UPS automated shipping system. – The shipping label will include a carbon neutral indicator. Also, if you select e-mail notifications, your recipient will receive a UPS carbon neutral branded e-mail. – Learn more at ups.com/carbonneutral. 	Per package charge: – UPS Domestic Air Services and UPS 3 Day Select®: \$0.20 – UPS® Ground and UPS® Standard: \$0.05 – UPS International Air Services and UPS 3 Day Select® from Canada: \$0.75 Per pallet charge: – UPS Worldwide Express Freight® Services: \$20.00
Certificate of Origin	<ul style="list-style-type: none"> – Can be prepared by UPS on behalf of the shipper for exported goods manufactured and originating within the U.S. 	\$10.00
Collect on Delivery (C.O.D.) Services	<ul style="list-style-type: none"> – UPS will attempt to collect the amount shown on C.O.D. tag or package label, then send payment to you. If payment cannot be collected after three attempts, the package will be returned. – C.O.D. service is available for packages shipped throughout the U.S. and Puerto Rico. – Also available for imports from Canada where the fee would apply per package. – Business or personal checks are accepted as payment. Currency is not accepted for payment. – C.O.D. service is not available when using a UPS 3 Day Select or UPS Ground shipping document. Refer to page 22 for an explanation of these documents. 	
UPS C.O.D.	To request a C.O.D. electronically: <ul style="list-style-type: none"> – Service is available by using a UPS automated shipping system. – The shipping system will produce a barcoded address label that contains all C.O.D. information. To request a C.O.D. using a manual tag: <ul style="list-style-type: none"> – Type or print an address label and attach it to the top of the package. – Complete the UPS C.O.D. tag per the instructions on the tag and specify the exact amount due. – Attach C.O.D. tag to each package requiring collection, covering the address label. – Retain the "Shipper Receipt" portion for your records. 	\$16.50
C.O.D. Direct®*	<ul style="list-style-type: none"> – Receive C.O.D. payments generally within six business days of package delivery. – Direct electronic transfer of funds into your designated accounts; timely alert of non-sufficient funds. – Receive daily reports of payments received, net deposits to accounts and total returned items. – Must have minimum annual 50 C.O.D. packages to qualify. – No additional fee beyond the C.O.D. rate. Please contact your account representative or call 1-877-263-8772 for details. 	Contractual service
C.O.D. Automatic®*	<ul style="list-style-type: none"> – Receive advanced C.O.D. funds in as few as two days after package delivery. – Direct electronic transfer of funds into your designated accounts; timely alert of non-sufficient funds. – Receive daily reports of payments received, net deposits to accounts and total returned items. – Online access to statement history, check images and downloadable transaction details. – Must have minimum annual C.O.D. remittances of \$30,000.00 and at least 100 C.O.D. packages to qualify. – Please contact your account representative or call 1-877-263-8772 for details. 	Contractual service
Delayed Deposit for C.O.D. Direct and C.O.D. Automatic*	<ul style="list-style-type: none"> – Additional feature of C.O.D. Direct and C.O.D. Automatic services. – Eliminates manual handling of checks held for delayed deposits by electronically scheduling future deposits directly into your designated accounts; includes online, self-service capabilities. – Please contact your account representative or call 1-877-263-8772 for details. 	Contractual service

*Visit upscapital.com/cod or call 1-877-263-8772 for more information.

Notes:

- The value-added services listed are available for UPS domestic, international package, UPS Worldwide Express Freight® Midday and UPS Worldwide Express Freight services unless otherwise noted on page 112.
- Fuel surcharges apply to value-added services associated with pickup, transport and delivery. For current fuel surcharges, where applicable, visit ups.com.

Domestic, Export and Import Value-Added Services

PACKAGE

Unless otherwise noted, UPS rates are per package for domestic services and per shipment for international services.

Available Options	Description	Fee
Collect on Delivery (C.O.D.) Services (cont.) C.O.D. Secure**	<ul style="list-style-type: none"> – Receive all the benefits of C.O.D. Automatic® service, along with protection for returned C.O.D. checks up to a specified limit. – UPS Capital® handles/manages the collections process on bad checks. – Must have minimum annual C.O.D. remittances of \$50,000.00 and at least 50 C.O.D. packages to qualify. – Please contact your account representative or call 1-877-263-8772 for details. 	Contractual service
Currency Conversion Rate	– Charges to a payer's account in a foreign currency will be converted to the payer's currency using a weekly exchange rate secured through major money center banks.	0.75% of currency amount converted
Declared Value for Carriage	<ul style="list-style-type: none"> – UPS's liability for loss or damage for each domestic package or international shipment, or to each pallet in a UPS Worldwide Express Freight® Middyay or UPS Worldwide Express Freight® shipment is limited to \$100.00 without a declaration of value. – The maximum declared value is \$50,000.00 per package/\$100,000.00 per pallet shipped via UPS Worldwide Express Freight Middyay and UPS Worldwide Express Freight services. UPS's liability for loss or damage can be increased up to \$50,000.00 per package or \$100,000.00 per pallet by making a declaration of value for an additional charge (subject to terms and conditions). Certain domestic packages are eligible for the enhanced maximum declared value of \$70,000.00, subject to restrictions set forth in the "UPS Tariff/Terms and Conditions of Service – United States" available at ups.com/terms and also set forth in "Maximum Declared Values" on page 8. – Declarations of value from \$100.01 to \$300.00 are subject to a charge of \$3.45. Declarations of value over \$300.00 incur a charge for each \$100.00 (or portion of \$100.00) of the total value declared, including the first \$100.00. For example, a declaration of \$950.00 value incurs a charge of \$11.50 (10 times \$1.15). – For international shipments with a declared value of more than \$50,000.00, multiply the total declared value by the rate to determine the declared value charge for the shipment. – For packages tendered to a UPS driver with a declared value amount of more than \$1,000.00, the shipper must retain a high-value shipment summary signed by the driver. The UPS Shipping System provides this form when the shipping label is requested. – Declared value charges can be included in charges billed to receivers or third parties. 	<ul style="list-style-type: none"> – Value from \$100.01 to \$300.00 \$3.45 – Value over \$300.00, charge for each \$100.00 (or portion of \$100.00) of the total value declared (from \$0.00 to total value declared) \$1.15 – For international shipments with a declared value of more than \$50,000.00: \$0.009 times the declared value
Delivery Change Options	– In addition to Delivery Change Option fees, additional transportation charges and all applicable surcharges may apply. Refer to the "UPS Tariff/Terms and Conditions of Service – United States" available at ups.com/terms for more information.	
UPS Delivery Intercept®	<ul style="list-style-type: none"> – As a shipper, after you tender your package to UPS, you can request that UPS return the package to you**, reroute the package to a new address**, have the package available at Will Call for pickup or have the package delivered on a future date. When the package is tracked, the status of the UPS Delivery Intercept request will be displayed. – Shippers can make a UPS Delivery Intercept request through the Shipping History with WorldShip® or UPS CampusShip® shipping systems, ups.com shipping, Quantum View Manage® or UPS tracking on ups.com. A UPS Delivery Intercept request can also be made by calling 1-800-PICK-UPS® (1-800-742-5877). 	UPS Delivery Intercept: <ul style="list-style-type: none"> – \$17.60 for web requests – \$24.90 for phone requests – No charge for Will Call
Delivery Change Request	<ul style="list-style-type: none"> – For domestic packages and import shipments only. After the first delivery attempt has occurred, consignees may, via the tracking application on ups.com or by calling 1-800-PICK-UPS® (1-800-742-5877), request the following Delivery Change Requests for a package or pallet: Return to sender**, Hold for future delivery, Change a domestic package's delivery location** (but not a pallet's), Deliver** eligible domestic packages to a UPS Access Point® location, Redeliver to the original address a package that was taken to a UPS Access Point location, and Request that UPS hold a package for Will Call at a UPS Customer Center. – A UPS InfoNotice® number is required to change the destination delivery address. 	Delivery Change Requests for a package or pallet: <ul style="list-style-type: none"> – Return to sender** - Free – Hold for future delivery - \$11.99 – Change a domestic package's delivery location** (but not a pallet's) - \$16.99 – Deliver** eligible domestic packages to a UPS Access Point location - \$7.99 – Redeliver to the original address a package that UPS elected to deliver to a UPS Access Point location without your request - Free – Request that UPS hold a package for Will Call or Same Day Will Call at a UPS Customer Center - \$7.99
UPS Delivery Confirmation	<ul style="list-style-type: none"> – Confirmation of delivery is sent by mail, and includes the delivery date, either the name of the recipient or the package disposition, and in the event of a return, the reason for the return. – Similar information, including the ability to view a signature, is available for no charge when you track your package at ups.com. 	\$2.00

*Visit [upscapital.com/cod](https://www.ups.com/cod) or call 1-877-263-8772 for more information.

**Additional transportation fees and all applicable surcharges may apply. For requests to return to the sender, any such fees will be assessed to the shipper. Refer to the "UPS Tariff/Terms and Conditions of Service – United States" available at [ups.com/terms](https://www.ups.com/terms) for more information.

Notes:

- The value-added services listed are available for UPS domestic, international package, UPS Worldwide Express Freight Middyay and UPS Worldwide Express Freight services unless otherwise noted on page 112.
- Fuel surcharges apply to value-added services associated with pickup, transport and delivery. For current fuel surcharges, where applicable, visit [ups.com](https://www.ups.com).

Domestic, Export and Import Value-Added Services

PACKAGE

Unless otherwise noted, UPS rates are per package for domestic services and per shipment for international services.

Available Options	Description	Fee
Direct Delivery Only	<ul style="list-style-type: none"> Except for shipper requests, where available, the package may not be re-routed, re-directed or delivered to an alternate address (except requests to hold for Will Call at UPS Customer Centers). Delivery pursuant to UPS's driver release and Shipper Release procedures is still available. Signature on delivery and delivery to the person specified as the receiver not required. Available for residential and commercial delivery. 	\$2.00
Electronic Export Information (E.E.I.) formerly known as Shipper's Export Declaration (S.E.D.)	<ul style="list-style-type: none"> UPS can file E.E.I. on your behalf when all required data is provided with the proper Power of Attorney. Providing E.E.I. as part of a shipment using WorldShip®, UPS CampusShip® or ups.com shipping systems ensures that UPS has all the information to file E.E.I. in a timely manner. File E.E.I. free of charge at cbp.gov/ace, the U.S. Government website designed for U.S. export shippers. 	\$15.00
Hold at Location	<ul style="list-style-type: none"> For UPS Worldwide Express Freight® Midday or UPS Worldwide Express Freight® shipments, the shipper may request that UPS hold a shipment at a UPS Worldwide Express Freight Center location for pickup. For each such shipment, the shipper will complete an address label showing the words "Hold for Pickup," the consignee's name, telephone number, the name of a contact person and the full address of the consignee (designated UPS Worldwide Express Freight Center address not required). 	No charge
Hold for Pickup	<ul style="list-style-type: none"> UPS will deliver the package to a selected UPS Customer Center and call the recipient for pickup, usually by 8:30 a.m. on the scheduled day of delivery. Recipient will be required to present a government-issued photo ID. If a recipient's representative is picking up the package, a letter on company letterhead authorizing release or a company ID may be required. Packages not picked up within five business days will be returned to the shipper. Hold for Pickup service is not available for Saturday Delivery. For each package, customers must prepare a label including the words "Hold for Pickup," the recipient's name and telephone number and the full address of the UPS Customer Center. Apply a UPS Hold for Pickup label above the address label on the package. Labels can be ordered from ups.com. Visit ups.com for the most convenient UPS Hold for Pickup location. 	No charge
UPS Import Control®		
Print Label	<ul style="list-style-type: none"> You generate the label(s) and distribute to your customer, who applies it to the shipment. 	\$1.05 per label
Electronic Label	<ul style="list-style-type: none"> UPS e-mails the label(s) upon request to your customer, who then prints and applies the label(s) to the shipment. 	\$1.05 per label
Print and Mail Label	<ul style="list-style-type: none"> UPS prints the label(s) upon request and mails it to your customer, who then applies the label(s) to the shipment. 	\$2.25 per label
1 UPS Pickup Attempt Label	<ul style="list-style-type: none"> UPS delivers a shipping label to your customer and collects the shipment. If the shipment cannot be picked up on the first attempt, UPS will leave the label at the pickup location. 	\$6.00 per label
3 UPS Pickup Attempts Label*	<ul style="list-style-type: none"> UPS delivers a shipping label to your customer and collects the shipment. If the shipment cannot be picked up on the first attempt, UPS will only make two more pickup attempts over the next two business days. 	\$8.20 per label
Invoice Removal	<ul style="list-style-type: none"> UPS removes the commercial invoice prior to delivery, which keeps merchandise values confidential from the final consignee. 	\$20.00 per shipment

GENERAL INFORMATION REGARDING UPS IMPORT CONTROL

- Importers initiate UPS shipments from another country, delivering to themselves or an alternate location.
- Allows importers to use a UPS automated shipping system or their own system to generate labels and commercial invoices, which can be forwarded to a supplier/exporter in another country by e-mail, mail or via a UPS driver with a pickup dispatch.
- Includes import document preparation, pickup, customs clearance, visibility and delivery.
- Facilitates pickup/delivery in over 145 countries and territories; varies by country; transportation charges based upon the scheduled delivery date.
- Exporter will be responsible for meeting export/import documentation requirements; to facilitate export, exporter may receive an Instruction Sheet with every label delivered to them.
- Shipments containing certain items including, but not limited to, Hazardous Materials or Dangerous Goods requiring shipping papers are not allowed in UPS Import Control shipments.
- Transportation charges for return packages are billed after entering the UPS system.
- Print and Mail Label, 1 UPS Pickup Attempt Label and 3 UPS Pickup Attempts Label accessorials are billed at the time of request. Print Label and Electronic Label fees are billed after the package enters the UPS system.
- Regulations and requirements for documentation for individual commodities vary from country to country. See ups.com for country-specific rules.
- Shipments with a package or pallet valued greater than \$1,000.00 (or local equivalent) must include a high-value shipment summary from the exporter with the labels and must be signed by the driver.

*Not available for UPS Worldwide Express Freight Services.

Notes:

- The value-added services listed are available for UPS domestic, international package, UPS Worldwide Express Freight Midday and UPS Worldwide Express Freight services unless otherwise noted on page [112](#).
- Fuel surcharges apply to value-added services associated with pickup, transport and delivery. For current fuel surcharges, where applicable, visit ups.com.

Domestic, Export and Import Value-Added Services

PACKAGE

Unless otherwise noted, UPS rates are per package for domestic services and per shipment for international services.

Available Options	Description	Fee
UPS My Choice® for Business	<ul style="list-style-type: none"> – A new web-based tool designed to give commercial and home-based businesses better control and visibility into their shipments, allowing them to easily manage their UPS services from a customizable dashboard. • View, at a glance, all inbound and outbound shipments with interactive dashboards to easily track shipments. • View estimated delivery windows to prepare incoming shipments. • Filter by date, shipment characteristics or accounts with updates from label creation to delivery. • View current shipment status to provide more accurate timing to customers and help resolve any issues. • Set notifications preferences to get automatic status alerts, including for the day before and day of delivery. • Enable additional users within your organization to access important visibility information. • Learn more and enroll any time at: ups.com/mychoiceforbusiness. 	<ul style="list-style-type: none"> Change Requests for a package or pallet – Return to sender** - Free – Hold for future delivery - Free – Change a domestic package's delivery location** (but not a pallet's) - \$14.99 – Deliver** eligible domestic packages to a UPS Access Point® location - \$5.99 – Request that UPS hold a package for Will Call or Same Day Will Call at a UPS Customer Center - \$5.99 – Redeliver to the original address a package that UPS elected to deliver to a UPS Access Point location without your request - Free
UPS My Choice®	<p>UPS My Choice service helps shippers to:</p> <ul style="list-style-type: none"> – Ensure delivery on the first attempt – Maintain superior customer service – Reduce tracking calls and returns – Improve online purchasing experience <p>With two levels of membership, UPS My Choice service provides recipients with online and mobile access to flexible delivery options to manage their home deliveries.</p> <ul style="list-style-type: none"> – Available in 112 countries 	
UPS My Choice® Member	<ul style="list-style-type: none"> – Proactive alerts via text,* e-mail or UPS® Mobile App push notification. – Provides an online Delivery Planner to help manage and track recipients' home deliveries. – Recipients may give authorization online for UPS to deliver packages without a signature. – Leave a package with a neighbor (someone within walking distance of the original delivery address). – UPS will provide delivery information, typically a four-hour approximate delivery time. – Follow My Delivery (FMD), map-based tracking notification sent morning of delivery, enables you to track premium and UPS® Ground package deliveries in real time. – Manage premium and Ground package deliveries with real-time, map-based tracking. – Set a vacation and have eligible domestic packages delivered to a UPS Access Point location and pick up within seven calendar days (unless shipper provides otherwise).** <p>Service upgrades:</p> <ul style="list-style-type: none"> – Deliver eligible packages to another address or on another day: <ul style="list-style-type: none"> • Redeliver to My Address: If UPS elected to deliver packages to a UPS Access Point location without your request, recipient can request that eligible packages be delivered back to the original address. • Deliver to a UPS Access Point location:** Have eligible domestic packages delivered to a location of The UPS Store® or UPS Access Point location (where available – refer to the "UPS Tariff/Terms and Conditions of Service – United States" available at ups.com/terms). • Request that UPS hold a package for Will Call or Same Day Will Call at a UPS Customer Center. • Deliver package on another day. • Deliver package to another address.** • Set a vacation and have all packages delivered on one of the three business days after the vacation ends. – Confirmed Delivery Window: Select a two-hour confirmed delivery window. – Upgrade UPS SurePost® service*** to UPS Ground. 	<ul style="list-style-type: none"> Free No additional charge \$5.99 per package \$5.99 per package \$9.99 per package \$14.99 per package \$9.99 per package \$14.99 per shipment \$7.99 per package
UPS My Choice® Premium Member	<ul style="list-style-type: none"> – Includes same features as a UPS My Choice Member in addition to the following: <ul style="list-style-type: none"> • Unlimited deliveries of eligible packages to another address** • Unlimited deliveries on another day (including vacation holds) <p>Service upgrades:</p> <ul style="list-style-type: none"> – Redeliver to My Address: If UPS elected to deliver packages to a UPS Access Point location without your request, recipient can request that eligible packages be delivered back to the original address. – Confirmed Delivery Window: <ul style="list-style-type: none"> • Two confirmed delivery window (two-hour) requests annually • Additional confirmed delivery window requests – Unlimited upgrades from UPS SurePost service*** to UPS Ground. 	<ul style="list-style-type: none"> \$19.99 annual fee No additional charge No additional charge \$14.99 per shipment No additional charge

*Your carrier's standard message and data rates may apply.

**Additional transportation fees and all applicable surcharges may apply. For requests to return to the sender, any such fees will be assessed to the shipper. Refer to the "UPS Tariff/Terms and Conditions of Service – United States" available at ups.com/terms for more information.

***UPS SurePost is a contract-only, non-guaranteed economy residential service with final delivery typically provided by the U.S. Postal Service.

Notes:

– The value-added services listed are available for UPS domestic, international package, UPS Worldwide Express Freight® Midday and UPS Worldwide Express Freight services unless otherwise noted on page 112.

– Fuel surcharges apply to value-added services associated with pickup, transport and delivery. For current fuel surcharges, where applicable, visit ups.com.

Domestic, Export and Import Value-Added Services

PACKAGE

Unless otherwise noted, UPS rates are per package for domestic services and per shipment for international services.

Available Options	Description	Fee
Non-Resident Importer (NRI)	<ul style="list-style-type: none"> – Applicable when shipping to Canada via UPS Air or UPS® Ground shipments. – A Non-Resident Importer is a shipper in the U.S. who acts as the importer of record to the Canadian government. – An NRI account allows you to pay the duties, taxes and brokerage charges for shipments to Canada, simplifying the experience for your consignee. – Shipper files the Power of Attorney (clearance authorization) with UPS for clearance of goods in Canada and is responsible for the payment of all Canadian duties, taxes and brokerage fees. – UPS will automatically charge all Canadian duties, taxes and brokerage fees to the shipper's NRI brokerage account. – Consignee is not involved in the customs clearance process. – Shipper undertakes all importing responsibilities as required by Canadian law. – Shipper must maintain records on all importation into Canada for a period of time prescribed by the Canadian government (for U.S. NRI account holders, that period is six years). – NRI option can be utilized on UPS Air or UPS Ground shipments. – Contact your UPS representative if you would like to set up an NRI account. 	No charge
UPS On-Call Pickup®	<ul style="list-style-type: none"> – With one pickup request, UPS will pick up all of your packages – Air, International, UPS 3 Day Select® and Ground services at your office or home. – Schedule a same-day or future-day pickup via ups.com. – At ups.com, send an e-mail confirmation of your pickup request to multiple addresses, modify your pickup request or cancel the request. – Fees are applied per pickup request regardless of the number of packages being picked up. <p>UPS Worldwide Express Freight® MIDDAY and UPS Worldwide Express Freight®</p> <ul style="list-style-type: none"> – Pickup or drop-off must be scheduled for each UPS Worldwide Express Freight MIDDAY and UPS Worldwide Express Freight shipment via WorldShip® shipping system or UPS CampusShip® shipping systems, ups.com shipping, a UPS Ready® solution, UPS® Developer Kit, ups.com or by calling 1-800-782-7892. – UPS Worldwide Express Freight MIDDAY and UPS Worldwide Express Freight pickups cannot be combined with Air, International or UPS 3 Day Select services package pickup. 	<p>Package</p> <ul style="list-style-type: none"> – Same-Day Pickup: \$6.90 – Future-Day Pickup: \$5.80 – Residential and area surcharges may apply <p>UPS Worldwide Express Freight Services</p> <p>No charge</p>
UPS® Premier	<ul style="list-style-type: none"> – Proactive monitoring and intervention service for UPS Next Day Air®, UPS Next Day Air® Early, and UPS Next Day Air Saver® shipments. – UPS provides 24-hour-a-day, seven-day-a-week support for these shipments. – Intervention is available for these shipments to help ensure service commitments and shipment integrity. – Ideal for customers shipping critical high-value, time- or temperature-sensitive products that require an additional layer of protection. 	Contractual service
Proof of Delivery (P.O.D.)	<ul style="list-style-type: none"> – Proof of Delivery of a shipment can be requested after the shipment has been delivered by calling 1-800-PICK-UPS® (1-800-742-5877). – Proof of Delivery includes the time of delivery, full delivery address and the name and signature of the person who accepted your shipment, if available. – Information can be provided via e-mail, fax or mail and is subject to a charge which will be assessed to the shipper. – Similar information is available for no charge when you track your shipment at ups.com. 	\$3.00 per package
Saturday Delivery	<ul style="list-style-type: none"> – For time-critical shipments, UPS offers the convenience of Saturday Delivery in select locations. – UPS Next Day Air® Early shipments are typically guaranteed one hour later than the guaranteed weekday delivery time to many UPS Next Day Air Early destinations. – UPS Next Day Air shipments are typically guaranteed an hour and a half later than the guaranteed weekday delivery time. – UPS 2nd Day Air® shipments are guaranteed by end of day. – UPS Worldwide Express Plus®, UPS Worldwide Express NA1® and UPS Worldwide Express services available to/from select locations. – UPS 3 Day Select and UPS Ground shipments to commercial delivery addresses within Saturday Ground Service Territories are guaranteed by end of day, if Saturday Delivery is requested by the shipper at the time of shipping. Commercial consignees in Saturday Ground Service Territories also are eligible to receive deliveries for UPS 3 Day Select, UPS Ground, UPS Ground with Freight Pricing, UPS® Standard from Canada and UPS® Standard from Mexico services on Saturday, if the consignee has a Saturday Scheduled Pickup and has opted in to receive such deliveries, but not by request. – UPS 3 Day Select, UPS Ground, UPS Ground with Freight Pricing, UPS® Standard from Canada and UPS® Standard from Mexico services are available to residential addresses within Saturday Ground Service Territories, but not by request. – Where Saturday Delivery is requested for UPS Air and international services, each package or pallet must have a Saturday Delivery routing label. A Saturday Delivery routing label is not required for UPS 3 Day Select, UPS Ground, UPS Ground with Freight Pricing, UPS Standard from Canada and UPS Standard from Mexico services. – Availability of Saturday Delivery may vary based on location of delivery address. Refer to ups.com for delivery areas. 	<p>UPS Ground Commercial and UPS 3 Day Select Commercial</p> <p>\$4.00</p> <p>UPS Ground with Freight Pricing Commercial</p> <p>\$4.00 per shipment</p> <p>UPS Air and International Services</p> <p>\$16.00</p> <p>UPS Worldwide Express Freight</p> <p>\$200.00</p>
Ship to a UPS Access Point® Location*	<p>Ship to a UPS Access Point Location Service:</p> <ul style="list-style-type: none"> – Available to all shippers with a valid UPS small package account number. – Available with all UPS small package shipping services** and most value-added services. – Shippers can integrate a UPS Locator into their e-commerce platforms, allowing their customers to select the UPS Access Point delivery location that is most convenient for them. – Only shippers with an approved UPS agreement for transportation of wine may ship wine to a UPS Access Point location, subject to limitations set forth at ups.com/wine. – For more information, go to ups.com/media/en/ShiptoUPSAccessPointlocation_US_EN.pdf. <p>Additional Service Options for Ship to a UPS Access Point Location:</p> <ul style="list-style-type: none"> – Deliver to Addressee Only – For added security, the shipment may only be picked up by the person identified on the shipping label (pickup by any third party is not permitted). – Package Release Code – For combined flexibility and security, enter a four- to six-digit numerical code when preparing a shipment and provide the code to the person you want to pick it up. The code is known only to you and the person you provide it to. 	<p>Ship to a UPS Access Point Location Service</p> <p>\$2.99</p> <p>Deliver to Addressee Only</p> <p>\$4.90 per shipment</p> <p>Package Release Code</p> <p>No additional charge</p>
Signature Required and Adult Signature Required	<ul style="list-style-type: none"> – UPS will obtain the necessary signature upon delivery. For Signature Required packages only, UPS may obtain, at its discretion, an electronic authorization to release the package without a signature upon delivery. 	Signature Required: \$5.55 Adult Signature Required: \$6.70

*For more information and restrictions on UPS Access Point Location, refer to page 24, Pickup and Drop-off Availability.

**Not available for UPS Worldwide Express Freight Services.

Notes:

– The value-added services listed are available for UPS domestic, international package, UPS Worldwide Express Freight MIDDAY and UPS Worldwide Express Freight services unless otherwise noted on page 112.

– Fuel surcharges apply to value-added services associated with pickup, transport and delivery. For current fuel surcharges, where applicable, visit [ups.com](https://www.ups.com).

DAILY RATES

Domestic, Export and Import Value-Added Services

UPS RETURNS® FOR PACKAGE

Available Options	Description	Fee
STANDARD RETURNS SOLUTIONS		
UPS Authorized Return Service®	<ul style="list-style-type: none"> – UPS preprints these return labels and provides to you for distribution. – You may include these return labels within an outbound shipment or distribute the label separately. – For domestic return shipments only. 	Contractual service
UPS Mail Innovations® Returns*	<ul style="list-style-type: none"> – Return packages through the United States Postal Service. – Features include easy-to-use label, thousands of drop off locations and detailed tracking through ups.com. 	Contractual service
Electronic Return Label	<ul style="list-style-type: none"> – UPS electronically provides a return label to your customer through a variety of formats, including e-mail, UPS tracking results or with a mobile barcode on a mobile device. – Request that UPS transmit a return label to your customer. – Pre-authorize your customer's return packages when they meet parameters agreed upon by you and UPS within the UPS Returns Manager portal. Once implemented, your customer obtains their return label through the portal; the shipper is responsible for payment of return charges and fees regardless of when the package is tendered. 	\$1.05 per label
Print and Mail Return Label	<ul style="list-style-type: none"> – UPS prints the return label upon your request and sends it to your customer, via First-Class Mail, who then applies the label to the package. 	\$2.25 per label
Print Return Label	<ul style="list-style-type: none"> – You print the return label and include it in an outbound shipment or distribute separately to your customer, who then applies the label to the package. 	\$1.05 per label
PREMIUM RETURNS SOLUTIONS		
1 UPS Pickup Attempt Label	<ul style="list-style-type: none"> – UPS delivers a return shipping label to your customer and collects the item for return. If the package cannot be picked up on the first attempt, UPS will leave the return label at the pickup location. – Pickup attempt date is not guaranteed. 	\$6.00 per label
3 UPS Pickup Attempts Label	<ul style="list-style-type: none"> – UPS delivers a return shipping label to your customer and collects the item for return. If the package cannot be picked up on the first attempt, UPS will only make two more pickup attempts over the next two business days. – Pickup attempt date is not guaranteed. 	\$8.20 per label
UPS Returns® Exchange	<ul style="list-style-type: none"> – UPS delivers a replacement item and picks up a like item for return during the same visit. – The new item is unpacked by the driver and customer; then using the delivery packaging, the old item is repacked for return to the shipper. – Replacement item won't be delivered until consignee provides the item for return to the driver. – Text and e-mail notifications are available to notify your customer of the upcoming exchange. – The outbound and return package tracking numbers are linked for round-trip visibility. 	Contractual service \$15.00 (or local equivalent) per exchange
CUSTOM RETURNS SOLUTIONS		
Customized Returns	<ul style="list-style-type: none"> – UPS can customize existing returns capabilities to address a customer's specific returns needs. 	Contractual service
Returns and The UPS Store®	<ul style="list-style-type: none"> – The UPS Store locations provide product return and exchange programs that can be tailored to large customer returns needs and that leverage The UPS Store retail network of nearly 5,000 locations to improve your client's returns experience. 	Contractual service

GENERAL INFORMATION REGARDING UPS RETURNS SERVICES

- Return packages must be UPS-compatible, conforming to UPS packaging guidelines and fall within UPS size and weight limits.
- Shipments containing certain items including, but not limited to, Hazardous Materials or Dangerous Goods requiring shipping papers are not allowed in UPS Returns Services.
- Transportation charges for return packages are billed after the package enters the UPS system.
- UPS Returns Print and Mail Label, 1 UPS Pickup Attempt Label, 3 UPS Pickup Attempts Label and UPS Returns Exchange accessorials fees are billed at the time of request.
- UPS Returns Print Return Label and Electronic Return Label fees are billed after the package enters the UPS system.
- UPS Automated Shipping Systems will allow you to produce a commercial invoice along with the label for international returns shipments.
- UPS Returns Services facilitate the pickup of return shipments and their delivery in over 145 countries and territories. Specific details may vary by country.
- The exporter will be responsible for meeting export/import documentation requirements, regardless of who processes a shipment.
- Regulations and requirements for documentation for individual commodities vary from country to country. See Export and Import rules on [ups.com](https://www.ups.com) for country-specific rules.
- Refer to the "UPS Tariff/Terms and Conditions of Service – United States" available at [ups.com/terms](https://www.ups.com/terms) for limits on actual and declared value for UPS Returns Services shipments.
- UPS provides third-country returns (where the international shipment is to be returned to a country other than the exporter's or processing party's country) only as a contractual service.
- UPS Returns® Service options for UPS® Simple Rate are limited to UPS Print Return Label Service only.

*Provided by UPS Mail Innovations. For more information, visit [ups.com/mireturns](https://www.ups.com/mireturns).

Notes:

- The value-added services listed are available for UPS domestic, international package, UPS Worldwide Express Freight® Midday and UPS Worldwide Express Freight services unless otherwise noted on page 112.
- Fuel surcharges apply to value-added services associated with pickup, transport and delivery. For current fuel surcharges, where applicable, visit [ups.com](https://www.ups.com).

Domestic, Export and Import Value-Added Services

PACKAGE

Unless otherwise noted, UPS rates are per package for domestic services and per shipment for international services.

Available Options	Description	Fee												
Saturday Air Processing Fee	<ul style="list-style-type: none"> – Formerly referred to as Saturday Pickup. – UPS Next Day Air® packages will be delivered the next business day, and UPS 2nd Day Air® packages will be delivered within two business days. – Available in select locations for UPS Next Day Air® Early. – Includes UPS Air Services and UPS Hundredweight Service® Air Services packages tendered to UPS on Saturday, including packages dropped off at retail locations. – If a Saturday pickup is scheduled but nothing is shipped, the Saturday Air Processing Fee will be assessed. – Additional pickup fees will apply for UPS On-Call Pickup® service. 	\$16.00												
Saturday Export Processing Fee	<ul style="list-style-type: none"> – UPS Worldwide Express Plus®, UPS Worldwide Express® and UPS Worldwide Saver® shipments picked up on Saturday will be delivered one day sooner than shipments picked up on Monday. – Available to select destination countries. – Includes UPS Worldwide Express Plus, UPS Worldwide Express and UPS Worldwide Saver shipments tendered to UPS on Saturday, including shipments dropped off at retail locations. – If a Saturday pickup is scheduled but nothing is shipped, the Saturday Export Processing Fee will be assessed. – Additional pickup fees will apply for UPS On-Call Pickup service. 	\$16.00 per shipment												
Saturday Stop Charge	<ul style="list-style-type: none"> – Saturday pickup is available for UPS 3 Day Select®, UPS® Ground and UPS Ground with Freight Pricing services in Saturday Ground Service Territories. – A Saturday Stop Charge that varies depending on the pickup service selected will apply any time a pickup is requested in addition to any applicable Saturday Air Processing Fee(s) or Saturday Export Processing Fee(s). – In Saturday Ground Service Territories, if a Saturday pickup is scheduled but nothing is shipped, the Saturday Stop Charge will be assessed (in lieu of the Saturday Air Processing Fee or Saturday Export Processing Fee). 													
UPS Smart Pickup®	<ul style="list-style-type: none"> – When you process a shipment using WorldShip® or UPS CampusShip® shipping systems, or ups.com shipping on Saturday, the system automatically notifies a UPS driver to make a UPS Smart Pickup service request. – In Saturday Ground Service Territories, a UPS Smart Pickup Saturday Stop Charge will apply at any time a UPS Smart Pickup request is made for Saturday pickup. 	\$6.00 per stop												
Scheduled Pickup	<ul style="list-style-type: none"> – A UPS driver automatically stops at your location once each Saturday, as scheduled. – In Saturday Ground Service Territories, a Saturday Stop Charge – Scheduled Pickup will apply any time a Saturday pickup is requested. – When paying for a Saturday Stop Charge – Scheduled Pickup, customers in Saturday Ground Service Territories may opt in to receive eligible deliveries on Saturday. 	\$9.00 per stop												
UPS On-Call Pickup	<ul style="list-style-type: none"> – Schedule a same-day or future-day Saturday pickup via ups.com. – In Saturday Ground Service Territories, a UPS On-Call Pickup Saturday Stop Charge in addition to the applicable UPS On-Call Pickup Charge will apply any time a Saturday pickup is requested. 	\$3.20 per stop UPS On-Call Pickup Fees will also apply. Refer to page 118 for UPS On-Call Pickup details.												
Scheduled Pickup Options	<ul style="list-style-type: none"> – One UPS driver will pick up all of your packages – Air, International, UPS 3 Day Select and Ground Services. That can mean a lower carbon footprint for UPS and you. – Scheduled pickup options are restricted to Monday-Friday pickups. For Saturday options, refer to the section above. – For more information, visit ups.com/pickupoptions. – Scheduled pickup options are not available for UPS Worldwide Express Freight® Midday and UPS Worldwide Express Freight® shipments. Pickups for UPS Worldwide Express Freight Midday and UPS Worldwide Express Freight services must be requested using WorldShip® or UPS CampusShip shipping systems, ups.com shipping, a UPS Ready® solution, UPS® Developer Kit, ups.com or by calling 1-800-782-7892. 													
UPS Smart Pickup**	<ul style="list-style-type: none"> – Automatically arrange a pickup only when you have packages to ship. – When you process a shipment using WorldShip or UPS CampusShip shipping systems, or ups.com shipping, the system automatically notifies a UPS driver to make a UPS Smart Pickup service request that same day. 	\$15.45 per week												
Day-Specific Pickup*	<ul style="list-style-type: none"> – A UPS driver automatically stops at your location Monday through Friday. You decide which days are best for your business. – The weekly service fee will vary based on the number of pickup days selected. 	<p style="text-align: right;">Weekly Billing Total:</p> <p style="text-align: right;">\$0.00-\$74.99 \$75.00 or more</p> <table border="0"> <tr> <td>Day-Specific Pickup</td> <td></td> <td></td> </tr> <tr> <td>– 1-2 days</td> <td>\$15.45</td> <td>\$15.45</td> </tr> <tr> <td>– 3 days</td> <td>\$24.30</td> <td>\$15.45</td> </tr> <tr> <td>– 4 days</td> <td>\$31.00</td> <td>\$15.50</td> </tr> </table>	Day-Specific Pickup			– 1-2 days	\$15.45	\$15.45	– 3 days	\$24.30	\$15.45	– 4 days	\$31.00	\$15.50
Day-Specific Pickup														
– 1-2 days	\$15.45	\$15.45												
– 3 days	\$24.30	\$15.45												
– 4 days	\$31.00	\$15.50												
Daily On-Route Pickup	<ul style="list-style-type: none"> – A UPS driver makes a pickup at your location once each business day while making deliveries in your area, even if there are no packages delivered to your location. 	Daily On-Route Pickup \$31.00 \$15.50												
Daily Pickup*	<ul style="list-style-type: none"> – A UPS driver automatically stops at your location once each business day, as scheduled. 	Daily Pickup \$33.00 \$16.50												

*Customers who select this Scheduled Pickup option receive one UPS On-Call Pickup request for Air, International or UPS 3 Day Select packages per day at no extra charge for shipments tendered after their Scheduled Pickup time. (For Day-Specific Pickup, the total number of free UPS On-Call Pickup requests for the week will not exceed the number of selected pickup days.)

Notes:

- The value-added services listed are available for UPS domestic, international package, UPS Worldwide Express Freight Midday and UPS Worldwide Express Freight® services unless otherwise noted on page 112.
- Fuel surcharges apply to value-added services associated with pickup, transport and delivery. For current fuel surcharges, where applicable, visit [ups.com](https://www.ups.com).

DAILY RATES

Domestic, Export and Import Value-Added Services

PACKAGE

Unless otherwise noted, UPS rates are per package for domestic services and per shipment for international services.

Available Options	Description	Fee
Shipper Release	– Have UPS deliver your package without requiring the recipient's signature.	No charge
Third Party Billing Service	<ul style="list-style-type: none"> – A fee applies to any shipment billed to a Third Party (regardless of the country of origin or destination of the shipment) and will be charged to the payer. – Based upon all charges, including transportation and accessorials. Excludes duties and taxes assessed by government authorities. – Does not apply to UPS Returns® Services or UPS Import Control® shipments. – UPS® Simple Rate does not qualify for Third Party Billing service. 	5.0% of total charges
World Ease®	<ul style="list-style-type: none"> – Simplifies customs clearance and reduces cost by grouping several shipments destined for one country or the entire European Union into a single shipment. – Available to and from over 75 countries and territories. – Multiple shipments travel together until customs clearance. Transit times may vary from traditional single-shipment transit times. – Call 1-800-782-7892 for more information. 	Contractual service

Notes:

- The value-added services listed are available for UPS domestic, international package, UPS Worldwide Express Freight® Midday and UPS Worldwide Express Freight services unless otherwise noted on page [112](#).
- Fuel surcharges apply to value-added services associated with pickup, transport and delivery. For current fuel surcharges, where applicable, visit [ups.com](https://www.ups.com).

Domestic, Export and Import Other Charges

PACKAGE

Unless otherwise noted, UPS rates are per package for domestic services and per shipment for international services.

Charges	Description	Fee																								
Additional Handling	<ul style="list-style-type: none"> – An Additional Handling charge will be assessed for any package that requires special handling, as determined by UPS in its sole discretion, including, but not limited to: <ul style="list-style-type: none"> • Weight: <ul style="list-style-type: none"> - Domestic: Any package with an actual weight of more than 50 pounds. <ul style="list-style-type: none"> - Each package in a shipment where the average weight per package is greater than 50 pounds and the weight for each package is not specified on the source document or the UPS automated shipping system used. - International: Any package with an actual weight of more than 70 pounds. <ul style="list-style-type: none"> - Each package in a shipment where the average weight per package is greater than 70 pounds and the weight for each package is not specified on the source document or the UPS automated shipping system used. • Length plus girth: Any package with its length (longest side of the package) plus girth [(2 x width) + (2 x height)] combined exceeding 105 inches. • Length: Any package with the longest side exceeding 48 inches. • Width: Any package with its second-longest side exceeding 30 inches. • Packaging: <ul style="list-style-type: none"> - Any article that is not fully encased in a corrugated cardboard shipping container, including tires. - Any package with an outer shipping container not made of corrugated cardboard, including but not limited to canvas, leather, metal, wood, hard plastic, soft plastic (e.g., plastic bag) or expanded polystyrene foam (e.g., styrofoam). - Any article that is encased in a soft-sided pack (e.g., poly bags and bubble mailers) that exceeds 18 inches along its longest side or 14 inches along its second-longest side or 6 inches in height. - Any package with an outer shipping container covered in shrink wrap or stretch wrap. - Any package bound with metal, plastic or cloth banding, or that has wheels, casters, handles or straps (including packages where the outer surface area is loosely wrapped or where the contents protrude outside the container surface). - Any cylindrical-like item, including but not limited to barrels, buckets, cans, drums, mailing tubes or pails. - Any package routed through UPS's irregular package sortation process, including but not limited to packages 1 inch or less in height. - Any other package that requires special handling, as determined by UPS in its sole discretion. – Applies per package for both domestic and international services. – For a package that meets multiple criteria listed above, only one Additional Handling charge will be assessed, in the following order: Weight, Length plus girth, Length, Width, Packaging. – An Additional Handling charge will not be assessed when a Large Package Surcharge is applied. 	<p><i>Effective through April 10, 2021</i></p> <p>Domestic</p> <ul style="list-style-type: none"> – Weight \$25.50 – Length + girth \$16.00 – Length \$16.00 – Width \$16.00 – Packaging \$15.25 <p>International \$16.00</p> <p><i>Effective April 11, 2021**</i></p> <table border="1"> <thead> <tr> <th>Domestic</th> <th>Zone 2</th> <th>Zones 3-4</th> <th>Zones 5+</th> </tr> </thead> <tbody> <tr> <td>– Weight</td> <td>\$24.00</td> <td>\$25.50</td> <td>\$27.00</td> </tr> <tr> <td>– Length + girth</td> <td>\$15.00</td> <td>\$16.00</td> <td>\$18.00</td> </tr> <tr> <td>– Length</td> <td>\$15.00</td> <td>\$16.00</td> <td>\$18.00</td> </tr> <tr> <td>– Width</td> <td>\$15.00</td> <td>\$16.00</td> <td>\$18.00</td> </tr> <tr> <td>– Packaging</td> <td>\$14.00</td> <td>\$15.00</td> <td>\$16.00</td> </tr> </tbody> </table> <p>International \$16.00</p>	Domestic	Zone 2	Zones 3-4	Zones 5+	– Weight	\$24.00	\$25.50	\$27.00	– Length + girth	\$15.00	\$16.00	\$18.00	– Length	\$15.00	\$16.00	\$18.00	– Width	\$15.00	\$16.00	\$18.00	– Packaging	\$14.00	\$15.00	\$16.00
Domestic	Zone 2	Zones 3-4	Zones 5+																							
– Weight	\$24.00	\$25.50	\$27.00																							
– Length + girth	\$15.00	\$16.00	\$18.00																							
– Length	\$15.00	\$16.00	\$18.00																							
– Width	\$15.00	\$16.00	\$18.00																							
– Packaging	\$14.00	\$15.00	\$16.00																							
Address Correction	<ul style="list-style-type: none"> – If any shipment has an incorrect or incomplete address, UPS will make reasonable efforts to secure the correct or complete address and will make available to the shipper the correct address. UPS may also correct or complete an address based on information obtained from the shipper or consignee. An Address Correction charge will be assessed to the shipper for an address correction or completion. – An address validated by UPS may be incorrect or incomplete for purposes of completing delivery, and may be corrected by UPS. 	<p>Package and UPS Worldwide Express Freight Services</p> <p>\$18.00</p> <p>UPS® Ground with Freight Pricing</p> <p>\$18.00 per package up to a maximum of \$126.00 per shipment.</p>																								
Chargeback for Consignee Billing Shipments	<ul style="list-style-type: none"> – In the event of non-payment by the consignee or third party, the original shipper will be billed a refusal fee in addition to the shipping charges. 	\$18.00																								
Delivery Area Surcharge	<ul style="list-style-type: none"> – A surcharge applies to each package delivered to certain ZIP Codes within the 48 contiguous states. For Alaska and Hawaii, refer to page 125 for the Remote Area Surcharge. – Refer to the Area Surcharge Listing at ups.com/rates for a listing of applicable ZIP Codes. – Delivery Area Surcharge does not apply to UPS Ground with Freight Pricing or UPS® Simple Rate shipments. 	<table border="1"> <thead> <tr> <th></th> <th>Ground</th> <th>Air*</th> </tr> </thead> <tbody> <tr> <td>– Commercial</td> <td>\$3.10</td> <td>\$3.25</td> </tr> <tr> <td>– Residential</td> <td>\$4.30</td> <td>\$4.70</td> </tr> <tr> <td>– Commercial Extended</td> <td>\$3.70</td> <td>\$3.85</td> </tr> <tr> <td>– Residential Extended</td> <td>\$5.90</td> <td>\$5.90</td> </tr> </tbody> </table> <p>Import:</p> <ul style="list-style-type: none"> – Delivery Area Surcharge: \$3.25 – Delivery Area Surcharge Extended: \$3.85 		Ground	Air*	– Commercial	\$3.10	\$3.25	– Residential	\$4.30	\$4.70	– Commercial Extended	\$3.70	\$3.85	– Residential Extended	\$5.90	\$5.90									
	Ground	Air*																								
– Commercial	\$3.10	\$3.25																								
– Residential	\$4.30	\$4.70																								
– Commercial Extended	\$3.70	\$3.85																								
– Residential Extended	\$5.90	\$5.90																								
Delivery Reattempt	<ul style="list-style-type: none"> – For UPS Worldwide Express Freight® Midday and UPS Worldwide Express Freight shipments, one delivery attempt is included in the rate. – Additional delivery attempts may have additional charges. 	\$60.00																								
Destination Outside Service Area	<ul style="list-style-type: none"> – If delivery of a UPS Next Day Air® Early package is requested to a destination outside the UPS Next Day Air Early service area, UPS reserves the right to assess an additional fee. 	\$10.00																								

*UPS 3 Day Select® packages receive the charge listed for UPS Air Services.

**Effective April 11, 2021 for non-Hundredweight service packages, and effective July 11, 2021 for Hundredweight service packages.

Notes:

– The other charges listed are available for UPS domestic, international package, UPS Worldwide Express Freight Midday and UPS Worldwide Express Freight services unless otherwise noted on page 113.

– Fuel surcharges apply to other charges associated with pickup, transport and delivery. For current fuel surcharges, where applicable, visit [ups.com](https://www.ups.com).

DAILY RATES

Domestic, Export and Import Other Charges

PACKAGE

Unless otherwise noted, UPS rates are per package for domestic services and per shipment for international services.

Charges	Description	Fee																																															
Dry Ice	<ul style="list-style-type: none"> Most non-Dangerous Goods shipments containing dry ice are accepted, without requiring the shipper to enter into the UPS Dangerous Goods Agreement (contract). Prepare and process these packages through WorldShip® or UPS CampusShip® shipping systems, UPS® Developer Kit or an approved UPS Ready® solution. The IATA "Shipper's Declaration for Dangerous Goods" is not required for domestic shipments of non-Dangerous Goods packed in dry ice. Title 49 C.F.R. Shipping Papers are only required for non-medical shipments containing more than 5.5 pounds of dry ice. International dry ice shipping is available on a contractual basis only. For more information, visit ups.com or call the Hazardous Materials Support Center at 1-800-554-9964. 	\$6.15 per package																																															
Extended Area Surcharge	<ul style="list-style-type: none"> An Extended Area Surcharge applies to shipments for some international origins and destinations. Visit ups.com/rates or call 1-800-782-7892 to determine if a particular origin or destination is classified as an Extended Area. 	Greater of \$42.00 per shipment or \$0.42 per lb.																																															
Dangerous Goods (Hazardous Materials)	<ul style="list-style-type: none"> UPS accepts Hazardous Materials only from customers with a UPS Dangerous Goods Agreement (contract) in effect and a Scheduled Pickup account, and then for transport only within and between all 50 states and Puerto Rico. Materials prepared in accordance with Title 49 C.F.R. 173.4 Small Quantities for highway and rail, 173.4a Excepted Quantities, and 173.4b de minimis exceptions; and Excepted Quantities, as defined in the International Air Transport Association (IATA) 2.7, may be shipped without a Hazardous Materials contract in the 50 states and Puerto Rico. International Dangerous Goods (IDG) shipments requiring "Shipper's Declaration for Dangerous Goods," as defined under the International Civil Aviation Organization (ICAO) and published in the International Air Transport Association (IATA) "Dangerous Goods Regulations," are accepted for transportation only as a contractual service. Excepted Quantities require a contract for International Dangerous Goods (IDG) service but are not subject to the additional International Dangerous Goods (IDG) charge. UPS accepts International Dangerous Goods (IDG) only for transportation within and between defined international service areas. For valid countries and territories, see ups.com/approvedcountries. Domestic Air*, International Air* and UPS Worldwide Express Freight Services Dangerous Goods are rated based on the class of the commodity being shipped. If a package or shipment contains any Accessible Dangerous Goods commodities or the shipper fails to identify the class of the commodity, the Accessible charge will apply. <ul style="list-style-type: none"> Accessible Dangerous Goods: Class 1.4 Explosives, Class 2.1 Flammable Gas, Class 2.2 Non-Flammable Gas in Cargo Aircraft Only (CAO) quantities, Class 3 Flammable Liquid, Class 4 Flammable Solid, Dangerous When Wet, Class 5 Oxidizers and Organic Peroxides, and Class 8 Corrosives. Inaccessible Dangerous Goods: Class 2.2 Non-Flammable Gas in Passenger (PAX) and Limited (LQ) quantities, Class 6 Toxic and Infectious Substances, Class 7 Radioactive Material and Class 9 Miscellaneous Dangerous Substances. For additional information, call the Hazardous Materials Support Center at 1-800-554-9964. Hazardous Materials are not accepted for transportation using UPS® Simple Rate, UPS Ground with Freight Pricing or UPS Worldwide Expedited® Ground Freight. 	<p>Package</p> <ul style="list-style-type: none"> UPS® Ground: \$39.00 UPS® Standard to/from Canada: the greater of \$46.40 per shipment or \$5.27 per Dangerous Goods package <p>Domestic and International Air Services</p> <p>Accessible Dangerous Goods</p> <ul style="list-style-type: none"> UPS Domestic Air Services*: \$115.00 per package UPS International Air Services*: the greater of \$171.00 per shipment or \$20.53 per Dangerous Goods package UPS Worldwide Express Freight Services: the greater of \$171.00 per shipment or \$0.93 per lb. <p>Inaccessible Dangerous Goods</p> <ul style="list-style-type: none"> UPS Domestic Air Services*: \$54.50 per package UPS International Air Services*: the greater of \$85.50 per shipment or \$10.26 per Dangerous Goods package UPS Worldwide Express Freight Services: the greater of \$85.50 per shipment or \$0.47 per lb. 																																															
Large Package Surcharge	<ul style="list-style-type: none"> For domestic shipments, a package is considered a "Large Package" when its length (longest side of the package) plus girth [(2 x width) + (2 x height)] combined exceeds 130 inches or its length exceeds 96 inches. For international shipments, a package is considered a "Large Package" when its length (longest side of the package) plus girth [(2 x width) + (2 x height)] combined exceeds 130 inches. With the exception of UPS Ground with Freight Pricing packages, Large Packages are subject to a minimum billable weight of 90 pounds. Applies per package for both domestic and international services. For a domestic package that meets both criteria listed above, only the Large Package Surcharge applicable when length plus girth combined exceeds 130 inches will be assessed. An Additional Handling charge will not be assessed when a Large Package Surcharge is applied. 	<p><i>Effective through April 10, 2021</i></p> <table border="1"> <thead> <tr> <th></th> <th>Length + Girth >130"</th> <th>Length >96"</th> </tr> </thead> <tbody> <tr> <td>Domestic</td> <td></td> <td></td> </tr> <tr> <td>– Commercial</td> <td>\$105.00</td> <td>\$105.00</td> </tr> <tr> <td>– Residential</td> <td>\$130.00</td> <td>\$130.00</td> </tr> <tr> <td>International</td> <td colspan="2">\$105.00</td> </tr> </tbody> </table> <p><i>Effective April 11, 2021**</i></p> <table border="1"> <thead> <tr> <th></th> <th>Zone 2</th> <th>Zones 3-4</th> <th>Zones 5+</th> </tr> </thead> <tbody> <tr> <td>Commercial</td> <td></td> <td></td> <td></td> </tr> <tr> <td>– Length + girth >130"</td> <td>\$100.00</td> <td>\$105.00</td> <td>\$120.00</td> </tr> <tr> <td>– Length >96"</td> <td>\$100.00</td> <td>\$105.00</td> <td>\$120.00</td> </tr> <tr> <td>Residential</td> <td></td> <td></td> <td></td> </tr> <tr> <td>– Length + girth >130"</td> <td>\$125.00</td> <td>\$130.00</td> <td>\$145.00</td> </tr> <tr> <td>– Length >96"</td> <td>\$125.00</td> <td>\$130.00</td> <td>\$145.00</td> </tr> <tr> <td>International</td> <td colspan="3">\$105.00</td> </tr> </tbody> </table>		Length + Girth >130"	Length >96"	Domestic			– Commercial	\$105.00	\$105.00	– Residential	\$130.00	\$130.00	International	\$105.00			Zone 2	Zones 3-4	Zones 5+	Commercial				– Length + girth >130"	\$100.00	\$105.00	\$120.00	– Length >96"	\$100.00	\$105.00	\$120.00	Residential				– Length + girth >130"	\$125.00	\$130.00	\$145.00	– Length >96"	\$125.00	\$130.00	\$145.00	International	\$105.00		
	Length + Girth >130"	Length >96"																																															
Domestic																																																	
– Commercial	\$105.00	\$105.00																																															
– Residential	\$130.00	\$130.00																																															
International	\$105.00																																																
	Zone 2	Zones 3-4	Zones 5+																																														
Commercial																																																	
– Length + girth >130"	\$100.00	\$105.00	\$120.00																																														
– Length >96"	\$100.00	\$105.00	\$120.00																																														
Residential																																																	
– Length + girth >130"	\$125.00	\$130.00	\$145.00																																														
– Length >96"	\$125.00	\$130.00	\$145.00																																														
International	\$105.00																																																

*UPS 3 Day Select® shipments receive the charge listed for UPS Domestic Air Services. UPS 3 Day Select® from Canada receives the charge listed for UPS International Air Services. References to "Domestic and International Air" in this section include UPS 3 Day Select Services.

**Effective April 11, 2021 for non-Hundredweight service packages and effective July 11, 2021 for Hundredweight service packages.

Notes:

– The other charges listed are available for UPS domestic, international package, UPS Worldwide Express Freight® Midday and UPS Worldwide Express Freight services unless otherwise noted on page [113](#).

– Fuel surcharges apply to other charges associated with pickup, transport and delivery. For current fuel surcharges, where applicable, visit [ups.com](https://www.ups.com).

Domestic, Export and Import Other Charges

PACKAGE

Unless otherwise noted, UPS rates are per package for domestic services and per shipment for international services.

Charges	Description	Fee
Missing PLD Fee	<ul style="list-style-type: none"> – A processing fee will be charged when the shipper does not provide all applicable Package Level Detail (PLD) information to UPS prior to delivery. – Applies per package for both domestic and international services. 	\$2.00 per package
Missing/Invalid Account Number or Refusal Fee	<ul style="list-style-type: none"> – A processing fee will be charged for a missing or invalid account number when the account number is missing, the account number is not the correct number for the bill-to party, the account number is for a receiver or third party who fails to pay the shipping charges or the package is shipped to an unauthorized consignee. 	\$18.00
UPS On-Call Pickup® Area Surcharge	<ul style="list-style-type: none"> – A surcharge applies to each residential UPS On-Call Pickup request at certain ZIP Codes within the 48 contiguous states. – Refer to the Area Surcharge Listing at ups.com/rates for a listing of applicable ZIP Codes. – Does not apply to UPS On-Call Pickup requests made at commercial addresses. 	<ul style="list-style-type: none"> – Residential: \$4.30 – Extended Residential: \$5.90
Over Maximum Limits	<ul style="list-style-type: none"> – Packages with an actual weight of more than 150 pounds, or that exceed 108 inches in length or exceed a total of 165 inches in length plus girth [(2 x width) + (2 x height)] combined, as measured to determine their billable weight, are not accepted for transportation. – If found in the UPS system, they are subject to additional charges. UPS reserves the right in its sole and unlimited discretion to return such packages to the shipper at the shipper's expense. – Refer to the "UPS Tariff/Terms and Conditions of Service – United States" available at ups.com/terms for more information. 	\$920.00 per package
Oversize Pallet Handling Surcharge	<ul style="list-style-type: none"> – UPS Worldwide Express Freight® Midday and UPS Worldwide Express Freight® pallets that exceed maximum size or weight restrictions (which vary by origin and destination) as set forth at ups.com/assets/resources/media/wwef_max_dim.pdf require prior approval and are subject to an Oversize Pallet Handling Surcharge. 	\$920.00 per pallet
Package Tracking, Tracing and Refund Requests	<ul style="list-style-type: none"> – Shipper may be assessed a charge per request for excessive tracking, tracing and refund requests. 	\$3.00
Peak Surcharges	<ul style="list-style-type: none"> – One or more Peak Surcharges will apply to certain packages tendered during a Peak Period. Details are available at ups.com/peaksurcharges. – Refer to the "UPS Tariff/Terms and Conditions of Service – United States" available at ups.com/terms for more information. 	Refer to ups.com/peaksurcharges
Pickup Area Surcharge	<ul style="list-style-type: none"> – A surcharge applies to each UPS Worldwide Express Freight Midday or UPS Worldwide Express Freight U.S. export shipment picked up from certain ZIP Codes within the 48 contiguous states. – Refer to the Area Surcharge Listing at ups.com/rates or call 1-800-782-7892 for a listing of applicable ZIP Codes. 	Greater of \$42.00 per shipment or \$0.42 per lb.
Prohibited Item Fee	<ul style="list-style-type: none"> – Packages containing prohibited articles or restricted articles not in compliance with all UPS policies and procedures and applicable laws and regulations are subject to additional charges if found in the UPS system. – Such charges apply in addition to all other applicable charges. – UPS reserves the right in its sole and unlimited discretion to dispose of such packages, submit such packages to governmental authorities or return such packages to the shipper solely at the shipper's risk and expense. – Refer to the "UPS Tariff/Terms and Conditions of Service – United States" available at ups.com/terms for more information. 	\$150.00 per package
Rebill Fee	<ul style="list-style-type: none"> – A fee will be assessed for each request to change the billing account for a shipment. 	\$18.00 per request

Notes:

- The other charges listed are available for UPS domestic, international package, UPS Worldwide Express Freight Midday and UPS Worldwide Express Freight services unless otherwise noted on page 113.
- Fuel surcharges apply to other charges associated with pickup, transport and delivery. For current fuel surcharges, where applicable, visit [ups.com](https://www.ups.com).

Domestic, Export and Import Other Charges

PACKAGE

Unless otherwise noted, UPS rates are per package for domestic services and per shipment for international services.

Charges	Description	Fee
Remote Area Surcharge	<ul style="list-style-type: none"> – A Remote Area Surcharge applies to deliveries to certain ZIP Codes within Alaska and Hawaii and select origins and destinations. – Applies to any UPS On-Call Pickup® request made within certain ZIP Codes within Alaska and Hawaii. – Refer to the Area Surcharge Listing at ups.com/rates for a listing of applicable ZIP Codes. – Applies to UPS® Simple Rate shipments. 	<p>Package</p> <ul style="list-style-type: none"> – Alaska: \$32.50 – Hawaii: \$10.65 – Non-U.S. origins and destinations: Greater of \$42.00 per shipment or \$0.42 per lb. <p>UPS Worldwide Express Freight® Services</p> <ul style="list-style-type: none"> – Alaska/Hawaii: Greater of \$42.00 per shipment or \$0.42 per lb. – Non-U.S. origins and destinations: Greater of \$42.00 per shipment or \$0.42 per lb.
Residential Surcharge	<ul style="list-style-type: none"> – A surcharge will apply (in addition to all applicable Area Surcharges) to any delivery to, or a UPS On-Call Pickup request from, a location that is a home, including a business operating out of a home. – UPS® Ground service fee applies to UPS On-Call Pickup requests made at a residential address. – Refer to the “UPS Tariff/Terms and Conditions of Service – United States” available at ups.com/terms for more information. – Residential Surcharge does not apply to UPS Simple Rate shipments. 	<p>Package</p> <ul style="list-style-type: none"> – UPS Domestic and International Air Services, UPS 3 Day Select® and UPS 3 Day Select® from Canada: \$5.00 – UPS Ground services \$4.45 – UPS® Standard services \$4.80 – UPS Ground with Freight Pricing: \$43.20 per shipment <p>UPS Worldwide Express Freight Services</p> <ul style="list-style-type: none"> – \$160.00
Shipping Charge Correction Audit Fee	<ul style="list-style-type: none"> – An audit fee will be assessed when the average shipping charge correction during an invoice week is greater than \$2.00 per package subject to a shipping charge correction. – The fee will be calculated per account number, based on shipping charge corrections billed to the account number during the applicable invoice period. – Shipping Charge Correction Audit Fee does not apply to import shipments. 	<p>Greater of:</p> <ul style="list-style-type: none"> – \$1.00 per package subject to a shipping charge correction during the applicable invoice period; or – 6% of the total amount of shipping charge corrections during the applicable invoice period
Special Handling of Undeliverable Shipments	<ul style="list-style-type: none"> – Domestic packages refused by the consignee, or which are undeliverable for any reason, will be returned to the shipper at the shipper’s expense. – Return service level will be UPS 3 Day Select for Air Services and UPS Ground for UPS Ground shipments at the applicable rate. Packages in UPS Ground with Freight Pricing shipments will be charged at the applicable rate for single-piece UPS Ground service. All applicable surcharges apply to any return. – The UPS Service Guarantee does not apply to undeliverable packages returned to the shipper. 	<ul style="list-style-type: none"> – UPS Air Services and UPS 3 Day Select: applicable UPS 3 Day Select rate – UPS Ground and UPS Ground with Freight Pricing: applicable UPS Ground rate – All applicable surcharges apply
Undeliverable Shipment Surcharge	<ul style="list-style-type: none"> – For all international shipments refused by the consignee, or which are undeliverable for any reason, UPS will contact the shipper for further instructions.* – Forwarding costs, return transportation charges, all applicable surcharges, duties, taxes and a return surcharge apply to any return, at the shipper’s expense. – The UPS Service Guarantee does not apply to undeliverable packages returned to the shipper. 	<p>Applicable costs plus \$10.00 per undeliverable shipment</p>

*For UPS® Standard to Mexico shipments, in cases where the shipment cannot be imported, the shipment will be automatically returned to the exporter.

Notes:

- The other charges listed are available for UPS domestic, international package, UPS Worldwide Express Freight® Midday and UPS Worldwide Express Freight services unless otherwise noted on page [113](#).
- Fuel surcharges apply to other charges associated with pickup, transport and delivery. For current fuel surcharges, where applicable, visit ups.com.

Value-Added Services

FREIGHT

Value-added services are available for the UPS services indicated. For additional information and rates, refer to the pages listed in the "Page" column at right.

	Air Freight						UPS Freight® LTL (Less-Than-Truckload)				Freight Between the U.S. and Mexico		Page				
	UPS Next Day Air® Freight	UPS Next Day Air® Freight NGS	UPS 2nd Day Air® Freight	UPS 2nd Day Air® Freight NGS	UPS 3 Day Freight®	UPS 3 Day Freight® NGS	LTL	LTL Guaranteed	LTL Guaranteed A.M.	LTL Urgent	UPS® Standard LTL	UPS Worldwide Expedited® Ground Freight	Air Freight	UPS Freight LTL	UPS Standard LTL	UPS Worldwide Expedited Ground Freight	
Delivery Instructions and Notification																	
Collect on Delivery (C.O.D.) Services							•			•	•			130	130		
Hold at Destination Airport for Pickup (HAPU)	•	•	•	•	•	•						•	128				132
Proof of Delivery (P.O.D.)	•	•	•	•	•	•	•	•	•	•	•	•	128	130	130		132
Saturday Delivery	•	•	•	•	•	•							128				
Saturday, Sunday or Holiday Delivery							•			•	•			130	130		
International Shipping																	
Certificate of Origin	•	•	•	•	•	•						•	128				132
Pickup																	
Saturday Pickup	•	•											128				
Saturday, Sunday or Holiday Pickup							•			•	•			130	130		
Additional Options																	
Declared Value for Carriage	•	•	•	•	•	•	•	•	•	•	•	•	128	130	130		132

Note: For information on additional charges that may apply to your Coyote Logistics® shipments, please call 1-877-626-9683 or visit coyote.com.

Other Charges

FREIGHT

Additional charges may apply to your shipment. For additional information and rates for the UPS services indicated, refer to the pages listed in the “Page” column at right.

	Air Freight						UPS Freight® LTL (Less-Than-Truckload)				Freight Between the U.S. and Mexico		Page			
	UPS Next Day Air® Freight	UPS Next Day Air® Freight NGS	UPS 2nd Day Air® Freight	UPS 2nd Day Air® Freight NGS	UPS 3 Day Freight®	UPS 3 Day Freight® NGS	LTL	LTL Guaranteed	LTL Guaranteed A.M.	LTL Urgent	UPS® Standard LTL	UPS Worldwide Expedited® Ground Freight	Air Freight	UPS Freight LTL	UPS Standard LTL	UPS Worldwide Expedited Ground Freight
Address Correction	•	•	•	•	•	•					•	129				133
Chargeback for Consignee Billed Shipments	•	•	•	•	•	•					•	129				133
Corrected Bill of Lading							•	•	•	•	•		131	131		
Dangerous Goods		•										129				
Detention of Vehicle	•	•	•	•	•	•	•	•	•	•	•		131	131	133	
Hazardous Materials							•			•	•		131	131		
Inside Delivery and Inside Pickup							•			•	•		131	131		
Liftgate Services	•	•	•	•	•	•	•			•	•	129	131	131	133	
Missing/Invalid Account Number or Refusal Fee	•	•	•	•	•	•					•	129				133
Non-Conforming Freight	•	•	•	•	•	•					•	129				133
Notification Prior to Delivery							•			•	•		131	131		
Oversize	•	•	•	•	•	•	•			•	•	129	131	131	133	
Payer Rebilling Fee	•	•	•	•	•	•					•	129				133
Redelivery	•	•	•	•	•	•	•	•	•	•	•	129	131	131	133	
Residential Delivery/Pickup		•		•		•	•			•	•	129	131	131	133	
Storage							•	•	•	•	•		131	131		
Truck Waiting Time	•	•	•	•	•	•					•	129				133

Note: For information on additional charges that may apply to your Coyote Logistics® shipments, please call 1-877-626-9683 or visit coyote.com.

Within and Between the U.S., Canada and Puerto Rico

Value-Added Services

AIR FREIGHT

Available Options	Description	Fee
Certificate of Origin	– Can be prepared by UPS on behalf of the shipper for exported goods manufactured and originating within the U.S.	\$25.00
Declared Value for Carriage	– UPS's liability for all losses is limited to \$50.00 per shipment or \$0.50 per pound, whichever is greater. – Shipper may declare a value in excess of these limits, subject to maximum allowable values for an additional charge. – For more information, refer to the "UPS Air Freight Terms and Conditions of Contract for UPS Air Freight Services in the United States, Canada and International" at ups-scs.com/terms .	– \$1.10 per \$100.00 – Minimum of \$115.00
Hold at Destination Airport for Pickup (HAPU)	– Freight is to be held at the carrier's destination location for pickup by the recipient. – HAPU requires a consignee name and phone number. – All services will be billed door-to-door.	No charge
Proof of Delivery (P.O.D.)	– Contact your local service center to request Proof of Delivery. To locate your local service center, call 1-800-443-6379.	\$10.00
Saturday Delivery	– Saturday Delivery may be selected by the shipper where available to A.M. points only. – Shipments delivered on Saturday must be picked up on Friday.	\$33.00 per 100 lbs.: \$210.00 minimum in U.S., Canada and Puerto Rico
Saturday Pickup	– Saturday Pickup may be selected by the shipper where available to A.M. points only.	\$33.00 per 100 lbs.: \$210.00 minimum in U.S., Canada and Puerto Rico

Notes:

- The value-added services listed are available for UPS Air Freight services unless otherwise noted on page [126](#).
- Fuel surcharges apply to value-added services associated with pickup, transport and delivery. For current fuel surcharges, where applicable, visit [ups-scs.com/surcharges](https://www.ups.com/surcharges).

Within and Between the U.S., Canada and Puerto Rico

Other Charges

AIR FREIGHT

Charges	Description	Fee
Address Correction	<ul style="list-style-type: none"> – If any shipment has an incorrect or incomplete address, UPS will make reasonable efforts to secure the correct or complete address and will provide the shipper with the correct address. UPS may also correct or complete an address based on information obtained from the shipper or consignee. An Address Correction charge will be assessed to the shipper for an address correction or completion. – An address validated by UPS may be incorrect or incomplete for purposes of completing delivery and may be corrected by UPS. 	\$84.00
Chargeback for Consignee Billed Shipments	<ul style="list-style-type: none"> – In the event of non-payment by the consignee or third party, the original shipper will be billed a refusal fee in addition to the shipping charges. 	\$25.00
Dangerous Goods	<ul style="list-style-type: none"> – Dangerous Goods can be shipped via UPS Next Day Air® Freight NGS only. – Non-conforming freight may be subject to service delays. 	\$0.49 per lb.; \$113.00 minimum
Liftgate Services	<ul style="list-style-type: none"> – Liftgate equipment on trailers is available for customers who do not have a shipping or receiving dock and cannot load or unload their shipment without liftgate assistance. – Liftgate service must be requested, as not all trailers are equipped with liftgate devices. 	<ul style="list-style-type: none"> – Origin: \$9.26 per 100 lbs.; \$137.00 minimum; \$451.00 maximum – Destination: \$9.26 per 100 lbs.; \$137.00 minimum; \$451.00 maximum
Missing/Invalid Account Number or Refusal Fee	<ul style="list-style-type: none"> – A processing fee will be charged for a missing or invalid account number when the account number is missing, the account number is not the correct number for the bill-to party, the account number is for a receiver or third party who fails to pay the shipping charges or the package is shipped to an unauthorized consignee. 	\$25.00
Non-Conforming Freight	<ul style="list-style-type: none"> – Shipments that are unusually shaped, non-stackable, difficult to handle or require special handling in transit (to prevent damage to the shipment, the other shipments it may come in contact with or the equipment). – Non-conforming freight may be subject to service delays and additional charges. 	30% of Air Freight charges; \$245.00 minimum
Oversize	<ul style="list-style-type: none"> – Oversize fees will be charged to shipments that exceed 120 inches in length, 83 inches in width and 60 inches in height. 	Cubic Dimensional Weight and % of transportation charge for the greater of: <ul style="list-style-type: none"> – 20% if length + girth > 200" – 30% if a dimension ≥ 60" – Minimum \$185.00 when a dimension > 120"
Payer Rebilling Fee	<ul style="list-style-type: none"> – A payer rebilling fee will be assessed for each request to change the billing instructions for a shipment. 	\$25.00
Redelivery	<ul style="list-style-type: none"> – If more than one delivery attempt is made. 	\$0.077 per lb.; \$70.50 minimum
Residential Delivery/Pickup	<ul style="list-style-type: none"> – Fee assessed for pickup from or delivery to a home address, including a business operating out of a home that does not have an entrance open to the public. 	\$160.00 per shipment
Truck Waiting Time	<ul style="list-style-type: none"> – If the driver is required to wait more than 15 minutes for either a pickup or delivery, charges based on waiting time will be computed by multiplying the hourly rate by the time involved. 	<ul style="list-style-type: none"> – \$65.00 per hour – \$47.00 per vehicle for each 15 minutes or fraction thereof shall be made for the time consumed for the delay, subject to a minimum charge of \$83.50 – \$128.00 per vehicle for each 24-hour period or fraction thereof, excluding non-business days

Notes:

- The other charges listed are available for UPS Air Freight services unless otherwise noted on page 127.
- Fuel surcharges apply to other charges associated with pickup, transport and delivery. For current fuel surcharges, where applicable, visit ups-scs.com/surcharges.

Within the U.S. and Between the U.S., Canada and Mexico

Value-Added Services

UPS FREIGHT® LTL (LESS-THAN-TRUCKLOAD)

Available Options	Description
Collect on Delivery (C.O.D.)	– C.O.D. is accepted on your behalf when requested.
Declared Value for Carriage	<ul style="list-style-type: none"> – UPS's liability for losses is determined by several criteria, including origin and destination of the shipment, the actual invoice value of the commodities lost, damaged or destroyed, the amount determined from the applicable limited liability provisions of the National Motor Freight Classification (NMFC), and the limits provided by contract, if applicable, or the UPS Freight® 102 Series Tariff. – Shipper may declare a value in excess of these limits, subject to maximum allowable values for an additional charge. – For more information, refer to the UPS Freight 102 Series Tariff at upsfreight.com/tariff Item 166.
Proof of Delivery (P.O.D.)	<ul style="list-style-type: none"> – Proof of Delivery includes the time of delivery, full delivery address and the name and signature of the person who accepted your shipment, if available. – Information can be provided via Tracking on ups.com when logged in, Quantum View Manage® tracking, UPS Billing Center, My LTL Freight, e-mail, fax or mail.
Saturday, Sunday or Holiday Delivery	– Delivery service is available on non-business days such as Saturdays, Sundays and holidays upon request.
Saturday, Sunday or Holiday Pickup	– Pickup service is available on non-business days such as Saturdays, Sundays and holidays upon request.

Notes:

- The value-added services listed are available for UPS Freight LTL and UPS® Standard LTL services unless otherwise noted on page [126](#).
- The list of value-added services listed above is not a comprehensive list of all value-added services available. For a complete list of value-added services, fees and current fuel surcharges, where applicable, visit [upsfreight.com](https://www.upsfreight.com) and refer to the UPS Freight Rules Tariff for Less-Than-Truckload transportation. For full details and updates, refer to [upsfreight.com/tariff](https://www.upsfreight.com/tariff).

Within the U.S. and Between the U.S., Canada and Mexico

Other Charges

UPS FREIGHT® LTL (LESS-THAN-TRUCKLOAD)

Charges	Description
Corrected Bill of Lading	– When information on a shipping document must be corrected.
Detention of Vehicle	– Detention of Vehicle fees apply (with power and without power) upon expiration of the applicable free time allowed.
Hazardous Materials	– UPS Freight® accepts Hazardous Materials for Ground Transportation within the 48 contiguous states under the D.O.T. Code of Federal Regulations, as outlined in Title 49, Parts 100-185 on Transportation (49 C.F.R.).
Inside Delivery and Inside Pickup	– For shipments that require the driver to deliver or pick up at points beyond the area immediately accessible to the loading dock.
Liftgate Services	– Liftgate equipment on trailers is available for customers who do not have a shipping or receiving dock and cannot load or unload their shipment without liftgate assistance. – Liftgate service must be requested, as not all trailers are equipped with liftgate devices.
Notification Prior to Delivery	– When recipient must be contacted in advance of arrival.
Oversize	– Shipments containing one or more articles with any single dimension that equals or exceeds the applicable length threshold shall be subject to a charge.
Redelivery	– If more than one delivery attempt is made, a fee applies if redelivery is needed after UPS Freight attempts to deliver during committed delivery time.
Residential Delivery/Pickup	– A surcharge will apply to any delivery or pickup to or from a location that is a home, including a business operating out of a home.
Storage	– A fee is assessed if UPS Freight is unable to deliver a shipment during committed delivery times and must store the shipment at a UPS Freight facility.

Notes:

- The other charges listed are available for UPS Freight LTL and UPS® Standard LTL services unless otherwise noted on page [127](#).
- The list of other charges listed above is not a comprehensive list of all other charges that may apply. For a complete list of other charges, fees and current fuel surcharges, where applicable, visit [upsfreight.com](https://www.upsfreight.com) and refer to the UPS Freight Rules Tariff for Less-Than-Truckload transportation. For full details and updates, refer to [upsfreight.com/tariff](https://www.upsfreight.com/tariff).

Freight Between the U.S. and Mexico

Value-Added Services

UPS WORLDWIDE EXPEDITED® GROUND FREIGHT

Available Options	Description	Fee
Certificate of Origin	– Can be prepared by UPS on behalf of the shipper for exported goods manufactured and originating within the U.S.	\$25.00
Declared Value for Carriage	– UPS's liability for all losses is limited to \$50.00 per shipment or \$0.50 per pound, whichever is greater. – Shipper may declare a value in excess of these limits, subject to maximum allowable values for an additional charge. – For more information, refer to the "UPS Air Freight Terms and Conditions of Contract for UPS Air Freight Services in the United States, Canada and International" at ups-scs.com/terms .	– \$1.10 per \$100.00 – Minimum of \$115.00
Hold at Destination Airport for Pickup (HAPU)	– Freight is to be held at the carrier's destination location for pickup by the recipient. – HAPU requires a consignee name and phone number. – All services will be billed door-to-door.	No charge
Proof of Delivery (P.O.D.)	– Contact your local service center to request Proof of Delivery. To locate your local service center call 1-800-443-6379.	\$10.00

Notes:

- Fuel surcharges apply to value-added services associated with pickup, transport and delivery. For current fuel surcharges, where applicable, visit ups-scs.com/surcharges.
- The value-added services listed are available for UPS Worldwide Expedited Ground Freight services unless otherwise noted on page [126](#).
- UPS Worldwide Expedited Ground Freight is governed by the "UPS Air Freight Terms of Contract for UPS Air Freight Services in the United States, Canada and International" at ups-scs.com/terms.

Freight Between the U.S. and Mexico

Other Charges

UPS WORLDWIDE EXPEDITED® GROUND FREIGHT

Charges	Description	Fee
Address Correction	<ul style="list-style-type: none"> – If any shipment has an incorrect or incomplete address, UPS will make reasonable efforts to secure the correct or complete address and will provide the shipper with the correct address. UPS may also correct or complete an address based on information obtained from the shipper or consignee. An Address Correction charge will be assessed to the shipper for an address correction or completion. – An address validated by UPS may be incorrect or incomplete for purposes of completing delivery, and may be corrected by UPS. 	\$84.00
Chargeback for Consignee Billed Shipments	– In the event of non-payment by the consignee or third party, the original shipper will be billed a refusal fee in addition to the shipping charges.	\$25.00
Detention of Vehicle	– Detention of Vehicle fees apply (with power and without power) upon expiration of the applicable free time allowed.	\$65.00
Liftgate Services		
Origin	– Fee assessed for pickup that requires a vehicle equipped with a mechanical lifting device.	<ul style="list-style-type: none"> – \$9.26 per 100 lbs. – \$137.00 minimum – \$451.00 maximum
Destination	– Fee assessed for delivery that requires a vehicle equipped with a mechanical lifting device.	<ul style="list-style-type: none"> – \$9.26 per 100 lbs. – \$137.00 minimum – \$451.00 maximum
Missing/Invalid Account Number or Refusal Fee	– A processing fee will be charged for a missing or invalid account number when the account number is missing, the account number is not the correct number for the bill-to party, the account number is for a receiver or third party who fails to pay the shipping charges or the package is shipped to an unauthorized consignee.	\$25.00
Non-Conforming Freight	<ul style="list-style-type: none"> – Shipments that are unusually shaped, non-stackable, difficult to handle or require special handling in transit (to prevent damage to the shipment, the other shipments it may come in contact with or the equipment). – Non-conforming freight may be subject to service delays and additional charges. 	<ul style="list-style-type: none"> 30% of Air Freight charges \$245.00 minimum
Oversize	– Oversize fees will be charged to shipments that exceed 120 inches in length, 83 inches in width and 60 inches in height.	<ul style="list-style-type: none"> Cubic Dimensional Weight and % of transportation charge for the greater of: – 20% if length + girth > 200" – 30% if a dimension ≥ 60" – Minimum \$185.00 when a dimension > 120"
Payer Rebilling Fee	– A payer rebilling fee will be assessed for each request to change the billing instructions for a shipment.	\$25.00
Redelivery	– If more than one delivery attempt is made.	\$0.077 per lb.; \$70.50 minimum
Residential Delivery/Pickup	– A surcharge will apply to any delivery to a location that is a home, including a business operating out of a home.	\$160.00 per shipment
Truck Waiting Time	– If the driver is required to wait more than 15 minutes for either a pickup or delivery, charges based on waiting time will be computed by multiplying the hourly rate by the time involved.	<ul style="list-style-type: none"> – \$65.00 per hour – \$47.00 per vehicle for each 15 minutes or fraction thereof shall be made for the time consumed for the delay, subject to a minimum charge of \$83.50 – \$128.00 per vehicle for each 24-hour period or fraction thereof, excluding non-business days

Notes:

- Fuel surcharges apply to other charges associated with pickup, transport and delivery. For current fuel surcharges, where applicable, visit [ups-scs.com/surcharges](https://www.ups.com/surcharges).
- The other charges listed are available for UPS Worldwide Expedited Ground Freight services unless otherwise noted on page 127.
- UPS Worldwide Expedited Ground Freight is governed by the "UPS Air Freight Terms of Contract for UPS Air Freight Services in the United States, Canada and International" at [ups-scs.com/terms](https://www.ups.com/terms).

Customs Brokerage

PACKAGE

The following applies per shipment for imports into the U.S.:

- All UPS Worldwide Express Plus®, UPS Worldwide Express NA1®, UPS Worldwide Express®, UPS Worldwide Express Freight® Midday, UPS Worldwide Express Freight®, UPS Worldwide Saver®, UPS Worldwide Expedited®, UPS 3 Day Select® from Canada and UPS® Standard to/from Mexico rates include routine customs clearance. Routine customs clearance is built into your rates when you use UPS to perform the customs clearance for any of these services.
- Additional services such as parts database management, customer-specific classification directives, special operating plans, assigned rating team, custom reporting and other value-added services are part of our Customized Brokerage Services

and subject to a customs entry fee and/or other charges. Please see Customized Brokerage Services in the Special Services section below for more information.

- UPS also provides services designed to facilitate movements of your UPS® Standard shipments to and from Canada (see brokerage rates into Canada at ups.com/rates/ca) and other non-routine services that include formal entry clearance, live entry clearance, temporary import bonds and duty drawbacks. In addition, UPS can provide customs clearance for other ocean, air freight, truck and rail U.S. imports. The importer is responsible for all brokerage fees, including duties and taxes. See charts on the following pages for more information.
- The UPS Service Guarantee does not apply when customs clearance is performed by brokerage offices other

than those designated by UPS, or if a service delay is the result of certain events beyond our control, such as a government agency hold.

- Customs clearance for services specified here is provided by the UPS Supply Chain Solutions® customs brokerage offices designated by UPS for handling package customs clearance. Other UPS Supply Chain Solutions customs brokerage offices charge fees for clearance of packages and freight. Customs clearance and brokerage services are subject to the Customs Brokerage and Freight Forwarding Terms and Conditions/ U.S. located at ups-scs.com/tools/terms.html.

For more information on any of our Customs Brokerage Services, call 1-800-782-7892.

UPS Broker of Choice®

With UPS Broker of Choice service, importers select their own alternate customs broker for customs clearance of their UPS international shipments. This service is available for all UPS international shipments, except for UPS® Standard service.

This contractual, fee-based service allows the importer to utilize UPS for international shipping needs, with an alternate broker providing customs clearance. The importer may use UPS Broker of Choice service for specific

commodities or product lines, while continuing to utilize UPS brokerage expertise for others.

UPS technology makes shipment information and documentation (e.g., the commercial invoice) available to the designated broker at the time of export. This enables customs clearance in a timely manner.

Importers have two options:

1. UPS Broker of Choice OnSite keeps shipments in UPS's possession while the

importer's customs broker completes customs clearance procedures prior to UPS completing delivery of the shipment.

2. UPS Broker of Choice OffSite moves shipments in-bond directly to a customs-controlled (bonded) warehouse (at the importer's direction), where the importer's customs broker completes the customs clearance procedures. The UPS transport is completed upon delivery of the shipment to the warehouse. Refer to page [137](#) for fees.

Note: For information on UPS Customs Brokerage Services for your freight needs, including the Customs Brokerage and Freight Forwarding Terms and Conditions, please visit ups-scs.com.

Customs Brokerage

PACKAGE

UPS® FTZ Facilitator

With UPS FTZ Facilitator service, importers and exporters have the ability to use UPS to transport international shipments in-bond to and from a global Free/Foreign Trade Zone (FTZ). This service is available for all UPS international shipments, except for UPS® Standard service.

This contractual, fee-based service allows the shipment of goods to and from an FTZ, while retaining the benefits of UPS's transportation network. Using UPS as a single source enables

importers and exporters to increase visibility and tracking, and reduce the chance for errors and costs associated with utilizing multiple transportation providers.

UPS technology enables shipment information and documentation (e.g., the commercial invoice) available to the customer, customer's broker and FTZ operator at the time of export. This enables prompt processing of the FTZ entry.

Importers will choose UPS FTZ Facilitator import service to direct shipments to be delivered in-bond to a designated FTZ rather than being cleared through customs.

Exporters will choose UPS FTZ Facilitator export service to ship goods in-bond from an FTZ to an international destination. Refer to page [137](#) for fees.

Entry Preparation Charges for Importing into the United States

All rates and values are shown in U.S. funds. Rates are per shipment and do not include applicable taxes.

Value for Duty	UPS Worldwide Express Plus® UPS Worldwide Express NA1® UPS Worldwide Express® UPS Worldwide Express Freight® Midday UPS Worldwide Express Freight® UPS Worldwide Saver® UPS Worldwide Expedited® UPS 3 Day Select® from Canada UPS® Standard from Mexico	UPS® Standard from Canada*
\$0.00 to \$800.00**	No Charge***	No Charge††
\$800.01† to \$1,250.00	No Charge***	\$28.75
\$1,250.01 to \$2,500.00	No Charge***	\$40.50
Each Additional \$1,000.00 or Part Thereof	No Charge***	\$1.95

*When UPS Supply Chain Solutions® is designated as the customs broker on the commercial invoice for the product listed above, the UPS Service Guarantee applies to your shipment, subject to its terms set forth in the applicable "UPS Tariff/Terms and Conditions of Service – United States" available at [ups.com/terms](https://www.ups.com/terms). The UPS Service Guarantee does not apply when customs clearance is performed by customs brokerage offices other than those designated by UPS for clearing the products listed above. Call 1-800-782-7892 for more information.

**\$800.00 or current de minimis requirements set forth by law, if different.

***For UPS Worldwide Express Plus, UPS Worldwide Express NA1, UPS Worldwide Express, UPS Worldwide Express Freight Midday, UPS Worldwide Express Freight, UPS Worldwide Saver, UPS Worldwide Expedited, UPS 3 Day Select from Canada and UPS Standard from Mexico service levels, routine customs clearance (for entries up to three entry lines) is included at no additional cost. Additional charges will apply if customs clearance is performed by customs brokerage offices other than those designated by UPS for clearing the products listed above.

†\$800.01 or \$0.01 higher than current de minimis requirement set forth by law, if different.

††An Entry Preparation Charge will apply on any UPS Standard from Canada shipment below de minimis value requiring an entry, at the fee amount published for goods valued between \$800.01 and \$1,250.00.

Customs Brokerage

PACKAGE

The Customs Brokerage information below applies to all UPS international package and UPS Worldwide Express Freight® services, unless otherwise noted.

Service	Explanation	Fee
BONDS (CONTRACT ONLY)		
Continuous Transaction Bond	<ul style="list-style-type: none"> – One-year import bond for all entries made in a single year with up to \$50,000.00 coverage. – Required under special circumstances. 	\$525.00
In-Transit Bond (IT Bond)	– Allows a shipment to be transported under U.S. Customs and Border Protection supervision until it is formally entered into the customs territory of the U.S. and duty is paid, or until it is exported from the U.S.	\$85.00
Single Entry Bond (SEB)	<ul style="list-style-type: none"> – One-time import bond issued to ensure compliance with U.S. laws and regulations. – When an SEB is necessary, UPS will contact the importer prior to customs clearance. 	\$4.50 per \$1,000.00 (minimum \$45.00)
SPECIAL ENTRIES		
Additional Consignee or Invoice	– A fee applies if the shipment has more than one consignee or one commercial invoice.	\$2.10 per consignee or invoice
Complex Entries	<ul style="list-style-type: none"> – Usually requires a formal entry and may require an additional day of customs clearance. – A Complex Entry fee will be applied to the following: <ul style="list-style-type: none"> • A live entry that is required by U.S. Customs and Border Protection (CBP) when an export license (visa) is mandated for import into the U.S. • If the commodity and country of origin require Antidumping/Countervailing Duties. Antidumping/Countervailing Duty entries help U.S. companies compete with foreign industries and require additional information for U.S. Customs and Border Protection. • Any imported goods, goods returned and goods previously imported that require additional U.S. Customs and Border Protection documentation to substantiate the duty-free claim. • Goods with additional licensing requirements. • When the customer requests UPS to file a single entry for a non-restricted commodity which normally qualifies for clearance under a consolidated manifest (Title 19 C.F.R. 128). 	\$25.00
Duty Drawbacks	– The preparation of a refund request for part or all of customs duty or domestic tax paid on imported merchandise that was subsequently manufactured into a different article or re-exported.	\$90.00 minimum*
Entry-Line Charge After First Three Lines	– A fee applies when more than three entry lines are entered.	\$3.20/line
Entry Type 86 Processing	– A fee applies when the customer requests UPS to file a single entry under Entry Type 86 for a shipment which normally qualifies for clearance under a consolidated manifest (Title 19 C.F.R. 128.24(e)).	\$11.00
Fish and Wildlife (F&W) Entry Preparation	– Fish and Wildlife Service is a government agency that requires the filing of certain documents and permits, and conducts inspections of products that contain wildlife or plant species that fall under the F&W jurisdiction. A fee of \$25.00 will be assessed for UPS preparing and submitting the Fish and Wildlife USFWS Form 3-177.	\$25.00**
Foreign Trade Zone (FTZ) Entry	– These types of entries are non-routine and must be requested by the importer to UPS Supply Chain Solutions. For more information, refer to UPS® FTZ Facilitator service on pages 135 and 137 .	Upon request

*Additional charges may apply.

**All fees charged by any government agency or other third party, if any, will be billed in addition to the listed fees.

Customs Brokerage

PACKAGE

The Customs Brokerage information below applies to all UPS international package and UPS Worldwide Express Freight® services, unless otherwise noted.

Service	Explanation	Fee
SPECIAL ENTRIES (CONTINUED)		
Partner Government Agency (PGA) Clearance	<ul style="list-style-type: none"> Government agencies work with U.S. Customs and Border Protection on regulating and controlling commodities coming into the U.S. from other countries. Special documents must be submitted to these agencies for shipments that contain controlled commodities. Agencies include the Food and Drug Administration (FDA), Department of Agriculture (USDA) and the Federal Communications Commission (FCC), among others. 	\$25.00*
Prior Notice for Food and Food Products	<ul style="list-style-type: none"> A fee applies if you want UPS to provide Prior Notice to the U.S. Food and Drug Administration (FDA) for food and food products imported into or moving through the U.S. This advance notice is required by the Bioterrorism Preparedness and Response Act of 2002. For import shipments, the Prior Notice fee is in addition to the existing FDA Clearance fee for regulated food and food products. 	\$12.00
Temporary Import Under Bond	<ul style="list-style-type: none"> Special customs entry for merchandise to be brought into the country exempt of duty, provided the merchandise exits the country within a certain amount of time and under U.S. Customs and Border Protection supervision. 	\$95.00
UPS Broker of Choice®	<ul style="list-style-type: none"> Enables an importer to use an alternate customs broker for imported shipments, providing advanced visibility of shipment documents to the selected alternate broker, clearance while in UPS's possession (OnSite), with UPS completing delivery or after UPS has delivered to a designated bonded warehouse (OffSite). 	\$55.00 (OnSite)/\$55.00 (OffSite) OffSite will also include a separate In-Transit Bond fee
UPS® FTZ Facilitator	<ul style="list-style-type: none"> Facilitates the bonded movement from the first port of arrival to the FTZ location, providing advanced visibility of shipment documents to the importer or FTZ operator; also available for international shipments originating in FTZ. 	\$80.00
Warehouse Entry	<ul style="list-style-type: none"> Fee assessed to the customer when a request is made by the importer to file a warehouse entry. These types of entries are non-routine and must be requested by the importer to UPS Supply Chain Solutions. 	\$132.50
OTHER SERVICES		
Customized Brokerage Services	<ul style="list-style-type: none"> UPS can provide additional customized brokerage services to meet your specific importing and compliance needs. Examples of these contractual, fee-based services include customized reports, shipment pre-alerts, classification confirmations and others. The fees for these customized services depend on the types of services requested. 	Upon request
Customs Entry Packets	<ul style="list-style-type: none"> Entry and payment documentation for shipments that have been through the U.S. Customs and Border Protection payment and review process. Request by the shipper, consignee and/or third party for import clearance documentation which could include, but is not limited to, records previously supplied to the broker by the shipper/consignee or copies of any import clearance documentation. 	\$2.00 per packet or shipment
Disbursement Fee	<ul style="list-style-type: none"> Customers are responsible for payment of duty and taxes. Fee of 2% (minimum \$12.00) of the amount paid or processed by UPS on behalf of the customer will be charged. 	2% of Duty/Tax (minimum \$12.00)
Duty	<ul style="list-style-type: none"> Fee imposed by U.S. Customs and Border Protection on imported merchandise. 	Based on the value and/or gross weight; it differs according to the commodity

*All fees charged by any government agency or other third party, if any, will be billed in addition to the listed fees.

Customs Brokerage

PACKAGE

The Customs Brokerage information below applies to all UPS international package and UPS Worldwide Express Freight® services, unless otherwise noted.

Service	Explanation	Fee
OTHER SERVICES (CONTINUED)		
Formal Entry	– Required for shipments valued at more than \$2,500.00 (U.S.) or for shipments containing specific commodities designated by U.S. Customs and Border Protection.	See Complex Entries on page 136
Marking Notice Processing	– Special documents must be filed for a shipment not properly marked with the country of origin. – Customs Power of Attorney must also be completed and on file with brokerage before the shipment can be forwarded to the consignee for proper marking.	\$80.00
Merchandise Processing Fee	– A non-refundable fee charged by U.S. Customs and Border Protection for administrative expenses for processing certain imported shipments. The fee will not apply if the goods qualify under applicable free trade agreements. For Air shipments: – Applicable only for formal entries (customs value more than \$2,500.49 or as required by regulation). For Ground shipments: – Applicable for both informal and formal entries.	Based on the value of merchandise; minimum and maximum fees may apply
Overtime/Special Handling Service (Hourly Rate)	– When additional, non-routine activities/services are required, selected services may be performed by UPS. – Services offered include (but are not limited to) manipulations, labeling, inventory, auditing, customized reports, spreadsheets, key entry, general order processing, etc. – UPS reserves the right to charge in one-hour increments, rounded up to the next hour. – Please contact a brokerage specialist if there is a need for additional clearance services.	\$53.00 per hour*
Post Entry Services	– Protest: Request from an importer to recoup the overpayment of duty to U.S. Customs and Border Protection due to a description discrepancy or misclassification on the customs entry. – Post Summary Correction: Request from an importer to obtain corrections to an entry filed with U.S. Customs and Border Protection prior to liquidation. – Voluntary Tender: Request from an importer to submit additional duties owed to U.S. Customs and Border Protection, where submission is initiated by the customer.	\$95.00 / \$120.00**
Pre-Release Notification	– This fee applies when customer contact is required prior to releasing the shipment.	\$14.00 per shipment
Transportation Handling	– Assessed when shipments are removed from the UPS system, at the request of the importer, to be forwarded to another broker for clearance. – Shipments are transferred from the UPS-bonded facility to the designated bonded agent's facility. – A bonded carrier or cartman must be used to transfer goods in-bond from UPS to another carrier based on approval to move the goods from U.S. Customs and Border Protection. – Transfer may be denied by UPS Supply Chain Solutions® Customs Brokerage Services.	\$30.00
United States-Mexico-Canada Agreement (USMCA) Processing	– Special processing to ensure that the required USMCA documentation on a shipment is complete to allow any applicable reduced tariff.	\$21.25
Warehouse Storage – Air/Ground – Per Day After Two Days	– Assessed when shipments remain in the UPS warehouse after the two free days regardless of the customs broker.	\$20.00 + \$0.04 per lb. per day

*All fees charged by any government agency or other third party, if any, will be billed in addition to the listed fees.

**Complex post entry services include, but are not limited to, protests and complex post summary corrections (i.e., tariff exclusions and multiple tariff lines).

How To Use This Guide

Section 1 CHOOSING A SERVICE PAGES [3-9](#)

Section 2 PREPARING A SHIPMENT PAGES [10-24](#)

Section 3 DETERMINING THE RATE PAGES [25-138](#)

Section 4

TRACKING AND PAYMENT

Convenient and up-to-the-minute ways to track shipments are reviewed, as well as an explanation of the UPS invoice, its presentation and various billing and payment options.

- Track your shipment as it moves through the UPS system from drop-off or pickup to completed delivery. Pages [140-141](#)
 - Choose to review your invoice in a variety of electronic formats or as a paper summary. Page [142](#)
 - Select from a number of payment plans that offer weekly and monthly options. Page [143](#)
 - Review solutions for managing your invoice and tips on how to avoid additional charges. Page [144](#)
-

Track Your Shipment

Convenient Ways to Track Shipments

Method	Description
UPS® Mobile App*	– Track your package and freight shipments anytime and anywhere directly from your mobile device. Visit ups.com/mobile to learn more or to download the app.
coyote.com	Provides direct access for customers to create, view, track and settle their own loads, and for carriers to find, accept and update loads. – Network map includes filters to provide a focused, filtered view and ability to hover over lane to see lane information. – Customizable load board allows users to add or remove columns to view the most valuable information. – Streamlined accounting features allow for uploading paperwork, viewing invoices and checking accounting status. – Call 1-877-626-9683 or coyote.com/technology for more information.
CoyoteHOWL®	– CoyoteHOWL® mobile app allows shippers to easily connect with their Coyote reps and access shipments, documents and business trends right from their mobile phones. It offers ability to receive load updates via push notifications and provides shippers free, on-the-go visibility 24/7. – Visit noexcuses.coyote.com/CoyoteHOWL to learn more.
Flex® Global View	– Query status and receive e-mail alerts on Air Freight, Ocean Freight and UPS Worldwide Expedited® Ground Freight shipment exceptions, warehouse inventory and backorders, purchase orders and fulfillment, as well as customs brokerage entries and clearance. – Search by multiple customer reference types, trade lanes, purchase orders, waybills, bills of lading and ocean containers; receive standard and customized reports in PDF, Excel or text formats. – Contact your UPS representative or visit ups.com for more information on Flex Global View .
UPS InfoNotice® Number	– Number assigned by UPS that links all shipments for a delivery attempt together (patent pending). For detailed information on each shipment, go to ups.com or call 1-800-833-9943.
upsfreight.com	– Track UPS Freight® LTL shipments directly from the upsfreight.com homepage using your PRO Number. You can also track using your Bill of Lading or Purchase Order numbers.
UPS My Choice®**	– Provides recipients with proactive delivery alerts via text,** e-mail or UPS® Mobile App push notification the day before delivery and the morning of delivery. Confirmation of delivery and delivery schedule updates are available.
UPS My Choice® for Business	– A new web-based tool designed to give commercial and home-based businesses better control and visibility into their shipments, allowing them to easily manage their UPS services from a customizable dashboard: <ul style="list-style-type: none"> • At-a-glance view of all inbound and outbound shipments with interactive dashboards to easily track shipments • View estimated delivery windows to prepare incoming shipments • Filter by date, shipment characteristics or accounts with updates from label creation to delivery • View current shipment status to provide more accurate timing to customers and help resolve any issues • Set notifications preferences to get automatic status alerts, including for the day before and day of delivery • Enable additional users within your organization to access important visibility information • Learn more and enroll any time at: ups.com/mychoiceforbusiness
PRO Number	– Number automatically assigned to your LTL shipment by UPS Freight® to identify and locate the shipment.
Quantum View® Data*	– An information service that provides package status updates via data files hourly (or as often as requested), when new information is available, about UPS shipments you ship/receive and shipments billed to your UPS account. Files are available in CSV, Flat File (TXT), XML and EDI formats for integration into your software applications and databases. – Contact your UPS representative or visit ups.com/quantumview for more information.
Quantum View Manage®	– Allows you to receive proactive package and freight shipment status information via a user-friendly web interface without having to provide a tracking number. View information about UPS shipments you ship, receive or bill to your UPS account. – Create custom views of shipping information, filter information and results, search by criteria you choose, set alerts, e-mail interested parties with shipping information and download data. – For importers: provides additional inbound solutions to expedite clearance delays, automate customs compliance processes, audit post-clearance shipments prior to the payment of duties, contact UPS Customs Brokerage representatives and archive trade documents. – Contact your UPS representative or visit ups.com/quantumview for more information.
Quantum View Notify®	– Sends proactive e-mail notifications of key package and freight shipment events to as many as five e-mail addresses per request or two SMS recipients when requested in UPS.com tracking or Quantum View Manage. – Choose any combination of three critical shipment notifications for a particular shipment: when shipping information is received by UPS, when the shipment is delivered and when there is an exception which results in a change in the scheduled day of delivery. – Can be requested at the time a shipment is processed in WorldShip® or UPS CampusShip® shipping systems, the UPS App, the UPS® Developer Kit, ups.com shipping and a UPS Ready® solution approved to use this service. – Can also be selected post-shipment at Tracking on ups.com and Quantum View Manage tracking. – Contact your UPS representative or visit ups.com/quantumview for more information. – If UPS carbon neutral is also selected, e-mail notifications will be on a UPS carbon neutral branded template highlighting that the shipment is carbon neutral.
Reference Number	– Number you can assign when you ship to help you identify your shipment. Reference number can contain any combination of letters and numbers up to 35 characters.
Text Message	– Track your package shipment via text messaging. Visit ups.com/mobile to get started.

*Not available for UPS Worldwide Express Freight® Services.

**Your carrier's standard message and data rates may apply.

Track Your Shipment

Convenient Ways to Track Shipments (continued)

Method	Description
Tracking Number	– Number automatically assigned to your shipment by UPS to identify and locate the shipment as it travels through the UPS system.
ups.com	– Track your package and freight shipments directly from the ups.com homepage or click on the Tracking menu to track up to 25 different tracking or UPS InfoNotice® numbers; you can also track by using your own reference numbers.
Within Your Business	– Integrate the Tracking Application Programming Interface (API), one of the UPS Developer Kit APIs, into your business applications or onto your website; use a tracking or reference number to track your package and freight shipments.

PACKAGE

Proof of Delivery (P.O.D.)

Service	Description
Proof of Delivery (P.O.D.)	– Proof of Delivery of a shipment via e-mail, fax or mail is subject to a charge which will be assessed to the shipper. Refer to page 118 for charges and details.
UPS Delivery Confirmation (Domestic)	– Confirmation of delivery for domestic package will be mailed to the shipper. Delivery Confirmation mailings will no longer be included with Signature Required or Adult Signature Required services. Refer to page 115 for charges and details.
Signature Tracking®	– Web-based enhanced shipment tracking for instant access to Proof of Delivery information, including a digital signature image and full delivery address. – Available at no charge. – Sign up at ups.com/myups/login . Once logged in, select Tracking from the Services menu and then choose Signature Tracking from the menu of services on the right side of the page.

Manage Your Claims

Now you can efficiently and conveniently manage your package claims online. From this website you can:

- Report a problem
- Provide claim documentation
- Check the status of a claim
- Receive key status updates via e-mail
- View and download claim history
- Initiate a claim dispute
- Access information about minimizing specific packaging problems that can result in lost or damaged packages
- Contact UPS with questions

You can access the claim site by:

- Visiting [Claims Support](#)
- Going to the Customer Service section under the Support tab on ups.com

Plus, the ability to manage your claims has been integrated into systems you already use:

- Tracking on ups.com: If there is a problem with your package, you will see a link under “File a Claim” on the detailed tracking result page. This link will allow you to report a lost or damaged package or missing C.O.D.

- Quantum View Manage® tracking: If you are a subscriber, you will see a link on the Shipment Progress page to “report a lost or damaged package.”

For UPS Worldwide Express Freight® Midday and UPS Worldwide Express Freight® claims, call 1-800-782-7892.

Reviewing Your Invoice

Viewing, Downloading, Paying and Managing Your Invoice

UPS offers a number of options for viewing, downloading, paying and managing your invoice. You may want to consider one of our information-rich electronic invoice formats, designed to help your company allocate and reconcile UPS charges more effectively. To learn more or enroll in these options, visit ups.com/billing.

Solutions	Description	Benefits
UPS Billing Center	<ul style="list-style-type: none"> – A secure, easy-to-use website that allows you to view, pay and request adjustments to your invoice online. – Provides invoices electronically through online reporting, customized reports or downloading a file of your invoice similar to UPS Billing Data in PDF, CSV (32 and 250 elements) or XML formats. – To learn more, visit ups.com/billing. 	<ul style="list-style-type: none"> – An electronic alternative to receiving paper bills for package and freight services, including Brokerage and UPS Mail Innovations® service. – Receive invoices faster. – Set up/arrange to have payments sent electronically, eliminating the printing and mailing of checks. – Access to supporting brokerage documents (e.g., Commercial Invoice) for U.S. import shipments. – Create/download summary or detailed reports to improve cost allocation for package shipments.* – Print as much or as little of the invoices as needed. – Electronic filing of invoices saves time and space.
UPS Billing Data	<ul style="list-style-type: none"> – UPS Billing Data is a detailed electronic billing file that can be received in a CSV, XML or EDI 210 format. – To learn more, visit ups.com/billing. 	<ul style="list-style-type: none"> – An electronic alternative to receiving paper bills for package and freight services. – Receive invoices faster. – Allows the integration of UPS billing information into accounting and other business applications. – Facilitates faster and easier invoice reconciliation, cost allocation and accounts payable processes.
UPS PDF Invoice	<ul style="list-style-type: none"> – The electronic document is an exact copy of your paper bill and is available for domestic, export, import and LTL bills. – When your bill is ready, UPS will send you an e-mail that directs you to ups.com to receive your invoice. 	<ul style="list-style-type: none"> – Able to view up to 52 weeks of PDF invoices. – Easy record-keeping and allows you to view your statements faster.
UPS Paper Bill	<ul style="list-style-type: none"> – Receive a summary or detailed paper bill sent via the U.S. Mail. 	<ul style="list-style-type: none"> – Does not require a computer to review shipping charges.
coyote.com	<ul style="list-style-type: none"> – Provides direct access for customers to create, view, track and settle their own loads, and for carriers to find, accept and update loads. – Call 1-877-626-9683 or coyote.com/technology for more information. 	<ul style="list-style-type: none"> – Network map includes filters to provide a focused, filtered view and ability to hover over lane to see lane information. – Customizable load board allows users to add or remove columns to view the most valuable information. – Streamlined accounting features allow for uploading paperwork, viewing invoices and checking accounting status. – Simplified tracking allows you to flag and track high-priority shipments, export entire load activity for easy viewing and mark specific commodities to quickly view all related shipments.

*Not available for Air Freight, Ocean Freight and UPS Worldwide Expedited® Ground Freight.

Reviewing Your Invoice

PACKAGE

UPS Billing and Payment Schedules

Schedules	Description
Billed Weekly/Pay Weekly	<ul style="list-style-type: none"> – Receive an invoice weekly and pay weekly. – Payment is due within the terms stated on the invoice. – A late payment fee will be assessed on balances that are past due. – Payment can be made by Electronic Funds Transfer, credit card or check. – Electronic Payment options are available via the UPS Billing Center.
Billed Weekly/Pay Monthly	<ul style="list-style-type: none"> – Receive an invoice weekly but pay only once a month. – A prepayment equal to four weeks' average shipping charges must be made and will remain on account with UPS. – Payment is due within the terms stated on the invoice. – A late payment fee will be assessed on balances that are past due. – Payment can be made by Electronic Funds Transfer or check. – Electronic Payment options are available via the UPS Billing Center.
Billed Monthly/Pay Monthly*	<ul style="list-style-type: none"> – Receive an invoice monthly and pay monthly. – A prepayment equal to four weeks' average shipping charges must be made and will remain on account with UPS. – To avoid a prepayment, a Credit Extension Fee can be charged based on your annual shipping charges and is subject to change annually. – Establishing an Electronic Funds Transfer payment option allows you to avoid a prepayment and the Credit Extension Fee. – Payment is due within the terms stated on the invoice. – A late payment fee will be assessed on balances that are past due. – Payment can be made by Electronic Funds Transfer or check. – Electronic Payment options are available via the UPS Billing Center.

*Monthly billing is limited to customers with average shipping charges of \$200.00 or less per week. To be eligible for the Credit Extension Plan, you must use UPS transportation services solely for business, commercial or agricultural purposes. The first-year fee is \$45.00. The fee for each following year will be based on yearly revenue. If the yearly revenue is under \$15,600.00, the fee will be \$45.00. If the yearly revenue exceeds \$15,600.00, the fee will be the actual yearly revenue multiplied by .0163.

Notes:

- UPS reserves the right to approve billing and payment schedules and payment methods requested.
- The "UPS Tariff/Terms and Conditions of Service – United States" available at [ups.com/terms](https://www.ups.com/terms) contains provisions for a late payment fee on past-due balances (including, without limitation, any previously assessed, but unpaid, late payment fees).
- The shipper should check with its bank to ensure that there are no fees for electronic transactions.

Reviewing Your Invoice

Solutions for Managing Your Invoice

UPS offers a variety of options to help you manage your shipping costs by allowing you to determine who pays what portion of the shipping charges.

UPS Billing/Payer Options

Options	Description
PACKAGE, AIR FREIGHT, LESS-THAN-TRUCKLOAD AND UPS WORLDWIDE EXPEDITED® GROUND FREIGHT	
Bill Shipper (Prepaid)	– Shipper's UPS account is billed for shipping charges.
Bill Receiver (Freight Collect)	– Receiver's UPS account is billed for shipping charges.
Bill Third Party	– A third party's UPS account is billed for shipping charges.
INTERNATIONAL PACKAGE	
Free Domicile	– The shipper pays all costs of delivery, including customs clearance fees, directly to the door of the consignee.
Split Duty and Tax	– Shipper's UPS account is billed for shipping charges and duties. – Receiver's UPS account is billed for all taxes.
AIR FREIGHT AND UPS WORLDWIDE EXPEDITED GROUND FREIGHT	
Shipper's Check Received	
– Delivery Duties Paid (DDP)*	Fees vary by country and seller's charges.
– Delivery Duties Unpaid (DDU)*	Importer is responsible for fees that vary by country.

**For a quoted price, the seller/exporter clears the goods for export and is responsible for making them available to the buyer at the named place of destination cleared for import, but not unloading them from the transport vehicle.*

Notes:

- For international shipments, the above billing options can be used in combination with one another, allowing the shipper, receiver or third party to be billed for all or part of the shipping charges. International shipping charges typically include the cost of transportation, duties, brokerage fees and taxes.
- Unless otherwise specified at the time of shipping, shipping charges are billed to the shipper. In the event of non-payment by the consignee or third party, the charges are billed to the shipper.

Managing Inbound Charges

Control who can and cannot bill shipping charges to your UPS account number. There are two convenient ways to manage this process. Select the option that is appropriate for your business needs.

– Allow any shipper to bill shipping charges to your UPS account number, except for certain shippers you wish to exclude.

– Allow only certain shippers to bill shipping charges to your UPS account and exclude all others.

To begin controlling your inbound charges, go to [ups.com/billing](https://www.ups.com/billing).

Consolidated Payment Plans

A Consolidated Payment Plan offers a convenient way to aggregate UPS invoices for multiple UPS account numbers into a single invoice for payment.

Consolidated Payment Plans can be created for UPS domestic, export and import invoices.

To learn more about Consolidated Payment Plans, call 1-800-PICK-UPS® (1-800-542-5877).

Managing Additional Charges

Additional charges can occur when shipments are not processed properly.

Tips for avoiding these charges may be found at [ups.com/avoidcharges](https://www.ups.com/avoidcharges).

Index

A

Additional Charges	
<i>See Value-Added Services and Other Charges</i>	112-138
Additional Consignee or Invoice	136
Additional Handling	113, 122
Address Correction	113, 127
Air Freight	129
Package	122
UPS Worldwide Expedited Ground Freight	133
Adult Signature Required	112, 118, 141
Air Freight Services	74-75
Air Shipping Documents (ASDs)	22
Alcoholic Beverages	8
Alliance Location (Staples)	9, 24
Ammunition	8
Authorized Shipping Outlet	9, 24
Automated Processing	
Air Freight	21, 22
LTL	21, 22
Package	21, 22

B

Batteries	11
Bill of Lading	
Corrected Bill of Lading	127, 131
LTL	22
Billing Options	112
Air Freight	144
LTL	144
Package	114, 143-145
Bonds	
Continuous Transaction Bond	136
In-Transit Bond (IT Bond)	136
Single Entry Bond (SEB)	136
Branded Tracking from UPS	112, 114
Brokerage Services	76, 94, 134-138
Bundled or Strapped Boxes	11

C

Canada	
Canada Zone Chart	
Export	33-37
Import	42
UPS Standard	
From Canada	4, 42, 94, 107-109, 135
To Canada	4, 33-37, 76, 88-90
UPS 3 Day Select from Canada	4, 42, 94, 106, 135
UPS Worldwide Service to Canada	4
Certificate of Origin	112, 114, 126
Air Freight	128
Package	114
UPS Worldwide Expedited Ground Freight	132
Chargeback for Consignee Billing Shipments	113, 127
Air Freight	129
Package	122
UPS Worldwide Expedited Ground Freight	133
Check	142, 143, 144
Claims	141
Collect on Delivery (C.O.D.) Services	112, 126
C.O.D. Automatic	114
C.O.D. Direct	114
C.O.D. Secure	115
C.O.D. Service Restrictions	8
Delayed Deposit	114
LTL	130
Manual C.O.D. Tags	114
Package	114
Complex Entries	136
Corrected Bill of Lading	127, 131
Coyote Logistics	21, 140, 142
Collaborative Transportation Management	5, 6
CoyoteHOWL	22, 140
Truckload and Intermodal	5, 6
Credit Extension Fee	143
Currency Conversion Rate	112, 115
Customer Service	
International Customer Service	76, 94
Customized Brokerage Services	137
Customized Returns	119
Customs Brokerage	76, 94, 134-138
Customs Clearance Entry Preparation Charges	135
Customs Entry Packets	137

Index

D

Daily On-Route Pickup	23 , 112 , 120
Daily Pickup	23 , 112 , 120
Dangerous Goods	113 , 127
Air Freight	129
International	123
Day-Specific Pickup	23 , 112 , 120
Declared Value for Carriage	112 , 126
Air Freight	128
LTL	130
Package	115
UPS Worldwide Expedited Ground Freight	132
Dedicated Contract Carriage	6
Delivery Area Surcharge	113 , 122
Commercial, Commercial Extended	122
Residential, Residential Extended	122
Delivery Attempt	
Air Freight	129
UPS Worldwide Expedited Ground Freight	133
Delivery Change Options	115
Delivery Change Request	112 , 115
Delivery Reattempt	115 , 122
Destination Outside Service Area	113 , 122
Detention of Vehicle	127
LTL	131
UPS Worldwide Expedited Ground Freight	133
Determine the Rate	
Domestic, Export and Import	26-27
Determine the Weight and Size	16-20
Air Freight	19-20
Domestic Shipments	16-17
International Shipments	16-17
Irregularly Shaped Packages	17
Items Shipped in Bags	17
Letter Rates	17
UPS Worldwide Expedited Ground Freight	19
UPS Worldwide Express Freight	18
UPS Worldwide Express Freight Midday	18
Determine the Zone	
Domestic	27
Export	27
Import	27
Dimensional Weight	
Air Freight	19-20
Package	16-17 , 76 , 94
Domestic	16-17
International	16-17
UPS Worldwide Expedited Ground Freight	19
UPS Worldwide Express Freight	18
UPS Worldwide Express Freight Midday	18
Direct Delivery Only	112 , 116
Disbursement Fee	137

D (continued)

Documentation	
Air Shipping Documents (ASDs)	22
Domestic Package Rates and Services	
UPS Express Critical	4 , 5 , 7
UPS Ground	4 , 68-71
UPS Next Day Air	4 , 48-51
UPS Next Day Air Early	4 , 44-47
UPS Next Day Air Saver	4 , 52-55
UPS 2nd Day Air	4 , 60-63
UPS 2nd Day Air A.M.	4 , 56-59
UPS 3 Day Select	4 , 64-67
Domestic Freight Service Options	
Air Freight	74-75
LTL	6
TL and Intermodal	6
Dry Ice	7 , 113 , 123
Duty	137
Duty Drawbacks	136

E

Electronic Export Information (E.E.I.)	112 , 116
Electronic Funds Transfer	143
Electronic Label	116
Electronic Media	11 , 17
Electronic Return Label	112 , 119
Entry-Line Charge	136
Export Support	76 , 94
Extended Area Surcharge	113 , 123

F

Fabric and Wallpaper	11
Firearms	8
Fish and Wildlife (F&W) Entry Preparation	136
Flex Global View	140
Foreign Trade Zone (FTZ) Entry	136
Formal Entry	138
Freight Between the U.S. and Mexico	4 , 5 , 126 , 127
Freight Preparation	13-15
Fuel Surcharge	114-125 , 128-133
Full Container Load (FCL) NVOCC Service	5

Index

G

Ground Shipping Documents [22](#)

H

Hazardous Materials and Dangerous Goods [113, 127](#)
 Air Freight [129](#)
 LTL [131](#)
 Package [123](#)

Hazardous Materials and
 International Dangerous Goods [7, 8, 113, 123](#)

Hazardous Materials Service Restrictions
 Setting Up Service [7](#)
 To and From Alaska, Hawaii, Puerto Rico
 and Catalina Island [7](#)

Hearing Impaired Service Number 1-800-833-0056

Heavy Package [12](#)

Heavy Package Sticker [12](#)

Hold at Destination Airport for Pickup (HAPU) [126](#)
 Air Freight [128](#)
 UPS Worldwide Expedited Ground Freight [132](#)

Hold at Location [112, 116](#)

Hold for Pickup [112, 116](#)

I

Import Support [76, 94](#)

Inside Delivery and Inside Pickup [127, 131](#)

Intermodal [6](#)

International Customer Service Center 1-800-782-7892

International Dangerous Goods (IDG) [7, 8, 113, 123](#)

International Freight Services [4, 5](#)

International Rates and Services

UPS Air Freight Consolidated [4](#)

UPS Air Freight Direct [4](#)

UPS Air Freight Premium Direct [4](#)

UPS Express Critical [4, 5](#)

UPS Standard from Canada [4, 94, 107-108, 135](#)

UPS Standard to Canada [4, 33-37, 76, 88-90](#)

UPS Standard from Mexico [4, 109-111](#)

UPS Standard to Mexico [4, 76, 91-93](#)

UPS 3 Day Select from Canada [4, 94, 106](#)

UPS Worldwide Expedited [4, 5, 76, 85-87, 94, 103-105](#)

UPS Worldwide Express [4, 76, 77-79, 94, 95-97](#)

UPS Worldwide Express Freight [4, 76, 81, 94, 99](#)

UPS Worldwide Express Freight Midday [4, 76, 80, 94, 98](#)

UPS Worldwide Express NA1 [4, 94, 95-97](#)

UPS Worldwide Express Plus [4, 76, 77-79, 94, 95-97](#)

UPS Worldwide Saver [4, 76, 82-84, 94, 100-102](#)

I (continued)

International Service Options [4, 5](#)

Invoice

Air Freight [144](#)

Invoice Removal [116](#)

LTL [144](#)

Package [136, 143-144](#)

UPS Worldwide Expedited Ground Freight [144](#)

Irregularly Shaped Items and Bare Metals [12](#)

J

Jewelry [8](#)

L

Label

Electronic Label [116](#)

Electronic Return Label [112, 119](#)

1 UPS Pickup Attempt Label [112, 116, 119](#)

Print and Mail Label [116](#)

Print and Mail Return Label [112, 119](#)

Print Label [116](#)

Print Return Label [112, 119](#)

3 UPS Pickup Attempts Label [112, 116, 119](#)

UPS Smart Label [22](#)

Large and/or Heavy Packages [12](#)

Large Package Surcharge [17, 113, 123](#)

Late Payment Fee [143](#)

Less-Than-Container Load (LCL) NVOCC Service [5](#)

Less-Than-Truckload (LTL) Services

LTL [5, 6](#)

LTL Guaranteed [5, 6](#)

LTL Guaranteed A.M. [5, 6](#)

LTL Urgent [5, 6](#)

Liftgate Services [127](#)

Air Freight [129](#)

LTL [131](#)

UPS Worldwide Expedited Ground Freight [133](#)

Limited Quantities (Ltd Qty) [7, 24, 26, 27](#)

Index

M

Manual Processing	
LTL	22
Package	22
Marking Notice Processing	138
Maximum Declared Values	8
Maximum Length	8
Maximum Size	8
Maximum Weight	8
Merchandise Processing Fee	138
Mexico	
UPS Standard	
From Mexico	4, 109-111, 135
To Mexico	4, 91-93
Zone Chart	38, 43
Missing/Invalid Account Number or Refusal Fee	113, 127
Air Freight	129
Package	124
UPS Worldwide Expedited Ground Freight	133
Missing PLD Fee	124
MyFreight	21
My LTL Freight	21

N

Non-Conforming Freight	127
Air Freight	129
UPS Worldwide Expedited Ground Freight	133
Non-Resident Importer (NRI)	112, 118
North American Freight	5
Notification Prior to Delivery	127, 131

O

Ocean Freight	5
Ocean Freight Forwarding	5
1 UPS Pickup Attempt Label	112, 116, 119
Other Charges	113, 127
Air Freight	129
LTL	131
Package	122-125
UPS Worldwide Expedited Ground Freight	133
Over Maximum Limits	113, 124
Oversize	127
Air Freight	129
LTL	131
UPS Worldwide Expedited Ground Freight	133
Oversize Pallet Handling Surcharge	113, 124
Overtime/Special Handling Service	138

P

Pack & Ship Guarantee	12, 24
Package Tracking, Tracing and Refund Requests	113, 124
Packaging Assistance	
Packaging Advisor	12
Packing Services	12
UPS Package Design and Test Lab	12
Packaging Guidelines	13-15
Air Freight	13-15
LTL	13-15
UPS Worldwide Expedited Ground Freight	13-15
UPS Worldwide Express Freight	13-15
UPS Worldwide Express Freight Middy	13-15
Packaging Needs	
Heavy Package	12
Packages Weighing More Than 70 Pounds	12
Special Packaging Needs	11-12
Palletized Freight	13-15
Non-Palletized Freight	13, 15
Palletized Shipments	13, 80, 98
International Palletized Shipments	18
Partner Government Agency (PGA) Clearance	137
Payer Rebilling Fee	127
Air Freight	129
UPS Worldwide Expedited Ground Freight	133
Payment Options	142-144
Peak Surcharges	124
Pickup and Drop-off Availability	23-24
Pickup Area Surcharge	113, 124
Pickup Notifications for LTL	23
Post Entry Services	138
Prepare Your Shipment	
<i>See Packaging Guidelines</i>	13
Pre-Release Notification	138
Print and Mail Label	116
Print and Mail Return Label	112, 119
Print Label	116
Print Return Label	112, 119
Prior Notice for Food and Food Products	137
Prohibited and Restricted Goods	
Export and Import	7-9
Package	7-9
Prohibited Item Fee	113, 124
Project Cargo Management	5
PRO Number	14, 140
Proof of Delivery (P.O.D.)	112, 126
Air Freight	128
LTL	130
Package	118, 141
UPS Worldwide Expedited Ground Freight	132

Index

Q

Quantum View Data	140
Quantum View Manage	140
Quantum View Notify	140

R

Rates	
Air Freight	27, 74-75
Package	
Domestic	27, 44-71
Export	27, 77-93
Import	27, 95-111
Rebill Fee	113, 124
Redelivery	127
Air Freight	129
LTL	131
UPS Worldwide Expedited Ground Freight	133
Reference Number	140
Remote Area Surcharge	113, 125
Residential Delivery/Pickup	127
Air Freight	129
LTL	131
UPS Worldwide Expedited Ground Freight	133
Residential Surcharge	113, 125
Returns and The UPS Store	112, 119
Reviewing Your Invoice	142-144

S

Saturday Air Processing Fee (Saturday Pickup)	112
Package	120
Saturday Delivery	112, 126
Air Freight	128
Package	118
Saturday Pickup	112, 126
Air Freight	128
Package	120
Saturday Stop Charge	112, 120
Scheduled Pickup	112, 120
UPS On-Call Pickup	112, 120
UPS Smart Pickup	112, 120

S (continued)

Saturday, Sunday or Holiday Delivery	126, 130
LTL	130
Saturday, Sunday or Holiday Pickup	126, 130
LTL	130
Scheduled Pickup Options	23, 120
Daily On-Route Pickup	23, 112, 120
Daily Pickup	23, 112, 120
Day-Specific Pickup	23, 112, 120
Package	23, 120
UPS Smart Pickup	23, 112, 120
Service Options	
Air Freight	4, 5
LTL	5, 6
Package	
Domestic	4
International	4, 5
Truckload and Intermodal	5, 6
Service Restrictions	7-9
Air Freight	7-9
LTL	7-9
Package	7-9
Prohibited and Restricted Goods	8-9
Ship to a UPS Access Point Location	112, 118
Shipment Pricing	
Export	76
Import	94
Shipper Release	112, 121
Shipper's Export Declaration (S.E.D.)	
<i>See Electronic Export Information</i>	112, 116
Shipping Charge Correction Audit Fee	113, 125
Shipping Forms	76, 94
Shipping Solutions	21-22
Signature Required	112, 118, 141
Signature Tracking	141
Special Handling of Undeliverable Shipments	113, 125
Special Packaging Needs (Package)	11-12
Staples	9, 24
State Classifications and Abbreviations	
West and East	28
Storage	127, 131

Index

T

Table of Contents	2
Telecommunications Device for the Deaf Service Number	1-800-833-0056
Temperature Protection Services	6
Temporary Import Under Bond	137
The UPS Store	9, 12, 24, 117, 119
Thermal Label Printer	22
Third Party Billing Service	112, 121
Third-Party Retail Locations Alliance Location [Staples] as well as Authorized Shipping Outlets	9, 24
3 UPS Pickup Attempts Label	112, 116, 119
Tires	12
Tobacco	9
Track Your Shipment	140-141
Flex Global View	140
PRO Number	140
Quantum View Data	140
Quantum View Manage	140
Quantum View Notify	140
Reference Number	140
Text Message	140
Tracking Number	140
UPS App	140
UPS InfoNotice Number	140
UPS My Choice	140
UPS My Choice for Business	140
Trade Show Services	6
Transportation Handling	138
Truck Waiting Time	127
Air Freight	129
UPS Worldwide Expedited Ground Freight	133

U

Undeliverable Shipment Surcharge	113, 125
United States-Mexico-Canada Agreement (USMCA) Processing	138
ups.com	140
ups.com shipping	21
UPS Access Point	24, 112, 118
UPS Air Freight Consolidated	4, 19
UPS Air Freight Direct	4, 19
UPS Air Freight Premium Direct	4, 19
UPS Alliance Location (Staples)	9, 24
UPS App	22, 140
UPS Authorized Return Service	112, 119
UPS Authorized Shipping Outlet	9, 24

U (continued)

UPS Billing and Payment Schedules	
Billed Monthly/Pay Monthly	143
Billed Weekly/Pay Monthly	143
Billed Weekly/Pay Weekly	143
UPS Billing Center	142
UPS Billing Data	142
UPS Billing/Payer Options	
Bill Receiver (Freight Collect)	144
Bill Shipper (Prepaid)	144
Bill Third Party	144
Free Domicile	144
Shipper's Check Received	144
Split Duty and Tax	144
UPS Broker of Choice	134, 137
UPS CampusShip	21
UPS carbon neutral	112, 114
UPS C.O.D.	114
UPS Customer Center	24
UPS Delivery Confirmation	112, 115, 141
UPS Delivery Intercept	112, 115
UPS Developer Kit	22
UPS Drop Box	24
UPS Express Critical	4, 5
UPS Express Pak	17
upsfreight.com	140
UPS Freight Services	
Dedicated Contract Carriage	5, 6
LTL	5, 6, 23, 126, 127
LTL Guaranteed	5, 6, 23, 126, 127
LTL Guaranteed A.M.	5, 6, 23, 126, 127
LTL Urgent	5, 6, 23, 126, 127
Temperature Protection Services	5, 6, 23
Trade Show Services	5, 6, 23
UPS FTZ Facilitator	135, 137
UPS Ground	4, 22, 68-71, 112, 113
UPS Ground Shipping Documents	22
UPS Ground with Freight Pricing	4, 6, 112, 113
UPS Hundredweight Service	6
UPS Import Control	94, 112, 117
UPS InfoNotice Number	140
UPS Mail Innovations Returns	119
UPS marketplace shipping	21
UPS My Choice for Business	112, 117
UPS My Choice	112, 117, 140
UPS My Choice Member	117
UPS My Choice Premium Member	117
UPS Next Day Air Letter Rate	4, 48-51, 112, 113 48

Index

U (continued)

UPS Next Day Air Early Letter Rate	4, 44-47, 112, 113 44
UPS Next Day Air Freight	5, 19, 74, 126, 127
UPS Next Day Air Freight NGS	5, 19, 75, 126, 127
UPS Next Day Air Saver Letter Rate	4, 52-55, 112, 113 52
UPS On-Call Pickup	23, 112, 118, 120
UPS On-Call Pickup Area Surcharge	113, 124
UPS On-Call Pickup Saturday Stop Charge	112, 120
UPS Package Design and Test Lab	12, 14
UPS Paper Bill	142
UPS Paperless Invoice	76, 94
UPS Preferred Multimodal Freight Services	5
UPS Premier	112, 118
UPS Ready	21, 22
UPS Returns	
Customized Returns	119
Returns and The UPS Store	112, 119
UPS Mail Innovations Returns	119
UPS Returns Exchange	112, 119
UPS Returns Services	9, 119
UPS 2nd Day Air Letter Rate	4, 60-63, 112, 113 60
UPS 2nd Day Air A.M. Letter Rate	4, 56-59, 112, 113 56
UPS 2nd Day Air Freight	5, 19, 74, 126, 127
UPS 2nd Day Air Freight NGS	5, 19, 75, 126, 127
UPS Service Guarantee	125, 134, 135
UPS Services	
Air Freight	4, 5
Domestic	4, 5
International	4, 5
LTL	5, 6
Truckload and Intermodal	5, 6
UPS Services Website Address	ups.com/services
UPS Simple Rate	72-73
UPS Smart Label	22
UPS Smart Pickup	23, 112, 120
UPS Smart Pickup Saturday Stop Charge	112, 120
UPS Standard	
From Canada	4, 42, 94, 107-108, 112, 113, 135
From Mexico	4, 43, 109-111, 112, 113, 135
To Canada	4, 33-37, 76, 88-90, 112, 113
To Mexico	4, 38, 76, 91-93, 112, 113
UPS Standard LTL	5, 126, 127
UPS Standard Truckload	5
UPS Standard Zone Chart	
From Canada	42
From Mexico	43
To Canada	33-37
To Mexico	38

U (continued)

UPS Supply Chain Solutions Call Centers	23
UPS Supply Chain Solutions Quick Zip	74, 75
UPS 3 Day Freight	5, 19, 74, 126, 127
UPS 3 Day Freight NGS	5, 19, 75, 126, 127
UPS 3 Day Select	4, 7, 22, 64-67,
UPS 3 Day Select from Canada	4, 42, 94, 106, 112, 113, 135
UPS TradeAbility	76, 94
UPS Website Address	ups.com
UPS Worldwide Expedited	112, 113
Export	4, 29-37, 76, 85-87
Import	4, 39-41, 94, 103-105, 135
UPS Worldwide Expedited Air Freight	5, 19
UPS Worldwide Expedited Ground Freight	5, 19, 126, 127, 132, 133
UPS Worldwide Expedited Truckload	5
UPS Worldwide Express	112, 113
Export	4, 29-37, 76, 77-79
10 KG Box	77
25 KG Box	77
Letter Rate	77
Pak Rate	77
Import	4, 39-41, 94, 95-97, 135
Letter Rate	95
UPS Worldwide Express Freight	112, 113
Export	4, 29-37, 76, 81
Import	4, 39-41, 94, 99, 135
UPS Worldwide Express Freight Center	24
UPS Worldwide Express Freight Midday	112, 113
Export	4, 29-37, 76, 80
Import	4, 39-41, 94, 98, 135
UPS Worldwide Express NA1	112, 113
Import	4, 39, 40, 41, 94, 95-97, 135
Letter Rate	95
UPS Worldwide Express Plus	112, 113
Export	4, 29-37, 76, 77-79
10 KG Box	77
25 KG Box	77
Letter Rate	77
Pak Rate	77
Import	4, 39-41, 94, 95-97, 135
Letter Rate	95
UPS Worldwide Saver	112, 113
Export	4, 29-37, 76, 82-84
10 KG Box	82
25 KG Box	82
Letter Rate	82
Pak Rate	82
Import	4, 39-41, 94, 100-102, 135
Letter Rate	100
UPS Worldwide Services Waybill	22

Index

V

Value-Added Services	112 , 126
Air Freight	128
LTL	130
Package	114-121
UPS Worldwide Expedited Ground Freight	132
Vaping Products	9

W

Warehouse	
Entry	137
Storage	138
Waybill	22
Weapons	8
Weight and Size Information	
Air Freight	19
Package	16-17
UPS Worldwide Expedited Ground Freight	19
UPS Worldwide Express Freight	18
UPS Worldwide Express Freight Midday	18
West and East State Classifications	28
World Ease	112 , 121
WorldShip	21

Z

Zone Charts	
Air Freight	27 , 29-43
Package	
Determine the Zone	27 , 29-43
International Export	
Except Canada	29-32
To Canada	33-37
To Mexico	38
International Import	
UPS Standard from Mexico	43
UPS 3 Day Select and UPS Standard from Canada	42



[ups.com](https://www.ups.com)

© 2021 United Parcel Service of America, Inc. UPS, the UPS brandmark and the color brown are trademarks of United Parcel Service of America, Inc. All rights reserved. 4/21



2019 Annual Report



Accelerating Forward >>>

CUSTOMER FIRST. PEOPLE LED. INNOVATION DRIVEN.



YEAR FOUNDED: **1907**

2285 DAILY FLIGHT SEGMENTS

WORLDWIDE OPERATING FACILITIES: **MORE THAN 2,500**

ALTERNATIVE FUEL VEHICLES: **MORE THAN 10,000**

OVER 40,000 UPS ACCESS POINT LOCATIONS

2019 DELIVERY VOLUME: **5.5 BILLION** PACKAGES AND DOCUMENTS

MORE THAN 125,000 VEHICLES IN DELIVERY FLEET

UPS MY CHOICE[®] MEMBERS: **67 MILLION**

ONLINE TRACKING: **295 MILLION** PER DAY

11.5 MILLION CUSTOMERS

EMPLOYEES: **495,000**

FINANCIAL HIGHLIGHTS

(in millions except per-share amounts)

	2019	2018	2017
Revenue	\$74,094	\$71,861	\$66,585
Operating expenses	66,296	64,837	59,056
Net income	4,440	4,791	4,905
Adjusted net income*	6,543	6,301	5,254
Diluted earnings per share	5.11	5.51	5.61
Adjusted diluted earnings per share*	7.53	7.24	6.00
Dividends declared per share	3.84	3.64	3.32
Assets	57,857	50,016	45,574
Long-term debt	21,818	19,931	20,278
Shareowners' equity	3,283	3,037	1,024
Capital expenditures ¹	6,380	6,283	5,227
Cash and marketable securities	5,741	5,035	4,069

KEY METRICS

	2019	2018	2017
Return on Assets (GAAP)	8.2%	10.0%	11.4%
Return on Assets (Adjusted)*	12.3%	13.3%	12.1%
Dividend Yield	3.3%	3.7%	2.6%

FREE CASH FLOW

(millions of dollars)

	2019	2018	2017
Net cash from operations	\$8,639	\$12,711	\$1,479
Capital expenditures ¹	(6,380)	(6,283)	(5,227)
Proceeds from disposals of PP&E	65	37	24
Net change in finance receivables	13	4	5
Other investing activities	(75)	1	1
Free cash flow ²	2,262	6,470	(3,718)
Discretionary pension contributions	2,000	-	7,291
Adjusted free cash flow excluding discretionary pension contributions	4,262	6,470	3,573

*See reconciliation of Non-GAAP financial measures on page A1.

¹Adjusted capital expenditures including principal repayments of finance lease obligations were \$6.520 and \$6.623 billion in 2019 and 2018, respectively.

²Adjusted free cash flow including principal repayments of finance lease obligations was \$4.122 and \$6.130 billion in 2019 and 2018, respectively.



Dear Fellow Shareowner,

2019 was a year of momentum for UPS.

We reached several important turning points in our transformation as we accelerate forward and progress to become the fastest, most technology-enabled company in our industry. Our global integrated network provided UPS and our customers great flexibility to respond to the fast pace of change in the market. Our innovative services and solutions helped our customers compete and grow, especially the small and medium-sized businesses (SMBs) we serve. And our people led us forward, delivering great service and fostering a culture of continuous transformation.

2019 also marked a significant milestone in UPS history. We celebrated the 20th anniversary of our initial public offering, the largest U.S. IPO on the New York Stock Exchange in the 20th century. Even 20 years ago, UPS recognized the need to transform to facilitate growth. The IPO strengthened our ability to grow, invest and make strategic acquisitions in markets around the world. It also laid the groundwork for the integrated Smart Global Logistics Network we operate today.

Our integrated network continues to expand and strengthen, and is powered by next-generation technology that is also enabling our enterprise-wide transformation. Technology is improving efficiency, creating additional flexibility, and increasing speed and scalability. It is the backbone of our industry-leading, data-driven solutions like UPS My Choice for Business and our Digital Access Program. It is the force that is enabling us to meet the growing demand of global B2B and B2C e-commerce. And it is the connective tissue that integrates UPS physical assets with our increasingly digital world.

Such innovations make it easier for customers to connect with UPS, access our services and enjoy more control over their inbound and outbound shipments. Our network is more responsive to the changing pickup and delivery conditions, thanks to our expanded use of route optimization and navigation software. Importantly, these actions and investments enable us to operate more sustainably. When coupled with our alternative fuel and alternative fleet solutions, we are reducing our environmental impact, the benefits of which will create long-term value for all stakeholders.

We are investing to increase efficiency and to create new capabilities that will generate high-quality volume growth. We launched more new solutions in 2019 than at any other time in recent history. The impacts of our transformation are becoming more visible in our operating performance, even as we invest in new capabilities. We achieved this success due to the creativity and commitment of our 495,000 UPSers around the world.

CUSTOMER FIRST. PEOPLE LED. INNOVATION DRIVEN.

Accelerating DELIVERIES

Speed of delivery is becoming increasingly important to consumers and is a critical competitive differentiator for many of our customers, both large and small. In 2019, we took advantage of the structural shift to faster next-day delivery, leveraging the strength of our expanding automated network to successfully absorb a 22% surge in next-day air volume, while strengthening our position as the e-commerce shipper of choice.

The rapid movement toward next-day and seven-day delivery in the U.S. provides tremendous near-term growth opportunities and we are taking aggressive steps forward to continue speeding up our network to help all customers adapt, especially SMBs. For example, we are improving time-in-transit for 80% of our customers, doubling the amount of volume we handle on Saturdays and launching Sunday delivery. These actions are enabling UPS to take advantage of today's opportunities, while continuing to diversify our growing customer base and generate long-term profitable growth.

In 2019, we forged new paths to accelerate deliveries, creating innovative solutions for our customers. We achieved a milestone in commercial drone aviation when the Federal Aviation Administration (FAA) certified UPS with the first full Part 135 Standard to operate a drone airline at WakeMed, moving lab samples across its vast hospital campus. Working in partnership with the FAA on approvals, we tested similar services at other hospitals and medical campuses, proving drone solutions can accelerate deliveries and provide shortened time-in-transit, helping healthcare professionals better serve their patients. We are continuing to work with the FAA to expand our drone capabilities, as well as create new, breakthrough solutions to serve the evolving needs of our customers.

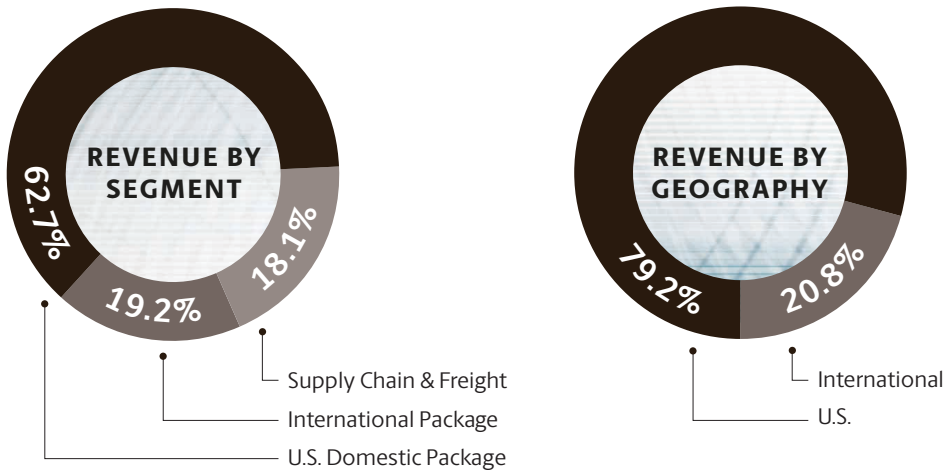

REVENUE (in billions of dollars)



NET INCOME (in billions of dollars)

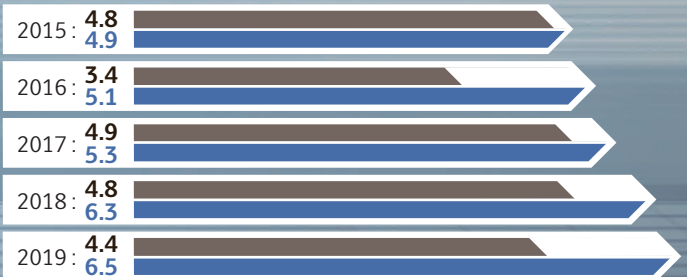

■ Adjusted*

*See reconciliation of Non-GAAP financial measures on page A1.

Accelerating EFFICIENCIES

We made great strides expanding capacity and automating our Smart Global Logistics Network. Across the U.S., increased automation and improved efficiency drove unit costs down in 2019, helping fuel positive operating leverage and profit growth in the year. Adjusted operating margins expanded 50 basis points*†, an indication that our strategy and investments are improving the fundamentals of the business.

As we move through our transformation and open more automated facilities, we remain confident that we will achieve our goal of a 30% to 35% increase in efficiency. The investments we are making are creating a more nimble, more competitive UPS, to better serve customers today and well into the future.

Here are some highlights for the year:

- >>> We added 11 high-capacity aircraft to our global fleet, the largest annual addition to date, in our multi-year fleet expansion program.
- >>> We opened 20 new or retrofitted automated facilities, adding nearly five million square feet and about 400,000 pieces per hour of automated sort capacity. Combined with 2018, we have opened a total of 41 facilities with 10 million square feet and approximately 800,000 pieces per hour of additional sort capacity.
- >>> We pulled forward efforts to accelerate the U.S. ground network, widening the reach of our next-day ground capabilities and speeding up transit times in key lanes.
- >>> In Europe, we opened a highly-automated superhub in Eindhoven, the Netherlands, a strategic location to connect Western European businesses to our Smart Global Logistics Network and facilitate market access around the world.
- >>> In Asia, time-in-transit improvements and the expansion of our Shenzhen, China air hub are enabling UPS to take advantage of regional growth.
- >>> We made wide-spread technology investments to expand our use of cloud infrastructure, improve cash flow management, and enhance procurement practices — all of which contributed to positive operating leverage.
- >>> We advanced the development of ORION 3.0, our proprietary route optimization and navigation technology that dynamically adjusts and recalculates driver routes based on the remaining packages and pickup requests on the route, together with changing traffic conditions and other factors. Deployment in 2020 is on schedule.

The investments we are making are strengthening our core business. Our integrated network is running exceptionally well, generating new levels of efficiency and flexibility. We continually adjust our network to align capacity with changes in market demand around the world, which results in a lower cost structure and positive operating leverage.

*See reconciliation of Non-GAAP financial measures on page A1.

†One basis point equals one-hundredth of a percentage point.



CUSTOMER FIRST. PEOPLE LED. INNOVATION DRIVEN.

Accelerating GROWTH

In addition to creating greater efficiency and agility in the network, our transformation program is funding reinvestment in new state-of-the-art, customer-focused services and solutions. Our program is enabling UPS to pursue the best market opportunities for diversified revenue growth and long-term financial returns. These growth opportunities constitute our four Strategic Growth Initiatives:

>>> Small and Medium-sized Businesses (SMBs)

- We increased the number and variety of retail partners in our UPS Access Point network significantly in 2019, expanding the network to approximately 21,000 locations in the U.S. and 40,000 globally. Ninety percent of U.S. consumers will find a UPS Access Point location within five miles of their home, offering a new level of package pickup and drop-off convenience.
- We launched UPS My Choice for Business, giving small businesses unprecedented visibility and control over their inbound and outbound shipments.

>>> B2B and B2C e-Commerce

- We introduced the UPS Digital Access Program creating preferred relationships and embedding UPS technology directly into leading marketplaces and digital platforms such as Stamps.com, which many SMBs already use. Retail is becoming increasingly integrated across all digital channels as SMBs leverage tools to access larger pools of potential customers than they could have reached on their own. UPS's footprint touches all aspects of the e-commerce ecosystem, from demand generation and shipping to visibility and returns.
- UPS now enables customers to tender shipments later for next-day ground delivery to 98% of the U.S. population. UPS Extended Hours Pickup for next-day ground delivery solidifies our market leading position in both next-day air and ground coverage.
- We expanded Saturday pickups and deliveries to help our customers deliver to consumers faster. And, in 2020 we expect to double the amount of Saturday volume we handled in 2019, and will continue to phase in Sunday delivery.

>>> International Growth Markets

- B2B and B2C businesses that export to key e-commerce destinations around the world now have a more affordable way to ship with UPS Worldwide Economy. This deferred service provides economical and efficient international options for small businesses shipping lightweight and less-expensive products.
- Customers are now able to reach more destinations with the expansion of our Express services. Postal codes across 40 countries in Europe, Asia, Latin America, Africa and the Middle East were added, significantly expanding the footprint of our time- and day-definite guaranteed international services.

>>> Healthcare and Life Sciences

- Healthcare and life sciences customers often need a higher level of visibility and security for their most-critical shipments. To meet those needs, we created UPS Premier (next-generation, on-package sensor technology) which enables advanced package tracking and contingency actions for critical shipments.
- Additionally, we connected all of our global healthcare and life sciences businesses under a single, dedicated UPS Healthcare unit. Wes Wheeler, a healthcare professional with deep experience, leads the unit which supports operations and includes a combined workforce of more than 5,000 employees from Marken, Polar Speed, and all 114 UPS healthcare facilities.

We are moving quickly and intelligently to provide our customers new levels of speed, visibility, control and market access while creating new revenue streams for UPS. And our solutions are taking hold: in 2019, we grew consolidated volume 5.8%, while expanding our operating margins in all three segments. We outpaced the market in U.S. air growth with double-digit volume increases in Next Day Air and our deferred services. Looking forward, we see many opportunities to accelerate high-quality, high-margin volume growth.



DILUTED EARNINGS PER SHARE (in dollars)



OPERATING MARGIN (percent)

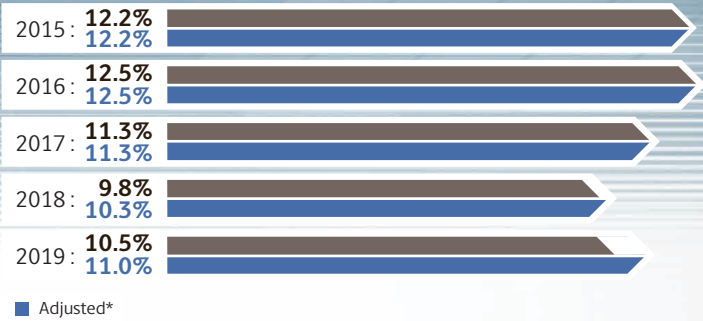

DIVIDENDS DECLARED (dollars per share)

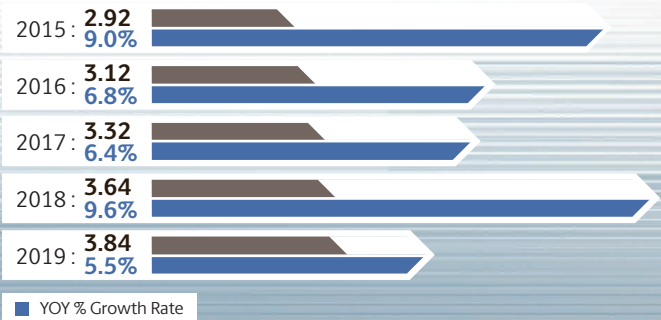

SHARE REPURCHASE EXPENDITURES (in billions of dollars)



*See reconciliation of Non-GAAP financial measures on page A1.

CUSTOMER FIRST. PEOPLE LED. INNOVATION DRIVEN.

Accelerating EXECUTION

Our financial results demonstrate that our investments and strong execution are having an impact on the fundamentals of the business. Both top- and bottom-line results improved in 2019 due to increased demand for our services and new cost efficiencies in our network.

For the company, consolidated revenue grew 3.1% to \$74 billion and adjusted operating profit grew 10.4% to \$8.2 billion*.

Globally, we delivered more than 5.5 billion packages, a nearly 6% increase over 2018, driven by B2B and B2C volume growth in the U.S., which helped offset softness in global trade, particularly during the second half of the year.

In U.S. Domestic, revenue grew 6.7% to \$46.5 billion with volume growth across all products. Adjusted operating profit grew 12.7% to \$4.4 billion* and we generated a margin of 9.4%*, or 50 basis points higher than in 2018.

The International segment reported \$14.2 billion in revenue, a decrease of 1.5% due to the dynamic macro environment. Adjusted operating profit rose 6.7% to \$2.8 billion* and margins expanded, primarily driven by strong execution, cost management and innovative services with a focus on SMB market opportunities.

The Supply Chain and Freight segment delivered another year of strong results, with an 11.2%* increase in adjusted operating profit and healthy margin expansion. The diversity of our portfolio, coupled with our continued focus on SMBs, helped offset softer business conditions in certain business units.

Once again, UPS generated excellent cash flow — enabling us to invest in our network while rewarding shareowners. We invested \$6.5 billion* in adjusted capital expenditures and returned \$4.3 billion to shareowners, with \$1 billion of share buybacks and \$3.3 billion in dividends, a per-share increase of 5.5% over the prior year.

Executing our strategies for the long-term benefits all stakeholders — our shareowners, customers, employees, suppliers, and the communities we serve. Operating more sustainably is a core principle of our strategy and business operations. We pursue efficiency at every turn and deploy advanced technology to optimize resources and reduce our environmental impact. We are proud to have been named to the Dow Jones Sustainability World Index for the seventh consecutive year and the Dow Jones Sustainability North America Index for the 15th straight year. Plus, *Corporate Responsibility Magazine* named UPS to its “100 Best Corporate Citizens” annual listing for the 10th straight year.

*See reconciliation of Non-GAAP financial measures on page A1.



Accelerating FORWARD

We are making significant progress in our transformation. Through the investments we are making today, our network — powered by next-generation advanced technologies — will become even more efficient and flexible. And as we look ahead, we will continue to introduce innovative solutions to help all of our customers grow. We are accelerating our strategies to take advantage of the tremendous growth prospects in the market today. Our actions will open new opportunities for our people and create additional value for our customers and shareowners in the near-term and well into the coming decade.

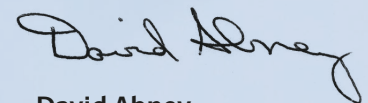

David Abney

*UPS Chairman and
Chief Executive Officer*



MANAGEMENT COMMITTEE



DAVID P. ABNEY
UPS Chairman and Chief
Executive Officer



PHILIPPE GILBERT
President, Supply
Chain Solutions



JUAN PEREZ
Chief Information and
Engineering Officer



KEVIN WARREN
Chief Marketing Officer



**NORMAN M.
BROTHERS, JR.**
Senior Vice President,
General Counsel and
Corporate Secretary



KATE GUTMANN
Chief Sales and
Solutions Officer



SCOTT PRICE
Chief Strategy and
Transformation Officer



GEORGE WILLIS
President, U.S. Operations



NANDO CESARONE
President,
UPS International



BRIAN NEWMAN
Chief Financial Officer



CHARLENE THOMAS
Chief Human
Resources Officer

UPS BOARD OF DIRECTORS

DAVID P. ABNEY
Chairman and Chief
Executive Officer,
United Parcel Service, Inc.
Director since 2014

WILLIAM R. JOHNSON
Former Chairman, President
and Chief Executive Officer,
H.J. Heinz Company
Director since 2009

FRANCK J. MOISON
Former Vice Chairman,
Colgate-Palmolive Company
Director since 2017

JOHN T. STANKEY
President and Chief Operating
Officer, AT&T Inc. and CEO,
Warner Media LLC
Director since 2014

RODNEY C. ADKINS
Former Senior Vice
President, International
Business Machines
Director since 2013

ANN M. LIVERMORE
Former Executive Vice
President, Hewlett-
Packard Company
Director since 1997

CLARK T. RANDT, JR.
Former U.S. Ambassador
to the People's Republic
of China
Director since 2010

CAROL B. TOMÉ
Former Chief Financial Officer
and Executive Vice President —
Corporate Services,
The Home Depot, Inc.
Director since 2003

MICHAEL J. BURNS
Former Chairman, President
and Chief Executive Officer,
Dana Corporation
Director since 2005

RUDY H.P. MARKHAM
Former Financial Director,
Unilever
Director since 2007

CHRISTIANA SMITH SHI
Former President,
Direct-to-Consumer,
Nike, Inc.
Director since 2018

KEVIN WARSH
Former Member of the Board
of Governors of the Federal
Reserve System, Distinguished
Visiting Fellow, Hoover
Institution, Stanford University
Director since 2012

**UNITED STATES
SECURITIES AND EXCHANGE COMMISSION**

Washington, D.C. 20549

Form 10-K

(Mark One)

ANNUAL REPORT PURSUANT TO SECTION 13 OR 15(d) OF THE SECURITIES EXCHANGE ACT OF 1934

For the fiscal year ended December 31, 2019
or

TRANSITION REPORT PURSUANT TO SECTION 13 OR 15(d) OF THE SECURITIES EXCHANGE ACT OF 1934

For the transition period from _____ to _____
Commission file number 001-15451



United Parcel Service, Inc.
(Exact name of registrant as specified in its charter)

Delaware

*(State or Other Jurisdiction of
Incorporation or Organization)*

55 Glenlake Parkway, N.E. Atlanta, Georgia
(Address of Principal Executive Offices)

58-2480149

*(I.R.S. Employer
Identification No.)*

30328
(Zip Code)

(404) 828-6000

(Registrant's telephone number, including area code)

Securities registered pursuant to Section 12(b) of the Act:

Title of Each Class	Trading Symbol	Name of Each Exchange on Which Registered
Class B common stock, par value \$.01 per share	UPS	New York Stock Exchange
Floating-Rate Senior Notes due 2020	UPS20A	New York Stock Exchange
1.625% Senior Notes due 2025	UPS25	New York Stock Exchange
1% Senior Notes due 2028	UPS28	New York Stock Exchange
0.375% Senior Notes due 2023	UPS23A	New York Stock Exchange
1.500% Senior Notes due 2032	UPS32	New York Stock Exchange

Securities registered pursuant to Section 12(g) of the Act:

Class A common stock, par value \$.01 per share

(Title of Class)

Indicate by check mark if the registrant is a well-known seasoned issuer, as defined in Rule 405 of the Securities Act. Yes No

Indicate by check mark if the registrant is not required to file reports pursuant to Section 13 or Section 15(d) of the Exchange Act. Yes No

Indicate by check mark whether the registrant: (1) has filed all reports required to be filed by Section 13 or 15(d) of the Securities Exchange Act of 1934 during the preceding 12 months (or for such shorter period that the registrant was required to file such reports), and (2) has been subject to such filing requirements for the past 90 days. Yes No

Indicate by check mark whether the registrant has submitted electronically every Interactive Data File required to be submitted pursuant to Rule 405 of Regulation S-T (Section 232.405 of this chapter) during the preceding 12 months (or for such shorter period that the registrant was required to submit such files). Yes No

Indicate by check mark whether the registrant is a large accelerated filer, an accelerated filer, a non-accelerated filer, a smaller reporting company, or an emerging growth company. See definitions of "large accelerated filer", "accelerated filer", "smaller reporting company," and "emerging growth company" in Rule 12b-2 of the Exchange Act.

Large accelerated filer Accelerated filer Non-accelerated filer Smaller reporting company Emerging growth company

If an emerging growth company, indicate by check mark if the registrant has elected not to use the extended transition period for complying with any new or revised financial accounting standards provided pursuant to Section 13(a) of the Exchange Act.

Indicate by check mark whether the registrant is a shell company (as defined in Rule 12b-2 of the Exchange Act). Yes No

The aggregate market value of the class B common stock held by non-affiliates of the registrant was \$72,097,367,231 as of June 30, 2019. The registrant's class A common stock is not listed on a national securities exchange or traded in an organized over-the-counter market, but each share of the registrant's class A common stock is convertible into one share of the registrant's class B common stock.

As of February 6, 2020, there were 156,399,660 outstanding shares of class A common stock and 702,088,016 outstanding shares of class B common stock.

DOCUMENTS INCORPORATED BY REFERENCE

Portions of the registrant's definitive proxy statement for its annual meeting of shareowners scheduled for May 14, 2020 are incorporated by reference into Part III of this report.

UNITED PARCEL SERVICE, INC.
ANNUAL REPORT ON FORM 10-K
TABLE OF CONTENTS

PART I

Item 1.	<u>Business</u>	<u>1</u>
	<u>Overview</u>	<u>1</u>
	<u>Strategy</u>	<u>1</u>
	<u>Products and Services; Reporting Segments</u>	<u>2</u>
	<u>People</u>	<u>6</u>
	<u>Customers</u>	<u>6</u>
	<u>Competition</u>	<u>6</u>
	<u>Competitive Strengths</u>	<u>6</u>
	<u>Government Regulation</u>	<u>7</u>
	<u>Where You Can Find More Information</u>	<u>8</u>
Item 1A.	<u>Risk Factors</u>	<u>10</u>
Item 1B.	<u>Unresolved Staff Comments</u>	<u>17</u>
Item 2.	<u>Properties</u>	<u>17</u>
	<u>Operating Facilities</u>	<u>17</u>
	<u>Fleet</u>	<u>18</u>
Item 3.	<u>Legal Proceedings</u>	<u>18</u>
Item 4.	<u>Mine Safety Disclosures</u>	<u>18</u>

PART II

Item 5.	<u>Market for Registrant’s Common Equity, Related Stockholder Matters and Issuer Purchases of Equity Securities</u>	<u>19</u>
	<u>Shareowner Return Performance Graph</u>	<u>20</u>
Item 6.	<u>Selected Financial Data</u>	<u>21</u>
Item 7.	<u>Management’s Discussion and Analysis of Financial Condition and Results of Operations</u>	<u>22</u>
	<u>Overview</u>	<u>22</u>
	<u>Supplemental Information - Items Affecting Comparability</u>	<u>23</u>
	<u>U.S. Domestic Package Operations</u>	<u>27</u>
	<u>International Package Operations</u>	<u>30</u>
	<u>Supply Chain & Freight Operations</u>	<u>33</u>
	<u>Consolidated Operating Expenses</u>	<u>35</u>
	<u>Other Income and (Expense)</u>	<u>37</u>
	<u>Income Tax Expense</u>	<u>38</u>
	<u>Liquidity and Capital Resources</u>	<u>39</u>
	<u>Collective Bargaining Agreements</u>	<u>44</u>
	<u>New Accounting Pronouncements</u>	<u>44</u>
	<u>Rate Adjustments</u>	<u>44</u>
	<u>Critical Accounting Policies and Estimates</u>	<u>45</u>
Item 7A.	<u>Quantitative and Qualitative Disclosures about Market Risk</u>	<u>50</u>
Item 8.	<u>Financial Statements and Supplementary Data</u>	<u>52</u>
Item 9.	<u>Changes in and Disagreements with Accountants on Accounting and Financial Disclosure</u>	<u>129</u>
Item 9A.	<u>Controls and Procedures</u>	<u>129</u>
Item 9B.	<u>Other Information</u>	<u>130</u>

PART III

Item 10.	<u>Directors, Executive Officers and Corporate Governance</u>	<u>131</u>
Item 11.	<u>Executive Compensation</u>	<u>132</u>
Item 12.	<u>Security Ownership of Certain Beneficial Owners and Management and Related Stockholder Matters</u>	<u>132</u>
Item 13.	<u>Certain Relationships and Related Transactions, and Director Independence</u>	<u>132</u>
Item 14.	<u>Principal Accountant Fees and Services</u>	<u>132</u>

PART IV

Item 15.	<u>Exhibits and Financial Statement Schedules</u>	<u>133</u>
Item 16.	<u>Form 10-K Summary</u>	<u>133</u>

PART I

Cautionary Statement About Forward-Looking Statements

This report, our Annual Report to Shareowners and our other filings with the Securities and Exchange Commission (“SEC”) contain “forward-looking statements” within the meaning of the Private Securities Litigation Reform Act of 1995. Statements other than those of current or historical fact, and all statements accompanied by terms such as “believe,” “project,” “expect,” “estimate,” “assume,” “intend,” “anticipate,” “target,” “plan” and variations thereof and similar terms, are intended to be forward-looking statements. Forward-looking statements are made subject to the safe harbor protections of the federal securities laws pursuant to Section 27A of the Securities Act of 1933 and Section 21E of the Securities Exchange Act of 1934.

From time to time, we also include written or oral forward-looking statements in other publicly disclosed materials. Such statements relate to our intent, belief and current expectations about our strategic direction, prospects and future results, and give our current expectations or forecasts of future events; they do not relate strictly to historical or current facts. Management believes that these forward-looking statements are reasonable as and when made. However, caution should be taken not to place undue reliance on any such forward-looking statements because such statements speak only as of the date when made.

Forward-looking statements are subject to certain risks and uncertainties that could cause actual results to differ materially from our historical experience and our present expectations or anticipated results. These risks and uncertainties are described in Part I, “Item 1A. Risk Factors” and may also be described from time to time in our future reports filed with the SEC. You should consider the limitations on, and risks associated with, forward-looking statements and not unduly rely on the accuracy of predictions contained in such forward-looking statements. We do not undertake any obligation to update forward-looking statements to reflect events, circumstances, changes in expectations or the occurrence of unanticipated events after the date of those statements.

Item 1. *Business*

Overview

United Parcel Service, Inc. (“UPS”) was founded in 1907 as a private messenger and delivery service in Seattle, Washington. Today, we are the world’s largest package delivery company, a leader in the U.S. less-than-truckload industry and a premier provider of global supply chain management solutions. The global market for these services includes transportation, distribution, contract logistics, ground freight, ocean freight, air freight, customs brokerage, insurance and financing.

We operate one of the largest airlines in the world, as well as the world’s largest fleet of alternative-powered vehicles. We deliver packages each business day for 1.6 million shipping customers to 9.9 million delivery customers in over 220 countries and territories. In 2019, we delivered an average of 21.9 million pieces per day, or a total of 5.5 billion packages. Total revenue in 2019 was \$74.094 billion.

We have three reporting segments: U.S. Domestic Package and International Package, which together we refer to as our global small package operations, and Supply Chain & Freight, all of which are described below.

Strategy

Our strategy is to provide advanced logistics solutions made possible by a broad portfolio of differentiated services and capabilities integrated into our customers’ businesses. This strategy, supported by our efficient global multimodal network, enables us to deliver value to, and build lasting relationships with, our customers.

Customers are able to leverage our broad portfolio of logistics capabilities comprised of: our extensive presence in North America, Europe, Middle East, Africa, Asia Pacific and Latin America; our reliability; and our industry-leading technologies and solutions.

We offer a full range of industry-leading products, services and capabilities across a growing geographical and industry footprint. Achieving our objectives has required new methods and innovative approaches to develop and implement logistics services that address customer needs for speed to market, visibility, reliability and greater control. Recent examples include:

- the acquisition or creation of platform-based offerings such as UPS e-fulfillment and Ware2Go;
- specialized healthcare solutions such as UPS Premier, which offers prioritized handling and visibility for critical healthcare shipments;
- a full range of global customs brokerage and shipment insurance services; and
- offerings such as UPS My Choice for business that give small- and medium-sized businesses ("SMBs") greater control, visibility and data access to improve their customer service.

We monitor global trade, economic, geopolitical, regulatory and environmental factors, as well as other factors impacting the business environment. We quickly implement measures to convert risk to opportunity and help our customers adjust their supply chains to a fast-moving world. We have a long history of joint ventures and partnerships that provide operational flexibility and the ability to acquire new capabilities as we build scale, and we also forge new marketplace alliances to stay at the cutting edge of business. For example, our Digital Access Program makes it easier for SMBs to use our services by embedding our shipping solutions directly into leading e-commerce platforms.

We are a disciplined and focused business that purposefully reinvests capital to achieve both long-term strategic benefits and favorable returns. In September 2018, we communicated our commitment to continuous transformation and to invest to modernize our business and operations through state-of-the art technology. We see transformation as an ongoing commitment to enhance quality and efficiency as we deliver innovative capabilities and services. Our strategic investments are primarily focused in areas we believe will drive growth and lasting profit potential:

- services and solutions for SMBs;
- international growth markets;
- global Business to Consumer ("B2C") and Business to Business ("B2B") e-commerce;
- healthcare and life-sciences logistics; and
- operational improvements to drive greater productivity and the use of automation to enhance the efficiency of our network.

In recent periods, we have added approximately ten million square feet of highly automated capacity in more than forty new and remodeled facilities globally. We have also continued to implement numerous new technologies to help control the network and ensure resources are in the right place at the right time.

Products and Services; Reporting Segments

Global Small Package

Our global small package operations provide time-definite delivery services for express letters, documents, small packages and palletized freight via air and ground services. These services are supported by numerous shipping, visibility and billing technologies.

All types of service (air, ground, domestic, international, commercial and residential) are managed through a single, global integrated pickup and delivery network. We combine all packages within our network, unless dictated by specific service commitments. This enables one UPS driver to pick up customers' shipments for any services at a scheduled time each day. Our integrated network uniquely provides operational and capital efficiencies that have less of an impact on the environment than single service network designs.

We handle packages up to 108 inches in length that weigh up to 150 pounds and are up to 165 inches in combined length and girth, as well as palletized shipments weighing more than 150 pounds. We offer same-day pickup of air and ground packages seven days a week. Our global network offers approximately 150,000 entry points where customers can tender a package to us at a location or time convenient to them. This integrated network includes UPS drivers who can accept packages, UPS drop boxes, UPS Access Point locations, The UPS Store locations, authorized shipping outlets and commercial counters, alliance locations and customer centers attached to UPS facilities. The UPS Access Point network, which includes local small businesses, national retailers and self-serve lockers, allows consumers to ship or redirect packages to an alternate delivery location or drop off pre-labeled packages, including returns. We have expanded the UPS Access Point network to total approximately 21,000 locations within the U.S. and 40,000 globally.

We have developed a robust portfolio of returns services in more than 145 countries resulting from the continued growth of online and mobile shopping that has increased our customers' need for efficient and reliable returns. This portfolio provides a range of cost-effective label options and a broad network of consumer drop points, as well as a selection of returns technologies that promote efficiency and a friction-free consumer experience. These options include solutions such as UPS Returns, as well as more-specialized services such as UPS Returns Exchange. Our technologies, such as UPS Returns Manager promote systems integration, customer ease of use and visibility of inbound merchandise, which help reduce costs and improve efficiency in our customers' reverse logistics processes.

Our global air operations are centered at our Worldport hub in Louisville, Kentucky. Our U.S. regional air hubs in Dallas, Texas; Ontario, California; Philadelphia, Pennsylvania and Rockford, Illinois support Worldport. Our European air hub is located in Cologne, Germany, and we maintain Asia Pacific air hubs in Shanghai, China; Shenzhen, China and Hong Kong. Our regional air hub in Canada is located in Hamilton, Ontario and our regional air hub for Latin America and the Caribbean is in Miami, Florida. This network design creates cost-effective package processing in our most technology-enabled facilities, which allows us to use fewer, larger and more fuel-efficient aircraft.

U.S. Domestic Package Reporting Segment

We are a leader in time-definite, guaranteed small package delivery services in the United States. We offer a full spectrum of U.S. domestic guaranteed air and ground package transportation services, and our U.S. ground fleet serves all business and residential zip codes in the contiguous United States.

- UPS's Air portfolio offers options enabling customers to specify a time-of-day guarantee for their delivery (e.g. by 8:00 A.M., 10:30 A.M., noon, end of day, etc.), while selecting from same day, next day, two day and three day delivery alternatives.
- Customers can also leverage our extensive ground network to ship using our day-definite guaranteed Ground service. We deliver more ground packages in the U.S. than any other carrier, with average daily package volume of 15 million, most within one to three business days.
- We offer UPS SurePost, an economy residential ground service for customers with non-urgent, lightweight residential shipments. UPS SurePost is a residential ground service that combines the consistency and reliability of the UPS ground network with final delivery often provided by the U.S. Postal Service.

International Package Reporting Segment

Our International Package reporting segment consists of our small package operations in Europe, Asia Pacific, Canada, Latin America and the Indian sub-continent, Middle East and Africa ("ISMEA"). We offer a wide selection of guaranteed day- and time-definite international shipping services. We offer more guaranteed time-definite express options (Express Plus, Express and Express Saver) than any other carrier.

In recent years we have continued the expansion of our Express time-definite portfolio, with certain products now reaching as many as 220 countries and territories. For international package shipments that do not require Express services, UPS Worldwide Expedited offers a reliable, deferred, guaranteed day-definite service option. The service is now available from more than 80 origin countries to more than 220 countries and territories. For cross-border ground package delivery, we offer UPS Standard delivery services within Europe, between the U.S. and Canada and between the U.S. and Mexico.

By expanding our time-definite services, we are better able to offer customers the services they need in the places they do business. For businesses with time-sensitive shipments, these upgrades can help replenish inventories quicker, improve time to market and meet urgent delivery requirements.

Europe, our largest region outside of the U.S., accounts for approximately half of our international small package segment revenue and is one of the primary drivers of our growth. We continue to make major European infrastructure investments, including new hubs in London, Paris and Eindhoven, the Netherlands.

Asia Pacific also remains a strategic market due to growth rates in intra-Asia trade. To capitalize on these opportunities, we have continued to bring faster time-in-transit to customers focused on intra-Asia trade and reduced transit times from Asia to the U.S. and Europe. Through added flight frequencies, we now provide our customers the ability to ship next day to more places in the U.S. and Europe - guaranteed - than any other express carrier. We serve more than 40 Asia Pacific countries and territories through more than two dozen alliances with local delivery companies that supplement our owned operations. For example, our joint venture with SF Express combines SF's extensive Chinese network with UPS's delivery capabilities in the U.S. and Europe, increasing our market presence and providing Chinese enterprises with greater global access. In addition, improvements to time-in-transit for UPS Express Saver and UPS Worldwide Expedited services to Shanghai have resulted in faster delivery by a full day to 185 postal codes for packages coming from Europe.

International high-growth markets remain one of our strategic imperatives. Our direct flight from the U.S. to Dubai has improved time-in-transit to key destinations in ISMEA for shippers throughout the U.S., Canada and the Americas. Markets like India also provide opportunities for growth. In support of this, we acquired full ownership of our express services unit in 2018. The unit helps Indian businesses, large and small, connect with global markets via the UPS network. This follows the opening of two integrated logistics facilities in Hyderabad and Ahmedabad from where customers are provided a 48-hour delivery timeline to markets in the U.S. and Europe. In addition to these upgrades, we have added Saturday delivery to seven countries in ISMEA and expanded Express Services to India, the Middle East and other international high-growth markets ahead of Expo 2020 in Dubai, offering greater flexibility and competitiveness.

Supply Chain & Freight

Supply Chain & Freight consists of our forwarding, truckload brokerage, logistics, UPS Freight, UPS Capital and other businesses. Supply chain complexity creates demand for a global service offering that incorporates transportation, distribution and international trade and brokerage services, with complementary financial and information services. Outsourcing non-core logistics activity is a strategy more companies are pursuing. With increased competition and growth opportunities in new markets, businesses require flexible and responsive supply chains to support their strategies. We meet this demand by offering a broad array of supply chain services in more than 200 countries and territories.

Forwarding

We are one of the largest U.S. domestic air freight carriers and among the top international air freight forwarders globally. We offer a portfolio of guaranteed and non-guaranteed global air freight services. Additionally, as one of the world's leading non-vessel operating common carriers, we provide ocean freight full-container load, less-than-container load and multimodal transportation services between most major ports around the world.

Truckload Brokerage

Our acquisition of Coyote Logistics, LLC, a U.S.-based third party logistics provider, in 2015 has resulted in synergies in the areas of purchased transportation, backhaul utilization, technology systems and industry best practices. Coyote's access to our fleet, combined with its broad carrier network, has created a customized capacity solution for all markets, customers and situations. In addition, Coyote provides access to UPS services (such as air freight, customs brokerage and global freight forwarding) for its customer base.

Our acquisition of Freightex, a U.K.-based freight brokerage firm, in 2017 added a full scale truckload brokerage and transportation management solution to our European portfolio, creating a single-source solution for shippers throughout Europe with freight ranging from parcel to full truckload. In 2018, Freightex was rebranded as Coyote Logistics to further leverage the centralized technology and business models with the market knowledge, talent and established customer and carrier bases already in Europe. Coyote Logistics's European division complements our North American truckload brokerage business, as many international shippers know and trust the Coyote truckload product.

Logistics

We provide value-added fulfillment and transportation management services to customers through our global network of owned and leased distribution centers and field stocking locations. We leverage a global network of more than 1,000 facilities in more than 100 countries to ensure products and parts are in the right place at the right time.

Our distribution centers are strategically located near UPS air and ground transportation hubs for rapid delivery to consumer and business markets. In 2019, we expanded our network to support new business growth by adding 2 million square feet of distribution capacity. We also continued to expand our cloud-based transportation and warehouse management platforms, driving higher operational efficiency and improved customer service. The result has been better visibility, more rapid onboarding of customers and improved flexibility and response times.

With the strategic focus of serving the unique, priority-handling needs of healthcare and life sciences customers, U.S. healthcare warehouse and distribution space will total approximately 5 million square feet in 2020. Key features in the new facilities include climate controls and validated coolers and freezers for customer products requiring strict temperature-controlled environments.

In 2019, we expanded our e-commerce solutions for SMBs worldwide, offering streamlined fulfillment and shipping services to consumers in the U.S. and Canada. We launched the UPS eFulfillment program to help sellers quickly and easily manage multiple marketplaces. The program, which is compatible with over 20 e-commerce marketplaces, includes a technology platform and physical fulfillment services, such as storage, order processing, packaging and shipping.

UPS Post Sales, our service parts logistics solution, relies on a global network of over 950 central and field stocking sites to provide same and next-day spare parts delivery, enabling customers to get critical equipment back up and running. This solution focuses on customers within the high tech, industrial manufacturing, automotive, healthcare and aerospace sectors. More specific to the healthcare industry, UPS has an implantable medical device solution leveraging 36 field stocking sites, which helps ensure surgical kits and devices arrive safely and on time at hospital and surgery centers. Implantable medical device firms benefit from outsourcing and optimizing their supply chain with UPS, which drives down costs and increases control and service levels.

Also in 2019, UPS announced an expansion of foreign trade zone ("FTZ") management services in the U.S.. Since our acquisition of Zone Solutions in 2017, we have developed a comprehensive FTZ solution that helps clients manage the end-to-end process, from dealing with customers to inventory control. The integration of FTZ services with our logistics network means UPS can designate any of our 42 U.S. distribution centers as a FTZ, allowing customers to take advantage of the program's benefits. The strategic utilization of the FTZ program provides opportunities for duty elimination and duty deferral.

UPS Freight

UPS Freight offers regional, inter-regional and long-haul less-than-truckload ("LTL") services in all 50 states, Canada, Puerto Rico, Guam, the U.S. Virgin Islands and Mexico. UPS Freight provides reliable LTL service backed by a day-definite, on-time guarantee at no additional cost. UPS Freight also provides dedicated contract carriage truckload services. User friendly shipping, visibility and billing technology offerings, including UPS WorldShip, Quantum View and UPS Billing Center, allow freight customers to create electronic bills of lading, monitor shipment progress and reconcile shipping charges.

Customs Brokerage

We are among the world's largest customs brokers by both the number of shipments processed annually and by the number of dedicated brokerage employees worldwide. In addition to customs clearance services, we provide product classification, trade management, duty drawback and consulting services through STTAS, a UPS company.

UPS Capital

UPS Capital provides financial, insurance and payment services to support all aspects of the order-to-cash cycle and help protect companies from risk in their supply chains. Services are available in 22 countries and territories. UPS Capital also offers insured transportation of high value goods including loose gemstones, finished jewelry and wristwatches.

People

The strength of UPS is our people, working together with a common purpose. We have more than 495,000 employees (excluding temporary seasonal employees), of which 413,000 are in the U.S. and 82,000 are located internationally. Our global workforce includes approximately 87,000 management employees (40% of whom are part-time) and 408,000 hourly employees (49% of whom are part-time).

For information regarding employees employed under collective bargaining agreements, see note 6 to the audited, consolidated financial statements.

Customers

As described below, we believe that our focus on building and maintaining long-term customer relationships is a competitive strength of UPS. We serve 1.6 million shipping customers and more than 9.9 million delivery customers daily. For the year ended December 31, 2019, one customer, Amazon.com, Inc. and its affiliates, represented approximately 11.6% of our consolidated revenues, substantially all of which was within our U.S. Domestic Package segment. For additional information on our customers, see "Risk Factors - Changes in our relationships with any of our significant customers, including the loss or reduction in business from one or more of them, could have a material adverse effect on us" and note 13 to the audited, consolidated financial statements.

Competition

We offer a broad array of services in the package and freight delivery industry and compete with many local, regional, national and international logistics providers. We believe our strategy, network and competitive strengths position us well to compete in the marketplace. For additional information on our competitive environment, see "Risk Factors - Our industry is rapidly evolving. We expect to continue to face significant competition, which could adversely affect us".

Competitive Strengths

Our competitive strengths include:

Efficient Multimodal Network. We believe that our integrated global air and ground network is the most extensive in the industry. We provide all types of package services (air, ground, domestic, international, commercial and residential) through a single pickup and delivery network. We also have extensive air freight, ocean freight, ground freight and logistics networks that provide additional capabilities in the global transportation and logistics market. Our sophisticated engineering systems allow us to optimize our network efficiency and asset utilization.

Global Presence. We serve more than 220 countries and territories. We have a significant presence in all of the world's major economies.

Cutting-Edge Technology. Technology powers virtually every service we offer and every operation we perform. We are a global leader in developing technology that helps our customers enhance their shipping and logistics business processes to lower costs, improve service and increase efficiency. We offer a variety of online service options that enable our customers to integrate UPS functionality into their own businesses to send, manage and track their shipments conveniently, and also to provide their customers with better information services. We provide the infrastructure for an internet presence that extends to tens of thousands of customers who have integrated UPS tools directly into their own websites.

Broad Portfolio of Services. Our portfolio of services helps customers choose the delivery option that is most appropriate for their requirements. Increasingly, our customers benefit from business solutions that integrate many UPS services beyond package delivery. For example, our supply chain services – such as freight forwarding, truckload brokerage, customs brokerage, order fulfillment and returns management – help improve the efficiency of the entire supply chain management process.

Customer Relationships. We focus on building and maintaining long-term customer relationships. We serve 1.6 million shipping customers daily and deliver packages to more than 9.9 million delivery customers daily. Cross selling small package and supply chain services across our customer base is an important growth mechanism for UPS.

Brand Equity. We have built a leading and trusted brand that stands for quality, reliability and service innovation. The distinctive appearance of our vehicles and the professional courtesy of our drivers are major contributors to our brand equity.

Distinctive Culture. We believe that the dedication of our employees comes in large part from our distinctive “employee-owner” concept. Our employee stock ownership tradition dates back to 1927, when our founders, who believed that employee stock ownership was a vital foundation for successful business, created our first stock ownership program.

Financial Strength. Our financial strength allows us to achieve global scale; to invest in employee development, technology, transportation equipment and facilities; to pursue strategic opportunities that facilitate our growth; to service our obligations and to return value to our shareowners.

Government Regulation

We are subject to numerous laws and regulations in the countries in which we operate. Key laws and regulations are summarized below.

Air Operations

The U.S. Department of Transportation (“DOT”), the Federal Aviation Administration (“FAA”) and the U.S. Department of Homeland Security, through the Transportation Security Administration (“TSA”), have regulatory authority over our air transportation services. The Federal Aviation Act of 1958, as amended, is the statutory basis for DOT and FAA authority and the Aviation and Transportation Security Act of 2001, as amended, is the basis for TSA aviation security authority.

The DOT’s authority primarily relates to economic aspects of air transportation, such as operations, authority, insurance requirements, pricing, non-competitive practices, interlocking relations and cooperative agreements. The DOT also regulates, subject to the authority of the President of the United States, international routes, fares, rates and practices and is authorized to investigate and take action against discriminatory treatment of U.S. air carriers abroad. International operating rights for U.S. airlines are usually subject to bilateral agreements between the U.S. and foreign governments or, in the absence of such agreements, by principles of reciprocity. We are also subject to current and potential aviation regulations imposed by governments in other countries in which we operate, including registration and license requirements and security regulations. We have international route operating rights granted by the DOT and we may apply for additional authorities when those operating rights are available and are required for the efficient operation of our international network. The efficiency and flexibility of our international air transportation network is dependent on DOT and foreign government regulations and operating restrictions.

The FAA’s authority primarily relates to safety aspects of air transportation, including certification, aircraft operating procedures, transportation of hazardous materials, record keeping standards and maintenance activities and personnel. In 1988, the FAA granted us an operating certificate, which remains in effect so long as we meet the safety and operational requirements of the applicable FAA regulations. In addition, we are subject to non-U.S. government regulation of aviation rights involving non-U.S. jurisdictions and non-U.S. customs regulation.

UPS's aircraft maintenance programs and procedures, including aircraft inspection and repair at periodic intervals, are approved for all aircraft under FAA regulations. The future cost of repairs pursuant to these programs may fluctuate according to aircraft condition, age and the enactment of additional FAA regulatory requirements.

The TSA regulates various security aspects of air cargo transportation in a manner consistent with the TSA mission statement to “protect the Nation’s transportation systems to ensure freedom of movement for people and commerce.” Our airport and off-airport locations, as well as our personnel, facilities and procedures involved in air cargo transportation must comply with TSA regulations.

UPS Airlines, along with a number of other U.S. domestic airlines, participates in the Civil Reserve Air Fleet (“CRAF”) program. Our participation in the CRAF program allows the U.S. Department of Defense (“DOD”) to requisition specified UPS Airlines aircraft for military use during a national defense emergency. The DOD is required to compensate us for the use of aircraft under the CRAF program. In addition, participation in CRAF entitles us to bid for other U.S. Government opportunities including small package and air freight.

Ground Operations

Our ground transportation of packages in the U.S. is subject to regulation by the DOT and its agency, the Federal Motor Carrier Safety Administration (the “FMCSA”). Ground transportation also falls under state jurisdiction with respect to the regulation of operations, safety and insurance. Our ground transportation of hazardous materials in the U.S. is subject to regulation by the DOT's Pipeline and Hazardous Materials Safety Administration. We also must comply with safety and fitness regulations promulgated by the FMCSA, including those relating to drug and alcohol testing and hours of service for drivers. We are subject to similar regulation in many non-U.S. jurisdictions.

The Postal Reorganization Act of 1970 created the U.S. Postal Service as an independent establishment of the executive branch of the federal government, and created the Postal Rate Commission, an independent agency, to recommend postal rates. The Postal Accountability and Enhancement Act of 2006 amended the 1970 Act to give the re-named Postal Regulatory Commission revised oversight authority over many aspects of the Postal Service, including postal rates, product offerings and service standards. We sometimes participate in proceedings before the Postal Regulatory Commission in an attempt to secure fair postal rates for competitive services.

Our ground operations are also subject to compliance with various cargo-security and transportation regulations issued by the U.S. Department of Homeland Security, including regulation by the TSA.

Customs

We are subject to the customs laws regarding the import and export of shipments in the countries in which we operate, including those related to the filing of documents on behalf of client importers and exporters. Our activities in the U.S., including customs brokerage and freight forwarding, are subject to regulation by the Bureau of Customs and Border Protection, the TSA, the U.S. Federal Maritime Commission and the DOT. Our international operations are subject to similar regulatory structures in their respective jurisdictions.

Environmental

We are subject to federal, state and local environmental laws and regulations across all of our business units. These laws and regulations cover a variety of processes, including, but not limited to: properly storing, handling and disposing of waste materials; appropriately managing waste water and stormwater; monitoring and maintaining the integrity of underground storage tanks; complying with laws regarding clean air, including those governing emissions; protecting against and appropriately responding to spills and releases and communicating the presence of reportable quantities of hazardous materials to local responders. We have established site- and activity-specific environmental compliance and pollution prevention programs to address our environmental responsibilities and remain compliant. In addition, we have created numerous programs which seek to minimize waste and prevent pollution within our operations.

Pursuant to the Federal Aviation Act, the FAA, with the assistance of the Environmental Protection Agency is authorized to establish standards governing aircraft noise. Our aircraft fleet is in compliance with current noise standards of the federal aviation regulations. Our international operations are also subject to noise regulations in certain countries in which we operate.

Communications and Data Protection

Because of our extensive use of radio and other communication facilities in our aircraft and ground transportation operations, we are subject to the Federal Communications Act of 1934, as amended. In addition, the Federal Communications Commission regulates and licenses our activities pertaining to satellite communications. There has recently been increased regulatory and enforcement focus on data protection in the U.S. (at both the state and federal level) and in other countries. For example, the European Union ("E.U.") General Data Protection Regulation ("GDPR"), which became effective in May 2018, greatly increases the jurisdictional reach of E.U. law and increases the requirements related to personal data, including individual notice and opt-out preferences and public disclosure of significant data breaches. Additionally, violations of the GDPR can result in significant fines. Other governments have enacted or are enacting similar data protection laws, and are considering data localization laws that would govern the use of data outside of their respective jurisdictions.

Where You Can Find More Information

We maintain a website at www.ups.com. Our annual report on Form 10-K, quarterly reports on Form 10-Q, current reports on Form 8-K and any amendments to those reports filed with or furnished to the SEC pursuant to Section 13(a) of the Securities Exchange Act of 1934 are made available free of charge through our investor relations website at www.investors.ups.com under the heading "Financials - SEC Filings" as soon as reasonably practical after we electronically file or furnish the reports to the SEC. We have a written Code of Business Conduct that applies to all of our directors, officers and employees, including our principal executive and financial officers. It is available under the heading "ESG"- Governance Documents" on our investor relations website. In the event that we make changes in, or provide waivers from, the provisions of the Code of Business Conduct that the SEC requires us to disclose, we intend to disclose these events within four business days following the date of the amendment or waiver in that section of our investor relations website.

Our Corporate Governance Guidelines and the Charters for our Audit Committee, Compensation Committee, Executive Committee, Risk Committee and Nominating and Corporate Governance Committee are also available under the heading "ESG- Governance Documents" on our investor relations website.

Our sustainability report, which describes our activities that support our commitment to acting responsibly and contributing to society, is available at www.sustainability.ups.com.

We provide the addresses to our internet sites solely for information. We do not intend for any addresses to be active links or to otherwise incorporate the contents of any website into this or any other report we file with the SEC.

Item 1A. Risk Factors

Our business, financial condition and results are subject to numerous risks and uncertainties. In connection with any investment decision, you should carefully consider the following significant factors, which could materially affect us, including impacting our business, financial condition, results of operations, stock price or credit rating, as well as our reputation. You should read these risk factors in conjunction with “Management’s Discussion and Analysis of Financial Condition and Results of Operations” in Item 7 and our Consolidated Financial Statements and related notes in Item 8. These risks are not the only ones we face. We could also be affected by other events, factors or uncertainties that are unknown to us, or that we do not currently consider to be significant risks.

Changes in general economic conditions, in the U.S. and internationally, may adversely affect us.

We conduct operations in over 220 countries and territories. Our operations are subject to cyclicity affecting national and international economies in general, as well as the local economic environments in which we operate. The factors that result in general economic changes are beyond our control, and it may be difficult for us to adjust our business model to mitigate the impact of these factors. In particular, our business is affected by levels of industrial production, consumer spending and retail activity and we could be materially affected by adverse developments in these aspects of the economy. In addition, there remains substantial economic uncertainty arising from the United Kingdom’s decision to leave the European Union. The U.K. and the E.U. continue to negotiate the future relationship between themselves, which could take several years to finalize. The outcome of these negotiations could result in, among other things, transportation delays, fewer goods being transported globally, additional volatility in currency exchange rates and further regulations relating to, among other things, trade, aviation and the transport of goods. Any of the foregoing could materially adversely affect us.

Our industry is rapidly evolving. We expect to continue to face significant competition, which could adversely affect us.

Our industry is rapidly evolving, including demand for faster deliveries and increased visibility into shipments. We expect continued significant competition on a local, regional, national and international basis. Our competitors include the postal services of the U.S. and other nations, various motor carriers, express companies, freight forwarders, air couriers, large transportation and e-commerce companies that are making significant investments in their capabilities, and start ups and other companies that combine technologies with crowdsourcing to focus on local market needs, some of whom may currently be our customers. Competition may also come from other sources in the future, including as new technologies are developed. Competitors have cost and organizational structures that differ from ours and from time to time may offer services or pricing terms that we may not be willing or able to offer. Additionally, to remain competitive, from time to time we may have to raise prices and our customers may not be willing to accept these higher prices. If we are unable to timely and appropriately respond to competitive pressures, we could be adversely affected.

Continued transportation industry consolidation may further increase competition. As a result of consolidation, competitors may increase their market share, improve their financial capacity and strengthen their competitive positions. Business combinations could also result in competitors providing a wider variety of services and products at competitive prices, which could adversely affect us.

Changes in our relationships with any of our significant customers, including the loss or reduction in business from one or more of them, could have a material adverse effect on us.

For the year ended December 31, 2019, one customer, Amazon.com and its affiliates, accounted for 11.6% of our consolidated revenues. Some of our other significant customers can account for a relatively significant portion of our revenues in a particular quarter or year. These customers can impact our revenues based on factors such as: customer product launches; e-commerce or other industry trends, such as the seasonality associated with the fourth quarter holiday season; business combinations and the overall growth of a customer's underlying business; as well as any disruptions to their businesses. These customers could choose to divert all or a portion of their business with us to one of our competitors, demand pricing concessions for our services, require us to provide enhanced services that increase our costs, or develop their own shipping and distribution capabilities. In addition, certain of our significant customer contracts include termination rights of either party upon the occurrence of certain events or without cause upon advance notice to the other party. If all or a portion of our business relationships with one or more significant customers were to terminate or be canceled it could materially adversely affect us.

Our business is subject to complex and stringent laws, regulations and policies which could increase our operating costs.

We are subject to complex and stringent aviation, transportation, environmental, security, labor, employment, safety, privacy and data protection and other governmental laws, regulations and policies, both in the U.S. and in other countries in which we operate. In addition, we are impacted by laws, regulations and policies that affect global trade, including tariff and trade policies, export requirements, taxes, monetary policies and other restrictions and charges. Recently, trade discussions between the U.S. and various of its trading partners have been fluid, and existing and future trade agreements are and are expected to continue to be subject to a number of uncertainties, including the imposition of new tariffs or adjustments and changes to the products covered by existing tariffs. The impact of new laws, regulations and policies or decisions or interpretations by authorities applying those laws and regulations, cannot be predicted. Compliance with any new laws or regulations may increase our operating costs or require significant capital expenditures. Any failure to comply with applicable laws, regulations or policies in the U.S. or in any of the other countries in which we operate could result in substantial fines or possible revocation of our authority to conduct our operations, which could adversely affect us.

Increased security requirements impose substantial costs on us and we could be the target of an attack or have a security breach, which could materially adversely affect us.

As a result of concerns about global terrorism and homeland security, governments around the world have adopted or may adopt stricter security requirements that will result in increased operating costs for businesses in the transportation industry. These requirements may change periodically as a result of regulatory and legislative requirements and in response to evolving threats. We cannot determine the effect that any new requirements will have on our cost structure or our operating results, and new rules or other future security requirements may increase our costs of operations and reduce operating efficiencies. Regardless of our compliance with security requirements or the steps we take to secure our facilities or fleet, we could also be the target of an attack or security breaches could occur, which could materially adversely affect us.

Increasingly stringent regulations related to climate change could materially increase our operating costs.

Regulation of greenhouse gas ("GHG") emissions exposes our transportation and logistics businesses to potentially significant new taxes, fees and other costs. Compliance with such regulation, and any increased or additional regulation, or the associated costs is further complicated by the fact that various countries and regions are following different approaches to the regulation of climate change.

For example, in 2009 the European Commission approved the extension to the airline industry of the European Union Emissions Trading Scheme ("ETS") for GHG emissions. Under this decision, all of our flights operating within the European Union are covered by the ETS requirements, and we are required annually to purchase emission allowances in an amount exceeding the number of free allowances allocated to us under the ETS. Similarly, in 2016, the International Civil Aviation Organization ("ICAO") passed a resolution adopting the Carbon Offsetting and Reduction Scheme for International Aviation ("CORSIA"), which is a global, market-based emissions offset program to encourage carbon-neutral growth beyond 2020. A pilot phase is scheduled to begin in 2021 in which countries may voluntarily participate, and full mandatory participation is scheduled to begin in 2027. ICAO continues to develop details regarding implementation, but compliance with CORSIA will increase our operating costs.

In the U.S., Congress in the past several years has considered various bills that would regulate GHG emissions, but these bills so far have not received sufficient Congressional support for enactment. Nevertheless, some form of federal climate change legislation is possible in the future. Even in the absence of such legislation, the Environmental Protection Agency ("EPA"), spurred by judicial interpretation of the Clean Air Act, could determine to regulate GHG emissions, especially aircraft or diesel engine emissions, and this could impose substantial costs on us.

In November 2019, the U.S. began the process to withdraw from the Paris climate accord, an agreement among 196 countries to reduce GHG emissions. The effect of that withdrawal on future U.S. policy regarding GHG emissions, on CORSIA and on other GHG regulation is uncertain. Nevertheless, the extent to which other countries implement that agreement could have an adverse direct or indirect effect on us.

We may face additional regulations regarding GHG emissions internationally and in the United States. Potential costs to us of increased regulation regarding GHG emissions, especially aircraft or diesel engine emissions, include an increase in the cost of the fuel and other energy we purchase and capital costs associated with updating or replacing our aircraft or vehicles prematurely. We cannot predict the impact any future regulation would have on our cost structure or our operating results. It is possible that such regulation could significantly increase our operating costs and that we may not be willing or able to pass such costs along to our customers. Moreover, even without such regulation, increased awareness and any adverse publicity in the global marketplace about the GHGs emitted by companies in the airline and transportation industries could harm our reputation and reduce customer demand for our services, especially our air services.

Strikes, work stoppages and slowdowns by our employees could adversely affect us.

Many of our U.S. employees are employed under a national master agreement and various supplemental agreements with local unions affiliated with the Teamsters. Our airline pilots, airline mechanics, ground mechanics and certain other employees are employed under other collective bargaining agreements. In addition, some of our international employees are employed under collective bargaining or similar agreements. Strikes, work stoppages or slowdowns by our employees could adversely affect our ability to meet our customers' needs. As a result, customers may reduce their business or stop doing business with us if they believe that such actions or threatened actions may adversely affect our ability to provide services. We may face a permanent loss of customers if we are unable to provide uninterrupted service, and this could materially adversely affect us. The terms of future collective bargaining agreements also may affect our competitive position and results of operations.

We are exposed to the effects of changing fuel and energy prices, including gasoline, diesel and jet fuel, and interruptions in supplies of these commodities.

Changing fuel and energy costs have a significant impact on our operations. We require significant quantities of fuel for our aircraft and delivery vehicles and are exposed to the risks associated with variations in the market price for petroleum products, including gasoline, diesel and jet fuel. We mitigate our exposure to changing fuel prices through our indexed fuel surcharges and through hedging transactions from time to time. If we are unable to maintain or increase our fuel surcharges, higher fuel costs could adversely impact our operating results. Even if we are able to offset changes in fuel costs with surcharges, high fuel surcharges may result in a mix shift from our higher-yielding air products to lower-yielding ground products or an overall reduction in volume. There can also be no assurance that hedging transactions will be effective to protect us from changes in fuel prices. Moreover, we could experience a disruption in energy supplies as a result of war, actions by producers or other factors beyond our control, which could have a material adverse effect on us.

Changes in exchange rates or interest rates may have a material adverse effect on us.

We conduct business across the globe with a significant portion of our revenue derived from operations outside the United States. Our operations in international markets are affected by changes in the exchange rates for local currencies, and in particular the Euro, British Pound Sterling, Canadian Dollar, Chinese Renminbi and Hong Kong Dollar.

We are exposed to changes in interest rates, primarily on our short-term debt and that portion of our long-term debt that carries floating interest rates. The impact of a 100-basis-point change in interest rates affecting our debt is discussed in the "Quantitative and Qualitative Disclosures about Market Risk" section of this report. Additionally, changes in interest rates impact the valuation of our pension and postretirement benefit obligations and the related benefit cost recognized in the income statement. The impact of changes in interest rates on our pension and postretirement benefit obligations and costs is discussed further in the "Critical Accounting Policies and Estimates" section of this report.

We monitor and manage our exposures to changes in currency exchange rates and interest rates, and use derivative instruments to mitigate the impact of changes in these rates on our financial position and results of operations; however, changes in exchange rates and interest rates cannot always be predicted or hedged and may have a material adverse effect on us.

The proposed phase out of the London Interbank Offer Rate ("LIBOR") could have an adverse effect on us.

Certain of our debt and other financial instruments have interest rates tied to LIBOR. The head of the United Kingdom Financial Conduct Authority has announced the desire to phase out the use of LIBOR by the end of 2021. There is currently no definitive information regarding the future utilization of LIBOR or any particular replacement rate. As such, the potential effect of any such event on our cost of capital cannot be determined. In addition, any further changes or reforms to the determination or supervision of LIBOR may result in a sudden or prolonged increase or decrease in reported LIBOR, which could have an adverse impact on extensions of credit held by us and could have a material adverse effect on us.

Failure to maintain our brand image and corporate reputation could adversely impact us.

Our success depends in part on our ability to maintain the image of the UPS brand and our reputation for providing excellent service to our customers. Service quality issues, actual or perceived, even when false or unfounded, could tarnish the image of our brand and may cause customers to use other companies. Also, adverse publicity surrounding labor relations, environmental concerns, security matters, political activities and similar matters, or attempts to connect our company to such issues, either in the United States or other countries in which we operate, could negatively affect our overall reputation and use of our services by customers. Social media accelerates and amplifies the scope of negative publicity, and makes responding to negative claims more difficult. Damage to our reputation and loss of brand equity could reduce demand for our services and thus have a material adverse effect on us, and could require additional resources to rebuild our reputation and restore the value of our brand.

A significant data breach or IT system disruption could materially adversely affect us, including requiring us to increase spending on data and system security.

We rely heavily on information technology networks and systems, including the Internet and a number of internally-developed systems and applications, to manage or support a wide variety of important business processes and activities throughout our operations. For example, we rely on information technology to receive package level information in advance of physical receipt of packages, to track items that move through our delivery systems, to efficiently plan deliveries, to execute billing processes, and to track and report financial and operational data. Our franchised center locations and businesses we have acquired also are reliant on the use of information technology systems to manage their business processes and activities.

In addition, the provision of service to our customers and the operation of our networks and systems involve the collection, storage and transmission of significant amounts of proprietary information and sensitive or confidential data, including personal information of customers, employees and others. To conduct our operations, we regularly move data across national borders, and consequently we are subject to a variety of continuously evolving and developing laws and regulations in the United States and abroad regarding privacy, data protection and data security. The scope of the laws that may be applicable to us is often uncertain and may be conflicting, particularly with respect to foreign laws. For example, the European Union's General Data Protection Regulation ("GDPR"), which greatly increases the jurisdictional reach of European Union law and adds a broad array of requirements for handling personal data, including the public disclosure of significant data breaches, became effective in May 2018. Other countries have enacted or are enacting data localization laws that require data to stay within their borders. All of these evolving compliance and operational requirements impose significant costs that are likely to increase over time.

Our information technology systems (as well as those of our franchisees and acquired businesses) are susceptible to damage, disruptions or shutdowns due to programming errors, defects or other vulnerabilities, power outages, hardware failures, computer viruses, cyber-attacks, ransomware attacks, malware attacks, theft, misconduct by employees or other insiders, telecommunications failures, misuse, human errors or other catastrophic events. Hackers, foreign governments, cyber-terrorists and cyber-criminals, acting individually or in coordinated groups, may launch distributed denial of service attacks or other coordinated attacks that may cause service outages, gain inappropriate or block legitimate access to systems or information, or result in other interruptions in our business. In addition, the foregoing breaches in security could expose us, our customers and franchisees, or the individuals affected, to a risk of loss, disclosure or misuse of proprietary information and sensitive or confidential data, including personal information of customers, employees and others. The techniques used to obtain unauthorized access, disable or degrade service or sabotage systems change frequently, may be difficult to detect and often are not recognized until launched against a target. As a result, we may be unable to anticipate these techniques or to implement adequate measures to prevent any of the events described above.

We also depend on and interact with the information technology networks and systems of third-parties for many aspects of our business operations, including our customers, and franchisees and service providers such as cloud service providers and third-party delivery services. These third parties may have access to information we maintain about our company, operations, customers, employees and vendors, or operating systems that are critical to or can significantly impact our business operations. Like us, these third parties are subject to risks imposed by data breaches and IT systems disruptions like those described above, and other events or actions that could damage, disrupt or close down their networks or systems. Security processes, protocols and standards that we have implemented and contractual provisions requiring security measures that we may have sought to impose on such third-parties may not be sufficient or effective at preventing such events. These events could result in unauthorized access to, or disruptions or denials of access to, misuse or disclosure of, information or systems that are important to our business, including proprietary information, sensitive or confidential data, and other information about our operations, customers, employees and suppliers, including personal information.

Any of these events that impact our information technology networks or systems, or those of acquired businesses, franchisees, customers, service providers or other third-parties, could result in disruptions in our operations, the loss of existing or potential customers, damage to our brand and reputation, regulatory scrutiny, and litigation and potential liability for us. Among other consequences, our customers' confidence in our ability to protect data and systems and to provide services consistent with their expectations could be impacted, further disrupting our operations. Similarly, an actual or alleged failure to comply with applicable U.S. or foreign data protection regulations or other data protection standards may expose us to litigation, fines, sanctions or other penalties.

We have invested and continue to invest in technology security initiatives, information technology risk management and disaster recovery plans. The cost and operational consequences of implementing, maintaining and enhancing further data or system protection measures could increase significantly to overcome increasingly intense, complex and sophisticated global cyber threats. Despite our best efforts, we are not fully insulated from data breaches and system disruptions. Although to date we are unaware of a data breach or system disruption, including a cyber-attack, that has been material to us, we cannot provide any assurances that such events and impacts will not be material in the future, and our efforts to deter, identify, mitigate and/or eliminate future breaches may require significant additional effort and expense and may not be successful.

Severe weather or other natural or manmade disasters could adversely affect us.

Severe weather conditions and other natural or manmade disasters, including storms, floods, fires, earthquakes, epidemics, pandemics, conflicts, unrest, or terrorist attacks, may disrupt our business and result in decreased revenues. Customers may reduce shipments, or our costs to operate our business may increase, either of which could have a material adverse effect on us. Any such event affecting one of our major facilities could result in a significant interruption in or disruption of our business.

We make significant capital investments in our business of which a significant portion is tied to projected volume levels.

We require significant capital investments in our business consisting of aircraft, vehicles, technology, facilities and sorting and other types of equipment. These investments support both our existing business and anticipated growth. Forecasting projected volume involves many factors which are subject to uncertainty, such as general economic trends, changes in governmental regulation and competition. If we do not accurately forecast our future capital investment needs, we could have excess capacity or insufficient capacity, either of which would negatively affect our revenues and profitability. In addition to forecasting our capital investment requirements, we adjust other elements of our operations and cost structure in response to adverse economic conditions; however, these adjustments may not be sufficient to allow us to maintain our operating margins.

Economic, political, social developments and other risks associated with international operations could adversely affect us.

We have significant international operations. As a result, we are continually exposed to changing economic, political and social developments that are beyond our control. Emerging markets are typically more volatile than those in the developed world, and any broad-based downturn in these markets could reduce our revenues and adversely affect our business, financial position and results of operations. We are subject to many laws governing our international operations, including those that prohibit improper payments to government officials and commercial customers, and restrict where we can do business, our shipments to certain countries and the information that we can provide to non-U.S. governments. Our failure to manage and anticipate these and other risks associated with our international operations could materially adversely affect us.

We are subject to changes in markets and our business plans that have resulted, and may in the future result, in substantial write-downs of the carrying value of our assets, thereby reducing our net income.

Our regular review of the carrying value of our assets has resulted, from time to time, in significant impairments, and we may in the future be required to recognize additional impairment charges. Changes in business strategy, government regulations, or economic or market conditions have resulted and may result in further substantial impairments of our intangible, fixed or other assets at any time in the future. In addition, we have been and may be required in the future to recognize increased depreciation and amortization charges if we determine that the useful lives of our fixed assets or intangible assets are shorter than we originally estimated. Such changes have in the past, and may in the future, reduce our net income.

Employee health and retiree health and pension benefit costs represent a significant expense to us; further cost increases could materially and adversely affect us.

Our expenses relating to employee health and retiree health and pension benefits are significant. In recent years, we have experienced significant increases in some of these costs, largely as a result of economic factors beyond our control, including, in particular, ongoing increases in healthcare costs well in excess of the rate of inflation and historically low discount rates that we use to value our benefit plan obligations. Continually increasing healthcare costs, volatility in investment returns and discount rates, as well as changes in laws, regulations and assumptions used to calculate retiree health and pension benefit expenses, may adversely affect our business, financial position, results of operations or require significant contributions to our benefit plans. Our national master agreement with the Teamsters includes provisions that are designed to mitigate certain of these healthcare expenses, but there can be no assurance that our efforts will be successful or that the failure or success of these efforts will not materially adversely affect us.

We participate in a number of trustee-managed multiemployer pension and health and welfare plans for employees covered under collective bargaining agreements. As part of the overall collective bargaining process for wage and benefit levels, we have agreed to contribute certain amounts to the multiemployer benefit plans during the contract period. The multiemployer benefit plans set benefit levels and are responsible for benefit delivery to participants. Future contribution amounts to multiemployer benefit plans will be determined only through collective bargaining, and we have no additional legal or constructive obligation to increase contributions beyond the agreed-upon amounts. However, in future collective bargaining negotiations, we could agree to make significantly higher future contributions to improve the funded status of one or more of these plans. The funded status of these multiemployer plans is impacted by various factors, including investment performance, healthcare inflation, changes in demographics and changes in participant benefit levels. At this time, we are unable to determine the amount of additional future contributions, if any, or whether any material adverse effect on us could result from our participation in these plans.

In addition to our on-going multiemployer pension plan obligations, we may have significant additional exposure with respect to benefits earned in the Central States Pension Fund (the "CSPF"). For additional information on our potential additional liabilities related to the CSPF, see note 5 to the audited, consolidated financial statements.

We may have additional tax liabilities.

We are subject to income taxes in the U.S. and many foreign jurisdictions. Significant judgment is required in determining our worldwide provision for income taxes. In the course of our business, there are many transactions and calculations where the ultimate tax determination is uncertain. For example, compliance with the 2017 United States Tax Cuts and Jobs Act (the "Tax Act") may require the collection of information not regularly produced within our company and the exercise of significant judgment in accounting for its provisions. Many aspects of the Tax Act remain unclear and may not be clarified for some time. In addition, many state jurisdictions continue to issue guidance on the state treatment of certain aspects of the Tax Act. As regulations and guidance evolve with respect to the Tax Act, our results may differ from previous estimates and may materially affect our tax rates and our financial position.

We are regularly under audit by tax authorities in different jurisdictions. Economic and political pressures to increase tax revenue in various jurisdictions may make resolving tax disputes more difficult. Although we believe our tax estimates are reasonable, the final determination of tax audits and any related litigation in the jurisdictions where we are subject to taxation could be materially different from our historical income tax provisions and accruals. In addition, changes in U.S. federal and state or international tax laws applicable to corporate multinationals, other fundamental law changes currently being considered by many countries, and changes in taxing jurisdictions' administrative interpretations, decisions, policies and positions may materially adversely impact our tax expense and cash flows.

We may be subject to various claims and lawsuits that could result in significant expenditures.

The nature of our business exposes us to the potential for various claims and litigation related to labor and employment, personal injury, property damage, business practices, environmental liability and other matters. Any material litigation or a catastrophic accident or series of accidents could result in significant expenditures and have a material adverse effect on us.

Our inability to effectively integrate acquired operations and realize the anticipated benefits of acquisitions, joint ventures or strategic alliances could adversely affect us.

As part of our business strategy, we may acquire businesses and form joint ventures or strategic alliances. Whether we realize the anticipated benefits from these transactions depends, in part, upon the successful integration between the businesses involved, the performance of the underlying operations, capabilities or technologies and the management of the acquired operations. Accordingly, our financial results could be materially adversely affected by our failure to effectively integrate the acquired operations, unanticipated performance issues or transaction-related charges.

Insurance and claims expenses could have a material adverse effect on us.

We have a combination of both self-insurance and high-deductible insurance programs for the risks arising out of the services we provide and the nature of our global operations, including claims exposure resulting from cargo loss, personal injury, property damage, aircraft and related liabilities, business interruption and workers' compensation. Workers' compensation, automobile and general liabilities are determined using actuarial estimates of the aggregate liability for claims incurred and an estimate of incurred but not reported claims, on an undiscounted basis. Our accruals for insurance reserves reflect certain actuarial assumptions and management judgments, which are subject to a high degree of variability. If the number or severity of claims for which we are retaining risk increases, our financial condition and results of operations could be adversely affected. If we lose our ability to self-insure these risks, our insurance costs could materially increase and we may find it difficult to obtain adequate levels of insurance coverage.

Item 1B. *Unresolved Staff Comments*

None.

Item 2. *Properties***Operating Facilities**

We own our headquarters, which is located in Atlanta, Georgia and consists of approximately 745,000 square feet of space in an office campus, and our UPS Supply Chain Solutions group's headquarters, which is located in Alpharetta, Georgia and consists of approximately 310,000 square feet of office space. Our information technology headquarters is located in Parsippany, New Jersey, consisting of about 200,000 square feet of owned office space.

Our primary information technology operations are consolidated in a 444,000 square foot owned facility in New Jersey. We also own a 175,000 square foot facility in Georgia, which serves as a backup to the main information technology operations facility in New Jersey.

We own or lease over 1,000 package operating facilities in the U.S., with approximately 80 million square feet of floor space. These facilities have vehicles and drivers stationed for the pick-up and delivery of packages, and capacity to sort and transfer packages. Our larger facilities also service our vehicles and equipment, and employ specialized mechanical installations for the sorting and handling of packages. We own or lease approximately 800 facilities that support our international package operations, with approximately 24 million square feet of space.

Our aircraft are operated in a hub and spoke pattern in the U.S., with our principal air hub, Worldport, located in Louisville, Kentucky. The Worldport facility consists of over 5 million square feet and includes high-speed conveyor and computer control systems. For additional information on our air hubs, see "Item 1 - Business - Products and Services; Reporting Segments - Global Small Package".

Our major air hub in Europe is located in Cologne, Germany, and we operate three air hubs in Asia in Shanghai, China; Shenzhen, China; and Hong Kong.

We own or lease more than 500 facilities, with approximately 38 million square feet of floor space that support our freight forwarding and logistics operations. We own and operate a logistics campus consisting of approximately 4 million square feet in Louisville, Kentucky.

We own or lease approximately 200 UPS Freight service centers with approximately 6 million square feet of floor space. The main offices of UPS Freight in Richmond, Virginia, consist of approximately 217,000 square feet of office space.

Fleet*Aircraft*

The following table shows information about our aircraft fleet as of December 31, 2019:

Description	Owned & Finance Leases	Operating Leases & Chartered From Others	On Order	Under Option
Boeing 757-200	75	—	—	—
Boeing 767-200	—	—	—	—
Boeing 767-300	64	2	8	—
Boeing 767-300BCF	3	—	1	—
Boeing 767-300BDSF	2	—	2	—
Airbus A300-600	52	—	—	—
Boeing MD-11	37	—	5	—
Boeing 747-400F	11	—	—	—
Boeing 747-400BCF	2	—	—	—
Boeing 747-8F	15	—	13	—
Other	—	309	—	—
Total	261	311	29	—

Vehicles

We operate a global ground fleet of approximately 125,000 package cars, vans, tractors and motorcycles. Our ground support fleet consists of 36,000 pieces of equipment designed specifically to support our aircraft fleet, ranging from non-powered container dollies and racks to powered aircraft main deck loaders and cargo tractors. We also have 52,000 containers used to transport cargo in our aircraft.

Item 3. Legal Proceedings

See note 5 to the audited, consolidated financial statements for a discussion of pension related matters and note 9 to the audited, consolidated financial statements for a discussion of judicial proceedings and other matters arising from the conduct of our business activities.

Item 4. Mine Safety Disclosures

Not applicable.

Information about our Executive Officers

The information under the heading "Information about our Executive Officers" in Item 10 hereof is incorporated by reference into this Part 1.

PART II**Item 5. Market for Registrant's Common Equity, Related Stockholder Matters and Issuer Purchases of Equity Securities**

Our class A common stock is not listed on a national securities exchange or traded in an organized over-the-counter market, but each share of our class A common stock is convertible into one share of our class B common stock. Our class B common stock is listed on the New York Stock Exchange under the symbol "UPS".

As of February 7, 2020, there were 155,914 and 19,196 shareowners of record of class A and class B common stock, respectively.

Our practice has been to pay dividends on a quarterly basis. The declaration of dividends is subject to the discretion of the Board of Directors and will depend on various factors, including our net income, financial condition, cash requirements, future prospects and other relevant factors.

On February 13, 2020, our Board declared a dividend of \$1.01 per share, which is payable on March 10, 2020 to shareowners of record on February 25, 2020. This represents a 5.2% increase from the previous \$0.96 per share quarterly dividend paid in December 2019.

A summary of repurchases of our class A and class B common stock during the fourth quarter of 2019 is as follows (in millions, except per share amounts):

	Total Number of Shares Purchased⁽¹⁾	Total Number of Shares Purchased as Part of Publicly Announced Program	Average Price Paid Per Share	Approximate Dollar Value of Shares that May Yet be Purchased Under the Program (as of month-end)
October 1—October 31	0.8	0.8	\$ 115.96	\$ 2,495
November 1—November 30	0.6	0.6	121.81	2,416
December 1—December 31	0.7	0.7	117.99	2,334
Total October 1—December 31	<u>2.1</u>	<u>2.1</u>	<u>\$ 118.59</u>	

⁽¹⁾ Includes shares repurchased through our publicly announced share repurchase program and shares tendered to pay the exercise price and tax withholding on employee stock awards.

In May 2016, the Board of Directors approved a share repurchase authorization of \$8.0 billion for shares of class A and class B common stock. We anticipate repurchasing approximately \$1.0 billion of shares in 2020. For additional information on our share repurchase activities, see note 11 to the audited, consolidated financial statements included in this report.

Shareowner Return Performance Graph

The following performance graph and related information shall not be deemed “soliciting material” or to be “filed” with the SEC, nor shall such information be incorporated by reference into any future filing under the Securities Act of 1933 or Securities Exchange Act of 1934, each as amended, except to the extent that the Company specifically incorporates such information by reference into such filing.

The following graph shows a five-year comparison of cumulative total shareowners’ returns for our class B common stock, the Standard & Poor’s 500 Index and the Dow Jones Transportation Average. The comparison of the total cumulative return on investment, which is the change in the stock price plus reinvested dividends for each of the quarterly periods, assumes that \$100 was invested on December 31, 2014 in the Standard & Poor’s 500 Index, the Dow Jones Transportation Average and our class B common stock.

Comparison of Five-Year Cumulative Total Return

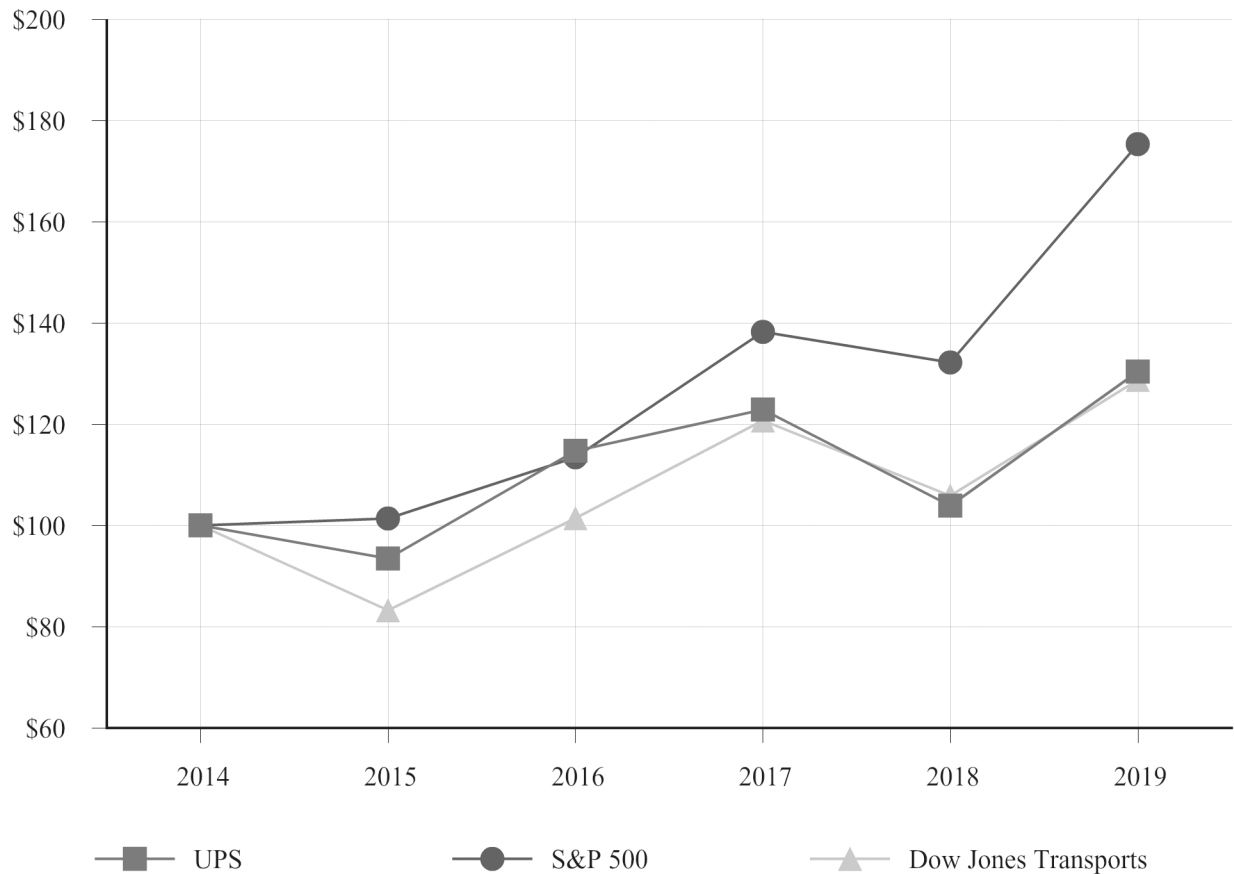

	12/31/2014	12/31/2015	12/31/2016	12/31/2017	12/31/2018	12/31/2019
United Parcel Service, Inc.	\$ 100.00	\$ 93.50	\$ 114.74	\$ 122.93	\$ 103.90	\$ 130.39
Standard & Poor’s 500 Index	\$ 100.00	\$ 101.37	\$ 113.49	\$ 138.26	\$ 132.19	\$ 175.30
Dow Jones Transportation Average	\$ 100.00	\$ 83.24	\$ 101.44	\$ 120.73	\$ 105.85	\$ 128.76

For information regarding our equity compensation plans, see Item 12 of this report.

Item 6. Selected Financial Data

The following table sets forth selected financial data for each of the five years in the period ended December 31, 2019 (in millions, except per share amounts). This financial data should be read together with our consolidated financial statements and related notes, Management's Discussion and Analysis of Financial Condition and Results of Operations, including the *Supplemental Information - Items Affecting Comparability* section, and other financial data appearing elsewhere in this report.

	Years Ended December 31,				
	2019	2018	2017	2016	2015
Selected Income Statement Data					
Revenue:					
U.S. Domestic Package	\$ 46,493	\$ 43,593	\$ 40,761	\$ 38,284	\$ 36,744
International Package	14,220	14,442	13,342	12,346	12,142
Supply Chain & Freight	13,381	13,826	12,482	10,980	10,300
Total Revenue	74,094	71,861	66,585	61,610	59,186
Operating Expenses:					
Compensation and benefits	38,908	37,235	34,577	32,534	31,448
Other	27,388	27,602	24,479	21,388	20,495
Total Operating Expenses	66,296	64,837	59,056	53,922	51,943
Operating Profit:					
U.S. Domestic Package	4,164	3,643	4,303	4,628	4,427
International Package	2,657	2,529	2,429	2,417	2,123
Supply Chain and Freight	977	852	797	643	693
Total Operating Profit	7,798	7,024	7,529	7,688	7,243
Other Income and (Expense):					
Investment income (expense) and other	(1,493)	(400)	61	(2,186)	435
Interest expense	(653)	(605)	(453)	(381)	(341)
Income Before Income Taxes	5,652	6,019	7,137	5,121	7,337
Income Tax Expense	1,212	1,228	2,232	1,699	2,497
Net Income	\$ 4,440	\$ 4,791	\$ 4,905	\$ 3,422	\$ 4,840
Per Share Amounts:					
Basic Earnings Per Share	\$ 5.14	\$ 5.53	\$ 5.63	\$ 3.88	\$ 5.37
Diluted Earnings Per Share	\$ 5.11	\$ 5.51	\$ 5.61	\$ 3.86	\$ 5.34
Dividends Declared Per Share	\$ 3.84	\$ 3.64	\$ 3.32	\$ 3.12	\$ 2.92
Weighted Average Shares Outstanding:					
Basic	864	866	871	883	901
Diluted	869	870	875	887	906

	As of December 31,				
	2019	2018	2017	2016	2015
Selected Balance Sheet Data:					
Cash and marketable securities	\$ 5,741	\$ 5,035	\$ 4,069	\$ 4,567	\$ 4,726
Total assets	57,857	50,016	45,574	40,545	38,497
Long-term debt	21,818	19,931	20,278	12,394	11,316
Shareowners' equity	3,283	3,037	1,024	430	2,501

This table reflects the impact of the adoption of new accounting standards in 2018 and 2019. Refer to note 1 to the audited, consolidated financial statements.

Item 7. Management's Discussion and Analysis of Financial Condition and Results of Operations**Overview**

Highlights of our annual results follow:

	Year Ended December 31,		\$ Change	% Change
	2019	2018	2019/2018	2019/2018
Revenue (in millions)	\$ 74,094	\$ 71,861	\$ 2,233	3.1 %
Operating Expenses (in millions)	66,296	64,837	1,459	2.3 %
Operating Profit (in millions)	\$ 7,798	\$ 7,024	\$ 774	11.0 %
Operating Margin	10.5%	9.8%		
Net Income (in millions)	\$ 4,440	\$ 4,791	\$ (351)	(7.3)%
Basic Earnings Per Share	\$ 5.14	\$ 5.53	\$ (0.39)	(7.1)%
Diluted Earnings Per Share	\$ 5.11	\$ 5.51	\$ (0.40)	(7.3)%
Average Daily Package Volume (in thousands)	21,880	20,677		5.8 %
Average Revenue Per Piece	\$ 10.87	\$ 10.98	\$ (0.11)	(1.0)%

- Consolidated revenue increased 3.1%.
- Average daily package volume increased 5.8% primarily driven by our U.S. Domestic Package segment, which experienced growth from SMBs as well as several large customers, led by our largest customer, Amazon.
- Average revenue per piece is dependent upon base rates, customer and product mix, average billable weight per piece, fuel surcharge rates and currency. Average revenue per piece decreased as a result of changes in customer and product mix, and lower average billable weight per piece in our U.S. Domestic Package segment. Currency movements negatively impacted revenue per piece in our International Package segment.
- Operating profit and operating margin increased with growth and margin expansion in all segments.
- We reported net income of \$4.440 billion and diluted earnings per share of \$5.11. Adjusted diluted earnings per share was \$7.53 after adjusting for the after-tax impacts of the following:
 - transformation strategy costs of \$196 million;
 - legal contingencies and expenses of \$91 million; and
 - pension mark-to-market losses recognized outside of a 10% corridor of \$1.816 billion.

2018 compared to 2017

See *Item 7. Management's Discussion and Analysis of Financial Condition and Results of Operations* of the Company's Annual Report on Form 10-K for the year ended December 31, 2018 filed with the Securities and Exchange Commission on February 21, 2019.

MANAGEMENT'S DISCUSSION AND ANALYSIS OF FINANCIAL CONDITION AND
RESULTS OF OPERATIONS**Supplemental Information - Items Affecting Comparability**

We supplement the reporting of our financial information determined under generally accepted accounting principles in the United States ("GAAP") with certain non-GAAP financial measures including, as applicable, "adjusted" compensation and benefits, operating expenses, operating profit, operating margin, other income and (expense), income before income taxes, income tax expense, effective tax rate, net income and earnings per share. Adjusted financial measures may exclude the impact of period over period exchange rate changes and hedging activities, amounts related to mark-to-market gains or losses, recognition of contingencies and transformation strategy costs, as described below. We believe that these adjusted financial measures provide meaningful information to assist investors and analysts in understanding our financial results and assessing our prospects for future performance. We believe these adjusted financial measures are important indicators of our recurring results of operations because they exclude items that may not be indicative of, or are unrelated to, our underlying operating results, and provide a useful baseline for analyzing trends in our underlying businesses. Additionally, these adjusted financial measures are used internally by management for the determination of incentive compensation awards, business unit operating performance analysis and business unit resource allocation.

Non-GAAP financial measures should be considered in addition to, and not as an alternative for, our reported results prepared in accordance with GAAP. Our non-GAAP financial information does not represent a comprehensive basis of accounting. Therefore, our non-GAAP financial information may not be comparable to similarly titled measures reported by other companies.

The year over year comparisons of our financial results are affected by the following items (in millions):

Non-GAAP Adjustments	Year Ended December 31,	
	2019	2018
Operating Expenses:		
Transformation Strategy Costs	\$ 255	\$ 360
Legal Contingencies and Expenses	97	—
Total Adjustments to Operating Expenses	\$ 352	\$ 360
Other Income and (Expense):		
Defined Benefit Plans Mark-to-Market Charges	\$ 2,387	\$ 1,627
Total Adjustments to Other Income and (Expense)	\$ 2,387	\$ 1,627
Total Adjustments to Income Before Income Taxes	\$ 2,739	\$ 1,987
Income Tax Benefit from the Mark-to-Market Charges	\$ (571)	\$ (390)
Income Tax Benefit from Transformation Strategy Costs	(59)	(87)
Income Tax Benefit from Legal Contingencies and Expenses	(6)	—
Total Adjustments to Income Tax Expense	\$ (636)	\$ (477)
Total Adjustments to Net Income	\$ 2,103	\$ 1,510

These items have been excluded from comparisons of "adjusted" Compensation and benefits, Operating Expenses, Operating Profit, Operating Margin, Other Income and (Expense), Income Tax Expense and effective tax rate in the discussion that follows. The income tax benefit from transformation strategy costs, legal contingencies and expenses and the mark-to-market charges are calculated by multiplying the statutory tax rates applicable in each tax jurisdiction, including the U.S. federal jurisdiction and various U.S. state and non-U.S. jurisdictions, by the tax deductible adjustments. The blended average of the effective tax rates in 2019 and 2018 were 23.2% and 24.0%, respectively.

**MANAGEMENT'S DISCUSSION AND ANALYSIS OF FINANCIAL CONDITION AND
RESULTS OF OPERATIONS***Impact of Changes in Foreign Currency Exchange Rates and Hedging Activities*

We supplement the reporting of our revenue, revenue per piece and operating profit with non-GAAP measures that exclude the period over period impact of foreign currency exchange rate changes and hedging activities.

Currency-neutral revenue, revenue per piece and operating profit are calculated by dividing current period reported U.S. dollar revenue, revenue per piece and operating profit by the current period average exchange rates to derive current period local currency revenue, revenue per piece and operating profit. The derived amounts are then multiplied by the average foreign exchange rates used to translate the comparable results for each month in the prior year period (including the period over period impact of foreign currency hedging activities). The difference between the current period reported U.S. dollar revenue, revenue per piece and operating profit and the derived current period U.S. dollar revenue, revenue per piece and operating profit is the period over period impact of currency fluctuations.

Transformation Strategy Costs

We supplement the presentation of our operating profit, operating margin, income before income taxes, net income and earnings per share with similar non-GAAP measures that exclude the impact of costs related to restructuring programs, including transformation strategy costs. For information regarding transformation strategy costs, see note 17 to the audited, consolidated financial statements.

Costs Related to Legal Contingencies and Expenses

We supplement the presentation of our operating profit, operating margin, income before income taxes, net income and earnings per share with similar non-GAAP measures that exclude the impact of costs related to certain of our legal contingencies and expenses. For information regarding legal contingencies and expenses, see note 9 to the audited, consolidated financial statements.

Defined Benefit Plans Mark-to-Market Charges

We recognize changes in the fair value of plan assets and net actuarial gains and losses in excess of a 10% corridor for our pension and postretirement defined benefit plans immediately as part of net periodic benefit cost other than service cost. We supplement the presentation of our income before income taxes, net income and earnings per share with "adjusted" measures that exclude the impact of the portion of net periodic benefit cost other than service cost represented by the gains and losses recognized in excess of the 10% corridor and the related income tax effects. We believe excluding these mark-to-market impacts from our adjusted results provides important supplemental information to remove the volatility caused by short-term changes in market interest rates, equity prices and similar factors.

This adjusted net periodic benefit cost (\$754 million in 2019 and \$615 million in 2018) utilizes the expected return on plan assets (7.68% in 2019 and 2018) and the discount rate used to determine net periodic benefit cost (4.45% in 2019 and 3.81% in 2018). The unadjusted net periodic benefit cost reflects the actual return on plan assets (17.57% in 2019 and -2.38% in 2018) and the discount rate used to measure the projected benefit obligation at the December 31 measurement date (3.55% in 2019 and 4.45% in 2018).

We recognized pre-tax mark-to-market losses outside of a 10% corridor related to the remeasurement of our pension and postretirement defined benefit plans' assets and liabilities in "Other Income and (Expense)" of \$2.387 and \$1.627 billion for 2019 and 2018, respectively. In October 2019, we refined the bond matching approach used to determine the discount rate for our U.S. pension and postretirement plans by implementing advances in technology and modeling techniques. This refinement decreased the projected benefit obligation on our consolidated balance sheet by approximately \$900 million as of December 31, 2019, decreased the pre-tax mark-to-market charge by approximately \$810 million and increased net income by \$616 million, or \$0.71 per share on a basic and diluted basis. This change did not have an impact on adjusted net income or adjusted earnings per share.

**MANAGEMENT'S DISCUSSION AND ANALYSIS OF FINANCIAL CONDITION AND
RESULTS OF OPERATIONS**

The table below indicates the amounts associated with each component of the pre-tax mark-to-market losses, as well as the weighted-average actuarial assumptions used to determine our net periodic benefit cost, for each year:

Components of mark-to-market gain (loss) (in millions):	Year Ended December 31,	
	2019	2018
Discount rates	\$ (5,670)	\$ 845
Return on assets	3,850	(1,057)
Demographic and other assumption changes	(24)	(22)
Coordinating benefits attributable to the Central States Pension Fund	(543)	(1,393)
Total mark-to-market gain (loss)	\$ (2,387)	\$ (1,627)

Weighted-average actuarial assumptions used to determine net periodic benefit cost:	Year Ended December 31,	
	2019	2018
Expected rate of return on plan assets	7.68%	7.68 %
Actual rate of return on plan assets	17.57%	(2.38)%
Discount rate used for net periodic benefit cost	4.45%	3.81 %
Discount rate at measurement date	3.55%	4.45 %

The pre-tax mark-to-market losses for the years ended December 31, 2019 and 2018, respectively, were comprised of the following components:

2019 - \$2.387 billion pre-tax mark-to-market loss:

- *Return on Assets* (\$3.850 billion pre-tax gain): In 2019, the actual rate of return on plan assets was higher than our expected rate of return, primarily due to strong global equity and U.S. bond markets.
- *Coordinating benefits attributable to the Central States Pension Fund* (\$543 million pre-tax loss): This represents our current best estimate of the additional potential coordinating benefits that may be required to be paid related to the Central States Pension Fund.
- *Discount Rates* (\$5.670 billion pre-tax loss): The weighted-average discount rate for our pension and postretirement medical plans decreased from 4.45% at December 31, 2018 to 3.55% at December 31, 2019, primarily due to both a decline in U.S. treasury yields and a decrease in credit spreads on AA-rated corporate bonds in 2019.
- *Demographic and Other Assumption Changes* (\$24 million pre-tax loss): This represents the difference between actual and estimated participant data and demographic factors, including items such as healthcare cost trends, compensation rate increases and rates of termination, retirement and mortality.

2018 - \$1.627 billion pre-tax mark-to-market loss:

- *Return on Assets* (\$1.057 billion pre-tax loss): In 2018, the actual rate of return on plan assets was lower than our expected rate of return, primarily due to weak global equity markets.
- *Coordinating benefits attributable to the Central States Pension Fund* (\$1.393 billion pre-tax loss): This represented our then-current best estimate of potential coordinating benefits that may be required to be paid related to the Central States Pension Fund.
- *Discount Rates* (\$845 million pre-tax gain): The weighted-average discount rate for our pension and postretirement medical plans increased from 3.81% at December 31, 2017 to 4.45% at December 31, 2018, primarily due to both an increase in U.S. treasury yields and an increase in credit spreads on AA-rated corporate bonds in 2018.
- *Demographic and Other Assumption Changes* (\$22 million pre-tax loss): This represents the difference between actual and estimated participant data and demographic factors, including items such as healthcare cost trends, compensation rate increases and rates of termination, retirement and mortality.

**MANAGEMENT'S DISCUSSION AND ANALYSIS OF FINANCIAL CONDITION AND
RESULTS OF OPERATIONS***Expense Allocations*

Certain operating expenses are allocated between our reporting segments using activity-based costing methods. These activity-based costing methods require us to make estimates that impact the amount of each expense category that is attributed to each segment. Changes in these estimates will directly impact the amount of expense allocated to each segment, and therefore the operating profit of each reporting segment. Our allocation methodologies are refined periodically, as necessary, to reflect changes in our businesses. There were no significant changes in our expense allocation methodologies during 2019, 2018 or 2017.

MANAGEMENT'S DISCUSSION AND ANALYSIS OF FINANCIAL CONDITION AND
RESULTS OF OPERATIONS

U.S. Domestic Package Operations

	Year Ended December 31,		\$ Change	% Change
	2019	2018	2019/2018	2019/2018
Average Daily Package Volume (in thousands):				
Next Day Air	1,889	1,542		22.5 %
Deferred	1,622	1,432		13.3 %
Ground	15,176	14,498		4.7 %
Total Average Daily Package Volume	18,687	17,472		7.0 %
Average Revenue Per Piece:				
Next Day Air	\$ 17.74	\$ 19.53	\$ (1.79)	(9.2)%
Deferred	12.62	13.12	(0.50)	(3.8)%
Ground	8.55	8.51	0.04	0.5 %
Total Average Revenue Per Piece	\$ 9.83	\$ 9.86	\$ (0.03)	(0.3)%
Operating Days in Period	253	253		
Revenue (in millions):				
Next Day Air	\$ 8,479	\$ 7,618	\$ 861	11.3 %
Deferred	5,180	4,752	428	9.0 %
Ground	32,834	31,223	1,611	5.2 %
Total Revenue	\$ 46,493	\$ 43,593	\$ 2,900	6.7 %
Operating Expenses (in millions):				
Operating Expenses	\$ 42,329	\$ 39,950	\$ 2,379	6.0 %
Transformation Strategy Costs	(108)	(235)	127	(54.0)%
Legal Contingencies and Expenses	(97)	—	(97)	N/M
Adjusted Operating Expenses	\$ 42,124	\$ 39,715	\$ 2,409	6.1 %
Operating Profit (in millions) and Operating Margin:				
Operating Profit	\$ 4,164	\$ 3,643	\$ 521	14.3 %
Adjusted Operating Profit	\$ 4,369	\$ 3,878	\$ 491	12.7 %
Operating Margin	9.0%	8.4%		
Adjusted Operating Margin	9.4%	8.9%		

Revenue

The change in overall revenue was due to the following factors for the year ended December 31, 2019 versus 2018:

	Volume	Rates / Product Mix	Fuel Surcharge	Total Revenue Change
Revenue Change Drivers:				
2019/2018	7.0%	(0.6)%	0.3%	6.7%

MANAGEMENT'S DISCUSSION AND ANALYSIS OF FINANCIAL CONDITION AND RESULTS OF OPERATIONS

Volume

2019 compared to 2018

Our overall volume increased across all products, led by strong growth in our Next Day Air and Deferred driven by the structural shift to faster delivery in retail and e-commerce, and from additional customer volume. We experienced growth from a number of large customers and SMBs, with volume growth led by our largest customer, Amazon. This growth was enabled by our on-going investment in automated facilities and other transformation initiatives.

Business-to-consumer shipments, which represented approximately 54% of the total U.S. Domestic Package average daily volume, grew 11.3% for the year driven by the growth in e-commerce and retail. Volume grew across all products, with particularly strong growth in our Air products. Business-to-business shipments increased 2.2% for the year with volume increases in both air and ground services.

Within our Air products, overall average daily volume increased in both Next Day Air and Deferred. Strong air volume growth continued primarily in residential Next Day Air and Second Day package products, as consumers and businesses continue to demand faster delivery options, which we expect will persist. This growth was slightly offset by declines in Next Day Air letter and Second Day letter volume due to shifts in customer preferences.

We experienced year over year growth in both residential and commercial ground products. Growth in residential ground volume was driven by changes in customer mix resulting from the continued growth in e-commerce, while growth in commercial ground products was primarily driven by an increase in retail return services.

Rates and Product Mix

2019 compared to 2018

Overall revenue per piece decreased due to customer and product mix and fuel surcharge rates, partially offset by changes in base rates.

Revenue per piece for ground and air products was positively impacted by a base rate increase on December 26, 2018. UPS Ground and UPS Air services rates increased an average net 4.9%.

Revenue per piece for our Next Day Air and Deferred products decreased primarily due to a shift in customer and product mix and a decrease in average billable weight per piece, which was partially offset by the increase in base rates.

Revenue per piece for our ground products increased primarily due to base rate increases and customer and product mix, partially offset by a decrease in average billable weight per piece.

Fuel Surcharges

We apply a fuel surcharge on our domestic air and ground services. The air fuel surcharge is based on the U.S. Department of Energy's ("DOE") Gulf Coast spot price for a gallon of kerosene-type jet fuel, while the ground fuel surcharge is based on the DOE's On-Highway Diesel Fuel Price. Based on published rates, the average fuel surcharge rates for domestic air and ground products were as follows:

	Year Ended December 31,		% Point Change
	2019	2018	2019/2018
Next Day Air / Deferred	7.3%	7.7%	(0.4)%
Ground	7.2%	7.0%	0.2 %

Effective April 2, 2018, we created separate fuel surcharges for Domestic Air shipments and International Air export shipments. These surcharges are based on the U.S. Gulf Coast Jet Fuel price and are adjusted weekly. In June and October 2018, ground fuel surcharge rates were raised for all thresholds, and in October and December 2018, Domestic Air fuel surcharge rates were increased for all thresholds. Ground surcharges continue to be based on the national U.S. Average On-Highway Diesel Fuel price and adjusted weekly.

While fluctuations in fuel surcharges can be significant from period to period, fuel surcharges represent one of the many individual components of our pricing structure that impact our overall revenue and yield. Additional components include the mix of products sold, the base price and any additional charges or discounts on these services.

**MANAGEMENT'S DISCUSSION AND ANALYSIS OF FINANCIAL CONDITION AND
RESULTS OF OPERATIONS**

Revenue per piece for ground products was positively impacted by fuel surcharge rate increases during 2018, while fuel surcharge rates for air products decreased slightly for the year.

Total domestic fuel surcharge revenue increased by \$140 million for the year as a result of increases in package volume and shifts in product mix, partially offset by lower fuel surcharge rates on our Air products.

Operating Expenses

2019 compared to 2018

Operating expenses, and operating expenses excluding the impact of transformation strategy costs and legal contingencies and expenses, increased largely due to pickup and delivery costs (up \$1.385 billion), costs of operating our domestic integrated air and ground network (up \$631 million), costs of package sorting (up \$301 million) and other indirect operating costs (up \$92 million).

In order to manage costs, we continually adjust our air and ground network to better match higher volume levels. In addition, we continue to deploy and utilize technology to increase package sorting and delivery productivity by reducing manual touchpoints. The growth in pickup and delivery and network operational costs was impacted by several factors:

- Higher employee compensation and benefit costs largely resulting from:
 - volume growth, which resulted in an increase in average daily union labor hours of 4.7%;
 - union pay rate and benefit increases; and
 - growth in the overall size of the workforce due to facility expansions.

We incurred higher employee benefit expenses due to additional headcount, contractual contribution rate increases to union multiemployer plans and changes in benefit eligibility for certain union employees. These increases were slightly offset by lower pension expense for our company-sponsored plans due to higher discount rates used to measure the projected benefit obligations which reduced service costs, and lower premiums due to improved funded status.

- We incurred slightly lower fuel expense for the year, driven by declines in fuel prices and higher alternative fuel tax credits in 2019 due to the passage of additional legislation. These reductions were partially offset by increased network volume, which resulted in higher fuel usage. Aircraft block hours increased 10.3%, daily package delivery stops increased 10.9% and daily delivery miles increased 7.9%.
- Lower costs for outside contract carriers were the result of retaining additional volume within our network.

Total cost per piece, which includes transformation strategy costs and legal contingencies and expenses, decreased 0.9% for the year. Excluding the year over year impact of transformation strategy costs and legal contingencies and expenses, adjusted cost per piece decreased 0.8% for the year. Year over year cost per piece decreased due to the incremental impact of our new automated facilities and other transformation initiatives.

Operating Profit and Margin

2019 compared to 2018

Operating profit increased \$521 million with operating margins increasing 60 basis points to 9.0%. Excluding the year over year impact of transformation strategy costs and legal contingencies and expenses, adjusted operating profit increased \$491 million with operating margins increasing 50 basis points to 9.4%. Operating profit increased as a result of the items described above.

MANAGEMENT'S DISCUSSION AND ANALYSIS OF FINANCIAL CONDITION AND
RESULTS OF OPERATIONS

International Package Operations

	Year Ended December 31,		\$ Change	% Change
	2019	2018	2019/2018	2019/2018
Average Daily Package Volume (in thousands):				
Domestic	1,721	1,723		(0.1)%
Export	1,472	1,482		(0.7)%
Total Average Daily Package Volume	3,193	3,205		(0.4)%
Average Revenue Per Piece:				
Domestic	\$ 6.51	\$ 6.59	\$ (0.08)	(1.2)%
Export	29.10	29.27	(0.17)	(0.6)%
Total Average Revenue Per Piece	\$ 16.93	\$ 17.08	\$ (0.15)	(0.9)%
Operating Days in Period	253	253		
Revenue (in millions):				
Domestic	\$ 2,836	\$ 2,874	\$ (38)	(1.3)%
Export	10,837	10,973	(136)	(1.2)%
Cargo & Other	547	595	(48)	(8.1)%
Total Revenue	\$ 14,220	\$ 14,442	\$ (222)	(1.5)%
Operating Expenses (in millions):				
Operating Expenses	\$ 11,563	\$ 11,913	\$ (350)	(2.9)%
Transformation Strategy Costs	(122)	(76)	(46)	60.5 %
Adjusted Operating Expenses	\$ 11,441	\$ 11,837	\$ (396)	(3.3)%
Operating Profit (in millions) and Operating Margin:				
Operating Profit	\$ 2,657	\$ 2,529	\$ 128	5.1 %
Adjusted Operating Profit	\$ 2,779	\$ 2,605	\$ 174	6.7 %
Operating Margin	18.7%	17.5%		
Adjusted Operating Margin	19.5%	18.0%		
Currency Translation Benefit / (Cost)—(in millions)*:				
Revenue			\$ (232)	
Operating Expenses			302	
Operating Profit			\$ 70	

* Net of currency hedging; amount represents the change compared to the prior year.

Revenue

The change in overall revenue was due to the following factors for the year ended December 31, 2019 versus 2018:

	Volume	Rates / Product Mix	Fuel Surcharge	Currency	Total Revenue Change
Revenue Change Drivers:					
2019/2018	(0.4)%	0.4%	0.1%	(1.6)%	(1.5)%

**MANAGEMENT'S DISCUSSION AND ANALYSIS OF FINANCIAL CONDITION AND
RESULTS OF OPERATIONS*****Volume****2019 compared to 2018*

Our overall average daily volume decreased slightly due to weak demand from several sectors including high tech, manufacturing, professional services, automotive and government, partially offset by higher demand in healthcare, retail and other sectors.

Export volume decreased slightly in 2019. European export volume declined across all trade lanes, while Intra-European volume grew slightly. Total U.S. export volume decreased, with declines in the Europe and Asia trade lanes partially offset by growth in the U.S. to Americas and U.S. to ISMEA trade lanes. Asia exports grew in all major trade lanes, with the exception of the United States. Export volume for the year was strongest in our non-premium Transborder Standard product, offset by declines in our premium Worldwide and Transborder Express services.

Domestic volume also decreased slightly for the year as growth in several domestic markets was more than offset by challenging economic conditions, particularly in the United Kingdom and other European countries. Additionally, a postal strike in Canada in 2018 drove additional domestic volume which did not repeat in 2019.

Rates and Product Mix*2019 compared to 2018*

On December 26, 2018, we implemented an average 4.9% net increase in base and accessorial rates for international shipments originating in the United States. Rate changes for shipments originating outside the U.S. are made throughout the year and vary by geographic market. On August 26, 2019, we implemented a 1.0% increase in International Air-Import fuel surcharge.

Total average revenue per piece decreased in 2019 due entirely to a 170 basis point decrease from currency. Excluding the impact of currency, revenue per piece increased 0.8% due to increases in base rates, partially offset by declines in fuel surcharge indices.

Domestic revenue per piece decreased 120 basis points, driven entirely by a 390 basis point decrease from currency. Excluding the impact of currency, revenue per piece increased 2.7% due to base rate increases.

Export revenue per piece decreased 60 basis points, also driven entirely by a 110 basis point decrease from currency. Excluding the impact of currency, revenue per piece increased 0.5% as the trend toward our lower priced non-premium services was more than offset by base rate increases.

Fuel Surcharges

We apply fuel surcharges on our international air and ground services. The fuel surcharge for international air products originating inside or outside the United States is largely indexed to the DOE's Gulf Coast spot price for a gallon of kerosene-type jet fuel. Fuel surcharges for ground products originating outside the United States are indexed to fuel prices in the region or country where the shipments originate.

While fluctuations in fuel surcharges can be significant from period to period, fuel surcharges represent one of the many individual components of our pricing structure that impact our overall revenue and yield. Additional components include the mix of products sold, the base price and any additional charges or discounts on these services.

Total international fuel surcharge revenue decreased by \$33 million in 2019, primarily due to decreases in fuel surcharge indices and decreases in volume.

Operating Expenses*2019 compared to 2018*

Operating expenses, and operating expenses excluding the year over year impact of transformation strategy costs, decreased for 2019. These decreases are the results of effective management of network capacity and cost in response to lower volumes within our air, ground and local pickup and delivery networks, combined with lower fuel prices and currency exchange rate movements.

**MANAGEMENT'S DISCUSSION AND ANALYSIS OF FINANCIAL CONDITION AND
RESULTS OF OPERATIONS**

In addition to variability in usage and market prices, the manner in which we purchase fuel also influences the net impact of fuel on our results. The majority of our contracts for fuel purchases utilize index-based pricing formulas plus or minus a fixed locational/supplier differential. While many of the indices are aligned, each index may fluctuate at a different pace, driving variability in the prices paid for fuel. Because of this, our operating results may be affected should the market price of fuel suddenly change by a significant amount or change by amounts that do not result in an adjustment in our fuel surcharges, which can affect our earnings either positively or negatively in the short-term.

The cost of operating our integrated international air and ground network decreased \$130 million for 2019. The decrease in network costs was primarily driven by a 2.1% decrease in aircraft block hours, due in large part to our ability to adjust our global air network to match capacity with demand, and lower package volume for the year, together with lower fuel prices. Pickup and delivery costs decreased \$105 million in 2019. The remaining decrease in operating expenses was driven by a \$40 million gain from the sale of surplus property in Canada, as well as decreases in the costs of package sorting and other indirect operating costs.

Operating Profit and Margin

2019 compared to 2018

Operating profit increased \$128 million for the year, with operating margin increasing 120 basis points to 18.7%. Excluding the year over year impact of transformation strategy costs, adjusted operating profit increased, with adjusted operating margin up 150 basis points to 19.5%. Operating profit increased as a result of the items described above.

MANAGEMENT'S DISCUSSION AND ANALYSIS OF FINANCIAL CONDITION AND
RESULTS OF OPERATIONS

Supply Chain & Freight Operations

	Year Ended December 31,		\$ Change	% Change
	2019	2018	2019/2018	2019/2018
Freight LTL Statistics:				
Revenue (in millions)	\$ 2,679	\$ 2,706	\$ (27)	(1.0)%
Revenue Per Hundredweight	\$ 26.54	\$ 25.52	\$ 1.02	4.0 %
Shipments (in thousands)	9,281	9,720		(4.5)%
Shipments Per Day (in thousands)	36.7	38.4		(4.5)%
Gross Weight Hauled (in millions of lbs)	10,096	10,605		(4.8)%
Weight Per Shipment (in lbs)	1,088	1,091		(0.3)%
Operating Days in Period	253	253		
Revenue (in millions):				
Forwarding	\$ 5,867	\$ 6,580	\$ (713)	(10.8)%
Logistics	3,435	3,234	201	6.2 %
Freight	3,265	3,218	47	1.5 %
Other	814	794	20	2.5 %
Total Revenue	\$ 13,381	\$ 13,826	\$ (445)	(3.2)%
Operating Expenses (in millions):				
Operating Expenses	\$ 12,404	\$ 12,974	\$ (570)	(4.4)%
Transformation Strategy Costs	(25)	(49)	24	(49.0)%
Adjusted Operating Expenses	\$ 12,379	\$ 12,925	\$ (546)	(4.2)%
Operating Profit (in millions) and Operating Margins:				
Operating Profit	\$ 977	\$ 852	\$ 125	14.7 %
Adjusted Operating Profit	\$ 1,002	\$ 901	\$ 101	11.2 %
Operating Margin	7.3%	6.2%		
Adjusted Operating Margin	7.5%	6.5%		
Currency Translation Benefit / (Cost)—(in millions)*:				
Revenue			\$ (75)	
Operating Expenses			67	
Operating Profit			\$ (8)	

* Amount represents the change compared to the prior year.

	Year Ended December 31,		\$ Change	% Change
	2019	2018	2019/2018	2019/2018
Transformation Strategy Costs (in millions):				
Forwarding	\$ 12	\$ 16	\$ (4)	(25.0)%
Logistics	13	22	(9)	(40.9)%
Freight	—	6	(6)	(100.0)%
Other	—	5	(5)	(100.0)%
Total Transformation Strategy Costs	\$ 25	\$ 49	\$ (24)	(49.0)%

**MANAGEMENT'S DISCUSSION AND ANALYSIS OF FINANCIAL CONDITION AND
RESULTS OF OPERATIONS*****Revenue****2019 compared to 2018*

Total revenue for the Supply Chain & Freight segment decreased \$445 million in 2019 compared with 2018.

Forwarding revenue decreased primarily due to an overall decline in market demand that was impacted by global trade uncertainties. This led to lower volume and declines in market rates in our international air and ocean freight forwarding businesses. In addition, excess capacity in the truckload brokerage market depressed rates, contributing to the year over year decrease in revenue. These decreases were partially offset by yield management initiatives in our air and ocean freight businesses.

Logistics revenue increased as we experienced growth in the healthcare, mail services, retail and manufacturing sectors.

Overall UPS Freight revenue increased, as declines in LTL tonnage and shipment volume which were largely attributable to market demand and the residual impacts of the fourth quarter 2018 network disruption were more than offset by yield management initiatives and volume growth in our Ground Freight Pricing product.

Operating Expenses*2019 compared to 2018*

Total operating expenses for the Supply Chain & Freight segment, and operating expenses excluding the year over year impact of transformation strategy costs, decreased in 2019 compared with 2018.

Forwarding operating expenses decreased \$685 million largely due to reductions in purchased transportation. Purchased transportation expense decreased \$655 million primarily due to lower tonnage and declines in market rates in our international air and ocean freight forwarding businesses as well as a decrease in volume and market rates in truckload brokerage. Cost management initiatives in our freight forwarding businesses also contributed to the reduction in operating expenses.

Logistics operating expenses increased \$172 million, primarily due to increases in purchased transportation driven by increased volume and rates, particularly in our mail services business. Additionally, business investments in healthcare quality assurance and technology increased costs.

UPS Freight operating expenses decreased \$54 million. Decreases in costs associated with operating our linehaul network (\$49 million) and decreases in pickup and delivery costs (\$40 million) were driven by lower expenses from outside transportation carriers as a result of a decline in tonnage, lower fuel surcharges and the residual impacts of the fourth quarter 2018 network disruption. These decreases were offset by increases in transportation expense for our Ground Freight Pricing product due to higher volume. Cost management initiatives and production improvements largely contributed to the overall reduction in operating expenses.

Operating Profit and Margin*2019 compared to 2018*

Total operating profit for the Supply Chain & Freight segment increased \$125 million in 2019 compared with 2018. Excluding the year over year impact of transformation strategy costs, adjusted operating profit increased \$101 million. Operating margin increased 110 basis points to 7.3%, while the adjusted operating margin increased 100 basis points to 7.5%. Operating profit and margin were impacted by the items described above.

MANAGEMENT'S DISCUSSION AND ANALYSIS OF FINANCIAL CONDITION AND
RESULTS OF OPERATIONS

Consolidated Operating Expenses

	Year Ended December 31,		\$ Change	% Change
	2019	2018	2019/2018	2019/2018
Operating Expenses (in millions):				
Compensation and Benefits:	\$ 38,908	\$ 37,235	\$ 1,673	4.5 %
Transformation Strategy Costs	(166)	(262)	96	(36.6)%
Adjusted Compensation and Benefits	38,742	36,973	1,769	4.8 %
Repairs and Maintenance	1,838	1,732	106	6.1 %
Depreciation and Amortization	2,360	2,207	153	6.9 %
Purchased Transportation	12,590	13,409	(819)	(6.1)%
Fuel	3,289	3,427	(138)	(4.0)%
Other Occupancy	1,392	1,362	30	2.2 %
Other Expenses	5,919	5,465	454	8.3 %
Total Other Expenses	27,388	27,602	(214)	(0.8)%
Other Transformation Strategy Costs	(89)	(98)	9	(9.2)%
Legal Contingencies and Expenses	(97)	—	(97)	N/M
Adjusted Total Other Expenses	\$ 27,202	\$ 27,504	\$ (302)	(1.1)%
Total Operating Expenses	\$ 66,296	\$ 64,837	\$ 1,459	2.3 %
Adjusted Total Operating Expenses	\$ 65,944	\$ 64,477	\$ 1,467	2.3 %
Currency Translation Cost / (Benefit)*			\$ (369)	

	Year Ended December 31,		\$ Change	% Change
	2019	2018	2019/2018	2019/2018
Adjustments to Operating Expenses (in millions):				
Transformation Strategy Costs:				
Compensation	\$ 21	\$ —	\$ 21	N/M
Benefits	145	262	(117)	(44.7)%
Depreciation and Amortization	3	12	(9)	(75.0)%
Other Occupancy	8	—	8	N/M
Other Expenses	78	86	(8)	(9.3)%
Total Transformation Strategy Costs	\$ 255	\$ 360	\$ (105)	(29.2)%
Legal Contingencies and Expenses:				
Other Expenses	\$ 97	\$ —	\$ 97	N/M
Total Adjustments to Operating Expenses	\$ 352	\$ 360	\$ (8)	(2.2)%

Compensation and Benefits*2019 compared to 2018*

Total compensation and benefits, and total compensation and benefits excluding the year over year impact of transformation strategy costs, increased for 2019.

Total compensation costs increased \$1.028 billion or 4.6%. Excluding the year over year impact of transformation strategy costs, adjusted compensation increased \$1.007 billion largely due to higher U.S. Domestic direct labor costs. These costs increased as a result of additional headcount, driven by U.S. Domestic average daily volume growth that resulted in an increase in average daily union hours of 4.7%. Contractual union wage increases also contributed to the increase in compensation for hourly employees.

**MANAGEMENT'S DISCUSSION AND ANALYSIS OF FINANCIAL CONDITION AND
RESULTS OF OPERATIONS**

Benefits costs increased \$645 million. Excluding the year over year impact of transformation strategy costs, adjusted benefits costs increased \$762 million due to the following:

- Health and welfare costs increased \$570 million, driven by higher contributions to multiemployer plans due to contractual rate increases, an overall increase in the size of the workforce and changes in eligibility for certain union employees.
- Pension and retirement benefits increased \$18 million. The impacts of contractually-mandated contribution increases to multiemployer plans, as well as an increase in the size of the overall workforce, were substantially offset by lower service cost for company-sponsored plans as a result of higher discount rates.
- Vacation, excused absence, payroll taxes and other expenses increased \$211 million, primarily driven by salary increases and growth in the overall size of the workforce.
- Workers' compensation expense decreased \$37 million as we experienced more favorable actuarial adjustments. We evaluate the total range of actuarial outcomes when estimating losses that will ultimately occur. See note 1 to the audited, consolidated financial statements for a further description of this policy.

Repairs and Maintenance

2019 compared to 2018

The increase in repairs and maintenance expense was driven by maintenance of our aircraft, routine repairs to buildings and facilities and maintenance of our other transportation equipment, due to additional investments we have made in recent periods.

Depreciation and Amortization

2019 compared to 2018

We evaluate the useful lives of all our property, plant and equipment based on our usage, maintenance and replacement policies, and taking into account physical and economic factors that may affect the useful lives of the assets. See note 1 to the audited, consolidated financial statements for a further description of the policy.

For 2019, depreciation expense increased \$365 million, and net income decreased by \$287 million, or \$0.33 per share on a basic and diluted basis, as a result of investments in property, plant and equipment, net of disposals and assets becoming fully depreciated. Depreciation expense decreased \$212 million, and net income increased \$167 million, or \$0.19 per share on a basic and diluted basis, as a result of lengthening our estimated useful lives for various asset categories in the latter half of 2018. The combined effect of the foregoing was a net increase in depreciation expense of \$153 million and a decrease in net income of \$120 million, or \$0.14 per share on a basic and diluted basis, for the year.

Purchased Transportation

2019 compared to 2018

The decrease in purchased transportation expense charged to us by third-party air, rail, ocean and truck carriers was primarily driven by the following factors:

- Expense in our Freight Forwarding and Logistics business decreased \$530 million due to decreases in both market rates and volume in our air and ocean freight forwarding businesses. Our truckload brokerage business also experienced declines in rates, primarily driven by market overcapacity. These decreases were partially offset by increases due to volume growth and rate increases in our mail services business.
- U.S. Domestic Package expense decreased \$186 million primarily due to lower overall usage of third-party transportation carriers.
- International Package expense decreased \$100 million primarily due to favorable currency exchange rate movements.
- Other purchased transportation expense decreased \$3 million due to changes in the number of leased and chartered aircraft and lower fuel surcharges passed on to us by outside carriers.

**MANAGEMENT'S DISCUSSION AND ANALYSIS OF FINANCIAL CONDITION AND
RESULTS OF OPERATIONS**

Fuel

2019 compared to 2018

The decrease in fuel expense was driven by lower jet fuel, diesel and gasoline prices as well as higher alternative fuel tax credits as a result of legislation passed in 2019. These decreases were partially offset by higher consumption due to additional aircraft block hours and vehicle miles driven by higher U.S. Domestic package volume.

Other Occupancy

2019 compared to 2018

The increase in other occupancy expense and other occupancy expense excluding the year over year impact of transformation strategy costs was primarily driven by additional operating facilities coming into service.

Other Expenses

2019 compared to 2018

Other expenses, and other expenses excluding the year over year impact of transformation strategy costs and legal contingencies and expenses, increased for 2019. The increase was attributable to various items, including adjustments to reserves for self-insured automobile liability claims, bad debt expense, technology equipment and software licenses, professional service fees and advertising. These increases were partially offset by a \$40 million gain on the sale of surplus property in Canada and lower travel and entertainment expenses.

Other Income and (Expense)

The following table sets forth investment income (expense) and other and interest expense for the years ended December 31, 2019 and 2018 (in millions):

	Year Ended December 31,		\$ Change	% Change
	2019	2018	2019/2018	2019/2018
Investment Income (Expense) and Other	\$ (1,493)	\$ (400)	\$ (1,093)	273.3 %
Defined Benefit Plans Mark-to-Market Charges	2,387	1,627	760	46.7 %
Adjusted Investment Income (Expense) and Other	\$ 894	\$ 1,227	\$ (333)	(27.1)%
Interest Expense	(653)	(605)	(48)	7.9 %
Total Other Income and (Expense)	\$ (2,146)	\$ (1,005)	\$ (1,141)	113.5 %
Adjusted Other Income and (Expense)	\$ 241	\$ 622	\$ (381)	(61.3)%

Investment Income (Expense) and Other

2019 compared to 2018

Investment income (expense) and other for the period increased \$1.093 billion, which included a \$760 million increase in mark-to-market pension charges. Excluding the impact of the defined benefit plan mark-to-market charges, adjusted investment income (expense) and other for the period, which includes expected investment returns on pension assets, net of interest cost on projected benefit obligations, prior service cost and investment income, decreased \$333 million. Expected returns on plan assets decreased as a result of the lower asset base driven by negative asset returns in 2018, partially offset by the effects of higher discretionary contributions in 2019. Pension interest cost increased with higher year-end discount rates, ongoing plan growth and an increase in the projected benefit obligation as a result of the 2018 year-end measurement of our plans. Investment income increased as a result of higher yields on invested assets, higher overall investment balances and foreign currency exchange rate movements.

MANAGEMENT'S DISCUSSION AND ANALYSIS OF FINANCIAL CONDITION AND
RESULTS OF OPERATIONS*Interest Expense*

2019 compared to 2018

Interest expense increased primarily due to higher average outstanding debt balances and higher effective interest rates, combined with lower capitalized interest for 2019.

Income Tax Expense

The following table sets forth income tax expense and our effective tax rate for the years ended December 31, 2019 and 2018 (in millions):

	Year Ended December 31,		\$ Change 2019/2018	% Change 2019/2018
	2019	2018		
Income Tax Expense:	\$ 1,212	\$ 1,228	\$ (16)	(1.3)%
Income Tax Impact of:				
Defined Benefit Plans Mark-to-Market Charges	571	390	181	46.4 %
Transformation Strategy Costs	59	87	(28)	(32.2)%
Legal Contingencies and Expenses	6	—	6	N/M
Adjusted Income Tax Expense	\$ 1,848	\$ 1,705	\$ 143	8.4 %
Effective Tax Rate	21.4%	20.4%		
Adjusted Effective Tax Rate	22.0%	21.3%		

For additional information on income tax expense and our effective tax rate, see note 14 to the audited, consolidated financial statements.

**MANAGEMENT'S DISCUSSION AND ANALYSIS OF FINANCIAL CONDITION AND
RESULTS OF OPERATIONS**

Liquidity and Capital Resources

As of December 31, 2019, we had \$5.741 billion in cash, cash equivalents and marketable securities. We believe that our current cash position, access to commercial paper programs and debt capital markets and cash flow generated from operations should be adequate not only for operating requirements, but also to enable us to complete our capital expenditure programs, transformation strategy and to fund dividend payments, share repurchases, pension contributions and long-term debt payments through the next several years. We regularly evaluate opportunities to optimize our capital structure, including through issuances of debt or equity to refinance existing debt and to fund ongoing cash needs.

Cash Flows From Operating Activities

The following is a summary of the significant sources (uses) of cash from operating activities (in millions):

	2019	2018
Net Income	\$ 4,440	\$ 4,791
Non-cash operating activities ⁽¹⁾	6,405	6,048
Pension and postretirement benefit plan contributions (company-sponsored plans)	(2,362)	(186)
Hedge margin receivables and payables	171	482
Income tax receivables and payables	599	469
Changes in working capital and other non-current assets and liabilities	(634)	1,091
Other operating activities	20	16
Net cash from operating activities	<u>\$ 8,639</u>	<u>\$ 12,711</u>

⁽¹⁾ Represents depreciation and amortization, gains and losses on derivative transactions and foreign exchange, deferred income taxes, provisions for uncollectible accounts receivable, amortization on operating lease assets, pension and postretirement benefit expense, stock compensation expense and other non-cash items.

Cash from operating activities remained strong throughout 2018 and 2019. Most of the variability in operating cash flows during this period related to funding company-sponsored pension and postretirement benefit plans (and related cash tax deductions). Except for discretionary or accelerated fundings of our plans, contributions to our company-sponsored pension plans have largely varied in accordance with minimum funding requirements. We made discretionary contributions to our three primary, company-sponsored U.S. pension plans totaling \$2.0 billion in 2019. No discretionary contributions were made in 2018. The remaining contributions in 2018 and 2019 were to our international pension plans and U.S. postretirement medical benefit plans.

Operating cash flows were impacted by changes in our working capital management whereby certain payments from the fourth quarter of 2018 shifted into the first quarter of 2019. In addition, accelerated growth in the business lifted overall working capital demand. The net hedge margin collateral received from our derivative counterparties was \$171 and \$482 million during 2019 and 2018, respectively, due to the change in net fair value of the derivative contracts used in our currency and interest rate hedging programs. Cash payments for income taxes were \$514 million and \$2 million for 2019 and 2018, respectively, primarily due to timing of deductions related to pension contributions.

As of December 31, 2019, our total worldwide holdings of cash, cash equivalents and marketable securities were \$5.741 billion, of which approximately \$2.564 billion was held by foreign subsidiaries. The amount of cash, cash equivalents and marketable securities held by our U.S. and foreign subsidiaries fluctuates throughout the year due to a variety of factors, including the timing of cash receipts and disbursements in the normal course of business. Cash provided by operating activities in the U.S. continues to be our primary source of funds to finance domestic operating needs, capital expenditures, share repurchases, pension contributions and dividend payments to shareowners. All cash, cash equivalents and marketable securities held by foreign subsidiaries are generally available for distribution to the U.S. without any U.S. federal income taxes. Any such distributions may be subject to foreign withholding and U.S. state taxes. When amounts earned by foreign subsidiaries are expected to be indefinitely reinvested, no accrual for taxes is provided.

**MANAGEMENT'S DISCUSSION AND ANALYSIS OF FINANCIAL CONDITION AND
RESULTS OF OPERATIONS**

Cash Flows From Investing Activities

Our primary sources (uses) of cash for investing activities were as follows (amounts in millions):

	2019	2018
Net cash used in investing activities	\$ (6,061)	\$ (6,330)
Capital Expenditures:		
Buildings, facilities and plant equipment	\$ (2,729)	\$ (3,147)
Aircraft and parts	(1,890)	(1,496)
Vehicles	(987)	(931)
Information technology	(774)	(709)
Total Capital Expenditures ⁽¹⁾ :	\$ (6,380)	\$ (6,283)
Capital Expenditures as a % of revenue	8.6%	8.7%
Other Investing Activities:		
Proceeds from disposals of property, plant and equipment	\$ 65	\$ 37
Net change in finance receivables	\$ 13	\$ 4
Net (purchases), sales and maturities of marketable securities	\$ 322	\$ (87)
Cash paid for business acquisitions, net of cash and cash equivalents acquired	\$ (6)	\$ (2)
Other investing activities	\$ (75)	\$ 1

⁽¹⁾In addition to capital expenditures of \$6.380 and \$6.283 billion in 2019 and 2018, respectively, there were capital expenditures relating to the principal repayments of finance lease obligations of \$140 and \$340 million. These are included in cash flows from financing activities.

We have commitments for the purchase of aircraft, vehicles, equipment and real estate to provide for the replacement of existing capacity and anticipated future growth. We generally fund our capital expenditures with cash from operations. Future capital spending for anticipated growth and replacement assets will depend on a variety of factors, including economic and industry conditions. In 2017 we began a multi-year investment program in our smart global logistics network which impacts all asset categories, with the largest investments in buildings, facilities and plant equipment. This investment program will continue in 2020, and we anticipate that our capital expenditures will be approximately \$6.5 to \$7.0 billion.

Capital expenditures on buildings, facilities and plant equipment decreased in 2019 compared to 2018 in our U.S. and international package businesses, as we completed several facility automation and capacity expansion projects in 2018. Capital spending on aircraft increased in 2019 compared 2018 due to a net increase in contract deposits on open aircraft orders and final payments associated with the delivery of aircraft. Capital spending on information technology increased in 2019 compared to 2018 due to continuing development of technology enabled solutions and capitalized software projects. Capital spending on vehicles increased in 2019 relative to 2018, largely due to the timing of vehicle replacements and expansion of the overall fleet to support volume growth.

Proceeds from the disposal of property, plant and equipment were largely attributable to the sale of an international property in 2019 and disposal of equipment in 2018. The net change in finance receivables was due to reductions in our finance portfolios in 2019 compared with 2018. Purchases and sales of marketable securities are largely determined by liquidity needs and the periodic rebalancing of investment types, and will fluctuate from period to period.

Cash paid for business acquisitions in 2019 and 2018 related to our acquisition of area franchise rights for The UPS Store, as well as other, small acquisitions in our International Small Package and Logistics business units in 2019. Other investing activities are impacted by changes in our non-current investments and various other items.

MANAGEMENT'S DISCUSSION AND ANALYSIS OF FINANCIAL CONDITION AND
RESULTS OF OPERATIONS*Cash Flows From Financing Activities*

Our primary sources (uses) of cash for financing activities were as follows (amounts in millions, except per share data):

	2019	2018
Net cash used in financing activities	\$ (1,727)	\$ (5,692)
Share Repurchases:		
Cash expended for shares repurchased	\$ (1,004)	\$ (1,011)
Number of shares repurchased	(9.1)	(8.9)
Shares outstanding at period end	857	858
Percent increase (decrease) in shares outstanding	(0.1)%	(0.1)%
Dividends:		
Dividends declared per share	\$ 3.84	\$ 3.64
Cash expended for dividend payments	\$ (3,194)	\$ (3,011)
Borrowings:		
Net borrowings (repayments) of debt principal	\$ 2,419	\$ (1,622)
Other Financing Activities:		
Cash received for common stock issuances	\$ 218	\$ 240
Other financing activities	\$ (166)	\$ (288)
Capitalization:		
Total debt outstanding at year end	\$ 25,238	\$ 22,736
Total shareowners' equity at year end	3,283	3,037
Total capitalization	\$ 28,521	\$ 25,773

For the years ended December 31, 2019 and 2018, we repurchased a total of 9.1 and 8.9 million shares of class A and class B common stock for \$1.005 and \$1.000 billion, respectively (\$1.004 and \$1.011 billion in repurchases for 2019 and 2018, respectively, are reported on the cash flow statement due to the timing of settlements). For additional information on our share repurchase activities, see note 11 to the audited, consolidated financial statements.

For the years ended December 31, 2019 and 2018, dividends reported within shareowners' equity include \$147 and \$178 million, respectively, of non-cash dividends that were settled in shares of class A common stock.

The declaration of dividends is subject to the discretion of the Board of Directors and depends on various factors, including our net income, financial condition, cash requirements, future prospects and other relevant factors. We expect to continue the practice of paying regular cash dividends. In February 2020, we increased our quarterly dividend payment from \$0.96 to \$1.01 per share, a 5.2% increase.

**MANAGEMENT'S DISCUSSION AND ANALYSIS OF FINANCIAL CONDITION AND
RESULTS OF OPERATIONS**

Issuances of debt in 2019 consisted of fixed-rate senior notes totaling \$3.0 billion and commercial paper. In 2018, issuances of debt consisted primarily of commercial paper. The following is a summary of debt issuances in 2019 (in millions):

	<u>Principal Amount in USD</u>
2019	
Fixed-rate senior notes:	
2.200% senior notes	\$ 400
2.500% senior notes	400
3.400% senior notes (multiple issuances)	1,450
4.250% senior notes	750
Total	<u>\$ 3,000</u>

Repayments of debt in 2019 and 2018 consisted primarily of our \$1.0 billion 5.125% fixed-rate senior notes that matured in April 2019 and our \$750 million 5.50% fixed-rate senior notes that matured in January 2018. The remaining repayments of debt during the period included paydowns of commercial paper and scheduled principal payments on our finance lease obligations. We consider the overall fixed and floating interest rate mix of our portfolio and the related overall cost of borrowing when planning for future issuances and non-scheduled repayments of debt.

The amount of commercial paper outstanding fluctuates throughout the year based on daily liquidity needs. The following is a summary of our commercial paper program (in millions):

	<u>Functional currency outstanding balance at year end</u>	<u>Outstanding balance at year end (\$)</u>	<u>Average balance outstanding</u>	<u>Average balance outstanding (\$)</u>	<u>Average interest rate</u>
2019					
USD	\$ 2,172	\$ 2,172	\$ 1,665	\$ 1,665	2.24 %
EUR	€ 949	\$ 1,062	€ 903	\$ 1,011	(0.39)%
Total		<u>\$ 3,234</u>			

	<u>Functional currency outstanding balance at year end</u>	<u>Outstanding balance at year end (\$)</u>	<u>Average balance outstanding</u>	<u>Average balance outstanding (\$)</u>	<u>Average interest rate</u>
2018					
USD	\$ 1,968	\$ 1,968	\$ 2,137	\$ 2,137	1.81 %
EUR	€ 606	\$ 694	€ 360	\$ 425	(0.38)%
Total		<u>\$ 2,662</u>			

The variation in cash received from common stock issuances was primarily due to the amount of stock option exercises by employees in 2018 and 2019.

Other financing activities includes cash used to repurchase shares from employees sold to satisfy tax withholding obligations on vested stock awards of \$180 and \$259 million in 2019 and 2018, respectively. Net cash inflows from premium payments and settlements of capped call options for the purchase of UPS class B shares were \$21 and \$34 million in 2019 and 2018, respectively.

Sources of Credit

See note 8 to the audited, consolidated financial statements for a discussion of our available credit and debt covenants.

MANAGEMENT'S DISCUSSION AND ANALYSIS OF FINANCIAL CONDITION AND RESULTS OF OPERATIONS

Guarantees and Other Off-Balance Sheet Arrangements

Except as disclosed in note 8 to the audited, consolidated financial statements, we do not have guarantees or other off-balance sheet financing arrangements, including variable interest entities, which we believe could have a material impact on financial condition or liquidity.

Contractual Commitments

We have contractual obligations and commitments in the form of finance leases, operating leases, debt obligations, purchase commitments and certain other liabilities. We intend to satisfy these obligations primarily through the use of cash flow from operations. The following table summarizes the expected cash outflow to satisfy our contractual obligations and commitments as of December 31, 2019 (in millions):

Commitment Type	2020	2021	2022	2023	2024	After 2024	Total
Finance Leases	\$ 199	44	39	37	35	259	\$ 613
Operating Leases	619	536	451	360	256	1,267	3,489
Debt Principal	4,232	2,551	2,001	2,284	1,474	12,349	24,891
Debt Interest	749	661	601	521	481	6,522	9,535
Purchase Commitments ⁽¹⁾	3,569	1,982	966	323	261	201	7,302
Tax Act Repatriation Liability	—	—	—	13	49	61	123
Pension Funding	1,180	—	—	—	—	—	1,180
Total	\$ 10,548	\$ 5,774	\$ 4,058	\$ 3,538	\$ 2,556	\$ 20,659	\$ 47,133

⁽¹⁾ Purchase commitments includes amounts due under aircraft leases that we entered into in 2019 and our January 29, 2020 announced commitment to purchase 10,000 electric vehicles.

Our finance lease obligations relate primarily to leases on aircraft and real estate. Finance leases and operating leases are discussed further in note 10 to the audited, consolidated financial statements. Purchase commitments, as well as our debt principal obligations, are discussed further in note 8 to the audited, consolidated financial statements. The amount of interest on our debt was calculated as the contractual interest payments due on our fixed-rate debt and variable rate debt based on interest rates as of December 31, 2019. The calculations of debt interest take into account the effect of interest rate swap agreements. For debt denominated in a foreign currency, the U.S. Dollar equivalent principal amount of the debt at the end of the year was used as the basis to calculate future interest payments.

Purchase commitments represent contractual agreements to purchase assets, goods or services that are legally binding, including contracts for aircraft, construction of new or expanded facilities and orders for technology equipment and vehicles. As of December 31, 2019, we had firm commitments to lease three used and purchase eight new Boeing 767-300 aircraft, to be delivered between 2020 and 2021 and to purchase 13 new Boeing 747-8F aircraft to be delivered between 2020 and 2022. We also had a firm commitment to purchase five Boeing MD-11 aircraft to be delivered between 2020 and 2021. We paid the full purchase price for these MD-11 aircraft in December 2019; therefore these amounts are not included in the table above.

On December 22, 2017, the United States enacted into law the Tax Act requiring a one-time transition tax on certain unrepatriated earnings of foreign subsidiaries. Companies may elect to pay the tax over eight years based on an installment schedule outlined in the Tax Act but are required under current Internal Revenue Service guidance to offset certain overpayments of tax against the liability. We made this election and have reflected our remaining transition tax due by year as a contractual obligation.

There are no anticipated required minimum cash contributions to our qualified U.S. pension plans (these plans are discussed further in note 5 to the audited, consolidated financial statements). The amount of any minimum funding requirement, as applicable, for these plans could change significantly in future periods depending on many factors, including future plan asset returns, discount rates, other actuarial assumptions and changes to pension plan funding regulations. A decline in discount rates or a sustained significant decline in equity or bond returns could result in our domestic pension plans being subject to significantly higher minimum funding requirements. Actual contributions made in future years could materially differ and consequently required minimum contributions beyond 2020 cannot be reasonably estimated.

**MANAGEMENT'S DISCUSSION AND ANALYSIS OF FINANCIAL CONDITION AND
RESULTS OF OPERATIONS**

As discussed in note 6 to the audited, consolidated financial statements, we are not currently subject to any minimum contributions or surcharges with respect to the multiemployer pension and health and welfare plans in which we participate. Contribution rates to these multiemployer pension and health and welfare plans are established through the collective bargaining process. As we are not subject to any minimum contribution levels, we have not included any amounts in the contractual commitments table with respect to these multiemployer plans.

The table above does not include approximately \$228 million of liabilities for uncertain tax positions because we are uncertain if or when such amounts will ultimately be settled in cash. Uncertain tax positions are further discussed in note 14 to the audited, consolidated financial statements.

As of December 31, 2019, we had outstanding letters of credit totaling approximately \$1.267 billion issued in connection with our self-insurance reserves and other routine business requirements. We also issue surety bonds as an alternative to letters of credit in certain instances, and as of December 31, 2019, we had \$1.327 billion of surety bonds written. As of December 31, 2019, we had unfunded loan commitments totaling \$131 million associated with UPS Capital.

We believe that funds from operations and borrowing programs will provide adequate sources of liquidity and capital resources to meet our expected long-term needs for the operation of our business, including anticipated capital expenditures, transformation strategy and pension contributions for the foreseeable future.

Contingencies

See note 5 to the audited, consolidated financial statements for a discussion of pension related matters and note 9 for a discussion of judicial proceedings and other matters arising from the conduct of our business activities.

Collective Bargaining Agreements*Status of Collective Bargaining Agreements*

See note 6 to the audited, consolidated financial statements for a discussion of the status of collective bargaining agreements.

Multiemployer Benefit Plans

We contribute to a number of multiemployer pension and health and welfare plans under the terms of collective bargaining agreements that cover our union represented employees. Our current collective bargaining agreements set forth the annual contribution increases allotted to the plans that we participate in, and we are in compliance with these contribution rates. These limitations will remain in effect throughout the terms of the existing collective bargaining agreements.

New Accounting Pronouncements*Recently Adopted Accounting Standards*

See note 1 to the audited, consolidated financial statements for a discussion of recently adopted accounting standards.

Accounting Standards Issued But Not Yet Effective

See note 1 to the audited, consolidated financial statements for a discussion of accounting standards issued, but not yet effective.

Rate Adjustments

Effective December 29, 2019, the rates and accessorial charges for UPS Ground, UPS Air and International services increased by an average net 4.9%. UPS Air Freight rates within and between the U.S., Canada and Puerto Rico increased an average net 4.2%. Density-based UPS Freight non-contractual LTL rates using Tariff 580 increased an average net 3.9%.

These rate changes are customary and occur on an annual basis. Rate changes for shipments originating outside the U.S. are made throughout the year and vary by geographic market.

**MANAGEMENT'S DISCUSSION AND ANALYSIS OF FINANCIAL CONDITION AND
RESULTS OF OPERATIONS****Critical Accounting Policies and Estimates**

This discussion and analysis of our financial condition and results of operations are based on our consolidated financial statements, which are prepared in accordance with GAAP. As indicated in note 1 to the audited, consolidated financial statements, the amounts of assets, liabilities, revenue and expenses reported in our financial statements are affected by estimates and judgments that are necessary to comply with GAAP. We base our estimates on prior experience and assumptions and third-party input that we consider reasonable to our circumstances. Actual results could differ materially from our estimates, which would affect the related amounts reported in our consolidated financial statements. While estimates and judgments are applied in arriving at many reported amounts, we believe that the following critical accounting policies involve a higher degree of judgment and complexity.

Contingencies

As discussed in note 9 to the audited, consolidated financial statements, we are involved in various legal proceedings and subject to various contingencies. The events that may impact our contingent liabilities are often unique and generally are not predictable. At the time a contingency is identified, we consider all relevant facts as part of our evaluation. We record a liability for a loss when the loss is probable of occurring and reasonably estimable. Events may arise that were not anticipated and the outcome of a contingency may result in a loss to us that differs from our previously estimated liability. This difference could be material. Income taxes and self-insurance are discussed below. Except as disclosed in note 9 to the audited, consolidated financial statements, other contingent losses that were probable and estimable were not material to our financial position or results of operations as of, or for the year ended, December 31, 2019. In addition, we have certain contingent liabilities that have not been recognized as of, or for the year ended, December 31, 2019, because a loss was not reasonably estimable.

Goodwill and Intangible Impairment

We test goodwill for impairment in each of our reporting units on an annual basis. Our U.S. Domestic Package segment is a reporting unit. In our International Package reporting segment, we have the following reporting units: Europe, Asia, Americas and ISMEA. In our Supply Chain & Freight segment we have the following reporting units: Forwarding, Logistics, UPS Mail Innovations, UPS Freight, The UPS Store, UPS Capital, Marken and Coyote Logistics. Our annual goodwill impairment testing date is July 1st for each reporting unit owned at the testing date. In assessing goodwill for impairment, we initially evaluate qualitative factors to determine if it is more likely than not that the fair value of a reporting unit is less than its carrying amount. If the qualitative assessment is not conclusive and it is necessary to calculate the fair value of a reporting unit, then we utilize a two-step process to test goodwill for impairment. First, a comparison of the fair value of the applicable reporting unit with the aggregate carrying value, including goodwill, is performed. If the carrying amount of a reporting unit exceeds the reporting unit's fair value, we perform the second step of the goodwill impairment test to determine the amount of impairment loss. The second step includes comparing the implied fair value of the affected reporting unit's goodwill with the carrying value of that goodwill.

We primarily determine the fair value of our reporting units using a discounted cash flow ("DCF") model and supplement this with observable valuation multiples for comparable companies, as appropriate. The completion of the DCF model requires that we make a number of significant assumptions to produce an estimate of future cash flows. These assumptions include projections of future revenue, costs, capital expenditures and working capital changes, as well as assumptions about the estimated cost of capital and other relevant variables. The projections that we use in our DCF model are updated annually and will change over time based on the historical performance and changing business conditions for each of our reporting units. The determination of whether goodwill is impaired involves a significant level of judgment in these assumptions, and changes in our business strategy, government regulations, or economic or market conditions could significantly impact these judgments. We routinely monitor market conditions and other factors to determine if interim impairment tests are necessary. If impairment indicators are present in future periods, the resulting impairment charges could have a material impact on our results of operations.

None of the reporting units incurred any goodwill impairment charges in 2019 or 2018. Changes in our forecasts could cause carrying values of our reporting units to exceed their fair values in future periods, potentially resulting in a goodwill impairment charge. During the year, management monitored the actual performance of the business relative to the fair value assumptions used during our annual goodwill impairment test. For the periods presented, no triggering events were identified that required an interim impairment test. Based on most recent tests, the fair value of all our reporting units exceed their carrying value.

**MANAGEMENT'S DISCUSSION AND ANALYSIS OF FINANCIAL CONDITION AND
RESULTS OF OPERATIONS**

A trade name with a carrying value of \$200 million and licenses with a carrying value of \$4 million as of December 31, 2019 are considered to be indefinite-lived intangibles, and therefore are not amortized. Impairment tests for indefinite-lived intangibles are performed on an annual basis. We determined that the income approach, specifically the relief from royalty method, is the most appropriate valuation method for the trade name. The estimated fair value of the trade name is compared to the carrying value of the asset. If the carrying value of the trade name exceeds its estimated fair value, an impairment charge is recognized for the amount by which the carrying amount of the asset exceeds its fair value. This valuation approach requires that we make a number of assumptions to estimate fair value. These assumptions include projections of future revenues, market royalty rates, tax rates, discount rates and other relevant variables. The projections we use in the model are updated annually and will change over time based on the historical performance and changing business conditions.

All of our remaining recorded intangible assets are deemed to be finite-lived intangibles, and are amortized over their estimated useful lives. Impairment tests for these intangible assets are only performed when a triggering event occurs that indicates that the carrying value of the intangible may not be recoverable based on the undiscounted future cash flows of the intangible. If the carrying amount of the intangible is determined not to be recoverable, a write-down to fair value is recorded. Fair values are determined based on a DCF model. If impairment indicators are present in future periods, the resulting impairment charges could have a material impact on our results of operations. Impairments of finite-lived intangible assets were \$2 and \$12 million in 2019 and 2018, respectively. There were no impairments of indefinite-lived intangible assets in 2019 or 2018.

Self-Insurance Accruals

We self-insure costs associated with workers' compensation claims, automobile liability, health and welfare and general business liabilities, up to certain limits. Insurance reserves are established for estimates of the loss that we will ultimately incur on reported claims, as well as loss estimates for claims that have been incurred but not yet reported. Recorded balances are based on third-party actuarial estimates, which incorporate historical loss experience and judgments about the present and expected cost per claim. Trends in actual experience are a significant factor in the determination of our reserves.

Workers' compensation, automobile liability and general liability insurance claims may take several years to completely settle. Consequently, actuarial estimates are required to project the ultimate cost that will be incurred to fully resolve a claim. A number of factors can affect the actual cost of a claim, including the length of time the claim remains open, trends in healthcare costs, the results of any related litigation and with respect to workers' compensation claims and changes in legislation. Furthermore, claims may emerge in a future year for events that occurred in a prior year at a rate that differs from actuarial projections. All of these factors can result in revisions to actuarial projections and produce a material difference between estimated and actual operating results. Based on our historical experience, during 2019 we changed our self-insurance reserves from the central estimate to the low end of the actuarial range of losses. We believe our estimated reserves for such claims are adequate; actual experience in claim frequency and/or severity could materially differ from our estimates and affect our results of operations. For additional information on our self-insurance reserves, refer to note 1 of the audited, consolidated financial statements.

We sponsor a number of health and welfare insurance plans for our employees. Liabilities and expenses related to these plans are based on estimates of, among other things, the number of employees and eligible dependents covered under the plans, anticipated medical usage by participants and overall trends in medical costs and inflation. We believe our estimates are reasonable/appropriate. Actual experience may differ from these estimates and, therefore, produce a material difference between estimated and actual operating results.

Pension and Postretirement Medical Benefits

Our pension and other postretirement benefit costs are calculated using various actuarial assumptions and methodologies. These assumptions include discount rates, healthcare cost trend rates, inflation, compensation increase rates, expected returns on plan assets, mortality rates and other factors. The assumptions utilized in recording the obligations under our plans represent our best estimates, and we believe that they are reasonable, based on information as to historical experience and performance as well as other factors that might cause future expectations to differ from past trends.

MANAGEMENT'S DISCUSSION AND ANALYSIS OF FINANCIAL CONDITION AND RESULTS OF OPERATIONS

Differences in actual experience or changes in assumptions may affect our pension and other postretirement obligations and future expenses. The primary factors contributing to actuarial gains and losses each year are (1) changes in the discount rate used to value pension and postretirement benefit obligations as of the measurement date, (2) differences between the expected and the actual return on plan assets, (3) changes in demographic assumptions including mortality, (4) participant experience different from demographic assumptions and (5) changes in coordinating benefits with plans not sponsored by UPS. In October 2019, we refined the bond matching approach used to determine the discount rate for our U.S. pension and postretirement plans by implementing advances in technology and modeling techniques. This refinement decreased the projected benefit obligation on our consolidated balance sheet by approximately \$900 million as of December 31, 2019, decreased the pre-tax mark-to-market charge by approximately \$810 million and increased net income by \$616 million, or \$0.71 per share on a basic and diluted basis.

We recognize changes in the fair value of plan assets and net actuarial gains or losses in excess of a corridor (defined as 10% of the greater of the fair value of plan assets or the plans' projected benefit obligations) in pension expense annually at December 31st each year. The remaining components of pension expense (herein referred to as "ongoing net periodic benefit cost"), primarily service and interest costs and the expected return on plan assets, are reported on a quarterly basis.

The following sensitivity analysis shows the impact of a 25 basis point change in the assumed discount rate and return on assets for our pension and postretirement benefit plans, and the resulting increase/(decrease) on our obligations and expense as of, and for the year ended, December 31, 2019 (in millions).

Pension Plans	25 Basis Point Increase	25 Basis Point Decrease
<i>Discount Rate:</i>		
Effect on ongoing net periodic benefit cost	\$ (37)	\$ 38
Effect on net periodic benefit cost for amounts recognized outside the 10% corridor	(1,390)	2,043
Effect on projected benefit obligation	(2,156)	2,294
<i>Return on Assets:</i>		
Effect on ongoing net periodic benefit cost ⁽¹⁾	(100)	100
Effect on net periodic benefit cost for amounts recognized outside the 10% corridor ⁽²⁾	(100)	100
Postretirement Medical Plans		
<i>Discount Rate:</i>		
Effect on ongoing net periodic benefit cost	3	(3)
Effect on net periodic benefit cost for amounts recognized outside the 10% corridor	(37)	48
Effect on accumulated postretirement benefit obligation	(55)	65
<i>Healthcare Cost Trend Rate:</i>		
Effect on ongoing net periodic benefit cost	1	(1)
Effect on net periodic benefit cost for amounts recognized outside the 10% corridor	4	(5)
Effect on accumulated postretirement benefit obligation	14	(16)

⁽¹⁾ Amount calculated based on 25 basis point increase / decrease in the expected return on assets.

⁽²⁾ Amount calculated based on 25 basis point increase / decrease in the actual return on assets.

Refer to note 5 to the audited, consolidated financial statements for information on our potential liability for coordinating benefits related to the Central States Pension Fund.

**MANAGEMENT'S DISCUSSION AND ANALYSIS OF FINANCIAL CONDITION AND
RESULTS OF OPERATIONS*****Depreciation, Residual Value and Impairment of Fixed Assets***

As of December 31, 2019, we had \$30.482 billion of net fixed assets, the most significant category of which is aircraft. In accounting for fixed assets, we make estimates of the expected useful lives, the expected residual values and the potential for impairment based on the fair values of the assets and the cash flows which they generate.

In estimating the lives and expected residual values of aircraft, we rely upon actual experience with the same or similar aircraft types. Revisions to these estimates could be caused by changes to our maintenance programs, changes in the utilization of the aircraft, governmental regulations on aging aircraft and changing market prices of new and used aircraft of the same or similar types. We periodically evaluate these estimates and assumptions, and adjust them as necessary. Adjustments are accounted for on a prospective basis through depreciation expense. In 2019, we revised our estimates of the useful lives and residual values for certain airframes, engines and related rotatable parts. This change increased the useful lives of certain fleet types and reduced the useful lives and residual values of the majority of our used aircraft. The net impact to 2019 depreciation expense was not material. In estimating cash flows, we project future volume levels for our different air products in all geographic regions in which we do business. Adverse changes in these volume forecasts, or a shortfall of our actual volume compared with our projections, could result in our current aircraft capacity exceeding current or projected demand. This situation could lead to an excess of a particular aircraft, resulting in an aircraft impairment charge or a reduction of the expected life of an aircraft (thus resulting in increased depreciation expense).

We evaluate the useful lives of our property, plant and equipment based on our usage, maintenance and replacement policies, and taking into account physical and economic factors that may affect the useful lives of the assets. As part of our ongoing investment in transformation in 2018, we revised our estimates of useful lives for building improvements, vehicles and plant equipment based on our current assessment of these factors. In general, these changes in estimate had the effect of lengthening the useful lives of vehicles, building improvements and plant equipment, and were applied prospectively beginning in 2018 through depreciation expense. See "Consolidated Operating Expenses" of this "Management's Discussion and Analysis of Financial Condition and Results of Operations" for the discussion of the impacts to "Depreciation and Amortization." See note 1 to the audited, consolidated financial statements for a discussion of our accounting policies and note 4 for a discussion of the change in estimated useful lives.

We review long-lived assets for impairment when circumstances indicate the carrying amount of an asset may not be recoverable based on the undiscounted future cash flows of the asset. If the carrying amount of the asset is determined not to be recoverable, a write-down to fair value is recorded. Fair values are determined based on quoted market values, discounted cash flows or external appraisals, as appropriate. We review long-lived assets for impairment at the individual asset or the asset group level for which the lowest level of independent cash flows can be identified. The circumstances that would indicate potential impairment may include, but are not limited to, a significant change in the extent to which an asset is utilized and operating or cash flow losses associated with the use of the asset.

There were no impairment charges on our property, plant and equipment during 2019 or 2018.

Fair Value Measurements

In the normal course of business, we hold and issue financial instruments that contain elements of market risk, including derivatives, marketable securities, finance receivables, pension assets, other investments and debt. Certain of these financial instruments are required to be recorded at fair value, principally derivatives, marketable securities, pension assets and certain other investments. Fair values are based on listed market prices, when such prices are available. To the extent that listed market prices are not available, fair value is determined based on other relevant factors, including dealer price quotations. If listed market prices or other relevant factors are not available, inputs are developed from unobservable data reflecting our own assumptions and include situations where there is little or no market activity for the asset or liability. Certain financial instruments, including over-the-counter derivative instruments, are valued using pricing models that consider, among other factors, contractual and market prices, correlations, time value, credit spreads and yield curve volatility factors. Changes in the fixed income, foreign exchange and commodity markets will impact our estimates of fair value in the future, potentially affecting our results of operations. A quantitative sensitivity analysis of our exposure to changes in commodity prices, foreign currency exchange rates and interest rates is presented in the "Quantitative and Qualitative Disclosures about Market Risk" section of this report.

**MANAGEMENT'S DISCUSSION AND ANALYSIS OF FINANCIAL CONDITION AND
RESULTS OF OPERATIONS**

Certain non-financial assets and liabilities are measured at fair value on a nonrecurring basis, including property, plant, and equipment, goodwill and intangible assets. These assets are not measured at fair value on a recurring basis; however, they are subject to fair value adjustments in certain circumstances, such as when there is evidence of an impairment.

For acquisitions, we allocate the fair value of purchase consideration to the tangible assets acquired, liabilities assumed and intangible assets acquired based on their estimated fair values. The excess of the fair value of purchase consideration over the fair values of these identifiable assets and liabilities is recorded as goodwill. Such valuations require management to make significant estimates and assumptions, especially with respect to intangible assets. Significant estimates in valuing certain intangible assets include, but are not limited to, future expected cash flows from acquired customers, technology and trade names from a market participant perspective, useful lives and discount rates. Management's estimates of fair value are based upon assumptions believed to be reasonable, but which are inherently uncertain and unpredictable. As a result, actual results may differ from estimates. During the measurement period, which is one year from the acquisition date, we may record adjustments to the assets acquired and liabilities assumed, with the corresponding offset to goodwill. Upon the conclusion of the measurement period, any subsequent adjustments are recorded to earnings.

Income Taxes

We make certain estimates and judgments in determining income tax expense for financial statement purposes. These estimates and judgments occur in the calculation of income by legal entity and jurisdiction, tax credits, benefits and deductions, and in the calculation of deferred tax assets and liabilities, which arise from differences in the timing of recognition of revenue and expense for tax and financial statement purposes, as well as tax, interest and penalties related to uncertain tax positions. Significant changes to these estimates may result in an increase or decrease to our tax provision in a subsequent period.

We assess the likelihood that we will be able to recover our deferred tax assets. If recovery is not likely, we must increase our provision for taxes by recording a valuation allowance against the deferred tax assets that we estimate will not ultimately be recoverable. We believe that we will ultimately recover a substantial majority of the deferred tax assets recorded on our consolidated balance sheets. However, should there be a change in our ability to recover our deferred tax assets, our tax provision would increase in the period in which we determined that the recovery was not likely.

The calculation of our tax liabilities involves dealing with uncertainties in the application of complex tax regulations. We recognize liabilities for uncertain tax positions based on a two-step process. The first step is to evaluate the tax position for recognition by determining if the weight of available evidence indicates that it is more likely than not that the position will be sustained on audit, including resolution of related appeals or litigation processes, if any. Once it is determined that the position meets the recognition threshold, the second step requires us to estimate and measure the largest amount of tax benefit that is more likely than not to be realized upon ultimate settlement. The difference between the amount of recognizable tax benefit and the total amount of tax benefit from positions filed or to be filed with the tax authorities is recorded as a liability for uncertain tax benefits. It is inherently difficult and subjective to estimate such amounts, as we have to determine the probability of various possible outcomes. We reevaluate uncertain tax positions on a quarterly basis. This evaluation is based on factors including, but not limited to, changes in facts or circumstances, changes in tax law, effectively settled issues under audit and new audit activity. Such a change in recognition or measurement could result in the recognition of a tax benefit or an additional charge to the tax provision.

See note 14 to the audited consolidated financial statements for a discussion of impacts of the Tax Act.

**MANAGEMENT'S DISCUSSION AND ANALYSIS OF FINANCIAL CONDITION AND
RESULTS OF OPERATIONS****Item 7A. *Quantitative and Qualitative Disclosures about Market Risk***

We are exposed to market risk from changes in certain commodity prices, foreign currency exchange rates, interest rates and equity prices. All of these market risks arise in the normal course of business, as we do not engage in speculative trading activities. In order to manage the risk arising from these exposures, we utilize a variety of commodity, foreign exchange and interest rate forward contracts, options and swaps. A discussion of our accounting policies for derivative instruments and further disclosures are provided in note 1 to the audited, consolidated financial statements.

Commodity Price Risk

We are exposed to changes in the prices of refined fuels, principally jet-A, diesel and unleaded gasoline, as well as changes in the price of natural gas and other alternative fuels. Currently, the fuel surcharges that we apply to our domestic and international package and LTL services are the primary means of reducing the risk of adverse fuel price changes. In order to mitigate the impact of fuel surcharges imposed on us by outside carriers, we regularly adjust the rates we charge for our freight brokerage, inter-modal and truckload services. The majority of our contracts for fuel purchases utilize index-based pricing formulas plus or minus a fixed locational/supplier differential. While many of the indices are aligned, each index may fluctuate at a different pace, driving variability in the prices paid for fuel. Because of this, our operating results may be affected should the market price of fuel suddenly change by a significant amount or change by amounts that do not result in an adjustment in our fuel surcharges, which can significantly affect our earnings either positively or negatively in the short-term. Additionally, we periodically use a combination of option, forward and futures contracts to provide partial protection from changing fuel and energy prices. As of December 31, 2019 and 2018, however, we had no commodity contracts outstanding.

Foreign Currency Exchange Risk

We have foreign currency risks related to our revenue, operating expenses and financing transactions in currencies other than the local currencies in which we operate. We are exposed to currency risk from the potential changes in functional currency values of our foreign currency-denominated assets, liabilities and cash flows. Our most significant foreign currency exposures relate to the Euro, British Pound Sterling, Canadian Dollar, Chinese Renminbi and Hong Kong Dollar. We use forwards as well as a combination of purchased and written options to hedge forecasted cash flow currency exposures. These derivative instruments generally cover forecasted foreign currency exposures for periods of 12 to 48 months. We also utilize forward contracts to hedge portions of our anticipated cash settlements of intercompany transactions and interest payments on certain debt subject to foreign currency remeasurement.

Interest Rate Risk

We have issued debt instruments, including debt associated with finance leases, that accrue expense at fixed and floating rates of interest. We use a combination of interest rate swaps as part of our program to manage the fixed and floating interest rate mix of our total debt portfolio and related overall cost of borrowing. The notional amount, interest payment and maturity dates of the swaps match the terms of the associated debt. We also utilize forward starting swaps and similar instruments to lock in all or a portion of the borrowing cost of anticipated debt issuances. Our floating-rate debt and interest rate swaps subject us to risk resulting from changes in short-term (primarily LIBOR) interest rates. For a discussion of the risks associated with the anticipated cessation of LIBOR, see Item 1A. Risk Factors - "The proposed phase out of the London Interbank Offer Rate ("LIBOR") could have an adverse effect on us".

We also are subject to interest rate risk with respect to our pension and postretirement benefit obligations, as changes in interest rates will effectively increase or decrease our liabilities associated with these benefit plans, which also results in changes to the amount of pension and postretirement benefit expense recognized in future periods.

We have investments in debt securities, as well as cash-equivalent instruments, some of which accrue income at variable rates of interest. Additionally, we hold a portfolio of finance receivables that accrue income at fixed and floating rates of interest.

**MANAGEMENT'S DISCUSSION AND ANALYSIS OF FINANCIAL CONDITION AND
RESULTS OF OPERATIONS**

Sensitivity Analysis

The following analysis provides quantitative information regarding our exposure to foreign currency exchange risk, interest rate risk and equity price risk embedded in our existing financial instruments. We utilize valuation models to evaluate the sensitivity of the fair value of financial instruments with exposure to market risk that assume instantaneous, parallel shifts in exchange rates, interest rate yield curves and commodity and equity prices. For options and instruments with non-linear returns, models appropriate to the instrument are utilized to determine the impact of market shifts.

There are certain limitations inherent in the sensitivity analyses presented, primarily due to the assumption that exchange rates change in a parallel fashion and that interest rates change instantaneously. In addition, the analyses are unable to reflect the complex market reactions that normally would arise from the market shifts modeled. While this is our best estimate of the impact of the specified interest rate scenarios, these estimates should not be viewed as forecasts. We adjust the fixed and floating interest rate mix of our interest rate sensitive assets and liabilities in response to changes in market conditions. Additionally, changes in the fair value of foreign currency derivatives and commodity derivatives are offset by changes in the cash flows of the underlying hedged foreign currency and commodity transactions.

(in millions)	Shock-Test Result As of December 31,	
	2019	2018
Change in Fair Value:		
Currency Derivatives ⁽¹⁾	\$ (786)	\$ (743)
Change in Annual Interest Expense:		
Variable Rate Debt ⁽²⁾	\$ 64	\$ 58
Interest Rate Derivatives ⁽²⁾	\$ 37	\$ 47
Change in Annual Interest Income:		
Marketable Securities ⁽³⁾	\$ —	\$ 1

⁽¹⁾ The potential change in fair value from a hypothetical 10% weakening of the U.S. Dollar against local currency exchange rates across all maturities.

⁽²⁾ The potential change in annual interest expense resulting from a hypothetical 100 basis point increase in short-term interest rates, applied to our variable rate debt and swap instruments (excluding hedges of anticipated debt issuances).

⁽³⁾ The potential change in interest income resulting from a hypothetical 100 basis point increase in short-term interest rates, applied to our variable rate investment holdings.

The sensitivity of our pension and postretirement benefit obligations to changes in interest rates is quantified in “Critical Accounting Policies and Estimates”. The sensitivity in the fair value and interest income of our finance receivables due to changes in interest rates was not material as of December 31, 2019 and 2018.

Item 8. Financial Statements and Supplementary Data**Table of Contents**

<u>Report of Independent Registered Public Accounting Firm</u>	<u>53</u>
<u>Consolidated Balance Sheets</u>	<u>57</u>
<u>Statements of Consolidated Income</u>	<u>58</u>
<u>Statements of Consolidated Comprehensive Income (Loss)</u>	<u>58</u>
<u>Statements of Consolidated Cash Flows</u>	<u>59</u>
<u>Notes to Consolidated Financial Statements</u>	<u>60</u>
<u>Note 1—Summary of Accounting Policies</u>	<u>60</u>
<u>Note 2—Revenue Recognition</u>	<u>68</u>
<u>Note 3—Investments and Restricted Cash</u>	<u>71</u>
<u>Note 4—Property, Plant and Equipment</u>	<u>75</u>
<u>Note 5—Company Sponsored Employee Benefit Plans</u>	<u>76</u>
<u>Note 6—Multiemployer Employee Benefit Plans</u>	<u>88</u>
<u>Note 7—Goodwill and Intangible Assets</u>	<u>91</u>
<u>Note 8—Debt and Financing Arrangements</u>	<u>93</u>
<u>Note 9—Legal Proceedings and Contingencies</u>	<u>99</u>
<u>Note 10—Leases</u>	<u>101</u>
<u>Note 11—Shareowners’ Equity</u>	<u>105</u>
<u>Note 12—Stock-Based Compensation</u>	<u>109</u>
<u>Note 13—Segment and Geographic Information</u>	<u>113</u>
<u>Note 14—Income Taxes</u>	<u>116</u>
<u>Note 15—Earnings Per Share</u>	<u>121</u>
<u>Note 16—Derivative Instruments and Risk Management</u>	<u>122</u>
<u>Note 17—Transformation Strategy Costs</u>	<u>127</u>
<u>Note 18—Quarterly Information (Unaudited)</u>	<u>127</u>

Report of Independent Registered Public Accounting Firm

To the Shareowners and Board of Directors of
United Parcel Service, Inc.
Atlanta, Georgia

Opinion on the Financial Statements

We have audited the accompanying consolidated balance sheets of United Parcel Service, Inc. and subsidiaries (the "Company") as of December 31, 2019 and 2018, the related consolidated statements of income, comprehensive income, and cash flows, for each of the three years in the period ended December 31, 2019, and the related notes (collectively referred to as the "financial statements"). In our opinion, the financial statements present fairly, in all material respects, the financial position of the Company as of December 31, 2019 and 2018, and the results of its operations and its cash flows for each of the three years in the period ended December 31, 2019, in conformity with accounting principles generally accepted in the United States of America.

We have also audited, in accordance with the standards of the Public Company Accounting Oversight Board (United States) (PCAOB), the Company's internal control over financial reporting as of December 31, 2019, based on criteria established in *Internal Control - Integrated Framework (2013)* issued by the Committee of Sponsoring Organizations of the Treadway Commission and our report dated February 20, 2020, expressed an unqualified opinion on the Company's internal control over financial reporting.

Change in Accounting Principle

As discussed in Note 1 to the financial statements, the Company has changed its method of accounting for leases due to the adoption of Financial Accounting Standards Board Accounting Standards Update 2016-02, *Leases (Topic 842)*. This change has been applied on a modified retrospective basis effective on January 1, 2019.

Basis for Opinion

These financial statements are the responsibility of the Company's management. Our responsibility is to express an opinion on the Company's financial statements based on our audits. We are a public accounting firm registered with the PCAOB and are required to be independent with respect to the Company in accordance with the U.S. federal securities laws and the applicable rules and regulations of the Securities and Exchange Commission and the PCAOB.

We conducted our audits in accordance with the standards of the PCAOB. Those standards require that we plan and perform the audit to obtain reasonable assurance about whether the financial statements are free of material misstatement, whether due to error or fraud. Our audits included performing procedures to assess the risks of material misstatement of the financial statements, whether due to error or fraud, and performing procedures that respond to those risks. Such procedures included examining, on a test basis, evidence regarding the amounts and disclosures in the financial statements. Our audits also included evaluating the accounting principles used and significant estimates made by management, as well as evaluating the overall presentation of the financial statements. We believe that our audits provide a reasonable basis for our opinion.

Critical Audit Matters

The critical audit matters communicated below are matters arising from the current-period audit of the financial statements that were communicated or required to be communicated to the audit committee and that (1) relate to accounts or disclosures that are material to the financial statements and (2) involved our especially challenging, subjective, or complex judgments. The communication of critical audit matters does not alter in any way our opinion on the financial statements, taken as a whole, and we are not, by communicating the critical audit matters below, providing separate opinions on the critical audit matters or on the accounts or disclosures to which they relate.

Central States Pension Fund coordinating benefit obligation assumptions - Refer to Note 5, Company-Sponsored Employee Benefit Plans (Actuarial Assumptions - Central States Pension Fund), to the financial statements

Critical Audit Matter Description

The Company was a contributing employer to the Central States Pension Fund (“CSPF”) until 2007 when it withdrew and fully funded its allocable share of unvested benefits. The Company agreed to provide coordinating benefits in the UPS/IBT Full Time Employee Pension Plan (“UPS/IBT Plan”) to CSPF participants whose last employer was the Company and who had not retired as of January 1, 2008 (the “UPS Transfer Group”) if the CSPF were to lawfully reduce benefits consistent with the terms of its withdrawal agreement with the Company. The CSPF has asserted that, absent legislative reform, it will become insolvent in 2025. If the CSPF were to become insolvent consistent with that assertion, the Company may be required to provide coordinating benefits through the UPS/IBT Plan to the UPS Transfer Group.

Under accounting standards generally accepted in the United States of America (“GAAP”), the Company is required to determine its best estimate of the eventual outcome of this matter and is prohibited from anticipating potential changes in law in making that best estimate. The Company considered potential outcomes based on the existing legislative framework, including the eventual insolvency of the CSPF or an approved application to reduce benefits under the U.S. Multiemployer Pension Reform Act (“MPRA”). As the Company cannot consider a legislative solution when making its best estimate of its projected benefit obligation, the Company believes the trustees of the CSPF (the “Trustees”) would be more likely to pursue an application to reduce benefits under the MPRA than they would be to allow the insolvency of the CSPF.

Based upon this possible outcome, the Company developed assumptions related to 1) the order in which benefits would be reduced to groups of participants under MPRA, 2) whether CSPF can reduce benefits to the UPS Transfer Group under MPRA without the Company’s consent, 3) the timing and effective date of a MPRA application, and 4) the actuarial assumptions associated with the timing of future CSPF cash flows. Based on the Company’s deterministic cash flow projection, management recorded a projected benefit obligation of \$2.6 billion for the CSPF coordinating benefits at December 31, 2019. Given that the passage of time or changes in actuarial assumptions could reduce or eliminate the effectiveness of a MPRA application in the future, it is reasonably possible that, at the next measurement date, the projected benefit obligation could increase by approximately \$2.2 billion, resulting in a total obligation for the CSPF coordinating benefits of \$4.8 billion. The Company also developed disclosures of the risks and uncertainties associated with this matter.

The assumptions require significant management judgment and the following audit considerations:

1. Auditing management’s conclusion that the CSPF benefits to the UPS Transfer Group cannot be reduced without first exhausting benefit reductions to the other CSPF participants is challenging because there appears to be multiple legal interpretations of the benefit reduction provisions of MPRA and those provisions have not yet been litigated.
2. Auditing management’s conclusion that the CSPF could not reduce benefits to the UPS Transfer Group without the Company’s consent requires judgment because the agreement between CSPF and the Company requiring such consent was made before the passage of MPRA and has not yet been litigated.
3. Auditing management’s assumptions related to the timing and effective date of a MPRA application is subjective.
4. Auditing the actuarial assumptions used to estimate the timing and present value of future CSPF cash flows is challenging because the underlying data is limited to information made publicly available by the CSPF.
5. Auditing the sufficiency of the Company’s disclosure of this matter in the footnotes to the financial statements is challenging due to the number of uncertainties associated with the potential obligation.

How the Critical Audit Matter Was Addressed in the Audit

Our audit procedures to address the Company’s assumptions used to measure its potential obligation to pay for CSPF coordinating benefits to the UPS Transfer Group (the “Coordinating Benefits”) included the following, among others:

- We tested the effectiveness of controls over Coordinating Benefits assumptions, including those over the determination of the accounting model, the key legal positions relevant to determining its Coordinating Benefits obligation, the other actuarial assumptions used to project the potential Coordinating Benefits obligation; and the related financial statement disclosures.

- With the assistance of professionals in our firm having expertise in pension accounting, we evaluated the Company's conclusions regarding the accounting model applied to the Coordinating Benefits obligation through consideration of possible alternatives under GAAP.
- We evaluated the Company's assumptions used in determining the most likely outcome of the CSPF matter under the existing legislative framework. In order to evaluate the Company's expectation that the Trustees would pursue another benefit suspension in order to avoid insolvency, we obtained evidence regarding the fiduciary responsibilities of the Trustees to govern the CSPF in a manner that continues to provide benefits to participants and their beneficiaries.
- We evaluated the Company's conclusion that 1) the CSPF could not reduce benefits to the UPS Transfer Group under MPRA without first exhausting benefit reductions to the other CSPF participants and 2) the CSPF could not reduce benefits without obtaining the Company's consent based on the terms of an agreement between the CSPF and the Company. Specifically, we examined letters from internal and external counsel describing both counsel's conclusion that those positions are more likely than not to be sustained if they were to be litigated. With the assistance of professionals in our firm having expertise in legal matters, we also evaluated whether the legal arguments supporting this assertion had substantive legal basis.
- With the assistance of our actuarial specialists, we tested the underlying data and actuarial model used by management to estimate the potential obligation to provide Coordinating Benefits, including consideration of (1) the expected timing of CSPF benefit reductions; (2) the discount rate; (3) the projected contributions and benefit payments; and (4) the expected return on CSPF assets. Further, because the data used by management is limited to publicly available CSPF information, we considered whether other available sources of data may yield a more precise estimate.
- We compared the Company's footnote disclosure relating to this matter to the information communicated between management and the Company's audit committee to evaluate whether significant uncertainties had been omitted from the disclosure.

Valuation of U.S. hedge fund, risk parity, private debt, private equity and real estate investments - Refer to Note 5, Company-Sponsored Employee Benefit Plans (Fair Value Measurements), to the financial statements

Critical Audit Matter Description

The Company's U.S. pension and postretirement medical benefit plans (the "U.S. Plans") held hedge fund, risk parity, private debt, private equity and real estate investments valued at \$7.6 billion as of December 31, 2019.

The Company determines the reported values of the U.S. Plans' investments in hedge, risk parity, private debt, private equity and real estate funds primarily based on the estimated net asset value ("NAV") of the fund. In order to estimate NAV, the Company evaluates audited and unaudited financial reports from fund managers, and makes adjustments, as appropriate, for investment activity between the date of the financial reports and December 31st. These investments are not actively traded, and their values can only be estimated using these subjective assumptions.

Auditing the estimated NAV of these hedge fund, risk parity, private debt, private equity and real estate instruments requires a high degree of auditor judgment and subjectivity to evaluate the completeness, reliability and relevance of the inputs used by management.

How the Critical Audit Matter Was Addressed in the Audit

Our audit procedures related to the inputs used by management to estimate the NAV of the U.S. Plans' hedge fund, risk parity, private debt, private equity and real estate investments included the following, among others:

- We tested the effectiveness of controls, including those related to the reliability of values reported by fund managers, the relevance of asset class benchmark returns, and the completeness and accuracy of unobservable inputs related to the underlying assets of the funds.

- For certain investments, we confirmed directly with the respective fund manager its preliminary estimate of the fund's NAV as of December 31, 2019.
- We evaluated the Company's ability to accurately estimate NAV for these funds by comparing each fund's recorded valuation as of its most recent fiscal year end to the audited fund financial statements (which are received in arrears of the Company's reporting timetable).

Revenue - Refer to Note 2, Revenue Recognition, to the financial statements

Critical Audit Matter Description

Approximately 80 percent of the Company's revenues are from its global small package operations that provide time-definite delivery services for express letters, documents, small packages and palletized freight via air and ground services. The Company's global small package revenues are comprised of a significant volume of low-dollar transactions sourced from systems that were primarily developed by the Company. The processing of transactions, including the recording of them, is highly automated and based on contractual terms with the Company's customers.

Auditing global small package revenue required a significant extent of effort and the involvement of professionals with expertise in information technology ("IT") necessary for us to identify, test, and evaluate the Company's systems, software applications, and automated controls.

How the Critical Audit Matter Was Addressed in the Audit

Our audit procedures related to the Company's systems to process global small package revenue transactions included the following, among others:

- With the assistance of our IT specialists, we:
 - Identified the significant systems used to process global small package revenue transactions and tested the effectiveness of the general IT controls over each of these systems, including testing of user access controls, change management controls, and IT operations controls.
 - Tested the effectiveness of system interface controls and automated controls within the global small package revenue stream, as well as the controls designed to ensure the accuracy and completeness of revenue. We tested the effectiveness of controls over the relevant global small package revenue business processes, including those in place to reconcile the various systems to the Company's general ledger.
- We performed analytical procedures to evaluate the Company's recorded revenue and evaluate trends.
- For a sample of customers, we read the Company's contract with the customer and evaluated the Company's pattern of revenue recognition for the customer. In addition, we evaluated the accuracy of the Company's recorded global small package revenue for a sample of customer invoices.

/s/ Deloitte & Touche LLP

Atlanta, Georgia
February 20, 2020

We have served as the Company's auditor since 1969.

UNITED PARCEL SERVICE, INC. AND SUBSIDIARIES
CONSOLIDATED BALANCE SHEETS
(In millions)

	December 31,	
	2019	2018
ASSETS		
Current Assets:		
Cash and cash equivalents	\$ 5,238	\$ 4,225
Marketable securities	503	810
Accounts receivable, net	9,552	8,958
Current income taxes receivable	382	940
Other current assets	1,428	1,277
Total Current Assets	17,103	16,210
Property, Plant and Equipment, Net	30,482	26,576
Operating Lease Right-Of-Use Assets	2,856	—
Goodwill	3,813	3,811
Intangible Assets, Net	2,167	2,075
Investments and Restricted Cash	24	170
Deferred Income Tax Assets	330	141
Other Non-Current Assets	1,082	1,033
Total Assets	<u>\$ 57,857</u>	<u>\$ 50,016</u>
LIABILITIES AND SHAREOWNERS' EQUITY		
Current Liabilities:		
Current maturities of long-term debt and commercial paper	\$ 3,420	\$ 2,805
Current maturities of operating leases	538	—
Accounts payable	5,555	5,188
Accrued wages and withholdings	2,552	3,047
Self-insurance reserves	914	810
Accrued group welfare and retirement plan contributions	793	715
Other current liabilities	1,641	1,522
Total Current Liabilities	15,413	14,087
Long-Term Debt and Finance Leases	21,818	19,931
Non-Current Operating Leases	2,391	—
Pension and Postretirement Benefit Obligations	10,601	8,347
Deferred Income Tax Liabilities	1,632	1,619
Self-Insurance Reserves	1,282	1,571
Other Non-Current Liabilities	1,437	1,424
Shareowners' Equity:		
Class A common stock (156 and 163 shares issued in 2019 and 2018)	2	2
Class B common stock (701 and 696 shares issued in 2019 and 2018)	7	7
Additional paid-in capital	150	—
Retained earnings	9,105	8,006
Accumulated other comprehensive loss	(5,997)	(4,994)
Deferred compensation obligations	26	32
Less: Treasury stock (0.4 shares in 2019 and 0.6 shares in 2018)	(26)	(32)
Total Equity for Controlling Interests	3,267	3,021
Noncontrolling Interests	16	16
Total Shareowners' Equity	<u>3,283</u>	<u>3,037</u>
Total Liabilities and Shareowners' Equity	<u>\$ 57,857</u>	<u>\$ 50,016</u>

See notes to audited, consolidated financial statements.

UNITED PARCEL SERVICE, INC. AND SUBSIDIARIES
STATEMENTS OF CONSOLIDATED INCOME
(In millions, except per share amounts)

	Years Ended December 31,		
	2019	2018	2017
Revenue	\$ 74,094	\$ 71,861	\$ 66,585
Operating Expenses:			
Compensation and benefits	38,908	37,235	34,577
Repairs and maintenance	1,838	1,732	1,601
Depreciation and amortization	2,360	2,207	2,282
Purchased transportation	12,590	13,409	11,696
Fuel	3,289	3,427	2,690
Other occupancy	1,392	1,362	1,155
Other expenses	5,919	5,465	5,055
Total Operating Expenses	66,296	64,837	59,056
Operating Profit	7,798	7,024	7,529
Other Income and (Expense):			
Investment income (expense) and other	(1,493)	(400)	61
Interest expense	(653)	(605)	(453)
Total Other Income and (Expense)	(2,146)	(1,005)	(392)
Income Before Income Taxes	5,652	6,019	7,137
Income Tax Expense	1,212	1,228	2,232
Net Income	<u>\$ 4,440</u>	<u>\$ 4,791</u>	<u>\$ 4,905</u>
Basic Earnings Per Share	<u>\$ 5.14</u>	<u>\$ 5.53</u>	<u>\$ 5.63</u>
Diluted Earnings Per Share	<u>\$ 5.11</u>	<u>\$ 5.51</u>	<u>\$ 5.61</u>

STATEMENTS OF CONSOLIDATED COMPREHENSIVE INCOME (LOSS)
(In millions)

	Years Ended December 31,		
	2019	2018	2017
Net Income	\$ 4,440	\$ 4,791	\$ 4,905
Change in foreign currency translation adjustment, net of tax	48	(149)	86
Change in unrealized gain (loss) on marketable securities, net of tax	6	—	(1)
Change in unrealized gain (loss) on cash flow hedges, net of tax	72	485	(321)
Change in unrecognized pension and postretirement benefit costs, net of tax	(1,129)	272	(148)
Comprehensive Income (Loss)	<u>\$ 3,437</u>	<u>\$ 5,399</u>	<u>\$ 4,521</u>

See notes to audited, consolidated financial statements.

UNITED PARCEL SERVICE, INC. AND SUBSIDIARIES
STATEMENTS OF CONSOLIDATED CASH FLOWS
(In millions)

	Years Ended December 31,		
	2019	2018	2017
Cash Flows From Operating Activities:			
Net income	\$ 4,440	\$ 4,791	\$ 4,905
Adjustments to reconcile net income to net cash from operating activities:			
Depreciation and amortization	2,360	2,207	2,282
Pension and postretirement benefit expense	3,141	2,242	1,643
Pension and postretirement benefit contributions	(2,362)	(186)	(7,794)
Self-insurance reserves	(185)	(86)	—
Deferred tax (benefit) expense	100	758	1,224
Stock compensation expense	915	634	584
Other (gains) losses	74	293	37
Changes in assets and liabilities, net of effects of business acquisitions:			
Accounts receivable	(717)	(421)	(1,022)
Other assets	698	754	(984)
Accounts payable	419	1,034	599
Accrued wages and withholdings	(446)	505	200
Other liabilities	182	170	(243)
Other operating activities	20	16	48
Net cash from operating activities	<u>8,639</u>	<u>12,711</u>	<u>1,479</u>
Cash Flows From Investing Activities:			
Capital expenditures	(6,380)	(6,283)	(5,227)
Proceeds from disposals of property, plant and equipment	65	37	24
Purchases of marketable securities	(561)	(973)	(1,630)
Sales and maturities of marketable securities	883	886	1,990
Net change in finance receivables	13	4	5
Cash paid for business acquisitions, net of cash and cash equivalents acquired	(6)	(2)	(134)
Other investing activities	(75)	1	1
Net cash (used in) investing activities	<u>(6,061)</u>	<u>(6,330)</u>	<u>(4,971)</u>
Cash Flows From Financing Activities:			
Net change in short-term debt	310	63	(250)
Proceeds from long-term borrowings	5,205	1,202	12,016
Repayments of long-term borrowings	(3,096)	(2,887)	(3,939)
Purchases of common stock	(1,004)	(1,011)	(1,813)
Issuances of common stock	218	240	247
Dividends	(3,194)	(3,011)	(2,771)
Other financing activities	(166)	(288)	(203)
Net cash (used in)/from financing activities	<u>(1,727)</u>	<u>(5,692)</u>	<u>3,287</u>
Effect Of Exchange Rate Changes On Cash, Cash Equivalents and Restricted Cash	<u>20</u>	<u>(91)</u>	<u>53</u>
Net Increase (Decrease) In Cash, Cash Equivalents and Restricted Cash	<u>871</u>	<u>598</u>	<u>(152)</u>
Cash, Cash Equivalents and Restricted Cash:			
Beginning of period	4,367	3,769	3,921
End of period	<u>\$ 5,238</u>	<u>\$ 4,367</u>	<u>\$ 3,769</u>
Cash Paid During The Period For:			
Interest (net of amount capitalized)	<u>\$ 628</u>	<u>\$ 595</u>	<u>\$ 428</u>
Income taxes (net of refunds and overpayments)	<u>\$ 514</u>	<u>\$ 2</u>	<u>\$ 1,559</u>

See notes to audited, consolidated financial statements.

UNITED PARCEL SERVICE, INC. AND SUBSIDIARIES
NOTES TO CONSOLIDATED FINANCIAL STATEMENTS

NOTE 1. SUMMARY OF ACCOUNTING POLICIES

Basis of Financial Statements and Business Activities

The accompanying consolidated financial statements have been prepared in accordance with accounting principles generally accepted in the United States (“GAAP”), and include the accounts of United Parcel Service, Inc., and all of its consolidated subsidiaries (collectively “UPS” or the “Company”). All intercompany balances and transactions have been eliminated.

We provide transportation services, primarily domestic and international letter and package delivery. Through our Supply Chain & Freight subsidiaries, we are also a global provider of specialized transportation, logistics and financial services.

Use of Estimates

The preparation of our consolidated financial statements requires the use of estimates and assumptions that affect the reported amounts of assets and liabilities, the reported amounts of revenues and expenses and the disclosure of contingencies. Estimates have been prepared on the basis of the most current and best information, and actual results could differ materially from those estimates.

Revenue Recognition

U.S. Domestic and International Package Operations—Revenue is recognized over time as we perform the services in the contract.

Forwarding—Freight forwarding revenue and the expense related to the transportation of freight are recognized over time as we perform the services. Truckload brokerage revenue and related transportation costs are recognized over time as we perform the services. Customs brokerage revenue is recognized upon completing documents necessary for customs entry purposes.

Logistics—In our Logistics business we have a right to consideration from customers in an amount that corresponds directly with the value to the customers of our performance completed to date, and as such we recognize revenue in the amount to which we have a right to invoice the customer.

UPS Freight—Revenue is recognized over time as we perform the services in the contract.

Financial Services—Income on loans and direct finance leases is recognized on the effective interest method. Accrual of interest income is suspended at the earlier of the time at which collection of an account becomes doubtful or the account becomes 90 days delinquent. Income on operating leases is recognized on the straight-line method over the terms of the underlying leases.

Principal vs. Agent Considerations—We utilize independent contractors and third-party carriers in the performance of some transportation services. GAAP requires us to evaluate whether our businesses themselves promise to transfer services to the customer (as the principal) or to arrange for services to be provided by another party (as the agent) using a control model. Based on our evaluation of the control model, we determined that all of our major businesses act as the principal rather than the agent within their revenue arrangements. Revenue and the associated purchased transportation costs are reported on a gross basis within our statements of consolidated income.

Refer to note 2 for further discussion of our revenue recognition policies.

Cash and Cash Equivalents

Cash and cash equivalents consist of highly liquid investments that are readily convertible into cash. We consider securities with maturities of three months or less, when purchased, to be cash equivalents. The carrying amount of these securities approximates fair value because of the short-term maturity of these instruments.

Investments

Debt securities are either classified as trading or available-for-sale securities and are carried at fair value. Unrealized gains and losses on trading securities are reported as investment income (expense) and other on the statements of consolidated income. Unrealized gains and losses on available-for-sale securities are reported as accumulated other comprehensive income ("AOCI"), a separate component of shareowners' equity. The amortized cost of debt securities is adjusted for amortization of premiums and accretion of discounts to maturity. Such amortization and accretion is included in investment income (expense) and other, along with interest and dividends. The cost of securities sold is based on the specific identification method; realized gains and losses resulting from such sales are included in investment income (expense) and other.

We periodically review our available-for-sale investments for indications of other-than-temporary impairment considering many factors, including the extent and duration to which a security's fair value has been less than its cost, overall economic and market conditions and the financial condition and specific prospects for the issuer. Impairment of available-for-sale securities results in a charge to income when a market decline below cost is other-than-temporary.

Inventories

Fuel and other materials and supplies inventories are recognized as inventory when purchased, and then charged to expense when used in our operations. Jet fuel, diesel and unleaded gasoline inventories are valued at the lower of average cost or net realizable value. Total inventories were \$511 and \$421 million as of December 31, 2019 and 2018, respectively, and are included in "Other current assets" on the consolidated balance sheets.

Property, Plant and Equipment

Property, plant and equipment are carried at cost. We evaluate the useful lives of our property, plant and equipment based on our usage, maintenance and replacement policies, and taking into account physical and economic factors that may affect the useful lives of the assets. As part of our ongoing investment in transformation in 2018, we revised our estimates of useful lives for building improvements, vehicles and plant equipment based on our current assessment of these factors. In 2019, we revised our estimates of useful lives and residual values for certain airframes, engines and related rotatable parts. The changes in estimate had the effect of lengthening the useful lives of building improvements, vehicles, plant equipment and certain aircraft, and reduced the useful lives and residual values of the majority of our used aircraft.

Depreciation and amortization are provided by the straight-line method over the estimated useful lives of the assets, which are as follows:

- Aircraft: 12 to 40 years
- Buildings: 20 to 40 years
- Leasehold Improvements: lesser of asset useful life or lease term
- Plant Equipment: 3 to 20 years
- Technology Equipment: 3 to 5 years
- Vehicles: 6 to 15 years

For substantially all of our aircraft, the costs of major airframe and engine overhauls, as well as routine maintenance and repairs, are charged to expense as incurred.

Interest incurred during the construction period of certain property, plant and equipment is capitalized until the underlying assets are placed in service, at which time amortization of the capitalized interest begins, straight-line, over the estimated useful lives of the related assets. Capitalized interest was \$91 and \$97 million in 2019 and 2018, respectively.

We review long-lived assets for impairment when circumstances indicate the carrying amount of an asset may not be recoverable based on its undiscounted future cash flows. If the carrying amount of the asset is determined not to be recoverable, a write-down to fair value is recorded. Fair values are determined based on quoted market values, discounted cash flows or external appraisals, as appropriate. We review long-lived assets for impairment at the individual asset or the asset group level for which the lowest level of independent cash flows can be identified.

Leased Assets

For a discussion of our accounting policies related to leased assets, refer to note 10.

Goodwill and Intangible Assets

Costs of purchased businesses in excess of net identifiable assets acquired (goodwill), and indefinite-lived intangible assets are tested for impairment at least annually, unless changes in circumstances indicate an impairment may have occurred sooner. We are required to test goodwill on a reporting unit basis. A reporting unit is the operating segment unless, for businesses within that operating segment, discrete financial information is prepared and regularly reviewed by management, in which case such a component business is the reporting unit.

In assessing goodwill for impairment, we initially evaluate qualitative factors to determine if it is more likely than not that the fair value of a reporting unit is less than its carrying amount. We consider several factors, including macroeconomic conditions, industry and market conditions, overall financial performance of the reporting unit, changes in management, strategy or customers and relevant reporting unit-specific events such as a change in the carrying amount of net assets, a more likely than not expectation of selling or disposing of all, or a portion of, a reporting unit, and the testing for recoverability of a significant asset group within a reporting unit. If this qualitative assessment results in a conclusion that it is more likely than not that the fair value of a reporting unit exceeds the carrying value, then no further testing is performed for that reporting unit.

If the qualitative assessment is not conclusive and it is necessary to calculate the fair value of a reporting unit, then we utilize a two-step process to test goodwill for impairment. First, a comparison of the fair value of the applicable reporting unit with the aggregate carrying value, including goodwill, is performed. If the carrying amount of a reporting unit exceeds its calculated fair value, then the second step is performed, and an impairment charge is recognized for the amount, if any, by which the carrying amount of goodwill exceeds its implied fair value. We primarily determine the fair value of our reporting units using a discounted cash flow model and supplement this with observable valuation multiples for comparable companies, as appropriate.

A trade name with a carrying value of \$200 million and licenses with a carrying value of \$4 million as of December 31, 2019 are considered to be indefinite-lived intangibles, and therefore are not amortized. Indefinite-lived intangible assets are reviewed for impairment at least annually. We determined that the income approach, specifically the relief from royalty method, is the most appropriate valuation method to estimate the fair value of the trade name. The estimated fair value of the trade name is compared to the carrying value of the asset. If the carrying value of the trade name exceeds its estimated fair value, an impairment charge is recognized for the amount by which the carrying amount of the asset exceeds its fair value.

Finite-lived intangible assets, including trademarks, licenses, patents, customer lists, non-compete agreements and franchise rights are amortized on a straight-line basis over the estimated useful lives of the assets, which range from 2 to 22 years. Capitalized software is generally amortized over 7 years.

Self-Insurance Accruals

We self-insure costs associated with workers' compensation claims, automobile liability, health and welfare and general business liabilities, up to certain limits. Insurance reserves are established for estimates of the loss that we will ultimately incur on reported claims, as well as estimates of claims that have been incurred but not yet reported. The expected ultimate cost for claims incurred is estimated based upon historical loss experience and judgments about the present and expected levels of cost per claim. Trends in actual experience are a significant factor in the determination of our reserves.

Workers' compensation, automobile liability and general liability insurance claims may take several years to completely settle. Consequently, actuarial estimates are required to project the ultimate cost that will be incurred to fully resolve a claim. A number of factors can affect the actual cost of a claim, including the length of time the claim remains open, trends in healthcare costs, the results of any related litigation and with respect to workers' compensation claims, changes in legislation. Furthermore, claims may emerge in a future year for events that occurred in a prior year at a rate that differs from actuarial projections. All of these factors can result in revisions to actuarial projections and produce a material difference between estimated and actual operating results. Based on our historical experience, during 2019 we changed our self-insurance reserves from the central estimate to the low end of the actuarial range of losses. The principal result of this change was a decrease in expense of \$94 million and an increase in net income of \$72 million, or \$0.08 per share on a basic and diluted basis. We believe our estimated reserves for such claims are adequate, but actual experience in claim frequency and/or severity could materially differ from our estimates and affect our results of operations.

We sponsor a number of health and welfare insurance plans for our employees. These liabilities and related expenses are based on estimates of the number of employees and eligible dependents covered under the plans, anticipated medical usage by participants and overall trends in medical costs and inflation.

Pension and Postretirement Benefits

We incur certain employment-related expenses associated with pension and postretirement medical benefits. These pension and postretirement medical benefit costs for company-sponsored benefit plans are calculated using various actuarial assumptions and methodologies, including discount rates, expected returns on plan assets, healthcare cost trend rates, inflation, compensation increase rates, mortality rates and coordination of benefits with plans not sponsored by UPS. Actuarial assumptions are reviewed on an annual basis, unless circumstances require an interim remeasurement of any of our plans.

We recognize changes in the fair value of plan assets and net actuarial gains or losses in excess of a corridor (defined as 10% of the greater of the fair value of plan assets or the plan's projected benefit obligation) in net periodic benefit cost other than service cost annually at December 31st each year. The remaining components of pension expense, primarily service and interest costs and the expected return on plan assets, are recorded on a quarterly basis.

For eligible employees hired after July 1, 2016, UPS contributes annually to a defined contribution plan. We recognize expense for the required contribution quarterly, and we recognize a liability for any contributions due and unpaid (included in "Other current liabilities").

During June 2017, we amended the UPS Retirement Plan and Excess Coordinating Plan to cease accrual of additional benefits for future service for non-union participants effective January 1, 2023. We remeasured plan assets and pension benefit obligations for the affected pension plans as of June 30, 2017 to recognize the impact of this change.

We participate in a number of trustee-managed multiemployer pension and health and welfare plans for employees covered under collective bargaining agreements. Our contributions to these plans are determined in accordance with the respective collective bargaining agreements. We recognize expense for the contractually required contribution for each period, and we recognize a liability for any contributions due and unpaid within "Other current liabilities".

Income Taxes

Income taxes are accounted for on an asset and liability approach that requires the recognition of deferred tax assets and liabilities for the expected future tax consequences of events that have been recognized in our consolidated financial statements or tax returns. In estimating future tax consequences, we generally consider all expected future events other than proposed changes in the tax law or rates. Valuation allowances are provided if it is more likely than not that a deferred tax asset will not be realized.

We recognize liabilities for uncertain tax positions based on a two-step process. The first step is to evaluate the tax position for recognition by determining if the weight of available evidence indicates that it is more likely than not that the position will be sustained on audit, including resolution of related appeals or litigation processes, if any. Once it is determined that the position meets the recognition threshold, the second step requires us to estimate and measure the largest amount of tax benefit that is more likely than not to be realized upon ultimate settlement. The difference between the amount of recognizable tax benefit and the total amount of tax benefit from positions filed or to be filed with the tax authorities is recorded as a liability for uncertain tax benefits. It is inherently difficult and subjective to estimate such amounts, as we have to determine the probability of various possible outcomes. We reevaluate uncertain tax positions on a quarterly basis. This evaluation is based on factors including, but not limited to, changes in facts or circumstances, changes in tax law, effectively settled issues under audit and new audit activity. Such a change in recognition or measurement could result in the recognition of a tax benefit or an additional charge to the tax provision.

In January 2018, the Financial Accounting Standards Board ("FASB") released guidance on the accounting for tax on the Global Intangible Low-Taxed Income ("GILTI") provisions of the Tax Cuts and Jobs Act (the "Tax Act"). The GILTI provisions impose U.S. tax on certain foreign income in excess of a deemed return on tangible assets of foreign corporations. The guidance indicates that either accounting for deferred taxes related to GILTI inclusions or treating any taxes on GILTI inclusions as period costs are both acceptable methods subject to an accounting policy election. We elect to treat any potential GILTI inclusions as period costs.

Foreign Currency Translation and Remeasurement

We translate the results of operations of our foreign subsidiaries using average exchange rates during each period, whereas balance sheet accounts are translated using exchange rates at the end of each period. Balance sheet currency translation adjustments are recorded in AOCI. Pre-tax foreign currency transaction gains (losses) from remeasurement, net of hedging, included in investment income (expense) and other were \$(6), \$(19) and \$3 million in 2019, 2018 and 2017, respectively.

Stock-Based Compensation

All share-based awards to employees are measured based on their fair values and expensed over the period during which an employee is required to provide service in exchange for the award (the vesting period), less estimated forfeitures. We have issued employee share-based awards under the UPS Incentive Compensation Plan that are subject to specific vesting conditions, including service conditions, where the awards cliff vest or vest ratably over a one, three, or five year period (the "nominal vesting period") or at the date the employee retires (as defined by the plan), if earlier. Compensation cost is generally recognized immediately for awards granted to retirement-eligible employees, or over the period from the grant date to the date retirement eligibility is achieved, if that is expected to occur during the nominal vesting period. We estimate forfeiture rates based on historical rates of forfeitures for awards with similar characteristics, historical rates of employee turnover and the nature and terms of the vesting conditions of the awards. We reevaluate our forfeiture rates on an annual basis.

Fair Value Measurements

Our financial assets and liabilities measured at fair value on a recurring basis have been categorized based upon a fair value hierarchy. Level 1 inputs utilize quoted prices in active markets for identical assets or liabilities. Level 2 inputs are based on other observable market data, such as quoted prices for similar assets and liabilities, and inputs other than quoted prices that are observable, such as interest rates and yield curves. Level 3 inputs are developed from unobservable data reflecting our own assumptions, and include situations where there is little or no market activity for the asset or liability.

Certain non-financial assets and liabilities are measured at fair value on a nonrecurring basis, including property, plant, and equipment, goodwill and intangible assets. These assets are subject to fair value adjustments in certain circumstances, such as when there is evidence of an impairment. A general description of the valuation methodologies used for assets and liabilities measured at fair value, including the general classification of such assets and liabilities pursuant to the valuation hierarchy, is included in each footnote with fair value measurements present.

For acquisitions, we allocate the fair value of purchase consideration to the tangible assets acquired, liabilities assumed and intangible assets acquired based on their estimated fair values. The excess of the fair value of purchase consideration over the fair values of these identifiable assets and liabilities is recorded as goodwill. Such valuations require management to make significant estimates and assumptions, especially with respect to intangible assets, including but are not limited to, future expected cash flows from acquired customers, acquired technology and trade names from a market participant perspective, useful lives and discount rates. Management's estimates of fair value are based upon assumptions believed to be reasonable, but which are inherently uncertain and unpredictable and, as a result, actual results may differ from estimates. During the measurement period, which is one year from the acquisition date, we may record adjustments to the assets acquired and liabilities assumed, with the corresponding offset to goodwill. Upon the conclusion of the measurement period, any subsequent adjustments are recorded to earnings.

Derivative Instruments

We recognize all derivative instruments as assets or liabilities in the consolidated balance sheets at fair value. The accounting for changes in the fair value of a derivative instrument depends on whether it has been designated and qualifies as part of a hedging relationship and, further, on the type of hedging relationship. For those derivative instruments that are designated and qualify as hedging instruments, a company must designate the derivative, based upon the exposure being hedged, as a cash flow hedge, a fair value hedge or a hedge of a net investment in a foreign operation.

A cash flow hedge refers to hedging the exposure to variability in expected future cash flows that is attributable to a particular risk. For derivative instruments that are designated and qualify as cash flow hedges, the gain or loss on the derivative instrument is reported as a component of AOCI, and reclassified into earnings in the same period during which the hedged transaction affects earnings.

A fair value hedge refers to hedging the exposure to changes in the fair value of an existing asset or liability in the consolidated balance sheets that is attributable to a particular risk. For derivative instruments that are designated and qualify as fair value hedges, the gain or loss on the derivative instrument is recognized in the statements of consolidated income during the current period, as well as the offsetting gain or loss on the hedged item.

A net investment hedge refers to the use of cross currency swaps, forward contracts or foreign currency denominated debt to hedge portions of net investments in foreign operations. For hedges that meet the hedge accounting requirements, the net gains or losses attributable to changes in spot exchange rates are recorded in the foreign currency translation adjustment within AOCI, and are recorded in the income statement when the hedged item affects earnings.

Adoption of New Accounting Standards

In May 2014, the FASB issued an accounting standards update ("ASU") that changes the revenue recognition for companies that enter into contracts with customers to transfer goods or services ("*Revenue from Contracts with Customers*"). The standard is a comprehensive new revenue recognition model that requires revenue to be recognized in a manner depicting the transfer of goods or services to a customer at an amount that reflects the consideration expected to be received in exchange for those goods or services. The FASB also issued a number of updates to this standard. Effective January 1, 2018, we adopted the requirements of this ASU using the full retrospective method. See note 2 for disclosures required by this ASU.

In January 2016, the FASB issued an ASU which addresses certain aspects of the recognition, measurement, presentation and disclosure of financial instruments. We adopted this standard on January 1, 2018. The adoption of this ASU did not have a material impact on our consolidated financial position, results of operations or cash flows.

In February 2016, the FASB issued ASU 2016-02, Leases (Topic 842), which requires lessees to recognize a right-of-use asset and lease liability on their balance sheet for all leases with terms beyond twelve months. The new standard also requires enhanced disclosures that provide more transparency and information to financial statement users about lease portfolios. Effective January 1, 2019, we adopted the requirements of this ASU using the modified retrospective approach. We elected the transition package of practical expedients permitted within the standard. As a result, we did not reassess initial direct costs, lease classification, or whether our contracts contain or are leases. We also made an accounting policy election to not recognize right-of-use assets and liabilities for leases with an original lease term of twelve months or less, unless the leases include options to renew or purchase the underlying asset that are reasonably certain to be exercised.

The adoption on January 1, 2019 resulted in the recognition of right-of-use assets for operating leases of approximately \$2.65 billion and operating lease liabilities of approximately \$2.70 billion. The consolidated financial statements for the year ended December 31, 2019 are presented under the new standard, while comparative periods presented have not been adjusted and continue to be reported in accordance with the previous standard. See note 10 for additional disclosures required by this ASU.

In August 2016, the FASB issued an ASU that addressed the classification and presentation of specific cash flow matters. The guidance also clarified how the predominance principle should be applied when cash receipts and cash payments have aspects of more than one class of cash flows. The guidance was applied retrospectively. We adopted this standard on January 1, 2018. This standard did not have a material impact on our statements of consolidated cash flows.

In November 2016, the FASB issued an ASU intended to reduce diversity in practice by adding or clarifying guidance on classification and presentation of changes in restricted cash on the statement of cash flows ("*Restricted Cash*"). Effective January 1, 2018, we adopted the requirements of this ASU retrospectively. As a result of this update, restricted cash is included within cash and cash equivalents on our statements of consolidated cash flows.

In March 2017, the FASB issued an ASU to improve the presentation of net periodic pension cost and net periodic postretirement benefit cost ("*Improving the Presentation of Net Periodic Pension Cost and Net Periodic Postretirement Benefit Cost*"). The update requires employers to report the current service cost component in the same line item as other compensation costs arising from services rendered by employees during the period. The other components of net periodic benefit cost are required to be presented separately from service cost and outside of income from operations. Effective January 1, 2018, we adopted the requirements of this ASU retrospectively, as required. As a result of this update, the net amount of interest cost, prior service cost and expected return on plan assets is now presented as other income.

In March 2017, the FASB issued an ASU requiring the premium on callable debt securities to be amortized to the earliest call date. We adopted this standard on January 1, 2019. It did not have a material impact on our consolidated financial position, results of operations or cash flows.

In May 2017, the FASB issued an ASU to provide clarity and reduce complexity on when to apply modification accounting to existing share-based payment awards. We adopted this standard on January 1, 2018. This ASU did not have a material impact on our consolidated financial position, results of operations or cash flows.

In August 2017, the FASB issued an ASU to enhance recognition of the economic results of hedging activities in the financial statements. In addition, the update made certain targeted improvements to simplify the application of hedge accounting guidance and increase transparency regarding the scope and results of hedging activities. We adopted this standard on January 1, 2019. It did not have a material impact on our consolidated financial position, results of operations or cash flows but did require additional disclosures. See note 16 for disclosures required by this ASU.

In February 2018, the FASB issued an ASU that allows a reclassification from AOCI to retained earnings for stranded tax effects resulting from the Tax Act. Effective January 1, 2018, we early adopted this ASU and elected to reclassify the income tax effects of the Tax Act from AOCI to retained earnings. This resulted in a \$735 million increase to retained earnings and a \$735 million decrease to AOCI. Our current accounting policy for releasing income tax effects from other comprehensive income is based on a portfolio approach.

In August 2018, the FASB issued an ASU that modifies the disclosure requirements for employers that sponsor defined benefit pension and postretirement plans. The update eliminates the disclosures for amounts in AOCI expected to be recognized as components of net periodic cost over the next fiscal year and the effects of a one percentage point change in the assumed healthcare cost trend rate. The update adds disclosure requirements to include the weighted-average interest crediting rates for cash balance plans and a narrative description of the significant gains and losses related to changes in the benefit obligation for the period. We early adopted this standard for the year ended December 31, 2018 with retrospective application. The adoption of this ASU did not have a material impact on our consolidated financial position, results of operations or cash flows.

We have recast our consolidated financial statements from amounts previously reported due to the adoption of new revenue recognition, pension and restricted cash standards. The unaudited consolidated statements of operations, which reflect the adoption of the new ASUs, are as follows (in millions):

	Twelve months ended December 31, 2017				
	As Previously Reported	Adjustments (a)	Adjustments (b)	Adjustments (c)	As Recast
Revenue	\$ 65,872	\$ 713	\$ —	\$ —	\$ 66,585
Operating Expenses:					
Compensation and benefits	34,588	—	(11)	—	34,577
Repairs and maintenance	1,600	1	—	—	1,601
Depreciation and amortization	2,282	—	—	—	2,282
Purchased transportation	10,989	707	—	—	11,696
Fuel	2,690	—	—	—	2,690
Other occupancy	1,155	—	—	—	1,155
Other expenses	5,039	16	—	—	5,055
Total Operating Expenses	58,343	724	(11)	—	59,056
Operating Profit	7,529	(11)	11	—	7,529
Other Income and (Expense):					
Investment income (expense) and other	72	—	(11)	—	61
Interest expense	(453)	—	—	—	(453)
Total Other Income and (Expense)	(381)	—	(11)	—	(392)
Income Before Income Taxes	7,148	(11)	—	—	7,137
Income Tax Expense (Benefit)	2,238	(6)	—	—	2,232
Net Income	\$ 4,910	\$ (5)	\$ —	\$ —	\$ 4,905
Basic Earnings Per Share	\$ 5.64	\$ (0.01)	\$ —	\$ —	\$ 5.63
Diluted Earnings Per Share	\$ 5.61	\$ —	\$ —	\$ —	\$ 5.61

(a) Recast to reflect the adoption of *Revenue from Contracts with Customers*.

(b) Recast to reflect the adoption of *Improving the Presentation of Net Periodic Pension Cost and Net Periodic Postretirement Benefit Cost*.

(c) Recast to reflect the adoption of *Restricted Cash*.

The unaudited impacted consolidated statement of cash flows line items, which reflect the adoption of the new ASUs, are as follows (in millions):

	Twelve Months Ended December 31, 2017				
	As Previously Reported	Adjustments (a)	Adjustments (b)	Adjustments (c)	As Recast
Net Income	\$ 4,910	\$ (5)	\$ —	\$ —	\$ 4,905
Adjustments to reconcile net income to net cash from operating activities:					
Deferred tax (benefit) expense	1,230	(6)	—	—	1,224
Other assets	(982)	(2)	—	—	(984)
Accounts payable	592	7	—	—	599
Accrued wages and withholdings	193	7	—	—	200
Other liabilities	(241)	(2)	—	—	(243)
Other operating activities	47	1			48
Cash flows from operating activities	1,479	—	—	—	1,479
Purchase of marketable securities	(1,634)	—	—	4	(1,630)
Net cash used in investing activities	(4,975)	—	—	4	(4,971)
Net decrease in cash, cash equivalents and restricted cash	(156)	—	—	4	(152)
Cash, cash equivalents and restricted cash at the beginning of period	3,476	—	—	445	3,921
Cash, cash equivalents and restricted cash at the end of period	\$ 3,320	\$ —	\$ —	\$ 449	\$ 3,769

(a) Recast to reflect the adoption of *Revenue from Contracts with Customers*.

(b) Recast to reflect the adoption of *Improving the Presentation of Net Periodic Pension Cost and Net Periodic Postretirement Benefit Cost*.

(c) Recast to reflect the adoption of *Restricted Cash*.

Other accounting pronouncements adopted during the periods covered by the consolidated financial statements did not have a material impact on our consolidated financial position, results of operations or cash flows.

Accounting Standards Issued But Not Yet Effective

In June 2016, the FASB issued an ASU introducing an expected credit loss methodology for the measurement of financial assets not accounted for at fair value. The methodology replaces the probable, incurred loss model for those assets. The standard will be effective for us in the first quarter of 2020. We are substantially complete with our evaluation of the adoption on our consolidated financial statements and internal controls over financial reporting. This adoption will not have a material impact on our consolidated financial position, results of operations or cash flows. We will update our process for calculating our allowance for doubtful accounts to include reasonable and supportable forecasts that could affect expected collectability.

In January 2017, the FASB issued an ASU to simplify the accounting for goodwill impairment. The update removes Step 2 of the goodwill impairment test, which requires a hypothetical purchase price allocation. Under this ASU, goodwill impairment will be the amount by which a reporting unit's carrying value exceeds its fair value, not to exceed the carrying amount of goodwill. The standard will be effective for us in the first quarter of 2020. We do not expect this ASU to have a material impact on our consolidated financial position, results of operations or cash flows.

In December 2019, the FASB issued an ASU to simplify the accounting for income taxes. The update removes certain exceptions to the general income tax principles. The standard will be effective for us in the first quarter of 2021. We are evaluating the impact of its adoption on our consolidated financial statements and internal control over financial reporting environment, but do not expect this ASU to have a material impact on our consolidated financial position, results of operations or cash flows.

Other accounting pronouncements issued, but not effective until after December 31, 2019, are not expected to have a material impact on our consolidated financial position, results of operations or cash flows.

NOTE 2. REVENUE RECOGNITION*Revenue Recognition*

Substantially all of our revenues are from contracts associated with the pick-up, transportation and delivery of packages and freight (“transportation services”), whether carried out or arranged by UPS, either domestically or internationally, which generally occurs over a short period of time. Additionally, we provide value-added logistics services to customers, both domestically and internationally, through our global network of company-owned and leased distribution centers and field stocking locations.

Disaggregation of Revenue

	Year Ended December 31,		
	2019	2018	2017
Revenue:			
Next Day Air	\$ 8,479	\$ 7,618	\$ 7,088
Deferred	5,180	4,752	4,422
Ground	32,834	31,223	29,251
U.S. Domestic Package	\$ 46,493	\$ 43,593	\$ 40,761
Domestic	\$ 2,836	\$ 2,874	\$ 2,646
Export	10,837	10,973	10,170
Cargo & Other	547	595	526
International Package	\$ 14,220	\$ 14,442	\$ 13,342
Forwarding	\$ 5,867	\$ 6,580	\$ 5,674
Logistics	3,435	3,234	3,017
Freight	3,265	3,218	3,000
Other	814	794	791
Supply Chain & Freight	\$ 13,381	\$ 13,826	\$ 12,482
Consolidated revenue	<u>\$ 74,094</u>	<u>\$ 71,861</u>	<u>\$ 66,585</u>

We account for a contract when both parties have approved the contract and are committed to perform their obligations, the rights of the parties are identified, payment terms are identified, the contract has commercial substance and collectability of consideration is probable.

Performance Obligations

A performance obligation is a promise in a contract to transfer a distinct good or service to the customer, and is the basis of revenue recognition in accordance with GAAP. To determine the proper revenue recognition method for contracts, we evaluate whether two or more contracts should be combined and accounted for as a single contract, and whether the combined or single contract should be accounted for as more than one performance obligation. This evaluation requires judgment, and the decision to combine a group of contracts or to separate the combined or single contract into multiple performance obligations could change the amount of revenue and profit recorded in a given period. Within most of our contracts, the customer contracts with us to provide distinct services, such as transportation services. The vast majority of our contracts with customers for transportation services include only one performance obligation; the transportation services themselves. However, if a contract is separated into more than one performance obligation, we allocate the total transaction price to each performance obligation based on the estimated relative standalone selling prices of the promised goods or services underlying each performance obligation. We frequently sell standard transportation services with observable standalone sales prices. In these instances, the observable standalone sales are used to determine the standalone selling price.

In certain business units, such as Logistics, we sell customized, customer-specific solutions in which we provide a significant service of integrating a complex set of tasks and components into a single capability (even if that single capability results in the delivery of multiple units). Hence, the entire contract is accounted for as one performance obligation. In these cases we typically use the expected cost plus a margin approach to estimate the standalone selling price of each performance obligation.

Satisfaction of Performance Obligations

We generally recognize revenue over time as we perform the services in the contract because of the continuous transfer of control to the customer. Our customers receive the benefit of our services as the goods are transported from one location to another. Further, if we were unable to complete delivery to the final location, another entity would not need to reperform the transportation service already performed.

As control transfers over time, revenue is recognized based on the extent of progress towards completion of the performance obligation. The selection of the method to measure progress towards completion requires judgment and is based on the nature of the products or services to be provided. We use the cost-to-cost measure of progress for our package delivery contracts because it best depicts the transfer of control to the customer which occurs as we incur costs on our contracts. Under the cost-to-cost measure of progress, the extent of progress towards completion is measured based on the ratio of costs incurred to date to the total estimated costs at completion of the performance obligation. Revenues, including ancillary or accessorial fees and reductions for estimated customer incentives, are recorded proportionally as costs are incurred. Costs to fulfill include labor and other direct costs and an allocation of indirect costs. For our freight and freight forwarding contracts, an output method of progress based on time-in-transit is utilized as the timing of costs incurred does not best depict the transfer of control to the customer. In our Logistics business we have a right to consideration from customers in an amount that corresponds directly with the value to the customers of our performance completed to date, and as such we recognize revenue in the amount to which we have a right to invoice the customer.

Variable Consideration

It is common for our contracts to contain customer incentives, guaranteed service refunds or other provisions that can either increase or decrease the transaction price. These variable amounts are generally dependent upon achievement of certain incentive tiers or performance metrics. We estimate variable consideration at the most likely amount to which we expect to be entitled. We include estimated amounts of revenue, which may be reduced by incentives or other contract provisions, in the transaction price to the extent it is probable that a significant reversal of cumulative revenue recognized will not occur when the uncertainty associated with the variable consideration is resolved. Our estimates of variable consideration and determination of whether to include estimated amounts in the transaction price are based on an assessment of anticipated customer spending and all information (historical, current and forecasted) that is reasonably available to us.

Contract Modifications

Contracts are often modified to account for changes in the rates we charge our customers or to add additional distinct services. We consider contract modifications to exist when the modification either creates new, or changes the existing, enforceable rights and obligations. Contract modifications that add additional distinct goods or services are treated as separate contracts. Contract modifications that do not add distinct goods or services typically change the price of existing services. These contract modifications are accounted for prospectively as the remaining performance obligations are distinct.

Payment Terms

Under the typical payment terms of our customer contracts, the customer pays at periodic intervals (i.e. every 14 days, 30 days, 45 days, etc.) for shipments included on invoices received. Invoices are generated each week on the week-ending day, which is Saturday for the majority of our U.S. Domestic Package business, but could be another day depending on the business unit or the specific agreement with the customer. It is not customary business practice to extend payment terms past 90 days, and as such, we do not have a practice of including a significant financing component within our contracts with customers.

Principal vs. Agent Considerations

In our transportation businesses, we utilize independent contractors and third-party carriers in the performance of some transportation services. GAAP requires us to evaluate, using a control model, whether our businesses themselves promise to transfer services to the customer (as the principal) or to arrange for services to be provided by another party (as the agent). Based on our evaluation of the control model, we determined that all of our major businesses act as the principal rather than the agent within their revenue arrangements. Revenue and the associated purchased transportation costs are both reported on a gross basis within our statements of consolidated income.

Accounts Receivable, Net

Accounts receivable, net, include amounts billed and currently due from customers. The amounts due are stated at their net estimated realizable value. Losses on accounts receivable are recognized when they are incurred, which requires us to make our best estimate of the probable losses inherent in our customer receivables at each balance sheet date. These estimates require consideration of historical loss experience, adjusted for current conditions, trends in customer payment frequency, and judgments about the probable effects of relevant observable data, including present economic conditions and the financial health of specific customers and market sectors. Our risk management process includes standards and policies for reviewing major account exposures and concentrations of risk.

Our total allowance for doubtful accounts as of December 31, 2019 and 2018 was \$93 and \$94 million, respectively. Our total provision for doubtful accounts charged to expense before recoveries during the years ended December 31, 2019 and 2018 was \$194 and \$118 million, respectively.

Contract Assets and Liabilities

Contract assets include billed and unbilled amounts resulting from in-transit packages, as we have an unconditional right to payment only once all performance obligations have been completed (i.e. packages have been delivered), and our right to payment is not solely based on the passage of time. Amounts may not exceed their net realizable value. Contract assets are generally classified as current and the full balance is converted each quarter based on the short-term nature of the transactions.

Contract liabilities consist of advance payments and billings in excess of revenue as well as deferred revenue. Advance payments and billings in excess of revenue represent payments received from our customers that will be earned over the contract term. Deferred revenue represents the amount of consideration due from customers related to in-transit shipments that has not yet been recognized as revenue based on our selected measure of progress. We classify advance payments and billings in excess of revenue as either current or long-term, depending on the period over which the advance payment will be earned. We classify deferred revenue as current based on the timing of when we expect to recognize revenue, which typically occurs within a short window after period-end. The full balance of deferred revenue is converted each quarter based on the short-term nature of the transactions. Our contract assets and liabilities are reported in a net position on a contract-by-contract basis at the end of each reporting period. In order to determine revenue recognized in the period from contract liabilities, we first allocate revenue to the individual contract liability balance outstanding at the beginning of the period until the revenue exceeds that deferred revenue balance.

Contract assets related to in-transit packages were \$272 and \$234 million at December 31, 2019 and 2018, respectively, net of deferred revenue related to in-transit packages of \$264 and \$236 million at December 31, 2019 and 2018, respectively. Contract assets are included within "Other current assets" in the consolidated balance sheets. Short-term contract liabilities related to advanced payments from customers were \$7 and \$5 million at December 31, 2019 and 2018, respectively. Short-term contract liabilities are included within "Other current liabilities" in the consolidated balance sheets. Long-term contract liabilities related to advanced payments from customers were \$26 million at December 31, 2019 and December 31, 2018. Long-term contract liabilities are included within "Other Non-Current Liabilities" in the consolidated balance sheets.

NOTE 3. INVESTMENTS AND RESTRICTED CASH

The following is a summary of marketable securities classified as trading and available-for-sale at December 31, 2019 and 2018 (in millions):

	<u>Cost</u>	<u>Unrealized Gains</u>	<u>Unrealized Losses</u>	<u>Estimated Fair Value</u>
2019				
Current trading marketable securities:				
Corporate debt securities	\$ 112	\$ —	\$ —	\$ 112
Equity securities	2	—	—	2
Total trading marketable securities	<u>114</u>	<u>—</u>	<u>—</u>	<u>114</u>
Current available-for-sale securities:				
U.S. government and agency debt securities	191	2	—	193
Mortgage and asset-backed debt securities	46	1	—	47
Corporate debt securities	130	3	—	133
Non-U.S. government debt securities	16	—	—	16
Total available-for-sale marketable securities	<u>383</u>	<u>6</u>	<u>—</u>	<u>389</u>
Total current marketable securities	<u>\$ 497</u>	<u>\$ 6</u>	<u>\$ —</u>	<u>\$ 503</u>
	<u>Cost</u>	<u>Unrealized Gains</u>	<u>Unrealized Losses</u>	<u>Estimated Fair Value</u>
2018				
Current trading marketable securities:				
Corporate debt securities	\$ 137	\$ —	\$ —	\$ 137
Equity securities	2	—	—	2
Total trading marketable securities	<u>139</u>	<u>—</u>	<u>—</u>	<u>139</u>
Current available-for-sale securities:				
U.S. government and agency debt securities	297	1	(1)	297
Mortgage and asset-backed debt securities	82	—	(1)	81
Corporate debt securities	275	—	(2)	273
Non-U.S. government debt securities	20	—	—	20
Total available-for-sale marketable securities	<u>674</u>	<u>1</u>	<u>(4)</u>	<u>671</u>
Total current marketable securities	<u>\$ 813</u>	<u>\$ 1</u>	<u>\$ (4)</u>	<u>\$ 810</u>

Total current marketable securities that were pledged as collateral for our self-insurance requirements had an estimated fair value of \$389 and \$587 million at December 31, 2019 and 2018, respectively.

The gross realized gains on sales of available-for-sale securities totaled \$8 million in 2019. There were no gross realized gains on sales of available-for-sale securities in 2018 or 2017. The gross realized losses on sales of available-for-sale securities totaled \$2, \$4 and \$2 million in 2019, 2018 and 2017, respectively.

There were no material impairment losses recognized on marketable securities during 2019, 2018 or 2017.

Investment Other-Than-Temporary Impairments

We have concluded that no material other-than-temporary impairment losses existed as of December 31, 2019. In making this determination, we considered the financial condition and prospects of each issuer, the magnitude of the losses compared with the investments' cost, the probability that we will be unable to collect all amounts due according to the contractual terms of the security, the credit rating of the security and our ability and intent to hold these investments until the anticipated recovery in market value occurs.

Unrealized Losses

The following table presents the age of gross unrealized losses and fair value by investment category for all securities in a loss position as of December 31, 2019 (in millions):

	Less Than 12 Months		12 Months or More		Total	
	Fair Value	Unrealized Losses	Fair Value	Unrealized Losses	Fair Value	Unrealized Losses
U.S. government and agency debt securities	\$ 42	\$ —	\$ —	\$ —	\$ 42	\$ —
Mortgage and asset-backed debt securities	3	—	5	—	8	—
Corporate debt securities	6	—	2	—	8	—
Non-U.S. government debt securities	9	—	2	—	11	—
Total marketable securities	\$ 60	\$ —	\$ 9	\$ —	\$ 69	\$ —

The unrealized losses for the corporate debt securities, mortgage and asset-backed debt securities, and U.S. government and agency debt securities are primarily due to changes in market interest rates. We have both the intent and ability to hold these securities for a time necessary to recover the cost basis.

Maturity Information

The amortized cost and estimated fair value of marketable securities at December 31, 2019, by contractual maturity, are shown below (in millions). Actual maturities may differ from contractual maturities because the issuers of the securities may have the right to prepay obligations with or without prepayment penalties.

	Cost	Estimated Fair Value
Due in one year or less	\$ 118	\$ 118
Due after one year through three years	328	332
Due after three years through five years	6	6
Due after five years	43	45
	495	501
Equity securities	2	2
	\$ 497	\$ 503

Non-Current Investments and Restricted Cash

Non-current investments and restricted cash are primarily associated with our self-insurance obligations. We entered into an escrow agreement with an insurance carrier to guarantee these obligations. This agreement requires us to provide collateral to the insurance carrier, which is invested in various marketable securities and cash equivalents. Collateral provided is reflected in "Cash, Cash Equivalents and Restricted Cash" in the statements of consolidated cash flows. In 2019 we liquidated our investment balance associated with this agreement and pledged the required collateral with a surety bond. At December 31, 2019 and 2018, we had \$0 and \$142 million, respectively, in restricted cash. For additional information on surety bonds written at December 31, 2019, see note 8.

We held a \$21 and \$19 million investment in a variable life insurance policy to fund benefits for the UPS Excess Coordinating Benefit Plan at December 31, 2019 and 2018, respectively. The quarterly change in investment fair value is recognized in "Investment income (expense) and other" in the statements of consolidated income. Additionally, we held escrowed cash related to the acquisition and disposition of certain assets of \$3 and \$9 million at December 31, 2019 and 2018, respectively. These amounts are classified as "Investments and Restricted Cash" in the consolidated balance sheets.

A reconciliation of cash and cash equivalents and restricted cash from the consolidated balance sheets to the statements of consolidated cash flows is shown below (in millions):

	December 31, 2019	December 31, 2018	December 31, 2017
Cash and cash equivalents	\$ 5,238	\$ 4,225	\$ 3,320
Restricted cash	\$ —	\$ 142	\$ 449
Total cash, cash equivalents and restricted cash	<u>\$ 5,238</u>	<u>\$ 4,367</u>	<u>\$ 3,769</u>

Fair Value Measurements

Marketable securities valued utilizing Level 1 inputs include active exchange-traded equity securities and equity index funds, and most U.S. government debt securities, as these securities all have quoted prices in active markets. Marketable securities valued utilizing Level 2 inputs include asset-backed securities, corporate bonds and municipal bonds. These securities are valued using market corroborated pricing, matrix pricing or other models that utilize observable inputs such as yield curves.

We maintain holdings in certain investment partnerships that are measured at fair value utilizing Level 3 inputs (classified as "Other non-current investments" in the tables below, and as "Other Non-Current Assets" in the consolidated balance sheets). These partnership holdings do not have quoted prices, nor can they be valued using inputs based on observable market data. These investments are valued internally using a discounted cash flow model with two significant inputs: (1) the after-tax cash flow projections for each partnership, and (2) a risk-adjusted discount rate consistent with the duration of the expected cash flows for each partnership. The weighted-average discount rates used to value these investments were 7.40% and 8.16% as of December 31, 2019 and 2018, respectively. These inputs, and the resulting fair values, are updated on a quarterly basis.

The following table presents information about our investments measured at fair value on a recurring basis as of December 31, 2019 and 2018, and indicates the fair value hierarchy of the valuation techniques utilized to determine such fair value (in millions):

	Quoted Prices in Active Markets for Identical Assets (Level 1)	Significant Other Observable Inputs (Level 2)	Significant Unobservable Inputs (Level 3)	Total
2019				
Marketable Securities:				
U.S. government and agency debt securities	\$ 193	\$ —	\$ —	\$ 193
Mortgage and asset-backed debt securities	—	47	—	47
Corporate debt securities	—	245	—	245
Equity securities	—	2	—	2
Non-U.S. government debt securities	—	16	—	16
Total marketable securities	193	310	—	503
Other non-current investments	21	—	1	22
Total	\$ 214	\$ 310	\$ 1	\$ 525

	Quoted Prices in Active Markets for Identical Assets (Level 1)	Significant Other Observable Inputs (Level 2)	Significant Unobservable Inputs (Level 3)	Total
2018				
Marketable Securities:				
U.S. government and agency debt securities	\$ 297	\$ —	\$ —	\$ 297
Mortgage and asset-backed debt securities	—	81	—	81
Corporate debt securities	—	410	—	410
Equity securities	—	2	—	2
Non-U.S. government debt securities	—	20	—	20
Total marketable securities	297	513	—	810
Other non-current investments	19	—	2	21
Total	\$ 316	\$ 513	\$ 2	\$ 831

There were no transfers of investments between Level 1 and Level 2 during the years ended December 31, 2019 or 2018.

NOTE 4. PROPERTY, PLANT AND EQUIPMENT

Property, plant and equipment, including both owned assets as well as assets subject to finance leases, consists of the following as of December 31, 2019 and 2018 (in millions):

	<u>2019</u>	<u>2018</u>
Vehicles	\$ 10,613	\$ 9,820
Aircraft	19,045	17,499
Land	2,087	2,000
Buildings	5,046	4,808
Building and leasehold improvements	4,898	4,323
Plant equipment	13,849	11,833
Technology equipment	2,206	2,093
Construction-in-progress	1,983	2,112
	<u>59,727</u>	<u>54,488</u>
Less: Accumulated depreciation and amortization	(29,245)	(27,912)
	<u>\$ 30,482</u>	<u>\$ 26,576</u>

As part of our ongoing investment in transformation, in 2018 we made prospective revisions to our estimates of useful lives for building improvements, vehicles and plant equipment which in general had the effect of lengthening the useful lives of these categories.

For 2019, depreciation expense increased \$365 million, and net income decreased by \$287 million, or \$0.33 per share on a basic and diluted basis, as a result of investments in property, plant and equipment, net of disposals and assets becoming fully depreciated. Depreciation expense decreased \$212 million, and net income increased \$167 million, or \$0.19 per share on a basic and diluted basis, as a result of lengthening our estimated useful lives for various asset categories in the latter half of 2018. The combined effect of the foregoing was a net increase in depreciation expense of \$153 million and a decrease in net income of \$120 million, or \$0.14 per share on a basic and diluted basis, for 2019.

For 2018, this resulted in a decrease in depreciation expense and an increase in operating income of \$286 million and an increase to net income of \$228 million or \$0.26 per share on a basic and diluted basis. Separately, capital investments in additional property, plant and equipment, net of disposals and fully-depreciated assets, resulted in an increase in depreciation expense of \$257 million and a decrease to net income of \$205 million or \$0.24 per share on a basic and diluted basis in 2018. Combining both impacts resulted in a net decrease of \$29 million to depreciation expense, and an increase to net income of \$23 million or \$0.03 per share on both a basic and diluted basis in 2018.

We monitor our aircraft fleet utilization in light of current and projected volume levels, aircraft fuel prices and other factors. Additionally, we monitor our other property, plant and equipment categories for any indicators that the carrying value of the assets may not be recoverable. No impairment charges on property, plant and equipment were recorded in 2019 or 2018.

NOTE 5. COMPANY SPONSORED EMPLOYEE BENEFIT PLANS

We sponsor various retirement and pension plans, including defined benefit and defined contribution plans which cover our employees worldwide.

U.S. Pension Benefits

In the U.S. we maintain the following single-employer defined benefit pension plans: the UPS Retirement Plan, the UPS Pension Plan, the UPS/IBT Full-Time Employee Pension Plan and the UPS Excess Coordinating Benefit Plan, a non-qualified plan.

The UPS Retirement Plan is noncontributory and includes substantially all eligible employees of participating domestic subsidiaries hired prior to July 1, 2016 who are not members of a collective bargaining unit, as well as certain employees covered by a collective bargaining agreement. This plan generally provides for retirement benefits based on average compensation earned by employees prior to retirement. Benefits payable under this plan are subject to maximum compensation limits and the annual benefit limits for a tax-qualified defined benefit plan as prescribed by the Internal Revenue Service ("IRS").

The UPS Pension Plan is noncontributory and includes certain eligible employees of participating domestic subsidiaries and members of collective bargaining units that elect to participate in the plan. This plan generally provides for retirement benefits based on service credits earned by employees prior to retirement.

The UPS/IBT Full Time Employee Pension Plan is noncontributory and includes employees that were previously members of the Central States Pension Fund ("CSPF"), a multiemployer pension plan, in addition to other eligible employees who are covered under certain collective bargaining agreements. This plan generally provides for retirement benefits based on service credits earned by employees prior to retirement.

The UPS Excess Coordinating Benefit Plan is a non-qualified plan that provides benefits to certain participants in the UPS Retirement Plan, hired prior to July 1, 2016, for amounts that exceed the benefit limits described above.

In the year ended December 31, 2017, we amended the UPS Retirement Plan and the UPS Excess Coordinating Benefit Plan to cease accruals of additional benefits for future service and compensation for non-union participants effective January 1, 2023. We remeasured plan assets and pension benefit obligations for the affected pension plans as of June 30, 2017, resulting in a net actuarial gain of \$569 million. This reflected a curtailment gain of \$1.525 billion resulting from the benefit plan changes that was partially offset by net actuarial losses of \$956 million, driven by a reduction of approximately 32 basis points in the discount rate compared to December 31, 2016, offset by actual asset returns approximately 275 basis points above our expected return as of the remeasurement date. The net curtailment gain reduced the actuarial loss recorded in AOCI in the equity section of the consolidated balance sheets. As actuarial losses were within the corridor (defined as 10% of the greater of the fair value of plan assets and the plan's projected benefit obligation), there was no impact to the statement of consolidated income as a result of this remeasurement.

During the fourth quarter of 2019, certain former U.S. employees were offered the option to receive a one-time payment of their vested pension benefit. Approximately 18,800 former employees accepted this option, accelerating \$820 million in benefit payments during 2019 while reducing the number of participants who are due future payments from U.S. pension plans. As the cost of these settlements did not exceed the plans' service cost and interest cost for the year, the impact of the settlement was not recognized in earnings.

International Pension Benefits

We also sponsor various defined benefit plans covering certain of our international employees. The majority of our international obligations are for defined benefit plans in Canada and the United Kingdom. In addition, many of our international employees are covered by government-sponsored retirement and pension plans. We are not directly responsible for providing benefits to participants of government-sponsored plans.

U.S. Postretirement Medical Benefits

We also sponsor postretirement medical plans in the U.S. that provide healthcare benefits to our non-union retirees, as well as select union retirees who meet certain eligibility requirements and who are not otherwise covered by multiemployer plans. Generally, this includes employees with at least 10 years of service who have reached age 55 and employees who are eligible for postretirement medical benefits from a Company-sponsored plan pursuant to collective bargaining agreements. We have the right to modify or terminate certain of these plans. These benefits have been provided to certain retirees on a noncontributory basis; however, in many cases, retirees are required to contribute all or a portion of the total cost of the coverage.

Defined Contribution Plans

We also sponsor a defined contribution plan for employees not covered under collective bargaining agreements, and several smaller defined contribution plans for certain employees covered under collective bargaining agreements. The Company matches, in shares of UPS common stock or cash, a portion of the participating employees' contributions. Matching contributions charged to expense were \$130, \$127 and \$119 million for 2019, 2018 and 2017, respectively.

In addition to current benefits under the UPS 401(k) Savings Plan, non-union employees hired after July 1, 2016, receive a retirement contribution. UPS contributes 3% to 8% of eligible pay to the UPS 401(k) Savings Plan based on years of vesting service and business unit. Contributions under this plan are subject to maximum compensation and contribution limits for a tax-qualified defined contribution plan as prescribed by the IRS. Contributions charged to expense were \$67, \$28 and \$23 million for 2019, 2018 and 2017 respectively.

Effective June 23, 2017, the Company amended the UPS 401(k) Savings Plan so that non-union employees who currently participate in the UPS Retirement Plan will, in addition to current benefits under the UPS 401(k) Savings Plan, earn a retirement contribution beginning January 1, 2023. UPS will contribute 5% to 8% of eligible compensation to the UPS 401(k) Savings Plan based on years of vesting service. The amendment also provides for transition contributions for certain participants. There was no impact to the statement of consolidated income for 2019, 2018 and 2017 as a result of this change.

The UPS Restoration Savings Plan is a non-qualified plan that provides benefits to certain participants in the UPS 401(k) Savings Plan for amounts that exceed the benefit limits described above.

Contributions are also made to defined contribution money purchase plans under certain collective bargaining agreements. Amounts charged to expense were \$97, \$92 and \$91 million for 2019, 2018 and 2017, respectively.

Net Periodic Benefit Cost

Information about net periodic benefit cost for the company-sponsored pension and postretirement defined benefit plans is as follows (in millions):

	U.S. Pension Benefits			U.S. Postretirement Medical Benefits			International Pension Benefits		
	2019	2018	2017	2019	2018	2017	2019	2018	2017
Net Periodic Benefit Cost:									
Service cost	\$ 1,439	\$ 1,661	\$ 1,543	\$ 23	\$ 29	\$ 29	\$ 57	\$ 62	\$ 60
Interest cost	2,067	1,799	1,813	108	104	112	47	45	40
Expected return on assets	(3,130)	(3,201)	(2,883)	(8)	(8)	(7)	(76)	(77)	(66)
Amortization of prior service cost	218	193	192	7	7	7	2	1	1
Actuarial (gain) loss	2,296	1,603	729	37	—	53	54	24	18
Curtailment and settlement loss	—	—	—	—	—	—	—	—	2
Net periodic benefit cost	<u>\$ 2,890</u>	<u>\$ 2,055</u>	<u>\$ 1,394</u>	<u>\$ 167</u>	<u>\$ 132</u>	<u>\$ 194</u>	<u>\$ 84</u>	<u>\$ 55</u>	<u>\$ 55</u>

Actuarial Assumptions

The table below provides the weighted-average actuarial assumptions used to determine the net periodic benefit cost.

	U.S. Pension Benefits			U.S. Postretirement Medical Benefits			International Pension Benefits		
	2019	2018	2017	2019	2018	2017	2019	2018	2017
Discount rate	4.50%	3.84%	4.41%	4.51%	3.82%	4.23%	2.94%	2.78%	2.75%
Rate of compensation increase	4.25%	4.25%	4.27%	N/A	N/A	N/A	3.24%	3.22%	3.17%
Expected return on assets	7.75%	7.75%	8.75%	7.20%	7.20%	8.75%	5.69%	5.76%	5.65%
Cash balance interest credit rate	2.98%	2.50%	2.91%	N/A	N/A	N/A	3.17%	3.07%	2.65%

The table below provides the weighted-average actuarial assumptions used to determine the benefit obligations of our plans.

	U.S. Pension Benefits		U.S. Postretirement Medical Benefits		International Pension Benefits		
	2019	2018	2019	2018	2019	2018	
Discount rate		3.60%	4.50%	3.59%	4.51%	2.21%	2.94%
Rate of compensation increase		4.22%	4.25%	N/A	N/A	3.00%	3.24%
Cash balance interest credit rate		2.50%	2.98%	N/A	N/A	2.59%	3.17%

A discount rate is used to determine the present value of our future benefit obligations. To determine the discount rate for our U.S. pension and postretirement benefit plans, we use a bond matching approach to select specific bonds that would satisfy our projected benefit payments. We believe the bond matching approach reflects the process we would employ to settle our pension and postretirement benefit obligations. In October 2019, we refined our bond matching approach by implementing advances in technology and modeling techniques. This refinement decreased the projected benefit obligation on our consolidated balance sheet for our U.S. pension and postretirement plans by approximately \$900 million as of December 31, 2019. Additionally, we estimate that this refinement in method decreased our pre-tax mark-to-market charge by approximately \$810 million and increased net income by \$616 million, or \$0.71 per share on a basic and diluted basis. For our international plans, the discount rate is determined by matching the expected cash flows of a sample plan of similar duration to a yield curve based on long-term, high quality fixed income debt instruments available as of the measurement date. These assumptions are updated each measurement date, which is typically annually.

As of December 31, 2019, the impact of each basis point change in the discount rate on the projected benefit obligation of our pension and postretirement medical benefit plans is as follows (in millions):

	Increase (Decrease) in the Projected Benefit Obligation			
	Pension Benefits		Postretirement Medical Benefits	
One basis point increase in discount rate	\$	(86)	\$	(2)
One basis point decrease in discount rate		92		3

The Society of Actuaries ("SOA") published mortality tables and improvement scales are used in developing the best estimate of mortality for U.S. plans. In October 2019, the SOA published updated mortality tables and an updated improvement scale, both of which reduced expected mortality improvements from previously published tables and improvement scale. Based on our perspective of future longevity, we updated the mortality assumptions to incorporate these updated tables and improvement scale for purposes of measuring pension and other postretirement benefit obligations.

Assumptions for the expected return on plan assets are used to determine a component of net periodic benefit cost for the year. The assumption for our U.S. plans is developed using a long-term projection of returns for each asset class. Our asset allocation targets are reviewed and, if necessary, updated taking into consideration plan changes, funded status and actual performance. The expected return for each asset class is a function of passive, long-term capital market assumptions and excess returns generated from active management. The capital market assumptions used are provided by independent investment advisors, while excess return assumptions are supported by historical performance, fund mandates and investment expectations.

For plans outside the U.S., consideration is given to local market expectations of long-term returns. Strategic asset allocations are determined by plan, based on the nature of liabilities and considering the demographic composition of the plan participants.

Actuarial Assumptions - Central States Pension Fund

UPS was a contributing employer to the CSPF until 2007 when we withdrew from the CSPF and fully funded our allocable share of unfunded vested benefits by paying a \$6.1 billion withdrawal liability. Under a collective bargaining agreement with the International Brotherhood of Teamsters (“IBT”), UPS agreed to provide coordinating benefits in the UPS/IBT Full Time Employee Pension Plan (“UPS/IBT Plan”) for UPS participants whose last employer was UPS and who had not retired as of January 1, 2008 (“the UPS Transfer Group”) in the event that benefits are lawfully reduced by the CSPF in the future consistent with the terms of our withdrawal agreement with the CSPF. Under our withdrawal agreement with the CSPF, benefits to the UPS Transfer Group cannot be reduced without our consent and can only be reduced in accordance with applicable law.

In December 2014, Congress passed the Multiemployer Pension Reform Act (“MPRA”). This change in law for the first time permitted multiemployer pension plans to reduce benefit payments to retirees, subject to specific guidelines in the statute and government approval. In September 2015, the CSPF submitted a proposed pension benefit reduction plan to the U.S. Department of the Treasury (“Treasury”). In May 2016, Treasury rejected the proposed plan submitted by the CSPF. In the first quarter of 2018, Congress established a Joint Select Committee to develop a recommendation to improve the solvency of multiemployer plans and the Pension Benefit Guaranty Corporation (“PBGC”) before a November 30, 2018 deadline. While the Committee’s efforts failed to meet its deadline, the Committee made significant progress towards finding solutions that will address the long term solvency of multiemployer pension plans. In the third quarter of 2019, the U.S. House of Representatives passed the Rehabilitation for Multiemployer Pensions Act of 2019 to provide assistance to critical and declining multiemployer pension plans. This bill is now with the U.S. Senate for consideration. UPS will continue to work with all stakeholders, including legislators and regulators, to implement an acceptable solution.

The CSPF has said that it believes a legislative solution to its funded status is necessary or that it will become insolvent in 2025, and we expect that the CSPF will continue to explore options to avoid insolvency. Numerous factors could affect the CSPF’s funded status and UPS’s potential obligation to pay coordinating benefits under the UPS/IBT Plan. Any obligation to pay coordinating benefits will be subject to a number of significant uncertainties, including whether the CSPF submits a revised MPRA filing and the terms thereof, or whether it otherwise seeks federal government assistance, as well as the terms of any applicable legislation, the extent to which benefits are paid by the PBGC and our ability to successfully defend legal positions we may take in the future under the MPRA, including the suspension ordering provisions, our withdrawal agreement and other applicable law.

We account for the potential obligation to pay coordinating benefits to the UPS Transfer Group under Accounting Standards Codification Topic 715- Compensation- Retirement Benefits (“ASC 715”), which requires us to provide a best estimate of various actuarial assumptions, including the eventual outcome of this matter, in measuring our pension benefit obligation at the December 31st measurement date. While we currently believe the most likely outcome to this matter and the broader systemic problems facing multiemployer pension plans is intervention by the federal government, ASC 715 does not permit anticipation of changes in law in making a best estimate of pension liabilities.

As such, our best estimate of the next most likely outcome at the December 31, 2019 measurement date is that the CSPF will submit and implement another benefit reduction plan under the MPRA during 2020. We believe any MPRA filing would be designed to forestall insolvency by reducing benefits to participants other than the UPS Transfer Group to the maximum extent permitted, and then reducing benefits to the UPS Transfer Group by a lesser amount.

We evaluated this outcome using a deterministic cash flow projection, reflecting updated estimated CSPF cash flows and investment earnings, the lack of legislative action and the absence of a MPRA filing by the CSPF in 2019. As a result, at the December 31, 2019 measurement date, the best estimate of our projected benefit obligation for coordinating benefits that may be required to be directly provided by the UPS/IBT Plan to the UPS Transfer Group is \$2.6 billion.

The future value of this estimate will be influenced by the terms and timing of any MPRA filing, changes in our discount rate, rate of return on assets and other actuarial assumptions, presumed solvency of the PBGC, as well as potential solutions resulting from federal government intervention. Any such event may result in a decrease or an increase in the best estimate of our projected benefit obligation. If the uncertainties are not resolved, it is reasonably possible that our projected benefit obligation could increase by approximately \$2.2 billion, resulting in a total obligation for coordinating benefits of approximately \$4.8 billion. If a future change in law occurs, it may be a significant event requiring an interim remeasurement of the UPS/IBT Plan at the date the law is enacted. We will continue to assess the impact of these uncertainties on our projected benefit obligation in accordance with ASC 715.

Other Actuarial Assumptions

Healthcare cost trends are used to project future postretirement medical benefits payable from our plans. For 2019 U.S. plan obligations, future postretirement medical benefit costs were forecasted assuming an initial annual rate of increase of 6.5%, decreasing to 4.5% by the year 2024 and with consistent annual increases at that ultimate level thereafter.

Funded Status

The following table discloses the funded status of our plans and the amounts recognized in our consolidated balance sheets as of December 31st (in millions):

	U.S. Pension Benefits		U.S. Postretirement Medical Benefits		International Pension Benefits	
	2019	2018	2019	2018	2019	2018
Funded Status:						
Fair value of plan assets	\$ 46,172	\$ 39,554	\$ 37	\$ 26	\$ 1,558	\$ 1,284
Benefit obligation	(54,039)	(45,333)	(2,616)	(2,510)	(1,906)	(1,552)
Funded status recognized at December 31	<u>\$ (7,867)</u>	<u>\$ (5,779)</u>	<u>\$ (2,579)</u>	<u>\$ (2,484)</u>	<u>\$ (348)</u>	<u>\$ (268)</u>
Funded Status Recognized in our Balance Sheet:						
Other non-current assets	\$ —	\$ —	\$ —	\$ —	\$ 34	\$ 35
Other current liabilities	(22)	(20)	(200)	(195)	(5)	(4)
Pension and postretirement benefit obligations	(7,845)	(5,759)	(2,379)	(2,289)	(377)	(299)
Net liability at December 31	<u>\$ (7,867)</u>	<u>\$ (5,779)</u>	<u>\$ (2,579)</u>	<u>\$ (2,484)</u>	<u>\$ (348)</u>	<u>\$ (268)</u>
Amounts Recognized in AOCI:						
Unrecognized net prior service cost	\$ (800)	\$ (1,018)	\$ (16)	\$ (21)	\$ (12)	\$ (14)
Unrecognized net actuarial gain (loss)	(5,404)	(3,967)	(240)	(32)	(162)	(100)
Gross unrecognized cost at December 31	(6,204)	(4,985)	(256)	(53)	(174)	(114)
Deferred tax assets (liabilities) at December 31	1,497	1,205	62	13	40	28
Net unrecognized cost at December 31	<u>\$ (4,707)</u>	<u>\$ (3,780)</u>	<u>\$ (194)</u>	<u>\$ (40)</u>	<u>\$ (134)</u>	<u>\$ (86)</u>

The accumulated benefit obligation for our pension plans as of the measurement dates in 2019 and 2018 was \$57.553 and \$45.704 billion, respectively.

Benefit payments under the pension plans include \$27 and \$23 million paid from employer assets in 2019 and 2018, respectively. Benefit payments (net of participant contributions) under the postretirement medical benefit plans include \$82 and \$87 million paid from employer assets in 2019 and 2018, respectively. Such benefit payments from employer assets are also categorized as employer contributions.

At December 31, 2019 and 2018, the projected benefit obligation, the accumulated benefit obligation and the fair value of plan assets for pension plans with benefit obligations in excess of plan assets were as follows (in millions):

	Projected Benefit Obligation Exceeds the Fair Value of Plan Assets		Accumulated Benefit Obligation Exceeds the Fair Value of Plan Assets	
	2019	2018	2019	2018
U.S. Pension Benefits:				
Projected benefit obligation	\$ 54,039	\$ 45,333	\$ 54,039	\$ 45,333
Accumulated benefit obligation	53,194	44,284	53,194	44,284
Fair value of plan assets	46,172	39,554	46,172	39,554
International Pension Benefits:				
Projected benefit obligation	\$ 1,319	\$ 630	\$ 1,319	\$ 630
Accumulated benefit obligation	1,210	539	1,210	539
Fair value of plan assets	948	339	948	339

The accumulated postretirement benefit obligation presented in the funded status table exceeds plan assets for all U.S. postretirement medical benefit plans.

Benefit Obligations and Fair Value of Plan Assets

The following tables provide a reconciliation of the changes in the plans' benefit obligations and fair value of plan assets as of the respective measurement dates in each year (in millions).

	U.S. Pension Benefits		U.S. Postretirement Medical Benefits		International Pension Benefits	
	2019	2018	2019	2018	2019	2018
Benefit Obligations:						
Projected benefit obligation at beginning of year	\$ 45,333	\$ 45,847	\$ 2,510	\$ 2,792	\$ 1,552	\$ 1,651
Service cost	1,439	1,661	23	29	57	62
Interest cost	2,067	1,799	108	104	47	45
Gross benefits paid	(2,394)	(1,390)	(288)	(263)	(40)	(33)
Plan participants' contributions	—	—	30	26	3	3
Plan amendments	—	331	—	—	1	13
Actuarial (gain)/loss	7,594	(2,915)	233	(178)	213	(81)
Foreign currency exchange rate changes	—	—	—	—	47	(110)
Curtailments and settlements	—	—	—	—	(2)	(1)
Other	—	—	—	—	28	3
Projected benefit obligation at end of year	\$ 54,039	\$ 45,333	\$ 2,616	\$ 2,510	\$ 1,906	\$ 1,552

	U.S. Pension Benefits		U.S. Postretirement Medical Benefits		International Pension Benefits	
	2019	2018	2019	2018	2019	2018
Fair Value of Plan Assets:						
Fair value of plan assets at beginning of year	\$ 39,554	\$ 41,932	\$ 26	\$ 183	\$ 1,284	\$ 1,333
Actual return on plan assets	6,991	(1,007)	(5)	(7)	171	(6)
Employer contributions	2,021	19	274	87	67	80
Plan participants' contributions	—	—	30	26	3	3
Gross benefits paid	(2,394)	(1,390)	(288)	(263)	(40)	(33)
Foreign currency exchange rate changes	—	—	—	—	49	(92)
Curtailments and settlements	—	—	—	—	(2)	(1)
Other	—	—	—	—	26	—
Fair value of plan assets at end of year	\$ 46,172	\$ 39,554	\$ 37	\$ 26	\$ 1,558	\$ 1,284

2019 - \$8.040 billion pre-tax actuarial loss related to benefit obligation:

- *Discount Rates* (\$7.477 billion pre-tax loss): The weighted-average discount rate for our pension and postretirement medical plans decreased from 4.45% at December 31, 2018 to 3.55% at December 31, 2019, primarily due to both a decline in U.S. treasury yields and a decrease in credit spreads on AA-rated corporate bonds in 2019. This was partially offset by a refinement to our bond matching approach from advances in technology and modeling techniques.
- *Coordinating benefits attributable to the Central States Pension Fund* (\$603 million pre-tax loss): This represents our current best estimate of the additional potential coordinating benefits that may be required to be paid related to the Central States Pension Fund before taking into account the impact of the change in discount rates.
- *Demographic and Assumption Changes* (\$40 million pre-tax gain): This represents the difference between actual and estimated participant data and demographic factors, including items such as healthcare cost trends, compensation changes, rates of termination, retirement, mortality and other changes.

2018 - \$3.174 billion pre-tax actuarial gain related to benefit obligation:

- *Discount Rates* (\$4.829 billion pre-tax gain): The weighted-average discount rate for our pension and postretirement medical plans increased from 3.81% at December 31, 2017 to 4.45% at December 31, 2018, primarily due to both an increase in U.S. treasury yields and an increase in credit spreads on AA-rated corporate bonds in 2018.
- *Coordinating benefits attributable to the Central States Pension Fund* (\$1.550 billion pre-tax loss): This represents our current best estimate of potential coordinating benefits that may be required to be paid related to the Central States Pension Fund.
- *Demographic and Assumption Changes* (\$105 million pre-tax loss): This represents the difference between actual and estimated participant data and demographic factors, including items such as healthcare cost trends, compensation rate increases and rates of termination, retirement and mortality.

Pension and Postretirement Plan Assets

Under the governance of plan trustees, the Investment Committee establishes investment guidelines and strategies and regularly monitors the performance of investments and investment managers. The investment guidelines address items such as establishing appropriate governance provisions; defining investment objectives; determining strategic asset allocation; monitoring and reporting the investments on a regular basis; appointing/dismissing investment managers, custodians, consultants and advisors; risk management; determining/defining the mandates for investment managers; rebalancing of assets and determining investment restrictions/prohibited investments.

Pension assets are invested in accordance with applicable laws and regulations. The primary long-term investment objectives for pension assets are to: (1) provide for a reasonable amount of long-term growth of capital given prudent levels of risk exposure while minimizing permanent loss of capital; (2) generate investment results that meet or exceed the long-term rate of return assumption for the plans and (3) match the duration of the liabilities and assets of the plans to reduce the need for large employer contributions in the future. In furtherance of these objectives, investment managers are engaged to actively manage assets within the guidelines and strategies set forth by the Investment Committee. Active managers are monitored regularly and their performance is compared to applicable benchmarks.

Fair Value Measurements

Pension assets valued utilizing Level 1 inputs include equity investments, corporate debt instruments and U.S. government securities. Fair values were determined by closing prices for those securities traded on national stock exchanges, while securities traded in the over-the-counter market and listed securities for which no sale was reported on the valuation date are valued at the mean between the last reported bid and asked prices.

Level 2 assets include certain bonds that are valued based on yields currently available on comparable securities of other issues with similar credit ratings; mortgage-backed securities that are valued based on cash flow and yield models using acceptable modeling and pricing conventions; and certain investments that are pooled with other investments in a commingled fund. We value our investments in commingled funds by taking the percentage ownership of the underlying assets, each of which has a readily determinable fair value.

Fair value estimates for certain investments are based on unobservable inputs that are not corroborated by observable market data and are thus classified as Level 3.

Investments that do not have a readily determinable fair value, and which provide a net asset value ("NAV") or its equivalent developed consistent with FASB measurement principles, are valued using NAV as a practical expedient. These investments are not classified in Levels 1, 2, or 3 of the fair value hierarchy but instead included within the subtotals by asset category. Such investments include hedge funds, risk parity funds, real estate investments, private debt and private equity funds. Investments in hedge funds and risk parity funds are valued using the reported NAV as of December 31st. Real estate investments, private debt and private equity funds are valued at NAV per the most recent partnership audited financial reports, and adjusted, as appropriate, for investment activity between the date of the financial reports and December 31st. Due to the inherent limitations in obtaining a readily determinable fair value measurement for alternative investments, the fair values reported may differ from the values that would have been used had readily available market information for the alternative investments existed. These investments are described further below:

- Hedge Funds: Plan assets are invested in hedge funds that pursue multiple strategies to diversify risk and reduce volatility. Most of these hedge funds allow redemptions either quarterly or semi-annually after a two to three month notice period, while others allow for redemption after only a brief notification period with no restriction on redemption frequency. No unfunded commitments existed with respect to hedge funds as of December 31, 2019.
- Risk Parity Funds: Plan assets are invested in risk parity strategies in order to provide diversification and balance risk/return objectives. These strategies reflect a multi-asset class balanced risk approach generally consisting of equity, interest rates, credit and commodities. These funds allow for monthly redemptions with only a brief notification period. No unfunded commitments existed with respect to risk parity funds as of December 31, 2019.
- Real Estate, Private Debt and Private Equity Funds: Plan assets are invested in limited partnership interests in various private equity, private debt and real estate funds. Limited provision exists for the redemption of these interests by the limited partners that invest in these funds until the end of the term of the partnerships, typically ranging between 10 and 15 years from the date of inception. An active secondary market exists for similar partnership interests, although no particular value (discount or premium) can be guaranteed. At December 31, 2019, unfunded commitments to such limited partnerships totaling approximately \$2.241 billion are expected to be contributed over the remaining investment period, typically ranging between three and six years.

The fair values of U.S. and international pension and postretirement benefit plan assets by asset category as of December 31, 2019 are presented below (in millions), as well as the percentage that each category comprises of our total plan assets and the respective target allocations.

	Total Assets ⁽¹⁾	Level 1	Level 2	Level 3	Percentage of Plan Assets	Target Allocation
Asset Category (U.S. Plans):						
Cash and cash equivalents	\$ 964	\$ 818	\$ 146	\$ —	2.1%	1-5
Equity Securities:						
U.S. Large Cap	6,607	2,889	3,718	—		
U.S. Small Cap	505	376	129	—		
Emerging Markets	2,039	1,523	516	—		
Global Equity	2,892	2,553	339	—		
International Equity	4,591	2,499	2,092	—		
Total Equity Securities	16,634	9,840	6,794	—	36.0	25-55
Fixed Income Securities:						
U.S. Government Securities	14,077	12,980	1,097	—		
Corporate Bonds	5,051	—	5,051	—		
Global Bonds	50	—	50	—		
Municipal Bonds	24	—	24	—		
Total Fixed Income Securities	19,202	12,980	6,222	—	41.5	35-55
Other Investments:						
Hedge Funds	3,273	—	1,380	—	7.1	5-15
Private Equity	3,030	—	—	—	6.6	1-10
Private Debt	772	—	—	—	1.7	1-10
Real Estate	1,940	149	74	—	4.2	1-10
Structured Products ⁽²⁾	153	—	153	—	0.3	1-5
Risk Parity Funds	241	—	—	—	0.5	1-10
Total U.S. Plan Assets	\$ 46,209	\$ 23,787	\$ 14,769	\$ —	100.0%	
Asset Category (International Plans):						
Cash and cash equivalents	\$ 72	\$ 32	\$ 40	\$ —	4.6	1-10
Equity Securities:						
Local Markets Equity	209	—	209	—		
U.S. Equity	47	—	47	—		
Emerging Markets	33	33	—	—		
International / Global Equity	441	179	262	—		
Total Equity Securities	730	212	518	—	46.8	30-60
Fixed Income Securities:						
Local Government Bonds	94	—	94	—		
Corporate Bonds	177	20	157	—		
Global Bonds	110	110	—	—		
Total Fixed Income Securities	381	130	251	—	24.5	25-45
Other Investments:						
Real Estate	128	—	80	—	8.2	5-10
Other	247	—	218	12	15.9	1-20
Total International Plan Assets	\$ 1,558	\$ 374	\$ 1,107	\$ 12	100.0%	
Total Plan Assets	\$ 47,767	\$ 24,161	\$ 15,876	\$ 12		

⁽¹⁾ Certain investments that are measured at fair value using the NAV per share (or its equivalent) practical expedient have not been classified in the fair value hierarchy but are included in the category totals.

⁽²⁾ Represents mortgage and asset-backed securities.

The fair values of U.S. and international pension and postretirement benefit plan assets by asset category as of December 31, 2018 are presented below (in millions), as well as the percentage that each category comprises of our total plan assets and the respective target allocations.

Asset Category (U.S. Plans):	Total Assets ⁽¹⁾	Level 1	Level 2	Level 3	Percentage of Plan Assets	Target Allocation
Cash and cash equivalents	\$ 157	\$ 108	\$ 49	\$ —	0.4%	1-5
Equity Securities:						
U.S. Large Cap	5,276	2,155	3,121	—		
U.S. Small Cap	542	386	156	—		
Emerging Markets	1,859	1,436	423	—		
Global Equity	2,320	2,056	264	—		
International Equity	3,670	2,189	1,481	—		
Total Equity Securities	13,667	8,222	5,445	—	34.5	25-55
Fixed Income Securities:						
U.S. Government Securities	12,295	11,922	373	—		
Corporate Bonds	4,303	—	4,301	2		
Global Bonds	55	—	55	—		
Municipal Bonds	16	—	16	—		
Total Fixed Income Securities	16,669	11,922	4,745	2	42.1	35-55
Other Investments:						
Hedge Funds	3,154	—	1,185	—	8.0	5-15
Private Equity	2,763	—	—	—	7.0	1-10
Private Debt	836	—	178	—	2.1	1-10
Real Estate	1,989	152	53	—	5.0	1-10
Structured Products ⁽²⁾	138	—	138	—	0.4	1-5
Risk Parity Funds	207	—	—	—	0.5	1-10
Total U.S. Plan Assets	\$ 39,580	\$ 20,404	\$ 11,793	\$ 2	100.0%	
Asset Category (International Plans):						
Cash and cash equivalents	\$ 45	\$ 4	\$ 41	\$ —	3.5	1-10
Equity Securities:						
Local Markets Equity	171	—	171	—		
U.S. Equity	34	—	34	—		
Emerging Markets	33	33	—	—		
International / Global Equity	348	150	198	—		
Total Equity Securities	586	183	403	—	45.6	30-60
Fixed Income Securities:						
Local Government Bonds	102	24	78	—		
Corporate Bonds	195	54	141	—		
Global Bonds	27	27	—	—		
Total Fixed Income Securities	324	105	219	—	25.2	25-45
Other Investments:						
Real Estate	121	—	76	—	9.4	5-10
Other	208	—	191	4	16.3	1-20
Total International Plan Assets	\$ 1,284	\$ 292	\$ 930	\$ 4	100.0%	
Total Plan Assets	\$ 40,864	\$ 20,696	\$ 12,723	\$ 6		

⁽¹⁾ Certain investments that are measured at fair value using the NAV per share (or its equivalent) practical expedient have not been classified in the fair value hierarchy but are included in the category totals.

⁽²⁾ Represents mortgage and asset-backed securities.

The following table presents the changes in the Level 3 instruments measured on a recurring basis for the years ended December 31, 2019 and 2018 (in millions).

	Corporate Bonds	Other	Total
Balance on January 1, 2018	\$ 8	\$ —	\$ 8
Actual Return on Assets:			
Assets Held at End of Year	—	—	—
Assets Sold During the Year	(7)	—	(7)
Purchases	11	9	20
Sales	(10)	(5)	(15)
Transfers Into (Out of) Level 3	—	—	—
Balance on December 31, 2018	\$ 2	\$ 4	\$ 6
Actual Return on Assets:			
Assets Held at End of Year	—	1	1
Assets Sold During the Year	(4)	—	(4)
Purchases	4	7	11
Sales	(2)	—	(2)
Transfers Into (Out of) Level 3	—	—	—
Balance on December 31, 2019	\$ —	\$ 12	\$ 12

There were no shares of UPS class A or B common stock directly held in plan assets as of December 31, 2019 or December 31, 2018.

Expected Cash Flows

Information about expected cash flows for the pension and postretirement benefit plans is as follows (in millions):

	U.S. Pension Benefits	U.S. Postretirement Medical Benefits	International Pension Benefits
Expected Employer Contributions:			
2020 to plan trusts	\$ 1,000	\$ 186	\$ 62
2020 to plan participants	21	11	5
2020	\$ 1,645	\$ 241	\$ 32
2021	1,802	225	36
2022	1,942	215	41
2023	2,085	206	46
2024	2,230	196	52
2025 - 2029	13,293	857	353

Our funding policy for U.S. plans is to contribute amounts annually that are at least equal to the amounts required by applicable laws and regulations, or to directly fund payments to plan participants, as applicable. International plans will be funded in accordance with local regulations. Additional discretionary contributions may be made when deemed appropriate to meet the long-term obligations of the plans. Expected benefit payments for pensions will be primarily paid from plan trusts. Expected benefit payments for postretirement medical benefits will be paid from plan trusts and corporate assets.

NOTE 6. MULTIEMPLOYER EMPLOYEE BENEFIT PLANS

We contribute to a number of multiemployer defined benefit plans under the terms of collective bargaining agreements that cover our union-represented employees. These plans generally provide for retirement, death and/or termination benefits for eligible employees within the applicable collective bargaining units, based on specific eligibility/participation requirements, vesting periods and benefit formulas. The risks of participating in these multiemployer plans are different from single-employer plans in the following aspects:

- Assets contributed to a multiemployer plan by one employer may be used to provide benefits to employees of other participating employers.
- If we negotiate to cease participating in a multiemployer plan, we may be required to pay that plan an amount based on our allocable share of its underfunded status, referred to as a "withdrawal liability". However, cessation of participation in a multiemployer plan and subsequent payment of any withdrawal liability is subject to the collective bargaining process.
- If any of the multiemployer pension plans in which we participate enter critical status, and our contributions are not sufficient to satisfy any rehabilitation plan funding schedule, we could be required under the Pension Protection Act of 2006 to make additional surcharge contributions to the multiemployer pension plan in the amount of five to ten percent of the existing contributions required by our labor agreement. Such surcharges would cease upon the ratification of a new collective bargaining agreement, and could not recur unless a plan re-entered critical status at a later date.

The discussion that follows sets forth the financial impact on our results of operations and cash flows for the years ended December 31, 2019, 2018 and 2017, from our participation in multiemployer benefit plans. As part of the overall collective bargaining process for wage and benefit levels, we have agreed to contribute certain amounts to the multiemployer benefit plans during the contract period. The multiemployer benefit plans set benefit levels and are responsible for benefit delivery to participants. Future contribution amounts to multiemployer benefit plans are determined only through collective bargaining, and we have no additional legal or constructive obligation to increase contributions beyond the agreed-upon amounts (except potential surcharges under the Pension Protection Act of 2006 as described above).

The number of employees covered by our multiemployer pension plans has remained consistent over the past three years, and there have been no significant changes that affect the comparability of 2019, 2018 and 2017 contributions. We recognize expense for the contractually-required contribution for each period, and we recognize a liability for any contributions due and unpaid at the end of a reporting period.

Status of Collective Bargaining Agreements

As of December 31, 2019, we had approximately 290,000 employees employed under a national master agreement and various supplemental agreements with local unions affiliated with the Teamsters. The current National Master Agreement ("NMA") was ratified on April 28, 2019, and runs through July 31, 2023. Most of the economic provisions of the NMA are retroactive to August 1, 2018, which is the effective date of the NMA. The UPS Freight business unit national master agreement was ratified on November 11, 2018.

We have approximately 2,900 pilots who are employed under a collective bargaining agreement with the Independent Pilots Association ("IPA"), which becomes amendable on September 1, 2021. On February 10, 2020, the Company and the IPA reached a tentative agreement on a two-year contract extension. Upon ratification, the extension will go into effect on September 1, 2021 and become amendable September 1, 2023.

We have approximately 1,500 airline mechanics who are covered by a collective bargaining agreement with Teamsters Local 2727 which becomes amendable November 1, 2023. In addition, approximately 3,300 of our auto and maintenance mechanics who are not employed under agreements with the Teamsters are employed under collective bargaining agreements with the International Association of Machinists and Aerospace Workers ("IAM"). On May 2, 2019, the IAM ratified a new collective bargaining agreement which runs through July 31, 2024.

Multiemployer Pension Plans

The following table outlines our participation in multiemployer pension plans for the periods ended December 31, 2019, 2018 and 2017, and sets forth our calendar year contributions and accruals for each plan. The “EIN/Pension Plan Number” column provides the Employer Identification Number (“EIN”) and the three-digit plan number. The most recent Pension Protection Act zone status available in 2019 and 2018 relates to the plans’ two most recent fiscal year ends. The zone status is based on information that we received from the plans’ administrators and is certified by each plan’s actuary. Plans certified in the red zone are generally less than 65% funded; plans certified in the orange zone are both less than 80% funded and have an accumulated funding deficiency, or are expected to have a deficiency in any of the next six plan years; plans certified in the yellow zone are less than 80% funded; and plans certified in the green zone are at least 80% funded. The “FIP/RP Status Pending/Implemented” column indicates whether a financial improvement plan (“FIP”) for yellow/orange zone plans, or a rehabilitation plan (“RP”) for red zone plans, is either pending or has been implemented. As of December 31, 2019, all plans that have either a FIP or RP requirement have had the respective plan implemented.

Our collectively-bargained contributions satisfy the requirements of all implemented FIPs and RPs and do not currently require the payment of any surcharges. In addition, minimum contributions outside of the agreed upon contractual rates are not required. For the plans detailed in the following table, the expiration date of the associated collective bargaining agreements is July 31, 2023, with the exception of the Automotive Industries Pension Plan, the Automotive Machinists Pension Trust and the IAM National Pension Fund / National Pension Plan, which have a July 31, 2024 expiration date. For all plans detailed in the following table, we provided more than 5% of the total plan contributions from all employers for 2019, 2018 and 2017 (as disclosed in the annual filing with the Department of Labor for each respective plan).

Certain plans have been aggregated in the “all other multiemployer pension plans” line in the following table, as the contributions to each of these individual plans are not material.

Pension Fund	EIN / Pension Plan Number	Pension Protection Act Zone Status		FIP / RP Status Pending / Implemented	(in millions) UPS Contributions and Accruals			Surcharge Imposed
		2019	2018		2019	2018	2017	
Central Pennsylvania Teamsters Defined Benefit Plan	23-6262789-001	Green	Green	No	48	44	40	No
Employer-Teamsters Local Nos. 175 & 505 Pension Trust Fund	55-6021850-001	Red	Red	Yes/Implemented	14	13	12	No
Hagerstown Motor Carriers and Teamsters Pension Fund	52-6045424-001	Red	Red	Yes/Implemented	10	9	8	No
I.A.M. National Pension Fund / National Pension Plan	51-6031295-002	Green	Green	No	41	38	35	No
International Brotherhood of Teamsters Union Local No. 710 Pension Fund	36-2377656-001	Green	Green	No	142	129	118	No
Local 705, International Brotherhood of Teamsters Pension Plan	36-6492502-001	Yellow	Yellow	Yes/Implemented	113	104	93	No
Local 804 I.B.T. & Local 447 I.A.M.—UPS Multiemployer Retirement Plan	51-6117726-001	Yellow	Yellow	Yes/Implemented	112	116	110	No
Milwaukee Drivers Pension Trust Fund	39-6045229-001	Green	Green	No	48	42	38	No
New England Teamsters & Trucking Industry Pension Fund	04-6372430-001	Red	Red	Yes/Implemented	120	121	114	No
New York State Teamsters Conference Pension and Retirement Fund	16-6063585-074	Red	Red	Yes/Implemented	119	108	100	No
Teamster Pension Fund of Philadelphia and Vicinity	23-1511735-001	Yellow	Yellow	Yes/Implemented	74	66	60	No
Teamsters Joint Council No. 83 of Virginia Pension Fund	54-6097996-001	Green	Green	No	75	69	64	No
Teamsters Local 639—Employers Pension Trust	53-0237142-001	Green	Green	No	68	61	55	No
Teamsters Negotiated Pension Plan	43-6196083-001	Green	Green	No	37	34	32	No
Truck Drivers and Helpers Local Union No. 355 Retirement Pension Plan	52-6043608-001	Green	Green	No	24	22	20	No
United Parcel Service, Inc.—Local 177, I.B.T. Multiemployer Retirement Plan	13-1426500-419	Red	Red	Yes/Implemented	100	95	88	No
Western Conference of Teamsters Pension Plan	91-6145047-001	Green	Green	No	939	868	772	No
Western Pennsylvania Teamsters and Employers Pension Fund	25-6029946-001	Red	Red	Yes/Implemented	34	31	30	No
All Other Multiemployer Pension Plans					102	72	81	
Total Contributions					<u>\$2,220</u>	<u>\$2,042</u>	<u>\$1,870</u>	

Agreement with the New England Teamsters and Trucking Industry Pension Fund

In 2012, we reached an agreement with the New England Teamsters and Trucking Industry Pension Fund ("NETTI Fund"), a multiemployer pension plan in which UPS is a participant, to restructure the pension liabilities for approximately 10,200 UPS employees represented by the Teamsters. As of December 31, 2019 and 2018, we had \$845 and \$852 million, respectively, recognized in "Other Non-Current Liabilities" as well as \$7 million as of December 31, 2019 and 2018 recorded in "Other current liabilities" on our consolidated balance sheets representing the remaining balance of the NETTI Fund withdrawal liability. This liability is payable in equal monthly installments over a remaining term of approximately 43 years. Based on the borrowing rates currently available to the Company for long-term financing of a similar maturity, the fair value of the NETTI Fund withdrawal liability as of December 31, 2019 and 2018 was \$929 and \$832 million, respectively. We utilized Level 2 inputs in the fair value hierarchy of valuation techniques to determine the fair value of this liability.

Multiemployer Health and Welfare Plans

We also contribute to a number of multiemployer health and welfare plans covering both active and retired employees. Healthcare benefits are provided to participants who meet certain eligibility requirements as covered under the applicable collective bargaining unit. The following table sets forth our calendar year plan contributions and accruals. Certain plans have been aggregated in the "all other multiemployer health and welfare plans" line, as the contributions to each of these individual plans are not material.

Health and Welfare Fund	(in millions)		
	UPS Contributions and Accruals		
	2019	2018	2017
Bay Area Delivery Drivers	37	40	37
Central Pennsylvania Teamsters Health & Pension Fund	31	29	27
Central States, South East & South West Areas Health and Welfare Fund	2,899	2,530	2,366
Delta Health Systems—East Bay Drayage Drivers	30	30	29
Joint Council #83 Health & Welfare Fund	45	40	37
Local 804 Welfare Trust Fund	101	90	84
Milwaukee Drivers Pension Trust Fund—Milwaukee Drivers Health and Welfare Trust Fund	48	43	38
New York State Teamsters Health & Hospital Fund	71	62	59
Northern California General Teamsters (DELTA)	157	153	132
Northern New England Benefit Trust	59	54	50
Oregon / Teamster Employers Trust	51	43	38
Teamsters 170 Health & Welfare Fund	19	18	17
Teamsters Benefit Trust	47	48	46
Teamsters Local 251 Health & Insurance Plan	18	17	15
Teamsters Local 638 Health Fund	53	48	43
Teamsters Local 639—Employers Health & Pension Trust Funds	32	29	27
Teamsters Local 671 Health Services & Insurance Plan	20	19	17
Teamsters Union 25 Health Services & Insurance Plan	59	56	52
Teamsters Western Region & Local 177 Health Care Plan	769	656	605
Truck Drivers and Helpers Local 355 Baltimore Area Health & Welfare Fund	19	18	16
Utah-Idaho Teamsters Security Fund	37	32	29
Washington Teamsters Welfare Trust	67	57	52
All Other Multiemployer Health and Welfare Plans	141	156	156
Total Contributions	\$ 4,810	\$ 4,268	\$ 3,972

NOTE 7. GOODWILL AND INTANGIBLE ASSETS

The following table indicates the allocation of goodwill by segment (in millions):

	U.S. Domestic Package	International Package	Supply Chain & Freight	Consolidated
Balance on January 1, 2018	\$ 715	\$ 435	\$ 2,722	\$ 3,872
Acquired	—	—	—	—
Currency / Other	—	(18)	(43)	(61)
Balance on December 31, 2018	\$ 715	\$ 417	\$ 2,679	\$ 3,811
Acquired	—	2	3	5
Currency / Other	—	(3)	—	(3)
Balance on December 31, 2019	\$ 715	\$ 416	\$ 2,682	\$ 3,813

2019 Goodwill Activity

The goodwill acquired in the International Package segment is related to our January 2019 acquisition of Transmodal Services Private Limited in India. The goodwill acquired in the Supply Chain & Freight segment is primarily due to July 2019 acquisitions by Marken in Europe.

The remaining change in goodwill for the International Package segment was due to immaterial purchase accounting adjustments and the impact of changes in the value of the U.S. Dollar on the translation of non-U.S. Dollar goodwill balances.

2018 Goodwill Activity

The change in goodwill for both the Supply Chain & Freight and the International Package segments was due to immaterial purchase accounting adjustments and the impact of changes in the value of the U.S. Dollar on the translation of non-U.S. Dollar goodwill balances.

Goodwill Impairment

We completed our annual goodwill impairment evaluation, as of July 1st, on a reporting unit basis. For the periods presented, no triggering events were identified that required an interim impairment test.

U.S. Domestic Package is our largest reporting segment and reporting unit. In our International Package reporting segment, we have the following reporting units: Europe, Asia, Americas and ISMEA. In our Supply Chain & Freight segment we have the following reporting units: Forwarding, Logistics, UPS Mail Innovations, UPS Freight, The UPS Store, UPS Capital, Marken and Coyote.

In assessing our goodwill for impairment, we initially evaluate qualitative factors to determine if it is more likely than not that the fair value of a reporting unit is less than its carrying amount. If the qualitative assessment is not conclusive and it is necessary to calculate the fair value of a reporting unit, then we utilize a two-step process to test goodwill for impairment. First, a comparison of the fair value of the applicable reporting unit with the aggregate carrying value, including goodwill, is performed. We primarily determine the fair value of our reporting units using a discounted cash flow model, and supplement this with observable valuation multiples for comparable companies, as applicable. If the carrying amount of a reporting unit exceeds the reporting unit's fair value, we perform the second step of the goodwill impairment test to determine the amount of impairment loss. The second step includes comparing the implied fair value of the affected reporting unit's goodwill with the carrying value of that goodwill.

In 2019, we utilized a qualitative assessment to determine that it was more likely than not that the reporting unit fair value exceeded the carrying value for U.S. Domestic Package, Forwarding, Logistics, Coyote, UPS Mail Innovations and The UPS Store. For the remaining reporting units owned at the annual goodwill impairment testing date, we utilized the two-step process to test goodwill for impairment. We did not have any goodwill impairment charges in 2019, 2018 or 2017. Cumulatively, our Supply Chain & Freight segment has recorded \$622 million of goodwill impairment charges, while our International and U.S. Domestic Package segments have not recorded any goodwill impairment charges.

Intangible Assets

The following is a summary of intangible assets at December 31, 2019 and 2018 (in millions):

	Gross Carrying Amount	Accumulated Amortization	Net Carrying Value	Weighted-Average Amortization Period (in years)
December 31, 2019				
Capitalized software	\$ 4,125	\$ (2,704)	\$ 1,421	6.9
Licenses	117	(64)	53	3.9
Franchise rights	146	(109)	37	20.0
Customer relationships	730	(282)	448	10.6
Trade name	200	—	200	N/A
Trademarks, patents and other	29	(21)	8	7.7
Total Intangible Assets	<u>\$ 5,347</u>	<u>\$ (3,180)</u>	<u>\$ 2,167</u>	<u>7.7</u>
December 31, 2018				
Capitalized software	\$ 3,693	\$ (2,478)	\$ 1,215	
Licenses	117	(36)	81	
Franchise rights	145	(105)	40	
Customer relationships	736	(217)	519	
Trade name	200	—	200	
Trademarks, patents and other	52	(31)	20	
Total Intangible Assets	<u>\$ 4,943</u>	<u>\$ (2,867)</u>	<u>\$ 2,075</u>	

A trade name and licenses with carrying values of \$200 and \$4 million, respectively, as of December 31, 2019 are deemed to be indefinite-lived intangible assets, and therefore are not amortized. Impairment tests for indefinite-lived intangible assets are performed on an annual basis. All of our other recorded intangible assets are deemed to be finite-lived intangibles, and are thus amortized over their estimated useful lives. Impairment tests for these intangible assets are only performed when a triggering event occurs that may indicate that the carrying value of the intangible may not be recoverable. Impairments of finite-lived intangible assets were \$2 and \$12 million in 2019 and 2018, respectively.

Amortization of intangible assets was \$377, \$339 and \$287 million during 2019, 2018 and 2017, respectively. Expected amortization of finite-lived intangible assets recorded as of December 31, 2019 for the next five years is as follows (in millions): 2020—\$481; 2021—\$403; 2022—\$332; 2023—\$276; 2024—\$220. Amortization expense in future periods will be affected by business acquisitions, software development, licensing agreements, franchise rights purchased and other factors.

NOTE 8. DEBT AND FINANCING ARRANGEMENTS

The carrying value of our outstanding debt obligations, as of December 31, 2019 and 2018 consists of the following (in millions):

	Principal		Carrying Value	
	Amount	Maturity	2019	2018
Commercial paper	\$ 3,243	2020	\$ 3,234	\$ 2,662
Fixed-rate senior notes:				
5.125% senior notes	1,000	2019	—	998
3.125% senior notes	1,500	2021	1,524	1,492
2.050% senior notes	700	2021	699	698
2.450% senior notes	1,000	2022	1,003	1,023
2.350% senior notes	600	2022	598	597
2.500% senior notes	1,000	2023	995	994
2.800% senior notes	500	2024	497	496
2.200% senior notes	400	2024	398	—
2.400% senior notes	500	2026	498	498
3.050% senior notes	1,000	2027	992	991
3.400% senior notes	750	2029	745	—
2.500% senior notes	400	2029	397	—
6.200% senior notes	1,500	2038	1,483	1,482
4.875% senior notes	500	2040	490	490
3.625% senior notes	375	2042	368	368
3.400% senior notes	500	2046	491	491
3.750% senior notes	1,150	2047	1,136	1,136
4.250% senior notes	750	2049	742	—
3.400% senior notes	700	2049	688	—
Floating-rate senior notes:				
Floating-rate senior notes	350	2021	349	349
Floating-rate senior notes	400	2022	399	399
Floating-rate senior notes	500	2023	499	499
Floating-rate senior notes	1,041	2049-2067	1,028	1,029
8.375% Debentures:				
8.375% debentures	424	2020	426	419
8.375% debentures	276	2030	281	274
Pound Sterling Notes:				
5.500% notes	87	2031	86	84
5.125% notes	597	2050	566	546
Euro Senior Notes:				
0.375% senior notes	783	2023	779	797
1.625% senior notes	783	2025	779	798
1.000% senior notes	560	2028	556	570
1.500% senior notes	560	2032	556	569
Floating-rate senior notes	560	2020	559	572
Canadian senior notes:				
2.125% senior notes	573	2024	571	548
Finance lease obligations	498	2020 – 2210	498	534
Facility notes and bonds	320	2029 – 2045	320	320
Other debt	8	2020 – 2025	8	13
Total debt	\$ 26,388		25,238	22,736
Less: current maturities			(3,420)	(2,805)
Long-term debt			\$ 21,818	\$ 19,931

Commercial Paper

We are authorized to borrow up to \$10.0 billion under a U.S. commercial paper program and €5.0 billion (in a variety of currencies) under a European commercial paper program. We had the following amounts outstanding under these programs as of December 31, 2019: \$2.172 billion with an average interest rate of 1.90% and €949 million (\$1.062 billion) with an average interest rate of -0.44%. As of December 31, 2019, we have classified the entire commercial paper balance as a current liability on our consolidated balance sheets. The amount of commercial paper outstanding under these programs in 2020 is expected to fluctuate.

Debt Classification

We have classified both our 8.375% debentures due April 2020 with a principal balance of \$424 million, and our €500 million (\$560 million) floating-rate senior notes due July 2020, as long-term debt based on our intent and ability to refinance the debt as of December 31, 2019. We have classified certain floating-rate senior notes that are puttable by the note holders as long-term debt due to our intent and ability to refinance the debt if the put option is exercised by the note holders.

Debt Issuances

On March 15, 2019 we issued two series of notes, both in the principal amounts of \$750 million. These fixed-rate notes bear interest at 3.40% and 4.25% and will mature on March 15, 2029 and March 15, 2049, respectively. Interest on the fixed-rate senior notes is payable semi-annually, beginning September 2019. The 3.40% fixed-rate senior notes are callable at our option at a redemption price equal to the greater of 100% of the principal amount, or the sum of the present values of remaining scheduled payments of principal and interest due from the redemption date until three months prior to maturity, discounted to the redemption date on a semi-annual basis at the discount rate of the Treasury Rate plus 15 basis points, plus accrued and unpaid interest. The 4.25% fixed-rate senior notes are callable at our option at a redemption price equal to the greater of 100% of the principal amount, or the sum of the present values of remaining scheduled payments of principal and interest due from the redemption date until six months prior to maturity discounted to the redemption date on a semi-annual basis at the discount rate of the Treasury Rate plus 20 basis points, plus accrued and unpaid interest.

On August 16, 2019 we issued three series of notes, two with principal amounts of \$400 million and one in the principal amount of \$700 million. These notes bear interest at 2.20%, 2.50% and 3.40%, respectively, and will mature on September 1, 2024, September 1, 2029 and September 1, 2049, respectively. Interest on the notes is payable semi-annually, beginning March 2020. The 2.20% senior notes are callable at our option at a redemption price equal to the greater of 100% of the principal amount, or the sum of the present values of scheduled payments of principal and interest due from the redemption date until one month prior to maturity, discounted to the redemption date on a semi-annual basis at the discount rate of the Treasury Rate plus 10 basis points, plus accrued and unpaid interest. The 2.50% senior notes are callable at our option at a redemption price equal to the greater of 100% of the principal amount, or the sum of the present values of scheduled payments of principal and interest due from the redemption date until three months prior to maturity discounted to the redemption date on a semi-annual basis at the discount rate of the Treasury Rate plus 15 basis points, plus accrued and unpaid interest. The 3.40% senior notes are callable at our option at a redemption price equal to the greater of 100% of the principal amount, or the sum of the present values of scheduled payments of principal and interest due from the redemption date until six months prior to maturity, discounted to the redemption date on a semi-annual basis at the discount rate of the Treasury Rate plus 20 basis points, plus accrued and unpaid interest.

Fixed-Rate Senior Notes

All of our fixed-rate notes pay interest semi-annually, and allow for redemption by UPS at any time by paying the greater of the principal amount or a “make-whole” amount, plus accrued interest. We subsequently entered into interest rate swaps on several of these notes, which effectively converted the fixed interest rates on the notes to variable LIBOR-based interest rates. The average interest rate payable on the notes where fixed interest rates were swapped to variable-based interest rates, including the impact of the interest rate swaps, for 2019 and 2018 were as follows:

	Principal Value	Maturity	Average Effective Interest Rate	
			2019	2018
5.50% senior notes	\$ 750	2018	—%	3.63%
5.125% senior notes	1,000	2019	4.48%	3.99%
3.125% senior notes	1,500	2021	2.59%	2.32%
2.45% senior notes	1,000	2022	3.03%	2.77%

On April 1, 2019, our \$1.00 billion 5.125% senior notes matured and were repaid in full.

8.375% Debentures

The 8.375% debentures consist of two separate tranches, as follows:

- \$276 million of the debentures have a maturity of April 1, 2030. These debentures have an 8.375% interest rate until April 1, 2020, and, thereafter, the interest rate will be 7.62% for the final 10 years. These debentures are redeemable in whole or in part at our option at any time. The redemption price is equal to the greater of 100% of the principal amount and accrued interest, or the sum of the present values of the remaining scheduled payments of principal and interest thereon discounted to the date of redemption (at a benchmark treasury yield plus five basis points) plus accrued interest.
- \$424 million of the debentures have a maturity of April 1, 2020. These debentures are not subject to redemption prior to maturity.

Interest is payable semi-annually in April and October for both tranches and neither tranche is subject to sinking fund requirements. We subsequently entered into interest rate swaps on the 2020 debentures, which effectively converted the fixed interest rates on the debentures to variable LIBOR-based interest rates. The average interest rate payable on the 2020 debentures, including the impact of the interest rate swaps, for 2019 and 2018 was 7.20% and 6.93%, respectively.

Floating-Rate Senior Notes

The floating-rate senior notes, with principal amounts totaling \$1.041 billion, bear interest at either one or three-month LIBOR, less a spread ranging from 30 to 45 basis points. The average interest rate for 2019 and 2018 was 2.05% and 1.76%, respectively. These notes are callable at various times after 30 years at a stated percentage of par value, and putable by the note holders at various times after one year at a stated percentage of par value. The notes have maturities ranging from 2049 through 2067. We classified the floating-rate senior notes that are putable by the note holder as long-term liabilities, due to our intent and ability to refinance the debt if the put option is exercised by the note holder.

The remaining three floating-rate senior notes in the principal amounts of \$350, \$400, and \$500 million, bear interest at three-month LIBOR, plus a spread ranging from 15 to 45 basis points. The average interest rate for 2019 and 2018 was 2.82% and 2.50%, respectively. These notes are not callable. The notes have maturities ranging from 2021 through 2023.

Finance Lease Obligations

We have certain property, plant and equipment subject to finance leases. For additional information on finance lease obligations, see note 10.

Facility Notes and Bonds

We have entered into agreements with certain municipalities or related entities to finance the construction of, or improvements to, facilities that support our operations in the United States. These facilities are located around airport properties in Louisville, Kentucky; Dallas, Texas; and Philadelphia, Pennsylvania. Under these arrangements, we enter into a lease or loan agreement that covers the debt service obligations on the bonds issued by these entities, as follows:

- Bonds with a principal balance of \$149 million issued by the Louisville Regional Airport Authority associated with our Worldport facility in Louisville, Kentucky. The bonds, which are due in January 2029, bear interest at a variable rate, and the average interest rates for 2019 and 2018 were 1.49% and 1.43%, respectively.
- Bonds with a principal balance of \$42 million and due in November 2036 issued by the Louisville Regional Airport Authority associated with our air freight facility in Louisville, Kentucky. The bonds bear interest at a variable rate, and the average interest rates for 2019 and 2018 were 1.49% and 1.39%, respectively.
- Bonds with a principal balance of \$29 million issued by the Dallas / Fort Worth International Airport Facility Improvement Corporation associated with our Dallas, Texas airport facilities. The bonds are due in May 2032 and bear interest at a variable rate, however the variable cash flows on the obligation have been swapped to a fixed 5.11%.
- Bonds with a principal balance of \$100 million issued by the Delaware County, Pennsylvania Industrial Development Authority associated with our Philadelphia, Pennsylvania airport facilities. These bonds, which are due September 2045, bear interest at a variable rate. The average interest rate for 2019 and 2018 was 1.48% and 1.35%, respectively.

Pound Sterling Notes

The Pound Sterling notes consist of two separate tranches, as follows:

- Notes with a principal amount of £66 million accrue interest at a 5.50% fixed rate, and are due in February 2031. These notes are not callable.
- Notes with a principal amount of £455 million accrue interest at a 5.125% fixed rate, and are due in February 2050. These notes are callable at our option at a redemption price equal to the greater of 100% of the principal amount and accrued interest, or the sum of the present values of the remaining scheduled payments of principal and interest thereon discounted to the date of redemption at a benchmark U.K. government bond yield plus 15 basis points, plus accrued interest.

Canadian Dollar Senior Notes

The Canadian Dollar notes consist of a single series as follows:

- Notes in the principal amount of C\$750 million, which bear interest at a 2.125% fixed interest rate and mature in May 2024. Interest on the notes is payable semi-annually. The notes are callable at our option, in whole or in part at the Government of Canada yield plus 21.5 basis points, and on or after the par call date, at par value.

Euro Senior Notes

The Euro notes consist of four separate issuances, as follows:

- Notes in the principal amount of €500 million accrue interest at a 1% fixed rate and are due in November 2028. Interest is payable annually on the notes. These notes are callable at our option at a redemption price equal to the greater of 100% of the principal amount, or the sum of the present values of the remaining scheduled payments of principal and interest thereon discounted to the date of redemption at a benchmark comparable German government bond yield plus 15 basis points, plus accrued interest.
- Notes with a principal amount of €500 million accrue interest at a variable rate equal to three-month EURIBOR plus 43 basis points and are due in July 2020. Interest is payable quarterly on the notes. These notes are not callable. The notes bear interest at a variable rate, and the average interest rates for 2019 and 2018 were 0.08% and 0.11%, respectively.

- Notes with a principal amount of €700 million accrue interest at a 1.625% fixed rate and are due in November 2025. Interest is payable annually on the notes. These notes are callable at our option at a redemption price equal to the greater of 100% of the principal amount, or the sum of the present values of the remaining scheduled payments of principal and interest thereon discounted to the date of redemption at a benchmark German government bond yield plus 20 basis points, plus accrued interest.
- Notes with principal amounts of €700 million and €500 million accrue interest at 0.375% and 1.500% fixed rates, respectively, and are due in November 2023 and November 2032, respectively. Interest on these notes is payable annually. The notes are callable at our option at a redemption price equal to the greater of 100% of the principal amount, or the sum of the present values of the remaining scheduled payments of principal and interest thereon discounted to the date of redemption at a benchmark comparable government bond yield plus 10 and 20 basis points, respectively, plus accrued interest.

Contractual Commitments

The following table sets forth the aggregate annual principal payments due under our long-term debt and the aggregate amounts expected to be spent for purchase commitments (in millions).

Year	Debt Principal	Purchase Commitments⁽¹⁾
2020	\$ 4,232	3,569
2021	2,551	1,982
2022	2,001	966
2023	2,284	323
2024	1,474	261
After 2024	12,349	201
Total	\$ 24,891	\$ 7,302

⁽¹⁾ Purchase commitments includes amounts due under aircraft leases that we entered into in 2019 and our January 29, 2020 announced commitment to purchase 10,000 electric vehicles.

As of December 31, 2019, we had outstanding letters of credit totaling approximately \$1.267 billion issued in connection with our self-insurance reserves and other routine business requirements. We also issue surety bonds as an alternative to letters of credit in certain instances, and as of December 31, 2019, we had \$1.327 billion of surety bonds written.

Sources of Credit

We maintain two credit agreements with a consortium of banks. One of these agreements provides revolving credit facilities of \$2.0 billion, and expires on December 8, 2020. Generally, amounts outstanding under this facility bear interest at a periodic fixed rate equal to LIBOR for the applicable interest period and currency denomination, plus an applicable margin. Alternatively, a fluctuating rate of interest equal to the highest of (1) the rate of interest last quoted by The Wall Street Journal as the prime rate in the United States; (2) the Federal Funds effective rate plus 0.50%; and (3) LIBOR for a one month interest period plus 1.00%, plus an applicable margin, may be used at our discretion. In each case, the applicable margin for advances bearing interest based on LIBOR is a percentage determined by quotations from Markit Group Ltd. for our 1-year credit default swap spread, subject to a minimum rate of 0.25% and a maximum rate of 1.00%. The applicable margin for advances bearing interest based on the prime rate is 1.00% below the applicable margin for LIBOR advances (but not lower than 0.00%). We are also able to request advances under this facility based on competitive bids for the applicable interest rate. There were no amounts outstanding under this facility as of December 31, 2019.

The second agreement provides revolving credit facilities of \$2.5 billion, and expires on December 11, 2023. Generally, amounts outstanding under this facility bear interest at a periodic fixed rate equal to LIBOR for the applicable interest period and currency denomination, plus an applicable margin. Alternatively, a fluctuating rate of interest equal to the highest of (1) the rate of interest last quoted by The Wall Street Journal as the prime rate in the United States; (2) the Federal Funds effective rate plus 0.50%; and (3) LIBOR for a one month interest period plus 1.00%, plus an applicable margin, may be used at our discretion. In each case, the applicable margin for advances bearing interest based on LIBOR is a percentage determined by quotations from Markit Group Ltd. for our 1-year credit default swap spread, interpolated for a period from the date of determination of such credit default swap spread in connection with a new interest period until the latest maturity date of this facility then in effect (but not less than a period of one year). The minimum applicable margin rate is 0.10% and the maximum applicable margin rate is 0.75% per annum. The applicable margin for advances bearing interest based on the prime rate is 1.00% below the applicable margin for LIBOR advances (but not less than 0.00%). We are also able to request advances under this facility based on competitive bids. There were no amounts outstanding under this facility as of December 31, 2019.

Debt Covenants

Our existing debt instruments and credit facilities subject us to certain financial covenants. As of December 31, 2019 and for all prior periods presented, we have satisfied these financial covenants. These covenants limit the amount of secured indebtedness that we may incur, and limit the amount of attributable debt in sale-leaseback transactions, to 10% of net tangible assets. As of December 31, 2019, 10% of net tangible assets is equivalent to \$3.646 billion; however, we have no covered sale-leaseback transactions or secured indebtedness outstanding. We do not expect these covenants to have a material impact on our financial condition or liquidity.

Fair Value of Debt

Based on the borrowing rates currently available to the Company for long-term debt with similar terms and maturities, the fair value of long-term debt, including current maturities, is approximately \$26.949 and \$23.293 billion as of December 31, 2019 and 2018, respectively. We utilized Level 2 inputs in the fair value hierarchy of valuation techniques to determine the fair value of all of our debt instruments.

NOTE 9. LEGAL PROCEEDINGS AND CONTINGENCIES

We are involved in a number of judicial proceedings and other matters arising from the conduct of our business.

Although there can be no assurance as to the ultimate outcome, we have generally denied, or believe we have a meritorious defense and will deny, liability in all pending matters, including (except as otherwise noted herein) the matters described below, and we intend to vigorously defend each matter. We accrue amounts associated with legal proceedings when and to the extent a loss becomes probable and can be reasonably estimated. The actual costs of resolving legal proceedings may be substantially higher or lower than the amounts accrued on those claims.

For matters as to which we are not able to estimate a possible loss or range of losses, we are not able to determine whether any such loss will have a material adverse effect on our business, financial condition, results of operations or liquidity. For matters in this category, we have indicated in the descriptions that follow the reasons that we are unable to estimate the possible loss or range of losses.

Judicial Proceedings

In February 2015, the State and City of New York filed suit against UPS in the U.S. District Court for the Southern District of New York, arising from alleged shipments of cigarettes to New York State and City residents. The complaint asserted claims under various federal and state laws. The complaint also included a claim that UPS violated the Assurance of Discontinuance it entered into with the New York Attorney General in 2005 concerning cigarette deliveries. On March 24, 2017, the District Court issued an opinion and order finding liability against UPS on each of the plaintiffs' causes of action. On May 25, 2017, the District Court issued a corrected opinion and order on liability and an order awarding the plaintiffs damages of \$9 million and penalties of \$238 million. Following an appeal, on November 7, 2019, the U.S. Court of Appeals for the Second Circuit issued an order awarding the plaintiffs damages of \$19 million and penalties of \$79 million. An accrual of \$100 million with respect to this matter is included on our consolidated balance sheets at December 31, 2019. We estimate that the amount of losses could be up to \$247 million, plus interest; however, the amount of penalties ultimately payable, if any, is subject to a variety of complex factors and potential outcomes that could be determined in future legal proceedings, which would include a petition for a writ of certiorari with the U.S. Supreme Court.

We are a defendant in a number of lawsuits filed in state and federal courts containing various class action allegations under state wage-and-hour laws. At this time, we do not believe that any loss associated with any matter would have a material adverse effect on our financial condition, results of operations or liquidity. One of these matters, Hughes v. UPS Supply Chain Solutions, Inc. and United Parcel Service, Inc. had previously been certified as a class action in Kentucky state court. In the second quarter of 2019, the court granted our motion for judgment on the pleadings related to the wage-and-hour claims. The plaintiffs have appealed this decision.

Other Matters

In October 2015, the Department of Justice ("DOJ") informed us of an industry-wide inquiry into the transportation of mail under the United States Postal Service ("USPS") International Commercial Air contracts. In October 2017, we received a Civil Investigative Demand seeking certain information relating to our contracts. The DOJ has indicated it is investigating potential violations of the False Claims Act or other statutes. We are cooperating with the DOJ. We are unable to predict what action, if any, might be taken in the future by any government authorities as a result of their investigation. Accordingly, at this time, we are not able to estimate a possible loss or range of losses that may result from this matter or to determine whether such loss, if any, would have a material adverse effect on our financial condition, results of operations or liquidity.

In August 2016, Spain's National Markets and Competition Commission ("CNMC") announced an investigation into 10 companies in the commercial delivery and parcel industry, including UPS, related to alleged nonaggression agreements to allocate customers. In May 2017, UPS received a Statement of Objections issued by the CNMC. In July 2017, UPS received a Proposed Decision from the CNMC. On March 8, 2018, the CNMC adopted a final decision, finding an infringement and imposing a fine on UPS of €19 million. UPS appealed the decision and in September 2018, obtained a suspension of the implementation of the decision (including payment of the fine). The appeal is pending. There are multiple factors that prevent us from being able to estimate a possible loss or range of losses that may result from this matter or to determine whether such loss, if any, would have a material adverse effect on our financial condition, results of operations or liquidity including: (1) we are vigorously defending ourselves and believe that we have a number of meritorious legal defenses; and (2) there are unresolved questions of law and fact that could be important to the ultimate resolution of this matter.

In February 2018, the Turkish Competition Authority ("Authority") opened an investigation into nine companies in the small package industry, including UPS, related to alleged customer allocations in violation of Turkish competition law. In April 2018, the Authority consolidated this investigation with two other investigations involving similar allegations. The consolidated investigation involves over 30 companies. In January 2020, the Authority held a hearing and announced a summary decision, finding an infringement and imposing an immaterial fine on UPS. We do not believe that any loss associated with this matter will have a material adverse effect on our financial condition, results of operations or liquidity.

We are a party in various other matters that arose in the normal course of business. We do not believe that the eventual resolution of these other matters (either individually or in the aggregate), including any reasonably possible losses in excess of current accruals, will have a material adverse effect on our financial condition, results of operations or liquidity.

NOTE 10. LEASES

We adopted ASU 2016-02, *Leases (Topic 842)*, on January 1, 2019. The standard requires lessees to recognize a right-of-use ("ROU") asset and lease liability for all leases. Some of our leases contain both lease and non-lease components, which we have elected to treat as a single lease component. We have also elected not to recognize leases that have an original lease term, including reasonably certain renewal or purchase options, of twelve months or less in our consolidated balance sheets for all classes of underlying assets. Lease costs for short-term leases are recognized on a straight-line basis over the lease term. We elected the package of transition practical expedients for existing contracts, which allowed us to carry forward our historical assessments of whether contracts are, or contain, leases, lease classification and determination of initial direct costs.

We lease property and equipment under finance and operating leases. We have finance and operating leases for package centers, airport facilities, warehouses, corporate office space, aircraft, aircraft engines, information technology equipment (primarily mainframes, servers and copiers), vehicles and various other equipment used in operating our business. Certain leases for real estate and aircraft contain options to purchase, extend or terminate the lease. Determining the lease term and amount of lease payments to include in the calculation of the ROU asset and lease liability for leases containing options requires the use of judgment to determine whether the exercise of an option is reasonably certain, and if the optional period and payments should be included in the calculation of the associated ROU asset and liability. In making this determination, we consider all relevant economic factors that would compel us to exercise or not exercise an option.

When our leases contain future payments that are dependent on an index or rate, such as the consumer price index, we initially measure the lease liability and ROU asset using the index or rate at the commencement date. In subsequent periods, lease payments dependent on an index or rate are not remeasured. Rather, changes to payments due to a change in an index or rate are recognized in our statements of consolidated income in the period of the change.

When available, we use the rate implicit in the lease to discount lease payments; however, the rate implicit in the lease is not readily determinable for substantially all of our leases. For these leases, we use an estimate of our incremental borrowing rate to discount lease payments based on information available at lease commencement. The incremental borrowing rate is derived using multiple inputs including our credit rating, the impact of full collateralization, lease term and denominated currency. The remaining lease terms vary from 1 month to 190 years.

Aircraft

In addition to the aircraft that we own, we have leases for 342 aircraft. Of these leased aircraft, 31 are classified as finance leases, 14 are classified as operating leases and the remaining 297 are classified as short-term leases. A majority of the obligations associated with the aircraft classified as finance leases have been legally defeased. Most of our long-term aircraft operating leases are operated by a third party to handle package and cargo volume in geographic regions where, due to government regulations, we are restricted from operating an airline.

In order to meet customers' needs, we charter aircraft to handle package and cargo volume on certain international trade lanes and domestic routes. Due to the nature of these agreements, primarily being that either party can cancel the agreement with short notice, we have classified these as short-term leases. Additionally, all of the lease payments associated with these charter agreements are variable in nature based on the number of hours flown.

Real Estate

We have operating and finance leases for package centers, airport facilities, warehouses, corporate office space and expansion facilities utilized during peak shipping periods. Many of our leases contain charges for common area maintenance or other miscellaneous expenses that are updated based on landlord estimates. Due to this variability, the cash flows associated with these charges are not included in the minimum lease payments used in determining the ROU asset and associated lease liability.

Some of our real estate leases contain options to renew or extend the lease or terminate the lease before the expiration date. These options are factored into the determination of the lease term and lease payments when their exercise is considered to be reasonably certain.

We also enter into real estate leases that contain lease incentives, such as tenant improvement allowances or move-in allowances, that are received or receivable at lease commencement. These incentives reduce lease payments for classification purposes and reduce the initial ROU asset. When lease incentives are receivable at lease commencement, they also reduce the initial lease liability.

From time to time, we enter into leases with the intention of purchasing the property, either through purchase options with a fixed price or a purchase agreement negotiated contemporaneously with the lease agreement. We classify these leases as finance leases and include the purchase date and purchase price in the lease term and lease payments, respectively, when the option to exercise or purchase is reasonably certain.

Transportation and other equipment

We enter into both long-term and short-term leases for transportation equipment to supplement our capacity or meet contractual demands. Some of these assets are leased on a month-to-month basis and the leases can be terminated without penalty. The lease term for these types of leases is determined by the length of the underlying customer contract or based on the judgment of the business unit. We also enter into multi-year leases for trailers to increase capacity during periods of high demand, which are typically only used for 90-120 days during the year. These leases are treated as short-term as the cumulative right-of-use is less than 12 months over the term of the contract.

The remainder of our leases are primarily related to equipment used in our air operations, vehicles required to meet capacity needs during periods of higher demand for our shipping services, technology equipment and office equipment used in our facilities.

Some of our transportation and technology equipment leases require us to make additional lease payments based on the underlying usage of the assets. Due to the variable nature of these costs, these are expensed as incurred and are not included in the ROU asset and lease liability.

The components of lease expense for the year ended December 31, 2019 are as follows (in millions):

	Year Ended December 31,	
	2019	
Operating lease costs	\$	643
Finance lease costs:		
Amortization of assets	\$	73
Interest on lease liabilities		19
Total finance lease costs		92
Variable lease costs		206
Short-term lease costs		1,122
Total lease costs	\$	2,063

Supplemental information related to leases and location within our consolidated balance sheets are as follows (in millions, except lease term and discount rate):

	<u>December 31, 2019</u>
Operating Leases:	
Operating lease right-of-use assets	\$ 2,856
Current maturities of operating leases	\$ 538
Non-current operating leases	2,391
Total operating lease liabilities	<u>\$ 2,929</u>
Finance Leases:	
Aircraft	\$ 2,087
Buildings	272
Vehicles, plant equipment, technology equipment and other	27
Accumulated amortization	(884)
Property, plant and equipment, net	<u>\$ 1,502</u>
Current maturities of long-term debt, commercial paper and finance leases	\$ 181
Long-term debt and finance leases	317
Total finance lease liabilities	<u>\$ 498</u>
Weighted average remaining lease term (in years):	
Operating leases	9.7
Finance leases	8.9
Weighted average discount rate:	
Operating leases	2.78%
Finance leases	4.03%

Supplemental cash flow information related to leases is as follows (in millions):

	<u>Year Ended December 31,</u> <u>2019</u>
Cash paid for amounts included in measurement of liabilities:	
Operating cash flows from operating leases	\$ 620
Operating cash flows from finance leases	19
Financing cash flows from finance leases	140
Right-of-use assets obtained in exchange for lease liabilities:	
Operating leases	\$ 810
Finance leases	\$ 110

Maturities of lease liabilities as of December 31, 2019 are as follows (in millions):

	Finance Leases	Operating Leases
2020	\$ 199	\$ 619
2021	44	536
2022	39	451
2023	37	360
2024	35	256
Thereafter	259	1,267
Total lease payments	613	3,489
Less: Imputed interest	(115)	(560)
Total lease obligations	498	2,929
Less: Current obligations	(181)	(538)
Long-term lease obligations	\$ 317	\$ 2,391

As of December 31, 2019, we have additional leases which have not commenced. These leases will commence when we are granted access to the property, such as when leasehold improvements are completed by the lessor or a certificate of occupancy is obtained. These leases will commence in 2020.

Disclosures related to periods prior to adoption of the new lease standard

Rent expense related to our operating leases was \$959 and \$804 million for 2018 and 2017, respectively. The following table sets forth the aggregate minimum lease payments under capital and operating leases as of December 31, 2018 (in millions):

	Capital Leases	Operating Leases
2019	\$ 158	\$ 578
2020	95	477
2021	42	399
2022	39	325
2023	36	262
After 2023	293	926
Total lease payments	663	2,967
Less: Imputed interest	(129)	
Total lease obligations	534	
Less: Current obligations	(140)	
Long-term lease obligations	\$ 394	

NOTE 11. SHAREOWNERS' EQUITY

Capital Stock, Additional Paid-In Capital and Retained Earnings

We maintain two classes of common stock, which are distinguished from each other by their respective voting rights. Class A shares of UPS are entitled to 10 votes per share, whereas class B shares are entitled to one vote per share. Class A shares are primarily held by UPS employees and retirees, as well as trusts and descendants of the Company's founders, and these shares are fully convertible into class B shares at any time. Class B shares are publicly traded on the New York Stock Exchange ("NYSE") under the symbol "UPS". Class A and B shares both have a \$0.01 par value, and as of December 31, 2019, there were 4.6 billion class A shares and 5.6 billion class B shares authorized to be issued. Additionally, there are 200 million preferred shares authorized to be issued, with a par value of \$0.01 per share. As of December 31, 2019, no preferred shares had been issued.

The following is a rollforward of our common stock, additional paid-in capital, retained earnings and non-controlling interests accounts for the year ended December 31, 2019, 2018 and 2017 (in millions, except per share amounts):

Year Ended December 31:	2019		2018		2017	
	Shares	Dollars	Shares	Dollars	Shares	Dollars
Class A Common Stock:						
Balance at beginning of year	163	\$ 2	173	\$ 2	180	\$ 2
Common stock purchases	(3)	—	(3)	—	(4)	—
Stock award plans	5	—	3	—	4	—
Common stock issuances	3	—	4	—	3	—
Conversions of class A to class B common stock	(12)	—	(14)	—	(10)	—
Class A shares issued at end of year	<u>156</u>	<u>\$ 2</u>	<u>163</u>	<u>\$ 2</u>	<u>173</u>	<u>\$ 2</u>
Class B Common Stock:						
Balance at beginning of year	696	\$ 7	687	\$ 7	689	\$ 7
Common stock purchases	(7)	—	(5)	—	(12)	—
Conversions of class A to class B common stock	12	—	14	—	10	—
Class B shares issued at end of year	<u>701</u>	<u>\$ 7</u>	<u>696</u>	<u>\$ 7</u>	<u>687</u>	<u>\$ 7</u>
Additional Paid-In Capital:						
Balance at beginning of year		\$ —		\$ —		\$ —
Stock award plans		778		419		396
Common stock purchases		(1,005)		(859)		(813)
Common stock issuances		356		406		363
Option premiums received (paid)		21		34		54
Balance at end of year		<u>\$ 150</u>		<u>\$ —</u>		<u>\$ —</u>
Retained Earnings:						
Balance at beginning of year		\$ 8,006		\$ 5,852		\$ 4,880
Net income attributable to controlling interests		4,440		4,791		4,905
Dividends (\$3.84, \$3.64, and \$3.32 per share) ⁽¹⁾		(3,341)		(3,189)		(2,928)
Common stock purchases		—		(141)		(1,003)
Reclassification from AOCI pursuant to the early adoption of ASU 2018-02		—		735		—
Other		—		(42)		(2)
Balance at end of year		<u>\$ 9,105</u>		<u>\$ 8,006</u>		<u>\$ 5,852</u>
Non-Controlling Interests						
Balance at beginning of year		\$ 16		\$ 30		\$ 24
Change in non-controlling interests		—		(14)		6
Balance at end of year		<u>\$ 16</u>		<u>\$ 16</u>		<u>\$ 30</u>

⁽¹⁾ The dividend per share amount is the same for both class A and class B common stock. Dividends include \$147, \$178 and \$157 million for 2019, 2018 and 2017, respectively, that were settled in shares of class A common stock.

In May 2016, the Board of Directors approved a share repurchase authorization of \$8.0 billion for shares of class A and class B common stock, which has no expiration date. As of December 31, 2019, we had 2.334 billion of this share repurchase authorization available.

Share repurchases may be in the form of accelerated share repurchase programs, open market purchases or other such methods as we deem appropriate. The timing of share repurchases will depend upon market conditions. Unless terminated earlier by the Board, the program will expire when we have purchased all shares authorized for repurchase under the program.

For the years ended December 31, 2019, 2018 and 2017, we repurchased a total of 9.1, 8.9 and 16.1 million shares of class A and class B common stock for \$1.005, \$1.000 and \$1.816 billion, respectively (\$1.004, \$1.011 and \$1.813 billion in repurchases for 2019, 2018 and 2017, respectively, are reported on the cash flow statement due to the timing of settlements).

From time to time, we enter into share repurchase programs with large financial institutions to assist in our buyback of company stock. These programs may allow us to repurchase our shares at a price below the weighted average UPS share price for a given period. We did not enter into any such program during the years ended December 31, 2019, 2018 or 2017.

In order to lower the average cost of acquiring shares in our ongoing share repurchase program, we periodically enter into structured repurchase agreements involving the use of capped call options for the purchase of UPS class B shares. We pay a fixed sum of cash upon execution of each agreement in exchange for the right to receive either a pre-determined amount of cash or stock. Upon expiration of each agreement, if the closing market price of our common stock is above the pre-determined price, we will have our initial investment returned with a premium in either cash or shares (at our election). If the closing market price of our common stock is at or below the pre-determined price, we will receive the number of shares specified in the agreement. We received net premiums of \$21, \$34 and \$54 million during the years ended December 31, 2019, 2018 and 2017, respectively, related to entering into and settling capped call options for the purchase of class B shares. As of December 31, 2019, we had no capped call options outstanding.

Accumulated Other Comprehensive Income (Loss)

We recognize activity in AOCI for unrealized holding gains and losses on available-for-sale securities, foreign currency translation adjustments, unrealized gains and losses from derivatives that qualify as hedges of cash flows and unrecognized pension and postretirement benefit costs. Additionally, effective January 1, 2018, we adopted an ASU that allows a reclassification from AOCI to retained earnings for stranded tax effects resulting from the Tax Act (see note 1 for further information). The activity in AOCI for the years ended December 31, 2019, 2018 and 2017 is as follows (in millions):

Year Ended December 31:	2019	2018	2017
Foreign Currency Translation Gain (Loss), Net of Tax:			
Balance at beginning of year	\$ (1,126)	\$ (930)	\$ (1,016)
Translation adjustment (net of tax effect of \$10, \$37 and \$(161))	48	(149)	86
Reclassification to retained earnings pursuant to the early adoption of ASU 2018-02	—	(47)	—
Balance at end of year	<u>\$ (1,078)</u>	<u>\$ (1,126)</u>	<u>\$ (930)</u>
Unrealized Gain (Loss) on Marketable Securities, Net of Tax:			
Balance at beginning of year	\$ (2)	\$ (2)	\$ (1)
Current period changes in fair value (net of tax effect of \$4, \$(1) and \$(1))	11	(3)	(2)
Reclassification to earnings (net of tax effect of \$(1), \$1 and \$1)	(5)	3	1
Balance at end of year	<u>\$ 4</u>	<u>\$ (2)</u>	<u>\$ (2)</u>
Unrealized Gain (Loss) on Cash Flow Hedges, Net of Tax:			
Balance at beginning of year	\$ 40	\$ (366)	\$ (45)
Current period changes in fair value (net of tax effect of \$61, \$135 and \$(190))	195	429	(316)
Reclassification to retained earnings pursuant to the early adoption of ASU 2018-02	—	(79)	—
Reclassification to earnings (net of tax effect of \$(39), \$18 and \$(3))	(123)	56	(5)
Balance at end of year	<u>\$ 112</u>	<u>\$ 40</u>	<u>\$ (366)</u>
Unrecognized Pension and Postretirement Benefit Costs, Net of Tax:			
Balance at beginning of year	\$ (3,906)	\$ (3,569)	\$ (3,421)
Reclassification to earnings (net of tax effect of \$626, \$439 and \$269)	1,988	1,389	731
Reclassification to retained earnings pursuant to the early adoption of ASU 2018-02	—	(609)	—
Net actuarial gain (loss) and prior service cost resulting from remeasurements of plan assets and liabilities (net of tax effect of \$(979), \$(355) and \$(180))	(3,117)	(1,117)	(879)
Balance at end of year	<u>\$ (5,035)</u>	<u>\$ (3,906)</u>	<u>\$ (3,569)</u>
Accumulated other comprehensive income (loss) at end of year	<u>\$ (5,997)</u>	<u>\$ (4,994)</u>	<u>\$ (4,867)</u>

Detail of the gains (losses) reclassified from AOCI to the statements of consolidated income for the years ended December 31, 2019, 2018 and 2017 is as follows (in millions):

Year Ended December 31:	Amount Reclassified from AOCI			Affected Line Item in the Income Statement
	2019	2018	2017	
Unrealized Gain (Loss) on Marketable Securities:				
Realized gain (loss) on sale of securities	6	(4)	(2)	Investment income (expense) and other
Income tax (expense) benefit	(1)	1	1	Income tax expense
Impact on net income	5	(3)	(1)	Net income
Unrealized Gain (Loss) on Cash Flow Hedges:				
Interest rate contracts	(15)	(24)	(27)	Interest expense
Foreign exchange contracts	177	(50)	35	Revenue
Income tax (expense) benefit	(39)	18	(3)	Income tax expense
Impact on net income	123	(56)	5	Net income
Unrecognized Pension and Postretirement Benefit Costs:				
Prior service costs	(227)	(201)	(200)	Investment income (expense) and other
Remeasurement of benefit obligation	(2,387)	(1,627)	(800)	Investment income (expense) and other
Income tax (expense) benefit	626	439	269	Income tax expense
Impact on net income	(1,988)	(1,389)	(731)	Net income
Total amount reclassified for the year	<u>\$ (1,860)</u>	<u>\$ (1,448)</u>	<u>\$ (727)</u>	Net income

Deferred Compensation Obligations and Treasury Stock

We maintain a deferred compensation plan whereby certain employees were previously able to elect to defer the gains on stock option exercises by deferring the shares received upon exercise into a rabbi trust. The shares held in this trust are classified as treasury stock, and the liability to participating employees is classified as “Deferred compensation obligations” in the shareowners’ equity section of the consolidated balance sheets. The number of shares needed to settle the liability for deferred compensation obligations is included in the denominator in both the basic and diluted earnings per share calculations. Employees are generally no longer able to defer the gains from stock options exercised subsequent to December 31, 2004.

Activity in the deferred compensation program for the years ended December 31, 2019, 2018 and 2017 is as follows (in millions):

Year Ended December 31:	2019		2018		2017	
	Shares	Dollars	Shares	Dollars	Shares	Dollars
Deferred Compensation Obligations:						
Balance at beginning of year		\$ 32		\$ 37		\$ 45
Reinvested dividends		2		2		2
Benefit payments		(8)		(7)		(10)
Balance at end of year		<u>\$ 26</u>		<u>\$ 32</u>		<u>\$ 37</u>
Treasury Stock:						
Balance at beginning of year	(1)	\$ (32)	(1)	\$ (37)	(1)	\$ (45)
Reinvested dividends	—	(2)	—	(2)	—	(2)
Benefit payments	1	8	—	7	—	10
Balance at end of year	<u>—</u>	<u>\$ (26)</u>	<u>(1)</u>	<u>\$ (32)</u>	<u>(1)</u>	<u>\$ (37)</u>

NOTE 12. STOCK - BASED COMPENSATION

The UPS Incentive Compensation Plan permits the grant of non-qualified and incentive stock options, stock appreciation rights, restricted stock and stock units, and restricted performance shares and units to eligible employees. On May 14, 2018 our shareholders approved our 2018 Omnibus Incentive Compensation Plan under which we are authorized to issue an additional 26 million shares. Each share issued in the form of restricted stock units and restricted performance units (collectively referred to as "Restricted Units"), stock options and other permitted awards reduces the share reserve by one share. We had 13 million shares available to be issued under the Incentive Compensation Plan as of December 31, 2019.

The primary compensation programs offered under the UPS Incentive Compensation Plan include the UPS Management Incentive Award program, the Coyote Restricted Stock Award, the UPS Long-Term Incentive Performance Award program and the UPS Stock Option program. These awards are discussed in the following paragraphs. The total expense recognized in our income statement under all stock compensation award programs was \$915, \$634 and \$584 million during 2019, 2018 and 2017, respectively. The associated income tax benefit recognized in our statements of consolidated income was \$216, \$186 and \$227 million during 2019, 2018 and 2017, respectively. The cash income tax benefit received from the exercise of stock options and the lapsing of Restricted Units was \$148, \$175 and \$276 million during 2019, 2018 and 2017, respectively.

Management Incentive Award Program ("MIP")

Non-executive management earning the right to receive MIP awards is determined annually by the Salary Committee, which is comprised of executive officers of UPS. Awards granted to executive officers are determined annually by the Compensation Committee of the UPS Board of Directors. Our MIP provides, with certain exceptions, that one-half to two-thirds of the annual award will be made in Restricted Units, depending upon the level of management involved. The remaining one-third to one-half of the award is electable in the form of cash or unrestricted shares of class A common stock, and is fully vested at the time of grant.

Upon vesting, Restricted Units result in the issuance of the equivalent number of UPS class A common shares after required tax withholdings. Except in the case of death, Restricted Units granted under the MIP prior to 2019 vest over a five-year period with approximately 20% of the award vesting at each anniversary date of the grant. The grant value, less estimated forfeitures, is expensed on a straight-line basis over the requisite service period, except in the case of death, disability or retirement, in which case immediate expensing occurs. These historical awards will continue to vest through 2023.

Beginning with the MIP award in the first quarter of 2019, Restricted Units vest one year following the grant date, except in the case of death, disability or retirement, in which case immediate vesting occurs. The grant value, less estimated forfeitures, is expensed on a straight-line basis over the requisite service period, except in the case of death, disability or retirement, in which case immediate expensing occurs. All Restricted Units granted are subject to early cancellation or vesting under certain conditions. Dividends earned on Restricted Units are reinvested in additional Restricted Units at each dividend payable date until they have fully vested.

Coyote Restricted Stock Award

In August 2015 we acquired Coyote, a U.S.-based truckload brokerage company. During the third quarter of 2015, we granted Restricted Units to eligible Coyote management employees. The vesting of Restricted Units granted under this award varied between one and four years with an equal number of restricted units vesting at each anniversary date, except in the case of death or disability, in which case immediate vesting occurred. The entire grant was expensed on a straight-line basis over the requisite service period, except in the case of death or disability, in which case immediate expensing occurred. All Restricted Units granted under this award had vested as of December 31, 2019.

As of December 31, 2019, we had the following outstanding Restricted Units, including reinvested dividends, granted under the MIP:

	Shares (in thousands)	Weighted-Average Grant Date Fair Value	Weighted-Average Remaining Contractual Term (in years)	Aggregate Intrinsic Value (in millions)
Nonvested at January 1, 2019	10,139	\$ 104.47		
Vested	(5,100)	102.54		
Granted	5,516	108.78		
Reinvested Dividends	410	N/A		
Forfeited / Expired	(226)	107.22		
Nonvested at December 31, 2019	10,739	\$ 106.94	0.71	\$ 1,257
Restricted Units Expected to Vest	12,690	\$ 106.59	0.74	\$ 1,485

The fair value of each Restricted Unit is the NYSE closing price of class B common stock on the date of grant. The weighted-average grant date fair value of Restricted Units granted during 2019, 2018 and 2017 was \$108.78, \$110.95 and \$105.62, respectively. The total fair value of Restricted Units vested was \$457, \$596 and \$534 million in 2019, 2018 and 2017, respectively. As of December 31, 2019, there was \$341 million of total unrecognized compensation cost related to nonvested Restricted Units. That cost is expected to be recognized over a weighted-average period of two years and one month.

Long-Term Incentive Performance ("LTIP") Program

We award Restricted Units in conjunction with our LTIP program to certain eligible employees. Performance targets are equally-weighted among consolidated operating return on invested capital, growth in currency-constant consolidated revenue and total shareholder return relative to a peer group of companies ("RTSR"). The Restricted Units granted under this award vest at the end of a three-year period, except in the case of death, disability or retirement, in which case immediate vesting occurs on a prorated basis. The number of Restricted Units earned will be based on the percentage achievement of the performance targets set forth on the grant date. The range of percentage achievement can vary from 0% to 200% of the target award.

For the two-thirds of the award related to consolidated operating return on invested capital and growth in currency-constant consolidated revenue, we recognize the grant date fair value of these units, less estimated forfeitures, as compensation expense ratably over the vesting period, based on the number of awards expected to be earned. The remaining one-third of the award related to RTSR is valued using a Monte Carlo model. This portion of the award, less estimated forfeitures, is recognized as compensation expense ratably over the vesting period.

The weighted-average assumptions used by year, and the calculated weighted-average fair values of the RTSR portion of the grants, are as follows:

	2019	2018	2017
Risk-free interest rate	2.23%	2.61%	1.46%
Expected volatility	19.64%	16.51%	16.59%
Weighted-average fair value of units granted	\$ 123.44	\$ 137.57	\$ 119.29
Share payout	115.04%	123.47%	113.55%

There is no expected dividend yield as units earn dividend equivalents.

As of December 31, 2019, we had the following Restricted Units outstanding, including reinvested dividends, that were granted under our LTIP program:

	Shares (in thousands)	Weighted-Average Grant Date Fair Value	Weighted-Average Remaining Contractual Term (in years)	Aggregate Intrinsic Value (in millions)
Nonvested at January 1, 2019	1,701	\$ 108.63		
Vested	(898)	106.12		
Granted	974	107.30		
Reinvested Dividends	83	N/A		
Forfeited / Expired	(169)	108.60		
Nonvested at December 31, 2019	1,691	\$ 109.18	1.54	\$ 198
Restricted Units Expected to Vest	1,677	\$ 109.16	1.55	\$ 196

The fair value of each Restricted Unit is the NYSE closing price of class B common stock on the date of grant. The weighted-average grant date fair value of Restricted Units granted during 2019, 2018 and 2017 was \$107.30, \$111.42 and \$105.65, respectively. The total fair value of Restricted Units vested was \$71, \$97 and \$71 million in 2019, 2018 and 2017, respectively. As of December 31, 2019, there was \$103 million of total unrecognized compensation cost related to nonvested Restricted Units. That cost is expected to be recognized over a weighted-average period of one year and eight months.

Non-qualified Stock Options

We maintain stock option plans, under which options are granted to purchase shares of UPS class A common stock. Stock options granted in connection with the UPS Incentive Compensation Plan must have an exercise price at least equal to the NYSE closing price of UPS class B common stock on the date the option is granted.

Executive officers and certain senior managers receive a non-qualified stock option grant annually, in which the value granted is determined as a percentage of salary. Options granted generally vest over a five-year period with approximately 20% of the award vesting at each anniversary date of the grant. All options granted are subject to earlier cancellation or vesting under certain conditions. The options granted will expire ten years after the date of the grant. Option holders may exercise their options via the payment of cash or class A common stock and new class A shares are issued upon exercise.

The following is an analysis of options to purchase shares of class A common stock issued and outstanding:

	Shares (in thousands)	Weighted-Average Exercise Price	Weighted-Average Remaining Contractual Term (in years)	Aggregate Intrinsic Value (in millions)
Outstanding at January 1, 2019	1,384	\$ 95.36		
Exercised	(147)	69.33		
Granted	261	111.68		
Forfeited / Expired	—	—		
Outstanding at December 31, 2019	1,498	\$ 100.74	6.37	\$ 24
Options Vested and Expected to Vest	1,498	\$ 100.74	6.37	\$ 24
Exercisable at December 31, 2019	915	\$ 96.12	5.25	\$ 19

The fair value of each option grant is estimated using the Black-Scholes option pricing model. The weighted-average assumptions used, by year, and the calculated weighted-average fair values of options, are as follows:

	2019	2018	2017
Expected dividend yield	2.94%	2.93%	2.89%
Risk-free interest rate	2.60%	2.84%	2.15%
Expected life in years	7.5	7.5	7.5
Expected volatility	17.79%	16.72%	17.81%
Weighted-average fair value of options granted	\$ 16.34	\$ 15.23	\$ 14.70

Expected volatilities are based on the historical returns on our stock and the implied volatility of our publicly-traded options. The expected dividend yield is based on the recent historical dividend yields for our stock, taking into account changes in dividend policy. The risk-free interest rate is based on the term structure of interest rates at the time of the option grant. The expected life represents an estimate of the period of time options are expected to remain outstanding, and we have relied upon a combination of the observed exercise behavior of our prior grants with similar characteristics, the vesting schedule of the grants and an index of peer companies with similar grant characteristics in estimating this variable.

We received cash of \$7, \$12 and \$41 million during 2019, 2018 and 2017, respectively, from option holders resulting from the exercise of stock options. The total intrinsic value of options exercised during 2019, 2018 and 2017 was \$5, \$6 and \$22 million, respectively. As of December 31, 2019, there was \$2 million of total unrecognized compensation cost related to nonvested options. That cost is expected to be recognized over a weighted-average period of three years and five months.

The following table summarizes information about stock options outstanding and exercisable at December 31, 2019:

Exercise Price Range	Options Outstanding			Options Exercisable		
	Shares (in thousands)	Weighted-Average Remaining Contractual Term (in years)	Weighted-Average Exercise Price	Shares (in thousands)	Weighted-Average Exercise Price	
\$65.01 - \$80.00	157	1.52	\$ 74.06	157	\$ 74.06	
\$80.01 - \$95.00	100	3.17	82.89	100	82.89	
\$95.01 - \$110.00	985	6.75	103.93	635	103.09	
\$110.01 - \$125.00	256	9.13	111.80	23	111.80	
	<u>1,498</u>	<u>6.37</u>	<u>\$ 100.74</u>	<u>915</u>	<u>\$ 96.12</u>	

Discounted Employee Stock Purchase Plan

We maintain an employee stock purchase plan for all eligible employees. Under this plan, shares of UPS class A common stock may be purchased at quarterly intervals at 95% of the NYSE closing price of UPS class B common stock on the last day of each quarterly period. Employees purchased 1, 0.9 and 0.9 million shares at average prices of \$102.11, \$105.53 and \$108.98 per share, during 2019, 2018 and 2017, respectively. This plan is not considered to be compensatory, and therefore no compensation cost is measured for the employees' purchase rights.

NOTE 13. SEGMENT AND GEOGRAPHIC INFORMATION

We report our operations in three segments: U.S. Domestic Package operations, International Package operations and Supply Chain & Freight operations. Package operations represent our most significant business and are broken down into regional operations around the world. Regional operations managers are responsible for both domestic and export products within their geographic area.

U.S. Domestic Package

Domestic Package operations include the time-definite delivery of letters, documents and packages throughout the United States.

International Package

International Package operations include delivery to more than 220 countries and territories worldwide, including shipments wholly outside the United States, as well as shipments with either origin or destination outside the United States. Our International Package reporting segment includes the operations of our Europe, Asia, Americas and ISMEA operating segments.

Supply Chain & Freight

Supply Chain & Freight includes our Forwarding, Logistics, Coyote, Marken, UPS Mail Innovations, UPS Freight and other aggregated business units. Our Forwarding, Logistics and UPS Mail Innovations units provide services in more than 200 countries and territories worldwide and include international air and ocean freight forwarding, customs brokerage, distribution and post-sales services, mail and consulting services. UPS Freight offers a variety of less-than-truckload and truckload services to customers in North America. Coyote offers truckload brokerage services primarily in the United States. Marken is a global provider of supply chain solutions to the healthcare and life sciences industry. Other aggregated business units within this segment include The UPS Store and UPS Capital.

In evaluating financial performance, we focus on operating profit as a segment's measure of profit or loss. Operating profit is before investment income (expense) and other, interest expense and income taxes. The accounting policies of the segments are the same as those described in the "Supplemental Information - Items Affecting Comparability" section of Management's Discussion and Analysis, with certain expenses allocated between the segments using activity-based costing methods. As we operate an integrated, global multimodal network, we evaluate many of our capital expenditure decisions at a network level. Accordingly, expenditures on property, plant and equipment by segment are not presented. Unallocated assets are comprised primarily of cash, marketable securities and certain investment partnerships. In 2018, we changed the segment allocation methodology for certain shared assets. All prior periods have been recast to reflect this change in methodology.

Segment information for the years ended December 31, 2019, 2018 and 2017 is as follows (in millions):

	2019	2018	2017
Revenue:			
U.S. Domestic Package	\$ 46,493	\$ 43,593	\$ 40,761
International Package	14,220	14,442	13,342
Supply Chain & Freight	13,381	13,826	12,482
Consolidated	<u>\$ 74,094</u>	<u>\$ 71,861</u>	<u>\$ 66,585</u>
Operating Profit:			
U.S. Domestic Package	\$ 4,164	\$ 3,643	\$ 4,303
International Package	2,657	2,529	2,429
Supply Chain & Freight	977	852	797
Consolidated	<u>\$ 7,798</u>	<u>\$ 7,024</u>	<u>\$ 7,529</u>
Assets:			
U.S. Domestic Package	\$ 32,795	\$ 28,216	\$ 25,449
International Package	14,044	12,070	10,361
Supply Chain & Freight	9,045	8,411	8,267
Unallocated	1,973	1,319	1,497
Consolidated	<u>\$ 57,857</u>	<u>\$ 50,016</u>	<u>\$ 45,574</u>
Depreciation and Amortization Expense:			
U.S. Domestic Package	\$ 1,520	\$ 1,375	\$ 1,479
International Package	547	526	509
Supply Chain & Freight	293	306	294
Consolidated	<u>\$ 2,360</u>	<u>\$ 2,207</u>	<u>\$ 2,282</u>

Revenue by product type for the years ended December 31, 2019, 2018 and 2017 is as follows (in millions):

	2019	2018	2017
U.S. Domestic Package:			
Next Day Air	\$ 8,479	\$ 7,618	\$ 7,088
Deferred	5,180	4,752	4,422
Ground	32,834	31,223	29,251
Total U.S. Domestic Package	<u>46,493</u>	<u>43,593</u>	<u>40,761</u>
International Package:			
Domestic	2,836	2,874	2,646
Export	10,837	10,973	10,170
Cargo	547	595	526
Total International Package	<u>14,220</u>	<u>14,442</u>	<u>13,342</u>
Supply Chain & Freight:			
Forwarding	5,867	6,580	5,674
Logistics	3,435	3,234	3,017
Freight	3,265	3,218	3,000
Other	814	794	791
Total Supply Chain & Freight	<u>13,381</u>	<u>13,826</u>	<u>12,482</u>
Consolidated	<u>\$ 74,094</u>	<u>\$ 71,861</u>	<u>\$ 66,585</u>

Geographic information for the years ended December 31, 2019, 2018 and 2017 is as follows (in millions):

	2019	2018	2017
United States:			
Revenue	\$ 58,699	\$ 56,115	\$ 52,080
Long-lived assets	\$ 27,976	\$ 24,918	\$ 21,141
International:			
Revenue	\$ 15,395	\$ 15,746	\$ 14,505
Long-lived assets	\$ 9,567	\$ 8,577	\$ 7,966
Consolidated:			
Revenue	\$ 74,094	\$ 71,861	\$ 66,585
Long-lived assets	\$ 37,543	\$ 33,495	\$ 29,107

Long-lived assets include property, plant and equipment, pension and postretirement benefit assets, long-term investments, goodwill and intangible assets.

No countries outside of the United States provided 10% or more of consolidated revenue for the years ended December 31, 2019, 2018 or 2017. For the year ended December 31, 2019, Amazon.com, Inc. and its affiliates ("Amazon") represented 11.6% of our consolidated revenues. Substantially all of this revenue was attributed to our U.S. Domestic Package segment. As of December 31, 2019, Amazon accounted for approximately 16.9% of accounts receivable, net, included within the consolidated balance sheets. No single customer represented 10% or more of our consolidated revenues for the years ended December 31, 2018 or 2017.

NOTE 14. INCOME TAXES

The income tax expense (benefit) for the years ended December 31, 2019, 2018 and 2017 consists of the following (in millions):

	2019	2018	2017
Current:			
U.S. Federal	\$ 570	\$ 89	\$ 671
U.S. State and Local	183	7	49
Non-U.S.	359	374	288
Total Current	<u>1,112</u>	<u>470</u>	<u>1,008</u>
Deferred:			
U.S. Federal	255	668	1,115
U.S. State and Local	(93)	75	118
Non-U.S.	(62)	15	(9)
Total Deferred	<u>100</u>	<u>758</u>	<u>1,224</u>
Total Income Tax Expense	<u>\$ 1,212</u>	<u>\$ 1,228</u>	<u>\$ 2,232</u>

Income before income taxes includes the following components (in millions):

	2019	2018	2017
United States	\$ 3,972	\$ 4,307	\$ 5,987
Non-U.S.	1,680	1,712	1,150
Total Income Before Income Taxes:	<u>\$ 5,652</u>	<u>\$ 6,019</u>	<u>\$ 7,137</u>

A reconciliation of the statutory federal income tax rate to the effective income tax rate for the years ended December 31, 2019, 2018 and 2017 consists of the following:

	2019	2018	2017
Statutory U.S. federal income tax rate	21.0%	21.0%	35.0%
U.S. state and local income taxes (net of federal benefit)	1.4	1.4	1.5
Non-U.S. tax rate differential	0.3	0.2	(2.0)
U.S. federal tax credits	(1.4)	(1.1)	(1.8)
Income tax benefit from the Tax Cuts and Jobs Act and other non-U.S. tax law changes	—	—	(3.6)
Defined benefit plans mark-to-market charge tax rate differential ⁽¹⁾	—	—	1.5
Non-U.S. valuation allowance release	(1.2)	—	—
Other	1.3	(1.1)	0.7
Effective income tax rate	<u>21.4%</u>	<u>20.4%</u>	<u>31.3%</u>

⁽¹⁾ Impact of applying Tax Act corporate rate enacted of 21% versus 35%

Our effective tax rate is affected by recurring factors, such as statutory tax rates in the jurisdictions in which we operate and the relative amounts of taxable income we earn in those jurisdictions. It is also affected by discrete items that may occur in any given year, but may not be consistent from year to year.

Our effective tax rate was 21.4% in 2019, compared with 20.4% in 2018 and 31.3% in 2017, primarily due to the effects of the aforementioned recurring factors and the following discrete tax items.

Tax Cuts and Jobs Act

On December 22, 2017, the United States enacted into law the Tax Act. The Tax Act made broad and complex changes to the U.S. tax code, including a permanent corporate rate reduction to 21% and a transition to a territorial international system effective in 2018. The Tax Act includes provisions that affected 2017, including: (1) requiring a one-time transition tax on certain unrepatriated earnings of foreign subsidiaries ("Transition Tax") that is payable over eight years; (2) requiring a remeasurement of all U.S. deferred tax assets and liabilities to the newly enacted corporate tax rate of 21% and (3) providing for additional first-year depreciation that allows full expensing of qualified property placed into service after September 27, 2017.

In late December 2017, the SEC staff issued Staff Accounting Bulletin ("SAB") 118, which provided guidance on accounting for the tax effects of the Tax Act. SAB 118 provided a measurement period up to one year from the Tax Act enactment date for companies to complete the related accounting under GAAP. We recorded a \$272 million provisional benefit inclusive of our Transition Tax liability, the change in our indefinite reinvestment assertion for certain foreign subsidiaries and the remeasurement of our U.S. net deferred tax liabilities for the year ended December 31, 2017. During the fourth quarter of 2018, we completed our accounting for the Tax Act based on the current regulatory guidance available at the end of the SAB 118 measurement period and recorded no material net adjustments to our provisional estimate.

The Tax Act also enacted provisions that took effect in 2018 including but not limited to: (1) a provision that imposes U.S. tax on certain foreign subsidiary income known as GILTI, (2) a new deduction for Foreign-Derived Intangible Income ("FDII"), (3) additional limitations on tax deductions for expenses such as interest and executive compensation and (4) a new minimum tax based on certain payments from a U.S. company to foreign related parties known as the Base Erosion and Anti-Abuse Tax ("BEAT").

We included the impact of each of the newly effective Tax Act provisions in our computation of the 2018 and 2019 income tax expense. Throughout 2018 and 2019, the U.S. Department of the Treasury and IRS issued regulatory guidance clarifying certain provisions of the Tax Act, and we anticipate additional regulatory guidance and technical clarifications during future years. When additional guidance is issued, we will recognize the related tax impact in the quarter of enactment.

2019 Discrete Items

In the fourth quarter of 2019, we recognized an income tax benefit of \$571 million related to pre-tax mark-to-market losses of \$2.387 billion on our pension and postretirement defined benefit plans. This income tax benefit was generated at a higher average tax rate than the 2019 U.S. federal statutory tax rate because it included the effect of U.S. state and local and foreign taxes.

We recorded pre-tax transformation strategy costs of \$255 million during the year ended December 31, 2019. As a result, we recorded an additional income tax benefit of \$59 million. This income tax benefit was generated at a higher average tax rate than the 2019 U.S. federal statutory tax rate due to the effect of U.S. state and local and foreign taxes.

As discussed in note 9, \$97 million of legal contingencies and expenses were accrued during 2019 in respect of certain legal proceedings for which we recorded an additional income tax benefit of \$6 million. This income tax benefit was generated at a lower average tax rate than the U.S. federal statutory tax rate due to the portion of the accrual related to penalties, which are not deductible for tax purposes.

As of December 31, 2018, we maintained a valuation allowance against certain deferred tax assets, primarily related to foreign net operating loss carryforwards. As of each reporting date, we consider new evidence, both positive and negative, that could affect the future realization of deferred tax assets. During 2019, we determined that there is sufficient positive evidence to conclude that it is more likely than not that the deferred tax assets related to certain foreign net operating loss carryforwards will be realized. This conclusion is primarily related to achieving cumulative three-year income and anticipated future earnings within the relevant jurisdiction. Accordingly, we reversed the related valuation allowance and recognized a discrete tax benefit of approximately \$68 million.

Other factors that impacted our 2019 effective tax rate include favorable tax provisions enacted in the Taxpayer Certainty and Disaster Tax Relief Act of 2019.

2018 Discrete Items

The decrease in our effective tax rate from 2017 to 2018 was primarily due to the impact of the Tax Act which reduced the U.S. federal corporate income tax rate from 35% to 21% effective January 1, 2018.

In the fourth quarter of 2018, we recognized an income tax benefit of \$390 million related to pre-tax mark-to-market losses of \$1.627 billion on our pension and postretirement defined benefit plans. This income tax benefit was generated at a higher average tax rate than the 2018 U.S. federal statutory tax rate because it included the effect of U.S. state and local and foreign taxes.

We recorded pre-tax transformation strategy costs of \$360 million during the year ended December 31, 2018. As a result, we recorded an additional income tax benefit of \$87 million. This income tax benefit was generated at a higher average tax rate than the 2018 U.S. federal statutory tax rate due to the effect of U.S. state and local and foreign taxes.

The recognition of excess tax benefits and deficiencies related to share-based compensation in income tax expense resulted in a net tax benefit of \$38 million and reduced our effective tax rate by 0.6% during the year ended December 31, 2018.

Other factors that impacted our 2018 effective tax rate include favorable resolutions of uncertain tax positions, favorable U.S. state and local tax law changes, favorable tax provisions enacted in the Bipartisan Budget Act of 2018 and discrete tax credits associated with the filing of our 2017 U.S. federal income tax return.

2017 Discrete Items

In addition to the impact of the Tax Act described above, the following discrete items were recorded during the year ended December 31, 2017.

In the fourth quarter of 2017, we recognized an income tax benefit of \$193 million related to pre-tax mark-to-market losses of \$800 million on our pension and postretirement defined benefit plans. This income tax benefit was generated at a lower average tax rate than the 2017 U.S. federal statutory tax rate due to future tax rate changes enacted by the Tax Act and differences between U.S. and foreign statutory rates, which was partially offset by the effect of U.S. state and local taxes.

In the fourth quarter of 2017, tax law changes were enacted in certain non-U.S. jurisdictions in which we operate. As a result, we recorded a decrease to our foreign net deferred tax assets of \$14 million with a corresponding net increase to deferred tax expense of \$14 million.

In the first quarter of 2017, we adopted a new accounting standard that requires the recognition of excess tax benefits related to share-based compensation in income tax expense, which resulted in tax benefits for the year ended December 31, 2017 of \$71 million and reduced our effective tax rate by 1.0%.

Other Items

Beginning in 2012, we were granted a tax incentive for certain of our non-U.S. operations, which is effective through December 31, 2021. The tax incentive is conditional upon our meeting specific employment and investment thresholds. The impact of this tax incentive decreased non-U.S. tax expense by \$27 million, \$27 million and \$24 million (increased diluted earnings per share by \$0.03, \$0.03 and \$0.03) for 2019, 2018 and 2017, respectively.

Deferred income tax assets and liabilities are comprised of the following at December 31, 2019 and 2018 (in millions):

	2019	2018
Fixed assets and capitalized software	\$ (4,720)	\$ (4,010)
Operating lease right-of-use assets	(685)	—
Other	(538)	(493)
Deferred tax liabilities	(5,943)	(4,503)
Pension and postretirement benefits	2,522	1,743
Loss and credit carryforwards	328	298
Insurance reserves	413	437
Stock compensation	249	189
Accrued employee compensation	287	274
Operating lease liabilities	691	—
Other	205	196
Deferred tax assets	4,695	3,137
Deferred tax assets valuation allowance	(54)	(112)
Deferred tax asset (net of valuation allowance)	4,641	3,025
Net deferred tax asset (liability)	<u>\$ (1,302)</u>	<u>\$ (1,478)</u>

Amounts recognized in the consolidated balance sheets:

Deferred tax assets	\$ 330	\$ 141
Deferred tax liabilities	(1,632)	(1,619)
Net deferred tax asset (liability)	<u>\$ (1,302)</u>	<u>\$ (1,478)</u>

The valuation allowance changed by \$(58), \$(14) and \$(33) million during the years ended December 31, 2019, 2018 and 2017, respectively.

We have a U.S. federal capital loss carryforward of \$21 million as of December 31, 2019, \$20 million of which expires on December 31, 2021, and the remainder of which expires on December 31, 2022. In addition, we have U.S. federal tax credit carryforwards of \$3 million, which can be carried forward for periods ranging from ten years to twenty years.

Further, we have U.S. state and local operating loss and credit carryforwards as follows (in millions):

	2019	2018
U.S. state and local operating loss carryforwards	\$ 1,374	\$ 1,014
U.S. state and local credit carryforwards	\$ 110	\$ 80

The U.S. state and local operating loss carryforwards and credits can be carried forward for periods ranging from one year to indefinitely. We also have non-U.S. loss carryforwards of \$670 million as of December 31, 2019, the majority of which may be carried forward indefinitely. As indicated in the table above, we have established a valuation allowance for certain U.S. federal, state and non-U.S. carryforwards due to the uncertainty resulting from a lack of previous taxable income within the applicable tax jurisdictions and other limitations.

Undistributed earnings and profits ("E&P") of our foreign subsidiaries amounted to \$6.060 billion at December 31, 2019. As a result of the Tax Act, during the year ended December 31, 2017, we changed our indefinite reinvestment assertion with respect to the earnings of certain foreign subsidiaries. For all other foreign subsidiaries, we continue to assert that these earnings are indefinitely reinvested. \$1.597 billion of the undistributed E&P of our foreign subsidiaries is considered to be indefinitely reinvested and, accordingly, no deferred income taxes have been provided thereon. Upon distribution of those earnings in the form of dividends or otherwise, we would be subject to U.S. state and local taxes and withholding taxes payable in various jurisdictions. Determination of the amount of unrecognized deferred income tax liability is not practicable because of the complexities associated with its hypothetical calculation.

The following table summarizes the activity related to our uncertain tax positions (in millions):

	<u>Tax</u>	<u>Interest</u>	<u>Penalties</u>
Balance at January 1, 2017	\$ 144	\$ 50	\$ 6
Additions for tax positions of the current year	16	—	—
Additions for tax positions of prior years	33	14	3
Reductions for tax positions of prior years for:			
Changes based on facts and circumstances	(24)	(18)	—
Settlements during the period	(6)	(3)	—
Lapses of applicable statute of limitations	(3)	—	—
Balance at December 31, 2017	<u>160</u>	<u>43</u>	<u>9</u>
Additions for tax positions of the current year	47	—	1
Additions for tax positions of prior years	7	10	—
Reductions for tax positions of prior years for:			
Changes based on facts and circumstances	(43)	(8)	(5)
Settlements during the period	(1)	(1)	—
Lapses of applicable statute of limitations	(3)	—	—
Balance at December 31, 2018	<u>167</u>	<u>44</u>	<u>5</u>
Additions for tax positions of the current year	6	—	—
Additions for tax positions of prior years	51	13	—
Reductions for tax positions of prior years for:			
Changes based on facts and circumstances	(45)	(4)	(1)
Settlements during the period	(3)	(1)	—
Lapses of applicable statute of limitations	(4)	—	—
Balance at December 31, 2019	<u>\$ 172</u>	<u>\$ 52</u>	<u>\$ 4</u>

The total amount of gross uncertain tax positions as of December 31, 2019, 2018 and 2017 that, if recognized, would affect the effective tax rate was \$171, \$165 and \$159 million, respectively. Our continuing policy is to recognize interest and penalties associated with income tax matters as a component of income tax expense.

We file income tax returns in the U.S. federal jurisdiction, most U.S. state and local jurisdictions, and many non-U.S. jurisdictions. We have substantially resolved all U.S. federal income tax matters for tax years prior to 2015.

A number of years may elapse before an uncertain tax position is audited and ultimately settled. It is difficult to predict the ultimate outcome or the timing of resolution for uncertain tax positions. It is reasonably possible that the liability for uncertain tax positions could significantly increase or decrease within the next twelve months. Items that may cause changes to uncertain tax positions include the timing of interest deductions and the allocation of income and expense between tax jurisdictions. These changes could result from the settlement of ongoing litigation, the completion of ongoing examinations, the expiration of the statute of limitations, additional regulatory guidance on the Tax Act or other unforeseen circumstances. At this time, an estimate of the range of the reasonably possible change cannot be made.

NOTE 15. EARNINGS PER SHARE

The earnings per share amounts are the same for class A and class B common shares as the holders of each class are legally entitled to equal per share distributions whether through dividends or in liquidation.

The following table sets forth the computation of basic and diluted earnings per share (in millions, except per share amounts):

	<u>2019</u>	<u>2018</u>	<u>2017</u>
Numerator:			
Net income attributable to common shareowners	\$ 4,440	\$ 4,791	\$ 4,905
Denominator:			
Weighted-average shares	859	860	865
Deferred compensation obligations	—	1	1
Vested portion of restricted shares	5	5	5
Denominator for basic earnings per share	<u>864</u>	<u>866</u>	<u>871</u>
Effect of Dilutive Securities:			
Restricted performance units	5	4	3
Stock options	—	—	1
Denominator for diluted earnings per share	<u>869</u>	<u>870</u>	<u>875</u>
Basic Earnings Per Share	<u>\$ 5.14</u>	<u>\$ 5.53</u>	<u>\$ 5.63</u>
Diluted Earnings Per Share	<u>\$ 5.11</u>	<u>\$ 5.51</u>	<u>\$ 5.61</u>

Diluted earnings per share for the years ended December 31, 2019, 2018 and 2017 exclude the effect of 0.5, 0.2 and 0.1 million shares, respectively, of common stock that may be issued upon the exercise of employee stock options because such effect would be antidilutive.

NOTE 16. DERIVATIVE INSTRUMENTS AND RISK MANAGEMENT

Risk Management Policies

Changes in fuel prices, interest rates and foreign currency exchange rates impact our results of operations. These exposures are actively monitored by management. To manage the impact of these exposures, we enter into a variety of derivative financial instruments. Our objective is to manage, where it is deemed appropriate to do so, fluctuations in earnings and cash flows associated with changes in foreign currency rates, commodity prices and interest rates. It is our policy and practice to use derivative financial instruments only to the extent necessary to manage exposures. As we use price sensitive instruments to hedge a certain portion of our existing and anticipated transactions, we expect that any loss in value from those instruments generally would be offset by increases in the value of those hedged transactions. We do not hold or issue derivative financial instruments for trading or speculative purposes.

Credit Risk Management

The forward contracts, swaps and options discussed below contain an element of risk that the counterparties may be unable to meet the terms of the agreements; however, we seek to minimize such risk exposures for these instruments by limiting the counterparties to banks and financial institutions that meet established credit guidelines and by monitoring counterparties to prevent concentrations of credit risk with any single counterparty.

We have agreements with all of our active counterparties (covering the majority of our derivative positions) containing early termination rights and/or zero threshold bilateral collateral provisions whereby cash is required based on the net fair value of derivatives associated with those counterparties.

At December 31, 2019 and 2018, we held cash collateral of \$495 and \$325 million, respectively, under these agreements; this collateral is included in "Cash and cash equivalents" on the consolidated balance sheets and its use by UPS is not restricted. At December 31, 2019 and 2018 respectively, no additional collateral was required to be posted with our counterparties.

Events such as a counterparty credit rating downgrade (depending on the ultimate rating level) could also allow us to take additional protective measures such as the early termination of trades. Alternatively, we could be required to provide additional collateral or terminate transactions with certain counterparties in the event of a downgrade of our credit rating. The amount of collateral required would be determined by the net fair value of the associated derivatives with each counterparty. We have not historically incurred, and do not expect to incur in the future, any losses as a result of counterparty default.

At December 31, 2019, there were no instruments in a net liability position that were not covered by the zero threshold bilateral collateral provisions.

Types of Hedges

Commodity Risk Management

Currently, the fuel surcharges that we apply to our domestic and international package and less-than-truckload services are the primary means of reducing the risk of adverse fuel price changes on our business. In order to mitigate the impact of fuel surcharges imposed on us by outside carriers, we regularly adjust the rates we charge for our freight brokerage, inter-modal and truckload services. We periodically enter into derivative contracts on energy commodity products to manage the price risk associated with forecasted transactions involving refined fuels, principally jet-A, diesel and unleaded gasoline. The objective of the hedges is to reduce the variability of cash flows, due to changing fuel prices, associated with the forecasted transactions involving those products. We normally designate and account for these contracts as cash flow hedges of the underlying forecasted transactions involving these fuel products and, therefore, the resulting gains and losses from these hedges are recognized as a component of fuel expense or revenue when the underlying transactions occur.

Foreign Currency Risk Management

To protect against the reduction in value of forecasted foreign currency cash flows from our international package business, we maintain a foreign currency cash flow hedging program. Our most significant foreign currency exposures relate to the Euro, British Pound Sterling, Canadian Dollar, Chinese Renminbi and Hong Kong Dollar. We hedge portions of our forecasted revenue denominated in foreign currencies with option and forward contracts. We normally designate and account for these contracts as cash flow hedges of anticipated foreign currency denominated revenue and, therefore, the resulting gains and losses from these hedges are recognized as a component of international package revenue when the underlying sales transactions occur.

We also hedge portions of our anticipated cash settlements of intercompany transactions and interest payments on certain debt subject to foreign currency remeasurement using foreign currency forward contracts. We normally designate and account for these contracts as cash flow hedges of forecasted foreign currency denominated transactions; therefore, the resulting gains and losses from these hedges are recognized as a component of investment income and other when the underlying transactions are subject to currency remeasurement.

We hedge our net investment in certain foreign operations with foreign currency denominated debt instruments. The use of foreign denominated debt as the hedging instrument allows the debt to be remeasured to foreign currency translation adjustment within AOCI to offset the translation risk from those investments. Balances in the cumulative translation adjustment accounts remain until the sale or substantially complete liquidation of the foreign entity, upon which they are recognized as a component of investment income and other.

Interest Rate Risk Management

Our indebtedness under our various financing arrangements creates interest rate risk. We use a combination of derivative instruments as part of our program to manage the fixed and floating interest rate mix of our total debt portfolio and related overall cost of borrowing. The notional amount, interest payment date and maturity date of the swaps match the terms of the associated debt being hedged. Interest rate swaps allow us to maintain a target range of floating-rate debt within our capital structure.

We have designated and account for the majority of our interest rate swaps that convert fixed-rate interest payments into floating-rate interest payments as hedges of the fair value of the associated debt instruments. Therefore, the gains and losses resulting from fair value adjustments to the interest rate swaps and fair value adjustments to the associated debt instruments are recorded to interest expense in the period in which the gains and losses occur. We have designated and account for interest rate swaps that convert floating-rate interest payments into fixed-rate interest payments as cash flow hedges of the forecasted payment obligations. The gains and losses resulting from fair value adjustments to the interest rate swaps are recorded to AOCI.

We periodically hedge the forecasted fixed-coupon interest payments associated with anticipated debt offerings by using forward starting interest rate swaps, interest rate locks or similar derivatives. These agreements effectively lock a portion of our interest rate exposure between the time the agreement is entered into and the date when the debt offering is completed, thereby mitigating the impact of interest rate changes on future interest expense. These derivatives are settled commensurate with the issuance of the debt, and any gain or loss upon settlement is amortized as an adjustment to the effective interest yield on the debt.

Outstanding Positions

The notional amounts of our outstanding derivative positions were as follows as of December 31, 2019 and 2018 (in millions):

		<u>2019</u>	<u>2018</u>
Currency Hedges:			
Euro	EUR	4,571	4,924
British Pound Sterling	GBP	1,494	2,037
Canadian Dollar	CAD	1,402	1,443
Hong Kong Dollar	HKD	3,327	3,642
Singapore Dollar	SGD	—	20
Interest Rate Hedges:			
Fixed to Floating Interest Rate Swaps	USD	3,674	4,674
Floating to Fixed Interest Rate Swaps	USD	778	778

As of December 31, 2019 and 2018, we had no outstanding commodity hedge positions.

Balance Sheet Recognition

The following table indicates the location in the consolidated balance sheets where our derivative assets and liabilities have been recognized, the fair value hierarchy level applicable to each derivative type and the related fair values of those derivatives (in millions).

We have master netting arrangements with substantially all of our counterparties giving us the right of offset for our derivative positions. However, we have not elected to offset the fair value positions of our derivative contracts recorded in the consolidated balance sheets. The columns labeled "Net Amounts if Right of Offset had been Applied" indicate the potential net fair value positions by type of contract and location in the consolidated balance sheets had we elected to apply the right of offset.

Asset Derivatives	Balance Sheet Location	Fair Value Hierarchy Level	Gross Amounts Presented in Consolidated Balance Sheets		Net Amounts if Right of Offset had been Applied	
			2019	2018	2019	2018
Derivatives designated as hedges:						
Foreign exchange contracts	Other current assets	Level 2	\$ 138	\$ 90	\$ 131	\$ 83
Interest rate contracts	Other current assets	Level 2	2	1	2	1
Foreign exchange contracts	Other non-current assets	Level 2	252	230	236	215
Interest rate contracts	Other non-current assets	Level 2	21	14	20	6
Derivatives not designated as hedges:						
Foreign exchange contracts	Other current assets	Level 2	7	7	7	5
Foreign exchange contracts	Other non-current assets	Level 2	—	1	—	1
Interest rate contracts	Other non-current assets	Level 2	12	18	11	18
Total Asset Derivatives			\$ 432	\$ 361	\$ 407	\$ 329

Liability Derivatives	Balance Sheet Location	Fair Value Hierarchy Level	Gross Amounts Presented in Consolidated Balance Sheets		Net Amounts if Right of Offset had been Applied	
			2019	2018	2019	2018
Derivatives designated as hedges:						
Foreign exchange contracts	Other current liabilities	Level 2	\$ 7	\$ 7	\$ —	\$ —
Foreign exchange contracts	Other non-current liabilities	Level 2	16	15	—	—
Interest rate contracts	Other non-current liabilities	Level 2	11	41	10	33
Derivatives not designated as hedges:						
Foreign exchange contracts	Other current liabilities	Level 2	—	3	—	1
Foreign exchange contracts	Other non-current liabilities	Level 2	—	1	—	1
Interest rate contracts	Other non-current liabilities	Level 2	3	—	2	—
Total Liability Derivatives			\$ 37	\$ 67	\$ 12	\$ 35

Our foreign exchange, interest rate and investment market price derivatives are largely comprised of over-the-counter derivatives, which are primarily valued using pricing models that rely on market observable inputs such as yield curves, currency exchange rates and investment forward prices; therefore, these derivatives are classified as Level 2. At December 31, 2019 and 2018 we did not have any derivatives that were classified as Level 1 (valued using quoted prices in active markets for identical assets) or Level 3 (valued using significant unobservable inputs).

Balance Sheet Location of Hedged Item in Fair Value Hedges

The following table indicates the amounts that were recorded in the consolidated balance sheets related to cumulative basis adjustments for fair value hedges as of December 31, 2019 and December 31, 2018 (in millions).

Line Item in the Consolidated Balance Sheets in Which the Hedged Item is Included	Carrying Amount of Hedged Liabilities	Cumulative Amount of Fair Value Hedge Adjustments	Carrying Amount of Hedged Liabilities	Cumulative Amount of Fair Value Hedge Adjustments
	December 31, 2019	December 31, 2019	December 31, 2018	December 31, 2018
Long-Term Debt and Finance Leases	3,234	40	4,207	16

The cumulative amount of fair value hedging losses remaining for any hedged assets and liabilities for which hedge accounting has been discontinued as of December 31, 2019 is \$17 million. These amounts will be recognized over the next 11 years.

Income Statement and AOCI Recognition

The following table indicates the amount of gains and losses that have been recognized in the income statement for the fair value and cash flow hedges, as well as the associated gain or (loss) for the underlying hedged item for fair value hedges for the years ended December 31, 2019 and 2018 (in millions):

Location and Amount of Gain (Loss) Recognized in Income on Fair Value and Cash Flow Hedging Relationships	Year Ended December 31,			Year Ended December 31,		
	2019			2018		
	Revenue	Interest Expense	Investment Income and Other	Revenue	Interest Expense	Investment Income and Other
Gain or (loss) on fair value hedging relationships:						
Interest Contracts:						
Hedged items	\$ —	\$ (38)	\$ —	\$ —	\$ 57	\$ —
Derivatives designated as hedging instruments	—	38	—	—	(57)	—
Gains or (loss) on cash flow hedging relationships:						
Interest Contracts:						
Amount of gain or (loss) reclassified from accumulated other comprehensive income	—	(15)	—	—	(24)	—
Foreign Exchange Contracts:						
Amount of gain or (loss) reclassified from accumulated other comprehensive income	177	—	—	(50)	—	—
Total amounts of income and expense line items presented in the statement of income in which the effects of fair value or cash flow hedges are recorded	\$ 177	\$ (15)	\$ —	\$ (50)	\$ (24)	\$ —

The following table indicates the amount of gains and (losses) that have been recognized in AOCI for the years ended December 31, 2019 and 2018 for those derivatives designated as cash flow hedges (in millions):

Derivative Instruments in Cash Flow Hedging Relationships	Amount of Gain (Loss) Recognized in AOCI on Derivatives	
	2019	2018
Interest rate contracts	\$ 6	\$ 1
Foreign exchange contracts	250	563
Total	\$ 256	\$ 564

As of December 31, 2019, there were \$162 million of pre-tax gains related to cash flow hedges that are currently deferred in AOCI that are expected to be reclassified to income over the 12 month period ended December 31, 2020. The actual amounts that will be reclassified to income over the next 12 months will vary from this amount as a result of changes in market conditions. The maximum term over which we are hedging exposures to the variability of cash flows is approximately 13 years.

The following table indicates the amount of gains and losses that have been recognized in AOCI within foreign currency translation adjustment for the years ended December 31, 2019 and 2018 for those instruments designated as net investment hedges (in millions):

Non-derivative Instruments in Net Investment Hedging Relationships	Amount of Gain (Loss) Recognized in AOCI on Debt	
	2019	2018
Foreign denominated debt	\$ 75	\$ 211
Total	\$ 75	\$ 211

Additionally, we maintain interest rate swaps, foreign exchange forwards and investment market price forward contracts that are not designated as hedges. The interest rate swap contracts are intended to provide an economic hedge of portions of our outstanding debt. The foreign exchange forward contracts are intended to provide an economic offset to foreign currency remeasurement and settlement risk for certain assets and liabilities on our consolidated balance sheets. The investment market price forward contracts are intended to provide an economic offset to fair value fluctuations of certain investments in marketable securities.

We also periodically terminate interest rate swaps and foreign exchange options by entering into offsetting swap and foreign currency positions with different counterparties. As part of this process, we de-designate our original swap and foreign exchange contracts. These transactions provide an economic offset that effectively eliminates the effects of changes in market valuation.

The following is a summary of the amounts recorded in the statements of consolidated income related to fair value changes and settlements of these interest rate swaps, foreign currency forward and investment market price forward contracts not designated as hedges for the years ended December 31, 2019 and 2018 (in millions):

Derivative Instruments Not Designated in Hedging Relationships	Location of Gain (Loss) Recognized in Income	Amount of Gain (Loss) Recognized in Income	
		2019	2018
Interest rate contracts	Interest expense	\$ (9)	\$ (9)
Foreign exchange contracts	Investment income and other	(1)	(102)
Investment market price contracts	Investment income and other	—	16
Total		\$ (10)	\$ (95)

NOTE 17. TRANSFORMATION STRATEGY COSTS

In the first quarter of 2018, we launched the first phase of a multi-year, enterprise-wide transformation strategy impacting our organization. Over the next several years additional phases will be implemented. The program includes investments, as well as changes in processes and technology, that impact global direct and indirect operating costs.

The table below presents the transformation strategy costs for the years ended December 31, 2019 and 2018 (in millions):

Transformation Strategy Costs	Year Ended December 31,	
	2019	2018
Compensation and benefits	\$ 166	\$ 262
Total other expenses	89	98
Total Transformation Strategy Costs	\$ 255	\$ 360
Income Tax Benefit from Transformation Strategy Costs	(59)	(87)
After Tax Transformation Strategy Costs	\$ 196	\$ 273

The income tax effects of transformation strategy costs are calculated by multiplying the amount of the adjustments by the statutory tax rates applicable in each tax jurisdiction.

NOTE 18. QUARTERLY INFORMATION (UNAUDITED)

Our revenue, segment operating profit, other income and (expense), net income, basic and diluted earnings per share on a quarterly basis are presented below (in millions, except per share amounts):

	First Quarter		Second Quarter		Third Quarter		Fourth Quarter	
	2019	2018	2019	2018	2019	2018	2019	2018
Revenue:								
U.S. Domestic Package	\$10,480	\$10,227	\$11,150	\$10,354	\$11,455	\$10,437	\$13,408	\$12,575
International Package	3,459	3,533	3,505	3,602	3,494	3,478	3,762	3,829
Supply Chain & Freight	3,221	3,353	3,393	3,500	3,369	3,529	3,398	3,444
Total revenue	17,160	17,113	18,048	17,456	18,318	17,444	20,568	19,848
Operating Profit:								
U.S. Domestic Package	666	756	1,208	939	1,216	949	1,074	999
International Package	528	594	663	618	667	536	799	781
Supply Chain & Freight	200	170	272	216	245	242	260	224
Total operating profit	1,394	1,520	2,143	1,773	2,128	1,727	2,133	2,004
Total Other Income and (Expense)	\$ 46	\$ 141	\$ 61	\$ 153	\$ 78	\$ 162	\$ (2,331)	\$ (1,461)
Net Income	\$ 1,111	\$ 1,345	\$ 1,685	\$ 1,485	\$ 1,750	\$ 1,508	\$ (106)	\$ 453
Net Income Per Share:								
Basic	\$ 1.28	\$ 1.55	\$ 1.95	\$ 1.71	\$ 2.03	\$ 1.74	\$ (0.12)	\$ 0.52
Diluted	\$ 1.28	\$ 1.55	\$ 1.94	\$ 1.71	\$ 2.01	\$ 1.73	\$ (0.12)	\$ 0.52

Our quarterly results were impacted by transformation strategy costs, legal contingencies and expenses and defined benefit plan mark-to-market charges. The table below presents the impact on operating profit and other income and (expense) for each period.

(in millions, except per share amounts)

	First Quarter		Second Quarter		Third Quarter		Fourth Quarter	
	2019	2018	2019	2018	2019	2018	2019	2018
Impact to Operating Profit								
Transformation Strategy - Employee Benefits	\$ 106	\$ —	\$ 2	\$ 192	\$ 41	\$ 70	\$ 17	\$ —
Transformation Strategy - Other Costs	17	—	19	71	22	27	31	—
Legal Contingencies and Expenses	—	—	—	—	—	—	97	—
Allocation of Matters Impacting Operating Profit to Segments								
U.S. Domestic Package	\$ 28	—	18	196	26	39	133	—
International Package	84	—	2	36	26	40	10	—
Supply Chain & Freight	11	—	1	31	11	18	2	—
Impact to Other Income and (Expense)								
Defined Benefit Plan Mark-to-Market Charges	\$ —	\$ —	\$ —	\$ —	\$ —	\$ —	\$ 2,387	\$ 1,627

Item 9. Changes in and Disagreements with Accountants on Accounting and Financial Disclosure

None.

Item 9A. Controls and Procedures*Evaluation of Disclosure Controls and Procedures:*

As of the end of the period covered by this report, management, including our Chief Executive Officer and Chief Financial Officer, evaluated the effectiveness of the design and operation of our disclosure controls and procedures. Based upon, and as of the date of, the evaluation, our Chief Executive Officer and Chief Financial Officer concluded that the disclosure controls and procedures were effective to ensure that information required to be disclosed in the reports we file and submit under the Exchange Act is recorded, processed, summarized and reported as and when required and is accumulated and communicated to our management, including the Chief Executive Officer and Chief Financial Officer, as appropriate to allow timely decisions regarding required disclosure.

Changes in Internal Control:

There were no changes in the Company's internal control over financial reporting during the quarter ended December 31, 2019 that have materially affected, or are reasonably likely to materially affect, the Company's internal control over financial reporting.

Management's Report on Internal Control Over Financial Reporting:

UPS management is responsible for establishing and maintaining adequate internal control over financial reporting for United Parcel Service, Inc. and its subsidiaries (the "Company"). Based on the criteria for effective internal control over financial reporting established in *Internal Control-Integrated Framework (2013)* issued by the Committee of Sponsoring Organizations of the Treadway Commission, management has assessed the Company's internal control over financial reporting as effective as of December 31, 2019. The independent registered public accounting firm of Deloitte & Touche LLP, as auditors of the consolidated balance sheets of United Parcel Service, Inc. and its subsidiaries as of December 31, 2019 and the related statements of consolidated income, consolidated comprehensive income and consolidated cash flows for the year ended December 31, 2019, has issued an attestation report on the Company's internal control over financial reporting, which is included herein.

Report of Independent Registered Public Accounting Firm

To the Shareowners and Board of Directors of
United Parcel Service, Inc.
Atlanta, Georgia

Opinion on Internal Control over Financial Reporting

We have audited the internal control over financial reporting of United Parcel Service, Inc. and subsidiaries (the "Company") as of December 31, 2019, based on criteria established in Internal Control-Integrated Framework (2013) issued by the Committee of Sponsoring Organizations of the Treadway Commission ("COSO"). In our opinion, the Company maintained, in all material respects, effective internal control over financial reporting as of December 31, 2019, based on criteria established in Internal Control - Integrated Framework (2013) issued by COSO.

We have also audited, in accordance with the standards of the Public Company Accounting Oversight Board (United States) ("PCAOB"), the consolidated financial statements as of and for the year ended December 31, 2019, of the Company and our report dated February 20, 2020, expressed an unqualified opinion on those financial statements and included an explanatory paragraph regarding the Company's adoption of a new accounting standard.

Basis for Opinion

The Company's management is responsible for maintaining effective internal control over financial reporting and for its assessment of the effectiveness of internal control over financial reporting, included in the accompanying Management's Report on Internal Control over Financial Reporting. Our responsibility is to express an opinion on the Company's internal control over financial reporting based on our audit. We are a public accounting firm registered with the PCAOB and are required to be independent with respect to the Company in accordance with the U.S. federal securities laws and the applicable rules and regulations of the Securities and Exchange Commission and the PCAOB.

We conducted our audit in accordance with the standards of the PCAOB. Those standards require that we plan and perform the audit to obtain reasonable assurance about whether effective internal control over financial reporting was maintained in all material respects. Our audit included obtaining an understanding of internal control over financial reporting, assessing the risk that a material weakness exists, testing and evaluating the design and operating effectiveness of internal control based on the assessed risk, and performing such other procedures as we considered necessary in the circumstances. We believe that our audit provides a reasonable basis for our opinion.

Definition and Limitations of Internal Control over Financial Reporting

A company's internal control over financial reporting is a process designed to provide reasonable assurance regarding the reliability of financial reporting and the preparation of financial statements for external purposes in accordance with generally accepted accounting principles. A company's internal control over financial reporting includes those policies and procedures that (1) pertain to the maintenance of records that, in reasonable detail, accurately and fairly reflect the transactions and dispositions of the assets of the company; (2) provide reasonable assurance that transactions are recorded as necessary to permit preparation of financial statements in accordance with generally accepted accounting principles, and that receipts and expenditures of the company are being made only in accordance with authorizations of management and directors of the company; and (3) provide reasonable assurance regarding prevention or timely detection of unauthorized acquisition, use, or disposition of the company's assets that could have a material effect on the financial statements.

Because of its inherent limitations, internal control over financial reporting may not prevent or detect misstatements. Also, projections of any evaluation of effectiveness to future periods are subject to the risk that controls may become inadequate because of changes in conditions, or that the degree of compliance with the policies or procedures may deteriorate.

/s/ Deloitte & Touche LLP

Atlanta, Georgia
February 20, 2020

Item 9B. Other Information

None.

PART III**Item 10. Directors, Executive Officers and Corporate Governance Information about our Executive Officers**

Name and Office	Age	Principal Occupation and Employment For the Last Five Years
David P. Abney Chairman and Chief Executive Officer	64	Chief Executive Officer (2014 - present), Chairman (2016 - present) Senior Vice President and Chief Operating Officer (2007 - 2014).
Norman M. Brothers, Jr. Senior Vice President, General Counsel and Corporate Secretary	52	Senior Vice President, General Counsel and Corporate Secretary (2016 - present), Corporate Legal Department Manager (2014 - 2016), Vice President, Corporate Legal (2004 - 2014).
Nando Cesarone Senior Vice President and President, UPS International	48	President, UPS International (2018 - present), Europe Region Manager (2016 - 2018), Asia Pacific Region Manager (2013 - 2016).
Philippe Gilbert Senior Vice President and President, UPS Supply Chain Solutions	55	President, UPS Supply Chain Solutions (2019 - present), Regional CEO, Americas, DB Schenker Logistics (2015 - 2018), Regional CEO, West Europe, DB Schenker Logistics (2013 - 2015).
Kate M. Gutmann Senior Vice President, Chief Sales and Solutions Officer	51	Chief Sales and Solutions Officer; Senior Vice President The UPS Store and UPS Capital (2017 - present), Senior Vice President, Worldwide Sales and Solutions (2014 - 2017), President, Worldwide Sales (2011 - 2014).
Brian Newman Senior Vice President, Chief Financial Officer and Treasurer	51	Chief Financial Officer and Treasurer (2019 - present), Executive Vice President, Finance and Operations, Latin America, PepsiCo, Inc. (2017 - 2019), Executive Vice President, Global Operations, PepsiCo, Inc. (2015 - 2017), Global Head of e-Commerce, PepsiCo, Inc. (2014 - 2015).
Juan R. Perez Senior Vice President, Chief Information Officer	53	Chief Information Officer and Engineering Officer (2017 - present), Chief Information Officer (2016 - 2017), Vice President, Information Services (2011 - 2016).
Scott A. Price Senior Vice President, Chief Transformation Officer	57	Chief Strategy Transformation Officer (2017 - present), Executive Vice President of Global Leverage - Walmart International, Walmart Stores, Inc. (2017), Chief Administrative Officer and Executive Vice President - Walmart International, Walmart Stores Inc. (2016 - 2017), Chief Executive Officer and President of Walmart Asia Pte. Ltd. (2014 - 2016).
Charlene Thomas Senior Vice President, Chief Human Resources Officer	52	Chief Human Resources Officer (2019 - present), President, Human Capital Transformation (2019), West Region Manager (2018 - 2019), North Atlantic District Manager (2018), Mid-South District Manager (2016-2018), West-OPS Package Operations Manager (2016), U.S. Operations Training Staff Manager (2015-2016).
Kevin Warren Senior Vice President, Chief Marketing Officer	57	Chief Marketing Officer (2018 - present), Executive Vice President and Chief Commercial Officer, Xerox Corp. (2017 - 2018), President, Commercial Business Group, Xerox Corp. (2016 - 2017), President, Industrial, Retail and Hospitality Business Group, Xerox Corp. (2015 - 2016), President of Strategic Growth Initiatives, Xerox Corp. (2014 - 2015).
George Willis Senior Vice President and President, United States Operations	55	President, U.S. Operations (2018 - present), President, West Region (2015 - 2018), U.K., Ireland, and Nordics District Manager (2013 - 2015).

Information about our directors is presented under the caption “Our Board of Directors” in our definitive proxy statement for the Annual Meeting of Shareowners to be held on May 14, 2020 (the “Proxy Statement”) and is incorporated herein by reference.

Information about our Audit Committee is presented under the caption “Our Board of Directors - Committees of the Board of Directors” and “Audit Committee Matters” in our Proxy Statement and is incorporated herein by reference.

Information about our Code of Business Conduct is presented under the caption “Where You Can Find More Information” in Part I, Item 1 of this report.

Item 11. *Executive Compensation*

Information about our board and executive compensation is presented under the captions “Our Board of Directors - Director Compensation” and “Executive Compensation” in our Proxy Statement and is incorporated herein by reference.

Item 12. *Security Ownership of Certain Beneficial Owners and Management and Related Stockholder Matters*

Information about security ownership is presented under the caption “Ownership of Our Securities - Securities Ownership of Certain Beneficial Owners and Management” in our Proxy Statement and is incorporated herein by reference.

Information about our equity compensation plans is presented under the caption “Executive Compensation - Equity Compensation Plans” in our Proxy Statement and is incorporated herein by reference.

Item 13. *Certain Relationships and Related Transactions, and Director Independence*

Information about transactions with related persons is presented under the caption “Corporate Governance - Conflicts of Interest and Related Person Transactions” in our Proxy Statement and is incorporated herein by reference.

Information about director independence is presented under the caption “Corporate Governance - Director Independence” in our Proxy Statement and is incorporated herein by reference.

Item 14. *Principal Accountant Fees and Services*

Information about aggregate fees billed to us by our principal accountant is presented under the caption “Audit Committee Matters - Principal Accounting Firm Fees” in our Proxy Statement and is incorporated herein by reference.

PART IV**Item 15. Exhibits and Financial Statement Schedules**

(a) *Documents filed as a part of this report:*

1. *Financial Statements.*

See Item 8 for the financial statements filed with this report.

2. *Financial Statement Schedules.*

None.

3. *Exhibits.*

See the Exhibit Index below for a list of the exhibits incorporated by reference into or filed with this report.

(b) *Exhibits Required To Be Filed*

See Item 15(a)1 above

(c) *Financial Statement Schedules Required To Be Filed*

See Item 15(a) 2 above

Item 16. Form 10-K Summary

None.

EXHIBIT INDEX

Exhibit No.	Description
3.1	— <u>Restated Certificate of Incorporation of United Parcel Service, Inc. (incorporated by reference to Exhibit 3.3 to Form 8-K filed on May 12, 2010).</u>
3.2	— <u>Amended and Restated Bylaws of United Parcel Service, Inc. as of November 17, 2017 (incorporated by reference to Exhibit 3.1 to Form 8-K, filed on November 17, 2017).</u>
4.1	— <u>Indenture relating to 8 3/8% Debentures due April 1, 2020 (incorporated by reference to Exhibit 4(c) to Registration Statement No. 33-32481, filed on December 7, 1989)⁽¹⁾.</u>
4.2	— <u>Indenture dated as of December 18, 1997 (incorporated by reference to Exhibit T-3C to Form T-3 (No. 022-22295), filed on December 18, 1997)⁽¹⁾.</u>
4.3	— <u>Indenture dated as of January 26, 1999 (incorporated by reference to Exhibit 4.1 to Pre-Effective Amendment No. 1 to Form S-3 (No. 333-08369), filed on January 26, 1999)⁽¹⁾.</u>
4.4	— <u>Form of First Supplemental Indenture to Indenture dated as of January 26, 1999 (incorporated by reference to Exhibit 4.2 to Post-Effective Amendment No. 1 to Form S-3 (No. 333-08369-01), filed on March 15, 2000).</u>
4.5	— <u>Second Supplemental Indenture dated as of September 21, 2001 to Indenture dated as of January 26, 1999 (incorporated by reference to Exhibit 4 to Form 10-Q for the quarter ended September 30, 2001).</u>
4.6	— <u>Indenture dated as of August 26, 2003 (incorporated by reference to Exhibit 4.1 to Form S-3 (No. 333-108272), filed on August 27, 2003).</u>
4.7	— <u>First Supplemental Indenture dated as of November 15, 2013 to Indenture dated as of August 26, 2003 (incorporated by reference to Exhibit 4.2 to Form S-3ASR (No. 333-192369), filed on November 15, 2013).</u>
4.8	— <u>Second Supplemental Indenture dated as of May 18, 2017 (incorporated by reference to Exhibit 4.1 to Form 8-K, filed on May 18, 2017).</u>
4.9	— <u>Form of 6.20% Senior Notes due January 15, 2038 (incorporated by reference to Exhibit 4.3 to Form 8-K, filed on January 15, 2008).</u>
4.10	— <u>Form of 3.125% Senior Notes due January 15, 2021 (incorporated by reference to Exhibit 4.1 to Form 8-K, filed on November 12, 2010).</u>
4.11	— <u>Form of 4.875% Senior Notes due November 15, 2040 (incorporated by reference to Exhibit 4.2 to Form 8-K, filed on November 12, 2010).</u>
4.12	— <u>Form of 2.450% Senior Notes due October 1, 2022 (incorporated by reference to Exhibit 4.2 to Form 8-K, filed on September 27, 2012).</u>
4.13	— <u>Form of 3.625% Senior Notes due October 1, 2042 (incorporated by reference to Exhibit 4.3 to Form 8-K, filed on September 27, 2012).</u>
4.14	— <u>Form of Floating Rate Senior Notes due December 15, 2064 (incorporated by reference to Exhibit 4.1 to Form 8-K, filed on December 15, 2014).</u>
4.15	— <u>Form of Floating Rate Senior Notes due September 15, 2065 (incorporated by reference to Exhibit 4.1 to Form 8-K, filed on September 17, 2015).</u>
4.16	— <u>Form of Floating Rate Senior Notes due July 15, 2020 (incorporated by reference to Exhibit 4.1 to Form 8-K, filed on November 20, 2015).</u>
4.17	— <u>Form of 1.625% Senior Notes due November 15, 2025 (incorporated by reference to Exhibit 4.2 to Form 8-K, filed on November 20, 2015).</u>
4.18	— <u>Form of Floating Rate Senior Notes due March 15, 2066 (incorporated by reference to Exhibit 4.1 to Form 8-K, filed on April 1, 2016).</u>
4.19	— <u>Form of 2.40% Senior Notes Due November 2026 (incorporated by reference to Exhibit 4.2 to Form 8-K, filed on October 25, 2016).</u>
4.20	— <u>Form of 3.40% Senior Notes Due November 2046 (incorporated by reference to Exhibit 4.3 to Form 8-K, filed on October 25, 2016).</u>

- 4.21 — Form of 1.00% Senior Notes Due November 2028 (incorporated by reference to Exhibit 4.1 to Form 8-K, filed on October 25, 2016).
- 4.22 — Form of Floating Rate Senior Notes due March 15, 2067 (incorporated by reference to Exhibit 4.1 to Form 8-K, filed on March 31, 2017).
- 4.23 — Form of Floating Rate Senior Notes due May 16, 2022 (incorporated by reference to Exhibit 4.1 to Form 8-K, filed on May 16, 2017).
- 4.24 — Form of 2.350% Senior Notes due May 16, 2022 (incorporated by reference to Exhibit 4.2 to Form 8-K, filed on May 16, 2017).
- 4.25 — Form of 2.125% Senior Notes due May 21, 2024 (incorporated by reference to Exhibit 4.2 to Form 8-K, filed on May 18, 2017).
- 4.26 — Form of 0.375% Senior Notes due November 15, 2023 (incorporated by reference to Exhibit 4.1 to Form 8-K, filed on November 13, 2017).
- 4.27 — Form of 1.500% Senior Notes due November 15, 2032 (incorporated by reference to Exhibit 4.2 to Form 8-K, filed on November 13, 2017).
- 4.28 — Form of Floating Rate Senior Notes due April 1, 2021 (incorporated by reference to Exhibit 4.1 to Form 8-K, filed on November 14, 2017).
- 4.29 — Form of Floating Rate Senior Notes due April 1, 2023 (incorporated by reference to Exhibit 4.2 to Form 8-K, filed on November 14, 2017).
- 4.30 — Form of 2.050% Senior Notes due April 1, 2021 (incorporated by reference to Exhibit 4.3 to Form 8-K, filed on November 14, 2017).
- 4.31 — Form of 2.500% Senior Notes due April 1, 2023 (incorporated by reference to Exhibit 4.4 to Form 8-K, filed on November 14, 2017).
- 4.32 — Form of 2.800% Senior Notes due November 15, 2024 (incorporated by reference to Exhibit 4.5 to Form 8-K, filed on November 14, 2017).
- 4.33 — Form of 3.050% Senior Notes due November 15, 2027 (incorporated by reference to Exhibit 4.6 to Form 8-K, filed on November 14, 2017).
- 4.34 — Form of 3.750% Senior Notes due November 15, 2047 (incorporated by reference to Exhibit 4.7 to Form 8-K, filed on November 14, 2017).
- 4.35 — Form of Floating Rate Senior Notes due November 15, 2067 (incorporated by reference to Exhibit 4.8 to Form 8-K, filed on November 14, 2017).
- 4.36 — Form of 3.400% Senior Notes due March 15, 2029 (incorporated by reference to Exhibit 4.1 to Form 8-K, filed on March 15, 2019).
- 4.37 — Form of 4.250% Senior Notes due March 15, 2049 (incorporated by reference to Exhibit 4.2 to Form 8-K, filed on March 15, 2019).
- 4.38 — Form of 2.200% Senior Notes due September 1, 2024 (incorporated by reference to Exhibit 4.1 to Form 8-K filed on August 16, 2019).
- 4.39 — Form of 2.500% Senior Notes due September 1, 2029 (incorporated by reference to Exhibit 4.2 to Form 8-K filed on August 16, 2019).
- 4.40 — Form of 3.400% Senior Notes due September 1, 2049 (incorporated by reference to Exhibit 4.3 to Form 8-K filed on August 16, 2019).
- 4.41 — Description of Securities.
- 10.1 — UPS Retirement Plan Amendment and Restatement Effective January 1, 2014 (incorporated by reference to Exhibit 10.1 to Form 10-K for the year ended December 31, 2014).*
- 10.1(a) — Amendment No. 1 to UPS Retirement Plan, as Amended and Restated, effective as of June 30, 2016 (incorporated by reference to Exhibit 10.1 to Form 10-Q for the quarter ended June 30, 2016).*

- 10.1(b) — Amendment Four to the Amended and Restated UPS Retirement Plan effective June 23, 2017 (incorporated by reference to Exhibit 10.2 to Form 8-K, filed on June 27, 2017).*
- 10.2 — UPS 401(k) Savings Plan, Amendment and Restatement effective as of January 1, 2017 (incorporated by reference to Exhibit 10.1 to Form 8-K, filed on June 27, 2017).*
- 10.3 — UPS Restoration Savings Plan effective January 1, 2017 (incorporated by reference to Exhibit 10.3 to Form 8-K, filed on June 27, 2017).*
- 10.4 — Amendment One to the Amended and Restated UPS Excess Coordinating Benefit Plan effective June 23, 2017 (incorporated by reference to Exhibit 10.4 to Form 8-K, filed on June 27, 2017).*
- 10.4(a) — UPS Excess Coordinating Benefit Plan, as Amended and Restated, effective as of January 1, 2012 (incorporated by reference to Exhibit 10.5 to Form 10-K for the year ended December 31, 2012).*
- 10.5 — United Parcel Service, Inc. 2012 Omnibus Incentive Compensation Plan (incorporated by reference to Annex A to the Definitive Proxy Statement, filed on March 12, 2012).*
- 10.5(a) — Form of Long-Term Incentive Performance Award Agreement (incorporated by reference to Exhibit 10.3 to the Quarterly Report on Form 10-Q for the quarter ended March 31, 2011).*
- 10.5(b) — Form of Non-Employee Director Restricted Stock Unit Award Agreement (incorporated by reference to Exhibit 10.1 to the Quarterly Report on Form 10-Q for the quarter ended June 30, 2019).*
- 10.5(c) — UPS Management Incentive Program Terms and Conditions effective as of January 1, 2011 (incorporated by reference to Exhibit 10.10(3) to the Form 10-K) for the year ended December 31, 2010).*
- 10.5(d) — UPS Stock Option Program Terms and Conditions effective as of January 1, 2012 (incorporated by reference to Exhibit 10.7(4) to the Form 10-K for the year ended December 31, 2011).*
- 10.5(e) — UPS Long-Term Incentive Performance Program Terms and Conditions effective as of January 1, 2012 (incorporated by reference to Exhibit 10.7(5) to the Form 10-K for the year ended December 31, 2011).*
- 10.6 — Form of UPS Deferred Compensation Plan as Amended and Restated effective January 1, 2012 (incorporated by reference to Exhibit 10.6 to Form 10-K for the year ended December 31, 2018).*
- 10.6(a) — Amendment No. 1 to Amended and Restated UPS Deferred Compensation Plan (incorporated by reference to Exhibit 10.7(1) to the Form 10-K for the year ended December 31, 2012).*
- 10.7 — 2015 Omnibus Incentive Compensation Plan (incorporated by reference to Annex A to the Definitive Proxy Statement filed on March 24, 2015).*
- 10.8 — 2018 Omnibus Incentive Compensation Plan (incorporated by reference to Annex A to the Definitive Proxy Statement filed on March 16, 2018).*
- 10.8(a) — UPS Management Incentive Program Amended and Restated Terms and Conditions effective November 8, 2018 (incorporated by reference to Exhibit 10.8(a) to Form 10-K for the year ended December 31, 2018).*
- 10.8(b) — UPS Stock Option Program Amended and Restated Terms and Conditions effective November 8, 2018 (incorporated by reference to Exhibit 10.8(b) to Form 10-K for the year ended December 31, 2018).*
- 10.8(c) — UPS Long-Term Incentive Performance Program Amended and Restated Terms and Conditions effective as of November 8, 2018 (incorporated by reference to Exhibit 10.8(c) to Form 10-K for the year ended December 31, 2018).*
- 10.9 — Employment offer letter agreement between the Company and Scott Price, dated November 28, 2017 (incorporated by reference to Exhibit 10.9 to Form 10-K for the year ended December 31, 2018).*
- 10.10 — Form of Protective Covenant Agreement between the Company and Scott Price (incorporated by reference to Exhibit 10.10 to Form 10-K for the year ended December 31, 2018).*
- 10.11 — Employment offer letter agreement between the Company and Kevin Warren, dated May 5, 2018 (incorporated by reference to Exhibit 10.11 to Form 10-K for the year ended December 31, 2018).*
- 10.12 — Form of Protective Covenant Agreement between the Company and Kevin Warren (incorporated by reference to Exhibit 10.12 to Form 10-K for the year ended December 31, 2018).*
- 10.13 — Employment offer letter agreement between the Company and Brian Newman, dated August 7, 2019 (incorporated by reference to Exhibit 10.1 to Form 8-K filed on August 13, 2019).*

- 10.14 — Protective Covenant Agreement between the Company and Brian Newman, dated August 7, 2019 (incorporated by reference to Exhibit 10.2 to Form 8-K filed on August 13, 2019).*
- 10.15 — Transition Agreement between the Company and James J. Barber, dated October 21, 2019 (incorporated by reference to Exhibit 10.1 to Form 8-K, filed on October 22, 2019).*
- 10.16 — UPS Long-Term Incentive Performance Program Amended and Restated Terms and Conditions effective as of February 13, 2020*.
- 21 — Subsidiaries.
- 23 — Consent of Deloitte & Touche LLP.
- 31.1 — Certificate of the Principal Executive Officer Pursuant to Rule 13a-14(a), as adopted pursuant to Section 302 of the Sarbanes-Oxley Act of 2002.
- 31.2 — Certificate of the Principal Financial Officer Pursuant to Rule 13a-14(a), as adopted pursuant to Section 302 of the Sarbanes-Oxley Act of 2002.
- 32.1 — Certification of the Principal Executive Officer Pursuant to 18 U.S.C. Section 1350, as Adopted Pursuant to Section 906 of the Sarbanes-Oxley Act of 2002.
- 32.2 — Certification of the Principal Financial Officer Pursuant to 18 U.S.C. Section 1350, as Adopted Pursuant to Section 906 of the Sarbanes-Oxley Act of 2002.
- 101 — The following financial information from the Annual Report on Form 10-K for the year ended December 31, 2019, formatted in Inline XBRL (Extensible Business Reporting Language): (i) the Consolidated Balance Sheets, (ii) the Consolidated Statements of Income, (iii) the Consolidated Statements of Comprehensive Income (Loss), (iv) the Consolidated Statements of Cash Flows and (v) the Notes to the Consolidated Financial Statements.
- 104 — Cover Page Interactive Data File - The cover page from this Annual Report on Form 10-K for the year ended December 31, 2019 is formatted in iXBRL (included as Exhibit 101).

⁽¹⁾ Filed in paper format.

* Management contract or compensatory plan or arrangement.

(amounts in millions, except per share amounts)

	Net Income				
	2019	2018	2017	2016	2015
Reported / GAAP	\$ 4,440	\$ 4,791	\$ 4,905	\$ 3,422	\$ 4,840
Transformation Strategy	255	360	-	-	-
Legal Contingencies and Expenses	97	-	-	-	-
Defined Benefit Plans Mark-to-Market Charge	2,387	1,627	800	2,651	118
Income Tax Expense (Benefit) from the Items Above	(636)	(477)	(193)	(978)	(39)
Income Tax Benefit from the Tax Cuts and Jobs Act and other non-U.S. tax law change	-	-	(258)	-	-
Adjusted	\$ 6,543	\$ 6,301	\$ 5,254	\$ 5,095	\$ 4,919

	Diluted Earnings Per Share				
	2019	2018	2017	2016	2015
Reported / GAAP	\$ 5.11	\$ 5.51	\$ 5.61	\$ 3.86	\$ 5.34
Transformation Strategy	0.29	0.41	-	-	-
Legal Contingencies and Expenses	0.11	-	-	-	-
Defined Benefit Plans Mark-to-Market Charge	2.75	1.87	0.90	2.98	0.13
Income Tax Expense (Benefit) from the Items Above	(0.73)	(0.55)	(0.22)	(1.10)	(0.04)
Income Tax Benefit from the Tax Cuts and Jobs Act and other non-U.S. tax law change	-	-	(0.29)	-	-
Adjusted	\$ 7.53	\$ 7.24	\$ 6.00	\$ 5.74	\$ 5.43

	Operating Profit				
	2019	2018	2017	2016	2015
Reported / GAAP	\$ 7,798	\$ 7,024	\$ 7,529	\$ 7,688	\$ 7,243
Transformation strategy	255	360	-	-	-
Legal Contingencies and Expenses	97	-	-	-	-
Adjusted	\$ 8,150	\$ 7,384	\$ 7,529	\$ 7,688	\$ 7,243

	Operating Margin				
	2019	2018	2017	2016	2015
Reported / GAAP	10.5%	9.8%	11.3%	12.5%	12.2%
Transformation strategy	0.4%	0.5%	-	-	-
Legal Contingencies and Expenses	0.1%	-	-	-	-
Adjusted	11.0%	10.3%	11.3%	12.5%	12.2%

	Operating Profit					
	U.S. Domestic Package		International Package		Supply Chain & Freight	
	2019	2018	2019	2018	2019	2018
Reported / GAAP	\$ 4,164	\$ 3,643	\$ 2,657	\$ 2,529	\$ 977	\$ 852
Transformation strategy	108	235	122	76	25	49
Legal Contingencies and Expenses	97	-	-	-	-	-
Adjusted	\$ 4,369	\$ 3,878	\$ 2,779	\$ 2,605	\$ 1,002	\$ 901
Currency Adjustment	-	-	(70)	10	8	5
Adjusted Currency Neutral	\$ 4,369	\$ 3,878	\$ 2,709	\$ 2,615	\$ 1,010	\$ 906

	Operating Margin					
	U.S. Domestic Package		International Package		Supply Chain & Freight	
	2019	2018	2019	2018	2019	2018
Reported / GAAP	9.0%	8.4%	18.7%	17.5%	7.3%	6.2%
Transformation strategy	0.2%	0.5%	0.8%	0.5%	0.2%	0.4%
Legal Contingencies and Expenses	0.2%	-	-	-	-	-
Adjusted	9.4%	8.9%	19.5%	18.0%	7.5%	6.5%

	Revenue					
	U.S. Domestic Package		International Package		Supply Chain & Freight	
	2019	2018	2019	2018	2019	2018
Reported / GAAP	\$ 46,493	\$ 43,593	\$ 14,220	\$ 14,442	\$ 13,381	\$ 13,826
Currency Adjustment	-	-	232	(147)	75	(39)
Currency Neutral	\$ 46,493	\$ 43,593	\$ 14,452	\$ 14,295	\$ 13,456	\$ 13,787

	Currency Neutral Revenue		
	2019 Currency Neutral	2018 As Reported	% Change
International Package	\$ 14,452	\$ 14,442	0.1%
Supply Chain & Freight	\$ 13,456	\$ 13,826	-2.7%

	Return on Assets		
	2019	2018	2017
Beginning Balance (Reported / GAAP)	\$ 50,016	\$ 45,574	\$ 40,545
Beginning Balance (Adjusted)	\$ 49,539	\$ 45,123	\$ 41,523
Ending Balance (Reported / GAAP)	\$ 57,857	\$ 50,016	\$ 45,574
Unrecognized Pension and Postretirement Benefit Costs (Net of Tax)	-	-	-
Long-Term U.S. Deferred Tax Assets	(636)	(477)	(451)
Adjusted Ending Balance	\$ 57,221	\$ 49,539	\$ 45,123
Average Reported Balance ((Reported Beginning + Reported Ending) / 2)	\$ 53,937	\$ 47,795	\$ 43,060
Average Adjusted Balance ((Adjusted Beginning + Adjusted Ending) / 2)	\$ 53,380	\$ 47,331	\$ 43,323
Return on Reported Balance (Reported Net Income / Average Reported Balance)	8.2%	10.0%	11.4%
Return on Adjusted Balance (Adjusted Net Income / Average Adjusted Balance)	12.3%	13.3%	12.1%

	Adjusted Shareowners' Equity		
	2019	2018	2017
Reported / GAAP	\$ 3,037	\$ 1,024	\$ 430
Adjusted	\$ 6,943	\$ 4,593	\$ 3,851
Adjusted	\$ 3,283	\$ 3,037	\$ 1,024
Unrecognized Pension and Postretirement Benefit Costs (Net of Tax)	5,035	3,906	3,569
Long-Term U.S. Deferred Tax Assets	-	-	-
Adjusted	\$ 8,318	\$ 6,943	\$ 4,593

	Adjusted Capital Expenditures	
	2019	2018
Reported / GAAP	\$ 6,380	\$ 6,283
Principal Repayments of Finance Lease Obligations	140	340
Adjusted	\$ 6,520	\$ 6,623

Note: The adjustments denoted in the tables above are further described in our annual reports on Form 10-K for the years ended December 31, 2019, 2018, 2017, 2016, and 2015, as well as in the historical financial schedules on our investor relations website.

Note: We supplement the reporting of our financial information determined under Generally Accepted Accounting Principles ("GAAP") with certain non-GAAP financial measures, including revenue, operating profit, operating margin, net income, earnings per share, and return on assets adjusted for the non-comparable items listed in the tables above. Adjusted financial measures may also exclude the impact of period over period exchange rate changes and hedging activities. We believe these adjusted measures provide meaningful information to assist investors and analysts in understanding our financial results and assessing our prospects for future performance. We believe these adjusted financial measures are important indicators of our recurring results of operations because they exclude items that may not be indicative of, or are unrelated to, our underlying operating results, and provide a useful baseline for analyzing trends in our underlying businesses.

(This page intentionally left blank)

INVESTOR INFORMATION

ANNUAL MEETING

Our annual meeting of shareowners will be held at 8 a.m. on May 14, 2020, at the Hotel DuPont, 11th and Market Street, Wilmington, DE. Shareowners of record as of March 16, 2020, are entitled to vote at the meeting.

INVESTOR RELATIONS

You can contact our Investor Relations Department at:

>>> UPS

55 Glenlake Parkway, NE
Atlanta, GA 30328-3474
800.877.1503 or 404.828.6059
investors.ups.com

EXCHANGE LISTING

Our Class B common stock is listed on the New York Stock Exchange under the symbol "UPS".

TRANSFER AGENT AND REGISTRAR

Computershare

Send notices of address changes or questions regarding account status, stock transfer, lost certificates, or dividend payments to:

>>> Regular Mail

UPS
c/o Computershare
PO Box 505002
Louisville, KY 40233-5002

or:

>>> Expedited Delivery

UPS
c/o Computershare
462 South 4th Street, Suite 1600
Louisville, KY 40202

FORM 10-K

Our Annual Report on Form 10-K for the year ended December 31, 2019 forms part of the UPS 2019 Annual Report. If you would like an additional copy of our Form 10-K, you can access it through the Investor Relations website at www.investors.ups.com or at the Securities and Exchange Commission website, sec.gov. The Form 10-K also is available free of charge by calling, contacting via the website, or writing to the Investor Relations Department.

UPS SHAREOWNER SERVICES

Convenient access 24 hours a day, seven days a week.

>>> Class A Common Shareowners

www.computershare.com/ups
888.663.8325

>>> Class B Common Shareowners

www.computershare.com/ups
800.758.4674

Calls from outside the United States: 201.680.6612
TDD for hearing impaired: 800.231.5469
TDD for non-U.S. shareowners: 201.680.6610

DIRECT STOCK PURCHASE PLAN

To make an initial purchase of UPS Class B Common Stock online, visit www.computershare.com/Investor and go to "Invest Now". Follow the instructions provided to search for Investment Plans and access the Enrollment Wizard.

Current Class B shareowners can enroll in the plan online by accessing their accounts through www.computershare.com/ups or by calling 800.758.4674.

DIVIDEND REINVESTMENT PLAN

To reinvest dividends in additional UPS shares:

>>> Class A and B Shareowners

www.computershare.com/ups

ONLINE ACCESS TO SHAREOWNER ACCOUNT MATERIALS

Enroll in E-Communications, a self-service program that provides electronic notification and secure access to shareowner communications. To enroll, access your account at www.computershare.com/ups. After accessing your account, click the "What would you like to do" dropdown menu in the upper left of the page. Under "Holdings" click "Manage My Stock," select "My Profile," click "Update" under "E-Communications" and follow the enrollment instructions.

UPS WEBSITES

- Investor Relations..... investors.ups.com
- UPS Corporate..... ups.com
- Sustainability/
Corporate Responsibility sustainability.ups.com
- Services and Solutions..... ups.com/businesssolutions

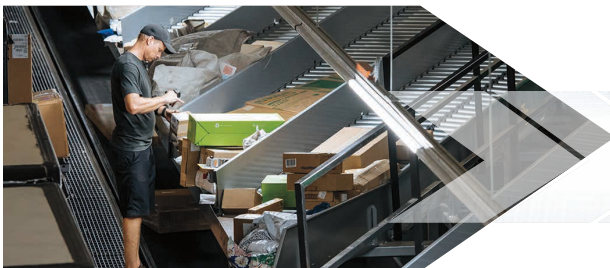



55 Glenlake Parkway, NE
Atlanta, GA 30328-3474
www.ups.com





2021 UPS[®] Tariff/Terms & Conditions of Service – United States

Effective April 5, 2021

Effective April 5, 2021 (unless otherwise noted)

UPS® Tariff/Terms and Conditions of Service – United States

TABLE OF CONTENTS

1. Introduction	4	13. ZIP Code/Postal Code Information	14
2. Definitions Used	4	14. P.O. Boxes	14
3. Commodities Handled and Restrictions on Service	5	15. UPS Customer Center and UPS Worldwide Express Freight® Center	14
3.1 Items Not Accepted for Transportation	5	16. Third-Party Retailer	14
3.2 Maximum Values	6	17. UPS Access Point® Locations	14
3.3 Prohibited by Law	6	17.1 Ship to a UPS Access Point Location Service	14
3.4 Alcoholic Beverages	7	17.2 Ship to a UPS Access Point Location Service – Deliver to Addressee Only	15
3.5 Marijuana and Hemp	7	17.3 Ship to a UPS Access Point Location Service – Package Release Code	15
3.6 Biological Materials	7	18. Pickup Services – Scheduled	15
3.7 Firearms and Ammunition	7	19. UPS On-Call Pickup® Service	15
3.7.1 Firearms	7	20. Saturday Air Processing Fee; Saturday Export Processing Fee; Saturday Stop Charge	15
3.7.2 Ammunition	7	21. Drop Shipment	16
3.8 Food Transport; Assumption of Legal Responsibility	8	22. Delivery	16
3.9 Hazardous Materials Service	8	23. Direct Delivery Only Surcharge	16
3.10 Dry Ice	9	24. Residential Surcharge	16
3.11 Limited Quantity Packages	9	25. Delivery Area Surcharge	16
3.12 Hazardous Waste, Mercury, and Mercury-Containing Waste	9	26. Delivery Attempts; UPS Access Point® Locations	16
3.13 Live Animals	9	27. Hold for Pickup and Hold at Location Services	17
3.14 Perishable Commodities	9	28. Shipper Release	17
3.15 Pharmaceuticals	10	29. UPS carbon neutral	17
3.16 Portable Electronic Devices	10	30. UPS Delivery Intercept® Service	17
3.17 Tobacco and Vaping Products	10	31. Delivery Change Requests	17
3.18 Prohibited Item Fee	10	32. Correction of Addresses	18
4. Provisions for Export and Customs Clearance of International Shipments	10	33. Saturday Delivery	18
4.1 Electronic Export Information	11	34. Delivery Confirmation Services	18
4.2 Certificate of Origin	11	34.1 Delivery Confirmation (domestic only)	18
4.3 UPS Paperless® Invoice Service	11	34.2 Delivery Confirmation Signature Required (domestic and international)	18
4.4 Pre-Release Notification for Import Shipments	12	34.3 Delivery Confirmation Adult Signature Required (domestic and international)	18
4.5 Record-Keeping	12	35. Proof of Delivery (P.O.D.)	19
5. UPS Import Control® Service	12	36. Tracking/Tracing and Refund Request Charge	19
6. Right of Inspection	12	37. Special Handling of Undeliverable Shipments; Refused Shipments Returned	19
7. Refusal of Service	12		
8. Packaging	13		
9. Use of UPS-Provided Materials and Services	13		
10. Use of UPS Accounts	13		
11. Use of UPS Electronic Information Systems	13		
12. Timely Upload of PLD; Missing PLD Fee	13		
12.1 Use of PLD Obtained Email Addresses and Telephone Numbers	13		

UPS® Tariff/Terms and Conditions of Service – United States

TABLE OF CONTENTS *(continued)*

38. C.O.D. Service	19	53. UPS Service Guarantee	26
38.1 Preparation and Listing of C.O.D. Packages	19	53.1 Conditions	26
38.2 Responsibility for C.O.D.s	19	53.2 Exclusions	27
38.3 Consignee's Checks in Payment of C.O.D.s	19	54. Claims and Legal Actions:	
38.4 C.O.D. Package of \$10,000 or More	20	Individual Binding Arbitration of Claims	27
38.5 Acceptance of Personal Check	20	54.1 Making Claims for Loss or Damage to Property	29
38.6 C.O.D. Remittance Verification	20	54.2 Acknowledgment of Claims for Loss	
38.7 Restrictions	20	or Damage to Property	29
38.8 Charges for C.O.D. Collections	20	54.3 Time Limit for Notice and Filing of Claims	
38.9 Remittance of C.O.D.s	20	for Loss or Damage to Property	29
39. UPS Returns® Services	20	54.4 Investigation of Claims for Loss	
40. UPS Rates	21	or Damage to Property	29
40.1 Daily Rates and Retail Rates	21	54.5 Salvage	30
40.2 UPS® Simple Rate	21	54.6 Disposition of Claims for Loss	
40.3 Letter Rates	21	or Damage to Property	30
40.4 Pak Rates	21	55. Responsibility for Loss or Damage	30
40.5 UPS 10 KG Box and UPS 25 KG Box Rates	21	55.1 Maximum Declared Values	30
40.6 Private Express Statutes	22	55.2 Liability Limits	31
40.7 Rates for Large Packages;		55.3 Exclusions from Liability	32
Large Package Surcharge	22	56. Data Handling	33
40.8 Over Maximum Limits Charge	22	57. Incorporation of Documents; Waiver;	
40.9 Additional Handling Charge	22	Future Changes	33
40.10 Oversize Pallet Handling Surcharge	22		
41. Peak Surcharges	22		
42. Fuel Surcharges	22		
43. Manual Processing Charges	22		
44. Third Party Billing Service	22		
45. Billing Options for Domestic Shipments	23		
46. Billing Options for International Shipments	23		
47. Bill My Account	23		
48. Disbursement Fee	23		
49. Currency Conversion Rate	23		
50. Missing/Invalid Account Number or Refusal Fee	23		
51. Shipping Charge Corrections; Audit Fee	23		
52. Payment of Charges	23		
52.1 Invoice Adjustment	24		
52.2 Alternative Payment Plans	24		
52.3 Late Payment Fee	25		
52.4 Lien on Shipments	26		

Effective April 5, 2021 (unless otherwise noted)

UPS® Tariff/Terms and Conditions of Service – United States

1. Introduction

The following contains the general terms and conditions of contract under which United Parcel Service (“UPS”) is engaged in the transportation of Package shipments itself and jointly through interchange with its affiliates via the services described below.

The UPS Tariff/Terms and Conditions of Service (“Terms”) are effective on the date set forth above and are subject to change without prior notice. The Terms are published electronically on the UPS website (ups.com). The most current and controlling version of the Terms is published at www.ups.com/terms. In tendering a Shipment for service, the Shipper agrees that the version of the Terms and the applicable UPS Rate and Service Guide (“Service Guide”) in effect at the time of shipping will apply to the Shipment and its transportation (however, the binding arbitration requirement in Section 54 applies to all disputes within its scope, even as to shipments tendered before the effective date of these Terms). The Terms apply to the following services:¹

- UPS Air Services
- UPS Hundredweight Service® Air Services
- UPS 3 Day Select®
- UPS Hundredweight Service® UPS 3 Day Select®
- UPS® Ground
- UPS® Ground with Freight Pricing
- UPS Hundredweight Service® Ground
- UPS Returns® Services

“UPS Air Services” includes:

- UPS Next Day Air® Early
- UPS Next Day Air®
- UPS Next Day Air Saver®
- UPS 2nd Day Air A.M.®
- UPS 2nd Day Air®

“UPS Hundredweight Air Services” includes:

- UPS Hundredweight Service® UPS Next Day Air®

¹The Third Party Billing Service fee described in Section 44 applies to all UPS services worldwide, regardless of origin or destination.

*Refer to www.ups.com/holidays for service limitations during the holiday season.

Note: Visit ups.com for guarantee details, service availability, delivery time commitments or to request a pickup.

- UPS Hundredweight Service® UPS Next Day Air Saver®
- UPS Hundredweight Service® UPS 2nd Day Air A.M.®
- UPS Hundredweight Service® UPS 2nd Day Air®

The Terms apply to the following international services:

- UPS Worldwide Express Plus®
- UPS Worldwide Express NA1®
- UPS Worldwide Express®
- UPS Worldwide Express Freight® Midday
- UPS Worldwide Express Freight®
- UPS Worldwide Saver®
- UPS Worldwide Expedited®
- UPS 3 Day Select® from Canada
- UPS® Standard services

“UPS Worldwide Express Freight Service” includes:

- UPS Worldwide Express Freight Midday
- UPS Worldwide Express Freight

2. Definitions Used

- “**Alaska and Hawaii Rates**” refer to the effective UPS Rates for Shipments originating in Alaska and Hawaii published in the effective Service Guide for Alaska and Hawaii, or Retail Rates established by UPS for the service selected by the Shipper that apply to the Shipper and the Package, and are in effect at the time of shipping, plus any additional charges or rates for nonstandard service, additional or nonstandard usage, and any other additional charges referenced within the Terms or the Service Guide, or those applicable additional rates set out in any customized contracts.
- “**Business day**” means Monday through Friday except the following holidays: New Year’s Day, Memorial Day, Independence Day, Labor Day, Thanksgiving Day, Christmas Day (December 25), and New Year’s Eve.*
- “**Charges**” means all applicable transportation and other charges including, but not limited to, all applicable accessorial charges, brokerage service fees, surcharges, additional handling charges and late payment fees. Any such Charges, including but not limited to any surcharges, are not intended solely to cover the cost of providing service and may result in profit to UPS.

– “**Claimant**” means any person asserting or against whom UPS asserts any claim in any forum for legal or equitable relief – including, but not limited to, any claim for damages, refunds, credits, injunctive relief, and declaratory relief – arising out of or related to the provision of services by UPS.

– “**C.O.D.**” means for all purposes Collect on Delivery.

– “**Commercial**” refers to any address that is not Residential.

– “**Daily Rates**” and “**Retail Rates**” refer to the effective UPS Rates for Shipments originating in the 48 contiguous United States established by UPS for the service selected by the Shipper that apply to the Shipper and the Package, and are in effect at the time of shipping, plus any additional charges or rates for nonstandard service, or additional or nonstandard usage, and any other additional charges referenced within the Terms or the Service Guide, or those applicable additional rates set out in any customized contracts. Effective December 28, 2015, “Daily Rates” is deemed to mean “Standard List Rates.”

– “**Delivery**” shall be deemed to include, but not be limited to any of the following: (1) delivery to the Consignee or the Consignee’s actual or apparent agent or representative, or pursuant to Consignee’s instructions, (2) delivery to the address or location specified in the UPS Shipping System or, to any person present at such address, (3) delivery to an alternate address or location, including to a UPS Access Point® location, (4) delivery in accordance with trade custom or usage, (5) delivery pursuant to UPS’s driver release procedures, (6) delivery pursuant to UPS’s Shipper Release procedures, or (7) delivery otherwise permitted under the Terms.

– “**Drop Shipment**” means any Shipment tendered pursuant to a written agreement or prior arrangement between UPS and a specific Shipper that permits the Shipper to tender quantities of individual Packages directly to UPS at a UPS pre-approved designated location.

– “**Letter Rates**” refers to the UPS Rates applicable to single package Shipments using UPS Express® Envelope or UPS® Letter packaging containing correspondence, urgent documents, or electronic

UPS® Tariff/Terms and Conditions of Service – United States

- media, with an actual weight of eight (8) ounces or less. (“UPS Express® Envelope” and “UPS Letter”) may be referred to interchangeably.)
- **“Package”** means any container and its contents, and includes a UPS Express® Envelope, as well as any article that may be handled without packaging if the handling thereof can be accomplished in a reasonably safe and practicable manner.
 - **“Perishable Commodity”** refers to a perishable commodity or a commodity requiring protection from heat or cold, including, but not limited to, live animals, foods, dry ice, flowers, biological materials.
 - **“Receiver” or “Consignee”** refers to the party to whom the Shipment is being sent.
 - **“Residential”** refers to an address that is a home, including, but not limited to, a business operating out of a home. If an address can be construed as either Residential or Commercial, then it will be considered Residential.
 - **“Shipment”** means one or more Packages, or one or more pallets in a UPS Worldwide Express Freight® Service, shipped under a single Source Document or UPS Automated Shipping System entry to one Receiver.
 - **“Shipper”** refers to the party holding the UPS account used to process and tender a Shipment to UPS or, if no account was used for the Shipment, then the party that contracted with UPS for the Shipment. The term Shipper does not include, for example, a party to whom a Shipment was Third Party or collect billed, the party who drops off a UPS Returns® Services package, or a party that uses another party’s account for a Shipment.
 - **“Third Party”** means any party that is not the Shipper or Receiver/Consignee.
 - **“Third-Party Retailers”** means locations of The UPS Store® centers, UPS Authorized Shipping Outlet locations, and UPS Alliance Locations (located within Staples® retail locations). UPS may designate certain Third-Party Retailers as UPS Access Point® locations, as that term is defined below, but all terms and conditions applicable to Third-Party Retailers set forth herein shall continue to apply, regardless of such designation.
 - A **“UPS Access Point”®** location is an independently owned and operated business or a location (including a UPS Access Point® locker) designated as a UPS Access Point location by UPS where a Consignee or other recipient may, where available, receive a Package Delivery. Where available, Packages processed for shipment prior to tender using a UPS Shipping System may be tendered to a UPS Access Point® location. Hours of operation and availability of staffing vary by location.
 - **“UPS® Automated Shipping System,” “Source Document” and “PLD Upload.”** Source Document means a shipping document provided by UPS for the purpose of tendering a Shipment to UPS for transportation. UPS Automated Shipping System means WorldShip® technology, UPS CampusShip® technology, [ups.com](https://www.ups.com) shipping (also referred to as online shipping), UPS marketplace shipping, UPS® Developer Kit, iShip® technology, UPS Host Access, UPS Mobile™ shipping apps, or an approved UPS Ready® solution that meets UPS requirements at the time of Shipment. PLD Upload means the transmission to UPS of Package manifest information, including without limitation, by Host Manifest Upload and Electronic Manifest Tool. The term “UPS Automated Shipping System,” “Source Document” and “PLD Upload,” individually or collectively, are sometimes referred to by the term “UPS Shipping System.”
 - **“UPS Customer Center”** means a UPS facility where Shippers may tender Packages to UPS for transportation, and a Consignee or other recipient may receive a Package Delivery.
 - **“UPS Rates”** refers collectively to Daily Rates (which are inclusive of Standard List Rates), Retail Rates, Alaska and Hawaii Rates, Letter Rates, Pak Rates, and UPS 10 KG Box and UPS 25 KG Box Rates.
 - **“UPS Returns® Services”** refers collectively to UPS Authorized Return®, Print Return Label, Electronic Return Label, and Print and Mail Return Label, 1 UPS Pickup Attempt, 3 UPS Pickup Attempts, UPS Returns® on the Web, and UPS Returns® Exchange.
 - **“UPS Smart Label”®** tag as defined here and described in the *UPS Guide to Labeling* includes but is not limited to the MAXI-CODE, postal code bar code, current UPS Routing Code, appropriate UPS service level icon, and UPS 1Z tracking number bar code.
 - **“UPS Worldwide Express Freight® Center”** means a UPS facility where Shippers may tender UPS Worldwide Express Freight® Service pallets to UPS for transportation, and a Consignee or other recipient may receive pallets.
- ### 3. Commodities Handled and Restrictions on Service
- UPS holds itself out to transport general commodities, as usually defined, subject to the following restrictions.
- The Shipper agrees to indemnify, defend, and hold harmless UPS and its affiliated companies, their officers, directors, employees, agents from all claims, demands, expenses, liabilities, causes of action, enforcement procedures, and suits of any kind or nature brought arising from or relating to a Shipment in violation of applicable law or regulation, or of these Terms.
- #### 3.1 Items Not Accepted for Transportation
- No service shall be rendered in the transportation of any of the prohibited articles listed in the applicable Service Guide or the Terms.
- UPS does not accept for transportation, and Shippers are prohibited from shipping:
- Articles of unusual value, which shall be deemed to include, but are not limited to:
 - Any Package with an actual value of more than \$50,000, except that the actual value of Packages declared in accordance with the Enhanced Maximum Declared Value provisions of Section 55.1 (“Maximum Declared Values”) cannot exceed \$70,000;
 - Any pallet with an actual value of more than \$100,000;
 - Coins, cash, currency, bonds, postage stamps, money orders, and negotiable instruments (such as drafts, bills of exchange, or promissory notes, but excluding checks);
 - Any article that contains more than 50 percent by weight of gold or platinum, or any combination thereof in raw form including, but not limited to, bullion, bars, or scraps of these metals.
 - Hazardous waste, defined as a solid waste that meets any of the criteria of the hazardous waste as described in 40 C.F.R. § 261.3;

UPS® Tariff/Terms and Conditions of Service – United States

- Human remains, fetal remains, human body parts, human embryos, or components thereof;
 - Common fireworks;
 - Replica or inert explosives or weapons that bear an appearance to actual explosives or weapons (except as a contractual service);
 - Packages containing marijuana, as defined in 21 U.S.C. § 802(16), including marijuana intended for medicinal use, and Packages containing Hemp, as defined in 7 U.S.C. § 1639o, when in plant form;
 - Packages using the same shipping label and tracking number as any other Package or a shipping label altered without UPS's express authorization. If any such Package is found in the UPS system, each such Package is subject to charge and UPS will apply Charges in its sole and unlimited discretion.
 - Packages with an actual weight of more than 150 pounds, or Packages that when measured to determine the billable weight exceed 108 inches in length, or exceed a total of 165 inches in length plus girth [(2 x width) + (2 x height)] combined. If found in the UPS system, they are subject to one or more of the following additional charges: Over Maximum Weight, Over Maximum Length, or Over Maximum Size. Such charges apply in addition to all other applicable Charges including, but not limited to, a Large Package Surcharge. UPS reserves the right in its sole and unlimited discretion to return such Packages to the Shipper at Shipper's expense;
 - Without prior approval by UPS, UPS Worldwide Express Freight® Service pallets that exceed maximum size or weight restrictions (which vary by origin and destination) as set forth at https://www.ups.com/assets/resources/media/wwef_max_dim.pdf. Such pallets are subject to an Oversize Pallet Handling Surcharge.
 - Shipments tendered (including pre-processed drop offs) to a Third-Party Retailer or UPS Access Point® location containing any hazardous materials requiring shipping papers, firearms, or ammunition. These prohibitions also apply to shipments delivered to a Third-Party Retailer or UPS Access Point location, except for ammunition that satisfies all requirements for the shipment of ammunition set forth in Section 3.7.2 ("Ammunition"), including qualifying for the exception for Limited Quantity packages;
 - UPS Returns® Services Shipments containing hazardous materials (except for Limited Quantity Ground Packages, as set forth below), or firearms, or requiring Delivery Confirmation Services; and
 - Any other items prohibited by the Service Guide, or on the [ups.com](https://www.ups.com) website.
- Shippers are prohibited from shipping and UPS will not accept for transportation Shipments containing articles that UPS is not authorized to accept or that UPS states in the Terms that it will not accept, including when such Shipments are tendered for transportation at UPS Customer Centers, UPS Worldwide Express Freight® Centers, UPS Access Point® locations, or any Third-Party Retailer.
- UPS reserves the right, but is not required, to return to the Shipper any Shipment containing a prohibited article. Such return will be made solely at the Shipper's risk and expense. UPS also reserves the right in its sole and unlimited discretion to dispose of a prohibited article found in the UPS system.
- ### 3.2 Maximum Values
- UPS does not accept for service Packages with values as set forth below:
- Any Package with an actual value of more than \$50,000, or \$70,000 for Packages declared in accordance with the Enhanced Maximum Declared Value provisions of Section 55.1 ("Maximum Declared Values");
 - Packages with a value of \$1,000 or more shipped via a Third-Party Retailer or UPS Access Point® location (including a UPS Access Point® locker) if such Packages were processed for shipment using a UPS Shipping System prior to drop off at the Third-Party Retailer or UPS Access Point® location or billed using Bill My Account;
 - Packages processed for shipment prior to tender using a UPS Shipping System and tendered to a UPS driver or UPS Customer Center with a value of more than \$1,000, unless a UPS high-value shipment summary is obtained by the Shipper or person tendering the Package and signed by the driver or UPS Customer Center representative upon tender of the Package;
 - Packages shipped or delivered to a UPS Access Point® location with a value of \$5,000 or more;
 - Domestic Packages with a value of more than \$1,000 returned via Print Return Label, Print and Mail Return Label, Electronic Return Label, or 1 UPS Pickup Attempt Return Services;
 - International Shipments with a value of more than \$1,000 per Package or pallet returned via UPS Print Return Label, UPS Print and Mail Return Label, Electronic Return Label, 1 UPS Pickup Attempt, or 3 UPS Pickup Attempts Return Services (including via UPS Returns® on the Web) unless a UPS high-value shipment summary is obtained by the Shipper or person tendering the Shipment and signed by the driver or UPS Customer Center representative upon tender of the Shipment;
 - International UPS Import Control® Shipments with a value of more than \$1,000 per Package or pallet unless a UPS high-value shipment summary is obtained by the Shipper or person tendering the Shipment and signed by the driver or UPS Customer Center representative upon tender of the Shipment;
 - Packages with a value of more than \$500 shipped via a UPS Drop Box;
 - Prepaid Letters with a value of more than \$100;
 - Packages with a value of more than \$999 when Shipper Release is selected;
 - Packages with a C.O.D. amount in excess of \$500 shipped via a UPS Drop Box;
 - UPS Worldwide Express Freight® Service Shipments having a value of more than \$100,000 per pallet.
- ### 3.3 Prohibited by Law
- No service shall be rendered by UPS in the transportation of any Shipment that is prohibited by applicable law or regulation of any federal, state, provincial, or local government in the origin or destination country. It is the responsibility of the Shipper to ensure that a Shipment tendered to UPS, and any UPS Shipping System entry that the Shipper prepares for that Shipment, does not violate any federal, state, provincial, or local laws or regulations applicable to the Shipment.

UPS® Tariff/Terms and Conditions of Service – United States

3.4 Alcoholic Beverages

Packages containing alcoholic beverages (wine, beer, or spirits) are accepted for transportation only as a contractual service and only from Shippers who are licensed and authorized under applicable laws to ship alcoholic beverages. To receive service for Packages containing alcoholic beverages, the Shipper must enter into an approved UPS agreement for the transportation of wine, beer, or spirits, as applicable. For all Packages containing alcoholic beverages, the Shipper must use Delivery Confirmation Adult Signature Required service requesting an adult signature for each Package containing alcoholic beverages, and must affix a special UPS alcoholic beverages label to each Package. For all U.S. inbound import Shipments containing alcoholic beverages, the Receiver must be licensed and authorized to receive the alcoholic beverages. It is the responsibility of the Shipper to ensure that a Package tendered to UPS does not violate any federal, state, or local laws or regulations applicable to the Package.

UPS reserves the right to dispose of any alcoholic beverages tendered for shipment which Shippers are prohibited from shipping, which UPS is not authorized to accept, which UPS states that it will not accept, or which UPS has a right to refuse. UPS reserves the right to discontinue service to any Shipper for, among other reasons, tendering a Package containing alcoholic beverages that does not comply with all applicable laws or the Terms.

3.5 Marijuana and Hemp

Shipment of Marijuana, as defined in 21 U.S.C. § 802(16), is prohibited under any circumstances. Shipment of Hemp, as defined in section 297A of the Agricultural Marketing Act of 1946, is also prohibited when in plant form (including parts of the plant, except as set forth in 21 U.S.C. § 802(16)(B)(ii)). Products made from Hemp (including cannabidiol) are accepted for shipment only as permitted by state and federal law, including compliance with the Food, Drug & Cosmetic Act, 21 U.S.C. § 321, et seq. Shippers are prohibited from shipping Hemp products except as allowed under all applicable law, and it is the responsibility of the Shipper to ensure compliance with all such laws.

UPS reserves the right to dispose of any shipment containing Marijuana, Hemp, or Hemp products tendered for shipment

which Shippers are prohibited from shipping, which UPS is not authorized to accept, which UPS states that it will not accept, or which UPS has a right to refuse. UPS reserves the right to discontinue service to any Shipper for, among other reasons, tendering a Package containing Marijuana, Hemp, or Hemp products that do not comply with all applicable laws or the Terms. See [ups.com/hemp](https://www.ups.com/hemp) for additional information.

3.6 Biological Materials

UPS accepts Packages containing “Biological Substance, Category B” as defined in 49 C.F.R. § 173.134, which are prepared in accordance with all aspects of 49 C.F.R. § 173.199.

Transportation of other biological materials is limited, must be prearranged, and will only be provided under the following conditions: the Shipper has received prior written authorization from UPS for the specific Package tendered; and the Shipper requests service in accordance with the conditions set forth in the written authorization from UPS for the Package tendered. Any Package containing biological materials shall be considered a Perishable Commodity.

3.7 Firearms and Ammunition

UPS accepts Packages containing firearms or ammunition only pursuant to the following limitations.

3.7.1 Firearms

UPS accepts Packages containing firearms (as defined by Title 18, Chapter 44, and Title 26, Chapter 53 of the United States Code) only (a) between licensed importers, licensed manufacturers, licensed dealers, and licensed collectors (as defined in Title 18, Chapter 44 of the United States Code), and government agencies; and (b) where not otherwise prohibited by federal, state, or local law from (i) an individual to a licensed importer, licensed manufacturer, licensed dealer or licensed collector; and (ii) from a licensed importer, licensed manufacturer, licensed dealer, or licensed collector to an individual. The Shipper shall comply with and shall ensure that each Shipment containing firearms complies with all federal, state, and local laws applicable to the Shipper, recipient, and Package, including, without limitation, age restrictions.

– The Shipper must use Delivery Confirmation Adult Signature Required and Direct Delivery Only services for

each Package containing a firearm (including handguns). UPS, in its sole and unlimited discretion, may require the Shipper to select a UPS Next Day Air® delivery service for any Package containing a firearm. Handguns (as defined by 18 U.S.C. § 921) will be accepted for transportation only via a UPS Next Day Air delivery service.

– Firearms (including handguns) are accepted for transportation only via Scheduled Pickup Service or at a UPS Customer Center. Firearms (including handguns) are not accepted for transportation via UPS Drop Boxes or in response to a request for UPS On-Call Pickup® service, and are not eligible for Delivery Change Requests (including, but not limited to, requests reroute) or UPS My Choice® requests, or drop-off or pickup at UPS Access Point® locations or Third-Party Retailers. UPS Returns® Services are not available for Packages containing firearms.

– Firearm parts, which do not constitute firearms as defined under federal law (including without limitation Title 18, Chapter 44, and Title 26, Chapter 53 of the United States Code), and which otherwise comply with federal, state, and local law, will be accepted for transportation.

– Firearms (including handguns) and firearm parts are not accepted for shipment internationally. Replicas or simulated firearms are not accepted for shipment internationally except as a contractual service.

See www.ups.com/content/us/en/resources/ship/packaging/guidelines/firearms.html or contact UPS for more information.

3.7.2 Ammunition

UPS accepts ammunition for transportation where such ammunition constitutes “cartridges, small arms,” as defined in 49 C.F.R. § 173.59. The Shipper shall comply with and shall ensure that each Shipment containing ammunition complies with all federal, state, and local laws applicable to the Shipper, recipient, and Package, including, without limitation, age restrictions.

– Ammunition will be transported only when packaged and labeled in compliance with 49 C.F.R. § 172 (Hazardous Materials), and must be shipped in accordance with the *UPS Guide for Shipping Ground and Air Hazardous Materials*. Ammunition may not be shipped in the same package as a firearm.

UPS® Tariff/Terms and Conditions of Service – United States

- To meet the exception for Limited Quantity, ammunition can be shipped via UPS Ground only within the 48 contiguous United States or UPS Ground Intra-Oahu and Intra-Alaska. All other allowable ammunition Shipments are accepted only on a contractual basis, and must be prepared under the rules for a fully regulated hazardous material. See further details in Section 3.11 (“Limited Quantity Packages”).
- Ammunition is not accepted for shipment internationally.

See www.ups.com/content/us/en/resources/ship/packaging/guidelines/firearms.html or contact UPS for more information.

3.8 Food Transport; Assumption of Legal Responsibility

Shipments containing “food,” as defined in section 201(f) of the Federal Food, Drug, and Cosmetic Act, will be accepted for transportation only according to the following terms. Shipper assumes all responsibility with respect to establishing and maintaining all records required under 21 C.F.R. Part 1 Subpart J §§ 1.326-1.363. In so doing, Shipper assumes the legal responsibility under 21 C.F.R. § 1.363 for establishing and maintaining records that would otherwise be required to be maintained by UPS. Shipper agrees its records will comply with 21 C.F.R. § 1.352 and shall identify the immediate recipient of the transported food; the origin and destination points of shipment; the date the Shipment is received and the date released; the number of Packages shipped; a description of the freight describing the type of food received and released; and the route of movement. Shipper agrees expressly to make all records required by 21 C.F.R. § 1.352 available to FDA as required by 21 C.F.R. § 1.361. Shipper commits, and recognizes that it has the responsibility, to ensure that all such records are maintained consistent with the record retention requirements provided in 21 C.F.R. § 1.360 and the record availability requirements provided in 21 C.F.R. § 1.363. Shipper agrees that within 45 days of the date of shipment, Shipper will obtain or request from UPS any information needed from UPS to satisfy Shipper’s responsibility to establish and maintain records. Shipper recognizes that the foregoing obligations with respect to establishing and maintaining records cannot be terminated. Shipper expressly agrees to immediately assume

responsibility to establish and maintain records as provided in this paragraph, regardless of any FDA-designated compliance date for any provision of 21 C.F.R. Part 1 Subpart J.

3.9 Hazardous Materials Service

Hazardous Materials, defined as those materials regulated under Title 49 of the Code of Federal Regulations (49 C.F.R.) (excluding Limited Quantity Ground Packages, as referenced below), and Dangerous Goods, defined as those materials regulated by the International Civil Aviation Organization (ICAO) and published in the International Air Transport Association (IATA) Dangerous Goods Regulations (collectively referred to as “Hazardous Materials,” or “Dangerous Goods,” or “International Dangerous Goods”), are accepted for transportation only as a contractual service and in accordance with the *UPS Guide for Shipping Ground and Air Hazardous Materials*, or the *UPS Guide for Shipping International Dangerous Goods*. To receive Hazardous Materials or Dangerous Goods service, the Shipper must sign and agree to the provisions set forth in an approved UPS agreement or agreements relating specifically to the transportation of Hazardous Materials, Dangerous Goods, or International Dangerous Goods (“Hazardous Materials Agreement(s)"). Contact UPS for specific information, including a list of “Common Items That May Be Classified as Hazardous Materials.”

An additional charge will be assessed for each Hazardous Materials Shipment. If the Shipper fails to select a service level, provide the Dangerous Goods Class, or identify that a Shipment is not fully regulated, the Shipment will be charged at the highest level of service, as Accessible Dangerous Goods, as fully regulated, or any combination of the above based on the Shipper’s failure to provide sufficient information to UPS. UPS may also assess an additional surcharge for Packages or pallets containing certain types of Hazardous Material. Applicable surcharges are described in the Service Guide and at the ups.com website.

It is the Shipper’s responsibility to determine if a Shipment contains a Hazardous Material and to properly classify, label, mark, and package it in accordance with applicable governmental regulations. When required, the Shipper is responsible for ensuring that all of its employees

involved in the preparation of Hazardous Materials for transport are properly trained, tested, and certified in accordance with 49 C.F.R. Part 172.700 through 172.704, or with IATA (Section 1.5) and for ensuring that a program exists for the retraining, testing, and certification as required by these rules.

All packaging used by the Shipper for the transportation of Hazardous Materials, when required by regulation, must pass UN performance testing in accordance with 49 C.F.R. Part 178.602 through 178.609 or IATA (Section 6.0).

The Shipper must use a software system, such as the most current version of WorldShip® software that is acceptable to UPS for the preparation of documents for shipping Hazardous Materials, or an alternative method determined by UPS in its sole and unlimited discretion to perform the same functions. UPS will provide Shippers, upon request, a list of vendors who provide acceptable software systems.

UPS reserves the right to refuse to accept, to return, or to dispose of, in compliance with applicable laws and regulations, any Hazardous Material that it determines not to have been prepared in accordance with the *UPS Guide for Shipping Ground and Air Hazardous Materials*, the *UPS Guide for Shipping International Dangerous Goods*, and all applicable governmental laws and regulations. The Shipper agrees to reimburse UPS for any costs or expenses incurred as a result of any improperly packed or prepared Hazardous Materials which Shipper tenders to UPS. In addition, the Shipper agrees to reimburse UPS for any costs or expenses incurred by UPS if Hazardous Materials tendered by the Shipper are refused by the Shipper upon return or cannot otherwise be delivered for any reason including, but not limited to, wrong delivery address or refusal of Receiver to accept Delivery.

UPS reserves the right, in its sole and unlimited discretion and without prior notice to the Shipper, to dispose of any international Shipment containing Dangerous Goods refused by the Receiver or which for any other reason cannot be delivered. Shipper shall be responsible for all disposal fees.

The Shipper agrees to indemnify, defend, and hold harmless UPS, its parent corporation, and affiliated companies, their officers, directors, employees, agents, and their

UPS® Tariff/Terms and Conditions of Service – United States

successors and assigns, from all claims, demands, expenses (including reasonable attorney's and consultants' fees), liabilities, causes of action, enforcement procedures, and suits of any kind or nature brought by a governmental agency or any other person or entity arising from or relating to the transportation of a Hazardous Materials Shipment, from the Shipper's breach of the Hazardous Materials Agreement(s) or the Terms, or from the Shipper's non-compliance with governmental laws or regulations applicable to the transportation of Hazardous Materials whether such action is brought by a governmental agency or other person or entity. Under no circumstances shall UPS be liable for special, incidental, or consequential damages arising from the transportation of a Hazardous Materials Shipment.

Pursuant to 49 C.F.R. Part 173.30, in the event the Shipper loads any UPS vehicle, the Shipper agrees to segregate Hazardous Materials in accordance with 49 C.F.R. Part 177.848 and properly secure Hazardous Materials in accordance with 49 C.F.R. Part 177.834.

UPS does not accept Hazardous Materials in any amounts that require placarding under 49 C.F.R. Part 172, Subpart F. The Shipper agrees not to tender Hazardous Materials to UPS in any amount for a single vehicle that would require placarding in accordance with 49 C.F.R. Part 172, Subpart F.

UPS reserves the right to discontinue or terminate service immediately with respect to the transportation of Hazardous Materials if the Shipper fails to comply with any provisions of the Terms, or any applicable government regulations (including Limited Quantity Shipments that are tendered without the proper shipping documentation). If a Shipper tenders an undeclared Hazardous Materials Shipment to UPS, UPS shall not be liable for the Shipment in the event of loss, damage, delay, or misdelivery, nor shall UPS be liable for any special, incidental, or consequential damages.

If the Shipper ships Hazardous Materials from more than one location, and the Shipper fails to comply with any provisions of the Terms, the Hazardous Materials Agreement(s), or any governmental regulations, UPS may, in its sole and unlimited discretion, terminate all of the Shipper's shipment locations or limit such termination to those locations where the failure to comply occurred.

Shippers are prohibited from shipping and UPS will not accept for transportation Shipments containing any Hazardous Materials requiring shipping papers (defined as those materials regulated under Title 49 of the Code of Federal Regulations) or Dangerous Goods requiring Shipper's Declaration for Dangerous Goods documents, when such Shipments are presented for shipment at UPS Customer Centers, Third-Party Retailers, or UPS Access Point® locations. Hazardous Materials requiring shipping papers cannot be picked up via UPS On-Call Pickup® service, or retrieved via any UPS Returns® Service, except as a contractual service. UPS Ground with Freight Pricing service is not available for Hazardous Materials Shipments (unless the Package qualifies as a Limited Quantity Package as set forth in Section 3.11 ("Limited Quantity Packages")).

Additional terms applicable to the shipment of Hazardous Materials are set forth in the *UPS Guide for Shipping Ground and Air Hazardous Materials*, and the *UPS Guide for Shipping International Dangerous Goods*, the terms of which are each incorporated here by this reference and available at <https://www.ups.com/content/us/en/resources/ship/hazardous>.

3.10 Dry Ice

Packages containing dry ice (carbon dioxide, solid) as a refrigerant, but no other Hazardous Materials, are accepted for transportation within the United States via UPS Ground and UPS Air Services (provided such Packages are prepared in accordance with all applicable governmental regulations) without a Hazardous Materials Agreement. Packages containing Hazardous Materials that use dry ice (carbon dioxide, solid) as a refrigerant are accepted for transportation within the United States via UPS Ground and UPS Air Services only as a contractual service. Any Package containing dry ice will be considered a Perishable Commodity. Packages containing dry ice may be tendered for shipment at The UPS Store® locations, where such services are available. A contract is required for all international Shipments of dry ice.

3.11 Limited Quantity Packages

Limited Quantity Packages are accepted for transportation without Hazardous Materials shipping papers and without a contract, only within the 48 contiguous United States via UPS Ground, UPS

Ground with Freight Pricing service, and UPS Hundredweight Service® Ground, and via UPS Standard to Canada and UPS Ground Intra-Alaska and Intra-Oahu services, when properly classified, packaged and marked, provided the Shipper has reviewed the required checklist and service restrictions with a UPS representative. Limited Quantity Packages shipped via UPS Air Services and UPS 3 Day Select® service within the United States and Puerto Rico are accepted for transportation on a contractual basis only. Limited Quantity Packages containing ammunition are not accepted for shipment internationally.

3.12 Hazardous Waste, Mercury, and Mercury-Containing Waste

Packages containing hazardous waste, defined as a solid waste that meets any of the criteria of hazardous waste as described in 40 C.F.R. § 261.3, are not accepted for transportation.

UPS's acceptance for transportation of any elemental mercury, mercury-containing material, or used mercury-containing device (including, but not limited to, medical devices, spent fluorescent lamps, thermostats, or thermometers) is limited, must be prearranged, and will only be provided pursuant to prior written authorization from UPS upon satisfaction of certain requirements including appropriate packaging and financial assurances.

3.13 Live Animals

UPS provides service on a limited basis for some types of live animal Shipments. (The term "animal" as used here refers to anything living, except plants.) Live animals may be shipped only pursuant to the restrictions and conditions set forth on the [ups.com](https://www.ups.com) website regarding Shipping Live Animals. A live animal Shipment will be considered a Perishable Commodity. Access <http://www.ups.com/content/us/en/resources/ship/packaging/guidelines/animals.html> or contact UPS for information regarding shipping live animals.

3.14 Perishable Commodities

UPS does not provide a protective service for the transportation of Perishable Commodities. Such commodities will be accepted for transportation solely at the Shipper's risk for any damage arising from the perishable nature of the item. Shippers shall not file claims for, and UPS shall not be liable to Shippers or any third parties for, any damage arising from the transportation of Perishable Commodities

UPS® Tariff/Terms and Conditions of Service – United States

arising from exposure to heat or cold or the perishable nature of the item, regardless of whether the Shipment is delivered pursuant to an applicable UPS Service Guarantee or is delayed in transit. UPS reserves the right to dispose of any Shipment in the UPS system containing a Perishable Commodity that UPS deems in its sole and unlimited discretion to be of no value, unsafe or unsanitary.

3.15 Pharmaceuticals

The Shipper shall comply with and shall ensure that each Shipment containing pharmaceutical products complies with all applicable federal, state, provincial, and local laws and regulations governing the dispensing, shipment or tender of shipment of pharmaceutical products.

3.16 Portable Electronic Devices

UPS transports Shipments containing radio frequency identification devices (RFID), ultrawideband devices (UWB), and other portable electronic devices (PED) only when such devices are in an inactivated state or otherwise in compliance with applicable law including 14 C.F.R. § 91.21, 14 C.F.R. § 121.306, or 47 C.F.R. § 15.521(a).

3.17 Tobacco and Vaping Products

Shipments containing Tobacco Products ("Tobacco Product Shipments"), are accepted for transportation only from Shippers who are licensed and authorized to ship Tobacco Products pursuant to applicable laws. UPS does not provide service to any person or entity listed in the Bureau of Alcohol, Tobacco, Firearms and Explosives PACT Act – Non-Compliant List.

For purposes of the UPS Tariff/Terms and Conditions of Service, the term "Tobacco Products" is defined at www.ups.com/tobacco. Shippers should consult www.ups.com/tobacco for the current definition of Tobacco Products, as the definition may change periodically. At present, and without limiting the complete definition posted at www.ups.com/tobacco, the term "Tobacco Products" includes any product made or derived from tobacco that is intended for human consumption, including any component, part, or accessory of a tobacco product; the term includes, without limitation, e-cigarettes, e-hookah, e-cigars, vape pens, advanced refillable personal vaporizers, and electronic pipes.

UPS prohibits the shipment of Cigarettes or Little Cigars (as those terms are defined at ups.com/tobacco) to consumers. UPS also prohibits the shipment of all Vaping

Products (as the term is defined at ups.com/tobacco) throughout its U.S. domestic network, including import and export, regardless of nicotine content and destination state. To make other Tobacco Product Shipments, the Shipper must sign, agree to, and comply with the provisions set forth in an approved UPS agreement for the transportation of Tobacco Products. Shippers and receivers must comply with all applicable federal, state, provincial, or local laws or regulations, and all Tobacco Product Shipments must conform to the terms, conditions, restrictions, and prohibitions set forth at www.ups.com/tobacco at the time of shipping. It is the responsibility of the Shipper to ensure that a Shipment tendered to UPS, including a Tobacco Product Shipment, does not violate any federal, state, provincial, or local laws or regulations applicable to the Shipment. For all Tobacco Product Shipments, the Shipper must use Delivery Confirmation Adult Signature Required service requesting an adult signature at the time of delivery. UPS reserves the right to refuse to accept, transport, or deliver any Tobacco Product Shipment that UPS, in its sole and unlimited discretion, determines does not comply with UPS requirements for the shipment or any applicable law or regulation, and to discontinue any or all service to any Shipper for, among other reasons, tendering such a Shipment. UPS reserves the right to dispose of any Tobacco Product Shipment that Shippers are prohibited from shipping, that UPS is not authorized to accept, that UPS states that it will not accept, or that UPS has a right to refuse.

3.18 Prohibited Item Fee

Packages that contain any of the prohibited articles listed in the applicable Service Guide or the Terms are subject to additional charges, including but not limited to a Prohibited Item fee, if found in the UPS system. Packages that contain restricted articles not in compliance with all UPS policies and procedures and applicable laws and regulations are also subject to additional charges, including but not limited to a Prohibited Item fee, if found in the UPS system. Such charges apply in addition to all other applicable Charges and in addition to any other rights to recovery UPS may have under the Terms or applicable law. UPS reserves the right in its sole and unlimited discretion to dispose of such Packages, submit such Packages to governmental authorities, or return such Packages to the Shipper solely at the Shipper's risk and expense. The Shipper

agrees to reimburse UPS for any costs or expenses incurred as a result of Shipper tendering any such Packages to UPS, including but not limited to all disposal fees.

4. Provisions for Export and Customs Clearance of International Shipments

The Shipper (or the party tendering an international Shipment to UPS for service, referred to for purposes of this Section 4 as "Shipper") is responsible for compliance with all applicable U.S. export control requirements, and must provide UPS with all documentation and information required by the laws of the origin and destination countries for export and import of Shipments (i.e., for export and customs clearance). The Shipper is responsible for determining export and import licensing or permitting requirements for a Shipment, obtaining any required licenses and permits, and ensuring that the Consignee is authorized by the laws of the origin and destination countries to receive the Shipment. The Shipper must regularly review its import and export transactions and immediately notify UPS of any incorrect or incomplete information provided, including information filed with, or otherwise transmitted (whether in writing or electronically) to, a U.S. or other governmental agency. By tendering an international Shipment for service and providing UPS with documentation (including any Source Documents), the Shipper certifies that the documentation includes all required licenses and permits, that the statements in that documentation and any other information that the Shipper provides to UPS relating to exportation and importation are complete, true, correct, and in compliance with the laws of the origin and destination countries, and that the Consignee is authorized by the laws of the origin and destination countries to receive the Shipment. Furthermore, the Shipper understands that civil and criminal penalties including seizure and forfeiture, may be imposed for failing to provide UPS with all required documentation, licenses, permits, statements, and information, for making inaccurate, false, or fraudulent statements, or for violating U.S. or other country laws regulating exports or imports (see, e.g., 13 U.S.C. § 305; 18 U.S.C. §§ 545, 554 and 1001; 19 U.S.C. §§ 1595a and 1592; 22 U.S.C. § 401; and Subchapter C of 15 C.F.R. (i.e., The Export Administration Regulations)).

Shipper further authorizes UPS to share information generally considered

UPS® Tariff/Terms and Conditions of Service – United States

confidential under 19 CFR 111.24 or any applicable laws, rules, or regulations of countries other than the United States that govern the confidentiality of customs brokerage data, including but not limited to information concerning points of contact, addresses and telephone numbers, revenue, and customs entry data, with corporations owned by or under common ownership with UPS, with corporations owned and operated by United Parcel Service, Inc., Delaware, or with UPS's authorized service providers incidental to their provision of services.

When an international Shipment is tendered to UPS, UPS is thereby appointed as the agent for performance of customs clearance in the destination country to the extent allowed by law. The Shipper shall provide all Powers of Attorney and other authorizations required by applicable law for UPS to serve as the Shipper's agent to perform customs clearance in the destination country. UPS is specified as the nominal Consignee for the purpose of designating a customs broker to perform customs clearance. Local authorities may require documentation confirming that UPS has been designated as the nominal Consignee.

Fines, penalties, liquidated damages, storage charges, or other expenses incurred as a result of an action by U.S. Customs and Border Protection (or any other U.S. or other country's government agency regulating imports or exports), or as a result of the failure of the Shipper or Consignee to provide complete, true, and correct documentation, statements, or information required by the laws of the origin and destination countries (including the failure to obtain a required license or permit) will be charged to the Shipper or Consignee along with any applicable duties, fees, or taxes, and any applicable late payment fees assessed by UPS. Unless a written agreement between UPS and the Shipper specifies otherwise, UPS reserves the right in its sole and unlimited discretion to charge the Shipper or Consignee for any such fines, penalties, liquidated damages, storage charges, expenses, duties, fees, taxes, or late payment fees. Regardless of any such written agreement specifying otherwise, in the event of non-payment by the Consignee, the Shipper is liable for all Charges.

The Shipper agrees to indemnify, defend, and hold harmless UPS, its parent corporation, and affiliated companies, their officers, directors, employees, agents, and their successors and assigns, from any and

all claims, demands, expenses, or liabilities including, but not limited to, fines, penalties, liquidated damages, storage charges, duties, fees, taxes, late payment fees, or other money due, arising from the transportation, importation, exportation, or customs clearance of Shipments on behalf of the Shipper, or arising from the Shipper's noncompliance with the laws of the origin and destination countries, or UPS requirements applicable to the Shipment.

UPS provides routine customs clearance through UPS Supply Chain Solutions® brokerage offices designated by UPS for handling customs clearance of Shipments at no additional charge, except for UPS® Standard to and from Canada Shipments, for which a brokerage service charge applies. Other UPS Supply Chain Solutions® customs brokerage offices charge fees for the clearance of Packages and freight. For UPS Standard to Mexico, UPS Supply Chain Solutions® customs clearance is required. Failure to do so will result in Packages automatically returned to Shipper.

Additional charges may apply for complex customs clearance procedures, which include, but are not limited to, the following:

- Clearance procedures involving a government agency other than U.S. Customs and Border Protection;
- Customs Bonds;
- Drawbacks;
- Formal entries involving more than three tariff lines;
- Live Entries;
- Country of Origin Marking; or
- Temporary Import Bonds (T.I.B.).

UPS is under no obligation, unless the customer requests in writing and UPS agrees in writing, to undertake any pre- or post-importation action including, but not limited to, obtaining binding rulings, advising of liquidations, filing protests, or filing petitions for relief.

UPS may prepay duties, fees, or taxes on behalf of the payer. For importation into the United States, a fee will be assessed and billed to the importer. A fee may also apply for shipments to other countries.

For any claims arising from import, export or customs clearance activities, the liability of UPS (including UPS Supply Chain Solutions) shall be limited to the lesser of (i) \$50 per entry, filing, or transaction; or (ii) the amount of fees paid to UPS for such entry, filing, or transaction.

4.1 Electronic Export Information

If Electronic Export Information (EEI) is required to be filed through the Automated Export System (AES) under the Foreign Trade Regulations of the U.S. Bureau of the Census ("Census") (i.e., Part 30, 15 C.F.R.), and the Shipper has not filed the EEI and provided an Internal Transaction Number (ITN) to UPS to confirm that an EEI transaction was submitted to Census by the Shipper accepted and is on file in the AES, UPS will electronically file the required EEI on behalf of the Shipper, provided that all information required to file the EEI is supplied by the Shipper in the UPS Shipping System or other export documentation and UPS has received proper authorization or a Power of Attorney from the Shipper to complete and file the EEI. A processing fee will be assessed and billed to the Shipper. The Shipper is solely responsible for determining whether EEI is required to be filed through the AES for its shipment and for ensuring that the EEI is accurately and timely filed, whether by the Shipper or by UPS acting as the filing agent on behalf of the Shipper.

4.2 Certificate of Origin

UPS may, based solely on information that the Shipper furnishes, prepare a Certificate of Origin for goods manufactured and originating within the United States on behalf of the Shipper when one is required but not included with the export documents provided by the Shipper. When authorizing UPS to prepare a Certificate of Origin, the Shipper certifies that the information it provides to UPS is complete, true, and correct and that the completed Certificate of Origin complies with the laws of each country where a claim will be made that the goods are manufactured and originate in the United States. A processing fee will be assessed and billed to the Shipper.

4.3 UPS Paperless® Invoice Service

A Shipper must register with UPS and accept the UPS SCS Paperless Invoicing Terms and Conditions in advance of shipping to use UPS Paperless Invoice service, where such services are available. The Shipper also acknowledges that, by continuing to use UPS Paperless Invoice service, the Shipper is accepting any updates and revisions to the UPS SCS Paperless Invoicing Terms and Conditions. By using UPS Paperless Invoice service (via a UPS Automated Shipping System or any other method, including, but not limited to, an API platform or a third-party system) or any

UPS® Tariff/Terms and Conditions of Service – United States

other means on a UPS Automated Shipping System to electronically generate a paperless invoice, the Shipper authorizes UPS to use the Shipper's letterhead and electronic signature and the data, documents, and information that the Shipper provides to generate true, correct, and paperless invoices that reflect, in all material respects, the Shipper's actual commercial invoice and the Shipper's sale transactions of merchandise to its buyers (i.e., the "Sold To" Parties) and that are necessary to expedite in accordance with law the export and customs clearance of international Shipments. The Shipper shall provide to UPS in advance all required information including, but not limited to, the true and accurate price at which the merchandise was sold to the "Sold To" Party, any required additions to customs value (e.g., dutiable commissions, royalty/license fees, assists, packing costs, and proceeds of subsequent sales), the currency of the sale, country of origin, terms of sale, the quantities, ultimate Consignee, and a complete commercial description of the merchandise. By using the service, Shipper represents and certifies that the data, documents, and information the Shipper provides is true, complete, and accurate and that the paperless invoice the Shipper prepares is, in all material respects, an electronic copy of the actual commercial invoice provided to the buyer. The Shipper shall have an affirmative, non-delegable duty to disclose to UPS any and all required commercial invoice information, in accordance with 19 C.F.R. Part 141, Subpart F (Invoices) for shipments entering the United States and any other laws governing valuation and invoicing requirements of other countries of destination or origin, and to ensure its accuracy and completeness. The Shipper shall maintain and produce to UPS, if requested, a copy of the original commercial invoice (between the buyer and the seller) and provide timely upload of PLD to use UPS Paperless Invoice service.

4.4 Pre-Release Notification for Import Shipments

A Shipper or Consignee may request that UPS notify the Consignee prior to submission of a U.S. import Shipment to U.S. Customs and Border Protection so that the importer may validate the classification, valuation, or other import information. An additional fee applies for this service and will be billed to the importer or to the Shipper when the Shipper is selected as the payer of the duties and taxes for the Shipment.

4.5 Record-Keeping

The Shipper agrees and consents that UPS may preserve a record of the carriage for an international Shipment using means other than producing a copy of the air waybill. The Shipper has a duty to and is solely liable for maintaining all records as required under the export and customs or other laws of the origin and destination countries, unless otherwise agreed to in writing. UPS assumes no responsibility to act as a record-keeper or record-keeping agent for the Shipper.

5. UPS Import Control® Service

UPS Import Control® service allows a Shipper to process an import Shipment, including commercial invoice. Where available, a Shipper may use UPS Import Control® service to create a Print Import Label, Electronic Import Label, or Print and Mail Import Label to provide to the sender or party tendering the Shipment to UPS, or a Shipper may request 1 UPS Pickup Attempt or 3 UPS Pickup Attempts to request that UPS make pickup attempts to retrieve import Shipments from a sender's address. 3 UPS Pickup Attempts is not available for UPS Worldwide Express Freight® Service Shipments. UPS Import Control® service is available only in countries where UPS pickup services are available. An additional charge will be assessed for each unique UPS Import Control label.

Shipments containing certain items are prohibited from being shipped and are not accepted by UPS for UPS Import Control® service including, but not limited to, Hazardous Materials Shipments requiring shipping papers, firearms, or Shipments requiring Delivery Confirmation Services. C.O.D. service is not available for UPS Import Control® Shipments.

The maximum actual or declared value for each UPS Import Control® Shipment is \$50,000 per Package and \$100,000 per pallet, provided that, for any UPS Import Control® Package or pallet with an actual or declared value in excess of \$1,000, the Shipper must ensure that a UPS high-value shipment summary is generated and signed by the UPS driver or UPS Customer Center representative upon tender of the Shipment to UPS. If no high-value shipment summary is obtained and signed, the maximum actual or declared value of each such Package or pallet is limited to \$1,000.

Notwithstanding anything herein to the contrary, for all UPS Import Control® Shipments tendered to UPS for export from the U.S., that transit the U.S., or that contain U.S.-origin goods, the sender or tendering party is the exporter for purposes of the Export Administration Regulations ("EAR"), and it shall be responsible for determining licensing authority (license, license exception, or NLR) and obtaining the appropriate license or other authorization as provided in Section 4 ("Provisions for Export and Customs Clearance of International Shipments"). In no event shall a party arranging for UPS Import Control® service provide a writing assuming responsibility for determining licensing requirements and obtaining license authority for any UPS Import Control Shipment to the tendering party. UPS does not agree to serve as the exporter for purposes of the EAR.

6. Right of Inspection

UPS reserves the right in its sole and unlimited discretion to open and inspect any Shipment tendered to it for transportation, but is not required to do so.

7. Refusal of Service

UPS reserves the right to refuse to provide service, among other reasons, for any Shipment which by reason of the dangerous or other character of its contents may, in the sole judgment of UPS, soil, taint or otherwise damage other Shipments or UPS's equipment, or which is improperly or insecurely packed or wrapped, as determined by UPS in its sole judgment.

Before accepting any Shipment, UPS reserves the right to require sufficient verification, as determined by UPS in its sole and unlimited discretion, of the Shipper's name and address, or any other information necessary to accept the Shipment for service. UPS reserves the right to refuse to provide service for any Shipment or to or from any location, or to provide alternative service arrangements, or to intercept, hold or return any Shipment when, among other reasons, UPS, in its sole and unlimited discretion, determines that it is unsafe or economically or operationally impracticable to provide service, that its services are being used in violation of federal, state, or local law, or for fraudulent purposes, or when the account of the person or entity responsible for payment is not in good standing.

UPS® Tariff/Terms and Conditions of Service – United States

8. Packaging

It is the responsibility of the Shipper to ensure that proper packaging is used and that contents are adequately and securely packed, wrapped, and cushioned for transportation. Shipments must be so packed or wrapped as to meet UPS's published standards related thereto set forth in the Service Guide, or on the ups.com website, and as to pass tests set forth in the International Safe Transit Association ("ISTA") Procedure 3A, Procedure for Testing Packaged Products, published by ISTA. Acceptance of tender by UPS is not an indication that a Package is packed in accordance with UPS's published standards. In addition, any tested product must be free from damage and the packaging must afford reasonable protection as determined by UPS in its sole judgment.

Shipments containing goods of high value or high risk, including without limitation jewelry, pharmaceuticals, computers, hand-held electronic devices, mobile telephones, and electronic components of these, must not have labels, customized shipping labels (including as created in a UPS Automated Shipping System), markings, logos, or other written notice of contents contained within the Package.

The use of UPS-provided packaging is not a guarantee that an item is sufficiently packaged for transportation. UPS does not provide special handling for Shipments with "Fragile," orientation markings (e.g., "UP" arrows or "This End Up" markings), or any other similar such markings.

When shipping media of any type containing sensitive personal information (such as personal financial or health information), it is recommended that the Shipper retain a copy of the data and secure the data on the media through encryption or other technological means. UPS is not liable or responsible for loss of, damage to, or irretrievability of data stored on media of any type, or for loss of information, including without limitation personal, health or financial information. For the shipment of electronic media, or for breakable items, see the packaging guidelines located at the ups.com website. The guidelines advise against the use of UPS Express® Envelopes, UPS Express® Pak, or UPS Express® Pad Paks to ship sensitive personal information or breakable items.

UPS Worldwide Express Freight® Service Shipments must be palletized, stackable, able to be lifted by forklift, and shrink-wrapped or banded to a skid. Shipper must

ensure that pallets and packaging comply with all applicable laws and regulations of the origin and destination country.

9. Use of UPS-Provided Materials and Services

UPS-provided materials including, but not limited to, packaging materials and supplies, envelopes, labels, label printers, shipping documents, publications and products are provided solely for the use of UPS Shippers to obtain UPS services on their behalf and to interact with UPS. Any other use of such UPS-provided materials is strictly prohibited.

UPS Express® Envelopes, UPS Express® Pak, UPS Express® Boxes, UPS Express® Tubes, UPS 10 KG Box and UPS 25 KG Box packaging may not be used for UPS® Ground, UPS® Standard, UPS 3 Day Select®, or UPS Worldwide Expedited® Shipments.

Under no circumstances may a Shipper sell any UPS-provided materials, products, or services to any third party without prior written authorization from UPS.

A weekly charge applies for use of UPS-provided thermal label printers.

10. Use of UPS Accounts

UPS account holders are prohibited from permitting the use of their UPS accounts by any third party to process or tender a Shipment to UPS without prior written approval from UPS. UPS account holders are also prohibited from using their UPS accounts to process or tender a Shipment to UPS on behalf of any third party without prior written approval from UPS.

11. Use of UPS Electronic Information Systems

Use of UPS electronic information systems to which Shippers are granted access by UPS and which are accessed by means of hardware, software, or internet interfaces, including UPS Shipping Systems, are subject to and will be governed by the terms in effect at the time of shipping for the relevant system, including without limitation, the UPS Technology Agreement, the iShip® Master Enterprise Service Agreement, the ConnectShip® End User License Agreement, or that agreement licensing use of a UPS Ready® solution.

12. Timely Upload of PLD; Missing PLD Fee

The Shipper must provide Timely Upload of Package Level Detail ("PLD") to UPS.

If timely upload of PLD is not provided, certain UPS services are unavailable, including but not limited to Direct Delivery Only, Ship to a UPS Access Point® location, UPS Delivery Intercept® service, and UPS Proactive Response® service. Timely Upload of PLD as used in these Terms refers to the electronic transmission of all applicable PLD information to UPS at or before the time that Shipments are tendered to UPS. PLD includes, but is not limited to, Consignee's full name, complete delivery address, and Shipment dimensions and weight. If Shipper does not upload all applicable PLD information to UPS, UPS reserves the right to determine missing PLD to be used for invoice purposes in its sole and unlimited discretion, up to and including maximum size and weight for the applicable service. In addition, a processing fee will be charged for missing PLD if Shipper does not upload all applicable PLD information to UPS prior to Package Delivery.

12.1 Use of PLD Obtained Email Addresses and Telephone Numbers

By including the email address or telephone number of the Consignee or associated addressee in PLD for a Shipment ("PLD Contact(s)"), the Shipper acknowledges and agrees that UPS may use such PLD Contact(s) and may send notifications to the Shipment's associated PLD Contact(s) related to the delivery of such Shipment and actions the PLD Contact(s) may take with respect to the Shipment. The PLD Contact(s) may be invited to enroll in UPS My Choice® to take these actions. The Shipper warrants that (i) informed and specific consent, in compliance with all applicable laws, rules, and regulations (including, where applicable, of the jurisdiction of Consignee's domicile), has been secured from the individual associated with each PLD Contact to receive notifications from UPS related to the delivery of such Shipments and actions the PLD Contact(s) may take with respect to the Shipment and for use by UPS of the PLD Contact(s) as provided above, and that (ii) the PLD Contact(s) is accurate and is controlled by the Consignee or associated addressee for the Shipment with which it is associated. Shipper will store such consents and, upon request by UPS, make available such consents to UPS.

The Shipper shall defend, indemnify and hold harmless UPS, its parent corporation, and affiliated companies, their officers, directors, employees, agents, and their

UPS® Tariff/Terms and Conditions of Service – United States

successors and assigns, from and against any and all liability, losses, damages, costs and expenses (including reasonable legal fees) of any nature whatsoever incurred or suffered in connection with damages arising out of or resulting from any breach of the warranties in the previous paragraph.

The Shipper agrees that UPS and its representatives may contact the Shipper at any telephone number UPS has on file for the Shipper, including through the use of auto-dialed and/or prerecorded calls and text messages.

13. ZIP Code/Postal Code Information

The Receiver's ZIP Code is a required part of the address for domestic Shipments. When available, ZIP+4 should be used. The Receiver's postal code, telephone number, and contact name are required parts of the address for international Shipments.

14. P.O. Boxes

UPS does not provide Delivery to a P.O. Box. The Shipper must make every effort to obtain a street address. If the Shipper should use a P.O. Box address, the recipient's telephone number must be included. A Package addressed to a P.O. Box may experience delays, is not covered by any UPS Service Guarantee, and is subject to an Address Correction charge. Army Post Office (APO) and Fleet Post Office (FPO) addresses are not accepted.

15. UPS Customer Center and UPS Worldwide Express Freight® Center

Before accepting a Shipment tendered for transportation or releasing any Shipment at a UPS Customer Center or a UPS Worldwide Express Freight® Center to a Consignee or other recipient, UPS reserves the right to require sufficient verification, as determined by UPS in its sole and unlimited discretion, of the Shipper's or recipient's name, address, authorization to ship or receive the Shipment, or any other information UPS deems necessary to accept or release the Shipment in its sole and unlimited discretion. Persons tendering or picking up Shipments on behalf of a business may be required to provide identification issued by the business and a government-issued identification. A Residential Consignee will be required to provide a government-issued identification. UPS reserves the right to require

payment to be made at Customer Centers and UPS Worldwide Express Freight® Centers by payment card only.

16. Third-Party Retailer

The UPS Store® locations are independently owned and operated by licensed franchisees of The UPS Store, Inc., a subsidiary of United Parcel Service, Inc., and are not agents of UPS. Other Third-Party Retailers are independently owned and operated businesses and are not agents of UPS. UPS assumes no liability other than to the Third-Party Retailer as the Shipper of the Package, for lost, damaged or delayed Packages sent by the Third-Party Retailer. Any such liability to the Third-Party Retailer is subject to the limitations set forth in the Terms. All inquiries regarding Packages shipped by any Third-Party Retailer must be directed to the Third-Party Retailer that shipped the Package. UPS will deal solely with the Third-Party Retailer in all matters concerning Packages shipped by any Third-Party Retailer including, but not limited to: tracking/tracing requests; claims and guarantees; C.O.D. preparation and remittance; return of undeliverable Packages; proper packaging and labeling; and billing. Even if UPS responds directly to customers of the Third-Party Retailer regarding tracking requests, UPS will not be liable to those customers. The Third-Party Retailer is solely responsible for the issuance of any refunds and claims to those who shipped Packages by the Third-Party Retailer. For any Package shipped by the Third-Party Retailer with a declared value in excess of \$1,000, the Third-Party Retailer must provide a copy of the high-value control log to UPS at the time of tender of the Package. The Third-Party Retailer shall not ship any articles which UPS does not accept for transportation. The Third-Party Retailer shall indemnify and hold harmless UPS in any action against UPS arising from the loss, damage, or delay of a Package shipped by the Third-Party Retailer.

17. UPS Access Point® Locations

Packages that may be received for Delivery or tendered for shipment (meaning, Packages that have been processed for shipment prior to tender using a UPS Shipping System only) at a UPS Access Point® location are subject to restrictions, including, without limitation, in regard to weight and size and actual and declared value, as set forth in the applicable Service Guide and on the

[ups.com](https://www.ups.com) website. Subject to modification by the Shipper, UPS Access Point® locations will hold Packages for up to seven (7) calendar days. Refer to tracking detail for Package-specific information, including but not limited to, the last available pickup date. Shipments not picked up within seven (7) calendar days (or other time selected by the Shipper) will be considered undeliverable, and may be returned to the Shipper. See further details in Section 37 ("Special Handling of Undeliverable Shipments; Refused Shipments Returned"). Before accepting a Shipment tendered for transportation or releasing any Shipment at a UPS Access Point® location to a Consignee or other recipient, a Shipper, Consignee, or other recipient may be required to produce sufficient verification of the Shipper's or recipient's name, address, authorization to ship or receive the Shipment, and any other information UPS deems necessary to accept or release the Shipment in its sole and unlimited discretion, including, without limitation, provision of government-issued identification.

17.1 Ship to a UPS Access Point Location Service

Subject to an additional charge and where available, Shippers with a valid UPS account may ship Packages directly to a UPS Access Point location to be picked up by the Consignee.

Shipper will require the Consignee to select its preferred means of notification from UPS (where available, e-mail, text message, or telephone call) and to provide a valid e-mail and/or phone number for notification. Shipper will transfer Consignee's preferred means of notification email and/or telephone number (where available) to UPS as part of the package level detail required for correct delivery of each package. UPS may, as a service provider on behalf of Shipper and where available, provide by email, text, or phone call notifications relating to the Shipment to the Consignee via the Consignee's preferred means of notification.

Where Shipper provides an e-mail address or phone number, Shipper does so pursuant to Section 12.1 ("Use of PLD Obtained Email Addresses and Telephone Numbers").

UPS will deliver Ship to a UPS Access Point location packages to the designated location. Delivery attempts to the designated

UPS® Tariff/Terms and Conditions of Service – United States

UPS Access Point location constitute a delivery attempt for the purposes of the UPS Service Guarantee. Delivery is deemed complete when the package is delivered to the designated UPS Access Point location.

Additional service options for Ship to a UPS Access Point location service must be selected when the Package is processed for shipment, where available and subject to additional charges.

Additional terms, restrictions and requirements are set forth in the Service Guide for the applicable destination country and at https://www.ups.com/media/en/ShiptoUPSAccessPointlocation_US_EN.pdf, which are each incorporated herein by this reference.

17.2 Ship to a UPS Access Point Location Service – Deliver to Addressee Only

If the Deliver to Addressee Only option is selected, the Package may only be picked up by the person identified on the shipping label. Pickup by any Third Party is not permitted. The Deliver to Addressee Only option is subject to an additional charge.

17.3 Ship to a UPS Access Point Location Service – Package Release Code

If the Package Release Code option is selected, the Shipper must enter a four- to six-digit numeric code when processing the Package for shipment and provide the code to the person picking up the package. The Shipper is solely responsible for generating, maintaining, and transmitting the Package Release Code. The Shipper must also provide all other information required to comply with UPS policies and procedures and applicable laws and regulations, including but not limited to customs requirements, as part of the PLD. There is no additional charge for the Package Release Code option.

The Package Release Code must be presented to pick up the Package. Any person who presents the Package Release Code may pick up the Package. UPS cannot provide the Package Release Code to the Shipper, the Consignee, or any other person at any time. UPS shall not be liable for any loss, damage, or costs of any kind arising out of or relating to loss of or unauthorized access, acquisition, use, modification, disclosure, or destruction of the Package Release Code.

18. Pickup Services – Scheduled

UPS offers the following Scheduled Pickup Services:

– *Daily Pickup*: When Daily Pickup service is selected, UPS will call on Shipper's location once each business day to pick up Packages. UPS may not call upon a location on any day in which the account indicates that there are no Packages available for pickup.

– *Daily On-Route Pickup*: When Daily On-Route Pickup service is selected, UPS will call on Shipper's location each business day to pick up Packages while making deliveries in Shipper's area.

– *Day-Specific Pickup*: When Day-Specific Pickup is selected, UPS will call on Shipper's location each business day as preselected by Shipper. Shipper may select up to four business days per week for Day-Specific Pickup.

– *UPS Smart Pickup® service*: When UPS Smart Pickup® service is selected, UPS will call on Shipper's location any business day when the Shipper transmits PLD using the current version of WorldShip® software, UPS CampusShip® software, or [ups.com](https://www.ups.com) shipping, by the deadline designated by UPS, or if Shipper has scheduled a pickup by telephone or through the [ups.com](https://www.ups.com) website, prior to the deadline designated by UPS.

For Daily Pickup, Daily On-Route Pickup, and Day-Specific Pickup, a weekly service charge based on the account's weekly billing total, as reflected in the UPS billing system, will be assessed. The weekly billing total may not necessarily reflect all Packages tendered during a calendar week. For UPS Smart Pickup® service, a weekly service charge will be assessed.

Scheduled Pickup Services are not available for any UPS Worldwide Express Freight® Service.

19. UPS On-Call Pickup® Service

When UPS On-Call Pickup® service is requested by the Shipper, UPS will arrange (where reasonably practicable) a pickup at the Shipper's location. An additional charge for UPS On-Call Pickup® service will be assessed.

UPS On-Call Pickup® service from a Residential address will be assessed an additional surcharge for residential pickup. If the Residential address is in a remote or

less accessible area as designated by UPS, an additional surcharge for extended area or remote Residential pickup also will apply.

UPS On-Call Pickup® service must be requested for each UPS Worldwide Express Freight® Service Shipment pickup or drop-off (for door-to-door and non-door-to-door services), and may not be combined with a Package pickup. No additional charge for UPS On-Call Pickup® service applies to any UPS Worldwide Express Freight® Service.

20. Saturday Air Processing Fee; Saturday Export Processing Fee; Saturday Stop Charge

UPS offers Saturday pickup of UPS Air Services Packages and UPS Hundredweight Service® Air Services Shipments for Delivery in the United States and Puerto Rico where such services are available and subject to a processing fee. UPS offers Saturday pickup of UPS Worldwide Express Plus, UPS Worldwide Express, and UPS Worldwide Saver Shipments for Delivery to select destination countries where such services are available and subject to a processing fee. Saturday pickup is available for domestic UPS 3 Day Select® Service, UPS Ground, UPS Ground with Freight Pricing, UPS Hundredweight Service® UPS 3 Day Select, and UPS Hundredweight Service Ground Shipments in select areas (these areas are referred to here as "Saturday Ground Service Territories"). Within Saturday Ground Service Territories, a Saturday Stop Charge that varies depending on the type of pickup service selected will apply any time the Shipper requests that UPS pick up any Packages on a Saturday, in addition to any Saturday Air Processing fee(s), regardless of whether there are packages to be picked up that day. Refer to the Service Guide for an explanation of applicable charges associated with pickup service on Saturdays.

The Shipper should contact UPS for information regarding UPS's Saturday pickup area. Refer to UPS's website for Delivery commitment information applicable to Packages picked up on Saturday. Saturday pickup service is provided by the following methods:

– A Shipper may request Saturday pickup via UPS On-Call Pickup® service by contacting UPS on or in advance of each Saturday, excluding holidays, on which the service is needed.

UPS® Tariff/Terms and Conditions of Service – United States

- At the Shipper's option, UPS will call at the Shipper's premises every Saturday, excluding holidays, to pick up qualifying Shipments.
- Shippers with UPS Smart Pickup service may schedule a Saturday pickup by processing a qualifying Package for pickup each Saturday, excluding holidays, on which the service is needed. Refer to Section 18 ("Pickup Services—Scheduled") for additional information regarding scheduling a pickup via UPS Smart Pickup service.

The Saturday Air Processing fee (formerly referred to as a "Saturday Pickup" charge) will be assessed for each UPS Air Services Package or each UPS Hundredweight Service® Air Services Shipment processed using a UPS Shipping System, tendered to UPS, or tendered to a Third-Party Retailer on a Saturday, in addition to any applicable UPS On-Call Pickup® charge and Saturday Stop Charge.

The Saturday Export Processing Fee will be assessed for each UPS Worldwide Express Plus, UPS Worldwide Express, or UPS Worldwide Saver Shipment processed using a UPS Shipping System, tendered to UPS, or tendered to a Third-Party Retailer on a Saturday, in addition to any applicable UPS On-Call Pickup® charge and Saturday Stop Charge.

Where a Saturday pickup is requested but there are no Packages to be picked up, a minimum processing fee will be assessed outside Saturday Ground Service Territories.

21. Drop Shipment

A unique Drop Shipper account number will be assigned to approved Shippers and must be used solely for the origin and destination locations as specified in the UPS Drop Ship Letter of Understanding or as required by UPS.

UPS reserves the right to refuse any Drop Shipment request, in its sole and unlimited discretion, including, but not limited to, any Drop Shipment that is operationally or economically impracticable to transport. A request for Drop Shipment service is not reasonable unless the Shipper makes a prior arrangement with UPS, agreed to in advance by UPS, as to timing, location, and volume of the Drop Shipment.

When a Shipper, through prior arrangements with UPS, tenders Packages at UPS's

receiving stations with a return address requiring a movement greater than a Zone 2 movement from the point of tender, any undelivered Packages will be returned automatically and will be charged at the rate applicable between the point of tender and the return address. The effective UPS Rates for the applicable shipment will apply.

UPS does not accept, and Shippers are prohibited from shipping, any Package via a Drop Shipment that contains Hazardous Materials, except for Limited Quantity Packages that are tendered for UPS Ground service in the 48 contiguous United States.

22. Delivery

UPS does not limit Delivery of a Shipment to the person specified as the Receiver in the UPS Shipping System. Unless the Shipper uses Delivery Confirmation service requiring a signature, UPS reserves the right, in its sole and unlimited discretion, to make a Delivery without obtaining a signature.

23. Direct Delivery Only Surcharge

Where available and subject to a Direct Delivery Only surcharge, UPS may in its sole and unlimited discretion accept a Shipper's request to limit (1) reroutes of Packages to an alternate address by the Consignee (including but not limited to Delivery Change Requests and UPS My Choice® requests, other than requests to hold for will call at a UPS Customer Center) and (2) delivery to a UPS Access Point® location following a first delivery attempt at a Residential address.

Packages containing firearms must use Direct Delivery Only service.

Direct Delivery Only does not limit UPS Delivery Intercept® requests or Delivery pursuant to UPS's driver release or Shipper Release procedures, and does not require signature on Delivery or Delivery to the person specified as the Receiver in the UPS Shipping System. The Shipper must provide timely upload of PLD to request Direct Delivery Only.

24. Residential Surcharge

A Residential Surcharge will apply if either the delivery address entered in the UPS Shipping System or the actual delivery address is considered Residential (regardless of a Shipper's designation of the address as Commercial).

25. Delivery Area Surcharge

A Delivery Area Surcharge or Extended Delivery Area Surcharge will apply to each Package delivered to certain ZIP Codes within the 48 contiguous states. A Remote Area Surcharge will apply to each Package delivered to, and any UPS On-Call Pickup service from, certain ZIP Codes within Alaska and Hawaii. Refer to the Area Surcharge listing at [ups.com/rates](https://www.ups.com/rates) for the listings of effective applicable ZIP Codes for the Delivery Area Surcharge, Extended Delivery Area Surcharge and Remote Area Surcharge.

A Delivery Area Surcharge, Extended Delivery Area Surcharge or Remote Area Surcharge, respectively, will apply if either the delivery (or pickup, where applicable) address entered in the UPS Shipping System or the actual delivery (or pickup, where applicable) address falls within ZIP Codes designated by UPS as subject to such charges. Such charges apply in addition to all other applicable Charges, including but not limited to the Residential Surcharge.

26. Delivery Attempts; UPS Access Point® Locations

If UPS is unable to deliver a Shipment, a notice will be left at the Consignee's address stating that Delivery has been attempted. Thereafter, a second and, if necessary, a third attempt to deliver the Shipment may be made without additional charge. Shipments not delivered after three attempts will be considered undeliverable and may be returned to the Shipper. See further details in Section 37 ("Special Handling of Undeliverable Shipments; Refused Shipments Returned").

For Residential deliveries and where available, UPS may in its sole and unlimited discretion, after the first delivery attempt, deliver a Shipment to a UPS Access Point® location, where such Shipment will be held for pickup. Requests for subsequent Delivery attempts are subject to additional Charges which will be assessed to the Consignee. For UPS Worldwide Express Freight® Service Shipments, only one Delivery attempt will be made and subsequent Delivery attempts are subject to additional charges which will be assessed to the Consignee. Refer to Section 31 ("Delivery Change Requests") for further information.

UPS® Tariff/Terms and Conditions of Service – United States

27. Hold for Pickup and Hold at Location Services

At the time a Shipper tenders a Shipment to UPS, the Shipper may request that UPS hold a domestic Package at a designated UPS Customer Center for pickup by the Consignee. For each such Shipment, the Shipper will complete an address label showing the words “Hold for Pickup,” the Consignee’s name, telephone number, the name of a contact person, and the full address of the designated UPS Customer Center. In addition, the Shipper will apply a UPS Hold for Pickup label below the address label on the Shipment. Hold for Pickup is not available for international Package shipments.

For UPS Worldwide Express Freight® Service Shipments, the Shipper may request that UPS hold a UPS Worldwide Express Freight® Service Shipment at a UPS Worldwide Express Freight® Center location for pickup by the Consignee (Hold at Location). For each such Shipment, the Shipper will complete an address label showing the words “Hold for Pickup,” the Consignee’s name, telephone number, the name of a contact person, and the full address of the Consignee (designated UPS Worldwide Express Freight® Center address not required).

UPS will hold the Shipment at the designated UPS Customer Center or UPS Worldwide Express Freight® Center and will attempt to contact the Consignee at the telephone number shown on the label. Shipments not picked up within seven (7) calendar days from the date of arrival will be considered undeliverable.

28. Shipper Release

A Shipper may request that UPS release a Shipment on the first Delivery attempt. When Shipper Release is selected, UPS will make only one Delivery attempt, a signature will not be obtained upon Delivery, and a UPS Delivery record showing a completed Shipper Release delivery shall be conclusive proof that Delivery was completed. Shipper Release is provided solely at the Shipper’s risk of loss or damage arising from the release of the Shipment by UPS and UPS will not be liable for any damages arising from the release of the Shipment.

29. UPS carbon neutral

A Shipper may request that UPS offset the climate impact of a Shipment via UPS carbon neutral service by selecting UPS carbon neutral at the time a Shipment is tendered to UPS. By selecting UPS carbon neutral, UPS will purchase and retire in the appropriate registry a sufficient number of voluntary or regulatory carbon credits as determined by UPS in its sole and unlimited discretion to offset calculated carbon dioxide emissions. UPS carbon neutral is available only for Shipments shipped using a UPS Automated Shipping System. An additional charge will be assessed for each Package or pallet.

30. UPS Delivery Intercept® Service

After a domestic Package has been tendered to UPS but before Delivery, a Shipper may request that UPS return a Package to the Shipper, reroute a Package (including a request by Shipper to correct an address, or where a Package has been returned to the Shipper after a Delivery attempt), hold the Package for pickup at a UPS Customer Center, or hold a Package for future Delivery. UPS may in its sole and unlimited discretion also accept a UPS Delivery Intercept® request from a Third Party when the Shipper has requested that the Third Party’s UPS account number be billed for such Package. UPS will honor a UPS Delivery Intercept® request in its sole and unlimited discretion where practicable and where the Shipper has guaranteed payment of applicable Charges resulting from the change. UPS shall not be liable for any damages whatsoever for failure or refusal to comply with a UPS Delivery Intercept® request.

An additional charge, set forth in the UPS Rates applicable to the Shipment in effect at the time of the request will be assessed for each Package returned to the Shipper, rerouted, or held for future Delivery. If a request to reroute a Package requires a Package movement from the original Receiver address beyond a UPS Zone 2, additional Charges also will apply. Such additional Charges will be calculated as a newly-initiated Shipment between the original Receiver address and the new rerouted address, and will include (but not be limited to) all applicable surcharges. All original Charges will continue to apply as if the Package were delivered to the original Receiver address. For a request

to return to the Shipper, all applicable Charges will apply and be assessed to the Shipper, as set forth in Section 37 (“Special Handling of Undeliverable Shipments; Refused Shipments Returned”).

The Shipper must provide timely upload of PLD to initiate a UPS Delivery Intercept® request.

31. Delivery Change Requests

After the Receiver has received notice from UPS that Delivery has or will be attempted, the Receiver may request that UPS hold a Package for pickup at a UPS Customer Center. In addition, a Commercial Receiver may request that UPS return a Package to the Shipper before Delivery is attempted. After the Receiver has received notice from UPS that Delivery has been attempted, the Receiver may request that UPS return a Package to the Shipper, hold for future Delivery, reroute a Package, direct eligible Packages to a UPS Access Point® location, redeliver to the original address a Package that was taken to a UPS Access Point location, or other such Delivery Changes as UPS in its sole and unlimited discretion may offer (collectively, “Delivery Change”). A UPS InfoNotice® tag is required for requests to reroute.

An additional charge set forth in the UPS Rates applicable to the Shipment in effect at the time of the request will be assessed to the Consignee for each Package rerouted, redelivered, directed to a UPS Access Point location, or held for future Delivery by a Delivery Change Request. If any Delivery Change Request requires a Package movement from the original Receiver address beyond a UPS Zone 2, additional Charges also will apply and be assessed to the Consignee. Such additional Charges will be calculated as a newly-initiated Shipment between the original Receiver address and the new rerouted address, and will include (but not be limited to) all applicable surcharges. All original Charges will continue to apply as if the Package were delivered to the original Receiver address. For a request to return to Shipper, all applicable Charges will apply and be assessed to the Shipper, as set forth in Section 37 (“Special Handling of Undeliverable Shipments; Refused Shipments Returned”).

For UPS Worldwide Express Freight® Service pallets, after the Receiver has received notice from UPS that Delivery

UPS® Tariff/Terms and Conditions of Service – United States

will occur, the Receiver may request that UPS hold a pallet at a UPS Worldwide Express Freight® Center. After the Receiver has received notice from UPS that Delivery has been attempted, the Receiver may request that UPS return a pallet to the Shipper, hold for future Delivery, or make a Delivery Reattempt. Delivery Reattempt charges will apply to subsequent attempts to deliver UPS Worldwide Express Freight® Service Shipments beyond the first Delivery attempt. For requests to return to the Shipper, all applicable Charges will apply and be assessed to the Shipper.

UPS will honor a Delivery Change Request in its sole and unlimited discretion where practicable and where the Receiver has guaranteed payment of any applicable Charges resulting from the change. By requesting a Delivery Change, the Receiver acknowledges and agrees that the limitations of liability set forth in the Terms in effect at the time of Shipment apply to the Shipment subject to the Delivery Change Request and that the value originally declared by the Shipper, if any, shall continue to apply throughout the course of transportation pursuant to the Delivery Change Request. UPS assumes no liability other than to the Shipper of the Shipment for loss, damage, or delay of any Shipment subject to Delivery Change.

UPS may restrict Delivery Change Requests at the request of the Shipper. Delivery Change Requests for Packages containing firearms are not available. Delivery Change Requests to reroute or direct to a UPS Access Point location are not available for international Packages. It is the responsibility of the Receiver to ensure that a Delivery Change Request complies with all federal, state and local laws and regulations applicable to the Shipment.

32. Correction of Addresses

If any Shipment as addressed by the Shipper has an incorrect or incomplete address (examples include, but are not limited to, P.O. Boxes, missing suite, apartment, or unit numbers, old addresses, and missing/incorrect ZIP Codes), UPS will make reasonable efforts, to be determined in its sole and unlimited discretion, to secure the correct or complete address. An address validated by UPS may be incorrect or incomplete for purposes of completing Delivery, and may be corrected by UPS. If the correct or complete address is secured, UPS, at its sole and unlimited discretion, will attempt Delivery, and the

Shipper, upon request, will be provided with the correct or complete address in order to update its internal records. UPS may in its sole and unlimited discretion correct or complete an address based on information obtained from the Shipper or Consignee. An address correction charge will be assessed to the Shipper for an address correction or completion.

33. Saturday Delivery

UPS offers Saturday Delivery by request for certain Delivery areas for certain UPS Air Services and international services, as set forth in the Service Guide. To request Saturday Delivery for these services, a Shipper must indicate the selection in the UPS Shipping System and attach a Saturday Delivery routing label to each Package or pallet. Refer to UPS's website for available Saturday Delivery areas for these services. Where Saturday Delivery is requested, an additional charge will be assessed for each such Shipment for Saturday Delivery and will be billed to the payer of the Charges.

Saturday Delivery is also available without an additional charge for certain Delivery areas for certain UPS Air Services and international services, but not by request. Refer to UPS's website for Saturday Delivery commitment information for these services. Where Saturday Delivery is available for such Shipments, a Saturday routing label is not required.

UPS offers Saturday Delivery by request to Commercial delivery addresses within Saturday Ground Service Territories for UPS 3 Day Select, UPS Ground, UPS Ground with Freight Pricing, UPS Hundredweight Service UPS 3 Day Select, and UPS Hundredweight Service Ground Shipments. To request Saturday Delivery for these services, a Shipper must indicate the selection in the UPS Shipping System. Refer to UPS's website for available Saturday Delivery areas for these services. Where Saturday Delivery is requested, an additional charge will be assessed for each such Shipment for Saturday Delivery and will be billed to the payer of the Charges.

Saturday Delivery is also available within Saturday Ground Service Territories for UPS 3 Day Select, UPS Ground, UPS Ground with Freight Pricing, UPS Hundredweight Service UPS 3 Day Select, UPS Hundredweight Service Ground, UPS Standard from Canada, and UPS Standard from Mexico Shipments, but not by request. Refer to UPS's website or

call 1-800-PICK-UPS® (1-800-742-5877) for Saturday Delivery commitment information for these services. Where Saturday Delivery is available for these services, there is no additional charge, except as set forth herein. Commercial Consignees in Saturday Ground Service Territories must pay for a Saturday Stop Charge – Scheduled Pickup and opt in to be eligible to receive such deliveries on Saturday.

34. Delivery Confirmation Services

UPS provides the following Delivery Confirmation Services. An additional charge applies for each service:

34.1 Delivery Confirmation (domestic only)

A Shipper may request Delivery Confirmation Service by indicating Delivery Confirmation in a UPS Automated Shipping System. Delivery Confirmation information will include the date of Delivery and either the name of the recipient or the disposition of the Package; or, in the event of a return, the reason for the return and the date processed. Delivery Confirmation information is available online or by mail. Where applicable, only valid UPS accounts will receive responses via mail.

34.2 Delivery Confirmation Signature Required (domestic and international)

A Shipper may request UPS to obtain the recipient's signature on Delivery. The Shipper must use a UPS Automated Shipping System to initiate a request for this service. UPS may obtain, at its sole and unlimited discretion, a signature, other electronic acknowledgment of receipt or authorization to release without a signature upon delivery pursuant to the UPS My Choice® service from the recipient when this option is selected. Delivery Confirmation information, including signatures where applicable, is available online.

34.3 Delivery Confirmation Adult Signature Required (domestic and international)

A Shipper may request UPS to obtain the signature of an adult 21 years of age or older on Delivery. UPS, in its sole and unlimited discretion, will determine if Delivery can be completed when such a request is made, and may request photo identification indicating the recipient's age, before completing Delivery. The Shipper must use a UPS Automated Shipping System to initiate a request for this service. UPS reserves the right to assess the Shipper the additional charge for this service when the Shipper requests UPS to obtain

UPS® Tariff/Terms and Conditions of Service – United States

an adult signature on Delivery and an approved UPS label is not affixed to the Package or pallet indicating such request, or, the Shipper tenders a Package or pallet that, based upon its contents, requires an approved UPS label requesting an adult signature upon Delivery and no such label has been affixed to the Package or pallet. Delivery Confirmation information, including signatures where applicable, is available online.

35. Proof of Delivery (P.O.D.)

Upon request, UPS will provide proof of Delivery of a Shipment via fax transmission, email, or mail. The request must include a fax number, including area code, for an operating fax machine, an email address for email delivery, or an address deliverable by the United States Postal Service for mail.

36. Tracking/Tracing and Refund Request Charge

UPS reserves the right to assess a Shipper an additional charge per request for each Tracking/Tracing and Refund Request initiated by or at the request of the Shipper. This charge will not be assessed for the first 50 tracking requests per calendar week, or for a quantity of tracking requests equal to or less than 20 percent of the Shipper's volume for that week, whichever is greater. This charge will not be assessed for a quantity of tracing requests equal to or less than two percent of the Shipper's volume for that week. UPS also reserves the right to assess the Shipper a charge set forth in the effective UPS Rates for Service Guarantee refund requests when the subject Shipment was delivered in accordance with the applicable UPS Service Guarantee in the effective Terms.

37. Special Handling of Undeliverable Shipments; Refused Shipments Returned

Shipments refused by the Consignee, or which are undeliverable for any reason, will be returned to the Shipper at Shipper's expense, including, but not limited to, forwarding costs, return transportation charges and all other applicable Charges, duties, and taxes. Such Charges will be calculated as a newly-initiated Shipment between the original delivery address and the return address, and will include (but not be limited to) all applicable surcharges. All original Charges will continue to apply

as if the package were delivered to the original delivery address. Undeliverable international Shipments returned to the Shipper also are subject to an undeliverable Shipment surcharge set forth in the effective UPS Rates. The UPS Service Guarantee does not apply to undeliverable Shipments returned to the Shipper.

UPS reserves the right to dispose of a Shipment, including salvage (for salvaged Shipments, after retention of the Shipment for a reasonable period of time as determined by UPS, not to exceed 30 days) if the Shipment is refused by the Consignee or for any other reason cannot be delivered, and return of the Shipment is refused by the Shipper or the Shipment cannot otherwise be returned to the Shipper for any reason. UPS's right to dispose of a package includes, but is not limited to, situations where UPS determines in its sole and unlimited discretion that it is unsafe or economically or operationally impracticable to provide delivery or return service. The Shipper or Consignee's sole recourse in such circumstances shall be in accordance with and subject to Sections 54 ("Claims and Legal Actions: Individual Binding Arbitration of Claims") and 55 ("Responsibility for Loss or Damage").

38. C.O.D. Service

UPS accepts C.O.D. Packages for Delivery in the United States and Puerto Rico. C.O.D. service is not provided for international Shipments except for international Shipments originating in Canada for Delivery in the United States. C.O.D. service is not available for UPS Worldwide Express Freight Services from any origin.

38.1 Preparation and Listing of C.O.D. Packages

Shippers not using a UPS Automated Shipping System must prepare and attach to each C.O.D. Package a UPS® C.O.D. tag showing the amount to be collected and enter such amount in the space provided for that purpose.

Shippers using a UPS Automated Shipping System will generate, and apply to each C.O.D. Package, a system-generated address label with a C.O.D. bar code and the amount to be collected for each individual Package. Each C.O.D. Package in a UPS Hundredweight Service® or UPS Ground with Freight Pricing C.O.D. Shipment must carry a C.O.D. tag or system-generated label for the goods contained in that Package.

38.2 Responsibility for C.O.D.s

Upon Delivery of each C.O.D. Package, UPS will attempt to collect the amount shown on the C.O.D. tag or the system-generated label attached to the Package and transmit to the Shipper the amount so collected (subject to the terms in Section 38.9, "Remittance of C.O.D.s," below), or, if collection cannot be made, will return the Package to the Shipper. The Shipper must notify UPS within 45 days from the date of shipment of a C.O.D. Shipment if the Shipper has not received payment of the C.O.D. amount, or any claim relating thereto shall be deemed waived. Suits shall be instituted within two years after denial of any portion of the claim.

If collection cannot be made within three Delivery attempts, or the Consignee refuses Delivery, UPS will return the Package to the Shipper.

38.3 Consignee's Checks in Payment of C.O.D.s

Unless instructions to collect a cashier's check or money order only are shown on the C.O.D. tag (in conformity with the instructions on the tag) or system-generated label, UPS will accept a check or other negotiable instrument issued by or on behalf of the Consignee. When instructions to collect a cashier's check or money order only are clearly indicated on the C.O.D. tag or system-generated label, UPS reserves the right to accept a cashier's check, money order, official bank check, or other similar instrument issued by or on behalf of the Consignee.

All checks or other negotiable instruments (including cashier's checks, official bank checks, money orders, and other similar instruments) tendered in payment of C.O.D.s will be accepted by UPS based solely upon the Shipper assuming all risk relating thereto, including, but not limited to, risk of non-payment, insufficient funds, and forgery, and UPS shall not be liable upon any such instrument.

All checks or other negotiable instruments (including cashier's checks, official bank checks, money orders, and other similar instruments) will be transmitted to the Shipper together with UPS's own check if Consignee check(s) collected are for less than the C.O.D. amount. Remittances (checks, money orders, etc.) received that are less than the C.O.D. dollar amount indicated by the Shipper will be reimbursed for the full amount unless the variance of the amount remitted is less than \$1.00.

UPS® Tariff/Terms and Conditions of Service – United States

38.4 C.O.D. Package of \$10,000 or More

UPS may require payment for any C.O.D. Package of \$10,000 or more to be received in a single check or other negotiable instrument such as a cashier's check, money order, official bank check, or other similar instrument.

38.5 Acceptance of Personal Check

In the event that UPS accepts a personal or company check when a Shipper has properly instructed UPS to collect a cashier's check or money order only, UPS reserves the right, in its sole and unlimited discretion, to deposit into a UPS account the personal or company check collected and to provide the Shipper with a check issued by UPS.

38.6 C.O.D. Remittance Verification

In the event that a Shipper timely notifies UPS that the Shipper has not received payment of the C.O.D. amount, if UPS's records show that it collected a C.O.D. payment and the remittance has not been cashed, UPS may, in its sole and unlimited discretion, provide the Shipper with a digital image of the check or money order along with a C.O.D. Remittance Verification in order to assist the Shipper in locating the missing C.O.D. payment. If the Shipper is still unable to locate the C.O.D. payment, UPS may, in its sole and unlimited discretion, provide the Shipper with an indemnified C.O.D. check or money order, which is a digital image of the original payment collected by UPS at the time of Delivery and can be deposited in a bank, provided that the original check or money order has not previously been deposited or negotiated. If the indemnified check or money order turns out to be invalid for any reason including, but not limited to, insufficient funds or forgery, UPS shall not be liable upon the instrument.

38.7 Restrictions

C.O.D.s are accepted for amounts up to \$50,000 per Package.

C.O.D. Packages with an amount to be collected in excess of \$500 are not accepted for transportation via a UPS Drop Box.

Entry of a C.O.D. amount is not a declaration of value for carriage. Payment of the C.O.D. charge does not constitute payment of the declared value charge.

UPS will not accept currency in any amount for payment of C.O.D. Shipments.

38.8 Charges for C.O.D. Collections

An additional charge will be assessed for each C.O.D. Package tendered to UPS.

38.9 Remittance of C.O.D.s

Subject to the following provisions of this Section, UPS shall remit C.O.D. collections to the Shipper after the date of collection.

The Shipper irrevocably authorizes UPS to apply, in its sole and unlimited discretion and without prior notice to the Shipper, any C.O.D. collections to any past due Charges owed by the Shipper. To this end, if there are any past due Charges owed by the Shipper, the Shipper hereby (a) irrevocably assigns and transfers to UPS all of the Shipper's right, title and interest in and to each check or other negotiable instrument for payment of a C.O.D. that is received by UPS or its employee or agent, and (b) constitutes and appoints UPS as the Shipper's attorney-in-fact and authorizes UPS, in the Shipper's name, place, and stead, to endorse any such check or other negotiable instrument with the Shipper's name, to deposit the same into any UPS account, and to apply the proceeds of the same against any past due Charges owed by the Shipper. The Shipper acknowledges and agrees that such appointment of UPS as the Shipper's attorney-in-fact is coupled with an interest and is irrevocable. UPS may exercise any of its rights under this Section either directly or through any employee or agent.

The Shipper relinquishes, waives, and agrees not to assert any claim against UPS or any of its employees or agents, any Consignee, any collecting or paying bank, or any other person or entity, that may directly or indirectly arise as a result of UPS's exercise of any of its rights under this Section "Remittance of C.O.D.s." Without diminishing any of UPS's rights under the preceding sentence, the Shipper agrees that UPS and such other persons or entities shall not be liable to the Shipper or any other person or entity for any special, incidental, or consequential damages in any claim made with respect to UPS's exercise of any such rights.

The Shipper agrees that, following UPS's application of any C.O.D. collections to any past due Charges owed by the Shipper in accordance with this Section, the Shipper will continue to be fully liable for the payment of all remaining Charges owed by the Shipper (including, without limitation, (i) any Charges that are not covered by the

application of the C.O.D. collections, and (ii) any Charges relating to a previously applied C.O.D. collection that is reversed by reason of the uncollectibility of the C.O.D. check or other negotiable instrument or otherwise).

Nothing in this Section shall constitute an election of remedies by UPS or any other person or entity or a waiver of any of the rights of UPS or any other person or entity under the remaining provisions of the Terms or at law or in equity.

39. UPS Returns® Services

Where available, UPS offers UPS Returns® Services (including UPS Authorized Return Service®, Print Return Label, Electronic Return Label, Print and Mail Return Label, 1 UPS Pickup Attempt, 3 UPS Pickup Attempts, UPS Returns® on the Web, and UPS Returns® Exchange). 3 UPS Pickup Attempts is not available for UPS Worldwide Express Freight® Service Shipments. UPS Authorized Return Service® requests and UPS Returns® Exchange requests are contractual Package services only.

An additional accessorial charge applies to each UPS Returns® Services Package or pallet and will be assessed when the service is requested, unless the applicable Service Guide specifically provides otherwise. The applicable charges will be those set forth in the UPS Rates in effect at the time the charge is applied. After entering the UPS system, a Package or pallet returned will be charged the rate calculated from the pickup location to the destination via the service selected. The Shipper is solely responsible for controlling the generation and dissemination of labels for UPS Authorized Return Service® Packages and pallets, and will remain liable for all Charges on any Shipment tendered on Shipper's account at any time, including after termination of the contractual service.

Shipments containing certain items are prohibited from being shipped and are not accepted by UPS for UPS Returns® Services including, but not limited to, Hazardous Materials Shipments requiring shipping papers, firearms, and Shipments requiring Delivery Confirmation Services.

C.O.D. (Collect on Delivery) service is not available for UPS Returns® Services Packages. Third Party Billing is not available for UPS Returns® Services in the United States.

UPS® Tariff/Terms and Conditions of Service – United States

Third Party Billing is available for UPS Returns® Services outside the United States.

UPS Returns® Services Shipments are subject to maximum declared values. See Section 55.1, "Maximum Declared Values."

40. UPS Rates

The applicable UPS Rates are determined on the basis of Shipment and Shipper characteristics, including Shipment weight and size and origin to destination distance, and are subject to change. Except as otherwise stated in the Terms, all charges, fees, or surcharges shall be those set forth in the UPS Rates in effect at the time of shipping.

To determine the amount of any Charges for UPS service, consult the UPS Rates in effect at the time of shipping. The effective UPS Rates are available at www.ups.com and upon request at the local UPS office.

Shippers are responsible for providing accurate and complete Shipment information in the UPS Shipping System used, including service selected, number, weight, and dimensions of Shipments. If any aspect of the Shipment information is incomplete or incorrect as determined by UPS in its sole and unlimited discretion, UPS may adjust Charges at any time.

If multiple Packages are tendered for transportation, at the same time or at different times, using the same shipping label and tracking number or a shipping label altered without UPS's express authorization, each of which is prohibited, UPS reserves the right to refuse service or to apply Charges to each such Package in its sole and unlimited discretion.

UPS reserves the right in its sole and unlimited discretion to use any mode of transportation whatsoever to provide the service selected by the Shipper. Regardless of the mode of transportation used, the effective UPS Rates for the service selected by the Shipper shall apply. If, however, a Shipper selects a UPS service to a destination for which only a higher level of service is available, UPS will substitute the next higher level of available service and will charge the corresponding rate for the substituted service.

40.1 Daily Rates and Retail Rates

Daily Rates apply to UPS account holders who received Daily Rates prior to July 11, 2016, to Shippers who establish a six-digit UPS account on or after July 11, 2016, or as UPS may otherwise agree in writing.

Shippers who do not receive Daily Rates will be charged Retail Rates. Retail Rates also apply to Shipments processed and paid for at The UPS Store® locations or UPS Customer Centers, except that charges for Value-Added Services and Other Charges may vary from those set forth in the Retail Rates.

Shippers who drop off at any The UPS Store® location, UPS Access Point location or a UPS Customer Center Packages that have already been processed prior to drop off will receive the rates applicable to the transaction. UPS Worldwide Express Freight® Service pallets that are processed as door-to-door pallets prior to drop off at a UPS Worldwide Express Freight® Center will receive door-to-door rates.

40.2 UPS® Simple Rate

UPS Simple Rate is available only for domestic Packages shipped within the U.S. 50 states with an actual weight of 50 pounds or less and a size of 1,728 cubic inches or less. The applicable rate is determined based on Package size in cubic inches and the service selected, as set forth in the applicable Service Guide. Packages that exceed 50 pounds in actual weight or 1,728 cubic inches in size may be assessed the applicable rate for the service selected in effect at the time of shipping, without UPS Simple Rate pricing or application of any discounts or reduction of any type, in UPS's sole and unlimited discretion.

UPS Simple Rate pricing is available for UPS Next Day Air Saver®, UPS 2nd Day Air®, UPS 3 Day Select®, and UPS® Ground Shipments. Separate rates for Shipments originating in or destined to Alaska and Hawaii are available for certain service levels, as set forth in the applicable Service Guide. UPS Returns® Service options for UPS Simple Rate are limited to UPS Print Return Label Service only. UPS Simple Rate is not available for use with UPS Hundredweight Service, Hazardous Materials Shipments, and Third Party or collected billed Shipments. UPS Simple Rate Shipments must be processed through ups.com shipping or another UPS Automated Shipping System, where available. UPS Simple Rate may not be available through all UPS shipping systems.

The following surcharges do not apply to UPS® Simple Rate Shipments: Residential Surcharge, Delivery Area Surcharge, Delivery Area Surcharge Extended, and fuel surcharges. All other charges apply

to UPS Simple Rate Shipments, including but not limited to any accessorial charge or surcharge.

No waiver, discount, or reduction of any type to UPS Simple Rate shall apply unless UPS agrees in writing to such waiver, discount, or reduction with specific written reference to UPS Simple Rate.

40.3 Letter Rates

Letter Rates for domestic Shipments are available only for UPS Express® Envelopes containing correspondence, urgent documents, or electronic media, with an actual weight of eight ounces or less. UPS Express® Envelopes containing items other than those listed or weighing more than eight ounces will be assessed the corresponding rate for the applicable weight. For international Shipments, UPS Express® Envelopes may be used only for single package documents of no commercial value (which may include electronic media in some countries), with an actual weight of eight (8) ounces or less. UPS Express® Envelopes containing other items, or weighing more than eight (8) ounces will be assessed the corresponding rate for the applicable weight (except as expressly set forth in Section 40.4 ("Pak Rates")).

40.4 Pak Rates

Pak Rates are available only for UPS Worldwide Express Plus®, UPS Worldwide Express®, and UPS Worldwide Saver® single package U.S. export shipments in UPS Express® Envelopes containing correspondence, urgent documents, or electronic media, with an actual weight of more than eight ounces but less than or equal to two pounds; or when UPS Express® Pak is selected at the time of shipping, the customs value of the Package is less than or equal to \$100.00, and the weight of the Package is two pounds or less. UPS Express® Pak shipments weighing more than two pounds will be assessed the corresponding applicable UPS Rates for the Shipment.

40.5 UPS 10 KG Box and UPS 25 KG Box Rates

UPS 10 KG Box and UPS 25 KG Box Rates apply to UPS Worldwide Express Plus®, UPS Worldwide Express®, and UPS Worldwide Saver® single package U.S. export Shipments, using UPS 10 KG Box and 25 KG Box packaging. Shipments that exceed 10 KG and 25 KG, respectively, will be assessed the applicable UPS Rates for the actual weight and service selected.

UPS® Tariff/Terms and Conditions of Service – United States

40.6 Private Express Statutes

The Shipper shall comply with the requirements of the Private Express Statutes when using UPS 2nd Day Air® A.M. and UPS 2nd Day Air® services.

40.7 Rates for Large Packages; Large Package Surcharge

For domestic Shipments, a Package is considered a "Large Package" when its length (longest side of the package) plus girth [(2 x width) + (2 x height)] combined exceeds 130 inches, or its length exceeds 96 inches.

For international Shipments, a Package is considered a "Large Package" when its length (longest side of the package) plus girth [(2 x width) + (2 x height)] combined exceeds 130 inches.

The rate for a Large Package will be based on the greater of the dimensional weight or the actual weight, and is subject to a minimum billable rate set forth in the UPS Rates applicable to the Shipment in effect at the time of the shipping.

A Large Package Surcharge (LPS) will be applied to each Large Package, including any Package that exceeds the weight or size restrictions set forth in Section 3.1 ("Items Not Accepted for Transportation"). Each Large Package in a multiple-package Shipment may receive an LPS. LPS will not apply to UPS Authorized Return Service® UPS® Ground Packages, or to UPS Worldwide Express Freight® Service Shipments.

40.8 Over Maximum Limits Charge

Packages that exceed the weight or size restrictions set forth in Section 3.1 ("Items Not Accepted for Transportation") are subject to one or more of the following additional charges: Over Maximum Weight, Over Maximum Length, or Over Maximum Size. Such charges apply in addition to all other applicable Charges, including but not limited to the Large Package Surcharge. UPS reserves the right in its sole and unlimited discretion to return such Packages to the Shipper at Shipper's expense.

40.9 Additional Handling Charge

An Additional Handling charge will be assessed for any Package that requires special handling, as determined by UPS in its sole and unlimited discretion, including, but not limited to:

- Any article that is not fully encased in a corrugated cardboard shipping container, including tires;

- Any Package with an outer shipping container not made of corrugated cardboard, including but not limited to canvas, leather, metal, wood, hard plastic, soft plastic (e.g., plastic bag), or expanded polystyrene foam (e.g., Styrofoam);

- Any article that is encased in a soft-sided pack (e.g., poly bag or bubble mailer) that exceeds 18 inches along its longest side or 14 inches along its second-longest side or 6 inches in height;

- Any Package with an outer shipping container covered in shrink wrap or stretch wrap;

- Any Package bound with metal, plastic or cloth banding, or that has wheels, casters, handles, or straps (including Packages where the outer surface area is loosely wrapped or where the contents protrude outside the container surface);

- Any cylindrical-like item, including but not limited to barrels, buckets, drums, mailing tubes, or pails;

- Any Package routed through UPS's irregular package sortation process, including but not limited to Packages 1 inch or less in height;

- Any Package with its longest side exceeding 48 inches or its second-longest side exceeding 30 inches;

- Any Package with its length (longest side of the package) plus girth [(2 x width) + (2 x height)] combined exceeding 105 inches;

- Any domestic Package with an actual weight greater than 50 pounds;

- Any international Package with an actual weight greater than 70 pounds;

- Each Package in a UPS Hundredweight Service® or UPS® Ground with Freight Pricing Shipment where the average weight per Package is greater than 50 pounds and the weight for each Package is not specified in the UPS Shipping System used; and

- Each Package in a UPS® Standard or international Shipment (excluding UPS Worldwide Express Freight® Service Shipments) where the average weight per Package is greater than 70 pounds and the weight for each Package is not specified in the UPS Shipping System used.

40.10 Oversize Pallet Handling Surcharge

UPS Worldwide Express Freight® Service pallets are subject to maximum size and weight restrictions (which vary by origin and destination) as set forth at https://www.ups.com/media/en/wwef_max_dim.pdf. Pallets exceeding size or weight

restrictions are not accepted for transportation without prior approval by UPS. Pallets that exceed these restrictions are subject to an Oversize Pallet Handling Surcharge.

41. Peak Surcharges

One or more Peak Surcharges will apply to certain Packages tendered to UPS for shipment during a Peak Period. Details regarding the application of Peak Surcharges and Peak Periods are set forth at [ups.com/peaksurcharges](https://www.ups.com/peaksurcharges). Peak Surcharges apply cumulatively if a Package meets more than one of the specified criteria. Peak Surcharges apply in addition to any other applicable Charges. No waiver, discount, or reduction of any type to the Peak Surcharges shall apply unless UPS agrees in writing to such waiver, discount, or reduction with specific written reference to the Peak Surcharges.

42. Fuel Surcharges

UPS reserves the right to institute fuel surcharges on some or all Shipments without prior notice. The surcharges are subject to adjustment weekly. The surcharges may apply to any domestic or international transportation or other charges including, but not limited to, any accessororial charge or surcharge. The current fuel surcharges are set forth at [ups.com/bridge/fuelsurcharge.html](https://www.ups.com/bridge/fuelsurcharge.html).

Regardless of the mode of transportation used, the effective fuel surcharge for the service selected by the Shipper shall apply. The surcharges will be applied to such services and for such periods as UPS, in its sole and unlimited discretion, may determine necessary.

43. Manual Processing Charges

UPS reserves the right to assess a manual processing charge of \$0.50 per Package or \$35 per week (whichever is greater) to Shippers who ship Packages using a UPS Shipping System that applies outdated UPS Rates until such time as the Shipper upgrades the UPS Shipping System to reflect current UPS Rates.

A manual processing service charge will be assessed to each Package shipped using a UPS 3 Day Select® or UPS Ground shipping document.

44. Third Party Billing Service

Any Shipment billed to a Third Party (regardless of the country of origin or destination of the Shipment) is subject to a Third Party Billing Service fee, charged to the payer, set forth in the Service Guide

UPS® Tariff/Terms and Conditions of Service – United States

at the time of shipping. The fee for Third Party Billing Service shall be charged for each transaction, based upon all Charges, excluding charges, duties and taxes assessed by government authorities. The Third Party Billing Service fee will not apply to UPS Returns Services or UPS Import Control Shipments.

45. Billing Options for Domestic Shipments

Unless otherwise agreed to in writing by UPS, Charges will be billed to the Shipper.

UPS accepts Shipments for Collect billing and Third Party billing (subject to a Third Party Billing Service fee), provided the Consignee or Third Party has a valid UPS account number and has agreed to accept the Charges. Regardless of the billing option selected, some charges including, but not limited to, address correction charges, will be billed to the Shipper.

46. Billing Options for International Shipments

The amount billed includes, but is not limited to, Charges, duties, fees, and taxes, if applicable. Unless otherwise restricted in the origin or destination country, Shippers tendering Packages using a UPS Shipping System may select the payer of Charges, duties, and taxes as Shipper, Receiver, or Third Party (subject to a Third Party Billing Service fee). UPS accepts shipments for Receiver or Third Party billing provided the Receiver or Third Party has a valid UPS account number and has agreed to accept the Charges. In the event of non-payment by the Receiver or Third Party, the Shipper is liable for all Charges including, but not limited to, duties, fees, and taxes.

An additional Duty and Tax Forwarding Surcharge will apply if the Shipper selects a billing option in which duties and taxes are to be paid outside of the destination country.

UPS reserves the right in its sole and unlimited discretion to request advance payment of Charges for any Package sent to or from any international destination or origin.

For all Shipments where the Shipper is not paying the Charges, the Shipper must notify the bill payer prior to shipping, and agree to pay all Charges in the event of non-payment by the bill-to party. The Shipper is liable for payment in the event of non-payment by the Consignee (or

Receiver) or Third Party. All Shipments must have a valid UPS billing option indicated on the UPS Shipping System entry. Regardless of the billing option selected, some charges including, but not limited to, address correction charges, will be billed to the Shipper.

47. Bill My Account

UPS may provide in its sole and unlimited discretion a Bill My Account service to registered Shippers to allow the Shipper to bill to its own account Charges incurred at UPS Customer Centers and participating Third-Party Retailer locations. A processing fee for using Bill My Account may apply and may vary by shipping location. When using Bill My Account, a Shipper with customized contract incentives that may otherwise apply to the account may be limited to certain maximum incentives (“Incentive Caps”). The applicable processing fee and Incentive Caps are subject to change without prior notice and are published at www.ups.com/billmyaccount. Incentive Caps and processing fees in effect at the time of shipping will apply to Shipments billed using Bill My Account.

48. Disbursement Fee

To expedite customs clearance, UPS may make or process payments of duties and taxes on behalf of the payer as dictated by the billing option selected. An additional fee, set forth in the UPS Rates applicable to the Shipment in effect at the time of shipping, will be assessed and billed to the payer.

49. Currency Conversion Rate

Charges to a payer's account in a foreign currency will be converted to the payer's currency using a weekly exchange rate secured through Major Money Center Banks, plus an exchange fee, set forth in the UPS Rates applicable to the Shipment in effect at the time of shipping.

50. Missing/Invalid Account Number or Refusal Fee

A processing fee will be charged for a missing or invalid account number when the account number, including the Shipper's account number, is missing, the account number is not the correct account number for the bill-to party, the account number is for a Receiver or Third Party who fails to pay the Charges, or the Package is shipped to an unauthorized Consignee. In the event of non-payment

by the Receiver or Third Party, the Shipper will be billed a refusal fee plus the Charges.

51. Shipping Charge Corrections; Audit Fee

UPS reserves the right to bill for Charges based upon the characteristics of, and services requested for, Shipments actually tendered to UPS. UPS also reserves the right to audit any Package, Shipment and/or invoice to verify service selection, dimensions, or weight, and applicability of any Charges. As part of that audit, UPS may weigh and measure any Package or Shipment tendered to UPS using any method UPS deems appropriate, including but not limited to multidimensional measuring devices. UPS may in its sole and unlimited discretion increase or adjust Charges based on the results of such audit. UPS reserves the right in its sole and unlimited discretion to bill for Charges based on shipping characteristics provided by the Shipper, regardless of whether UPS has audited the shipping characteristics. In the event that a Package's or Shipment's dimensions are altered during transit, UPS reserves the right to bill for Charges based on the altered dimensions.

An audit fee may be assessed for shipping charge corrections, as set forth in the effective UPS Rates.

52. Payment of Charges

Except where an alternative payment plan applies, UPS's payment terms require payment in full in advance.

UPS may provide in its sole and unlimited discretion alternative payment terms to certain of its Shippers. UPS, in its sole and unlimited discretion, shall decide which, if any, of the alternative payment plans described below (see Section 52.2, “Alternative Payment Plans”) will be made available to the Shipper.

A Shipper that is not enrolled in any of the Alternative Payment Plans described below shall pay all Charges in advance of shipment, as required by UPS.

Notwithstanding any billing plan that is in effect or payment or billing option selected at the time of shipment, the Shipper is ultimately liable for and agrees to pay all Charges, including in the event of insolvency, bankruptcy, non-payment, or refusal to pay by the Receiver or Third Party.

All Charges must be paid in the lawful money of the United States of America.

UPS® Tariff/Terms and Conditions of Service – United States

If a Shipper submits Shipment information to UPS through a UPS Shipping System and does not subsequently tender such Shipment to UPS, it is the Shipper's sole responsibility to request an adjustment in the event Shipper is invoiced for any such Shipments (even where Shipper is ordinarily invoiced based on a UPS package scan), as set forth below (see Section 52.1, "Invoice Adjustment"). Shippers who fail to do so will be liable for all applicable Charges.

As an accommodation to the Shipper, and in UPS's sole and unlimited discretion, UPS may render invoices, or copies of invoices, or charge certain Packages to a Third Party at the request of the Shipper. The Shipper remains responsible for the timely payment in full of all Charges owed by the Shipper. By requesting UPS to render invoices, or copies of invoices, or charge certain Packages to a Third Party, the Shipper is deemed to authorize the Third Party to act on behalf of the Shipper, and UPS may rely thereon in all respects.

UPS also may in its sole and unlimited discretion elect to render an invoice that includes amounts owed for services provided by UPS affiliates.

If Charges are paid by payment card or by an electronic payment method, the Shipper expressly authorizes UPS to assess any Charges and to obtain payment of the Charges by use of the payment card or electronic payment method. If, for any reason, any such transaction is rejected or declined, the Shipper will pay to UPS a declined transaction fee of ten dollars (\$10) per incident, in addition to any late payment fees assessed by UPS and any collection costs which may be incurred by UPS in the final collection of Charges owed by the Shipper. The Shipper authorizes UPS to charge the declined transaction fee to the Shipper's payment card account or electronic payment account or to collect the fee directly from the Shipper, at UPS's sole option.

If, for any reason, a negotiable instrument submitted to UPS as payment for Charges is returned to UPS unpaid, or an electronic request for payment is dishonored, UPS may charge the Shipper a dishonored payment fee of twenty dollars (\$20) per incident, in addition to any late payment fees assessed by UPS and any collection costs which may be incurred by UPS in

the final collection of Charges owed by the Shipper.

UPS may provide trade credit information on its Shippers to commercial reporting agencies.

52.1 Invoice Adjustment

Requests for an invoice adjustment (e.g., adjustment of Charges based on an incorrect rate, billable weight, account number, failure to tender a Shipment, type of service, shipping charge correction, etc.) or a refund due to a duplicate payment must be received by UPS within 180 days of receiving the contested invoice, or any billing dispute is waived. Notification to UPS of a request for an invoice adjustment must be made in writing using one of the following methods:

- Submit a request through UPS's online Billing Center at ups.com/billing;
- Email a request to UPS through the ups.com website using the "Support Category" "billing"; or
- Mail a request to United Parcel Service, P.O. Box 7247-0244, Philadelphia, PA 19170-0001.

The notification to UPS must include the date of shipment, the tracking number for each disputed charge, and the reason for the disputed charge. A partial payment against an invoice is not considered a request for an invoice adjustment or notice to UPS of a disputed charge. UPS reserves the right to refuse to issue any invoice adjustment until all outstanding Charges owing to UPS have been paid in full.

The filing of a lawsuit does not constitute notification by the filer or on behalf of any other party.

Requests for invoice adjustments cannot be made without a good faith basis for submitting the request as to each specific package and adjustment requested. If UPS determines that a requestor has submitted batch or multiple single requests for adjustments without a substantial basis, all requests of such requestor will be denied in their entirety for such time period as UPS may determine in its sole and unlimited discretion. A right or claim, of any kind, to challenge the amount invoiced is conditioned upon full and strict compliance with all requirements regarding notice set forth in this Section; otherwise, failure to comply with the notice requirements set forth in this Section constitutes

agreement to pay the amount in the invoice. Full and strict compliance with this Section is required, even where it is believed that such compliance would not result in relief or would otherwise be futile.

52.2 Alternative Payment Plans

Where UPS elects to make an alternative payment plan available to the Shipper, UPS may render an invoice to the Shipper on a weekly (i.e., seven days) or a monthly (i.e., four or five calendar weeks) basis. A weekly invoice will include the Charges incurred in the previous week. Notwithstanding that UPS has elected to render an invoice to the Shipper on a weekly basis, an invoice may be issued only when the Shipper has incurred aggregate Charges in excess of ten dollars (\$10), or when five (5) calendar weeks have elapsed from the date of issuance of the last invoice, whichever event occurs first. A monthly invoice will include the Charges incurred for the four- or five-week period for which the invoice is issued. In its sole and unlimited discretion, UPS may offer one or more of the following alternative payment plans for the payment of Charges:

– Electronic Funds Transfer Plan (Debit EFT)

By written agreement with UPS, the Shipper will provide UPS with the Shipper's bank account number and bank routing number to enable UPS to electronically request payment, for all Charges incurred by the Shipper, directly from the Shipper's bank, on a weekly or monthly basis. The Shipper's bank will remit the amount requested to UPS and deduct that amount from the Shipper's bank account. Payments to UPS will be shown on the Shipper's bank statements. The Shipper is responsible for payment of any fees imposed by the Shipper's bank. Additionally, the Shipper will receive a weekly or monthly invoice, as applicable, except as described above, from UPS listing the services provided for the applicable billing period. If, for any reason, an electronic request for payment is dishonored, the Shipper is responsible for making a timely payment directly to UPS. Past due balances will be subject to any collection costs which may be incurred by UPS in the final collection of Charges owed by the Shipper. No late payment fee shall be assessed with respect to the Electronic Funds Transfer Plan.

UPS® Tariff/Terms and Conditions of Service – United States

– Monthly Prepayment Plan

By written agreement with UPS, the Shipper will make a prepayment with UPS in an amount equal to four weeks' anticipated Charges as estimated by UPS. Upon notice to the Shipper, the required prepayment amount may be changed by UPS at any time to reflect a revised estimate of four weeks' Charges. All prepayment amounts will remain on account with UPS. No interest will be paid or accrued on the prepayment amounts.

The Charges incurred for the applicable month will be totaled and billed to the Shipper on a monthly basis. Payment is due within seven (7) days after receipt of the UPS invoice. Past due balances will be subject to a late payment fee as described below in addition to any collection costs which may be incurred by UPS in the final collection of Charges owed by the Shipper.

– Weekly Prepayment Plan

By written agreement with UPS, the Shipper will make a prepayment with UPS in an amount equal to four weeks' anticipated Charges as estimated by UPS. Upon notice to the Shipper, the required prepayment amount may be changed by UPS at any time to reflect a revised estimate of four weeks' Charges. All prepayment amounts will remain on account with UPS. No interest will be paid or accrued on the prepayment amounts.

Shipper will receive invoices on a weekly basis, except as described above. Each invoice will list the previous period's Charges incurred. Payment for all accumulated Charges will be due within seven (7) days following the Shipper's receipt of every fourth invoice; however, if prior to receiving the fourth invoice the Shipper's accumulated Charges should equal or exceed the prepayment amounts on account with UPS, then the accumulated Charges will be due within seven (7) days following the Shipper's receipt of the invoice requiring such payment. Past due balances will be subject to a late payment fee as described below, in addition to any collection costs which may be incurred by UPS in the final collection of Charges owed by the Shipper.

– Special Payment Plan

By written agreement with UPS, the Shipper may prepay an amount equal to the anticipated Charges for a period

of between ten to twenty-six weeks, as estimated by UPS. The Charges actually incurred by the Shipper will be deducted by UPS on a weekly basis from the prepayment amounts on account with UPS. Weekly invoices marked as paid will be forwarded to the Shipper reflecting the balance of the prepayment amount on account with UPS. When the prepayment amount on account with UPS reaches the minimum balance specified in the written agreement, the Shipper is required to make another prepayment for an additional period pursuant to the same agreement, or, if the Shipper does not do so, the Shipper must make another payment arrangement with UPS. All prepayment amounts will remain on account with UPS. No interest will be paid or accrued on the prepayment amounts. If the Charges incurred by the Shipper exceed the remaining balance of the prepayment amounts on account with UPS, the excess Charges will be due within seven (7) days following the Shipper's receipt of the invoice requiring such payment. Past due balances will be subject to a late payment fee as described below in addition to any collection costs which may be incurred by UPS in the final collection of Charges owed by the Shipper. This payment plan alternative is available only to existing customers already approved for a Special Payment Plan.

– Credit Extension Plan

By written agreement with UPS, the Shipper may elect to pay an annual credit extension fee and thereafter receive invoices for Charges incurred by the Shipper on a monthly basis with no prepayment requirement. The invoices will be payable within seven (7) days following receipt by the Shipper. The credit extension fee is based upon the Shipper's total annual Charges, as estimated by UPS, and is subject to change annually by UPS in its sole and unlimited discretion. To be eligible for the Credit Extension Plan, the Shipper must use UPS's transportation services and the Credit Extension Plan solely for business, commercial, or agricultural purposes. A Shipper is not eligible for the Credit Extension Plan if the Shipper uses UPS's transportation services and the Credit Extension Plan for any personal, family, or household purposes. By using the Credit Extension Plan (if made available to the Shipper), the Shipper represents, warrants, certifies, and agrees that it

will use UPS's transportation services and the Credit Extension Plan solely for business, commercial or agricultural purposes and not for any personal, family, or household purposes. Past due balances will be subject to a late payment fee as described below in addition to any collection costs which may be incurred by UPS in the final collection of Charges owed by the Shipper.

– Weekly Payment Plan

Each week the Shipper will receive an invoice for the previous week's Charges except as described above. The invoice is due within seven (7) days of receipt. No prepayment is required under this plan.

Past due balances will be subject to a late payment fee as described below in addition to any collection costs which may be incurred by UPS in the final collection of Charges owed by the Shipper.

– Credit Card Payment Plan

The Shipper may elect to pay the previous week's Charges by credit card. The Shipper will receive billing detail itemized on its card statement or a weekly invoice, except as described above, from UPS listing the previous period's Charges incurred. The Shipper will provide UPS with the Shipper's credit information to enable UPS to process Charges incurred by the Shipper on a weekly basis.

Shipper acknowledges and agrees that there may be a delay of two or more days between the date that payments are received by UPS and the date that the payments are posted and credited to the Shipper's account with UPS. If a UPS remittance advice is attached to the Shipper's payment, the payment will be credited accordingly. If no remittance advice is attached to the Shipper's payment, the payment will be credited to the Shipper's account.

52.3 Late Payment Fee

For the Monthly Prepayment Plan, the Weekly Prepayment Plan, the Special Payment Plan, the Credit Extension Plan, and the Weekly Payment Plan, a late payment fee will be assessed if the Shipper's payment is not received by UPS by the invoice due date. Except as otherwise stated below, the late payment fee will equal six percent (6%) of the total past due balance of the Shipper's invoice (including without limitation any previously assessed but unpaid late payment fees).

UPS® Tariff/Terms and Conditions of Service – United States

In determining the late payment fee for the Monthly Prepayment Plan and the Weekly Prepayment Plan, UPS will apply the prepayment amounts on account with UPS to reduce the calculated base amount on which the late payment fee is assessed, provided that UPS will so apply the prepayment amounts to the oldest outstanding invoice first, and to each subsequent invoice thereafter, until the prepayment amounts have been fully so applied. If an invoice past due is fully so covered by the prepayment amount, no late payment fee will apply. If an invoice past due is partially so covered by the prepayment amount, the late payment fee will apply to the portion not so covered by the prepayment amount.

For the Special Payment Plan, a late payment fee will not be assessed if there has been a positive balance in the Shipper's prepayment account with UPS at any time during the 27-day period immediately preceding the transmittal of the current invoice to the Shipper. The late payment fee for the Special Payment Plan will be assessed on the "charges this period" of the Shipper's invoice (including without limitation any previously assessed but unpaid late payment fees) that is past due.

A late payment fee will be assessed only once on each invoice that is past due. Each late payment fee will be due and payable within seven (7) days following the Shipper's receipt of the invoice that first reflects the assessment of the late payment fee. The late payment fee is in addition to any collection costs that may be incurred by UPS in the final collection of Charges owed by the Shipper. Neither the assessment nor the payment of a late payment fee will (a) affect the Shipper's responsibility to pay all Charges owed, or (b) in any manner preclude UPS from exercising any of its rights or remedies hereunder or under applicable law.

52.4 Lien on Shipments

UPS shall have a general and continuing lien on any and all Shipments for which services are being provided by UPS that come into UPS's actual or constructive possession or control for monies owed to UPS with regard to the Shipment on which the lien is claimed and/or any and all prior Shipment(s).

53. UPS Service Guarantee

UPS guarantees on-schedule Delivery of Shipments shipped via the following services, where available, to all 50 states and Puerto Rico:

- UPS Air Services
- UPS Hundredweight Service® Air Services
- UPS 3 Day Select®
- UPS Hundredweight Service® UPS 3 Day Select®
- UPS® Ground
- UPS® Ground with Freight Pricing
- UPS Hundredweight Service® Ground

UPS guarantees on-schedule Delivery of Shipments shipped via the following services, where available, and provided that customs clearance is performed by UPS Supply Chain Solutions® brokerage offices designated by UPS for clearing these Shipments:

- UPS Worldwide Express Plus®
- UPS Worldwide Express NA1®
- UPS Worldwide Express®
- UPS Worldwide Express Freight® Service
- UPS Worldwide Saver®
- UPS Worldwide Expedited®
- UPS 3 Day Select® from Canada
- UPS® Standard

In the event UPS fails to attempt Delivery by the date and time (if applicable) indicated at <https://www.wapps.ups.com/ctc>, for the applicable date, time and location of tender, or as provided when 1-800-PICK-UPS® (1-800-742-5877) is called, UPS, at its option, will either credit or refund the transportation charges for each such Shipment to the payer only, upon request, provided the conditions set forth in the UPS Service Guarantee are met. Transportation charges do not include other fees or charges that may be assessed by UPS including, but not limited to, fuel surcharges. This is the sole remedy available under the UPS Service Guarantee. UPS may, but is not required, to present the actual time of Delivery in tracking detail or proof of Delivery, and reserves the right to amend any delivery confirmation or the actual time of Delivery within forty-eight (48) hours of the date of Delivery.

UPS shall not be liable for any damages whatsoever for delayed Delivery, except as specifically provided for Shipments made under the UPS Service Guarantee. Under

no circumstances shall UPS be liable for any special, incidental, or consequential damages including, but not limited to, damages arising from delayed Delivery or failure to attempt on-schedule Delivery.

UPS may cancel, suspend or modify the UPS Service Guarantee (or change the guaranteed time in transit) for any service(s), and for any period of time, as determined by UPS in its sole and unlimited discretion, and without prior notice. Visit www.ups.com/holidays for changes effective during the holiday season.

53.1 Conditions

The UPS Service Guarantee is subject to the following conditions:

- UPS's guaranteed Delivery schedule has been obtained by referencing UPS's website or contacting a UPS Customer Service office. "On-time" or "on-schedule" means, subject to the terms of this UPS Service Guarantee, Delivery is attempted before or within 60 seconds of the Delivery time published in the UPS guaranteed Delivery schedule. UPS shall be deemed to have attempted "on-time" or "on-schedule" Delivery for purposes of the UPS Service Guarantee if (i) any of the exclusions to the UPS Service Guarantee applies, or (ii) any of the conditions set forth in the UPS Service Guarantee is not met.
- Each Package and Shipment is properly recorded in a UPS Shipping System.
- Each Package and Shipment bears the appropriate UPS tracking label and an address label, or a combined label generated by a UPS Automated Shipping System, showing the Consignee's correct name, deliverable address (UPS does not provide Delivery to a P.O. Box), and ZIP Code (or postal code for international Shipments).
- Each Package or pallet in a Shipment bears a UPS Saturday Delivery routing label (where required) when optional Saturday service is requested and available.
- Each Shipment is tendered to UPS during UPS's published business hours. Shipments received from or destined to certain locations may require earlier pickup times (available at the UPS website).
- UPS is notified by UPS's Interactive Voice Response system or through UPS's online Billing Center at ups.com/billing of a

UPS® Tariff/Terms and Conditions of Service – United States

service failure within fifteen (15) calendar days of the date of scheduled Delivery or the date by which UPS has amended or corrected the actual time of Delivery in tracking detail or proof of Delivery, whichever is later, and is advised of the Consignee's name and address, date of shipment, Shipment weight, and UPS tracking number.

- For UPS Worldwide Expedited® Shipments, the guarantee shall apply only to Shipments with a U.S. origin or destination and when the billed party is resident in the United States and is responsible for all Charges.
- For UPS Worldwide Express Freight® Service Shipments, the guarantee shall apply to a Shipment where any pallet exceeds maximum size or weight restrictions (as set forth at https://www.ups.com/assets/resources/media/wwef_max_dim.pdf) only if the Shipper obtained confirmation of eligibility for the UPS Service Guarantee, prior to tender of the Shipment to UPS for service.

UPS reserves the right to refuse any request for a credit or refund when such request is either (a) made by, or (b) based on information obtained by, a party other than the payer of the Charges.

53.2 Exclusions

The UPS Service Guarantee does not apply to:

- UPS 2nd Day Air® A.M. Packages for Residential deliveries.
- Shipments tendered pursuant to Drop Shipments, special operating plans, or customized handling or processing arrangements, or tendered either under an account number on which Service Guarantee claims are addressed by a special agreement or where such claims have been addressed by special agreement with the payer of the Charges.
- Shipments processed using a UPS Automated Shipping System that is not located at the pickup address assigned to the UPS account number on which the Shipment was made.
- UPS Ground Returns Service Packages.
- Packages subject to a Large Package Surcharge or Additional Handling Fee, Packages that exceed maximum size or weight limits, Shipments containing any Package subject to a Large Package

Surcharge, Additional Handling Fee, or that exceed maximum size or weight limits, or UPS Worldwide Express Freight® Service Shipments tendered without prior approval containing any pallet exceeding maximum size or weight restrictions (as set forth at https://www.ups.com/assets/resources/media/wwef_max_dim.pdf).

- Shipments made using a Call Tag.
- Shipments subject to a UPS Delivery Intercept® request, Delivery Change Request, or a UPS My Choice® request.
- Shipments that are delayed due to causes beyond UPS's control including, but not limited to: the unavailability or refusal of a person to accept Delivery of the Shipment, acts of God, natural disasters, war risks, acts of terrorism, acts of public authorities acting with actual or apparent authority, acts or omissions of customs or similar authorities, authority of law, insufficient information provided by a customer, Hazardous Materials Packages improperly offered for transport, the application of security regulations imposed by the government, or otherwise applicable to the Shipment, riots, strikes or other labor disputes, civil unrest, disruptions in national or local air or ground transportation networks (including, but not limited to, UPS's transportation network), disruption or failure of communication and information systems, and adverse weather conditions.
- International Shipments for which the Shipper has selected the Receiver or Third Party as the payer of any applicable duties and taxes and Delivery is delayed until payment arrangements are made.
- UPS Import Control® Shipments for which the Shipper has selected commercial invoice removal.
- UPS Ground Shipments or UPS® Standard Shipments that are picked up or scheduled to be delivered during the applicable dates set forth in the Year-End Holiday Schedule available at www.ups.com/holidays.
- Shipments without Timely Upload of PLD, Shipments not accompanied by a UPS Smart Label tag, or when the delivery address on any address label or combined label affixed to the Package does not match the delivery address on the UPS Smart Label tag, bar code, or PLD for the Package.

- UPS Air Services and UPS 3 Day Select Shipments of Hazardous Materials or Dangerous Goods Shipments, and all international Hazardous Materials or Dangerous Goods Shipments except UPS Standard Shipments.

54. Claims and Legal Actions: Individual Binding Arbitration of Claims Time Limits and Pleading Requirements for Claims/No Right to Set Off

Claims against UPS must be made within strict time limits, including as set forth in Section 52.1 ("Invoice Adjustment") regarding invoice adjustments or billing disputes; Section 54.3 ("Time Limit for Notice and Filing of Claims for Loss or Damage to Property") regarding claims for loss or damage to property; and pursuant to Section 53 "UPS Service Guarantee."

All claims against UPS arising out of or related to the provision of services by UPS, including, but not limited to, demands for damages, refunds, credits, and any legal or equitable relief whatsoever, shall be extinguished unless the Claimant (1) timely and completely complies with all applicable notice and claims periods set forth in the Terms and in the Service Guide, including as to claims for loss or damage to property under Section 54.3, claims under Section 53 ("UPS Service Guarantee"), claims for invoice adjustments under Section 52.1, or claims for breach of contract or any other cause of action; and (2) pleads on the face of any complaint filed in court against UPS or states in its submission of its claim in arbitration against UPS, as the case may be, satisfaction and compliance with those notice and claims periods as a contractual condition precedent to recovery. Claimants may not deduct the amounts of pending claims from any Charges owed to UPS, and the Shipper waives any and all rights, including any statutory or common law rights, to set off the amount of any claim against Charges owed to UPS.

Agreement to Arbitrate Claims

Claimant and UPS agree that, except for disputes that qualify for state courts of limited jurisdiction (such as small claims, justice of the peace, magistrate court, and similar courts with monetary limits of less than \$30,000 on their jurisdictions over civil disputes), any controversy or claim, whether at law or equity, arising out of or related to the provision of services by UPS, regardless of the date of accrual of such

UPS® Tariff/Terms and Conditions of Service – United States

dispute, shall be resolved in its entirety by individual (not class-wide nor collective) binding arbitration. Claimant and UPS expressly agree that the foregoing obligation to arbitrate disputes regardless of the date of accrual of such disputes includes, but is not limited to, preexisting disputes and disputes that arise from or relate to Packages shipped at the time of a previous version of these Terms. Claimant and UPS further agree that the foregoing obligation to arbitrate disputes applies to claims brought by UPS against Claimant, regardless of whether Claimant has also brought a claim against UPS.

Arbitration is the submission of a dispute to a neutral arbitrator, instead of a judge or jury, for a final and binding decision, known as an "award." Arbitration provides for more limited discovery than in court, and is subject to limited review by courts. Each party has an opportunity to present evidence to the arbitrator in writing or through witnesses. An arbitrator can only award the same damages and relief that a court can award under the law and must honor the terms and conditions in the Terms.

Claimant and UPS agree that their sole relationship is a contractual one governed by the Service Guide and Terms. Any controversy or claim arising out of or related to the provision of services by UPS shall be resolved solely based on the agreements set forth in the Service Guide and Terms.

Institutional Arbitration

The arbitration shall be conducted by the American Arbitration Association (AAA) in accordance with its Commercial Arbitration Rules or, provided that you are an individual consumer and are using UPS's services for personal (not business) use, the Consumer Arbitration Rules (the "AAA Rules"), and judgment on the award may be entered in any court of competent jurisdiction. The AAA Rules, including instructions for how to initiate arbitration, are available at <https://www.adr.org>. The arbitrator shall decide all issues of the case on the basis of the applicable law, not equity. If you initiate arbitration, you must serve UPS's registered agent for service of process, Corporation Service Company, which has locations in every state. Information also can be found on the website of your local Secretary of State.

Any arbitration under this Agreement will take place on an individual basis; class, mass, consolidated or combined actions or arbitrations or proceeding as

a private attorney general are not permitted. Claimant and UPS are each waiving the right to trial by jury. Claimant and UPS are further giving up the ability to participate in a class, mass, consolidated or combined action or arbitration.

Place of Arbitration/Number of Arbitrators/Costs of Arbitration/Governing Law/Survival

Any arbitration will take place in the county where Claimant resides and will be determined by a single arbitrator.

Any filing fee or administrative fee required of Claimant by the AAA Rules shall be paid by Claimant to the extent such fee does not exceed the amount of the fee required to commence a similar action in a court that otherwise would have jurisdiction. For all non frivolous complaints, UPS will pay the amount of such fee in excess of that amount. The arbitrator will allocate the administrative costs and arbitral fees consistent with the applicable rules of the American Arbitration Association. Reasonable attorney's fees and expenses will be allocated or awarded only to the extent such allocation or award is available under applicable law.

All issues are for the arbitrator to decide, except that issues relating to the scope, application, and enforceability of the arbitration provision are for a court to decide. The Federal Arbitration Act governs the interpretation and enforcement of this provision. This agreement to arbitrate shall survive termination of the Terms.

Severability

Notwithstanding anything to the contrary in the AAA Rules, if any part of this arbitration provision is deemed invalid or ineffective for any reason, this shall not affect the validity or enforceability of the remainder of this arbitration provision, and the arbitrator shall have the authority to amend any provisions deemed invalid or ineffective to make the same valid and enforceable.

Desk Arbitration

For all disputes concerning an amount less than fifteen thousand dollars (\$15,000.00), the parties shall submit their arguments and evidence to the arbitrator in writing and the arbitrator shall make an award based only on the documents; no hearing will be held unless the arbitrator in his or her discretion, and upon request of a party, decides it is a necessity to require an in-person hearing. For a dispute governed by the AAA Consumer Arbitration

Rules, and concerning an award between fifteen thousand dollars (\$15,000.00) and fifty thousand dollars (\$50,000.00), inclusive, UPS shall pay Claimant's filing fee under the AAA Rules, provided that Claimant agrees that both parties shall submit their arguments and evidence to the arbitrator in writing and that the arbitrator shall make an award based only on the documents, without a hearing being held. Notwithstanding this provision, the parties may agree to proceed with desk arbitration at any time.

Access to Small Claims Courts

All parties shall retain the right to seek adjudication in a state court of limited jurisdiction, such as small claims, justice of the peace, magistrate court, and similar courts with monetary limits of less than \$30,000 on their jurisdiction over civil disputes, for individual disputes within the scope of such court's jurisdiction.

Acknowledgements

Claimant and UPS acknowledge and agree that pursuant to these Terms:

- CLAIMANT AND UPS AGREE THAT WE ARE WAIVING THE RIGHT TO HAVE A TRIAL BY JURY TO RESOLVE ANY DISPUTE ALLEGED AGAINST CLAIMANT, UPS OR RELATED THIRD PARTIES;
- CLAIMANT AND UPS AGREE THAT WE ARE WAIVING THE RIGHT TO HAVE A COURT, OTHER THAN A STATE COURT OF LIMITED JURISDICTION AS DEFINED ABOVE, RESOLVE ANY DISPUTE ALLEGED AGAINST CLAIMANT, UPS OR RELATED THIRD PARTIES;
- CLAIMANT AND UPS AGREE THAT WE ARE WAIVING THE RIGHT TO HAVE A COURT REVIEW ANY DECISION OR AWARD OF AN ARBITRATOR, WHETHER INTERIM OR FINAL, EXCEPT FOR APPEALS BASED ON THOSE GROUNDS FOR VACATUR EXPRESSLY SET FORTH IN SECTION 10 OF THE FEDERAL ARBITRATION ACT.
- CLAIMANT AND UPS AGREE THAT WE ARE WAIVING THE RIGHT TO SERVE AS A REPRESENTATIVE, AS A PRIVATE ATTORNEY GENERAL, OR IN ANY OTHER REPRESENTATIVE CAPACITY, JOIN AS A CLASS MEMBER, AND/OR TO PARTICIPATE AS A MEMBER OF A CLASS OF CLAIMANTS IN ANY CLASS, MASS, CONSOLIDATED OR COMBINED ACTION OR ARBITRATION FILED AGAINST CLAIMANT, UPS AND/OR RELATED THIRD PARTIES.

UPS® Tariff/Terms and Conditions of Service – United States

Award

The arbitrator may award money or equitable relief in favor of only the individual party seeking relief and only to the extent necessary to provide relief warranted by that party's individual claim. Similarly, an arbitration award and any judgment confirming it apply only to that specific case; it cannot be used in any other case except to enforce the award itself. To reduce the time and expense of the arbitration, the arbitrator will not provide a statement of reasons for his or her award unless a brief explanation of the reasons is requested by one of the parties. Unless both Claimant and UPS agree otherwise, the arbitrator may not consolidate more than one person's claims, and may not otherwise preside over any form of a representative, private attorney general or class proceeding.

Confidentiality of Arbitration

Notwithstanding anything to the contrary in the AAA Rules, UPS and Claimant agree that the filing of arbitration, the arbitration proceeding, any documents exchanged or produced during the arbitration proceeding, any briefs or other documents prepared for the arbitration, and the arbitral award shall all be kept fully confidential and shall not be disclosed to any other party, except to the extent necessary to enforce this arbitration provision, arbitral award or other rights of the parties, or as required by law or court order. This confidentiality provision does not foreclose the American Arbitration Association from reporting certain consumer arbitration case information as required by state law.

54.1 Making Claims for Loss or Damage to Property

All notices of claims for loss of or damage to property transported or accepted for transportation must include the date of shipment, the tracking number, and the nature of the loss or damage. A request for proof of Delivery or damage inspection or the filing of a lawsuit do not constitute notification of a claim. Notice of a claim for loss or damage to property must be made using one of the following methods:

- Submit online at www.ups.com/us/en/help-center/claims-support.page;
- Call 1-800-PICK-UPS® (1-800-742-5877); or
- Mail notice to UPS Claims Processing Center, P.O. Box 1265, Newport News, VA 23601-1265 (for claims involving shipments to or from Puerto Rico, notice

must be mailed to UPS Mexico/AICM, Almacen Fiscalizado #21, Col. Federal Deleg. Venustiano Carranza, Mexico DF CP 15520).

All claims for loss of or damage to property transported or accepted for transportation must: (1) be in writing (or an electronic communication) and must include reference to the Source Document or pickup record number and date of shipment or copies of other documents sufficient to identify the Shipment involved, and the declared value; (2) assert the liability of UPS for alleged loss or damage; (3) make claim for payment of a specified or determinable amount of money; and (4) be accompanied by a copy of the original invoice or, if no invoice was issued, other proof, certified to in writing, as to the purchase price paid by the Consignee (where the property involved has been sold to the Consignee), actual cost or replacement cost of the property, or extent of the damage to the property.

No claims will be voluntarily paid unless UPS receives notice of the claims and they are filed in writing or transmitted electronically by or on behalf of the Shipper in accordance with these provisions.

A right or claim, of any kind, for loss or damage to property is conditioned upon full and strict compliance with this Section 54.1 and Sections 54.3 through 54.6. Full and strict compliance with this Section is required, even where it is believed that such compliance would not result in relief or would otherwise be futile.

54.2 Acknowledgment of Claims for Loss or Damage to Property

After receiving a proper written or electronic transmission of a claim in the manner and form and with the supporting documents described in Section 54.1 ("Making Claims for Loss or Damage to Property") and Section 54.4 ("Investigation of Claims for Loss or Damage to Property") herein, UPS or its designee will acknowledge the receipt of such claim in writing or electronically to the claimant within 30 days after the date of receipt, unless such claim has already been paid or denied in writing or electronically. UPS will at the time each claim is received create a separate file and assign thereto a successive claim file number and note that number on all documents filed in support of the claim and all records and correspondence with respect to the claim, including the

written acknowledgment of receipt and, if in its possession, the Source Document and delivery receipts, if any, covering the Shipment involved. At the time such claim is received, UPS will cause the date of receipt to be recorded on the face of the claim document, and the date of receipt will also appear on the acknowledgment of receipt sent to the claimant.

54.3 Time Limit for Notice and Filing of Claims for Loss or Damage to Property

As a condition precedent to recovery, all claims for loss or damage to property must be noticed and filed in writing or electronically with UPS within the following time limits:

- For domestic Shipments (including shipments to and from Puerto Rico), UPS must receive notice of claims within sixty days after Delivery of the Package or, in case of failure to make Delivery, within sixty days after the date of scheduled Delivery. Claims must be filed within nine months after Delivery of the Package or, in case of failure to make Delivery, within nine months after the date of scheduled Delivery.
- For international Shipments, claims must be filed within sixty days after Delivery of the Package or pallet or, in the case of non-Delivery, within sixty days after the date of scheduled Delivery.
- Suits shall be instituted within two years after denial of any portion of the claim. Where UPS does not receive notice of claims, claims are not filed, or suits are not instituted thereon in accordance with the foregoing provisions, such claims shall be deemed waived and will not be paid.

54.4 Investigation of Claims for Loss or Damage to Property

- **Prompt Investigation.** Each claim for loss or damage to a Package or Shipment filed in the manner prescribed herein will be promptly and thoroughly investigated, if investigation has not already been made prior to receipt of the claim.
- **Supporting Documents.** Each claim must be supported by the following: (1) evidence of payment of the shipping and any declared value charges; and (2) either the original invoice or a photocopy, exact copy, or extract of, the original invoice, a certification of prices or costs, with trade or other discounts, allowance, or deductions of any nature whatsoever and the terms thereof, or depreciation

UPS® Tariff/Terms and Conditions of Service – United States

reflected thereon. Where the property involved in a claim has not been invoiced to the Consignee shown on the bill of lading or receipt, where an invoice does not show price or cost, where the property involved has not been sold, or where the property has been transferred at bookkeeping values only, UPS will, before paying a claim, require the claimant to establish the value in the quantity shipped, transported, or involved. UPS reserves the right to request the original shipping record or Source Document.

For an asserted claim of \$1,000 or more for a Package processed through a UPS Shipping System and tendered to a UPS driver or UPS Customer Center, a copy of the signed high-value shipment summary applicable to the Shipment obtained by the Shipper and signed by the UPS driver or UPS Customer Center representative at the time of tender may be required to support the claim. UPS reserves the right to refuse to pay any claim if, having requested such a signed high-value shipment summary, no such summary is provided.

For an asserted claim of \$1,000 or more for an international UPS Returns® or a UPS Import Control® Package or pallet, the signed UPS high-value shipment summary applicable to the Shipment must be submitted in support of the claim.

By filing a claim and supporting documents to UPS, the claimant certifies that the claim, amount of claim, and supporting documents are true and correct.

– **Original Packaging Materials.** In the event that a claim is made for damage to a Shipment, the original packaging materials must be made available to UPS or its designee for inspection prior to reshipment.

– **Verification of Loss.** When an asserted claim for loss of an entire Package or pallet or an entire Shipment cannot be otherwise authenticated upon investigation, UPS will obtain from the Consignee of the Shipment involved a certified statement in writing that the property for which the claim is filed has not been received from UPS or from any other source. UPS reserves the right to require verification by the filing of a police report and providing a copy of the filed report to UPS in support of the claim.

54.5 Salvage

When UPS pays the actual cost, the purchase price, or the replacement cost of the property, all rights, title to, and interest in the property shall thereupon pass to UPS, and UPS reserves the right to obtain the property for salvage. Payment of a claim in such circumstances shall be contingent on UPS's receipt of the damaged property in the same condition as on the date the damage was incurred.

54.6 Disposition of Claims for Loss or Damage to Property

UPS or its designee, after receiving a written claim for property transported, will pay, decline, or make a firm compromise settlement offer in writing to the claimant within 120 days after UPS receives the claim; provided, however, that if the claim cannot be processed and disposed of within 120 days after receipt, UPS or its designee will at that time and at the expiration of each succeeding 60-day period while the claim remains pending, advise the claimant in writing of the status of the claim and the reason for the delay in making final disposition thereof and shall retain a copy of such notice to the claimant in its claim file.

No claim for loss or damage shall be paid unless a valid claim has been filed in accordance with terms set forth herein (in Section 54.1, "Making Claims for Loss or Damage to Property," Section 54.3, "Time Limit for Notice and Filing of Claims for Loss or Damage to Property," and Section 54.4, "Investigation of Claims for Loss or Damage to Property"). UPS reserves the right to refuse to pay any claim for loss or damage to property until all outstanding Charges owing to UPS have been paid in full. UPS reserves the right to refuse to pay any claim for loss of property if, having requested a detailed description of the property, no such description is provided.

55. Responsibility for Loss or Damage

UPS's liability for loss or damage to each UPS domestic Package or international Shipment, or to each pallet in a UPS Worldwide Express Freight® Service Shipment, is limited to a value of \$100, except as set forth below. Unless a greater value is recorded in the declared value field of the UPS Source Document or the UPS Automated Shipping System used, the Shipper agrees that the released value of each domestic Package or international Shipment, or pallet is no greater than \$100,

which is a reasonable value under the circumstances surrounding the transportation, and that UPS shall not be liable for more than \$100 for each domestic Package or international Shipment or pallet.

To increase UPS's limit of liability for loss or damage above \$100, the Shipper must declare a value in excess of \$100 for each Package or pallet in the declared value field of the UPS Source Document or the UPS Automated Shipping System used and pay an additional charge. The Shipper cannot declare a value in excess of the maximum allowable limits set forth below. UPS shall not be liable under any circumstances for an amount in excess of the declared value of a domestic Package or international Shipment, or pallet. When a Shipper declares a value in excess of \$100, it does not receive any form of insurance. Shippers desiring cargo insurance, all risk insurance, or another form of insurance should purchase such insurance from a third party. Cargo insurance may be available through UPS's licensed affiliates UPS Capital Insurance Agency, Inc. and Parcel Pro, Inc.

The rules relating to liability established by the Convention for the Unification of Certain Rules Relating to International Carriage by Air signed at Warsaw, Poland, on October 12, 1929, that convention as amended, or the Convention for the Unification of Certain Rules for International Carriage by Air (Montreal, 28 May 1999), shall apply to the international carriage of any Shipment insofar as the same is governed thereby. There are no stopping places which are agreed upon at the time of tender of the Shipment, and UPS reserves the right to route the Shipment in any way UPS deems appropriate.

55.1 Maximum Declared Values

The maximum declared value is \$50,000 per Package and \$100,000 per pallet, except for the following for which the maximum declared value may not exceed:

– Subject to the limitations set forth below, certain Packages are eligible for the enhanced maximum declared value of \$70,000 per Package ("Enhanced Maximum Declared Value"). A Package is eligible for Enhanced Maximum Declared Value only where the Package is a domestic Package; is tendered pursuant to the Shipper's Scheduled Pickup Service; the service level selected is a UPS Next Day Air delivery service; the Package is

UPS® Tariff/Terms and Conditions of Service – United States

processed for shipment using a UPS Shipping System (declarations of value on paper Source Documents are not eligible for Enhanced Maximum Declared Value); and the Package does not contain any hazardous material or a Perishable Commodity. Except as set forth in this Section, the portion of any declaration of value above \$50,000 per Package is null and void;

- \$1,000 per Package for Packages shipped by a Third-Party Retailer if no high-value control log was provided to UPS on tender of the Package;
- \$1,000 per Package for a Package processed for shipment prior to tender using a UPS Shipping System and tendered to a UPS driver or UPS Customer Center, unless a UPS high-value shipment summary is obtained by the Shipper or person tendering the Package and signed by the driver or UPS Customer Center representative upon tender of the Package;
- up to \$5,000 per Package for a Package shipped or delivered to a UPS Access Point® location.
- \$500 per Package for a Package shipped via a UPS Drop Box;
- up to \$1,000 per Package for a Package shipped via a Third-Party Retailer or UPS Access Point® location (including a UPS Access Point® locker) if such Package was processed for shipment using a UPS Shipping System prior to drop off at the Third-Party Retailer or UPS Access Point® location or billed using Bill My Account;
- \$1,000 per Package or pallet for international Shipments containing jewelry (not including costume jewelry), or \$2,500 per Package or pallet for Shipments tendered to eligible destinations set forth at [ups.com/jewelry](https://www.ups.com/jewelry);
- \$1,000 per Package or pallet for Shipments containing unset precious stones or industrial diamonds, or \$2,500 per Package or pallet for international Shipments tendered to eligible destinations set forth at [ups.com/jewelry](https://www.ups.com/jewelry);
- \$1,000 per Package for domestic Packages returned via UPS Print Return Label, UPS Print and Mail Return Label, Electronic Return Label, or 1 UPS Pickup Attempt Return Services, (including via UPS Returns® on the Web service);
- \$1,000 per Package or pallet for international Shipments returned via the following UPS Returns® Services: UPS Print

Return Label, UPS Print and Mail Return Label, Electronic Return Label, 1 UPS Pickup Attempt, or 3 UPS Pickup Attempts (including via UPS Returns® on the Web), unless a UPS high-value shipment summary is obtained by the Shipper or person tendering the Package or pallet and signed by the driver or UPS Customer Center representative upon tender of the Shipment;

- \$1,000 per Package or pallet for international UPS Import Control® Shipments unless a UPS high-value shipment summary is obtained by the Shipper or person tendering the Package or pallet and signed by the driver or UPS Customer Center representative upon tender of the Shipment;
- \$999 per Package for Packages shipped via Shipper Release service;

Shippers cannot declare a value for UPS® Prepaid Letters.

Declaring a value in the declared value field of the UPS Source Document or UPS Automated Shipping System used does not increase UPS's limitations of liability for, and Shippers may not declare a value for, damages related to providing or failure to provide C.O.D. service, including, but not limited to: failure to collect the C.O.D. amount; failure to collect the specified form of payment; collection of an instrument in the wrong amount; failure or delay in delivering the collected instrument to the Shipper; or collection of forged, insufficient funds, or otherwise invalid instruments.

Any declared value contrary to what is allowed in the applicable Terms or Service Guide (e.g., the portion of any declaration in excess of allowed maximums) is null and void. Acceptance for carriage or receipt of payment for any Package or Shipment bearing a declared value contrary to what is allowed does not constitute a waiver of any provisions of the Terms or Service Guide limiting UPS's liability or responsibility for any such Package or Shipment. If a Shipper declares value in excess of the applicable maximum allowed or in any respect contrary to what is allowed in the applicable Terms or Service Guide, it is the Shipper's sole responsibility timely to request an adjustment as set forth in Section 52.1 ("Invoice Adjustment") to recover any Charges. Shippers who fail to do so will be liable for all invoiced Charges.

55.2 Liability Limits

UPS's maximum liability for loss or damage to each UPS domestic Package or international Shipment, or to each pallet in a UPS Worldwide Express Freight® Service Shipment, shall not exceed the lesser of:

- \$100, when no value in excess of \$100 is declared on the Source Document or UPS Automated Shipping System used (or when a value in excess of \$100 is declared, but the applicable declared value charges are not paid);
- the declared value on the Source Document or UPS Automated Shipping System used when a value in excess of \$100 is declared and the applicable declared value charges paid;
- the purchase price paid by the Consignee (where the shipped property has been sold to the Consignee);
- the actual cost of the damaged or lost property;
- the replacement cost of the property at the time and place of loss or damage; or
- the cost of repairing the damaged property.

UPS's liability for Shipments containing the following commodities shall be limited as follows:

- **Checks.** UPS's liability for a Shipment containing a check or checks is limited to the cost of stopping payment on and reissuing the check(s), not to exceed \$100 per Package or pallet. In no event shall UPS be liable for the face value of the check(s).
- **Phone Cards, Tickets, Gift Cards, and Similar.** UPS's liability for a Shipment containing a phone card, ticket (such as event or airline ticket), gift certificate, gift card, coupon, or other similar printed matter with an exchange value is limited to the cost (which shall not include any amount of the value attached to the card, certificate, or coupon, or similar printed matter) of replacing the physical card(s), certificate(s), or printed matter, not to exceed \$100 per Package or per pallet. In no event shall UPS be liable for the face value of any phone card, ticket, gift certificate, gift card, coupon, or similar printed matter.
- **Media.** UPS's liability for a Shipment containing documents, film, photographs (including negatives), slides, transparencies, videotapes, compact discs, laser discs, computer tapes, and media of similar nature is limited to the replacement cost of the media on which the content is recorded.

UPS® Tariff/Terms and Conditions of Service – United States

– **Pairs, Parts.** In the event of loss of or damage to a pair or set of articles, UPS's liability is limited to the value of that part of the pair or set which is lost or damaged, and UPS shall not be liable for the value of the whole pair or set. In the event of loss of or damage to any part of property (including any part of a machine) which, when complete for sale or use, consists of several parts, UPS shall be liable only for the value of the part lost or damaged, not to exceed the declared value of the part lost or damaged. In no event shall UPS be liable for the value of the complete item.

In the event of partial loss or damage to a pallet in UPS Worldwide Express Freight® Service, UPS shall be liable only for the value of the contents of the pallet lost or damaged, and not the value of the full pallet.

55.3 Exclusions from Liability

UPS shall not be liable or responsible for:

- loss or damage to articles of unusual value (as defined in these Terms);
- loss or damage to Prepaid Letters;
- loss or damage resulting from insects, moths, vermin, inherent vice, deterioration, dampness of atmosphere, extreme of temperature, ordinary wear and tear, or that which occurred or arose prior to or after the course of transportation by UPS;
- loss or damage resulting from improper, inadequate or unsafe packaging or wrapping that fails to meet UPS's published standards related thereto set forth in the Terms or at [ups.com](https://www.ups.com);
- loss or damage to Perishable Commodities to the extent the loss or damage results from exposure to heat or cold or the perishable nature of the item;
- loss or damage to human remains, fetal remains, human body parts, human embryos, or components thereof;
- loss or damage to fluorescent tubes or bulbs;
- loss of, damage to, or irretrievability of data stored on any type of media, or of information including without limitation personal, health or financial information;
- loss or damage due to acts of God, natural disasters, war risks, acts of terrorism, nuclear damage, acts of public authorities acting with actual or apparent authority, acts or omissions of customs or similar authorities, authority of law, the

application of security regulations imposed by the government or otherwise applicable to the Shipment, riots, strikes or other labor disputes, civil unrest, disruptions in national or local air or ground transportation networks (including, but not limited to, UPS's transportation network), disruption or failure of communication and information systems, or adverse weather conditions;

- loss or damage to any Package or Shipment for which UPS has no scan or other record reflecting that the Package or Shipment was tendered to UPS by the Shipper; or
- loss or damage to any Shipment containing articles that Shippers are prohibited from shipping, that UPS does not or is not authorized to accept for transportation, that UPS states that it will not accept, or that UPS has a right to refuse.

UPS shall not be liable for any damages of any kind, under any theory, arising from or relating to, directly or indirectly, in whole or in part, the loss of or unauthorized access, acquisition, use, modification, disclosure, or destruction of, or damage to, personal, health, financial, or any other type of data or information, including, without limitation, Social Security number, date of birth, driver's license number, credit card number, and financial account information. Notwithstanding any other provisions to the contrary and to the fullest extent permitted by applicable law, UPS will in no event be liable to Shipper, Consignee, or any other person, for any loss, damage, or costs of any kind arising out of or related to any data loss, data exposure, misuse of data, unauthorized access to data or electronic system(s), or cybersecurity or data privacy incident, regardless of whether or not any such loss, damage, or costs are caused by, or otherwise attributable to, UPS.

UPS shall not be liable for any loss or damage arising from providing service to, or on behalf of, a person or entity that obtains such services, including the delivery of property, by trick, false pretense, or other fraudulent scheme.

UPS shall not be liable for any damages arising from UPS's inability, failure, or refusal to comply with a request to stop, return, or re-route shipment of a Package after tender to UPS.

UPS shall not be liable for any interruption of service due to causes beyond UPS's control including, but not limited to: the unavailability or refusal of a person to accept Delivery of the Shipment, acts of God, natural disasters, war risks, acts of terrorism, acts of public authorities acting with actual or apparent authority, acts or omissions of customs or similar authorities, authority of law, insufficient information provided by a customer, Hazardous Materials Packages improperly offered for transport, the application of security regulations imposed by the government or otherwise applicable to the Shipment, riots, a government agency hold, strikes or other labor disputes, civil unrest, disruptions of any kind in national or local air or ground transportation networks (including, but not limited to, UPS's transportation network), disruption or failure of communication and information systems, and adverse weather conditions.

UNDER NO CIRCUMSTANCES SHALL UPS BE LIABLE FOR ANY SPECIAL, INCIDENTAL, OR CONSEQUENTIAL DAMAGES INCLUDING, BUT NOT LIMITED TO, DAMAGES ARISING FROM LOSS, MISDELIVERY OF, OR DAMAGE TO PROPERTY, DELAYED DELIVERY, OR FAILURE TO ATTEMPT DELIVERY IN ACCORDANCE WITH THE UPS SERVICE GUARANTEE, WHETHER OR NOT UPS HAD KNOWLEDGE SUCH DAMAGES MIGHT BE INCURRED. UNDER NO CIRCUMSTANCES SHALL UPS BE LIABLE FOR ANY DAMAGES WHATSOEVER FOR DELAYED DELIVERY, EXCEPT AS SPECIFICALLY PROVIDED FOR SHIPMENTS MADE UNDER THE UPS SERVICE GUARANTEE.

Acceptance for carriage of any Shipment containing articles that Shippers are prohibited from shipping, that UPS does not or is not authorized to accept for transportation, that UPS states it will not accept, or that UPS has a right to refuse, does not constitute a waiver of any provisions of the Terms or Service Guide limiting UPS's liability or responsibility for any such Package or Shipment.

56. Data Handling

The Shipper agrees that UPS and other companies in the UPS group of companies worldwide (i) may use data provided by the Shipper for purposes that include providing UPS's services, products, and support; handling the Shipper's payments,

UPS® Tariff/Terms and Conditions of Service – United States

claims, requests, and UPS accounts; communicating with the Shipper or Consignee to provide tracking updates and information on special events, surveys, contests, offers, promotions, products, and services; providing advertising that may be tailored to the Shipper's or Consignee's interests; operating, evaluating, protecting, and improving UPS's business; facilitating the Shipper's use of UPS blogs and social media; performing data analyses; monitoring and reporting compliance issues, including identifying and protecting against illegal activity, claims, or other liabilities; exercising, establishing, and defending legal claims; and complying with UPS policies and legal obligations, and (ii) may transfer data provided by the Shipper to countries other than the country where the Shipment is tendered for service. The Shipper also agrees that UPS may share data provided by the Shipper with third parties, including service providers, affiliates, resellers, joint marketing partners, franchisees, Shipper's contacts upon the Shipper's request, government agencies, and other third parties such as shippers, consignees, or third-party payers and recipients. UPS may also disclose data provided by the Shipper in order to comply with a legal obligation, to cooperate voluntarily with law enforcement or other public or government authorities, to prevent harm or loss in connection with suspected or actual illegal activity, and in the event UPS sells or transfers all or a portion of its business or assets. UPS is not responsible for the privacy practices of any non-UPS places, sites, platforms, or services.

57. Incorporation of Documents; Waiver; Future Changes

All Shipments are subject to the terms and conditions contained in the Terms. The effective Service Guide, and any modifications or amendments of them, are hereby incorporated by reference in these Terms. In the event of a conflict or inconsistency between the Terms and the effective Service Guide, the Terms shall control. UPS reserves the right to unilaterally modify or amend any portion of the Service Guide or the Terms at any time without prior notice.

The Terms, the Service Guide and the UPS Source Document for each Shipment together comprise the complete and exclusive agreement of the parties, including any

of UPS's affiliates or subsidiaries, except as modified by any existing or future written agreement between the parties, and may not be contradicted, modified or supplemented by any oral agreement or by any implied-by-law covenant.

For any language in the parties' agreement that gives UPS any discretion, judgment or other right, UPS's exercise of such discretion, judgment or other right is not limited in any way whatsoever – even if the specific language does not so specify. UPS has the sole and unilateral authority to choose how to exercise its discretion, judgment or any other right and may do so for any reason it chooses, without limitation. UPS is not bound by any previous exercise of its discretion, judgment or any other right. Nor does any previous exercise constitute a determination or admission by UPS about how such discretion, judgment or right should be or should have been exercised.

The parties disavow and waive any obligations of good faith and/or fair dealing, whether implied by law or otherwise, in connection with their agreements regarding services to which these Terms apply, including but not limited to UPS's exercise of any discretion, judgment or other right, afforded by the Service Guide, the Terms or the UPS Source Document. UPS (and any of UPS's affiliates and subsidiaries) have no special, confidential, or fiduciary relationship with any Shipper or Claimant.

Any failure to enforce or apply any terms or provisions of the Service Guide or the Terms shall not constitute a waiver of that term or provision by UPS, and shall not diminish or impair UPS's right to enforce such term or provision in the future. If one or more provisions of the Terms shall be held to be invalid, illegal, or unenforceable, the validity, legality, and enforceability of the remaining provisions shall not be so affected or impaired.

UPS may engage subcontractors to perform transportation and incidental services.

UPS contracts on its own behalf and on behalf of its servants, agents, and subcontractors, each of whom shall have the benefit of these Terms. No such party has authority to waive or vary these Terms.

UPS TECHNOLOGY AGREEMENTVersion UTA 09072020A

PLEASE CAREFULLY READ THE FOLLOWING TERMS AND CONDITIONS OF THIS UPS TECHNOLOGY AGREEMENT. BY INDICATING BELOW THAT YOU AGREE TO BE BOUND BY THE TERMS AND CONDITIONS OF THIS AGREEMENT, YOU HAVE ENTERED INTO A LEGALLY BINDING AGREEMENT WITH UPS MARKET DRIVER, INC. (“UPS”).

The permission UPS gives You to use the UPS Technology continues so long as You meet your responsibilities in: (1) these General Terms and Conditions <https://www.ups.com/assets/resources/media/en_US/GTC.pdf>; (2) the End User Rights available at <https://www.ups.com/assets/resources/media/en_US/EUR.pdf>; and (3) the Information and General Use Policies available at <https://www.ups.com/assets/resources/media/en_US/IGUP.pdf>, along with the documentation referenced in any of the foregoing three parts (the “Agreement”).

You hereby confirm that You have read and fully understand ALL PARTS of this Agreement – the General Terms and Conditions, the End User Rights, and the Information and General Use Policies, including the documentation referenced therein.

For purposes of the Agreement:

“Customer” means the Person that is your employer, but is not a Service Provider, (1) and that has been assigned the UPS Account you use to register the first UPS Technology you access, if a UPS Account is required for such registration, (2) and that has been assigned the first UPS Account you use with the UPS Technology you access, if a UPS Account is not required for registration but is required for use, or (3) when the first UPS Technology you access does not require a UPS Account for registration or use.

“Service Provider” means a third party engaged by a UPS customer to assist such UPS customer in managing its shipping activity with the UPS Parties, including Billing Data Service Providers, that has been approved by UPS in writing to perform such services for the UPS customer; provided however, UPS Affiliates may serve as Service Provider without a written approval by UPS.

“Service Provider Employee” means an employee of a Service Provider.

“You” or the possessive, “Your,” means, as applicable: (i) you as an individual, if you are entering into this Agreement as an individual on behalf of no other third party for your own personal use of the UPS Technologies; (ii) you as an individual and Customer, if you are accessing UPS Technology as part of your responsibilities as an employee of Customer; or (iii) you as an individual and your employer, if your employer is a Service Provider to a UPS customer and you are accessing UPS Technology as part of your responsibilities as a Service Provider Employee to perform services for the benefit of a UPS customer.

You represent and warrant You have reached the age of legal majority and, if applicable, You can form legally binding contracts under applicable law on behalf of Yourself, the Customer or Service Provider related to the UPS Technology. If at any time You are no longer authorized to form legally binding contracts under applicable law on behalf of Yourself, the Customer or Service Provider, as applicable, You may no longer use UPS Technology on Your own behalf or on behalf of such Customer or Service Provider.

General Terms and Conditions

1. **Definitions.** Capitalized terms used in this Agreement have the meanings set forth on General Terms and Conditions Exhibit A attached hereto and End User Rights Exhibit A. In the case of any conflict between the terms of the End User Rights and these General Terms and Conditions, these General Terms and Conditions shall control.

2. **License Grant.**

2.1. **Scope.** UPS hereby grants to You and You accept, subject to the terms and conditions of this Agreement, a limited, revocable, non-sublicenseable, non-exclusive, non-transferable, license to use or access, as applicable, the UPS Technology and associated Technical Documentation in the Permitted Territory for such UPS Technology. The End User Rights contain additional general license rights and restrictions, as well as UPS Technology-specific license rights and restrictions.

2.2. **General Restrictions – UPS Materials and Software.** You shall not, and shall cause Your employees and agents not to, sublicense, disclose or transfer the UPS Materials to any third party without the written consent of UPS. You agree not to modify (including corrections to the Software), reproduce, rent, lease, lend, encumber, distribute, redistribute, remarket or otherwise dispose of the UPS Materials or any part thereof without the consent of UPS, and hereby waive such rights granted under applicable law. You agree not to duplicate the Software, except as required for its use in accordance with this Agreement, provided that You may make one (1) back-up copy of the Software solely for archival purposes. Such back-up copy shall include UPS's copyright and other proprietary notices, and shall be subject to all the terms and conditions of this Agreement. Notwithstanding anything to the contrary in this Agreement, You may not use the Software on an outsourced time-share or service bureau basis.

3. **Export Law Assurances.** You acknowledge that all UPS Materials provided hereunder are subject to the U.S. Export Administration Regulations ("EAR") administered by the U.S. Department of Commerce's Bureau of Industry and Security, as well as other U.S. laws and regulations. You agree to comply with the EAR and all applicable U.S. laws in your handling and use of all UPS Materials provided hereunder and to not export or reexport the UPS Materials except as authorized by the EAR, U.S. and other applicable laws. Without limiting the generality of the foregoing, you agree, represent and warrant that no UPS Materials will be accessed from, downloaded in, released in, carried to, transferred to, transshipped through or to, exported to, or reexported to (1) the Restricted Territory (or a national or resident thereof) or (2) any person, entity or organization on the U.S. Treasury Department's list of Specially Designated Nationals or the U.S. Department of Commerce's Denied Persons List or Entity List. The countries and territories considered Restricted Territory and the persons, entities or organizations on the aforementioned lists may change from time to time. You agree to stay current with and comply with this provision notwithstanding any such changes. For convenient reference only, information on the Restricted Territory countries and territories and the persons, entities or organizations on the aforementioned lists may be found at: <https://www.treasury.gov/ofac/downloads/sdnlist.txt>, <https://www.treasury.gov/resource-center/sanctions/Programs/Pages/Programs.aspx>, and <https://www.bis.doc.gov/complianceandenforcement/liststocheck.htm>.

4. **UPS Materials.**

4.1. **Ownership of Intellectual Property Rights.** You hereby acknowledge and agree that UPS owns all right, title and interest in and to, or has the right to license to You, the UPS Materials. You acknowledge that You have not acquired any ownership interest in the UPS Materials and will not acquire any ownership interest in the UPS Materials by reason of this Agreement. You will not at any time do or knowingly permit to be done any act or thing that would in any way impair the rights of UPS or its licensors in and to the UPS Materials. UPS and its licensors reserve all rights pertaining to the UPS Materials not specifically granted herein.

4.2. **Changes to UPS Materials and UPS Technology.** UPS may update, alter, modify or supplement any or all of the UPS Materials and/or UPS Technology at any time.

5. Support Services.

5.1. Support and Maintenance. From time to time UPS, in its sole discretion, may, in response to Your request, choose to provide support or maintenance for the Software (“Support Services”). You hereby authorize UPS and its authorized agents (the “Support Providers”), in order to provide Support Services, to access the Software, other applications which You may be using in conjunction with the Software and Your computer systems either (1) remotely, via the Internet or other means (which may require the installation of additional software on Your computer systems by UPS or the Support Providers) (“Support Software”), or (2) through on-site visits at specific times as mutually agreed upon by the parties. Each support session using Support Software will be separately approved by You. During such sessions UPS may see the Software as operating on the Your computer system and UPS may assist You in making modifications to Your computer systems. You further grant UPS and Support Providers the right to manipulate and modify the Software and Your computer systems, applications, files and data as reasonably necessary to provide You with Support Services. However, You agree that any Support Services will be provided at UPS’s discretion and nothing in the Agreement shall be interpreted to obligate UPS to provide any Support Services.

5.2. Access to Proprietary Information. You acknowledge and agree that You may disclose, or that UPS or the Support Providers may observe, Your information and data during the provision of Support Services by UPS or the Support Providers; and that such information and data shall be deemed non-confidential and thus, not covered by General Terms and Conditions Article 7, unless UPS has agreed otherwise in a signed confidentiality agreement separate from this Agreement. In addition, You acknowledge that the remote communications sessions utilized by UPS or the Support Providers may be implemented through the Internet, which is inherently insecure, and You agree that UPS or the Support Providers shall not be liable for any security breaches occurring on the Internet. You should take the foregoing into account when requesting Support Services from UPS or Support Providers.

6. Suspension; Term and Termination.

6.1. Suspension of Rights. UPS may suspend Your rights to access any part of the UPS Systems through the UPS Technology or as necessary in UPS’s sole discretion including without limitation, to (1) prevent access to any part of UPS Systems or the UPS Technology that is not in compliance with the terms and conditions of this Agreement; (2) correct a material error in the UPS Systems or the UPS Technology or (3) comply with a law, regulation or rule or any ruling of a court or other body of competent jurisdiction.

6.2. Term. This Agreement shall become effective upon Your assent by clickthrough below and shall remain in full force and effect thereafter until terminated as provided herein (the “Term”).

6.3. Hosted UPS Technology. Certain UPS Technology is hosted by UPS, UPS Affiliates or vendors of UPS or UPS Affiliates. Hosted UPS Technology is hosted on servers in the United States of America and is scheduled to be available twenty-four (24) hours a day, seven (7) days a week (other than when unavailable for maintenance); however, UPS does not guarantee the availability of hosted UPS Technology, or that access will be uninterrupted or error-free. UPS reserves the right to interrupt, limit, or suspend hosted UPS Technology from time to time for purposes of maintenance, upgrades and similar reasons. You agree that neither UPS nor UPS Affiliates shall be held responsible or liable for any Damages arising from any interruption, suspension or termination of hosted UPS Technology, regardless of the cause.

6.4. Termination.

a. Either party may terminate this Agreement, and UPS may terminate any or all licenses to the UPS Technology granted hereunder, for convenience at any time upon written notice to the other party.

b. Notwithstanding the foregoing, this Agreement shall terminate without any further action needing to be taken by UPS (1) upon a breach of General Terms and Conditions Article 3, 7 or 10, or General Terms and Conditions Sections 2.2 and 4.1 (third sentence); (2) in the event of Your bankruptcy, commencement of bankruptcy, corporate reorganization, civil rehabilitation, concordat, special liquidation or any other insolvency proceeding with respect to You, or if You shall have a receiver, administrator, administrative receiver or liquidator appointed or shall pass

a resolution for winding up, or a court shall make an order to that effect, (3) if You are a partner in or Customer or Service Provider is a partnership and such partnership is dissolved, or (4) upon deletion of Your UPS profile.

6.5. Effect of Termination.

a. Upon the termination of this Agreement for any reason whatsoever all licenses granted hereunder shall immediately terminate and You shall immediately cease and desist from all access to and use of the UPS Materials, and destroy all UPS Materials in Your possession or control.

b. Upon termination of any license to a UPS Technology, You shall immediately cease and desist from access to and use of such UPS Technology and associated UPS Materials and destroy all such associated UPS Materials in Your possession or control.

6.6. Survival of Terms upon Termination. General Terms and Conditions Articles 1, 7-9, and 12; and Sections 4.1, 6.5, and 6.6; the Articles and those Sections of the End User Rights identified in End User Rights Section 10.3; and the Articles and those Sections of the Information and General Use Policies identified in Article 4 of the Information and General Use Policies shall survive the termination of this Agreement for any reason.

7. Confidential Information, Trade Secrets, Information.

7.1. Disclosure. During the Term and thereafter, You shall not use (except as permitted in connection with Your performance hereunder), disclose or permit any Person access to any Trade Secrets (including, without limitation, any Trade Secrets contained in the UPS Materials). During the Term and for a period of five (5) years thereafter, except as otherwise mandated by law, You shall not use, disclose, or permit any Person access to any Confidential Information, except as permitted in connection with Your performance hereunder. You acknowledge that if You breach this General Terms and Conditions Article 7, UPS may have no adequate remedy at law available to it, may suffer irreparable harm, and will be entitled to seek equitable relief. You agree to protect such Confidential Information and Trade Secrets with no less diligence than You protect Your own confidential or proprietary information. If disclosure to Confidential Information is required under provisions of any law or court order, You will notify UPS sufficiently in advance so UPS will have a reasonable opportunity to object.

7.2. Aggregation. You shall not aggregate the Information or derive or develop information, services or products that use the Information, other than as expressly permitted under this Agreement.

7.3. Data Export. You may not export, whether by (i) data export functionality built into the Software; (ii) extraction from the Software interface (e.g. screen scraping); or (iii) otherwise, any data from the UPS Databases and use such data for comparing shipping rates or delivery times with the shipping rates or delivery times of any third party that is not a member of the UPS Parties.

8. Warranties.

8.1. By Customer. You represent and warrant that (1) neither Customer nor You is headquartered in, incorporated in, a national or resident of, or the government of the Restricted Territory; (2) neither You nor Customer is a Person on the U.S. Treasury Department's list of Specially Designated Nationals or a Person owned fifty percent or more by or under the control of any Person on the U.S. Treasury Department's list of Specially Designated Nationals (as they may be amended from time to time and which, for convenient reference only, may be found at <https://www.treasury.gov/ofac/downloads/sdnlist.txt> and <https://www.treasury.gov/resource-center/sanctions/Programs/Pages/Programs.aspx>) (each being a "Sanctioned Person"); (3) neither You nor Customer will use the UPS Technology in the Restricted Territory; and (4) neither You nor Customer will use the UPS Technology in connection with any business or transaction involving the Restricted Territory or a Sanctioned Person.

8.2. Disclaimers.

a. UPS PARTIES WARRANT THAT FOR NINETY (90) DAYS FROM THE DELIVERY TO YOU OF SOFTWARE THAT SUCH SOFTWARE SHALL MATERIALLY OPERATE AS DESCRIBED IN THE

SOFTWARE'S CORRESPONDING TECHNICAL DOCUMENTATION. UPS'S SOLE LIABILITY FOR A BREACH OF THE FOREGOING WARRANTY SHALL BE TO REPLACE ANY SUCH SOFTWARE. EXCEPT AS STATED IN THE WARRANTY OF THE FOREGOING TWO SENTENCES, THE UPS MATERIALS ARE PROVIDED "AS IS WITH ALL FAULTS" AND IN THEIR PRESENT STATE AND CONDITION. NO WARRANTY, REPRESENTATION, GUARANTEE, CONDITION, UNDERTAKING OR TERM, EXPRESS OR IMPLIED, STATUTORY OR OTHERWISE, AS TO THE CONDITION, QUALITY, DURABILITY, ACCURACY, COMPLETENESS, PERFORMANCE, NON-INFRINGEMENT OF THIRD PARTY RIGHTS, MERCHANTABILITY, QUIET ENJOYMENT, OR FITNESS FOR A PARTICULAR PURPOSE OR USE OF THE UPS MATERIALS IS GIVEN OR ASSUMED BY UPS AND ALL SUCH WARRANTIES, REPRESENTATIONS, CONDITIONS, UNDERTAKINGS AND TERMS ARE HEREBY EXCLUDED TO THE FULLEST EXTENT PERMITTED BY APPLICABLE LAW, AS ARE ANY WARRANTIES ARISING FROM COURSE OF DEALING OR USAGE. UPS DOES NOT WARRANT THAT DEFECTS IN THE UPS MATERIALS WILL BE CORRECTED. NO ORAL OR WRITTEN INFORMATION OR ADVICE GIVEN BY UPS OR ANY UPS REPRESENTATIVE SHALL CREATE A WARRANTY.

b. You furthermore acknowledge and agree that access by UPS or the Support Providers to Your computer systems, files and associated data pursuant to General Terms and Conditions Article 5 hereof is merely to facilitate Support Services on Your behalf, and You remain solely responsible for backing up Your computer systems, applications, files and data. ANY SUPPORT SERVICES OR SUPPORT SOFTWARE PROVIDED BY UPS OR A SUPPORT PROVIDER PURSUANT TO THIS AGREEMENT ARE PROVIDED "AS IS WITH ALL FAULTS", AND UPS MAKES NO WARRANTIES, EXPRESS OR IMPLIED, REGARDING ANY SUCH SUPPORT SERVICES OR SUPPORT SOFTWARE. WITHOUT LIMITING THE GENERALITY OF THE FOREGOING, UPS HEREBY EXPRESSLY DISCLAIMS ALL WARRANTIES, INCLUDING WITHOUT LIMITATION ANY WARRANTY OF MERCHANTABILITY, NON-INFRINGEMENT OF THIRD PARTY RIGHTS OR FITNESS FOR A PARTICULAR PURPOSE, RELATED TO SUPPORT SERVICES OR SUPPORT SOFTWARE PROVIDED UNDER THE AGREEMENT AND ALL ASSOCIATED ADVICE, DIAGNOSES AND RESULTS. YOU ACKNOWLEDGE AND AGREE THAT UPS WILL NOT BE LIABLE FOR ANY ERROR, OMISSION, DEFAULT, DEFICIENCY, OR NONCONFORMITY IN THE SUPPORT SERVICES.

c. THE UPS PARTIES DO NOT GUARANTEE CONTINUOUS, UNINTERRUPTED, OR SECURE ACCESS TO THE UPS SYSTEMS AND ACCESS TO SUCH UPS SYSTEMS MAY BE INTERFERED WITH BY NUMEROUS FACTORS OUTSIDE OF UPS'S CONTROL. THE UPS PARTIES ARE NOT LIABLE FOR ANY DAMAGES OF ANY TYPE CAUSED BY SUCH INTERFERENCE.

d. SOME JURISDICTIONS DO NOT ALLOW LIMITATIONS ON IMPLIED WARRANTY, SO THE LIMITATIONS AND EXCLUSIONS IN THIS SECTION MAY NOT APPLY TO YOU. THE AGREEMENT GIVES YOU SPECIFIC LEGAL RIGHTS. YOU MAY ALSO HAVE OTHER RIGHTS WHICH VARY FROM JURISDICTION TO JURISDICTION. YOU AGREE AND ACKNOWLEDGE THAT THE LIMITATIONS AND EXCLUSIONS OF LIABILITY AND WARRANTY PROVIDED IN THIS AGREEMENT ARE FAIR AND REASONABLE.

9. Limitation of Liability.

a. SOME JURISDICTIONS DO NOT ALLOW LIMITATIONS ON CERTAIN DAMAGES SUCH AS LIMITATIONS ON (I) INCIDENTAL OR CONSEQUENTIAL DAMAGES, (II) DAMAGES RESULTING FROM GROSS NEGLIGENCE OR WILLFUL MISCONDUCT AND (III) DAMAGES RESULTING FROM PERSONAL INJURY OR DEATH. ACCORDINGLY, THE LIMITATIONS AND EXCLUSIONS IN THIS SECTION MAY NOT APPLY TO YOU AND ARE ONLY APPLICABLE TO THE FULLEST EXTENT PERMITTED BY APPLICABLE LAW. THIS AGREEMENT GIVES YOU SPECIFIC LEGAL RIGHTS. YOU MAY ALSO HAVE OTHER RIGHTS THAT VARY FROM JURISDICTION TO JURISDICTION. IF YOU ARE DEALING AS A CONSUMER, YOUR STATUTORY RIGHTS THAT CANNOT BE WAIVED, IF ANY, ARE NOT AFFECTED BY THESE PROVISIONS.

b. THE UPS PARTIES SHALL NOT BE LIABLE TO YOU OR ANY THIRD PARTY FOR ANY INDIRECT, CONSEQUENTIAL, EXEMPLARY, PUNITIVE, MULTIPLE, INCIDENTAL, OR SPECIAL DAMAGES, LOST PROFITS, LOSS OF DATA OR DATA USE, LOST SAVINGS, OR COSTS OF PROCURING

SUBSTITUTE GOODS ARISING OUT OF THIS AGREEMENT, DUE TO BREACH OF CONTRACT, TORT (INCLUDING NEGLIGENCE), DELICT, USE OF THE UPS MATERIALS OR OTHERWISE, EVEN IF THE UPS PARTIES HAVE BEEN ADVISED OF THE LIKELIHOOD OF SUCH DAMAGES OCCURRING. EXCEPT FOR THE LIMITATIONS OF LIABILITY SET FORTH IN END USER RIGHTS SECTION 1.1 AND GENERAL TERMS AND CONDITIONS SECTION 8.2, IN NO EVENT SHALL THE LIABILITY OF ALL THE UPS PARTIES FOR ANY DAMAGES (DIRECT OR OTHERWISE) OR PENALTIES OR LOSS, REGARDLESS OF THE FORM OF ACTION OR CLAIM, WHETHER IN CONTRACT, TORT (INCLUDING NEGLIGENCE), DELICT OR OTHERWISE OF ANY TYPE EXCEED, IN THE AGGREGATE, ONE THOUSAND UNITED STATES DOLLARS (USD \$1,000), ANY CLAIM FOR DAMAGES IN EXCESS THEREOF BEING HEREBY WAIVED BY YOU.

c. FOR THE AVOIDANCE OF DOUBT AND CONSISTENT WITH THE SECOND PARAGRAPH OF THESE GENERAL TERMS AND CONDITIONS, THE PRESENTMENT OF THIS AGREEMENT (VERSION UTA 09072020A) MORE THAN ONCE TO YOU DOES NOT CHANGE THE UPS PARTIES' TOTAL AGGREGATE LIABILITY ABOVE ONE THOUSAND UNITED STATES DOLLARS (USD \$1,000).

d. CLAIMS NOT MADE WITHIN SIX (6) MONTHS AFTER THE FIRST EVENT GIVING RISE TO A CLAIM SHALL BE DEEMED WAIVED.

10. Use of Name and Publicity. Except as expressly provided in this Agreement, You agree that You shall not, without separate prior written consent of UPS in each instance, use in advertising, publicity or otherwise the name of the UPS Parties (including without limitation United Parcel Service of America, Inc.), or any partner or employee of the UPS Parties, nor any trade name, trademark, trade dress or simulation thereof owned by the UPS Parties.

11. Notices. Except as specifically provided in this Agreement, all notices, demands or other communications required or permitted hereunder shall be in writing and shall be given as follows:

If by You: by personal delivery, UPS Next Day Air® delivery (notice deemed effective one business day after dispatch); by facsimile or telecopier transmission if a transmission confirmation is received by the sending party (notice deemed effective on date confirmation is received); or by certified mail, return receipt requested, postage prepaid (notice deemed effective on tenth business day following placement in mail) to UPS, 35 Glenlake Parkway, Atlanta, Georgia 30328, attention: UPS Legal Department, facsimile: (404) 828-6912; and

If by UPS: by each method available to You as well as electronic mail (notice deemed effective on date of transmission); to the address, email address or facsimile number, as applicable, (1) of Your registration information for the UPS Technology as provided to UPS, (2) of a UPS Account You use with the UPS Technology or (3) if neither (1) nor (2) above apply, then to the address, email address or facsimile number, as applicable, that You have otherwise provided to UPS.

Either party may change its address, email address or facsimile number for notice through thirty (30) days' prior written notice to the other party.

12. Miscellaneous.

12.1. Independent Parties. The parties are independent parties and nothing herein shall be construed as creating an employment or agency relationship, partnership, and/or joint venture between the parties. Neither party is granted any right or authority to assume or to create any obligation or responsibility, express or implied, on behalf of or in the name of the other party, or to bind such other party in any manner.

12.2. Waiver. No waiver of any provision of this Agreement, or any rights or obligations of either party under this Agreement, shall be effective, except pursuant to a written instrument signed by the party or parties waiving compliance, and any such waiver shall be effective only in the specific instance and for the specific purpose stated in such writing.

12.3. Severability of Provisions. By law, You may have certain rights that cannot be limited by a contract like this Agreement. This Agreement is in no way intended to restrict those rights. If any portion of this Agreement is found to be invalid or unenforceable, the remaining portion will remain in full force and effect to the fullest extent permitted by applicable law.

12.4. Assignment. This Agreement, including any rights, licenses or obligations under this Agreement, may not be assigned by You to any other Person or entity without the prior written consent of UPS. UPS may assign, delegate or transfer all or any part of this Agreement or any rights hereunder to any member of the UPS Parties without the need for any approval or consent from You. For these purposes, "Assignment" shall include, but is not limited to, any merger or sale of all or substantially all of the assets of the assigning party or any transfer of this Agreement, or any portion hereof, by operation of law or otherwise, or any sale or other transfer of thirty percent (30%) or more of the voting shares/interests of the assigning party or control thereof. In the event of any permitted Assignment of this Agreement, this Agreement shall be binding upon and inure to the benefit of each of the parties and their respective legal successors and permitted assigns.

12.5. Taxes. Any fees payable under this Agreement do not include any taxes and fees (including, but not limited to, any applicable withholding taxes and VAT or any other tax or fee) levied by any duly constituted taxing authority against the fees payable to UPS hereunder. You shall be solely responsible for the calculation of and payment of any such taxes to the relevant taxing authority, and shall not reduce the amount of the fees payable for such tax payment.

12.6. Governing Law; Jurisdiction and Language. This Agreement and any claim, case, or controversy arising out of or relating to this Agreement (whether for breach of contract, tort or otherwise) shall be governed by and construed in accordance with the laws of the State of New York, excluding (1) its conflict of law principles; (2) the United Nations Convention on Contracts for the International Sale of Goods; (3) the 1974 Convention on the Limitation Period in the International Sale of Goods; and (4) the Protocol amending the 1974 Convention, done at Vienna, April 11, 1980. The parties declare that they have required that this Agreement and all documents related hereto, either present or future, be drawn up in the English language only. *Les parties déclarent qu'elles exigent que cette entente et tous les documents y afférents, soit pour le présent ou l'avenir, soient rédigés en langue anglaise seulement.* Except where local law requires, consistent with valid entry into a binding agreement, the controlling language of this Agreement is English and any translation You have received has been provided solely for Your convenience. All correspondence and communications between You and UPS under this Agreement must be in the English language. In the event You have entered into this Agreement by means of the Internet display of a translated version of this Agreement in a language other than U.S. English, You may view the U.S. English language version of this Agreement by accessing https://www.ups.com/assets/resources/media/en_US/UTA.pdf. **THE EXCLUSIVE JURISDICTION FOR ANY CLAIM, CASE, OR CONTROVERSY ARISING OUT OF OR RELATING TO THIS AGREEMENT (WHETHER FOR BREACH OF CONTRACT, TORT OR OTHERWISE) SHALL BE A FEDERAL OR STATE COURT IN ATLANTA, GEORGIA, AND THE PARTIES HEREBY CONSENT TO SUCH EXCLUSIVE JURISDICTION AND IRREVOCABLY WAIVE AND SHALL NOT ASSERT ANY DEFENSES BASED ON LACK OF IN PERSONAM JURISDICTION, IMPROPER VENUE OR INCONVENIENT FORUM.** Notwithstanding the foregoing, if and to the extent subsequent separate or ancillary proceedings in another U.S. or foreign court are necessary in order to enforce a judgment of the court in Atlanta, Georgia, or otherwise as is necessary to provide complete relief and full resolution of all issues in dispute, the Parties may institute such subsequent separate or ancillary proceedings in any such U.S. or foreign court, and the Parties hereby consent to the non-exclusive jurisdiction of such court and hereby waive any defenses therein based on lack of in personam jurisdiction, improper venue or inconvenient forum. Notwithstanding anything herein to the contrary, UPS shall be entitled to interim relief or provisional remedies before any court having jurisdiction. You agree to the admissibility of computer records and electronic evidence in any dispute herein. For the avoidance of doubt, dispute resolution provisions contained in any agreement You have entered into with a member of the UPS Parties related to UPS services, including for example, the applicable UPS Terms and Conditions of Carriage/Service, shall govern whenever such provisions are applicable to any claim or controversy. SEE SECTION 12.15 AND EXHIBIT B FOR COUNTRY-SPECIFIC DEVIATIONS TO THIS AGREEMENT IF YOU ARE A RESIDENT OF OR YOUR REGISTERED OFFICE IS LOCATED IN ONE OF THE FOLLOWING COUNTRIES OR TERRITORIES: MIDDLE EASTERN COUNTRIES, BANGLADESH, INDONESIA, ISRAEL, THE UNITED STATES OF AMERICA OR PUERTO RICO.

12.7. Force Majeure. Neither party hereto shall be liable for the failure to perform any of its obligations under this Agreement or for any Damages if such failure is caused by any reason beyond its reasonable control including without limitation, any occurrence of any act of God, labor strike or dispute, industrial disturbance, governmental emergency order, plague, epidemic, pandemic, outbreaks of infectious disease or any other public health crisis, including, without limitation, quarantine or other employee restrictions, regardless of whether such an event is officially declared to be an epidemic, pandemic, or the like by the relevant authoritative body(ies), judicial or government action, emergency regulations, sabotage, riots, vandalism, electronic failure, major computer hardware or software failures, equipment delivery delays, acts of third parties, or act of terrorism.

12.8. Remedies. Any remedies provided herein are non-exclusive.

12.9. Compliance with Laws. Each party, in connection with its performance hereunder, shall strictly comply with all applicable laws, rulings, and regulations and shall take no actions which would cause the other party to be in violation of any laws, rulings or regulations applicable to it, including, where required, You as a licensee filing this Agreement with a governmental entity. You specifically acknowledge that the UPS Materials provided hereunder may contain encryption functionality. You acknowledge and agree that by downloading, importing or using the UPS Materials in any country or territory outside the United States you, not UPS, assume full responsibility for compliance with all the laws and regulations of such country or territory, including, without limitation, all laws and regulations governing the import, use, distribution, development, or transfer of encryption software or technology and all requirements of registration or licensing related to same.

12.10. Data Practices. In order to perform pickup and delivery services, and in connection with Your use of the UPS Technology, the UPS package delivery company in Your jurisdiction, whose name and address may be found under “Contact UPS” on the UPS Web Site for Your jurisdiction (“UPS Delivery Co.”), collects, processes and uses personal information. UPS Market Driver, Inc., 35 Glenlake Parkway, N.E., Atlanta, Georgia, USA 30328 and the other UPS Parties may receive personal information and use it as described herein.

The UPS Parties process personal information in accordance with applicable data protection laws. Without limiting UPS’s ability to collect, use, process, or disclose personal information as permitted by applicable law, You agree that UPS and other UPS Parties worldwide (i) may collect, use, process, or disclose personal information provided by You for purposes (the “Purposes”) that include providing UPS’s services, products, and support; handling Your payments, claims, requests, and UPS Accounts; communicating with You to provide tracking updates and information on special events, surveys, contests, offers, promotions, products, and services; providing advertising that may be tailored to Your interests; operating, evaluating, protecting, and improving UPS’s business; facilitating Your use of UPS blogs and social media; performing data analyses; monitoring and reporting compliance issues, including identifying and protecting against illegal or wrongful activity, claims, or other liabilities; exercising, establishing, and defending legal claims; and complying with UPS policies and legal obligations, and (ii) may transfer personal information provided by You to countries other than the country where the Shipment is tendered for service. You also agree that UPS may share personal information provided by You with third parties, including service providers, affiliates, resellers, joint marketing partners, franchisees, Your contacts upon Your request, government agencies, and other third parties such as shippers, consignees, or third-party payers and recipients (collectively, the “Recipients”). UPS may also use or disclose personal information provided by You in connection with complying with a legal obligation, cooperating voluntarily with law enforcement or other public or government authorities, to prevent harm or loss in connection with suspected or actual illegal or wrongful activity, and in the event UPS sells or transfers all or a portion of its business or assets. UPS is not responsible for the privacy practices of any non-UPS places, sites, platforms, or services.

You represent and warrant to UPS that when You or Your employees, agents or contractors (“Shipper Parties”) provide UPS Delivery Co. with personal information: (1) the Shipper Parties have collected the personal information lawfully, and have the right and authority to provide the personal information to the UPS Parties for any uses permitted under these General Terms and Conditions Section 12.10; (2) You or another Shipper Party have notified each individual identified by the personal information (including all package addressees), as required by applicable law, that UPS will be processing the personal information as permitted by this Section 12.10 and for any additional purposes UPS may have adopted which are in effect at the time of shipping, that the personal information may be provided by UPS to the Recipients set forth above, and that the personal information may be transferred to countries or territories other than the country or territory in which the UPS Parties originally collected the information (which countries or territories may not have the same data protection laws as the country or territory in which You originally provided the

information); and (3) You have obtained informed and specific consent from any package addressee or recipient, as required by law, that UPS may send e-mail and other notifications related to the agreed shipment services.

You further agree to receive non-marketing telephone calls and text messages relating to the UPS pickup and delivery services (including, without limitation, collections calls and text messages) from or on behalf of UPS at any wireless telephone number assigned to Your account. You understand and agree that such calls or text messages may be prerecorded and/or delivered through the use of an automatic telephone dialing system and that Your wireless carrier's message and data rates may apply to Your receipt of such calls and text messages at a cellular telephone number. You understand and agree that any telephone number(s) that You provide to UPS will be true, accurate, current, and complete, and You will promptly update any such number as necessary to keep it true, accurate, current, and complete.

12.11. Non-Exclusivity. Nothing in this Agreement shall be construed to preclude or restrict UPS in any way from entering into similar arrangements with any other Person or from dealing or contracting directly with mutual customers of the parties.

12.12. Entire Agreement; Amendment. This Agreement constitutes the entire understanding and agreement between the parties with respect to the subject matter of this Agreement and supersedes any and all (1) prior or contemporaneous representations, understandings and agreements related thereto and (2) any prior versions of the UPS Technology Agreement between UPS and You, all of which are merged in this Agreement. Such merger will not be effective as to Software. The UPS Technology Agreement current at the time You receive a particular version of the Software will govern Your use of such Software version at all times. Any Corporate Technology Agreement between UPS and Customer, whether entered into before or after the date of this Agreement, shall supersede this Agreement. Any UPS Technology Agreement between UPS and You having a version more recent than Version UTA09072020A shall supersede this Agreement. The superseding of any prior agreement shall not abridge UPS's rights against You as a result of any violation or breach of such prior agreement before the date of this Agreement. This Agreement may not be modified or amended except by a writing signed by authorized representatives of the parties to this Agreement; provided, however, UPS may modify the End User Rights pursuant to End User Rights Section 10.2 and the UPS Materials and UPS Technology pursuant to these General Terms and Conditions Section 4.2. A writing with electronic signatures shall not qualify to modify or amend the Agreement.

12.13. Waiver: European Union Notices. If You are a resident of or Your registered office is located in any country within the European Union and/or the European Economic Area, including the United Kingdom regardless of whether it remains in the European Union, You waive all notices, acknowledgements and confirmations relative to contracting by electronic means which may be required under Articles 10(1), 10(2), 11(1) and 11(2) of EU Directive 2000/31/EC as implemented in Your jurisdiction (including, in the UK, which may be required by the equivalent provisions of the Electronic Commerce (EC Directive) Regulations 2002 as may be amended or replaced from time to time, following the UK's exit from the European Union) in respect of Your use of the UPS Technology. To the extent that You have a statutory right to withdraw from this Agreement in the first fourteen (14) days after Your acceptance, You hereby expressly renounce the 14-day right of withdrawal in exchange of UPS making UPS Technologies available to You immediately upon entering in this Agreement.

12.14. NOTICE: Processing of Personal Information pursuant to UPS Privacy Notice. You hereby acknowledge that personal information may be processed as set forth in General Terms and Conditions Section 12.10. You also agree that where You are the package addressee or recipient, You have received notice of the processing and use of personal information as described in General Terms and Conditions Section 12.10.

12.15. Country-Specific Terms. If You are a resident of or Your registered office is located in one of the countries or territories listed below, the terms of Exhibit B shall apply to You. In the case of conflict or ambiguity between any provision contained in the body of these General Terms and Conditions and any provision contained in Exhibit B, the provision contained in Exhibit B shall prevail if Exhibit B applies to You.

- a. Bahrain, Kuwait, Oman, Qatar, Saudi Arabia, UAE, Jordan, Tunisia, Algeria, Djibouti, Iraq, Lebanon, Libya, Morocco, and Mauritania ("Middle Eastern Countries").
- b. Bangladesh, Indonesia, Israel, the United States of America and Puerto Rico.

EXHIBIT A**DEFINITIONS- GENERAL TERMS AND CONDITIONS**

Affiliates means third parties that control, are controlled by, or under common control with, whether directly or indirectly, a Person. For purposes of this definition, the term “control” (including with correlative meanings, the terms “controlled by” and “under common control with”) means the possession directly or indirectly of the power to direct or cause the direction of the management and policies of an entity, whether through the ownership of voting securities, by trust, management agreement, contract or otherwise.

Agreement is defined in the second paragraph of these General Terms and Conditions.

Alternate Billed Shipment(s) means shipments tendered to the UPS Parties on Your behalf by another Person where such shipments are charged against Your UPS Account.

Assignment has the definition provided in General Terms and Conditions Section 12.4.

Billing Data Service Provider means a third party services provider (1) hired by You for providing services for You to close the Customer Billing Cycle, and (2) who has been identified to UPS by You for receipt of Billing Data from UPS to You via the UPS Systems, using the approved secure transfer method which may be modified from time to time by UPS in accordance with this Agreement.

Confidential Information means any information or material, other than Trade Secrets, that is of value to UPS and is not generally known to third parties, or that UPS obtains from any third party (including without limitation the UPS Parties) that UPS treats as proprietary whether or not owned by UPS. Confidential Information shall include Information. Confidential Information shall not include information that You can show is: (1) known by You at the time of receipt from UPS and not subject to any other nondisclosure agreement between the parties; (2) now, or which hereafter becomes, generally known to the public through no fault of You; (3) otherwise lawfully and independently developed by You without reference to Confidential Information; or (4) lawfully acquired by You from a third party without any obligation of confidentiality.

Customer is defined in the third paragraph of the General Terms and Conditions.

Damages means any claims, losses, damages, rulings, judgments and costs and expenses (including without limitation attorney’s fees).

End User Rights means the document available at https://www.ups.com/assets/resources/media/en_US/EUR.pdf.

General Terms and Conditions means this document.

Inbound Shipments means shipments tendered to the UPS Parties for delivery to You.

Information means information provided from the UPS Systems (i) related to services provided by the UPS Parties or (ii) generated in connection with You shipping with the UPS Parties, including without limitation, Tendered Shipments.

Information and General Use Policies means the document available at https://www.ups.com/assets/resources/media/en_US/IGUP.pdf.

Middle Eastern Countries has the definition provided in General Terms and Conditions Section 12.15.

Outbound Shipments means a shipment tendered to the UPS Parties by You.

Permitted Territory means for any UPS Technology those countries and territories associated with such UPS Technology on End User Rights Exhibit C.

Person means any individual, corporation, limited liability company, partnership, joint venture, association, joint stock company, trust, unincorporated organization or other legal entity.

Purposes has the definition provided in General Terms and Conditions Section 12.10.

Recipients has the definition provided in General Terms and Conditions Section 12.10.

Restricted Territory means those countries or territories subject to a comprehensive economic sanctions program administered by the U.S. Department of the Treasury, Office of Foreign Assets Control (“OFAC”) or to any other general prohibition on the use, exportation, or reexportation of the UPS Technology under U.S. sanctions or export control laws. Countries or territories subject to OFAC embargo or sanctions can change at any time. For Your convenient reference only, the following links provide information pertaining to such countries or territories: <https://www.treasury.gov/resource-center/sanctions/Programs/Pages/Programs.aspx>, and <https://www.bis.doc.gov/complianceandenforcement/liststocheck.htm>.

Service Provider has the definition provided in the third paragraph of the General Terms and Conditions.

Service Provider Employee has the definition provided in the third paragraph of the General Terms and Conditions.

Shipper Parties has the definition provided in General Terms and Conditions Section 12.10.

Software means those items of UPS Technology that (i) are software and that are provided by UPS to You under this Agreement, (excluding sample computer software code) and any associated Technical Documentation, and (ii) any Updates thereto to the extent provided by UPS to You under this Agreement.

Support Services has the definition provided in General Terms and Conditions Section 5.1.

Support Software has the definition provided in General Terms and Conditions Section 5.1.

Support Providers has the definition provided in General Terms and Conditions Section 5.1.

Technical Documentation means collectively any and all documentation and/or sample computer software code regarding the UPS Technology or the UPS Marks provided or made available to You by UPS hereunder.

Tendered Shipment means a shipment tendered (i) by or for You to the UPS Parties for delivery or (ii) by a third party to the UPS Parties for delivery to You, which can be an Outbound Shipment, Alternate Billed Shipment or Inbound Shipment.

Term has the definition provided in General Terms and Conditions Section 6.2.

Trade Secret means any information of UPS or that UPS acquired from a third party (including without limitation the UPS Parties) which is not commonly known by or available to the public, which (1) derives economic value, actual or potential, from not being generally known to and not being readily ascertainable by proper means by other persons who can obtain economic value from its disclosure or use, and (2) is the subject of efforts that are reasonable under the circumstances to maintain its secrecy.

Update(s) shall mean maintenance, error corrections, modifications, updates, enhancements or revisions to the UPS Materials.

UPS means UPS Market Driver, Inc.

UPS Account means any shipping account assigned to You by a member of the UPS Parties, including, without limitation, those accounts assigned to users of UPS.com shipping known as “temporary accounts” and UPS Freight shipping accounts.

UPS Databases means databases of proprietary information related to the shipping services of the UPS Parties and distributed with or for use with Software.

UPS Delivery Co. has the definition provided in General Terms and Conditions Section 12.10.

UPS Marks means the word mark “UPS” as shown in various trademark registrations including but not limited to U.S. Trademark Registration No. 966,724, and the mark “UPS & Stylized Shield Device” as shown below and as shown in various trademark registrations, including but not limited to U.S. Trademark Registration Nos.: 2,867,999, 2,965,392, 2,973,108, 2,978,624, 3,160,056 and European Community Trademark Registration Nos.: 3,107,026, 3,107,281, and 3,106,978.



UPS Materials means collectively the UPS Technology, the UPS Databases, the Technical Documentation, the Information, the Software, the UPS Marks, and the UPS Systems.

UPS Parties means UPS and existing Affiliates, and their respective shareholders, officers, directors, employees, agents, partners, third party suppliers and third party licensors.

UPS Systems means the UPS computer and network systems accessed by the UPS Technology.

UPS Technology means those products identified on End User Rights Exhibit B.

You is defined in the third paragraph of this Agreement.

EXHIBIT B**COUNTRY SPECIFIC AMENDMENT TO THE GENERAL TERMS AND CONDITIONS**

If You are a resident of or Your registered office is located in any country or territory identified in Section 12.15 of the General Terms and Conditions, the following terms replace or modify the referenced terms of the General Terms and Conditions. All terms of the General Terms and Conditions that are not changed by these amendments remain unchanged and in effect.

1. Middle Eastern Countries, Bangladesh, Indonesia, Israel, the U.S. and Puerto Rico.**1.1 Geographic Scope and Applicability.**

a. You warrant and represent that You are a resident of or Your registered office is located in one of the following countries: Middle Eastern Countries, Bangladesh, Indonesia, Israel, the United States of America or Puerto Rico.

b. Subject to Section 1.1(a) of this Exhibit B above, You and UPS agree to modify the General Terms and Conditions as set forth in Section 1.2 of this Exhibit B below.

c. Except as amended as set forth herein, the General Terms and Conditions (including the Exhibits thereto) shall continue in full force and effect until expired or terminated and reflect the entire agreement between You and UPS regarding the subject matter hereof. To the extent that any provisions of this Exhibit B are inconsistent with the General Terms and Conditions, the terms of this Exhibit B shall govern solely with regard to the subject of the inconsistency.

d. In consideration of the promises and mutual covenants of the parties, You and UPS agree that the General Terms and Conditions shall be modified as set forth in Section 1.2 of this Exhibit B below.

1.2 Amendments.

a. If You are a resident of or Your registered office is located in one of the Middle Eastern Countries, Bangladesh, Indonesia or Israel, Section 9 of the General Terms and Conditions shall be deleted in its entirety and replaced with the following:

“9. Limitation of Liability.

9.1 Except as expressly stated in Section 9.2:

a. UPS Parties shall not in any circumstances have any liability for any Damages which may be suffered by the Customer (or any person claiming under or through the Customer), whether the same are suffered directly or indirectly or are immediate or consequential, and whether the same arise in contract, tort (including negligence) or otherwise howsoever, which fall within any of the following categories:

- i. special damage even if UPS Parties was aware of the circumstances in which such special damage could arise;
- ii. loss of profits;
- iii. loss of anticipated savings;
- iv. loss of business opportunity;
- v. loss of goodwill;

- vi. costs of procuring substitute goods arising out of this Agreement;
- vii. loss or corruption of data or data use.

b. The total liability of UPS Parties, whether in contract, tort (including negligence) or otherwise and whether in connection with this Agreement or any collateral contract, shall in no circumstances exceed, in the aggregate, a sum equal to one thousand United States dollars (USD \$1,000); and

c. You agree that, in entering into this Agreement, either it did not rely on any representations, whether written or oral, of any kind or of any person other than those expressly set out in this Agreement or (if it did rely on any representations, whether written or oral, not expressly set out in this licence) that it shall have no remedy in respect of such representations and, in either case, UPS Parties shall have no liability in any circumstances otherwise than in accordance with the express terms of this Agreement.

9.2 The exclusions in Section 9.1 shall apply to the fullest extent permitted by applicable law, but UPS Parties do not exclude liability for:

- a. death or personal injury caused by the negligence of UPS Parties, their officers, employees, contractors or agents;
- b. fraud or fraudulent misrepresentation; or
- c. any other liability which may not be excluded by law.

9.3 For the avoidance of doubt, the presentment of this Agreement (version UTA 09072020A) more than once to you does not change the UPS Parties' total aggregate liability above one thousand united states dollars (USD \$1,000).

9.4 Claims not made within six (6) months after the first event giving rise to a claim shall be deemed waived.”

b. If You are a resident of or Your registered office is located in one of the Middle Eastern Countries, Bangladesh, Indonesia, Israel, the United States of America or Puerto Rico, Section 12.6 of the General Terms and Conditions shall be deleted in its entirety and replaced with the following:

“12.6 Governing Law and Arbitration.

- a. If You are a resident of or Your registered office is located in one of the Middle Eastern Countries, any dispute arising out of or in connection with this Agreement, including any question regarding its existence, validity or termination, shall be referred to and finally resolved by arbitration under the Arbitration Rules of the DIFC-LCIA Arbitration Centre, which the Arbitration Rules of the DIFC-LCIA Arbitration Centre are deemed to be incorporated by reference into this clause. The number of arbitrators shall be one. The seat, or legal place, of arbitration shall be the Dubai International Financial Centre. The language to be used in the arbitration shall be English. The governing law of the Agreement shall be the substantive laws of England and Wales. You hereby represent and warrant that You have the authority to enter into an agreement to arbitrate in accordance with this clause and any applicable law.
- b. If You are a resident of or Your registered office is located in Bangladesh or Indonesia, any dispute arising out of or in connection with this Agreement, including any question regarding its existence, validity or termination, shall be referred to and finally resolved by arbitration under the Arbitration Rules of the Singapore International Arbitration Centre, which the Arbitration Rules of the Singapore International Arbitration Centre are deemed to be

incorporated by reference into this clause. The number of arbitrators shall be one. The seat, or legal place, of arbitration shall be the Singapore International Arbitration Centre. The language to be used in the arbitration shall be English. The governing law of the Agreement shall be the substantive laws of England and Wales. You hereby represent and warrant that You have the authority to enter into an agreement to arbitrate in accordance with this clause and any applicable law.

- c. If You are a resident of or Your registered office is located in Israel, any dispute arising out of this Agreement, or the breach thereof, shall be settled by arbitration in accordance with the International Arbitration Rules of the Israeli Institute of Commercial Arbitration, which the International Arbitration Rules of the Israeli Institute of Commercial Arbitration are deemed to be incorporated by reference into this clause. The number of arbitrators shall be one. The parties also agree to abide by and to perform the award or judgment of the arbitrator as the final decision respecting such dispute. The language to be used in the arbitration shall be English. The governing law of the Agreement shall be the substantive laws of England and Wales. You hereby represent and warrant that You have the authority to enter into an agreement to arbitrate in accordance with this clause and any applicable law.
- d. If You are a resident of or Your registered office is located in the United States of America or Puerto Rico, any dispute arising out of this Agreement, or the breach thereof, shall be governed as set forth in Attachment 1 (Dispute Resolution in the U.S. and Puerto Rico) attached hereto.
- e. Except where local law requires, consistent with valid entry into a binding agreement, the controlling language of this Agreement is English and any translation You have received has been provided solely for Your convenience. All correspondence and communications between You and UPS under this Agreement must be in the English language. In the event You have entered into this Agreement by means of the Internet display of a translated version of this Agreement in a language other than U.S. English, You may view the U.S. English language version of this Agreement by accessing https://www.ups.com/assets/resources/media/en_US/UTA.pdf.
- f. Notwithstanding any other term of this Agreement, dispute resolution provisions contained in any agreement You have entered into with a member of the UPS Parties related to UPS Services, including for example, the applicable UPS Terms and Conditions of Carriage/Service, shall govern whenever such provisions are applicable to any claim or controversy.

c. If You are a resident of or Your registered office is located in one of the Middle Eastern Countries, Bangladesh, Indonesia or Israel, Section 12.16 shall be appended to the General Terms and Conditions as follows:

“**12.16 Interpretation.** The following rules of interpretation shall apply to this Agreement:

- a. Section and Exhibit headings shall not affect the interpretation of this Agreement.
- b. A person includes a natural person, corporate or unincorporated body (whether or not having separate legal personality).
- c. Unless the context otherwise requires, words in the singular shall include the plural and in the plural include the singular.
- d. Unless the context otherwise requires, a reference to one gender shall include a reference to the other gender.
- e. Any reference to an English legal term for any action, remedy, method of judicial proceeding, legal document, legal status, court, official or any legal concept or thing shall, in respect of any

jurisdiction other than England, be deemed to include a reference to what most nearly approximates to the English legal term in that jurisdiction.

- f. A reference to a statute or statutory provision is a reference to it as amended, extended or re-enacted from time to time, whether before or after the date of this Agreement, and in the case of a reference to a statute is also to all subordinate legislation made under that statute whether before or after the date of this Agreement.
- g. Any words following the terms “including,” “include,” “in particular” or “for example” or any similar phrase shall not limit the generality of the related general words.
- h. Any reference to the word “merchantability” shall also be construed as meaning “satisfactory quality.””

d. If You are a resident of or Your registered office is located in one of the Middle Eastern Countries, Bangladesh, Indonesia or Israel, Section 12.17 shall be appended to the General Terms and Conditions as follows:

“12.17 Third Party Rights. A person who is not a party to this Agreement shall not have any rights under the Contracts (Rights of Third Parties) Act 1999 to enforce any term of this Agreement, but this does not affect any right or remedy of a third party which exists, or is available, apart from that Act.”

e. If You are a resident of or Your registered office is located in one of the Middle Eastern Countries, Bangladesh, Indonesia or Israel, Section 12.18 shall be appended to the General Terms and Conditions as follows:

“12.18 Anti-Bribery and Anti-Corruption. You shall comply with all applicable laws, statutes, regulations, and codes relating to anti-bribery and anti-corruption including but not limited to the UK Bribery Act 2010 in connection with this Agreement and promptly report to UPS any request or demand for any undue financial or other advantage of any kind received by such party in connection with the performance of this Agreement.”

f. If You are a resident of or Your registered office is located in Indonesia, Section 12.13 of the General Terms and Conditions shall be deleted in its entirety and replaced with the following:

“12.13 Entire Agreement; Amendment. This Agreement constitutes the entire understanding and agreement between the parties with respect to the subject matter of this Agreement and supersedes any and all (1) prior or contemporaneous representations, understandings and agreements related thereto and (2) any prior versions of the UPS Technology Agreement between UPS and You, all of which are merged in this Agreement. Such merger will not be effective as to Software. The UPS Technology Agreement current at the time You receive a particular version of the Software will govern Your use of such Software version at all times. Any Corporate Technology Agreement between UPS and Customer, whether entered into before or after the date of this Agreement, shall supersede this Agreement. Any UPS Technology Agreement between UPS and You having a version more recent than Version UTA09072020A shall supersede this Agreement. The superseding of any prior agreement shall not abridge UPS’s rights against You as a result of any violation or breach of such prior agreement before the date of this Agreement. A writing with electronic signatures shall not qualify to modify or amend the Agreement.

Attachment 1

Dispute Resolution in the U.S. and Puerto Rico

Binding Arbitration of Disputes

Except as to disputes that qualify for state courts of limited jurisdiction (such as small claims, justice of the peace, magistrate court, and similar courts with monetary limits on their jurisdictions over civil disputes), You and UPS agree that any controversy or claim, whether at law or equity, arising out of or related to this Agreement that arises in whole or in part in the United States or Puerto Rico, regardless of the date of accrual of such dispute, shall be resolved in its entirety by individual (not class-wide nor collective) binding arbitration.

Arbitration is the submission of a dispute to a neutral arbitrator, instead of a judge or jury, for a final and binding decision, known as an "award." Arbitration provides for more limited discovery than in court, and is subject to limited review by courts. Each party has an opportunity to present evidence to the arbitrator in writing or through witnesses. An arbitrator can only award the same damages and relief that a court can award under the law and must honor the terms and conditions in this Agreement. You and UPS agree that their sole relationship is a contractual one governed by this Agreement.

Institutional Arbitration

The arbitration shall be conducted by the American Arbitration Association ("AAA") in accordance with its Commercial Arbitration Rules and the Supplementary Procedures for Consumer-Related Disputes (the "AAA Rules"), and judgment on the award may be entered in any court of competent jurisdiction. The AAA Rules, including instructions for how to initiate arbitration, are available at <https://www.adr.org>. The arbitrator shall decide all issues of the case on the basis of the applicable law, not equity. If You initiate arbitration, You must serve UPS's registered agent for service of process, Corporation Service Company, which has locations in every state. Information also can be found on the website of your local Secretary of State.

Any arbitration under this Agreement will take place on an individual basis; class, mass, consolidated or combined actions or arbitrations or proceeding as a private attorney general are not permitted. You and UPS each waives the right to trial by jury. You and UPS further waive the ability to participate in a class, mass, consolidated or combined action or arbitration.

Place of Arbitration/Number of Arbitrators/Costs of Arbitration

Any arbitration will take place in the county where You reside and will be determined by a single arbitrator. Any filing fee or administrative fee required of You by the AAA Rules shall be paid by You to the extent such fee does not exceed the amount of the fee required to commence a similar action in a court that otherwise would have jurisdiction. For all non frivolous complaints, UPS will pay the amount of such fee in excess of that amount. The arbitrator will allocate the administrative costs and arbitral fees consistent with the applicable rules of the AAA. Reasonable attorney's fees and expenses will be allocated or awarded only to the extent such allocation or award is available under applicable law.

All issues are for the arbitrator to decide, except that issues relating to the scope, application, and enforceability of the arbitration provision are for a court to decide. The Federal Arbitration Act governs the interpretation and enforcement of this provision.

Severability

Notwithstanding anything to the contrary in the AAA Rules, if any part of this arbitration provision is deemed invalid or ineffective for any reason, this shall not affect the validity or enforceability of the remainder of this arbitration provision, and the arbitrator shall have the authority to amend any provisions deemed invalid or ineffective to make the same valid and enforceable.

Desk Arbitration

For all disputes concerning an amount less than fifteen thousand dollars (\$15,000.00), the parties shall submit their arguments and evidence to the arbitrator in writing and the arbitrator shall make an award based only on the documents; no hearing will be held unless the arbitrator in his or her discretion, and upon request of a party, decides

it is a necessity to require an in-person hearing. For a dispute governed by the AAA Consumer-Related Disputes Supplementary Procedures, and concerning an award between fifteen thousand dollars (\$15,000.00) and fifty thousand dollars (\$50,000.00), inclusive, UPS shall pay Your filing fee under the AAA Rules, provided that You agree that each party shall submit their arguments and evidence to the arbitrator in writing and that the arbitrator shall make an award based only on the documents, without a hearing being held. Notwithstanding this provision, the parties may agree to proceed with desk arbitration at any time.

Access to Small Claims Courts

All parties shall retain the right to seek adjudication in a state court of limited jurisdiction, such as small claims, justice of the peace, magistrate court, and similar courts with monetary limits on their jurisdiction over civil disputes, for individual disputes within the scope of such court's jurisdiction.

Acknowledgements

YOU AND UPS ACKNOWLEDGE AND AGREE THAT EACH PARTY WAIVES THE RIGHT TO:

- (a) HAVE A TRIAL BY JURY TO RESOLVE ANY DISPUTE ALLEGED AGAINST YOU, UPS OR RELATED THIRD PARTIES;
- (b) HAVE A COURT, OTHER THAN A STATE COURT OF LIMITED JURISDICTION AS DEFINED ABOVE, RESOLVE ANY DISPUTE ALLEGED AGAINST YOU, UPS OR RELATED THIRD PARTIES;
- (c) HAVE A COURT REVIEW ANY DECISION OR AWARD OF AN ARBITRATOR, WHETHER INTERIM OR FINAL, EXCEPT FOR APPEALS BASED ON THOSE GROUNDS FOR VACATUR EXPRESSLY SET FORTH IN SECTION 10 OF THE FEDERAL ARBITRATION ACT; AND
- (d) SERVE AS A REPRESENTATIVE, AS A PRIVATE ATTORNEY GENERAL, OR IN ANY OTHER REPRESENTATIVE CAPACITY, JOIN AS A CLASS MEMBER, AND/OR TO PARTICIPATE AS A MEMBER OF A CLASS IN ANY CLASS, MASS, CONSOLIDATED OR COMBINED ACTION OR ARBITRATION FILED AGAINST YOU, UPS AND/ OR RELATED THIRD PARTIES.

Award

The arbitrator may award money or equitable relief in favor of only the individual party seeking relief and only to the extent necessary to provide relief warranted by that party's individual claim. Similarly, an arbitration award and any judgment confirming it apply only to that specific case; it cannot be used in any other case except to enforce the award itself. To reduce the time and expense of the arbitration, the arbitrator will not provide a statement of reasons for his or her award unless a brief explanation of the reasons is requested by one of the parties. Unless both You and UPS agree otherwise, the arbitrator may not consolidate more than one person's claims, and may not otherwise preside over any form of a representative, private attorney general or class proceeding.

Confidentiality of Arbitration

Notwithstanding anything to the contrary in the AAA Rules, UPS and You agree that the filing of arbitration, the arbitration proceeding, any documents exchanged or produced during the arbitration proceeding, any briefs or other documents prepared for the arbitration, and the arbitral award shall all be kept fully confidential and shall not be disclosed to any other party, except to the extent necessary to enforce this arbitration provision, arbitral award or other rights of the parties, or as required by law or court order. This confidentiality provision does not foreclose the AAA from reporting certain consumer arbitration case information as required by state law.



Response to NASPO ValuePoint Utah Solicitation # CH21-36 April 26, 2021 Multi Carrier Rate Charts



© 2021 United Parcel Service of America, Inc. UPS, the UPS brandmark and the color brown are trademarks of United Parcel Service America, Inc. All rights reserved.

"UPS offers customized rate sheets identifying its firm offer of rates and prices for transportation rates and prices. The rates and prices identified in the rate sheets will be guaranteed for 12-month periods and increase only with approval by the Lead State. Other fees and charges that may impact an authorized user's invoice are identified in UPS's Rate and Service Guide and as described in UPS's Tariff/Terms and Conditions of Service, in effect at the time of shipping. These fees and charges are subject to change without notice. In accordance with the conditions of the solicitation, UPS has waived all pick-up charges, including on-call/on-demand, and capped fuel surcharges at 7%. Fuel surcharge information is posted on UPS's website, www.ups.com."

Product Name	Service Description	Guar-anteed	Time in Transit	Area Coverage
UPS Next Day Air Early	Guaranteed overnight, first of day service, as early as 8:00 A.M. to the 48 contiguous U.S. states and limited addresses in Anchorage, Alaska.	Yes	1 Business Day, as early as 8:00 A.M. depending on origin/destination	US 48 contiguous states and limited addresses in Anchorage, Alaska
UPS Next Day Air	Guaranteed next business day delivery by 10:30 a.m., 12:00 p.m. or end of day, depending on destination, to all 50 states and Puerto Rico. UPS Next Day Intra is the name for this service in Puerto Rico.	Yes	1 Business Day, 10:30 a.m. (some extended areas by noon and end of day)	US 50 states and Puerto Rico
UPS Next Day Air Saver	Guaranteed overnight afternoon delivery throughout the U.S. 48 contiguous states.	Yes	1 Business Day, 3:00 p.m. or 4:30 p.m. to commercial destinations where UPS Next Day Air delivery is committed by 10:30 a.m. or noon, respectively; residential by end of day	US 48 contiguous states
UPS 2nd Day Air A.M.	Guaranteed delivery, by the morning of the second business day, to commercial destinations in the U.S. 48 contiguous states and selected locations in Anchorage, Alaska.	Yes	2 Business Days, 10:30 a.m. (some extended areas by 12:00 p.m.)	US 48 contiguous states
UPS 2nd Day Air	Guaranteed delivery, by the end of the second business day, throughout the U.S. and Puerto Rico.	Yes	2 Business Days, End of Day	US 50 states and Puerto Rico
UPS 3 Day Select	Guaranteed delivery, by the end of the third business day, throughout the U.S. 48 contiguous states.	Yes	3 Business Days, End of Day	US 48 contiguous states
UPS Ground	Guaranteed, cost-effective, day-definite delivery typically within one to five business days to all 50 states and Puerto Rico. UPS Ground is an economical choice for all routine shipments.	Yes	1 to 5 Business Days, End of Day, depending on origin/destination	US 50 states and Puerto Rico
UPS Hundredweight Service	Guaranteed, reliable, cost-effective delivery for non-palletized, multiple package shipments sent to a single address on the same day. Time-definite or day-definite delivery within 1 to 5 business days depending on level of service. Ideal for scheduled pickup customers with frequent shipments of more than 100 pounds. Available with UPS Next Day Air®, UPS Next Day Air Saver®, UPS 2nd Day Air A.M.®, UPS 2nd Day Air®, UPS 3 Day Select®, and UPS Ground.	Yes	1-5 Business Days, Matches single package service offerings	Matches single package service offerings
UPS Worldwide Express	UPS Express is UPS's premium, time-committed small package express service, serving 121 countries worldwide. Time-definite delivery is guaranteed in 1-3 business days, typically by 10:30 a.m. or noon. In limited areas, the time commit is 2pm. For worldwide shipments to Europe, UPS has a competitive advantage of delivering by 10:30 a.m. in 29 cities, while DHL and FedEx express services have noon or EOD commitments in those cities.	Yes	1-3 Business Days, 10:30 a.m. or 12:00 p.m. (limited areas 2 p.m.)	All UPS origins to 121 countries
UPS Worldwide Express Saver	UPS Express Saver is UPS's day-definite small package express service. Whether worldwide, transborder or domestic, service is guaranteed by end-of-day in typically 1-3 business days.	Yes	1-3 Business Days, End of Day, depending on origin/destination	All UPS origins to all UPS destinations
UPS Expedited	UPS Expedited is a deferred, international small package service that is guaranteed in 2-5 business days by end of day (guarantee applicable to U.S. and Canada payors only).	Yes	2-5 Business Days, End of Day, depending on origin/destination	From 80 countries to more than 220 countries and territories
UPS Standard / Worldwide Standard	UPS Standard is a small package, "non-express", "deferred", day-definite, ground service available in North America and Europe.	Yes	1-8 Business Days, End of Day, depending on origin/destination	North America (between US, Canada and Mexico), Europe domestic, transborder, and worldwide lanes between Norway, Switzerland, and the EU
3 Day Select (Canada to US)	A guaranteed, day-definite service. Shipments are typically delivered by the end of the third business day. Service is only valid from Canada to the US 48 contiguous states.	Yes	3 Business Days, End of Day	Canada to US 48 contiguous states (Import Only)

UPS offers customized rate sheets identifying its firm offer of rates and prices for transportation rates and prices. The rates and prices identified in the rate sheets will be guaranteed for 12-month periods and increase only with approval by the Lead State. Other fees and charges that may impact an authorized user's invoice are identified in UPS's Rate and Service Guide and as described in UPS's Tariff/Terms and Conditions of Service, in effect at the time of shipping. These fees and charges are subject to change without notice. In accordance with the conditions of the solicitation, UPS has waived all pick-up charges, including on-call/on-demand, and capped fuel surcharges at 7%. Fuel surcharge information is posted on UPS's website, www.ups.com.

UPS® Domestic Air - Delivery. The following custom rates will apply to packages billed via Prepaid, Freight Collect, Third Party, Return Service and Return Service Third Party.

Residential Surcharges apply.

UPS offers customized rate sheets identifying its firm offer of rates and prices for transportation rates and prices. The rates and prices identified in the rate sheets will be guaranteed for 12-month periods and increase only with approval by the Lead State. Other fees and charges that may impact an authorized user's invoice are identified in UPS's Rate and Service Guide and as described in UPS's Tariff/Terms and Conditions of Service, in effect at the time of shipping. These fees and charges are subject to change without notice. In accordance with the conditions of the solicitation, UPS has waived all pick-up charges, including on-call/on-demand, and capped fuel surcharges at 7%. Fuel surcharge information is posted on UPS's website, www.ups.com.

<i>Value Added Services / Other Charges *</i>	<i>Type</i>
Automatic Daily On-Route Pickup	Percent off
Automatic Daily Pickup	Percent off
Day-Specific Pickup	Percent off
Residential Surcharge - On Call Pickup	Percent off
Returns Plus - 1 UPS Pickup Attempt Domestic	Percent off
Returns Plus - 3 UPS Pickup Attempts Domestic	Percent off
Smart Pickup	Percent off
UPS On-Call Pickup [®] - Future Day	Percent off
UPS On-Call Pickup [®] - Same Day	Percent off
UPS On-Call Pickup [®] Area Surcharge - Extended Residential	Percent off
UPS On-Call Pickup [®] Area Surcharge - Residential	Percent off
UPS On-Call Pickup [®] Remote Surcharge - Alaska	Percent off
UPS On-Call Pickup [®] Remote Surcharge - Hawaii	Percent off
1 UPS Pick up Attempt - International	List
3 UPS Pick up Attempt - International	List
Additional Handling - Domestic (Dimensions)	List
Additional Handling - Domestic (Non-corrugated)	List
Additional Handling - Domestic (Weight)	List
Additional Handling - International Import	List
Additional Handling - International Export	List
Address Corrections - (Maximum per Shipment)	List
Address Corrections - Air	List
Address Corrections - Ground	List
C.O.D.	List
Commercial Domestic Air Delivery Area Surcharge - Extended (per piece excluding CWT)	List
Commercial Domestic Air Delivery Area Surcharge (per piece excluding CWT)	List
Commercial Domestic Ground Delivery Area Surcharge - Extended (per piece excluding CW)	List
Commercial Domestic Ground Delivery Area Surcharge (per piece excluding CWT)	List
Delivery Area Surcharge - (Import services)	List
Delivery Area Surcharge - Domestic Hundredweight - Air Commercial	List
Delivery Area Surcharge - Domestic Hundredweight - Air Commercial - Extended	List
Delivery Area Surcharge - Domestic Hundredweight - Air Residential	List
Delivery Area Surcharge - Domestic Hundredweight - Air Residential - Extended	List
Delivery Area Surcharge - Domestic Hundredweight - Ground Commercial	List
Delivery Area Surcharge - Domestic Hundredweight - Ground Commercial - Extended	List
Delivery Area Surcharge - Domestic Hundredweight - Ground Residential	List
Delivery Area Surcharge - Domestic Hundredweight - Ground Residential - Extended	List
Delivery Area Surcharge - Extended (Import services)	List
Delivery Area Surcharge - UPS SurePost	List
Delivery Area Surcharge - UPS SurePost - Extended	List
Delivery Change Request - Change Delivery Location	List
Delivery Change Request - Deliver to Access Point	List
Delivery Change Request - Hold for Future Delivery	List
Delivery Change Request - Hold for Will Call	List
Delivery Intercept Reroute - Phone	List
Delivery Intercept Reroute - Web	List
Delivery Intercept Return to Sender - Phone	List
Delivery Intercept Return to Sender - Web	List
Delivery Reattempt - UPS Worldwide Express Freight	List
Direct Delivery	List
Domestic - Peak Surcharge - Additional Handling	List
Domestic - Peak Surcharge - Commercial	List
Domestic - Peak Surcharge - Large Package	List
Domestic - Peak Surcharge - OverMax	List
Domestic - Peak Surcharge - Residential - All other UPS [®] Air (Applies to: UPS 2nd Day Air A.M. [®] , UPS 2nd Day Air [®] , and UPS 3 Day Select [®])	List
Domestic - Peak Surcharge - Residential - UPS SurePost [®]	List
Domestic - Peak Surcharge - Residential - UPS [®] Ground	List

Domestic - Peak Surcharge - Residential - UPS® Next Day Air (Applies to: UPS Next Day Air® Early, UPS Next Day Air®, and UPS Next Day Air Saver®)	List
Domestic & Export Monthly Late Payment Charge	List
Domestic & Export Weekly Late Payment Charge	List
Domestic Delivery Confirmation	List
Domestic Delivery Confirmation - Adult Signature Required	List
Domestic Delivery Confirmation - Signature Required	List
Dry Ice	List
Electronic Export Informaton (per shipment)	List
Electronic Return Label - Domestic	List
Electronic Return Label - International	List
Export - Disbursement Fee	List
Export - Disbursement Fee Minimum	List
Export Duty and Tax Forwarding Surcharge	List
Export Large Package Surcharge - International	List
Extended Area Surcharge - (Export services)	List
Freight Collect Refusal - International	List
Hazardous Material - Domestic Air Services* and 3 Day Select - Accessible	List
Hazardous Material - Domestic Air Services* and 3 Day Select - Inaccessible	List
Hazardous Material - Domestic Ground	List
Import - Disbursement Fee	List
Import - Disbursement Fee Minimum	List
Import Duty and Tax Forwarding Surcharge	List
Import Large Package Surcharge - International	List
Import Late Payment Charge	List
International Dangerous Goods - International Air Services - Accessible	List
International Dangerous Goods - International Air Services - Inaccessible	List
International Dangerous Goods - Standard to/from Canada	List
International Dangerous Goods - Worldwide Express Freight - Accessible	List
International Dangerous Goods - Worldwide Express Freight - Inaccessible	List
International Delivery Confirmation - Signature Required	List
International Delivery Confirmaton - Adult Signature Required	List
Missing/Invalid Account # Change	List
National Large Package Surcharge - Domestic - Commercial	List
National Large Package Surcharge - Domestic - Residential	List
Next Day Air Early (greater than 150 lbs DW) Charge	List
Over Maximum Limits	List
Oversized Pallet Handling Surcharge	List
Print and Mail Return Label - Domestic	List
Print and Mail Return Label -- International	List
Print Return Label - Domestic	List
Print Return Label - International	List
Remote Area Surcharge - (Export services)	List
Remote Area Surcharge - Destination Alaska	List
Remote Area Surcharge - Destination Hawaii	List
Remote Area Surcharge Alaska - (Import services)	List
Remote Area Surcharge Hawaii - (Import services)	List
Residential Domestic Delivery Area Surcharge, Air	List
Residential Domestic Delivery Area Surcharge, Air - Extended	List
Residential Domestic Delivery Area Surcharge, Ground	List
Residential Domestic Delivery Area Surcharge, Ground - Extended	List
Residential Surcharge - Domestic Delivery of Air Services* and 3 Day Select	List
Residential Surcharge - Domestic Delivery of Ground Service	List
Residential Surcharge - Domestic Hundredweight	List
Residential Surcharge - Export Standard Service	List
Residential Surcharge - Import Standard Service	List
Residential Surcharge - U.S. Export International Air Services	List
Residential Surcharge - U.S. Import International Air Services	List
Saturday Air Processing Fee - Domestic	List
Saturday Delivery - Air	List
Saturday Delivery - Ground and 3 Day Select	List
Saturday Delivery - International	List
Saturday Delivery - UPS Worldwide Express Freight	List
Saturday Stop Charge - Domestic	List
Third Party Billing Service Fee - Domestic	List
Third Party Billing Service Fee - Export	List

Third Party Billing Service Fee - Import	List
--	------

*UPS offers customized rate sheets identifying its firm offer of rates and prices for transportation rates and prices. The rates and prices identified in the rate sheets will be guaranteed for 12-month periods and increase only with approval by the Lead State. Other fees and charges that may impact an authorized user's invoice are identified in UPS's Rate and Service Guide and as described in UPS's Tariff/Terms and Conditions of Service, in effect at the time of shipping. These fees and charges are subject to change without notice. In accordance with the conditions of the solicitation, UPS has waived all pick-up charges, including on-call/on-demand, and capped fuel surcharges at 7%. Fuel surcharge information is posted on UPS's website, www.ups.com.

UPS offers customized rate sheets identifying its firm offer of rates and prices for transportation rates and prices. The rates and prices identified in the rate sheets will be guaranteed for 12-month periods and increase only with approval by the Lead State. Other fees and charges that may impact an authorized user's invoice are identified in UPS's Rate and Service Guide and as described in UPS's Tariff/Terms and Conditions of Service, in effect at the time of shipping. These fees and charges are subject to change without notice. In accordance with the conditions of the solicitation, UPS has waived all pick-up charges, including on-call/on-demand, and capped fuel surcharges at 7%. Fuel surcharge information is posted on UPS's website, www.ups.com.

NASPO ValuePoint**UPS Next Day Air®***(Per Package Rates from 48 State Origin)***Daily Commercial Rates***

								AK, HI	PR	AK, HI +
Lbs.	Zone 102	Zone 103	Zone 104	Zone 105	Zone 106	Zone 107	Zone 108	Zone 124	Zone 125	Zone 126
Letter	\$8.17	\$10.74	\$13.52	\$15.00	\$16.26	\$17.38	\$17.84	\$18.87	\$18.87	\$18.87
1	\$8.18	\$10.75	\$13.53	\$15.01	\$16.27	\$17.39	\$17.85	\$18.88	\$18.88	\$18.88
2	\$8.28	\$11.74	\$15.25	\$16.59	\$18.43	\$19.17	\$19.93	\$21.05	\$21.05	\$21.05
3	\$9.34	\$12.44	\$16.88	\$18.41	\$20.41	\$21.07	\$21.79	\$23.02	\$23.02	\$23.02
4	\$10.04	\$13.02	\$18.31	\$20.15	\$22.30	\$22.93	\$23.83	\$25.14	\$25.14	\$25.14
5	\$10.16	\$13.59	\$20.00	\$22.02	\$24.18	\$24.86	\$25.74	\$27.59	\$27.59	\$27.59
6	\$11.17	\$14.35	\$21.67	\$23.78	\$26.16	\$26.60	\$27.74	\$29.67	\$29.67	\$29.67
7	\$11.67	\$15.07	\$23.15	\$25.52	\$28.04	\$28.64	\$29.60	\$31.51	\$31.51	\$31.51
8	\$11.93	\$15.81	\$24.63	\$27.18	\$29.94	\$30.67	\$31.53	\$33.18	\$33.18	\$33.18
9	\$12.05	\$16.40	\$26.04	\$28.91	\$31.82	\$32.64	\$33.54	\$35.45	\$35.45	\$35.45
10	\$12.06	\$16.41	\$27.25	\$30.42	\$33.67	\$34.52	\$35.57	\$37.43	\$37.43	\$37.43
11	\$13.22	\$18.02	\$28.67	\$32.12	\$35.57	\$36.59	\$37.46	\$39.71	\$39.71	\$39.71
12	\$13.73	\$18.73	\$30.20	\$33.56	\$37.27	\$38.62	\$39.50	\$41.37	\$41.37	\$41.37
13	\$13.95	\$19.48	\$31.66	\$35.08	\$38.79	\$40.64	\$41.37	\$43.37	\$43.37	\$43.37
14	\$14.53	\$20.19	\$33.28	\$36.59	\$40.30	\$42.39	\$43.40	\$45.47	\$45.47	\$45.47
15	\$14.84	\$20.92	\$34.42	\$38.07	\$41.79	\$43.78	\$45.06	\$47.16	\$47.16	\$47.16
16	\$15.26	\$21.64	\$36.06	\$39.50	\$43.16	\$44.93	\$46.18	\$48.37	\$48.37	\$48.37
17	\$15.92	\$22.36	\$37.12	\$40.73	\$44.14	\$45.94	\$47.21	\$49.44	\$49.44	\$49.44
18	\$16.44	\$23.07	\$38.22	\$41.61	\$45.16	\$46.95	\$48.47	\$50.65	\$50.65	\$50.65
19	\$16.81	\$23.69	\$39.11	\$42.46	\$46.17	\$47.98	\$49.75	\$52.30	\$52.30	\$52.30
20	\$16.92	\$24.21	\$40.13	\$43.53	\$47.16	\$49.12	\$50.87	\$53.38	\$53.38	\$53.38
21	\$17.67	\$24.93	\$40.97	\$44.60	\$48.15	\$50.10	\$52.23	\$54.58	\$54.58	\$54.58
22	\$18.18	\$25.49	\$41.97	\$45.62	\$49.16	\$51.26	\$53.39	\$55.83	\$55.83	\$55.83
23	\$18.56	\$26.01	\$43.00	\$46.75	\$50.27	\$52.35	\$54.65	\$57.36	\$57.36	\$57.36
24	\$18.98	\$26.48	\$44.09	\$47.95	\$51.64	\$53.50	\$55.77	\$58.41	\$58.41	\$58.41
25	\$19.29	\$26.85	\$45.25	\$48.90	\$53.03	\$54.80	\$56.91	\$60.22	\$60.22	\$60.22
26	\$19.83	\$27.66	\$46.49	\$50.13	\$54.40	\$56.20	\$58.09	\$61.14	\$61.14	\$61.14
27	\$20.24	\$28.16	\$47.64	\$51.57	\$55.91	\$57.42	\$59.20	\$62.84	\$62.84	\$62.84
28	\$20.73	\$28.77	\$48.88	\$53.03	\$57.03	\$58.53	\$60.43	\$63.93	\$63.93	\$63.93
29	\$21.11	\$29.27	\$50.15	\$54.14	\$58.27	\$59.84	\$61.75	\$65.31	\$65.31	\$65.31
30	\$21.15	\$29.49	\$51.14	\$55.40	\$59.41	\$60.99	\$62.13	\$66.89	\$66.89	\$66.89
31	\$21.91	\$30.33	\$52.23	\$56.66	\$60.66	\$62.25	\$64.27	\$68.27	\$68.27	\$68.27
32	\$22.54	\$31.05	\$53.39	\$57.93	\$61.88	\$63.46	\$65.48	\$69.82	\$69.82	\$69.82
33	\$23.05	\$31.83	\$54.40	\$59.16	\$63.14	\$64.89	\$66.97	\$71.39	\$71.39	\$71.39
34	\$23.56	\$32.33	\$55.64	\$60.40	\$64.52	\$66.27	\$68.32	\$73.05	\$73.05	\$73.05
35	\$24.31	\$32.92	\$56.91	\$61.69	\$65.74	\$67.66	\$69.70	\$74.48	\$74.48	\$74.48
36	\$24.88	\$33.44	\$58.12	\$62.92	\$67.03	\$69.17	\$71.05	\$76.02	\$76.02	\$76.02
37	\$24.91	\$34.41	\$59.27	\$64.22	\$68.36	\$70.72	\$72.57	\$77.42	\$77.42	\$77.42
38	\$25.30	\$34.98	\$60.30	\$65.32	\$69.67	\$72.36	\$73.95	\$79.22	\$79.22	\$79.22
39	\$26.09	\$35.57	\$61.45	\$66.57	\$71.01	\$73.87	\$75.41	\$80.80	\$80.80	\$80.80
40	\$26.35	\$36.15	\$62.55	\$67.80	\$72.29	\$75.27	\$76.93	\$82.51	\$82.51	\$82.51
41	\$26.98	\$36.87	\$63.68	\$69.12	\$73.64	\$76.49	\$78.38	\$84.24	\$84.24	\$84.24
42	\$27.38	\$37.61	\$64.92	\$70.33	\$75.13	\$78.29	\$80.00	\$85.95	\$85.95	\$85.95
43	\$28.10	\$38.32	\$66.19	\$71.59	\$76.50	\$79.55	\$81.63	\$87.67	\$87.67	\$87.67
44	\$28.73	\$39.09	\$67.35	\$72.86	\$77.88	\$80.95	\$83.35	\$88.83	\$88.83	\$88.83
45	\$29.35	\$39.94	\$68.53	\$74.09	\$79.40	\$82.35	\$84.69	\$90.28	\$90.28	\$90.28
46	\$29.94	\$40.80	\$69.71	\$75.39	\$80.91	\$83.77	\$86.17	\$91.98	\$91.98	\$91.98
47	\$30.41	\$41.63	\$70.97	\$76.47	\$82.40	\$84.95	\$87.54	\$93.22	\$93.22	\$93.22
48	\$30.64	\$42.46	\$71.98	\$77.76	\$83.87	\$86.51	\$89.21	\$94.92	\$94.92	\$94.92
49	\$31.18	\$43.44	\$72.97	\$78.95	\$85.32	\$87.90	\$90.78	\$96.32	\$96.32	\$96.32
50	\$31.19	\$43.90	\$72.99	\$78.96	\$85.37	\$89.00	\$90.81	\$97.72	\$97.72	\$97.72
51	\$32.54	\$45.27	\$75.22	\$81.49	\$88.50	\$90.91	\$94.24	\$99.40	\$99.40	\$99.40

52	\$33.03	\$46.23	\$76.37	\$82.74	\$90.01	\$92.44	\$96.08	\$101.14	\$101.14	\$101.14
53	\$33.71	\$46.99	\$77.51	\$84.11	\$91.60	\$93.91	\$97.72	\$102.80	\$102.80	\$102.80
54	\$34.23	\$47.94	\$78.73	\$85.28	\$92.97	\$95.75	\$99.59	\$104.96	\$104.96	\$104.96
55	\$34.73	\$48.80	\$80.29	\$86.41	\$94.40	\$97.35	\$101.05	\$106.50	\$106.50	\$106.50
56	\$35.38	\$49.75	\$81.78	\$87.53	\$95.87	\$99.13	\$102.68	\$108.68	\$108.68	\$108.68
57	\$36.04	\$50.61	\$83.27	\$88.68	\$97.25	\$100.77	\$104.43	\$110.41	\$110.41	\$110.41
58	\$36.84	\$51.40	\$84.76	\$89.91	\$98.72	\$102.58	\$106.28	\$112.37	\$112.37	\$112.37
59	\$37.37	\$52.27	\$86.26	\$91.29	\$100.23	\$104.19	\$108.12	\$114.29	\$114.29	\$114.29
60	\$38.11	\$53.10	\$87.65	\$92.51	\$101.86	\$105.95	\$109.46	\$116.40	\$116.40	\$116.40
61	\$38.77	\$54.12	\$89.15	\$94.17	\$103.49	\$107.58	\$109.47	\$118.49	\$118.49	\$118.49
62	\$39.69	\$55.07	\$90.53	\$95.92	\$105.08	\$109.38	\$113.57	\$120.79	\$120.79	\$120.79
63	\$40.35	\$56.17	\$92.05	\$97.32	\$106.87	\$111.28	\$115.47	\$123.08	\$123.08	\$123.08
64	\$41.12	\$57.24	\$93.57	\$98.98	\$108.59	\$113.17	\$117.28	\$125.13	\$125.13	\$125.13
65	\$41.79	\$58.36	\$94.93	\$100.57	\$110.35	\$115.17	\$118.93	\$127.13	\$127.13	\$127.13
66	\$42.56	\$59.42	\$96.45	\$102.21	\$112.12	\$117.08	\$121.04	\$129.46	\$129.46	\$129.46
67	\$42.80	\$60.54	\$97.82	\$103.99	\$113.99	\$119.11	\$123.12	\$131.31	\$131.31	\$131.31
68	\$44.09	\$61.62	\$99.30	\$105.72	\$115.69	\$120.84	\$125.13	\$133.34	\$133.34	\$133.34
69	\$44.93	\$62.70	\$100.81	\$107.48	\$117.46	\$120.87	\$127.23	\$135.19	\$135.19	\$135.19
70	\$45.27	\$63.21	\$100.82	\$109.13	\$117.49	\$120.89	\$128.95	\$137.20	\$137.20	\$137.20
71	\$46.37	\$64.99	\$103.72	\$110.85	\$121.10	\$126.15	\$131.30	\$139.06	\$139.06	\$139.06
72	\$46.95	\$66.12	\$103.74	\$112.68	\$122.31	\$128.07	\$131.32	\$141.54	\$141.54	\$141.54
73	\$47.24	\$67.32	\$106.68	\$114.39	\$122.34	\$129.81	\$133.61	\$143.98	\$143.98	\$143.98
74	\$47.25	\$68.37	\$108.07	\$116.17	\$124.37	\$131.62	\$136.03	\$146.38	\$146.38	\$146.38
75	\$47.27	\$68.99	\$108.08	\$116.18	\$126.93	\$133.39	\$138.26	\$148.49	\$148.49	\$148.49
76	\$49.89	\$70.70	\$110.96	\$119.51	\$129.48	\$135.13	\$140.47	\$150.83	\$150.83	\$150.83
77	\$50.24	\$71.78	\$111.48	\$121.16	\$129.97	\$136.91	\$142.37	\$152.96	\$152.96	\$152.96
78	\$50.26	\$72.21	\$111.49	\$122.68	\$130.41	\$137.03	\$144.17	\$155.05	\$155.05	\$155.05
79	\$50.27	\$73.20	\$111.51	\$124.28	\$131.62	\$138.80	\$145.10	\$157.19	\$157.19	\$157.19
80	\$50.31	\$74.03	\$113.04	\$125.80	\$133.47	\$142.20	\$146.24	\$159.34	\$159.34	\$159.34
81	\$53.69	\$75.35	\$114.54	\$125.83	\$135.25	\$143.83	\$148.71	\$161.51	\$161.51	\$161.51
82	\$54.01	\$77.01	\$117.92	\$129.08	\$136.33	\$145.87	\$151.51	\$163.54	\$163.54	\$163.54
83	\$55.16	\$77.97	\$117.95	\$130.57	\$142.10	\$145.89	\$152.84	\$165.88	\$165.88	\$165.88
84	\$55.20	\$78.82	\$119.77	\$130.62	\$142.76	\$148.54	\$154.83	\$168.21	\$168.21	\$168.21
85	\$55.21	\$79.78	\$121.60	\$133.68	\$142.80	\$151.16	\$156.47	\$169.32	\$169.32	\$169.32
86	\$57.01	\$80.01	\$125.32	\$135.25	\$143.58	\$152.93	\$158.96	\$172.37	\$172.37	\$172.37
87	\$57.03	\$81.72	\$126.45	\$136.83	\$145.66	\$154.33	\$160.52	\$174.39	\$174.39	\$174.39
88	\$57.05	\$81.94	\$128.47	\$138.32	\$150.65	\$156.07	\$162.77	\$176.06	\$176.06	\$176.06
89	\$57.06	\$81.95	\$130.06	\$139.98	\$152.33	\$157.93	\$163.99	\$177.76	\$177.76	\$177.76
90	\$57.10	\$81.97	\$131.64	\$141.48	\$154.25	\$159.95	\$165.82	\$179.64	\$179.64	\$179.64
91	\$60.39	\$85.50	\$132.97	\$143.09	\$155.58	\$161.10	\$167.39	\$181.95	\$181.95	\$181.95
92	\$60.40	\$85.63	\$134.87	\$144.77	\$155.70	\$163.57	\$169.44	\$183.01	\$183.01	\$183.01
93	\$60.42	\$86.59	\$136.35	\$144.78	\$155.71	\$165.36	\$171.93	\$186.18	\$186.18	\$186.18
94	\$60.43	\$87.48	\$137.96	\$147.91	\$155.75	\$167.08	\$172.85	\$188.62	\$188.62	\$188.62
95	\$60.46	\$87.49	\$139.50	\$147.94	\$158.68	\$168.87	\$174.65	\$190.45	\$190.45	\$190.45
96	\$64.00	\$89.01	\$140.84	\$151.00	\$164.31	\$170.78	\$176.27	\$192.51	\$192.51	\$192.51
97	\$64.59	\$89.01	\$142.29	\$151.91	\$164.34	\$172.52	\$179.26	\$194.35	\$194.35	\$194.35
98	\$64.60	\$89.01	\$143.79	\$151.91	\$164.35	\$173.88	\$181.17	\$195.82	\$195.82	\$195.82
99	\$65.27	\$89.01	\$144.79	\$151.91	\$164.37	\$174.46	\$181.58	\$195.82	\$195.82	\$195.82
100	\$65.27	\$89.01	\$144.79	\$151.91	\$167.34	\$174.46	\$181.58	\$195.82	\$195.82	\$195.82
101	\$65.93	\$89.90	\$146.24	\$153.43	\$169.01	\$176.21	\$183.40	\$197.78	\$197.78	\$197.78
102	\$66.58	\$90.79	\$147.69	\$154.95	\$170.69	\$177.95	\$185.21	\$199.74	\$199.74	\$199.74
103	\$67.23	\$91.68	\$149.13	\$156.47	\$172.36	\$179.70	\$187.03	\$201.70	\$201.70	\$201.70
104	\$67.89	\$92.57	\$150.58	\$157.99	\$174.03	\$181.44	\$188.85	\$203.66	\$203.66	\$203.66
105	\$68.54	\$93.46	\$152.03	\$159.51	\$175.71	\$183.18	\$190.66	\$205.62	\$205.62	\$205.62
106	\$69.19	\$94.35	\$153.48	\$161.03	\$177.38	\$184.93	\$192.48	\$207.57	\$207.57	\$207.57
107	\$69.84	\$95.24	\$154.93	\$162.55	\$179.05	\$186.67	\$194.29	\$209.53	\$209.53	\$209.53
108	\$70.50	\$96.13	\$156.37	\$164.06	\$180.73	\$188.42	\$196.11	\$211.49	\$211.49	\$211.49
109	\$71.15	\$97.02	\$157.82	\$165.58	\$182.40	\$190.16	\$197.92	\$213.45	\$213.45	\$213.45
110	\$71.80	\$97.91	\$159.27	\$167.10	\$184.07	\$191.91	\$199.74	\$215.41	\$215.41	\$215.41
111	\$72.45	\$98.80	\$160.72	\$168.62	\$185.75	\$193.65	\$201.56	\$217.36	\$217.36	\$217.36
112	\$73.11	\$99.69	\$162.17	\$170.14	\$187.42	\$195.40	\$203.37	\$219.32	\$219.32	\$219.32
113	\$73.76	\$100.58	\$163.61	\$171.66	\$189.09	\$197.14	\$205.19	\$221.28	\$221.28	\$221.28
114	\$74.41	\$101.47	\$165.06	\$173.18	\$190.77	\$198.89	\$207.00	\$223.24	\$223.24	\$223.24
115	\$75.07	\$102.36	\$166.51	\$174.70	\$192.44	\$200.63	\$208.82	\$225.20	\$225.20	\$225.20

116	\$75.72	\$103.25	\$167.96	\$176.22	\$194.12	\$202.38	\$210.64	\$227.16	\$227.16	\$227.16
117	\$76.37	\$104.14	\$169.41	\$177.74	\$195.79	\$204.12	\$212.45	\$229.11	\$229.11	\$229.11
118	\$77.02	\$105.03	\$170.85	\$179.26	\$197.46	\$205.86	\$214.27	\$231.07	\$231.07	\$231.07
119	\$77.68	\$105.92	\$172.30	\$180.78	\$199.14	\$207.61	\$216.08	\$233.03	\$233.03	\$233.03
120	\$78.33	\$106.81	\$173.75	\$182.29	\$200.81	\$209.35	\$217.90	\$234.99	\$234.99	\$234.99
121	\$78.98	\$107.70	\$175.20	\$183.81	\$202.48	\$211.10	\$219.71	\$236.95	\$236.95	\$236.95
122	\$79.64	\$108.59	\$176.65	\$185.33	\$204.16	\$212.84	\$221.53	\$238.91	\$238.91	\$238.91
123	\$80.29	\$109.48	\$178.09	\$186.85	\$205.83	\$214.59	\$223.35	\$240.86	\$240.86	\$240.86
124	\$80.94	\$110.37	\$179.54	\$188.37	\$207.50	\$216.33	\$225.16	\$242.82	\$242.82	\$242.82
125	\$81.59	\$111.26	\$180.99	\$189.89	\$209.18	\$218.08	\$226.98	\$244.78	\$244.78	\$244.78
126	\$82.25	\$112.15	\$182.44	\$191.41	\$210.85	\$219.82	\$228.79	\$246.74	\$246.74	\$246.74
127	\$82.90	\$113.04	\$183.88	\$192.93	\$212.52	\$221.57	\$230.61	\$248.70	\$248.70	\$248.70
128	\$83.55	\$113.93	\$185.33	\$194.45	\$214.20	\$223.31	\$232.43	\$250.65	\$250.65	\$250.65
129	\$84.20	\$114.82	\$186.78	\$195.97	\$215.87	\$225.06	\$234.24	\$252.61	\$252.61	\$252.61
130	\$84.86	\$115.71	\$188.23	\$197.49	\$217.54	\$226.80	\$236.06	\$254.57	\$254.57	\$254.57
131	\$85.51	\$116.60	\$189.68	\$199.00	\$219.22	\$228.54	\$237.87	\$256.53	\$256.53	\$256.53
132	\$86.16	\$117.49	\$191.12	\$200.52	\$220.89	\$230.29	\$239.69	\$258.49	\$258.49	\$258.49
133	\$86.82	\$118.38	\$192.57	\$202.04	\$222.56	\$232.03	\$241.50	\$260.45	\$260.45	\$260.45
134	\$87.47	\$119.27	\$194.02	\$203.56	\$224.24	\$233.78	\$243.32	\$262.40	\$262.40	\$262.40
135	\$88.12	\$120.16	\$195.47	\$205.08	\$225.91	\$235.52	\$245.14	\$264.36	\$264.36	\$264.36
136	\$88.77	\$121.05	\$196.92	\$206.60	\$227.58	\$237.27	\$246.95	\$266.32	\$266.32	\$266.32
137	\$89.43	\$121.95	\$198.36	\$208.12	\$229.26	\$239.01	\$248.77	\$268.28	\$268.28	\$268.28
138	\$90.08	\$122.84	\$199.81	\$209.64	\$230.93	\$240.76	\$250.58	\$270.24	\$270.24	\$270.24
139	\$90.73	\$123.73	\$201.26	\$211.16	\$232.60	\$242.50	\$252.40	\$272.20	\$272.20	\$272.20
140	\$91.38	\$124.62	\$202.71	\$212.68	\$234.28	\$244.25	\$254.22	\$274.15	\$274.15	\$274.15
141	\$92.04	\$125.51	\$204.16	\$214.20	\$235.95	\$245.99	\$256.03	\$276.11	\$276.11	\$276.11
142	\$92.69	\$126.40	\$205.60	\$215.72	\$237.62	\$247.74	\$257.85	\$278.07	\$278.07	\$278.07
143	\$93.34	\$127.29	\$207.05	\$217.23	\$239.30	\$249.48	\$259.66	\$280.03	\$280.03	\$280.03
144	\$94.00	\$128.18	\$208.50	\$218.75	\$240.97	\$251.22	\$261.48	\$281.99	\$281.99	\$281.99
145	\$94.65	\$129.07	\$209.95	\$220.27	\$242.64	\$252.97	\$263.29	\$283.94	\$283.94	\$283.94
146	\$95.30	\$129.96	\$211.40	\$221.79	\$244.32	\$254.71	\$265.11	\$285.90	\$285.90	\$285.90
147	\$95.95	\$130.85	\$212.84	\$223.31	\$245.99	\$256.46	\$266.93	\$287.86	\$287.86	\$287.86
148	\$96.61	\$131.74	\$214.29	\$224.83	\$247.66	\$258.20	\$268.74	\$289.82	\$289.82	\$289.82
149	\$97.26	\$132.63	\$215.74	\$226.35	\$249.34	\$259.95	\$270.56	\$291.78	\$291.78	\$291.78
150	\$97.91	\$133.52	\$217.19	\$227.87	\$251.01	\$261.69	\$272.37	\$293.74	\$293.74	\$293.74
Price/Lb.	\$0.65	\$0.88	\$1.44	\$1.51	\$1.66	\$1.73	\$1.80	\$1.95	\$1.95	\$1.95

Any fraction of a pound more than the weight shown in the rate chart is rounded up to the next listed weight.

*UPS offers customized rate sheets identifying its firm offer of rates and prices for transportation rates and prices. The rates and prices identified in the rate sheets will be guaranteed for 12-month periods and increase only with approval by the Lead State. Other fees and charges that may impact an authorized user's invoice are identified in UPS's Rate and Service Guide and as described in UPS's Tariff/Terms and Conditions of Service, in effect at the time of shipping. These fees and charges are subject to change without notice. In accordance with the conditions of the solicitation, UPS has waived all pick-up charges, including on-call/on-demand, and capped fuel surcharges at 7%. Fuel surcharge information is posted on UPS's website, www.ups.com.

NASPO ValuePoint**UPS Next Day Air Saver®****Daily Commercial Rates***

Lbs.	Zone 132	Zone 133	Zone 134	Zone 135	Zone 136	Zone 137	Zone 138
Letter	\$8.16	\$10.62	\$13.51	\$14.99	\$16.25	\$17.36	\$17.83
1	\$8.17	\$10.64	\$13.52	\$15.01	\$16.26	\$17.38	\$17.84
2	\$8.18	\$10.65	\$13.53	\$15.02	\$16.27	\$17.39	\$17.85
3	\$8.19	\$10.66	\$14.84	\$16.13	\$17.91	\$18.45	\$19.13
4	\$8.20	\$10.67	\$16.08	\$17.68	\$19.57	\$20.13	\$20.91
5	\$8.44	\$10.80	\$17.60	\$19.21	\$20.88	\$21.42	\$22.19
6	\$8.90	\$12.15	\$19.01	\$20.51	\$22.60	\$22.95	\$23.93
7	\$9.09	\$12.72	\$20.37	\$22.29	\$24.20	\$24.69	\$25.55
8	\$9.57	\$13.05	\$21.68	\$23.71	\$25.84	\$26.47	\$27.19
9	\$10.06	\$13.65	\$22.89	\$25.22	\$27.43	\$28.17	\$28.96
10	\$10.28	\$14.16	\$23.93	\$26.57	\$29.07	\$29.84	\$30.68
11	\$10.63	\$14.82	\$25.20	\$28.02	\$30.68	\$31.57	\$32.32
12	\$10.98	\$15.54	\$26.57	\$29.33	\$32.20	\$33.29	\$34.06
13	\$11.17	\$16.33	\$27.83	\$30.67	\$33.48	\$35.03	\$35.72
14	\$11.51	\$16.94	\$29.27	\$31.94	\$34.77	\$36.58	\$37.46
15	\$12.00	\$17.53	\$30.26	\$33.25	\$36.06	\$37.76	\$38.89
16	\$12.25	\$17.98	\$31.71	\$34.47	\$37.25	\$38.76	\$39.87
17	\$12.88	\$18.29	\$32.61	\$35.58	\$38.11	\$39.63	\$40.73
18	\$13.27	\$18.76	\$33.60	\$36.34	\$38.96	\$40.52	\$41.80
19	\$13.61	\$19.27	\$34.39	\$37.10	\$39.84	\$41.40	\$42.93
20	\$13.84	\$19.82	\$37.10	\$40.29	\$43.12	\$44.94	\$46.57
21	\$14.23	\$20.24	\$38.08	\$41.27	\$44.40	\$46.21	\$47.89
22	\$14.73	\$20.65	\$39.02	\$42.24	\$45.51	\$47.25	\$48.86
23	\$14.95	\$21.04	\$40.13	\$43.26	\$46.57	\$48.15	\$50.04
24	\$15.36	\$21.37	\$41.18	\$44.40	\$47.84	\$49.34	\$51.07
25	\$15.68	\$21.86	\$42.40	\$45.81	\$49.07	\$50.82	\$52.27
26	\$16.08	\$22.47	\$43.64	\$46.91	\$50.21	\$51.86	\$53.44
27	\$16.32	\$23.07	\$44.79	\$47.95	\$51.18	\$53.50	\$54.81
28	\$16.83	\$23.69	\$45.81	\$48.90	\$52.43	\$54.39	\$56.36
29	\$17.17	\$23.81	\$46.80	\$49.89	\$53.44	\$55.41	\$57.81
30	\$17.43	\$24.42	\$48.09	\$51.00	\$54.72	\$56.93	\$58.69
31	\$17.78	\$24.65	\$49.07	\$52.27	\$55.91	\$57.92	\$59.73
32	\$18.16	\$24.84	\$49.89	\$53.44	\$57.18	\$59.01	\$60.90
33	\$18.56	\$25.61	\$50.91	\$54.51	\$58.60	\$60.15	\$62.26
34	\$18.86	\$26.18	\$52.17	\$55.51	\$59.90	\$61.37	\$63.45
35	\$19.44	\$26.69	\$53.28	\$56.62	\$61.05	\$62.69	\$64.78
36	\$19.77	\$27.27	\$54.38	\$57.76	\$62.27	\$63.98	\$66.25
37	\$20.16	\$27.63	\$55.83	\$59.19	\$63.51	\$65.08	\$67.49
38	\$20.51	\$28.17	\$57.05	\$60.59	\$64.84	\$66.03	\$68.60
39	\$21.02	\$28.84	\$58.33	\$61.87	\$66.39	\$67.17	\$69.88
40	\$21.35	\$29.52	\$59.52	\$63.29	\$67.80	\$68.60	\$71.42
41	\$21.73	\$29.94	\$60.42	\$64.53	\$69.18	\$69.88	\$72.98
42	\$22.10	\$30.32	\$61.47	\$65.97	\$70.57	\$71.28	\$74.69
43	\$22.47	\$31.00	\$62.55	\$67.35	\$71.83	\$72.72	\$76.31
44	\$22.87	\$31.53	\$63.72	\$68.60	\$73.42	\$73.94	\$77.89
45	\$23.24	\$32.23	\$64.84	\$69.88	\$74.79	\$75.35	\$78.93
46	\$23.59	\$32.78	\$66.03	\$71.02	\$76.09	\$76.79	\$80.42
47	\$24.09	\$33.44	\$67.35	\$72.12	\$77.20	\$78.33	\$81.77
48	\$24.47	\$34.12	\$68.60	\$73.42	\$78.42	\$79.59	\$82.82
49	\$24.84	\$34.79	\$69.56	\$74.26	\$79.65	\$80.89	\$83.88
50	\$25.31	\$35.33	\$69.64	\$74.27	\$79.66	\$80.91	\$83.91
51	\$25.68	\$35.98	\$71.83	\$76.91	\$81.94	\$83.80	\$87.21
52	\$26.18	\$36.52	\$72.98	\$78.32	\$83.12	\$85.47	\$88.84
53	\$26.69	\$37.31	\$74.08	\$79.68	\$84.05	\$86.93	\$90.38

54	\$27.05	\$38.04	\$75.35	\$80.72	\$85.23	\$88.47	\$92.03
55	\$27.52	\$38.83	\$76.50	\$81.77	\$86.48	\$89.63	\$93.64
56	\$28.04	\$39.51	\$77.76	\$82.65	\$87.75	\$91.54	\$95.00
57	\$28.66	\$40.32	\$78.63	\$84.30	\$89.41	\$93.21	\$96.17
58	\$29.27	\$41.25	\$79.59	\$85.33	\$91.31	\$95.00	\$98.09
59	\$29.77	\$42.31	\$80.85	\$86.38	\$93.07	\$96.46	\$99.62
60	\$30.22	\$43.22	\$82.13	\$88.30	\$94.66	\$98.26	\$101.50
61	\$30.77	\$44.03	\$83.39	\$89.32	\$96.17	\$99.91	\$103.75
62	\$31.63	\$44.70	\$84.69	\$90.72	\$97.95	\$101.40	\$105.41
63	\$32.10	\$45.56	\$86.07	\$92.12	\$99.29	\$102.86	\$107.58
64	\$32.73	\$46.46	\$87.33	\$93.54	\$100.94	\$104.81	\$109.26
65	\$33.23	\$47.28	\$88.58	\$94.83	\$102.45	\$106.46	\$111.10
66	\$33.81	\$47.31	\$88.60	\$94.85	\$104.37	\$108.55	\$112.51
67	\$34.35	\$49.17	\$91.31	\$97.60	\$105.82	\$110.01	\$114.20
68	\$34.98	\$50.13	\$92.69	\$99.05	\$107.85	\$111.64	\$116.03
69	\$35.58	\$50.93	\$93.77	\$100.45	\$109.26	\$113.46	\$117.81
70	\$36.33	\$51.98	\$95.19	\$101.96	\$111.05	\$115.52	\$119.83
71	\$37.04	\$52.80	\$96.03	\$103.23	\$112.19	\$116.89	\$121.49
72	\$37.75	\$53.62	\$97.31	\$104.64	\$113.79	\$118.84	\$123.61
73	\$38.27	\$54.82	\$98.85	\$106.18	\$115.33	\$120.70	\$125.90
74	\$39.02	\$55.80	\$100.13	\$107.85	\$117.16	\$122.32	\$128.14
75	\$39.63	\$56.58	\$101.28	\$109.47	\$118.71	\$124.33	\$129.47
76	\$40.24	\$56.59	\$102.68	\$111.10	\$120.38	\$126.18	\$131.78
77	\$40.96	\$58.34	\$103.92	\$112.83	\$121.92	\$128.14	\$133.83
78	\$41.61	\$59.31	\$105.39	\$114.43	\$123.46	\$129.81	\$135.74
79	\$42.11	\$60.37	\$106.56	\$116.20	\$125.07	\$131.64	\$137.52
80	\$42.21	\$61.31	\$108.02	\$117.81	\$126.41	\$133.59	\$139.47
81	\$43.43	\$62.44	\$109.28	\$119.27	\$127.71	\$135.31	\$141.24
82	\$44.45	\$63.38	\$110.96	\$120.98	\$129.40	\$137.25	\$143.32
83	\$45.06	\$64.44	\$112.51	\$122.23	\$131.07	\$139.23	\$145.27
84	\$45.54	\$65.42	\$114.37	\$123.80	\$132.58	\$141.23	\$146.74
85	\$45.78	\$66.50	\$116.20	\$125.20	\$134.20	\$143.06	\$148.36
86	\$46.75	\$67.47	\$117.98	\$126.85	\$135.85	\$144.65	\$150.04
87	\$47.28	\$68.53	\$119.83	\$128.57	\$137.43	\$146.33	\$151.95
88	\$47.76	\$69.63	\$121.70	\$129.99	\$138.98	\$148.08	\$153.60
89	\$48.54	\$70.69	\$123.46	\$131.32	\$140.67	\$149.70	\$155.37
90	\$48.55	\$71.65	\$125.42	\$132.79	\$142.22	\$151.22	\$157.44
91	\$49.51	\$72.72	\$127.17	\$134.47	\$143.76	\$153.00	\$159.26
92	\$50.23	\$73.52	\$128.83	\$136.32	\$145.48	\$155.08	\$161.20
93	\$50.96	\$74.43	\$130.36	\$138.00	\$147.12	\$156.84	\$162.95
94	\$51.45	\$75.22	\$131.99	\$139.53	\$148.70	\$158.55	\$164.75
95	\$51.47	\$75.96	\$133.18	\$141.08	\$150.37	\$159.69	\$166.56
96	\$52.22	\$75.96	\$134.63	\$142.58	\$151.91	\$161.48	\$168.04
97	\$52.22	\$75.96	\$135.99	\$144.32	\$151.91	\$163.14	\$169.65
98	\$52.22	\$75.96	\$137.43	\$145.87	\$151.91	\$164.79	\$169.71
99	\$52.22	\$75.96	\$138.86	\$145.98	\$151.91	\$164.97	\$169.71
100	\$52.22	\$75.96	\$138.86	\$145.98	\$151.91	\$164.97	\$169.71
101	\$52.74	\$76.72	\$140.25	\$147.44	\$153.43	\$166.62	\$171.41
102	\$53.26	\$77.48	\$141.63	\$148.90	\$154.95	\$168.27	\$173.11
103	\$53.79	\$78.23	\$143.02	\$150.36	\$156.47	\$169.92	\$174.81
104	\$54.31	\$78.99	\$144.41	\$151.82	\$157.99	\$171.57	\$176.50
105	\$54.83	\$79.75	\$145.80	\$153.28	\$159.51	\$173.22	\$178.20
106	\$55.35	\$80.51	\$147.19	\$154.74	\$161.03	\$174.86	\$179.90
107	\$55.88	\$81.27	\$148.58	\$156.20	\$162.55	\$176.51	\$181.59
108	\$56.40	\$82.03	\$149.97	\$157.66	\$164.06	\$178.16	\$183.29
109	\$56.92	\$82.79	\$151.35	\$159.12	\$165.58	\$179.81	\$184.99
110	\$57.44	\$83.55	\$152.74	\$160.58	\$167.10	\$181.46	\$186.69
111	\$57.96	\$84.31	\$154.13	\$162.04	\$168.62	\$183.11	\$188.38
112	\$58.49	\$85.07	\$155.52	\$163.50	\$170.14	\$184.76	\$190.08
113	\$59.01	\$85.83	\$156.91	\$164.96	\$171.66	\$186.41	\$191.78
114	\$59.53	\$86.59	\$158.30	\$166.41	\$173.18	\$188.06	\$193.47
115	\$60.05	\$87.35	\$159.69	\$167.87	\$174.70	\$189.71	\$195.17
116	\$60.57	\$88.11	\$161.07	\$169.33	\$176.22	\$191.36	\$196.87
117	\$61.10	\$88.87	\$162.46	\$170.79	\$177.74	\$193.01	\$198.57
118	\$61.62	\$89.63	\$163.85	\$172.25	\$179.26	\$194.66	\$200.26
119	\$62.14	\$90.39	\$165.24	\$173.71	\$180.78	\$196.31	\$201.96

120	\$62.66	\$91.15	\$166.63	\$175.17	\$182.29	\$197.96	\$203.66
121	\$63.19	\$91.91	\$168.02	\$176.63	\$183.81	\$199.61	\$205.35
122	\$63.71	\$92.67	\$169.41	\$178.09	\$185.33	\$201.26	\$207.05
123	\$64.23	\$93.43	\$170.79	\$179.55	\$186.85	\$202.91	\$208.75
124	\$64.75	\$94.19	\$172.18	\$181.01	\$188.37	\$204.56	\$210.45
125	\$65.27	\$94.95	\$173.57	\$182.47	\$189.89	\$206.21	\$212.14
126	\$65.80	\$95.70	\$174.96	\$183.93	\$191.41	\$207.86	\$213.84
127	\$66.32	\$96.46	\$176.35	\$185.39	\$192.93	\$209.51	\$215.54
128	\$66.84	\$97.22	\$177.74	\$186.85	\$194.45	\$211.16	\$217.23
129	\$67.36	\$97.98	\$179.13	\$188.31	\$195.97	\$212.81	\$218.93
130	\$67.89	\$98.74	\$180.51	\$189.77	\$197.49	\$214.46	\$220.63
131	\$68.41	\$99.50	\$181.90	\$191.23	\$199.00	\$216.11	\$222.33
132	\$68.93	\$100.26	\$183.29	\$192.69	\$200.52	\$217.76	\$224.02
133	\$69.45	\$101.02	\$184.68	\$194.15	\$202.04	\$219.41	\$225.72
134	\$69.97	\$101.78	\$186.07	\$195.61	\$203.56	\$221.06	\$227.42
135	\$70.50	\$102.54	\$187.46	\$197.07	\$205.08	\$222.71	\$229.11
136	\$71.02	\$103.30	\$188.85	\$198.53	\$206.60	\$224.36	\$230.81
137	\$71.54	\$104.06	\$190.23	\$199.99	\$208.12	\$226.00	\$232.51
138	\$72.06	\$104.82	\$191.62	\$201.45	\$209.64	\$227.65	\$234.21
139	\$72.59	\$105.58	\$193.01	\$202.91	\$211.16	\$229.30	\$235.90
140	\$73.11	\$106.34	\$194.40	\$204.37	\$212.68	\$230.95	\$237.60
141	\$73.63	\$107.10	\$195.79	\$205.83	\$214.20	\$232.60	\$239.30
142	\$74.15	\$107.86	\$197.18	\$207.29	\$215.72	\$234.25	\$240.99
143	\$74.67	\$108.62	\$198.57	\$208.75	\$217.23	\$235.90	\$242.69
144	\$75.20	\$109.38	\$199.95	\$210.21	\$218.75	\$237.55	\$244.39
145	\$75.72	\$110.14	\$201.34	\$211.67	\$220.27	\$239.20	\$246.09
146	\$76.24	\$110.90	\$202.73	\$213.13	\$221.79	\$240.85	\$247.78
147	\$76.76	\$111.66	\$204.12	\$214.59	\$223.31	\$242.50	\$249.48
148	\$77.29	\$112.41	\$205.51	\$216.05	\$224.83	\$244.15	\$251.18
149	\$77.81	\$113.17	\$206.90	\$217.51	\$226.35	\$245.80	\$252.87
150	\$78.33	\$113.93	\$208.29	\$218.97	\$227.87	\$247.45	\$254.57
Price/Lb.	\$0.52	\$0.75	\$1.38	\$1.45	\$1.51	\$1.64	\$1.69

Any fraction of a pound more than the weight shown in the rate chart is rounded up to the next listed weight.

*UPS offers customized rate sheets identifying its firm offer of rates and prices for transportation rates and prices. The rates and prices identified in the rate sheets will be guaranteed for 12-month periods and increase only with approval by the Lead State. Other fees and charges that may impact an authorized user's invoice are identified in UPS's Rate and Service Guide and as described in UPS's Tariff/Terms and Conditions of Service, in effect at the time of shipping. These fees and charges are subject to change without notice. In accordance with the conditions of the solicitation, UPS has waived all pick-up charges, including on-call/on-demand, and capped fuel surcharges at 7%. Fuel surcharge information is posted on UPS's website, www.ups.com.

NASPO ValuePoint

UPS 2nd Day Air A.M.[®]

Daily Commercial Rates*

Lbs.	Zone 242	Zone 243	Zone 244	Zone 245	Zone 246	Zone 247	Zone 248
Letter*	\$8.14	\$8.15	\$8.15	\$8.15	\$8.15	\$8.43	\$16.17
1	\$8.16	\$8.16	\$8.16	\$8.16	\$8.49	\$8.87	\$16.18
2	\$8.17	\$8.17	\$8.17	\$8.17	\$9.38	\$10.23	\$16.19
3	\$8.18	\$8.18	\$8.18	\$8.18	\$10.76	\$11.87	\$16.20
4	\$8.19	\$8.19	\$8.19	\$9.30	\$12.45	\$13.53	\$16.22
5	\$8.20	\$8.20	\$8.20	\$10.30	\$13.90	\$14.99	\$16.23
6	\$8.22	\$8.22	\$8.41	\$11.26	\$15.48	\$16.72	\$17.39
7	\$8.23	\$8.23	\$9.11	\$12.32	\$17.39	\$18.54	\$19.13
8	\$8.24	\$8.24	\$9.76	\$13.38	\$19.21	\$20.41	\$21.01
9	\$8.25	\$8.52	\$10.53	\$14.37	\$20.91	\$22.36	\$23.11
10	\$8.26	\$9.07	\$11.32	\$15.37	\$22.30	\$24.34	\$24.97
11	\$8.27	\$9.53	\$11.87	\$16.43	\$24.09	\$26.11	\$27.05
12	\$8.49	\$10.08	\$12.47	\$17.36	\$25.93	\$27.97	\$28.90
13	\$9.07	\$10.62	\$12.96	\$18.42	\$27.64	\$29.31	\$30.58
14	\$9.47	\$11.17	\$13.77	\$19.49	\$29.31	\$30.88	\$31.93
15	\$9.83	\$11.45	\$14.50	\$20.21	\$30.88	\$32.23	\$33.43
16	\$10.08	\$11.82	\$15.08	\$20.89	\$32.23	\$33.90	\$34.79
17	\$10.43	\$12.19	\$15.71	\$21.85	\$33.67	\$35.68	\$36.45
18	\$10.74	\$12.57	\$16.37	\$22.64	\$35.07	\$37.27	\$38.63
19	\$11.17	\$12.92	\$16.83	\$23.56	\$36.36	\$39.01	\$39.89
20	\$11.55	\$13.49	\$17.47	\$24.63	\$37.62	\$40.32	\$41.29
21	\$12.12	\$14.03	\$18.11	\$25.45	\$39.01	\$41.67	\$43.22
22	\$12.45	\$14.66	\$18.61	\$26.16	\$40.28	\$43.25	\$44.83
23	\$12.79	\$14.99	\$19.27	\$26.95	\$41.67	\$44.66	\$46.49
24	\$13.05	\$15.58	\$19.86	\$27.95	\$43.20	\$46.43	\$48.15
25	\$13.49	\$16.06	\$20.28	\$28.96	\$44.61	\$48.08	\$49.82
26	\$13.90	\$16.45	\$21.01	\$29.88	\$46.14	\$49.72	\$51.18
27	\$14.35	\$16.97	\$21.60	\$30.93	\$47.70	\$51.39	\$52.79
28	\$14.79	\$17.54	\$22.00	\$31.69	\$48.88	\$52.71	\$54.08
29	\$15.20	\$17.81	\$22.72	\$32.41	\$50.24	\$54.08	\$55.65
30	\$15.49	\$18.34	\$23.51	\$33.47	\$51.59	\$55.48	\$57.09
31	\$15.94	\$18.89	\$24.14	\$34.23	\$52.79	\$56.73	\$58.57
32	\$16.18	\$19.33	\$24.86	\$35.05	\$54.32	\$58.27	\$60.03
33	\$16.62	\$19.80	\$25.47	\$35.77	\$55.78	\$59.65	\$61.51
34	\$17.15	\$20.21	\$26.04	\$37.08	\$57.51	\$61.07	\$63.04
35	\$17.52	\$20.83	\$26.60	\$37.78	\$60.42	\$62.20	\$64.56
36	\$17.74	\$21.29	\$27.12	\$38.57	\$61.64	\$63.34	\$65.97
37	\$18.09	\$21.61	\$27.80	\$39.56	\$62.91	\$64.43	\$66.81
38	\$18.42	\$21.93	\$28.51	\$40.34	\$64.18	\$65.36	\$67.95
39	\$18.98	\$22.49	\$28.97	\$41.15	\$65.70	\$66.52	\$69.20
40	\$19.49	\$23.07	\$29.63	\$42.11	\$67.13	\$67.95	\$70.71
41	\$19.99	\$23.62	\$30.03	\$42.87	\$68.48	\$69.20	\$72.25

42	\$20.28	\$24.23	\$30.64	\$43.73	\$69.86	\$70.56	\$73.94
43	\$20.73	\$24.71	\$31.07	\$44.47	\$71.11	\$71.99	\$75.55
44	\$21.09	\$25.05	\$31.78	\$45.28	\$72.69	\$73.21	\$77.25
45	\$21.60	\$25.62	\$32.23	\$45.91	\$74.02	\$74.59	\$78.65
46	\$21.83	\$25.93	\$32.89	\$46.62	\$75.33	\$76.05	\$79.90
47	\$22.30	\$26.45	\$33.49	\$47.26	\$76.43	\$77.56	\$81.12
48	\$22.72	\$27.05	\$34.06	\$47.97	\$77.62	\$78.78	\$82.28
49	\$23.18	\$27.70	\$34.65	\$48.80	\$78.84	\$80.06	\$83.05
50	\$23.53	\$28.06	\$35.19	\$49.59	\$78.85	\$80.07	\$83.07
51	\$23.85	\$28.33	\$35.77	\$50.32	\$81.12	\$82.95	\$86.34
52	\$24.14	\$28.79	\$36.45	\$51.53	\$82.28	\$84.64	\$87.98
53	\$24.58	\$29.37	\$36.92	\$52.30	\$83.22	\$86.46	\$89.77
54	\$24.93	\$29.86	\$37.48	\$53.09	\$84.37	\$88.37	\$91.46
55	\$25.42	\$30.33	\$37.97	\$54.08	\$85.59	\$89.62	\$93.03
56	\$25.81	\$30.77	\$38.51	\$54.95	\$86.86	\$91.53	\$94.67
57	\$26.11	\$31.27	\$39.11	\$55.72	\$88.54	\$93.20	\$95.94
58	\$26.60	\$31.78	\$39.85	\$56.65	\$90.38	\$94.95	\$97.70
59	\$26.95	\$32.16	\$40.61	\$57.64	\$92.17	\$96.45	\$99.32
60	\$27.19	\$32.44	\$41.24	\$58.46	\$93.71	\$98.24	\$100.96
61	\$27.70	\$32.89	\$41.78	\$59.21	\$95.37	\$99.89	\$102.71
62	\$28.19	\$33.52	\$42.29	\$60.18	\$97.05	\$101.40	\$104.63
63	\$28.66	\$34.06	\$42.82	\$61.01	\$98.71	\$102.86	\$106.49
64	\$29.17	\$34.60	\$43.29	\$61.81	\$100.40	\$104.81	\$108.36
65	\$29.58	\$35.08	\$43.96	\$62.72	\$101.91	\$106.43	\$109.96
66	\$30.00	\$35.40	\$44.60	\$63.74	\$103.57	\$108.36	\$111.39
67	\$30.22	\$36.08	\$45.28	\$64.78	\$105.09	\$109.96	\$113.04
68	\$30.61	\$36.45	\$45.91	\$65.90	\$106.78	\$111.52	\$114.90
69	\$31.09	\$36.92	\$46.53	\$67.10	\$108.63	\$113.04	\$116.62
70	\$31.58	\$37.50	\$47.26	\$68.27	\$110.43	\$114.57	\$118.62
71	\$31.98	\$38.05	\$47.90	\$69.19	\$111.10	\$115.69	\$120.30
72	\$32.36	\$38.71	\$48.54	\$70.25	\$112.70	\$117.66	\$122.37
73	\$32.68	\$39.06	\$49.19	\$71.42	\$114.17	\$119.50	\$124.60
74	\$33.16	\$39.53	\$49.85	\$72.36	\$115.99	\$121.10	\$126.86
75	\$33.60	\$40.16	\$50.44	\$73.36	\$117.58	\$123.08	\$128.16
76	\$33.95	\$40.64	\$51.06	\$74.20	\$119.18	\$124.92	\$130.44
77	\$34.57	\$41.17	\$51.67	\$75.15	\$120.71	\$126.86	\$132.73
78	\$34.89	\$41.48	\$52.41	\$76.23	\$122.21	\$128.51	\$135.09
79	\$35.31	\$42.00	\$53.11	\$77.33	\$123.82	\$130.31	\$137.10
80	\$35.85	\$42.49	\$53.86	\$78.31	\$125.19	\$132.27	\$138.31
81	\$36.15	\$43.00	\$54.47	\$78.47	\$126.45	\$133.96	\$140.51
82	\$36.54	\$43.53	\$55.07	\$80.35	\$128.12	\$135.89	\$142.26
83	\$36.83	\$44.00	\$55.80	\$81.04	\$129.77	\$137.81	\$144.13
84	\$37.30	\$44.60	\$56.27	\$81.75	\$131.27	\$139.83	\$145.74
85	\$37.75	\$45.19	\$56.88	\$83.05	\$132.88	\$141.63	\$147.52
86	\$38.24	\$45.28	\$57.55	\$84.03	\$134.49	\$143.37	\$149.30
87	\$38.57	\$46.11	\$58.17	\$85.00	\$136.03	\$145.40	\$150.93
88	\$38.88	\$46.67	\$58.88	\$85.75	\$137.56	\$147.03	\$152.65
89	\$39.32	\$47.00	\$59.44	\$86.57	\$139.25	\$148.67	\$154.53
90	\$39.96	\$47.44	\$60.03	\$87.48	\$140.78	\$150.29	\$156.18
91	\$40.55	\$48.05	\$60.18	\$88.61	\$142.31	\$152.03	\$157.93
92	\$41.05	\$48.56	\$61.24	\$89.53	\$144.01	\$153.69	\$159.69
93	\$41.36	\$48.66	\$61.95	\$90.20	\$145.65	\$155.26	\$161.48
94	\$41.73	\$48.66	\$62.03	\$90.20	\$147.21	\$157.06	\$163.12
95	\$42.11	\$48.66	\$63.27	\$90.20	\$148.86	\$158.62	\$164.96

96	\$42.39	\$48.66	\$63.80	\$90.20	\$150.55	\$160.33	\$166.59
97	\$42.82	\$48.66	\$64.09	\$90.20	\$151.91	\$162.04	\$168.33
98	\$43.20	\$48.66	\$64.09	\$90.20	\$151.91	\$163.70	\$168.53
99	\$43.58	\$48.66	\$64.09	\$90.20	\$151.91	\$163.78	\$168.53
100	\$43.91	\$48.66	\$64.09	\$90.20	\$151.91	\$163.78	\$168.53
101	\$44.35	\$49.15	\$64.73	\$91.10	\$153.43	\$165.42	\$170.21
102	\$44.79	\$49.63	\$65.37	\$92.00	\$154.95	\$167.06	\$171.90
103	\$45.23	\$50.12	\$66.01	\$92.90	\$156.47	\$168.69	\$173.58
104	\$45.67	\$50.61	\$66.65	\$93.81	\$157.99	\$170.33	\$175.27
105	\$46.11	\$51.09	\$67.29	\$94.71	\$159.51	\$171.97	\$176.95
106	\$46.55	\$51.58	\$67.93	\$95.61	\$161.03	\$173.61	\$178.64
107	\$46.99	\$52.07	\$68.57	\$96.51	\$162.55	\$175.24	\$180.32
108	\$47.43	\$52.55	\$69.21	\$97.41	\$164.06	\$176.88	\$182.01
109	\$47.86	\$53.04	\$69.86	\$98.32	\$165.58	\$178.52	\$183.69
110	\$48.30	\$53.53	\$70.50	\$99.22	\$167.10	\$180.16	\$185.38
111	\$48.74	\$54.01	\$71.14	\$100.12	\$168.62	\$181.80	\$187.07
112	\$49.18	\$54.50	\$71.78	\$101.02	\$170.14	\$183.43	\$188.75
113	\$49.62	\$54.99	\$72.42	\$101.92	\$171.66	\$185.07	\$190.44
114	\$50.06	\$55.47	\$73.06	\$102.83	\$173.18	\$186.71	\$192.12
115	\$50.50	\$55.96	\$73.70	\$103.73	\$174.70	\$188.35	\$193.81
116	\$50.94	\$56.44	\$74.34	\$104.63	\$176.22	\$189.98	\$195.49
117	\$51.38	\$56.93	\$74.98	\$105.53	\$177.74	\$191.62	\$197.18
118	\$51.82	\$57.42	\$75.62	\$106.43	\$179.26	\$193.26	\$198.86
119	\$52.26	\$57.90	\$76.26	\$107.34	\$180.78	\$194.90	\$200.55
120	\$52.69	\$58.39	\$76.91	\$108.24	\$182.29	\$196.54	\$202.23
121	\$53.13	\$58.88	\$77.55	\$109.14	\$183.81	\$198.17	\$203.92
122	\$53.57	\$59.36	\$78.19	\$110.04	\$185.33	\$199.81	\$205.60
123	\$54.01	\$59.85	\$78.83	\$110.94	\$186.85	\$201.45	\$207.29
124	\$54.45	\$60.34	\$79.47	\$111.85	\$188.37	\$203.09	\$208.97
125	\$54.89	\$60.82	\$80.11	\$112.75	\$189.89	\$204.73	\$210.66
126	\$55.33	\$61.31	\$80.75	\$113.65	\$191.41	\$206.36	\$212.34
127	\$55.77	\$61.80	\$81.39	\$114.55	\$192.93	\$208.00	\$214.03
128	\$56.21	\$62.28	\$82.03	\$115.45	\$194.45	\$209.64	\$215.72
129	\$56.65	\$62.77	\$82.67	\$116.36	\$195.97	\$211.28	\$217.40
130	\$57.09	\$63.26	\$83.31	\$117.26	\$197.49	\$212.91	\$219.09
131	\$57.52	\$63.74	\$83.96	\$118.16	\$199.00	\$214.55	\$220.77
132	\$57.96	\$64.23	\$84.60	\$119.06	\$200.52	\$216.19	\$222.46
133	\$58.40	\$64.72	\$85.24	\$119.96	\$202.04	\$217.83	\$224.14
134	\$58.84	\$65.20	\$85.88	\$120.87	\$203.56	\$219.47	\$225.83
135	\$59.28	\$65.69	\$86.52	\$121.77	\$205.08	\$221.10	\$227.51
136	\$59.72	\$66.18	\$87.16	\$122.67	\$206.60	\$222.74	\$229.20
137	\$60.16	\$66.66	\$87.80	\$123.57	\$208.12	\$224.38	\$230.88
138	\$60.60	\$67.15	\$88.44	\$124.47	\$209.64	\$226.02	\$232.57
139	\$61.04	\$67.64	\$89.08	\$125.37	\$211.16	\$227.65	\$234.25
140	\$61.48	\$68.12	\$89.72	\$126.28	\$212.68	\$229.29	\$235.94
141	\$61.92	\$68.61	\$90.36	\$127.18	\$214.20	\$230.93	\$237.62
142	\$62.36	\$69.10	\$91.00	\$128.08	\$215.72	\$232.57	\$239.31
143	\$62.79	\$69.58	\$91.65	\$128.98	\$217.23	\$234.21	\$240.99
144	\$63.23	\$70.07	\$92.29	\$129.88	\$218.75	\$235.84	\$242.68
145	\$63.67	\$70.56	\$92.93	\$130.79	\$220.27	\$237.48	\$244.36
146	\$64.11	\$71.04	\$93.57	\$131.69	\$221.79	\$239.12	\$246.05
147	\$64.55	\$71.53	\$94.21	\$132.59	\$223.31	\$240.76	\$247.74
148	\$64.99	\$72.02	\$94.85	\$133.49	\$224.83	\$242.39	\$249.42
149	\$65.43	\$72.50	\$95.49	\$134.39	\$226.35	\$244.03	\$251.11

150	\$65.87	\$72.99	\$96.13	\$135.30	\$227.87	\$245.67	\$252.79
Price/Lb.	\$0.44	\$0.48	\$0.64	\$0.90	\$1.51	\$1.63	\$1.67

Any fraction of a pound more than the weight shown in the rate chart is rounded up to the next listed weight.

*UPS offers customized rate sheets identifying its firm offer of rates and prices for transportation rates and prices. The rates and prices identified in the rate sheets will be guaranteed for 12-month periods and increase only with approval by the Lead State. Other fees and charges that may impact an authorized user's invoice are identified in UPS's Rate and Service Guide and as described in UPS's Tariff/Terms and Conditions of Service, in effect at the time of shipping. These fees and charges are subject to change without notice. In accordance with the conditions of the solicitation, UPS has waived all pick-up charges, including on-call/on-demand, and capped fuel surcharges at 7%. Fuel surcharge information is posted on UPS's website, www.ups.com.

NASPO ValuePoint**UPS 2nd Day Air®***(Per Package Rates from 48 State Origin)***Daily Commercial Rates***

								AK, HI	PR	AK, HI +
Lbs.	Zone 202	Zone 203	Zone 204	Zone 205	Zone 206	Zone 207	Zone 208	Zone 224	Zone 225	Zone 226
Letter*	\$8.13	\$8.14	\$8.14	\$8.14	\$8.14	\$8.42	\$16.16	\$16.17	\$16.17	\$16.17
1	\$8.15	\$8.15	\$8.15	\$8.15	\$8.15	\$8.44	\$16.17	\$16.18	\$16.18	\$16.18
2	\$8.16	\$8.16	\$8.16	\$8.16	\$8.16	\$9.74	\$16.18	\$16.19	\$16.19	\$16.19
3	\$8.17	\$8.17	\$8.17	\$8.17	\$10.28	\$11.14	\$16.19	\$16.20	\$16.20	\$16.20
4	\$8.18	\$8.18	\$8.18	\$8.84	\$11.84	\$12.73	\$16.20	\$17.71	\$17.71	\$17.71
5	\$8.19	\$8.19	\$8.19	\$9.81	\$13.22	\$14.08	\$16.22	\$19.19	\$19.19	\$19.19
6	\$8.20	\$8.20	\$8.20	\$10.71	\$14.72	\$15.76	\$16.56	\$20.37	\$20.37	\$20.37
7	\$8.22	\$8.22	\$8.68	\$11.75	\$16.56	\$17.65	\$18.18	\$21.27	\$21.27	\$21.27
8	\$8.23	\$8.23	\$9.27	\$12.76	\$18.27	\$19.48	\$20.02	\$22.36	\$22.36	\$22.36
9	\$8.24	\$8.24	\$10.00	\$13.70	\$19.91	\$21.29	\$21.99	\$23.96	\$23.96	\$23.96
10	\$8.25	\$8.62	\$10.75	\$14.63	\$21.24	\$23.02	\$23.80	\$25.92	\$25.92	\$25.92
11	\$8.26	\$9.09	\$11.30	\$15.63	\$22.94	\$24.63	\$25.65	\$27.44	\$27.44	\$27.44
12	\$8.27	\$9.60	\$11.90	\$16.51	\$24.66	\$26.25	\$27.17	\$28.46	\$28.46	\$28.46
13	\$8.62	\$10.10	\$12.34	\$17.53	\$26.25	\$27.52	\$28.72	\$29.42	\$29.42	\$29.42
14	\$9.04	\$10.62	\$13.11	\$18.55	\$27.52	\$28.96	\$30.06	\$30.57	\$30.57	\$30.57
15	\$9.36	\$10.91	\$13.80	\$19.23	\$28.96	\$30.24	\$31.41	\$31.93	\$31.93	\$31.93
16	\$9.60	\$11.26	\$14.36	\$19.87	\$30.24	\$31.79	\$32.78	\$33.28	\$33.28	\$33.28
17	\$9.92	\$11.58	\$14.97	\$20.82	\$31.62	\$33.48	\$34.30	\$34.88	\$34.88	\$34.88
18	\$10.24	\$11.97	\$15.56	\$21.56	\$33.39	\$34.95	\$36.33	\$36.87	\$36.87	\$36.87
19	\$10.62	\$12.32	\$16.01	\$22.42	\$34.62	\$36.80	\$38.00	\$38.62	\$38.62	\$38.62
20	\$11.00	\$12.85	\$16.62	\$23.49	\$35.85	\$38.35	\$39.33	\$39.95	\$39.95	\$39.95
21	\$11.52	\$13.35	\$17.24	\$24.25	\$37.16	\$39.66	\$41.15	\$41.78	\$41.78	\$41.78
22	\$11.89	\$13.96	\$17.73	\$24.93	\$38.33	\$41.19	\$42.70	\$43.39	\$43.39	\$43.39
23	\$12.19	\$14.29	\$18.36	\$25.65	\$39.66	\$42.54	\$44.30	\$44.98	\$44.98	\$44.98
24	\$12.45	\$14.85	\$18.89	\$26.61	\$41.15	\$44.22	\$45.85	\$46.59	\$46.59	\$46.59
25	\$12.85	\$15.27	\$19.32	\$27.56	\$42.49	\$45.81	\$47.44	\$48.20	\$48.20	\$48.20
26	\$13.22	\$15.65	\$20.02	\$28.46	\$43.92	\$47.33	\$48.69	\$49.49	\$49.49	\$49.49
27	\$13.67	\$16.15	\$20.54	\$29.46	\$45.42	\$48.69	\$50.26	\$51.10	\$51.10	\$51.10
28	\$14.08	\$16.73	\$20.96	\$30.17	\$46.57	\$50.17	\$51.50	\$52.71	\$52.71	\$52.71
29	\$14.50	\$16.98	\$21.65	\$30.88	\$47.89	\$51.48	\$53.00	\$54.05	\$54.05	\$54.05
30	\$14.75	\$17.45	\$22.38	\$31.85	\$49.13	\$52.86	\$54.38	\$55.73	\$55.73	\$55.73
31	\$15.18	\$18.03	\$22.99	\$32.59	\$50.26	\$54.02	\$55.78	\$57.12	\$57.12	\$57.12
32	\$15.40	\$18.42	\$23.67	\$33.37	\$51.71	\$55.47	\$57.17	\$58.96	\$58.96	\$58.96
33	\$15.86	\$18.86	\$24.27	\$34.06	\$53.11	\$56.80	\$58.57	\$60.57	\$60.57	\$60.57
34	\$16.33	\$19.23	\$24.80	\$35.30	\$54.75	\$58.17	\$60.04	\$62.13	\$62.13	\$62.13
35	\$16.71	\$19.81	\$25.35	\$35.98	\$56.35	\$59.65	\$61.51	\$63.79	\$63.79	\$63.79
36	\$16.90	\$20.27	\$25.83	\$36.73	\$57.89	\$61.51	\$63.08	\$65.26	\$65.26	\$65.26
37	\$17.20	\$20.57	\$26.49	\$37.65	\$59.46	\$63.16	\$64.75	\$66.96	\$66.96	\$66.96
38	\$17.53	\$20.90	\$27.15	\$38.43	\$60.99	\$64.82	\$66.52	\$68.48	\$68.48	\$68.48
39	\$18.08	\$21.41	\$27.59	\$39.19	\$62.34	\$66.52	\$68.27	\$70.13	\$70.13	\$70.13
40	\$18.55	\$21.97	\$28.23	\$40.08	\$63.81	\$67.91	\$69.80	\$71.46	\$71.46	\$71.46
41	\$19.04	\$22.48	\$28.59	\$40.84	\$65.17	\$69.16	\$71.66	\$73.06	\$73.06	\$73.06
42	\$19.32	\$23.06	\$29.16	\$41.66	\$66.53	\$70.54	\$73.44	\$74.79	\$74.79	\$74.79
43	\$19.75	\$23.56	\$29.58	\$42.33	\$67.65	\$71.78	\$74.92	\$76.12	\$76.12	\$76.12
44	\$20.10	\$23.84	\$30.26	\$43.11	\$69.01	\$73.19	\$76.44	\$77.65	\$77.65	\$77.65
45	\$20.54	\$24.42	\$30.70	\$43.73	\$70.37	\$74.57	\$77.58	\$78.80	\$78.80	\$78.80
46	\$20.80	\$24.66	\$31.34	\$44.40	\$71.72	\$75.80	\$79.47	\$80.69	\$80.69	\$80.69
47	\$21.24	\$25.17	\$31.88	\$45.00	\$73.06	\$76.05	\$80.96	\$82.25	\$82.25	\$82.25
48	\$21.65	\$25.79	\$32.44	\$45.69	\$74.52	\$78.75	\$82.26	\$83.63	\$83.63	\$83.63
49	\$22.04	\$26.37	\$32.99	\$46.46	\$75.60	\$79.75	\$82.97	\$85.20	\$85.20	\$85.20
50	\$22.41	\$26.72	\$33.53	\$47.25	\$76.95	\$80.05	\$83.05	\$86.57	\$86.57	\$86.57
51	\$22.72	\$26.99	\$34.06	\$47.95	\$78.50	\$82.83	\$86.17	\$88.07	\$88.07	\$88.07
52	\$22.99	\$27.43	\$34.69	\$49.07	\$79.68	\$84.60	\$87.88	\$89.63	\$89.63	\$89.63
53	\$23.42	\$27.97	\$35.15	\$49.82	\$80.96	\$86.23	\$89.31	\$90.73	\$90.73	\$90.73

54	\$23.74	\$28.42	\$35.70	\$50.56	\$82.04	\$87.97	\$90.65	\$92.05	\$92.05	\$92.05
55	\$24.22	\$28.90	\$36.14	\$51.50	\$83.52	\$89.60	\$92.01	\$93.46	\$93.46	\$93.46
56	\$24.56	\$29.29	\$36.67	\$52.31	\$84.62	\$91.00	\$93.63	\$95.12	\$95.12	\$95.12
57	\$24.90	\$29.77	\$37.25	\$53.05	\$85.93	\$92.52	\$95.40	\$96.87	\$96.87	\$96.87
58	\$25.35	\$30.26	\$37.97	\$53.95	\$87.49	\$94.15	\$96.83	\$98.35	\$98.35	\$98.35
59	\$25.65	\$30.62	\$38.68	\$54.90	\$88.90	\$95.69	\$98.37	\$99.94	\$99.94	\$99.94
60	\$25.90	\$30.90	\$39.28	\$55.66	\$90.04	\$97.28	\$99.62	\$101.19	\$101.19	\$101.19
61	\$26.37	\$31.34	\$39.78	\$56.37	\$91.38	\$98.40	\$101.26	\$102.83	\$102.83	\$102.83
62	\$26.85	\$31.90	\$40.27	\$57.28	\$92.69	\$100.06	\$102.98	\$104.62	\$104.62	\$104.62
63	\$27.31	\$32.44	\$40.79	\$58.11	\$94.04	\$101.73	\$104.95	\$106.61	\$106.61	\$106.61
64	\$27.78	\$32.96	\$41.25	\$58.87	\$95.40	\$103.38	\$106.36	\$108.04	\$108.04	\$108.04
65	\$28.17	\$33.43	\$41.86	\$59.74	\$96.83	\$105.07	\$108.26	\$110.01	\$110.01	\$110.01
66	\$28.58	\$33.72	\$42.46	\$60.71	\$98.37	\$106.43	\$110.09	\$114.46	\$114.46	\$114.46
67	\$28.78	\$34.39	\$43.11	\$61.71	\$99.62	\$107.98	\$111.73	\$113.48	\$113.48	\$113.48
68	\$29.15	\$34.69	\$43.73	\$62.75	\$101.26	\$109.42	\$113.14	\$114.92	\$114.92	\$114.92
69	\$29.60	\$35.15	\$44.34	\$63.92	\$102.61	\$110.91	\$115.06	\$116.88	\$116.88	\$116.88
70	\$30.07	\$35.72	\$45.00	\$65.00	\$104.19	\$112.27	\$116.36	\$118.21	\$118.21	\$118.21
71	\$30.44	\$36.21	\$45.59	\$65.90	\$105.75	\$113.57	\$117.93	\$119.81	\$119.81	\$119.81
72	\$30.86	\$36.85	\$46.20	\$66.90	\$107.32	\$115.22	\$119.64	\$121.51	\$121.51	\$121.51
73	\$31.13	\$37.19	\$46.82	\$68.05	\$108.69	\$116.78	\$121.02	\$122.92	\$122.92	\$122.92
74	\$31.57	\$37.61	\$47.46	\$68.91	\$110.36	\$118.57	\$122.88	\$124.84	\$124.84	\$124.84
75	\$32.00	\$38.23	\$48.03	\$69.86	\$111.41	\$120.18	\$124.47	\$126.48	\$126.48	\$126.48
76	\$32.33	\$38.70	\$48.62	\$70.67	\$111.41	\$121.90	\$125.84	\$127.80	\$127.80	\$127.80
77	\$32.92	\$39.21	\$49.21	\$71.59	\$114.09	\$123.33	\$127.42	\$129.41	\$129.41	\$129.41
78	\$33.22	\$39.52	\$49.91	\$72.60	\$115.77	\$124.91	\$127.42	\$130.42	\$130.42	\$130.42
79	\$33.60	\$40.00	\$50.61	\$73.64	\$117.23	\$126.31	\$130.57	\$132.58	\$132.58	\$132.58
80	\$34.13	\$40.47	\$51.31	\$74.58	\$118.41	\$127.89	\$132.13	\$134.24	\$134.24	\$134.24
81	\$34.43	\$40.92	\$51.90	\$74.75	\$119.64	\$129.30	\$132.48	\$135.62	\$135.62	\$135.62
82	\$34.81	\$41.44	\$52.46	\$76.53	\$121.02	\$131.07	\$135.30	\$137.42	\$137.42	\$137.42
83	\$35.07	\$41.91	\$53.12	\$77.14	\$122.44	\$132.80	\$136.86	\$139.02	\$139.02	\$139.02
84	\$35.52	\$42.46	\$53.60	\$77.83	\$123.80	\$134.47	\$138.20	\$140.38	\$140.38	\$140.38
85	\$35.96	\$43.05	\$54.14	\$79.10	\$125.16	\$135.75	\$139.74	\$141.92	\$141.92	\$141.92
86	\$36.45	\$43.11	\$54.80	\$80.04	\$126.40	\$137.12	\$141.40	\$143.59	\$143.59	\$143.59
87	\$36.73	\$43.91	\$55.39	\$80.95	\$127.84	\$138.37	\$142.75	\$144.96	\$144.96	\$144.96
88	\$37.05	\$44.46	\$56.08	\$81.68	\$129.20	\$140.01	\$144.32	\$146.60	\$146.60	\$146.60
89	\$37.44	\$44.75	\$56.61	\$82.45	\$130.57	\$141.61	\$146.12	\$148.38	\$148.38	\$148.38
90	\$38.07	\$45.19	\$57.17	\$83.29	\$132.13	\$142.96	\$147.70	\$150.03	\$150.03	\$150.03
91	\$38.63	\$45.79	\$57.28	\$84.26	\$133.49	\$144.78	\$149.28	\$151.63	\$151.63	\$151.63
92	\$39.07	\$46.23	\$58.34	\$84.26	\$134.87	\$146.36	\$150.83	\$153.19	\$153.19	\$153.19
93	\$39.38	\$46.29	\$59.01	\$84.26	\$136.33	\$147.70	\$152.30	\$154.65	\$154.65	\$154.65
94	\$39.71	\$46.29	\$59.09	\$84.26	\$137.69	\$149.13	\$152.51	\$156.41	\$156.41	\$156.41
95	\$40.08	\$46.29	\$59.34	\$84.26	\$139.12	\$150.63	\$155.26	\$157.72	\$157.72	\$157.72
96	\$40.35	\$46.29	\$59.34	\$84.26	\$140.25	\$152.30	\$156.94	\$159.40	\$159.40	\$159.40
97	\$40.35	\$46.29	\$59.34	\$84.26	\$141.61	\$153.54	\$158.43	\$160.91	\$160.91	\$160.91
98	\$40.35	\$46.29	\$59.34	\$84.26	\$142.96	\$154.29	\$158.66	\$162.27	\$162.27	\$162.27
99	\$40.35	\$46.29	\$59.34	\$84.26	\$143.60	\$154.29	\$158.77	\$162.59	\$162.59	\$162.59
100	\$40.35	\$46.29	\$59.34	\$84.26	\$143.60	\$154.29	\$160.22	\$162.59	\$162.59	\$162.59
101	\$40.76	\$46.75	\$59.93	\$85.11	\$145.04	\$155.83	\$161.82	\$164.22	\$164.22	\$164.22
102	\$41.16	\$47.21	\$60.53	\$85.95	\$146.48	\$157.37	\$163.42	\$165.85	\$165.85	\$165.85
103	\$41.56	\$47.67	\$61.12	\$86.79	\$147.91	\$158.91	\$165.03	\$167.47	\$167.47	\$167.47
104	\$41.97	\$48.14	\$61.71	\$87.63	\$149.35	\$160.46	\$166.63	\$169.10	\$169.10	\$169.10
105	\$42.37	\$48.60	\$62.31	\$88.48	\$150.78	\$162.00	\$168.23	\$170.72	\$170.72	\$170.72
106	\$42.77	\$49.06	\$62.90	\$89.32	\$152.22	\$163.54	\$169.83	\$172.35	\$172.35	\$172.35
107	\$43.18	\$49.53	\$63.49	\$90.16	\$153.66	\$165.09	\$171.44	\$173.97	\$173.97	\$173.97
108	\$43.58	\$49.99	\$64.09	\$91.00	\$155.09	\$166.63	\$173.04	\$175.60	\$175.60	\$175.60
109	\$43.98	\$50.45	\$64.68	\$91.85	\$156.53	\$168.17	\$174.64	\$177.23	\$177.23	\$177.23
110	\$44.39	\$50.91	\$65.27	\$92.69	\$157.96	\$169.71	\$176.24	\$178.85	\$178.85	\$178.85
111	\$44.79	\$51.38	\$65.87	\$93.53	\$159.40	\$171.26	\$177.84	\$180.48	\$180.48	\$180.48
112	\$45.19	\$51.84	\$66.46	\$94.38	\$160.84	\$172.80	\$179.45	\$182.10	\$182.10	\$182.10
113	\$45.60	\$52.30	\$67.05	\$95.22	\$162.27	\$174.34	\$181.05	\$183.73	\$183.73	\$183.73
114	\$46.00	\$52.77	\$67.65	\$96.06	\$163.71	\$175.89	\$182.65	\$185.36	\$185.36	\$185.36
115	\$46.40	\$53.23	\$68.24	\$96.90	\$165.14	\$177.43	\$184.25	\$186.98	\$186.98	\$186.98
116	\$46.81	\$53.69	\$68.84	\$97.75	\$166.58	\$178.97	\$185.85	\$188.61	\$188.61	\$188.61
117	\$47.21	\$54.15	\$69.43	\$98.59	\$168.02	\$180.51	\$187.46	\$190.23	\$190.23	\$190.23
118	\$47.61	\$54.62	\$70.02	\$99.43	\$169.45	\$182.06	\$189.06	\$191.86	\$191.86	\$191.86
119	\$48.02	\$55.08	\$70.62	\$100.27	\$170.89	\$183.60	\$190.66	\$193.49	\$193.49	\$193.49

120	\$48.42	\$55.54	\$71.21	\$101.12	\$172.33	\$185.14	\$192.26	\$195.11	\$195.11	\$195.11
121	\$48.83	\$56.01	\$71.80	\$101.96	\$173.76	\$186.69	\$193.87	\$196.74	\$196.74	\$196.74
122	\$49.23	\$56.47	\$72.40	\$102.80	\$175.20	\$188.23	\$195.47	\$198.36	\$198.36	\$198.36
123	\$49.63	\$56.93	\$72.99	\$103.64	\$176.63	\$189.77	\$197.07	\$199.99	\$199.99	\$199.99
124	\$50.04	\$57.39	\$73.58	\$104.49	\$178.07	\$191.31	\$198.67	\$201.62	\$201.62	\$201.62
125	\$50.44	\$57.86	\$74.18	\$105.33	\$179.51	\$192.86	\$200.27	\$203.24	\$203.24	\$203.24
126	\$50.84	\$58.32	\$74.77	\$106.17	\$180.94	\$194.40	\$201.88	\$204.87	\$204.87	\$204.87
127	\$51.25	\$58.78	\$75.36	\$107.01	\$182.38	\$195.94	\$203.48	\$206.49	\$206.49	\$206.49
128	\$51.65	\$59.25	\$75.96	\$107.86	\$183.81	\$197.49	\$205.08	\$208.12	\$208.12	\$208.12
129	\$52.05	\$59.71	\$76.55	\$108.70	\$185.25	\$199.03	\$206.68	\$209.75	\$209.75	\$209.75
130	\$52.46	\$60.17	\$77.14	\$109.54	\$186.69	\$200.57	\$208.29	\$211.37	\$211.37	\$211.37
131	\$52.86	\$60.63	\$77.74	\$110.39	\$188.12	\$202.11	\$209.89	\$213.00	\$213.00	\$213.00
132	\$53.26	\$61.10	\$78.33	\$111.23	\$189.56	\$203.66	\$211.49	\$214.62	\$214.62	\$214.62
133	\$53.67	\$61.56	\$78.92	\$112.07	\$190.99	\$205.20	\$213.09	\$216.25	\$216.25	\$216.25
134	\$54.07	\$62.02	\$79.52	\$112.91	\$192.43	\$206.74	\$214.69	\$217.88	\$217.88	\$217.88
135	\$54.47	\$62.49	\$80.11	\$113.76	\$193.87	\$208.29	\$216.30	\$219.50	\$219.50	\$219.50
136	\$54.88	\$62.95	\$80.70	\$114.60	\$195.30	\$209.83	\$217.90	\$221.13	\$221.13	\$221.13
137	\$55.28	\$63.41	\$81.30	\$115.44	\$196.74	\$211.37	\$219.50	\$222.75	\$222.75	\$222.75
138	\$55.69	\$63.87	\$81.89	\$116.28	\$198.17	\$212.91	\$221.10	\$224.38	\$224.38	\$224.38
139	\$56.09	\$64.34	\$82.48	\$117.13	\$199.61	\$214.46	\$222.71	\$226.00	\$226.00	\$226.00
140	\$56.49	\$64.80	\$83.08	\$117.97	\$201.05	\$216.00	\$224.31	\$227.63	\$227.63	\$227.63
141	\$56.90	\$65.26	\$83.67	\$118.81	\$202.48	\$217.54	\$225.91	\$229.26	\$229.26	\$229.26
142	\$57.30	\$65.73	\$84.26	\$119.65	\$203.92	\$219.09	\$227.51	\$230.88	\$230.88	\$230.88
143	\$57.70	\$66.19	\$84.86	\$120.50	\$205.35	\$220.63	\$229.11	\$232.51	\$232.51	\$232.51
144	\$58.11	\$66.65	\$85.45	\$121.34	\$206.79	\$222.17	\$230.72	\$234.13	\$234.13	\$234.13
145	\$58.51	\$67.11	\$86.04	\$122.18	\$208.23	\$223.71	\$232.32	\$235.76	\$235.76	\$235.76
146	\$58.91	\$67.58	\$86.64	\$123.03	\$209.66	\$225.26	\$233.92	\$237.39	\$237.39	\$237.39
147	\$59.32	\$68.04	\$87.23	\$123.87	\$211.10	\$226.80	\$235.52	\$239.01	\$239.01	\$239.01
148	\$59.72	\$68.50	\$87.82	\$124.71	\$212.53	\$228.34	\$237.13	\$240.64	\$240.64	\$240.64
149	\$60.12	\$68.97	\$88.42	\$125.55	\$213.97	\$229.89	\$238.73	\$242.26	\$242.26	\$242.26
150	\$60.53	\$69.43	\$89.01	\$126.40	\$215.41	\$231.43	\$240.33	\$243.89	\$243.89	\$243.89
Price/Lb.	\$0.40	\$0.46	\$0.59	\$0.84	\$1.43	\$1.53	\$1.59	\$1.62	\$1.62	\$1.62

Any fraction of a pound more than the weight shown in the rate chart is rounded up to the next listed weight.

*UPS offers customized rate sheets identifying its firm offer of rates and prices for transportation rates and prices. The rates and prices identified in the rate sheets will be guaranteed for 12-month periods and increase only with approval by the Lead State. Other fees and charges that may impact an authorized user's invoice are identified in UPS's Rate and Service Guide and as described in UPS's Tariff/Terms and Conditions of Service, in effect at the time of shipping. These fees and charges are subject to change without notice. In accordance with the conditions of the solicitation, UPS has waived all pick-up charges, including on-call/on-demand, and capped fuel surcharges at 7%. Fuel surcharge information is posted on UPS's website, www.ups.com.

NASPO ValuePoint**UPS 3 Day Select®****Daily Commercial Rates***

Lbs.	Zone 302	Zone 303	Zone 304	Zone 305	Zone 306	Zone 307	Zone 308
1	\$6.27	\$6.27	\$6.27	\$6.41	\$6.76	\$7.14	\$7.92
2	\$6.27	\$6.27	\$6.27	\$6.62	\$7.74	\$8.36	\$9.20
3	\$6.27	\$6.27	\$6.37	\$7.23	\$8.88	\$9.35	\$10.43
4	\$6.27	\$6.27	\$6.62	\$8.43	\$9.84	\$10.63	\$11.93
5	\$6.27	\$6.33	\$6.98	\$9.33	\$11.17	\$11.75	\$13.38
6	\$6.33	\$6.62	\$7.61	\$10.19	\$12.44	\$13.08	\$15.10
7	\$6.62	\$6.76	\$8.24	\$11.16	\$13.83	\$14.75	\$16.59
8	\$6.62	\$7.38	\$8.81	\$12.11	\$15.14	\$16.16	\$18.22
9	\$6.62	\$7.73	\$9.51	\$13.01	\$16.48	\$17.71	\$19.82
10	\$6.97	\$8.18	\$10.23	\$13.91	\$17.42	\$19.01	\$21.43
11	\$7.26	\$8.62	\$10.71	\$14.86	\$18.56	\$20.39	\$22.81
12	\$7.69	\$9.13	\$11.31	\$15.67	\$19.81	\$21.72	\$24.18
13	\$8.18	\$9.60	\$11.74	\$16.66	\$20.94	\$22.85	\$25.54
14	\$8.57	\$10.08	\$12.45	\$17.65	\$21.99	\$24.07	\$26.82
15	\$8.88	\$10.37	\$13.08	\$18.27	\$23.20	\$25.09	\$28.04
16	\$9.13	\$10.68	\$13.64	\$18.87	\$24.14	\$26.32	\$29.27
17	\$9.41	\$11.04	\$14.24	\$19.76	\$25.05	\$27.66	\$30.80
18	\$9.74	\$11.37	\$14.79	\$20.47	\$25.88	\$28.97	\$32.42
19	\$10.08	\$11.68	\$15.21	\$21.32	\$26.79	\$30.24	\$33.60
20	\$10.47	\$12.21	\$15.78	\$22.30	\$27.77	\$31.44	\$34.95
21	\$10.97	\$12.71	\$16.39	\$23.02	\$28.51	\$32.61	\$36.10
22	\$11.29	\$13.27	\$16.84	\$23.69	\$29.58	\$33.72	\$37.42
23	\$11.57	\$13.58	\$17.43	\$24.40	\$30.51	\$34.82	\$38.69
24	\$11.84	\$14.09	\$17.99	\$25.28	\$31.65	\$35.97	\$40.01
25	\$12.21	\$14.53	\$18.36	\$26.16	\$32.61	\$37.27	\$41.25
26	\$12.56	\$14.89	\$19.01	\$27.02	\$33.69	\$38.46	\$42.48
27	\$12.97	\$15.35	\$19.52	\$28.00	\$34.92	\$39.83	\$43.85
28	\$13.36	\$15.89	\$19.93	\$28.66	\$36.07	\$41.09	\$45.18
29	\$13.74	\$16.13	\$20.56	\$29.33	\$37.08	\$42.23	\$46.63
30	\$14.02	\$16.58	\$21.26	\$30.26	\$38.29	\$43.37	\$47.96
31	\$14.38	\$17.10	\$21.84	\$30.95	\$39.47	\$44.65	\$49.32
32	\$14.63	\$17.49	\$22.47	\$31.70	\$40.45	\$45.88	\$50.70
33	\$15.03	\$17.91	\$23.05	\$32.34	\$41.57	\$47.03	\$51.99
34	\$15.52	\$18.27	\$23.56	\$33.53	\$42.71	\$48.23	\$53.56
35	\$15.88	\$18.82	\$24.08	\$34.19	\$43.69	\$49.40	\$54.82
36	\$16.06	\$19.26	\$24.52	\$34.90	\$44.81	\$50.44	\$56.11
37	\$16.37	\$19.55	\$25.15	\$35.79	\$45.74	\$51.45	\$57.36
38	\$16.66	\$19.83	\$25.80	\$36.51	\$46.69	\$52.41	\$58.46
39	\$17.15	\$20.34	\$26.20	\$37.22	\$47.76	\$53.43	\$59.61
40	\$17.65	\$20.89	\$26.80	\$38.08	\$48.84	\$54.45	\$60.67
41	\$18.09	\$21.35	\$27.17	\$38.77	\$49.63	\$55.58	\$61.99
42	\$18.36	\$21.92	\$27.71	\$39.58	\$50.74	\$56.74	\$63.30
43	\$18.75	\$22.37	\$28.12	\$40.24	\$51.69	\$57.99	\$64.74
44	\$19.10	\$22.66	\$28.73	\$40.95	\$52.77	\$59.22	\$66.14
45	\$19.52	\$23.19	\$29.15	\$41.54	\$53.76	\$60.46	\$67.48
46	\$19.75	\$23.45	\$29.75	\$42.19	\$54.82	\$61.64	\$69.05
47	\$20.18	\$23.90	\$30.29	\$42.76	\$56.11	\$62.90	\$70.54
48	\$20.56	\$24.48	\$30.82	\$43.38	\$57.45	\$64.09	\$71.92
49	\$20.95	\$25.07	\$31.36	\$44.13	\$58.78	\$65.48	\$73.38
50	\$21.29	\$25.39	\$31.85	\$44.86	\$59.92	\$66.79	\$74.73
51	\$21.61	\$25.64	\$32.34	\$45.51	\$60.98	\$68.11	\$75.87

52	\$21.84	\$26.05	\$32.97	\$46.62	\$61.88	\$69.38	\$77.07
53	\$22.26	\$26.57	\$33.43	\$47.32	\$62.97	\$70.69	\$78.54
54	\$22.54	\$27.00	\$33.91	\$48.03	\$63.93	\$71.99	\$79.86
55	\$22.99	\$27.44	\$34.35	\$48.91	\$64.91	\$73.35	\$81.33
56	\$23.33	\$27.83	\$34.84	\$49.70	\$65.82	\$74.73	\$82.85
57	\$23.64	\$28.27	\$35.40	\$50.43	\$66.94	\$76.02	\$84.31
58	\$24.08	\$28.73	\$36.04	\$51.26	\$68.05	\$77.46	\$85.59
59	\$24.40	\$29.08	\$36.73	\$52.17	\$69.20	\$78.83	\$87.24
60	\$24.58	\$29.36	\$37.31	\$52.90	\$70.43	\$80.04	\$88.80
61	\$25.07	\$29.75	\$37.80	\$53.56	\$71.62	\$81.36	\$90.25
62	\$25.49	\$30.31	\$38.24	\$54.43	\$72.85	\$82.73	\$91.78
63	\$25.94	\$30.82	\$38.74	\$55.19	\$74.01	\$84.05	\$93.21
64	\$26.39	\$31.31	\$39.20	\$55.92	\$75.33	\$85.44	\$94.73
65	\$26.76	\$31.74	\$39.75	\$56.75	\$76.53	\$86.78	\$96.08
66	\$27.13	\$32.01	\$40.34	\$57.66	\$77.62	\$88.07	\$97.65
67	\$27.36	\$32.65	\$40.95	\$58.59	\$78.85	\$89.43	\$99.19
68	\$27.69	\$32.97	\$41.54	\$59.63	\$79.92	\$90.76	\$100.70
69	\$28.14	\$33.43	\$42.11	\$60.69	\$81.05	\$92.06	\$102.22
70	\$28.58	\$33.92	\$42.76	\$61.77	\$82.19	\$93.30	\$103.73
71	\$28.95	\$34.41	\$43.28	\$62.59	\$83.12	\$94.46	\$105.09
72	\$29.29	\$35.02	\$43.89	\$63.57	\$84.31	\$95.75	\$106.52
73	\$29.56	\$35.34	\$44.49	\$64.62	\$85.44	\$97.12	\$107.95
74	\$30.00	\$35.75	\$45.10	\$65.46	\$86.54	\$98.35	\$109.34
75	\$30.39	\$36.35	\$45.64	\$66.37	\$87.63	\$99.48	\$110.85
76	\$30.73	\$36.76	\$46.18	\$67.13	\$88.75	\$100.62	\$112.06
77	\$31.27	\$37.24	\$46.74	\$68.00	\$89.90	\$101.83	\$113.51
78	\$31.55	\$37.52	\$47.43	\$68.97	\$90.91	\$103.15	\$114.94
79	\$31.91	\$38.03	\$48.05	\$69.95	\$92.05	\$104.49	\$116.20
80	\$32.44	\$38.46	\$48.73	\$70.84	\$93.21	\$105.65	\$117.66
81	\$32.73	\$38.89	\$49.31	\$71.00	\$94.34	\$106.91	\$118.89
82	\$33.08	\$39.37	\$49.83	\$72.68	\$95.43	\$108.32	\$120.43
83	\$33.30	\$39.83	\$50.49	\$73.31	\$96.55	\$109.42	\$121.89
84	\$33.75	\$40.34	\$50.91	\$73.95	\$97.71	\$110.78	\$123.07
85	\$34.16	\$40.87	\$51.44	\$75.15	\$98.75	\$111.80	\$124.52
86	\$34.61	\$40.95	\$52.05	\$76.05	\$99.93	\$112.94	\$125.96
87	\$34.90	\$41.72	\$52.64	\$76.91	\$101.03	\$114.05	\$127.10
88	\$35.14	\$42.23	\$53.30	\$77.58	\$101.92	\$115.32	\$128.57
89	\$35.58	\$42.49	\$53.77	\$78.32	\$103.07	\$116.66	\$129.97
90	\$36.14	\$42.94	\$54.33	\$78.33	\$104.21	\$117.92	\$131.40
91	\$36.68	\$43.47	\$54.43	\$78.33	\$105.34	\$119.22	\$132.88
92	\$37.15	\$43.91	\$55.42	\$78.33	\$106.36	\$120.51	\$134.34
93	\$37.42	\$44.54	\$56.07	\$78.33	\$107.42	\$121.68	\$135.55
94	\$37.74	\$44.61	\$56.12	\$78.33	\$108.58	\$122.87	\$137.08
95	\$38.08	\$44.67	\$57.20	\$78.33	\$109.66	\$124.20	\$138.28
96	\$38.33	\$45.45	\$57.71	\$78.33	\$110.75	\$125.37	\$139.74
97	\$38.74	\$45.50	\$58.26	\$78.33	\$112.04	\$126.55	\$141.14
98	\$39.07	\$45.59	\$58.60	\$78.33	\$112.75	\$127.65	\$142.32
99	\$39.40	\$45.64	\$58.84	\$78.33	\$112.75	\$128.86	\$143.49
100	\$40.35	\$52.22	\$64.09	\$78.33	\$112.75	\$130.55	\$145.98
101	\$40.76	\$52.74	\$64.73	\$79.11	\$113.87	\$131.85	\$147.44
102	\$41.16	\$53.26	\$65.37	\$79.90	\$115.00	\$133.16	\$148.90
103	\$41.56	\$53.79	\$66.01	\$80.68	\$116.13	\$134.47	\$150.36
104	\$41.97	\$54.31	\$66.65	\$81.46	\$117.26	\$135.77	\$151.82
105	\$42.37	\$54.83	\$67.29	\$82.25	\$118.38	\$137.08	\$153.28
106	\$42.77	\$55.35	\$67.93	\$83.03	\$119.51	\$138.38	\$154.74
107	\$43.18	\$55.88	\$68.57	\$83.81	\$120.64	\$139.69	\$156.20
108	\$43.58	\$56.40	\$69.21	\$84.60	\$121.77	\$140.99	\$157.66
109	\$43.98	\$56.92	\$69.86	\$85.38	\$122.89	\$142.30	\$159.12
110	\$44.39	\$57.44	\$70.50	\$86.16	\$124.02	\$143.60	\$160.58
111	\$44.79	\$57.96	\$71.14	\$86.95	\$125.15	\$144.91	\$162.04
112	\$45.19	\$58.49	\$71.78	\$87.73	\$126.28	\$146.22	\$163.50
113	\$45.60	\$59.01	\$72.42	\$88.51	\$127.40	\$147.52	\$164.96
114	\$46.00	\$59.53	\$73.06	\$89.30	\$128.53	\$148.83	\$166.41
115	\$46.40	\$60.05	\$73.70	\$90.08	\$129.66	\$150.13	\$167.87

116	\$46.81	\$60.57	\$74.34	\$90.86	\$130.79	\$151.44	\$169.33
117	\$47.21	\$61.10	\$74.98	\$91.65	\$131.91	\$152.74	\$170.79
118	\$47.61	\$61.62	\$75.62	\$92.43	\$133.04	\$154.05	\$172.25
119	\$48.02	\$62.14	\$76.26	\$93.21	\$134.17	\$155.35	\$173.71
120	\$48.42	\$62.66	\$76.91	\$94.00	\$135.30	\$156.66	\$175.17
121	\$48.83	\$63.19	\$77.55	\$94.78	\$136.42	\$157.96	\$176.63
122	\$49.23	\$63.71	\$78.19	\$95.56	\$137.55	\$159.27	\$178.09
123	\$49.63	\$64.23	\$78.83	\$96.35	\$138.68	\$160.58	\$179.55
124	\$50.04	\$64.75	\$79.47	\$97.13	\$139.81	\$161.88	\$181.01
125	\$50.44	\$65.27	\$80.11	\$97.91	\$140.93	\$163.19	\$182.47
126	\$50.84	\$65.80	\$80.75	\$98.70	\$142.06	\$164.49	\$183.93
127	\$51.25	\$66.32	\$81.39	\$99.48	\$143.19	\$165.80	\$185.39
128	\$51.65	\$66.84	\$82.03	\$100.26	\$144.32	\$167.10	\$186.85
129	\$52.05	\$67.36	\$82.67	\$101.05	\$145.44	\$168.41	\$188.31
130	\$52.46	\$67.89	\$83.31	\$101.83	\$146.57	\$169.71	\$189.77
131	\$52.86	\$68.41	\$83.96	\$102.61	\$147.70	\$171.02	\$191.23
132	\$53.26	\$68.93	\$84.60	\$103.40	\$148.83	\$172.33	\$192.69
133	\$53.67	\$69.45	\$85.24	\$104.18	\$149.95	\$173.63	\$194.15
134	\$54.07	\$69.97	\$85.88	\$104.96	\$151.08	\$174.94	\$195.61
135	\$54.47	\$70.50	\$86.52	\$105.75	\$152.21	\$176.24	\$197.07
136	\$54.88	\$71.02	\$87.16	\$106.53	\$153.34	\$177.55	\$198.53
137	\$55.28	\$71.54	\$87.80	\$107.31	\$154.46	\$178.85	\$199.99
138	\$55.69	\$72.06	\$88.44	\$108.09	\$155.59	\$180.16	\$201.45
139	\$56.09	\$72.59	\$89.08	\$108.88	\$156.72	\$181.46	\$202.91
140	\$56.49	\$73.11	\$89.72	\$109.66	\$157.85	\$182.77	\$204.37
141	\$56.90	\$73.63	\$90.36	\$110.44	\$158.97	\$184.07	\$205.83
142	\$57.30	\$74.15	\$91.00	\$111.23	\$160.10	\$185.38	\$207.29
143	\$57.70	\$74.67	\$91.65	\$112.01	\$161.23	\$186.69	\$208.75
144	\$58.11	\$75.20	\$92.29	\$112.79	\$162.36	\$187.99	\$210.21
145	\$58.51	\$75.72	\$92.93	\$113.58	\$163.48	\$189.30	\$211.67
146	\$58.91	\$76.24	\$93.57	\$114.36	\$164.61	\$190.60	\$213.13
147	\$59.32	\$76.76	\$94.21	\$115.14	\$165.74	\$191.91	\$214.59
148	\$59.72	\$77.29	\$94.85	\$115.93	\$166.87	\$193.21	\$216.05
149	\$60.12	\$77.81	\$95.49	\$116.71	\$167.99	\$194.52	\$217.51
150	\$60.53	\$78.33	\$96.13	\$117.49	\$169.12	\$195.82	\$218.97
Price/Lb.	\$0.40	\$0.52	\$0.64	\$0.78	\$1.12	\$1.30	\$1.45

Any fraction of a pound more than the weight shown in the rate chart is rounded up to the next listed weight.

*UPS offers customized rate sheets identifying its firm offer of rates and prices for transportation rates and prices. The rates and prices identified in the rate sheets will be guaranteed for 12-month periods and increase only with approval by the Lead State. Other fees and charges that may impact an authorized user's invoice are identified in UPS's Rate and Service Guide and as described in UPS's Tariff/Terms and Conditions of Service, in effect at the time of shipping. These fees and charges are subject to change without notice. In accordance with the conditions of the solicitation, UPS has waived all pick-up charges, including on-call/on-demand, and capped fuel surcharges at 7%. Fuel surcharge information is posted on UPS's website, www.ups.com.

NASPO ValuePoint**UPS® Ground****Daily Commercial Rates***

								AK, HI	PR	AK, HI +
Lbs.	Zone 2	Zone 3	Zone 4	Zone 5	Zone 6	Zone 7	Zone 8	Zone 44	Zone 45	Zone 46
1	\$5.27	\$5.29	\$5.76	\$6.02	\$6.23	\$6.30	\$6.40	\$19.02	\$19.56	\$25.06
2	\$6.08	\$6.09	\$6.59	\$6.73	\$7.02	\$7.29	\$7.41	\$21.16	\$21.90	\$27.19
3	\$6.41	\$6.42	\$6.94	\$7.23	\$7.53	\$7.78	\$8.16	\$22.99	\$24.95	\$28.95
4	\$6.45	\$6.46	\$7.16	\$7.63	\$7.84	\$8.35	\$8.74	\$25.25	\$26.59	\$31.41
5	\$6.75	\$6.76	\$7.41	\$7.97	\$8.31	\$8.73	\$9.32	\$27.37	\$28.87	\$33.41
6	\$6.83	\$6.84	\$7.48	\$8.08	\$8.38	\$8.83	\$9.36	\$29.54	\$30.72	\$34.69
7	\$7.00	\$7.01	\$7.68	\$8.34	\$8.54	\$9.07	\$9.71	\$31.54	\$33.11	\$36.47
8	\$7.06	\$7.26	\$7.96	\$8.58	\$8.88	\$9.44	\$10.14	\$32.58	\$34.83	\$38.25
9	\$7.12	\$7.36	\$8.06	\$8.65	\$9.07	\$9.83	\$10.68	\$34.88	\$37.25	\$40.53
10	\$7.18	\$7.44	\$8.14	\$8.89	\$9.17	\$10.30	\$11.38	\$37.06	\$40.44	\$42.71
11	\$7.28	\$7.58	\$8.30	\$8.93	\$9.47	\$11.14	\$12.11	\$38.96	\$42.81	\$44.63
12	\$7.40	\$7.90	\$8.39	\$9.05	\$9.80	\$11.59	\$12.68	\$40.63	\$44.38	\$46.28
13	\$7.44	\$7.94	\$8.48	\$9.23	\$10.11	\$12.41	\$13.38	\$42.31	\$45.99	\$47.94
14	\$7.71	\$8.15	\$8.57	\$9.46	\$10.69	\$13.18	\$14.39	\$44.06	\$47.78	\$49.67
15	\$7.71	\$8.33	\$8.69	\$9.79	\$11.29	\$13.60	\$15.14	\$45.69	\$49.95	\$51.26
16	\$7.91	\$8.57	\$8.85	\$9.96	\$11.65	\$14.30	\$15.71	\$47.73	\$52.04	\$53.30
17	\$7.97	\$8.74	\$8.95	\$10.24	\$12.14	\$15.03	\$16.04	\$49.76	\$54.53	\$54.99
18	\$8.05	\$8.87	\$9.04	\$10.73	\$12.78	\$15.48	\$17.14	\$51.82	\$57.77	\$57.03
19	\$8.25	\$9.27	\$9.50	\$11.20	\$13.11	\$15.91	\$17.73	\$53.86	\$59.63	\$59.06
20	\$8.31	\$9.35	\$9.55	\$11.64	\$13.56	\$16.49	\$18.55	\$55.66	\$61.81	\$60.83
21	\$8.61	\$9.71	\$10.05	\$11.77	\$14.11	\$17.12	\$19.12	\$56.94	\$64.64	\$62.10
22	\$8.64	\$9.81	\$10.33	\$12.21	\$14.68	\$17.75	\$19.95	\$58.72	\$67.10	\$63.88
23	\$8.67	\$10.00	\$10.66	\$12.56	\$15.39	\$18.34	\$20.74	\$60.50	\$69.56	\$65.65
24	\$8.90	\$10.40	\$11.11	\$13.08	\$15.97	\$18.78	\$21.93	\$62.48	\$72.10	\$67.63
25	\$9.01	\$10.52	\$11.24	\$13.33	\$16.27	\$19.60	\$22.36	\$64.42	\$74.61	\$69.58
26	\$9.44	\$10.88	\$11.71	\$13.88	\$16.86	\$20.41	\$23.28	\$66.45	\$76.53	\$71.76
27	\$9.67	\$11.14	\$11.83	\$14.11	\$17.52	\$20.78	\$23.67	\$68.29	\$79.05	\$73.64
28	\$9.93	\$11.40	\$12.49	\$15.02	\$18.39	\$21.71	\$24.81	\$70.13	\$81.62	\$75.49
29	\$9.96	\$11.62	\$12.72	\$15.08	\$18.92	\$22.41	\$25.23	\$71.84	\$83.64	\$77.00
30	\$10.15	\$11.90	\$13.21	\$15.67	\$19.20	\$22.52	\$26.29	\$73.56	\$86.27	\$78.75
31	\$10.50	\$12.19	\$13.38	\$15.75	\$19.62	\$23.17	\$27.18	\$73.58	\$88.41	\$78.80
32	\$10.51	\$12.19	\$13.38	\$15.76	\$19.81	\$23.19	\$27.73	\$74.19	\$91.23	\$79.35
33	\$10.57	\$12.38	\$13.98	\$16.50	\$20.85	\$23.95	\$28.21	\$75.74	\$93.64	\$80.93
34	\$10.64	\$12.65	\$14.43	\$17.08	\$21.10	\$24.67	\$29.57	\$77.43	\$96.15	\$82.59
35	\$10.83	\$13.32	\$14.76	\$17.49	\$21.41	\$25.31	\$30.06	\$79.35	\$98.72	\$84.50
36	\$11.00	\$13.33	\$15.02	\$18.09	\$22.31	\$26.17	\$30.94	\$81.05	\$101.06	\$86.37
37	\$11.15	\$13.50	\$15.32	\$18.49	\$22.41	\$27.01	\$31.25	\$82.90	\$103.62	\$88.26
38	\$11.33	\$13.71	\$15.66	\$18.93	\$22.92	\$27.37	\$31.83	\$84.89	\$106.04	\$90.25
39	\$11.71	\$14.25	\$16.17	\$19.34	\$23.74	\$28.19	\$32.48	\$86.72	\$108.53	\$91.93
40	\$11.72	\$14.31	\$16.22	\$19.37	\$23.99	\$28.19	\$32.71	\$88.58	\$110.73	\$93.74
41	\$11.87	\$14.78	\$16.66	\$20.03	\$24.76	\$29.07	\$33.72	\$90.09	\$113.12	\$95.44
42	\$11.94	\$14.97	\$17.30	\$20.10	\$25.11	\$29.55	\$33.89	\$91.79	\$115.69	\$97.13
43	\$12.21	\$15.18	\$17.33	\$21.12	\$26.22	\$30.62	\$34.81	\$93.66	\$117.92	\$99.01
44	\$12.39	\$15.42	\$17.77	\$21.49	\$26.44	\$31.28	\$35.18	\$95.01	\$120.20	\$100.91
45	\$12.40	\$15.42	\$17.77	\$21.50	\$26.63	\$32.20	\$35.43	\$96.84	\$121.99	\$102.76
46	\$12.67	\$15.58	\$18.34	\$22.11	\$27.33	\$32.54	\$36.36	\$98.70	\$124.94	\$104.64
47	\$12.72	\$15.78	\$18.64	\$22.27	\$27.70	\$33.18	\$36.95	\$100.60	\$127.32	\$106.53
48	\$12.73	\$15.81	\$18.81	\$22.87	\$28.11	\$33.48	\$37.53	\$102.32	\$129.50	\$108.28
49	\$12.74	\$15.84	\$18.87	\$22.87	\$28.32	\$34.07	\$37.75	\$104.07	\$131.92	\$110.06
50	\$12.74	\$15.87	\$18.87	\$22.90	\$28.33	\$34.15	\$37.96	\$105.82	\$131.97	\$111.82
51	\$12.78	\$15.90	\$18.92	\$22.94	\$28.36	\$34.19	\$38.40	\$107.57	\$136.42	\$114.63
52	\$12.78	\$15.93	\$18.93	\$22.95	\$28.37	\$34.20	\$38.41	\$107.79	\$136.71	\$114.84
53	\$12.79	\$15.96	\$18.93	\$22.98	\$28.37	\$34.21	\$38.78	\$109.41	\$138.74	\$116.48

54	\$12.79	\$15.99	\$18.97	\$23.12	\$28.38	\$34.21	\$38.81	\$110.96	\$140.46	\$118.24
55	\$12.80	\$16.01	\$18.98	\$23.24	\$28.41	\$34.22	\$38.84	\$112.45	\$144.70	\$120.02
56	\$12.81	\$16.04	\$19.00	\$23.24	\$28.41	\$34.25	\$39.28	\$113.97	\$145.13	\$121.76
57	\$13.03	\$16.09	\$19.05	\$23.94	\$28.44	\$34.28	\$39.68	\$115.54	\$147.76	\$123.65
58	\$13.04	\$16.10	\$19.07	\$23.97	\$28.45	\$34.30	\$40.39	\$117.06	\$150.23	\$125.40
59	\$13.15	\$16.11	\$19.31	\$23.97	\$28.87	\$34.33	\$40.68	\$118.84	\$152.26	\$127.26
60	\$13.41	\$16.73	\$19.63	\$24.81	\$29.14	\$34.49	\$40.94	\$120.69	\$154.13	\$129.14
61	\$13.42	\$16.78	\$19.66	\$24.88	\$29.40	\$34.69	\$41.19	\$122.18	\$156.89	\$130.68
62	\$13.97	\$17.97	\$20.15	\$25.59	\$29.59	\$35.22	\$41.45	\$124.19	\$160.16	\$132.72
63	\$13.97	\$17.98	\$20.35	\$25.60	\$29.79	\$35.29	\$41.70	\$126.22	\$162.77	\$134.81
64	\$14.35	\$18.16	\$20.68	\$25.63	\$30.28	\$35.52	\$42.34	\$128.32	\$164.84	\$136.97
65	\$14.50	\$18.64	\$20.69	\$25.66	\$30.54	\$35.60	\$42.41	\$130.42	\$167.70	\$139.14
66	\$14.71	\$18.65	\$20.69	\$25.67	\$30.56	\$35.71	\$42.59	\$132.43	\$170.58	\$141.20
67	\$14.71	\$18.68	\$20.72	\$25.70	\$30.80	\$35.89	\$42.62	\$134.44	\$171.18	\$143.29
68	\$14.88	\$19.18	\$21.94	\$26.23	\$30.97	\$36.10	\$42.65	\$136.38	\$175.69	\$145.26
69	\$15.04	\$19.18	\$21.95	\$26.44	\$31.14	\$36.13	\$42.82	\$138.37	\$178.21	\$147.30
70	\$15.12	\$19.45	\$22.42	\$27.43	\$31.76	\$36.15	\$43.19	\$141.27	\$180.36	\$149.11
71	\$15.15	\$19.49	\$22.82	\$27.48	\$32.32	\$37.10	\$43.28	\$143.72	\$180.87	\$152.05
72	\$15.59	\$19.49	\$23.30	\$27.48	\$32.55	\$38.32	\$43.58	\$145.86	\$181.29	\$154.23
73	\$15.68	\$19.69	\$23.30	\$27.89	\$32.60	\$38.33	\$43.66	\$148.00	\$183.20	\$156.41
74	\$16.25	\$19.69	\$23.31	\$27.90	\$33.41	\$38.75	\$43.75	\$149.42	\$192.32	\$156.91
75	\$17.02	\$19.89	\$23.31	\$28.38	\$33.72	\$39.14	\$43.77	\$151.11	\$192.88	\$158.03
76	\$18.16	\$20.99	\$23.46	\$28.82	\$34.15	\$39.78	\$43.80	\$152.98	\$192.96	\$159.92
77	\$18.87	\$21.30	\$23.95	\$28.95	\$34.35	\$40.54	\$43.82	\$154.24	\$193.58	\$160.85
78	\$18.89	\$22.10	\$24.66	\$29.26	\$34.56	\$41.22	\$43.85	\$155.07	\$194.21	\$162.02
79	\$19.92	\$22.81	\$25.04	\$29.72	\$35.28	\$41.86	\$44.50	\$155.10	\$199.62	\$162.47
80	\$20.28	\$23.46	\$25.39	\$30.43	\$35.88	\$42.04	\$44.84	\$156.71	\$201.60	\$163.31
81	\$20.77	\$23.65	\$26.00	\$30.63	\$36.34	\$42.68	\$45.41	\$158.02	\$201.88	\$164.14
82	\$21.44	\$24.41	\$27.09	\$31.21	\$36.43	\$43.78	\$45.41	\$158.81	\$204.42	\$164.90
83	\$21.66	\$24.46	\$27.18	\$31.42	\$36.88	\$43.80	\$45.42	\$160.55	\$206.66	\$165.53
84	\$22.51	\$25.26	\$27.97	\$31.72	\$37.44	\$44.32	\$45.77	\$162.40	\$209.03	\$167.39
85	\$22.90	\$25.43	\$27.99	\$32.23	\$38.02	\$44.80	\$46.27	\$164.29	\$211.46	\$169.27
86	\$23.97	\$26.59	\$29.09	\$32.84	\$38.47	\$45.63	\$47.24	\$166.02	\$213.69	\$171.01
87	\$24.23	\$26.61	\$29.09	\$32.85	\$38.98	\$45.67	\$47.31	\$167.88	\$216.09	\$172.86
88	\$25.47	\$27.46	\$30.29	\$33.90	\$39.49	\$46.15	\$48.29	\$169.74	\$218.47	\$174.73
89	\$26.36	\$27.97	\$30.60	\$34.01	\$39.97	\$46.62	\$49.29	\$171.51	\$220.74	\$176.50
90	\$27.71	\$29.18	\$31.62	\$35.01	\$40.54	\$47.26	\$49.80	\$173.28	\$222.99	\$178.94
91	\$27.72	\$29.18	\$31.62	\$35.07	\$40.63	\$47.27	\$49.80	\$175.13	\$224.23	\$180.08
92	\$28.60	\$29.45	\$31.79	\$35.07	\$41.11	\$47.27	\$49.91	\$176.80	\$226.20	\$181.76
93	\$28.97	\$30.02	\$32.71	\$35.40	\$41.48	\$47.28	\$50.43	\$178.51	\$226.27	\$183.49
94	\$29.12	\$30.52	\$32.86	\$35.86	\$41.96	\$47.28	\$50.95	\$180.18	\$231.92	\$185.17
95	\$29.80	\$31.08	\$33.08	\$36.35	\$42.25	\$47.45	\$51.50	\$181.95	\$233.96	\$186.94
96	\$30.75	\$31.29	\$34.29	\$37.10	\$42.49	\$47.78	\$52.48	\$183.62	\$235.06	\$188.58
97	\$31.46	\$32.21	\$34.79	\$37.29	\$42.95	\$48.13	\$53.03	\$185.37	\$235.25	\$190.33
98	\$31.88	\$32.41	\$34.80	\$37.73	\$43.43	\$48.14	\$53.05	\$186.99	\$235.39	\$191.99
99	\$32.58	\$32.93	\$36.11	\$38.20	\$43.94	\$48.62	\$53.57	\$188.77	\$235.56	\$193.74
100	\$32.86	\$33.19	\$36.14	\$38.82	\$44.47	\$49.11	\$54.10	\$190.52	\$245.19	\$195.50
101	\$33.14	\$33.48	\$36.17	\$38.82	\$44.48	\$49.12	\$54.13	\$190.55	\$247.44	\$195.52
102	\$33.17	\$33.50	\$36.31	\$38.98	\$44.59	\$49.12	\$54.16	\$190.58	\$249.73	\$195.58
103	\$33.97	\$34.31	\$36.87	\$39.21	\$45.04	\$49.61	\$54.39	\$191.44	\$251.97	\$195.61
104	\$34.17	\$34.48	\$37.06	\$39.62	\$45.18	\$49.76	\$54.71	\$191.92	\$254.36	\$196.29
105	\$35.06	\$35.35	\$37.83	\$40.44	\$45.88	\$50.53	\$55.72	\$194.09	\$256.62	\$198.00
106	\$35.30	\$35.52	\$37.90	\$40.45	\$45.89	\$50.56	\$55.72	\$195.89	\$258.98	\$199.79
107	\$35.82	\$36.07	\$38.72	\$41.25	\$46.30	\$50.93	\$56.69	\$197.70	\$261.39	\$201.60
108	\$36.33	\$36.58	\$38.78	\$41.27	\$46.72	\$51.38	\$56.70	\$198.86	\$263.76	\$203.21
109	\$36.72	\$37.09	\$39.20	\$41.67	\$47.13	\$51.82	\$57.19	\$200.61	\$266.03	\$204.96
110	\$37.67	\$37.99	\$40.03	\$42.07	\$47.99	\$52.80	\$58.25	\$202.90	\$268.27	\$206.77
111	\$37.72	\$38.04	\$40.88	\$42.89	\$48.02	\$53.16	\$58.94	\$205.21	\$271.33	\$209.59
112	\$38.50	\$38.84	\$40.92	\$42.89	\$48.40	\$53.17	\$58.95	\$207.53	\$274.39	\$212.44
113	\$38.53	\$38.87	\$41.37	\$43.29	\$48.84	\$53.61	\$60.02	\$209.32	\$276.77	\$214.23
114	\$38.94	\$39.68	\$42.13	\$44.13	\$49.66	\$54.51	\$60.42	\$211.15	\$279.17	\$216.06
115	\$39.37	\$40.13	\$42.13	\$44.25	\$49.67	\$54.51	\$60.42	\$212.95	\$281.56	\$217.87
116	\$39.78	\$40.26	\$43.06	\$44.45	\$49.99	\$55.72	\$60.79	\$214.27	\$283.31	\$219.60
117	\$40.17	\$40.70	\$43.17	\$45.27	\$50.40	\$55.75	\$61.77	\$215.47	\$285.57	\$221.30
118	\$40.60	\$41.52	\$43.21	\$45.41	\$50.81	\$55.78	\$62.32	\$217.69	\$287.82	\$223.02

119	\$41.16	\$41.57	\$44.07	\$45.66	\$51.25	\$56.16	\$63.07	\$220.83	\$292.00	\$227.32
120	\$42.14	\$42.57	\$44.45	\$46.41	\$51.66	\$56.90	\$63.34	\$222.11	\$294.39	\$229.15
121	\$42.17	\$42.59	\$44.56	\$46.41	\$51.99	\$56.91	\$63.42	\$224.14	\$296.35	\$231.10
122	\$42.55	\$43.39	\$45.00	\$46.83	\$52.40	\$57.82	\$63.95	\$226.04	\$298.87	\$233.01
123	\$43.00	\$43.44	\$46.35	\$47.66	\$52.81	\$58.51	\$64.90	\$227.96	\$301.41	\$234.94
124	\$43.32	\$43.87	\$46.40	\$47.69	\$53.24	\$58.52	\$65.27	\$229.86	\$303.93	\$236.87
125	\$43.44	\$43.87	\$46.41	\$48.07	\$53.65	\$58.68	\$65.42	\$231.78	\$306.45	\$238.81
126	\$44.29	\$44.74	\$47.77	\$48.39	\$53.97	\$59.43	\$66.94	\$232.66	\$308.35	\$240.72
127	\$44.64	\$45.06	\$47.78	\$48.80	\$54.37	\$59.44	\$66.95	\$235.12	\$310.87	\$242.64
128	\$44.64	\$45.07	\$48.24	\$49.23	\$55.20	\$60.51	\$67.95	\$236.46	\$313.41	\$244.56
129	\$45.62	\$46.08	\$48.60	\$49.53	\$55.21	\$60.51	\$67.95	\$238.36	\$315.92	\$246.51
130	\$45.64	\$46.10	\$49.05	\$49.91	\$55.61	\$61.31	\$69.52	\$242.58	\$318.44	\$250.81
131	\$45.91	\$46.38	\$49.77	\$50.37	\$55.91	\$61.32	\$69.53	\$243.44	\$321.86	\$252.79
132	\$46.80	\$47.28	\$49.78	\$50.78	\$56.33	\$61.47	\$69.70	\$244.76	\$324.41	\$254.74
133	\$46.88	\$47.35	\$49.99	\$51.19	\$56.60	\$61.75	\$69.77	\$249.18	\$326.93	\$258.66
134	\$47.24	\$47.72	\$50.48	\$51.50	\$57.03	\$62.17	\$69.85	\$249.80	\$329.47	\$258.70
135	\$48.17	\$48.66	\$51.05	\$52.05	\$58.08	\$63.24	\$70.84	\$250.48	\$331.98	\$260.56
136	\$48.48	\$49.24	\$51.85	\$52.37	\$58.11	\$63.27	\$70.87	\$252.38	\$334.51	\$262.50
137	\$48.84	\$49.24	\$52.72	\$53.26	\$58.29	\$63.49	\$71.34	\$254.31	\$337.06	\$264.47
138	\$49.28	\$50.02	\$53.38	\$53.69	\$59.46	\$64.62	\$72.63	\$256.21	\$339.57	\$266.43
139	\$49.73	\$50.52	\$53.39	\$53.70	\$59.50	\$64.63	\$72.63	\$258.12	\$342.11	\$268.35
140	\$50.18	\$50.67	\$53.59	\$54.13	\$59.81	\$64.90	\$73.20	\$259.92	\$344.48	\$270.20
141	\$50.62	\$51.00	\$54.01	\$54.56	\$60.13	\$65.23	\$73.21	\$261.84	\$346.21	\$272.04
142	\$51.26	\$51.94	\$54.41	\$55.30	\$60.58	\$66.13	\$74.01	\$263.06	\$348.66	\$273.92
143	\$51.27	\$51.95	\$54.89	\$55.44	\$61.04	\$66.13	\$74.19	\$264.84	\$351.00	\$275.74
144	\$52.22	\$53.43	\$55.92	\$56.48	\$61.50	\$67.04	\$74.99	\$266.66	\$353.41	\$277.60
145	\$52.39	\$53.96	\$56.11	\$56.68	\$62.42	\$67.74	\$75.66	\$269.19	\$355.91	\$279.55
146	\$52.40	\$53.99	\$56.48	\$56.92	\$62.43	\$67.92	\$75.69	\$270.46	\$358.45	\$281.51
147	\$53.12	\$54.02	\$56.94	\$57.22	\$62.87	\$67.95	\$76.01	\$272.35	\$360.95	\$283.44
148	\$53.77	\$54.38	\$57.11	\$57.68	\$63.95	\$68.38	\$77.61	\$277.57	\$363.50	\$288.14
149	\$53.88	\$54.86	\$57.40	\$57.99	\$63.96	\$68.65	\$77.64	\$278.16	\$367.76	\$290.11
150	\$53.89	\$55.37	\$59.07	\$60.06	\$64.28	\$69.30	\$78.07	\$280.09	\$370.31	\$294.86
Price/Lb.	\$0.36	\$0.37	\$0.39	\$0.40	\$0.43	\$0.46	\$0.52	\$1.85	\$2.45	\$1.95

Any fraction of a pound more than the weight shown in the rate chart is rounded up to the next listed weight.

*UPS offers customized rate sheets identifying its firm offer of rates and prices for transportation rates and prices. The rates and prices identified in the rate sheets will be guaranteed for 12-month periods and increase only with approval by the Lead State. Other fees and charges that may impact an authorized user's invoice are identified in UPS's Rate and Service Guide and as described in UPS's Tariff/Terms and Conditions of Service, in effect at the time of shipping. These fees and charges are subject to change without notice. In accordance with the conditions of the solicitation, UPS has waived all pick-up charges, including on-call/on-demand, and capped fuel surcharges at 7%. Fuel surcharge information is posted on UPS's website, www.ups.com.

NASPO ValuePoint

UPS Hundredweight Service®

UPS Next Day Air® - Daily Rates per Pound - 2021

ORIGIN 48 STATES

Tier	Minimum Weight per Pkg (lbs)	Weight	Zone 102	Zone 103	Zone 104	Zone 105	Zone 106	Zone 107	Zone 108	Zone 124	Zone 125	Zone 126
01	20	100 to 499lbs.	1.24	1.73	2.61	2.98	3.12	3.65	3.77	4.02	3.46	4.34
		500 to 999lbs.	1.24	1.73	2.61	2.98	3.12	3.65	3.77	4.02	3.46	4.34
		1000lbs. or more	1.24	1.73	2.61	2.98	3.12	3.65	3.77	4.02	3.46	4.34
02	20	100 to 499lbs.	1.31	1.79	2.78	3.13	3.26	3.79	3.93	4.22	3.61	4.54
		500 to 999lbs.	1.31	1.79	2.78	3.13	3.26	3.79	3.93	4.22	3.61	4.54
		1000lbs. or more	1.31	1.79	2.78	3.13	3.26	3.79	3.93	4.22	3.61	4.54
03	18	100 to 499lbs.	1.34	1.85	2.99	3.35	3.51	4.06	4.20	4.50	3.85	4.88
		500 to 999lbs.	1.34	1.85	2.99	3.35	3.51	4.06	4.20	4.50	3.85	4.88
		1000lbs. or more	1.34	1.85	2.99	3.35	3.51	4.06	4.20	4.50	3.85	4.88
04	18	100 to 499lbs.	1.37	1.89	3.16	3.56	3.72	4.37	4.50	4.78	3.99	5.16
		500 to 999lbs.	1.37	1.89	3.16	3.56	3.72	4.37	4.50	4.78	3.99	5.16
		1000lbs. or more	1.37	1.89	3.16	3.56	3.72	4.37	4.50	4.78	3.99	5.16
05	18	100 to 499lbs.	1.41	1.93	3.32	3.74	3.93	4.59	4.74	5.14	4.15	5.54
		500 to 999lbs.	1.41	1.93	3.32	3.74	3.93	4.59	4.74	5.14	4.15	5.54
		1000lbs. or more	1.41	1.93	3.32	3.74	3.93	4.59	4.74	5.14	4.15	5.54
06	18	100 to 499lbs.	1.43	1.99	3.52	3.93	4.05	4.82	5.06	5.60	4.35	5.73
		500 to 999lbs.	1.43	1.99	3.52	3.93	4.05	4.82	5.06	5.60	4.35	5.73
		1000lbs. or more	1.43	1.99	3.52	3.93	4.05	4.82	5.06	5.60	4.35	5.73
07	18	100 to 499lbs.	1.46	2.05	3.67	4.08	4.16	4.99	5.21	5.98	4.47	6.10
		500 to 999lbs.	1.46	2.05	3.67	4.08	4.16	4.99	5.21	5.98	4.47	6.10
		1000lbs. or more	1.46	2.05	3.67	4.08	4.16	4.99	5.21	5.98	4.47	6.10

Shipment minimum 100 pounds.

UPS Hundredweight Service®**UPS Next Day Air Saver® - Daily Rates per Pound - 2021**

ORIGIN 48 STATES

Tier	Minimum Weight per Pkg (lbs)	Weight	Zone 132	Zone 133	Zone 134	Zone 135	Zone 136	Zone 137	Zone 138
01	20	100 to 499lbs.	1.06	1.60	2.55	2.86	2.91	3.50	3.63
		500 to 999lbs.	1.06	1.60	2.55	2.86	2.91	3.50	3.63
		1000lbs. or more	1.06	1.60	2.55	2.86	2.91	3.50	3.63
02	20	100 to 499lbs.	1.15	1.65	2.73	3.02	3.09	3.66	3.85
		500 to 999lbs.	1.15	1.65	2.73	3.02	3.09	3.66	3.85
		1000lbs. or more	1.15	1.65	2.73	3.02	3.09	3.66	3.85
03	18	100 to 499lbs.	1.20	1.72	2.83	3.21	3.32	3.95	4.13
		500 to 999lbs.	1.20	1.72	2.83	3.21	3.32	3.95	4.13
		1000lbs. or more	1.20	1.72	2.83	3.21	3.32	3.95	4.13
04	18	100 to 499lbs.	1.25	1.76	3.04	3.45	3.53	4.12	4.32
		500 to 999lbs.	1.25	1.76	3.04	3.45	3.53	4.12	4.32
		1000lbs. or more	1.25	1.76	3.04	3.45	3.53	4.12	4.32
05	18	100 to 499lbs.	1.28	1.81	3.21	3.59	3.68	4.32	4.58
		500 to 999lbs.	1.28	1.81	3.21	3.59	3.68	4.32	4.58
		1000lbs. or more	1.28	1.81	3.21	3.59	3.68	4.32	4.58
06	18	100 to 499lbs.	1.31	1.92	3.36	3.76	3.94	4.65	4.85
		500 to 999lbs.	1.31	1.92	3.36	3.76	3.94	4.65	4.85
		1000lbs. or more	1.31	1.92	3.36	3.76	3.94	4.65	4.85
07	18	100 to 499lbs.	1.38	1.99	3.58	3.99	4.07	4.89	5.10
		500 to 999lbs.	1.38	1.99	3.58	3.99	4.07	4.89	5.10
		1000lbs. or more	1.38	1.99	3.58	3.99	4.07	4.89	5.10

Shipment minimum 100 pounds.

UPS Hundredweight Service®**UPS 2nd Day Air A.M.® - Daily Rates per Pound - 2021**

ORIGIN 48 STATES

Tier	Minimum Weight per Pkg (lbs)	Weight	Zone 242	Zone 243	Zone 244	Zone 245	Zone 246	Zone 247	Zone 248
01	20	100 to 499lbs.	0.75	0.91	1.19	1.66	2.68	3.16	3.35
		500 to 999lbs.	0.75	0.91	1.19	1.66	2.68	3.16	3.35
		1000lbs. or more	0.75	0.91	1.19	1.66	2.68	3.16	3.35
02	20	100 to 499lbs.	0.79	0.94	1.24	1.76	2.84	3.35	3.54
		500 to 999lbs.	0.79	0.94	1.24	1.76	2.84	3.35	3.54
		1000lbs. or more	0.79	0.94	1.24	1.76	2.84	3.35	3.54
03	18	100 to 499lbs.	0.84	1.00	1.32	1.88	3.11	3.55	3.74
		500 to 999lbs.	0.84	1.00	1.32	1.88	3.11	3.55	3.74
		1000lbs. or more	0.84	1.00	1.32	1.88	3.11	3.55	3.74
04	18	100 to 499lbs.	0.88	1.06	1.41	2.01	3.33	3.67	3.86
		500 to 999lbs.	0.88	1.06	1.41	2.01	3.33	3.67	3.86
		1000lbs. or more	0.88	1.06	1.41	2.01	3.33	3.67	3.86
05	18	100 to 499lbs.	0.93	1.14	1.49	2.12	3.53	3.89	4.04
		500 to 999lbs.	0.93	1.14	1.49	2.12	3.53	3.89	4.04
		1000lbs. or more	0.93	1.14	1.49	2.12	3.53	3.89	4.04
06	18	100 to 499lbs.	0.99	1.19	1.58	2.29	3.78	4.12	4.30
		500 to 999lbs.	0.99	1.19	1.58	2.29	3.78	4.12	4.30
		1000lbs. or more	0.99	1.19	1.58	2.29	3.78	4.12	4.30
07	18	100 to 499lbs.	1.06	1.28	1.66	2.46	4.00	4.30	4.51
		500 to 999lbs.	1.06	1.28	1.66	2.46	4.00	4.30	4.51
		1000lbs. or more	1.06	1.28	1.66	2.46	4.00	4.30	4.51

Shipment minimum 100 pounds.

UPS Hundredweight Service®**UPS 2nd Day Air® - Daily Rates per Pound - 2021**

ORIGIN 48 STATES

Tier	Minimum Weight per Pkg (lbs)	Weight	Zone 202	Zone 203	Zone 204	Zone 205	Zone 206	Zone 207	Zone 208	Zone 224	Zone 225	Zone 226
01	20	100 to 499lbs.	0.71	0.88	1.16	1.56	2.48	3.03	3.09	3.21	2.45	3.32
		500 to 999lbs.	0.71	0.88	1.16	1.56	2.48	3.03	3.09	3.21	2.45	3.32
		1000lbs. or more	0.71	0.88	1.16	1.56	2.48	3.03	3.09	3.21	2.45	3.32
02	20	100 to 499lbs.	0.75	0.91	1.21	1.63	2.66	3.15	3.26	3.36	2.57	3.51
		500 to 999lbs.	0.75	0.91	1.21	1.63	2.66	3.15	3.26	3.36	2.57	3.51
		1000lbs. or more	0.75	0.91	1.21	1.63	2.66	3.15	3.26	3.36	2.57	3.51
03	18	100 to 499lbs.	0.79	0.96	1.29	1.74	2.86	3.27	3.41	3.45	2.65	3.58
		500 to 999lbs.	0.79	0.96	1.29	1.74	2.86	3.27	3.41	3.45	2.65	3.58
		1000lbs. or more	0.79	0.96	1.29	1.74	2.86	3.27	3.41	3.45	2.65	3.58
04	18	100 to 499lbs.	0.83	1.02	1.34	1.82	3.01	3.38	3.51	3.55	2.77	3.68
		500 to 999lbs.	0.83	1.02	1.34	1.82	3.01	3.38	3.51	3.55	2.77	3.68
		1000lbs. or more	0.83	1.02	1.34	1.82	3.01	3.38	3.51	3.55	2.77	3.68
05	18	100 to 499lbs.	0.86	1.05	1.37	1.88	3.11	3.52	3.62	3.67	2.95	3.76
		500 to 999lbs.	0.86	1.05	1.37	1.88	3.11	3.52	3.62	3.67	2.95	3.76
		1000lbs. or more	0.86	1.05	1.37	1.88	3.11	3.52	3.62	3.67	2.95	3.76
06	18	100 to 499lbs.	0.89	1.11	1.42	1.98	3.21	3.61	3.77	3.82	3.10	3.90
		500 to 999lbs.	0.89	1.11	1.42	1.98	3.21	3.61	3.77	3.82	3.10	3.90
		1000lbs. or more	0.89	1.11	1.42	1.98	3.21	3.61	3.77	3.82	3.10	3.90
07	18	100 to 499lbs.	0.92	1.15	1.46	2.05	3.28	3.75	3.86	3.93	3.25	4.01
		500 to 999lbs.	0.92	1.15	1.46	2.05	3.28	3.75	3.86	3.93	3.25	4.01
		1000lbs. or more	0.92	1.15	1.46	2.05	3.28	3.75	3.86	3.93	3.25	4.01

Shipment minimum 100 pounds.

UPS Hundredweight Service®
UPS 3 Day Select® - Daily Rates per Hundredweight - 2021
 ORIGIN 48 STATES

Tier	Minimum Weight per Pkg (lbs)	Weight	Zone 302	Zone 303	Zone 304	Zone 305	Zone 306	Zone 307	Zone 308
01	25	100 to 499lbs.	31.26	37.79	42.58	50.96	76.07	113.94	129.56
		500 to 999lbs.	28.46	32.90	36.73	46.46	67.90	99.83	113.42
		1000lbs. or more	31.23	33.90	38.87	48.05	70.66	104.12	118.24
02	25	100 to 499lbs.	35.14	42.61	49.19	59.40	91.54	128.59	144.88
		500 to 999lbs.	30.40	35.90	43.73	53.69	81.78	112.83	127.18
		1000lbs. or more	33.17	38.58	45.78	54.55	85.25	117.38	132.26
03	20	100 to 499lbs.	38.55	48.78	54.28	64.87	100.86	138.00	156.41
		500 to 999lbs.	35.17	42.49	48.17	60.90	93.36	127.38	144.38
		1000lbs. or more	35.32	45.08	51.55	62.52	97.33	132.62	150.35
04	20	100 to 499lbs.	43.52	52.75	62.40	73.19	115.00	155.08	173.05
		500 to 999lbs.	40.58	47.02	55.99	67.87	106.33	145.35	161.93
		1000lbs. or more	41.67	49.02	60.90	70.92	110.83	149.29	168.58
05	15	100 to 499lbs.	48.05	56.99	68.34	80.78	128.44	168.81	187.63
		500 to 999lbs.	48.93	53.87	63.93	76.89	123.62	160.11	178.05
		1000lbs. or more	50.40	55.28	64.72	79.01	128.85	166.67	185.16
06	15	100 to 499lbs.	53.43	66.07	77.72	91.80	142.14	185.28	206.16
		500 to 999lbs.	53.02	64.46	76.98	91.63	139.00	181.16	201.57
		1000lbs. or more	54.61	67.07	81.28	96.92	144.85	187.69	208.83
07	15	100 to 499lbs.	62.40	79.25	94.13	112.62	163.08	195.28	210.78
		500 to 999lbs.	60.69	76.34	92.83	111.33	158.70	190.13	204.98
		1000lbs. or more	63.22	79.51	96.71	115.89	165.11	197.98	213.30
Minimums	Tier/Zone								
	1-5	Zone 302	Zone 303	Zone 304	Zone 305	Zone 306	Zone 307	Zone 308	
	6	63.00	63.00	63.00	63.00	63.00	63.00	63.00	63.00
	7	65.10	65.10	65.10	65.10	65.10	65.10	65.10	65.10

Shipment minimum 200 pounds.

UPS Hundredweight Service®
UPS® Ground - Daily Rates per Hundredweight - 2021
 ORIGIN 48 STATES

Tier	Minimum Weight per Pkg (lbs)	Weight	Zone 2	Zone 3	Zone 4	Zone 5	Zone 6	Zone 7	Zone 8	Zone 44	Zone 45	Zone 46
01	25	200 to 499lbs.	23.35	28.78	31.10	37.09	46.33	54.30	62.96	176.71	194.28	192.74
		500 to 999lbs.	20.24	25.00	27.04	32.29	40.20	46.90	54.39	151.50	166.54	164.73
		1000lbs. or more	20.64	25.61	27.70	33.09	41.13	48.05	55.73	154.85	170.21	168.71
02	25	200 to 499lbs.	25.12	30.72	33.00	39.29	48.89	57.26	67.71	190.60	209.47	209.03
		500 to 999lbs.	22.01	26.65	28.86	34.59	42.97	50.16	59.33	165.94	182.32	181.40
		1000lbs. or more	22.44	27.18	29.56	35.34	44.04	51.23	60.80	169.28	185.97	185.23
03	20	200 to 499lbs.	26.72	33.02	35.33	42.27	52.50	61.49	72.00	201.72	221.76	221.30
		500 to 999lbs.	23.66	29.09	31.32	37.43	46.38	54.33	63.53	176.69	194.24	193.18
		1000lbs. or more	24.24	29.67	32.08	38.36	47.52	55.67	65.11	180.29	198.22	197.61
04	20	200 to 499lbs.	28.23	34.77	37.06	44.26	55.28	65.13	76.30	215.91	237.38	234.71
		500 to 999lbs.	25.07	31.14	33.23	39.44	49.17	58.29	68.18	192.40	211.53	208.46
		1000lbs. or more	25.57	31.80	33.97	40.41	50.29	59.74	69.80	196.25	215.76	212.69
05	15	200 to 499lbs.	29.95	37.02	40.02	47.64	59.94	69.84	80.98	232.10	255.16	251.18
		500 to 999lbs.	27.43	33.38	36.26	43.16	54.01	63.14	73.06	210.83	231.77	227.42
		1000lbs. or more	27.98	34.05	37.14	44.23	55.29	64.67	74.77	215.04	236.40	232.26
06	15	200 to 499lbs.	31.92	39.15	42.68	50.92	63.33	75.09	85.57	246.83	271.61	266.17
		500 to 999lbs.	29.59	36.42	39.57	47.09	58.56	69.63	79.99	228.93	251.90	246.15
		1000lbs. or more	30.31	37.14	40.56	48.22	60.02	71.15	80.94	233.53	256.96	251.57
07	15	200 to 499lbs.	33.99	41.71	44.31	52.85	65.63	77.83	88.67	255.78	294.44	275.82
		500 to 999lbs.	31.83	39.20	41.56	49.62	61.57	72.74	83.02	237.84	273.77	255.55
		1000lbs. or more	32.56	40.17	42.58	50.85	62.90	74.32	84.99	242.59	279.25	260.98
Minimums	Tier/Zone											
	1-5	Zone 2	Zone 3	Zone 4	Zone 5	Zone 6	Zone 7	Zone 8	Zone 44	Zone 45	Zone 46	
	6	60.00	60.00	60.00	60.00	60.00	60.00	60.00	290.00	290.00	355.00	
	7	62.00	62.00	62.00	62.00	62.00	62.00	62.00	380.00	380.00	415.00	

Shipment minimum 200 pounds.

*UPS offers customized rate sheets identifying its firm offer of rates and prices for transportation rates and prices. The rates and prices identified in the rate sheets will be guaranteed for 12-month periods and increase only with approval by the Lead State. Other fees and charges that may impact an authorized user's invoice are identified in UPS's Rate and Service Guide and as described in UPS's Tariff/Terms and Conditions of Service, in effect at the time of shipping. These fees and charges are subject to change without notice. In accordance with the conditions of the solicitation, UPS has waived all pick-up charges, including on-call/on-demand, and capped fuel surcharges at 7%. Fuel surcharge information is posted on UPS's website, www.ups.com.

NASPO ValuePoint

UPS Worldwide Express® - Export

The rates shown are for shipments originating in the United States.

Letter/Pak/Document*

	Zones																
	81	82	84	901	902	903	904	905	906	907	908	909	911	912	913	920	921
Letter*	\$23.54	\$24.24	\$25.52	\$32.17	\$29.78	\$35.15	\$37.90	\$37.23	\$47.78	\$67.42	\$71.98	\$30.96	\$37.64	\$35.86	\$31.59	\$27.97	\$34.10
Pak 1 lb*	\$73.19	\$76.46	\$65.43	\$81.69	\$73.28	\$91.86	\$95.65	\$91.51	\$104.51	\$143.85	\$141.29	\$76.75	\$93.90	\$90.14	\$79.10	\$69.51	\$78.62
Pak 2 lbs*	\$80.35	\$84.23	\$68.70	\$86.34	\$81.40	\$94.35	\$104.14	\$97.59	\$140.21	\$170.68	\$168.64	\$83.82	\$109.32	\$99.00	\$87.49	\$78.83	\$105.32
1	\$83.67	\$91.19	\$84.27	\$102.44	\$97.41	\$121.64	\$110.77	\$106.30	\$131.43	\$163.82	\$170.96	\$94.41	\$115.13	\$109.41	\$98.29	\$92.53	\$99.52
2	\$92.03	\$100.58	\$95.04	\$116.36	\$105.08	\$143.51	\$135.32	\$123.32	\$158.07	\$186.60	\$188.61	\$107.33	\$130.43	\$125.70	\$113.09	\$98.37	\$120.97
3	\$103.17	\$109.83	\$105.71	\$135.18	\$115.16	\$159.99	\$155.43	\$143.07	\$184.91	\$224.91	\$214.49	\$126.95	\$145.48	\$141.58	\$129.61	\$109.40	\$130.14
4	\$113.84	\$120.89	\$118.82	\$157.07	\$129.35	\$181.90	\$180.41	\$163.07	\$217.83	\$262.56	\$254.93	\$147.60	\$159.93	\$159.71	\$150.90	\$122.88	\$146.82
5	\$127.20	\$145.65	\$135.42	\$183.27	\$145.89	\$197.12	\$203.45	\$193.82	\$239.63	\$291.39	\$286.07	\$179.07	\$194.00	\$193.88	\$189.89	\$138.59	\$164.12
6	\$131.41	\$152.54	\$151.94	\$194.72	\$158.41	\$212.99	\$222.67	\$204.11	\$270.73	\$308.74	\$304.30	\$189.59	\$212.99	\$211.90	\$199.33	\$150.50	\$191.12
7	\$134.15	\$156.23	\$161.83	\$205.93	\$169.61	\$233.50	\$242.37	\$222.17	\$300.74	\$332.03	\$339.51	\$201.11	\$231.82	\$234.32	\$210.11	\$162.69	\$212.14
8	\$138.08	\$158.48	\$170.06	\$214.96	\$179.42	\$249.88	\$261.04	\$247.43	\$358.01	\$348.06	\$363.52	\$210.86	\$255.55	\$247.65	\$216.34	\$172.10	\$232.15
9	\$139.07	\$161.89	\$171.35	\$215.87	\$180.34	\$255.14	\$265.49	\$251.31	\$363.69	\$354.26	\$377.46	\$211.86	\$263.12	\$249.93	\$218.92	\$174.65	\$259.14
10	\$140.02	\$162.89	\$174.54	\$217.23	\$183.31	\$257.58	\$274.38	\$252.28	\$364.91	\$355.75	\$384.92	\$213.12	\$264.36	\$250.78	\$219.92	\$177.53	\$272.09

Package

1	\$29.15	\$31.76	\$29.35	\$35.68	\$33.93	\$42.37	\$38.59	\$37.03	\$45.78	\$57.06	\$59.55	\$32.89	\$40.10	\$38.11	\$34.24	\$32.23	\$34.67
2	\$32.06	\$35.04	\$33.11	\$40.53	\$36.60	\$49.99	\$47.13	\$42.96	\$55.06	\$65.00	\$65.70	\$37.39	\$45.43	\$43.79	\$39.39	\$34.27	\$42.14
3	\$35.94	\$38.26	\$36.82	\$47.09	\$40.11	\$55.73	\$54.14	\$49.84	\$64.41	\$78.34	\$74.71	\$44.22	\$50.67	\$49.32	\$45.15	\$38.11	\$45.33
4	\$39.65	\$42.11	\$41.39	\$54.71	\$45.06	\$63.36	\$62.84	\$56.80	\$75.88	\$91.46	\$88.80	\$51.41	\$55.71	\$55.63	\$52.56	\$42.80	\$51.14
5	\$44.31	\$50.73	\$47.17	\$63.84	\$50.82	\$68.66	\$70.87	\$67.51	\$83.47	\$101.50	\$99.65	\$62.38	\$67.57	\$67.53	\$66.15	\$48.28	\$57.17
6	\$45.77	\$53.14	\$52.93	\$67.83	\$55.18	\$74.19	\$77.56	\$71.10	\$94.30	\$107.54	\$106.00	\$66.04	\$74.19	\$73.81	\$69.43	\$52.42	\$66.57
7	\$46.73	\$54.42	\$56.37	\$71.73	\$59.08	\$81.33	\$84.43	\$77.39	\$104.76	\$115.66	\$118.26	\$70.05	\$80.75	\$81.62	\$73.19	\$56.67	\$73.90
8	\$48.10	\$55.20	\$59.24	\$74.88	\$62.50	\$87.04	\$90.93	\$86.19	\$124.71	\$121.24	\$126.63	\$73.45	\$89.02	\$86.27	\$75.36	\$59.95	\$80.86
9	\$48.44	\$56.39	\$59.69	\$75.20	\$62.82	\$88.87	\$92.48	\$87.54	\$126.69	\$123.40	\$131.48	\$73.80	\$91.65	\$87.06	\$76.26	\$60.84	\$90.27
10	\$48.77	\$56.74	\$60.80	\$75.67	\$63.85	\$89.72	\$95.58	\$87.88	\$127.11	\$123.92	\$134.08	\$74.24	\$92.08	\$87.35	\$76.61	\$61.84	\$94.78
11	\$49.92	\$57.41	\$62.73	\$76.40	\$66.93	\$90.68	\$96.68	\$91.35	\$132.07	\$125.98	\$134.39	\$76.86	\$93.62	\$89.95	\$78.44	\$63.58	\$99.72
12	\$50.50	\$58.03	\$64.85	\$78.85	\$69.72	\$92.03	\$98.50	\$92.95	\$133.04	\$129.89	\$139.35	\$79.09	\$96.77	\$91.86	\$79.88	\$66.23	\$106.90
13	\$61.86	\$72.51	\$76.63	\$91.50	\$73.24	\$106.69	\$119.95	\$110.52	\$161.23	\$154.05	\$167.73	\$96.71	\$110.89	\$112.97	\$95.18	\$69.58	\$111.67
14	\$66.55	\$76.28	\$85.02	\$102.21	\$76.50	\$117.83	\$135.82	\$120.01	\$173.38	\$173.22	\$186.52	\$104.08	\$134.42	\$125.92	\$101.72	\$72.68	\$116.19
15	\$69.13	\$78.85	\$91.00	\$105.72	\$84.91	\$125.07	\$145.09	\$138.37	\$182.39	\$187.78	\$188.88	\$107.85	\$137.77	\$132.11	\$107.35	\$80.66	\$122.90
16	\$71.70	\$80.86	\$91.33	\$109.66	\$89.88	\$129.67	\$150.94	\$140.51	\$204.01	\$214.01	\$205.00	\$112.16	\$143.15	\$138.98	\$112.78	\$85.81	\$128.76
17	\$73.77	\$83.23	\$91.67	\$111.73	\$90.50	\$130.19	\$155.40	\$140.81	\$205.65	\$216.63	\$218.72	\$115.94	\$143.77	\$142.34	\$113.07	\$86.39	\$133.56
18	\$75.14	\$83.57	\$92.02	\$112.03	\$91.07	\$130.54	\$155.83	\$141.12	\$212.84	\$223.21	\$230.45	\$116.54	\$144.08	\$142.69	\$113.41	\$86.94	\$136.76
19	\$75.47	\$84.43	\$92.36	\$112.34	\$97.13	\$130.86	\$156.17	\$141.43	\$215.69	\$235.02	\$231.08	\$116.89	\$144.39	\$143.04	\$113.75	\$92.73	\$142.61
20	\$75.79	\$84.77	\$92.71	\$112.65	\$100.75	\$131.19	\$156.50	\$141.74	\$216.12	\$237.71	\$232.22	\$117.24	\$144.70	\$143.36	\$114.10	\$96.18	\$147.20
21	\$76.11	\$85.11	\$93.04	\$112.95	\$101.88	\$131.52	\$156.83	\$141.76	\$216.45	\$238.04	\$232.53	\$117.57	\$145.01	\$143.70	\$116.83	\$97.26	\$149.40
22	\$76.43	\$85.44	\$93.38	\$113.26	\$102.24	\$131.84	\$157.16	\$142.07	\$216.76	\$238.37	\$232.84	\$117.89	\$145.32	\$144.04	\$119.69	\$97.61	\$153.82
23	\$76.76	\$85.77	\$93.71	\$113.57	\$104.02	\$132.17	\$157.50	\$142.38	\$217.09	\$238.81	\$235.39	\$118.22	\$145.63	\$144.39	\$122.80	\$99.30	\$157.23
24	\$77.47	\$86.54	\$94.70	\$115.30	\$104.80	\$132.87	\$158.24	\$148.69	\$223.01	\$239.11	\$248.03	\$118.79	\$148.89	\$144.70	\$123.27	\$100.05	\$161.92
25	\$78.18	\$87.29	\$95.94	\$116.63	\$107.07	\$136.41	\$160.77	\$151.80	\$225.92	\$240.39	\$253.67	\$121.27	\$151.98	\$147.69	\$124.72	\$102.21	\$167.10
26	\$95.26	\$109.09	\$110.97	\$151.17	\$115.74	\$179.96	\$204.69	\$182.10	\$267.79	\$288.86	\$260.03	\$153.75	\$186.39	\$188.22	\$145.82	\$110.49	\$172.56
27	\$101.42	\$113.81	\$124.11	\$162.75	\$118.12	\$186.83	\$212.39	\$195.14	\$288.27	\$327.33	\$322.23	\$162.33	\$205.97	\$199.79	\$161.85	\$112.76	\$174.85
28	\$104.93	\$118.47	\$130.28	\$167.43	\$118.48	\$187.53	\$220.25	\$196.50	\$290.32	\$342.24	\$330.27	\$167.10	\$207.95	\$203.44	\$165.50	\$113.11	\$179.26
29	\$106.88	\$119.88	\$130.90	\$170.55	\$118.85	\$188.56	\$226.56	\$213.02	\$303.37	\$350.93	\$331.07	\$167.49	\$208.58	\$213.24	\$165.81	\$113.46	\$183.67
30	\$108.99	\$120.93	\$131.25	\$174.13	\$121.62	\$198.95	\$227.46	\$218.26	\$305.76	\$352.74	\$331.85	\$168.90	\$209.35	\$214.41	\$171.16	\$116.10	\$187.73
31	\$111.61	\$125.21	\$131.59	\$177.82	\$125.76	\$201.18	\$240.69	\$220.31	\$306.47	\$353.11	\$333.09	\$174.64	\$224.73	\$221.41	\$178.28	\$118.31	\$192.63
32	\$113.91	\$127.30	\$131.90	\$178.78	\$131.29	\$202.27	\$247.95	\$220.62	\$307.96	\$353.92	\$333.53	\$184.48	\$233.31	\$226.13	\$182.07	\$123.51	\$197.05
33	\$116.21	\$129.85	\$139.16	\$188.32	\$134.13	\$205.72	\$253.62	\$225.62	\$330.77	\$359.52	\$351.12	\$188.10	\$234.17	\$227.03	\$188.11	\$126.18	\$201.37
34	\$118.52	\$131.94	\$140.28	\$190.78	\$139.06	\$206.08	\$259.12	\$230.93	\$333.06	\$361.44	\$352.88	\$191.16	\$235.15	\$233.83	\$191.06	\$130.81	\$205.60
35	\$120.47	\$134.03	\$140.60	\$197.31	\$139.65	\$212.13	\$264.79	\$231.53	\$352.81	\$384.81	\$353.25	\$191.56	\$254.95	\$236.61	\$191.42	\$131.38	\$212.16
36	\$120.68	\$134.95	\$140.97	\$202.22	\$151.49	\$212.96	\$269.05	\$231.84	\$365.46	\$387.06	\$360.76	\$191.92	\$256.93	\$252.29	\$195.51	\$142.52	\$214.20
37	\$124.55	\$138.64	\$141.32	\$203.02	\$159.93	\$213.80	\$279.05	\$232.15	\$371.01	\$387.53	\$367.72	\$203.39	\$257.23	\$255.90	\$203.35	\$150.45	\$218.90
38	\$126.16	\$140.55	\$141.67	\$203.55	\$160.78	\$220.44	\$287.62	\$241.21	\$375.54	\$387.89	\$368.42	\$206.94	\$258.97	\$257.04	\$207.03	\$151.25	\$223.26
39	\$128.45	\$142.41	\$144.11	\$214.94	\$164.08	\$223.28	\$293.64	\$245.54	\$375.84	\$388.24	\$371.76	\$210.82	\$259.39	\$267.83	\$210.81	\$154.35	\$227.45
40	\$130.76	\$144.78	\$144.46	\$219.14	\$164.44	\$233.60	\$294.16	\$245.98	\$376.15	\$388.60	\$387.54	\$211.38	\$259.74	\$268.25	\$213.66	\$154.69	\$232.08
41	\$133.07	\$145.68	\$145.90	\$222.91	\$167.57	\$234.64	\$299.82	\$254.64	\$376.46	\$389.00	\$413.00	\$217.64	\$273.37	\$269.08	\$214.15	\$159.97	\$236.81
42	\$135.20	\$148.89	\$152.16	\$225.83	\$168.27	\$235.93	\$305.52	\$259.71	\$382.01	\$389.37	\$419.75	\$221.08	\$279.55	\$281.26	\$221.11	\$160.64	\$241.32
43	\$136.98	\$151.65	\$155.96	\$230.34	\$168.64	\$250.35	\$311.18	\$260.29	\$384.58	\$415.25	\$435.05	\$224.69	\$291.32	\$285.15	\$224.84	\$160.99	\$249.76
44	\$138.93	\$153.97	\$157.20	\$233.39	\$171.63	\$264.21	\$316.98	\$271.74	\$384.89	\$425.75	\$436.59	\$228.10	\$295.19	\$290.90	\$228.07	\$163.84	\$251.63
45	\$141.06	\$155.84	\$158.29	\$236.97	\$172.21	\$270.87	\$322.69	\$292.77	\$385.19	\$427.05	\$438.57	\$231.73	\$295.73	\$296.92	\$231.71	\$164.40	\$258.73
46	\$142.66	\$159.25	\$164.09	\$240.69	\$183.79	\$273.18	\$329.80	\$294.87	\$385.50	\$453.10	\$478.23	\$234.14	\$306.40	\$299.58	\$234.12	\$175.45	\$263.52
47	\$144.78	\$160.84	\$166.84	\$244.88	\$184.95	\$275.43	\$334.05	\$311.02	\$385.82	\$472.99	\$482.22	\$237.96	\$307.47	\$303.73	\$238.07	\$176.56	\$268.96
48	\$146.73	\$163.80	\$169.02	\$248.54	\$185.32	\$283.78	\$339.75	\$312.64	\$389.65</								

94	\$212.55	\$232.71	\$241.65	\$411.11	\$337.50	\$490.96	\$592.43	\$540.79	\$628.21	\$728.77	\$744.30	\$401.27	\$551.74	\$491.67	\$400.89	\$317.50	\$488.12
96	\$214.24	\$233.43	\$242.60	\$413.62	\$347.08	\$501.21	\$598.84	\$545.21	\$629.16	\$787.89	\$782.15	\$409.08	\$555.26	\$504.88	\$409.00	\$331.33	\$496.50
98	\$215.02	\$234.46	\$243.65	\$414.58	\$354.35	\$502.15	\$601.73	\$546.16	\$630.11	\$814.37	\$786.55	\$410.04	\$556.21	\$507.93	\$411.82	\$333.35	\$505.37
100	\$218.11	\$236.49	\$244.70	\$415.58	\$370.68	\$503.24	\$602.74	\$575.66	\$674.33	\$839.82	\$906.29	\$411.10	\$557.16	\$508.98	\$415.59	\$353.89	\$507.19
105	\$228.14	\$247.29	\$254.32	\$436.01	\$396.94	\$529.40	\$628.99	\$599.02	\$708.05	\$881.81	\$950.71	\$430.39	\$580.61	\$536.06	\$436.00	\$373.42	\$527.09
110	\$239.00	\$259.06	\$266.37	\$456.77	\$415.84	\$554.32	\$658.94	\$627.54	\$741.76	\$923.80	\$995.94	\$450.88	\$608.27	\$561.59	\$456.41	\$391.19	\$531.34
115	\$249.87	\$270.84	\$278.23	\$477.53	\$434.74	\$579.40	\$688.89	\$656.06	\$775.48	\$965.79	\$1,040.22	\$471.37	\$635.91	\$587.11	\$476.74	\$408.97	\$548.13
120	\$260.73	\$282.62	\$290.32	\$498.29	\$453.64	\$604.60	\$718.85	\$684.59	\$809.19	\$1,007.78	\$1,084.41	\$491.87	\$663.56	\$612.64	\$497.03	\$426.76	\$570.02
125	\$271.59	\$294.39	\$302.11	\$519.06	\$472.54	\$629.55	\$748.80	\$713.12	\$842.91	\$1,049.77	\$1,128.53	\$512.36	\$691.21	\$638.17	\$517.68	\$444.53	\$592.05
130	\$282.06	\$306.16	\$316.14	\$539.82	\$491.45	\$654.43	\$778.75	\$741.64	\$876.62	\$1,091.76	\$1,173.62	\$532.85	\$718.85	\$663.70	\$538.36	\$462.32	\$608.04
135	\$292.90	\$317.94	\$328.24	\$560.58	\$510.35	\$679.55	\$808.70	\$770.17	\$910.34	\$1,133.76	\$1,217.65	\$553.35	\$746.50	\$689.22	\$561.50	\$480.10	\$623.53
140	\$303.70	\$329.71	\$340.37	\$581.34	\$529.25	\$704.09	\$838.65	\$798.69	\$944.06	\$1,175.75	\$1,262.71	\$573.84	\$774.15	\$714.75	\$582.28	\$497.88	\$643.99
145	\$314.30	\$341.49	\$352.52	\$602.10	\$548.15	\$728.89	\$868.61	\$827.21	\$977.77	\$1,217.73	\$1,306.60	\$594.34	\$801.80	\$740.27	\$603.07	\$515.66	\$664.66
150	\$325.05	\$353.26	\$364.65	\$622.86	\$567.05	\$757.22	\$898.56	\$855.74	\$1,011.49	\$1,259.72	\$1,351.62	\$614.83	\$829.44	\$765.80	\$623.86	\$533.44	\$685.20

Shipments of More Than 150 Pounds* (non-pallet)

Minimum	\$325.05	\$353.26	\$364.65	\$622.86	\$567.05	\$757.22	\$898.56	\$855.74	\$1,011.49	\$1,259.72	\$1,351.62	\$614.83	\$829.44	\$765.80	\$623.86	\$533.44	\$685.20
---------	----------	----------	----------	----------	----------	----------	----------	----------	------------	------------	------------	----------	----------	----------	----------	----------	----------

Any fraction of a pound more than the weight shown in the rate chart is rounded up to the next listed weight.

*UPS offers customized rate sheets identifying its firm offer of rates and prices for transportation rates and prices. The rates and prices identified in the rate sheets will be guaranteed for 12-month periods and increase only with approval by the Lead State. Other fees and charges that may impact an authorized user's invoice are identified in UPS's Rate and Service Guide and as described in UPS's Tariff/Terms and Conditions of Service, in effect at the time of shipping. These fees and charges are subject to change without notice. In accordance with the conditions of the solicitation, UPS has waived all pick-up charges, including on-call/on-demand, and capped fuel surcharges at 7%. Fuel surcharge information is posted on UPS's website, www.ups.com.

NASPO ValuePoint

UPS Worldwide Saver® - Export

The rates shown are for shipments originating in the United States.

Letter/Pak/Document*	Zones																
	481	482	484	401	402	403	404	405	406	407	408	409	411	412	413	420	421
Letter*	\$25.14	\$25.90	\$27.00	\$34.50	\$31.00	\$37.55	\$40.18	\$39.66	\$50.80	\$71.90	\$76.54	\$32.89	\$40.22	\$38.12	\$32.78	\$29.45	\$35.56
Pak 1 lb*	\$72.46	\$75.32	\$63.83	\$81.02	\$71.03	\$90.50	\$93.50	\$89.89	\$102.46	\$141.02	\$137.84	\$75.17	\$92.05	\$88.37	\$75.69	\$67.48	\$75.60
Pak 2 lbs*	\$79.55	\$82.98	\$67.01	\$85.64	\$79.02	\$92.95	\$101.79	\$95.86	\$137.46	\$167.33	\$165.33	\$82.09	\$106.97	\$96.68	\$83.72	\$75.07	\$101.26
1	\$41.22	\$44.71	\$41.52	\$50.57	\$47.06	\$59.64	\$54.04	\$51.97	\$64.38	\$80.16	\$83.41	\$46.06	\$56.17	\$53.38	\$47.72	\$44.70	\$46.72
2	\$45.35	\$49.31	\$46.69	\$56.90	\$50.77	\$70.37	\$66.02	\$60.28	\$77.42	\$91.31	\$92.03	\$52.37	\$63.95	\$61.17	\$54.91	\$48.23	\$57.89
3	\$50.57	\$53.85	\$51.93	\$65.95	\$55.64	\$78.45	\$75.83	\$69.67	\$90.57	\$110.06	\$104.65	\$61.75	\$71.33	\$68.78	\$62.93	\$52.86	\$62.27
4	\$55.70	\$59.19	\$58.37	\$76.64	\$62.50	\$89.19	\$87.93	\$79.32	\$105.84	\$128.48	\$124.38	\$71.58	\$78.41	\$77.16	\$73.27	\$59.37	\$70.25
5	\$62.24	\$70.58	\$66.53	\$89.42	\$70.49	\$96.65	\$99.17	\$94.29	\$117.38	\$142.59	\$139.57	\$86.86	\$93.75	\$93.59	\$92.65	\$66.96	\$78.53
6	\$64.29	\$73.64	\$73.56	\$94.65	\$76.54	\$104.43	\$108.53	\$99.29	\$132.61	\$151.08	\$148.47	\$92.50	\$103.33	\$102.30	\$97.25	\$72.71	\$91.45
7	\$65.94	\$75.42	\$78.54	\$100.10	\$81.95	\$114.48	\$118.13	\$108.08	\$147.31	\$162.48	\$165.65	\$98.12	\$111.64	\$113.12	\$102.52	\$77.85	\$101.51
8	\$68.04	\$77.70	\$83.55	\$104.49	\$86.69	\$122.51	\$127.23	\$120.96	\$175.36	\$170.32	\$177.36	\$102.53	\$123.02	\$119.56	\$105.55	\$82.35	\$111.08
9	\$68.52	\$79.38	\$84.18	\$104.97	\$87.13	\$125.10	\$129.53	\$122.85	\$178.14	\$174.56	\$184.16	\$102.98	\$129.00	\$120.66	\$106.81	\$82.78	\$124.00
10	\$68.99	\$79.87	\$85.75	\$106.74	\$88.57	\$126.29	\$133.87	\$123.33	\$178.74	\$175.29	\$187.80	\$103.98	\$129.61	\$121.72	\$107.30	\$84.14	\$130.20

Package	1	2	3	4	5	6	7	8	9	10	11	12	13	14	15	16	17	18	19	20	21	22	23	24	25	26	27	28	29	30	31	32	33	34	35	36	37	38	39	40	41	42	43	44	45	46	47	48	49	50	51	52	53	54	55	56	57	58	59	60	61	62	63	64	65	66	67	68	69	70	71	72	73	74	75	76	77	78	79	80	81	82	83	84	85	86	87	88	89	90	91	92	93	94	95	96	97	98	99	100
1	\$40.47	\$43.89	\$40.76	\$49.65	\$46.20	\$58.55	\$53.05	\$51.01	\$63.20	\$78.69	\$81.88	\$45.22	\$55.14	\$52.40	\$46.85	\$43.89	\$45.87																																																																																			
2	\$44.52	\$48.41	\$45.83	\$55.86	\$49.84	\$69.08	\$64.81	\$59.18	\$76.01	\$89.64	\$90.34	\$51.41	\$62.78	\$60.05	\$53.90	\$47.35	\$56.83																																																																																			
3	\$49.65	\$52.86	\$50.98	\$64.75	\$54.62	\$77.01	\$74.45	\$68.39	\$88.91	\$104.04	\$102.73	\$60.62	\$70.02	\$67.52	\$61.77	\$51.89	\$61.13																																																																																			
4	\$54.68	\$58.11	\$57.30	\$75.24	\$61.35	\$87.55	\$86.32	\$77.87	\$103.90	\$126.13	\$122.10	\$70.27	\$76.98	\$75.75	\$71.93	\$58.28	\$68.97																																																																																			
5	\$61.10	\$69.29	\$65.31	\$87.78	\$69.20	\$94.88	\$97.35	\$92.56	\$115.23	\$139.98	\$137.02	\$85.27	\$92.03	\$91.88	\$90.95	\$65.74	\$77.10																																																																																			
6	\$63.11	\$72.30	\$72.22	\$92.92	\$75.14	\$102.52	\$106.54	\$97.47	\$130.18	\$148.31	\$145.75	\$90.80	\$101.43	\$100.42	\$95.47	\$71.38	\$89.78																																																																																			
7	\$64.74	\$74.04	\$72.71	\$98.27	\$80.45	\$112.39	\$115.97	\$106.10	\$144.61	\$159.50	\$162.61	\$96.32	\$109.60	\$111.05	\$100.64	\$76.42	\$99.65																																																																																			
8	\$66.79	\$76.28	\$82.02	\$102.58	\$85.10	\$120.27	\$124.90	\$118.74	\$172.15	\$167.20	\$174.12	\$100.65	\$120.76	\$117.37	\$103.62	\$80.84	\$109.05																																																																																			
9	\$67.27	\$77.92	\$82.64	\$103.05	\$85.54	\$122.81	\$127.16	\$120.61	\$174.88	\$171.36	\$180.79	\$101.10	\$126.64	\$118.45	\$104.86	\$81.26	\$121.73																																																																																			
10	\$67.73	\$78.40	\$84.18	\$104.79	\$86.95	\$123.98	\$131.42	\$121.07	\$175.47	\$172.08	\$184.37	\$102.08	\$127.24	\$119.49	\$105.33	\$82.60	\$127.82																																																																																			
11	\$69.32	\$79.88	\$86.85	\$106.31	\$91.13	\$125.30	\$132.93	\$125.86	\$182.32	\$174.94	\$184.79	\$105.69	\$128.74	\$123.68	\$107.33	\$86.58	\$134.48																																																																																			
12	\$70.13	\$80.74	\$89.78	\$109.72	\$94.93	\$127.17	\$135.43	\$128.81	\$183.66	\$180.37	\$191.62	\$108.76	\$133.06	\$126.18	\$109.31	\$90.18	\$144.17																																																																																			
13	\$85.90	\$100.19	\$106.10	\$125.23	\$99.72	\$147.43	\$164.93	\$152.26	\$222.57	\$209.59	\$230.63	\$131.06	\$152.48	\$153.70	\$130.24	\$94.74	\$150.59																																																																																			
14	\$92.41	\$105.40	\$117.72	\$142.21	\$104.16	\$162.82	\$186.76	\$165.34	\$239.34	\$238.88	\$256.47	\$142.69	\$185.74	\$172.47	\$139.19	\$98.96	\$156.69																																																																																			
15	\$96.00	\$108.95	\$125.99	\$147.11	\$115.61	\$172.82	\$199.51	\$190.63	\$251.78	\$258.97	\$259.71	\$147.86	\$189.44	\$180.94	\$146.89	\$109.83	\$165.74																																																																																			
16	\$99.57	\$112.51	\$126.82	\$152.27	\$122.99	\$180.07	\$207.55	\$194.73	\$281.62	\$295.14	\$281.88	\$153.78	\$196.84	\$190.35	\$153.87	\$116.84	\$173.64																																																																																			
17	\$102.44	\$115.80	\$127.30	\$155.46	\$123.84	\$180.78	\$213.68	\$195.16	\$283.88	\$298.75	\$300.75	\$158.95	\$198.67	\$195.53	\$154.72	\$117.64	\$180.12																																																																																			
18	\$104.55	\$116.28	\$127.78	\$155.88	\$124.61	\$181.27	\$214.28	\$195.58	\$293.82	\$307.82	\$316.88	\$160.25	\$199.10	\$196.01	\$155.17	\$118.38	\$184.44																																																																																			
19	\$105.00	\$117.47	\$128.26	\$156.31	\$132.91	\$181.72	\$214.74	\$196.01	\$297.76	\$324.11	\$317.75	\$160.73	\$199.52	\$196.49	\$155.65	\$126.26	\$192.33																																																																																			
20	\$105.45	\$117.95	\$128.74	\$156.74	\$137.85	\$182.18	\$215.19	\$196.44	\$298.35	\$327.83	\$319.31	\$161.21	\$199.95	\$196.94	\$156.12	\$130.96	\$198.51																																																																																			
21	\$105.90	\$118.42	\$129.21	\$157.16	\$139.41	\$182.64	\$215.65	\$196.86	\$298.79	\$328.28	\$319.73	\$161.66	\$200.38	\$197.40	\$159.86	\$132.44	\$201.48																																																																																			
22	\$106.35	\$118.88	\$129.67	\$157.59	\$139.90	\$183.08	\$216.11	\$197.29	\$299.23	\$328.73	\$320.16	\$162.11	\$200.80	\$197.87	\$163.77	\$132.91	\$207.43																																																																																			
23	\$106.80	\$119.34	\$130.14	\$158.01	\$142.34	\$183.53	\$216.56	\$197.72	\$299.68	\$329.34	\$323.67	\$162.56	\$201.23	\$198.34	\$168.04	\$135.22	\$212.05																																																																																			
24	\$107.79	\$120.41	\$131.50	\$160.42	\$143.40	\$184.52	\$217.59	\$206.48	\$307.86	\$329.76	\$344.42	\$163.35	\$205.74	\$198.77	\$168.67	\$136.23	\$218.37																																																																																			
25	\$108.78	\$121.45	\$133.23	\$161.96	\$146.50	\$189.42	\$221.07	\$210.38	\$311.87	\$331.53	\$352.27	\$166.76	\$208.99	\$202.88	\$170.66	\$139.18	\$225.35																																																																																			
26	\$132.40	\$151.05	\$154.10	\$210.34	\$158.38	\$249.89	\$281.73	\$252.38	\$369.66	\$398.36	\$361.09	\$210.79	\$257.56	\$255.80	\$199.53	\$150.46	\$232.71																																																																																			
27	\$140.99	\$156.22	\$172.35	\$226.01	\$161.62	\$259.44	\$292.33	\$270.45	\$397.94	\$451.41	\$443.09	\$222.56	\$284.62	\$271.52	\$220.82	\$153.54	\$235.79																																																																																			
28	\$145.91	\$164.03	\$180.91	\$232.50	\$162.13	\$260.41	\$303.16	\$272.33	\$400.77	\$471.98	\$454.14	\$229.09	\$287.35	\$276.48	\$225.79	\$154.02	\$241.75																																																																																			
29	\$148.64	\$165.97	\$181.78	\$236.84	\$162.63	\$261.84	\$311.83	\$295.23	\$418.79	\$483.96	\$455.24	\$229.62	\$288.22	\$289.81	\$226.22	\$154.50	\$247.70																																																																																			
30	\$151.55	\$168.26	\$182.26	\$241.81	\$166.41	\$276.28	\$313.08	\$302.48	\$422.09	\$486.46	\$456.30	\$231.57	\$289.28	\$291.39	\$233.52	\$158.09	\$253.17																																																																																			
31	\$155.15	\$173.36	\$182.74	\$246.93	\$172.08	\$279.37	\$331.28	\$305.33	\$423.07	\$486.97	\$458.01	\$239.43	\$310.54	\$300.91	\$243.24	\$163.48	\$258.78																																																																																			
32	\$158.38	\$176.24	\$183.17	\$248.27	\$179.64	\$280.88	\$341.27	\$305.75	\$425.12	\$488.08	\$458.62	\$252.92	\$322.39	\$307.32	\$248.40	\$170.66	\$265.75																																																																																			
33	\$161.61	\$179.78	\$193.25	\$261.51	\$183.54	\$285.67	\$349.08	\$312.69	\$456.61	\$499.24	\$482.81	\$257.89	\$323.58	\$308.55	\$256.64	\$174.36	\$271.57																																																																																			
34	\$164.83	\$182.68	\$194.80	\$264.93	\$190.28	\$286.18	\$356.65	\$320.05	\$459.77	\$501.92	\$485.23	\$262.09	\$324.94	\$317.78	\$260.68	\$180.76	\$277.27																																																																																			
35	\$167.49	\$185.58	\$195.24	\$274.00	\$191.09	\$294.58	\$364.46	\$320.88	\$487.04	\$530.69	\$485.74	\$262.63	\$352.29	\$321.56	\$261.16	\$181.54	\$286.12																																																																																			
36	\$167.91	\$187.77	\$195.75	\$280.82	\$207.28	\$295.73	\$370.32	\$321.31	\$504.51	\$553.80	\$496.06	\$263.13	\$350.52	\$342.88	\$266.75	\$196.92	\$288.87																																																																																			
37	\$173.12	\$191.95	\$196.24	\$281.92	\$218.83	\$296.89	\$384.08	\$321.73	\$512.17	\$534.44	\$505.63	\$278.84	\$355.45	\$347.78	\$277.44	\$207.89	\$295.21																																																																																			
38	\$175.45	\$194.59	\$196.73	\$282.66	\$220.00	\$306.11	\$395.88	\$334.29	\$518.41	\$534.93	\$506.59	\$283.71	\$357.85	\$349.33	\$282.46	\$209.00	\$301.09																																																																																			
39	\$178.55	\$197.17	\$200.12	\$295.54	\$224.51	\$310.06	\$404.17	\$340.30	\$518.84	\$535.42	\$511.19	\$289.04	\$358.43	\$364.00	\$287.61	\$213.29	\$306.73																																																																																			
40	\$181.78	\$200.46	\$200.60	\$301.33	\$225.01	\$324.39	\$404.88	\$340.91	\$519.26	\$535.92	\$532.88	\$290.66	\$358.92	\$364.57	\$291.50	\$213.76	\$312.99																																																																																			
41	\$185.00	\$201.70	\$202.60	\$306.51	\$229.29	\$325.83	\$412.66	\$352.91	\$519.69	\$536.46	\$567.89	\$298.39	\$377.75	\$365.70	\$292.17	\$217.82	\$319.37																																																																																			
42	\$187.98	\$206.14	\$211.30	\$310.52	\$230.25	\$327.62	\$420.52	\$359.94	\$527.35	\$536.98	\$577.18	\$303.10	\$386.29	\$382.24	\$301.67	\$218.74	\$325.44																																																																																			
43	\$190.38	\$209.96	\$215.09	\$316.72	\$230.75	\$347.65	\$428.30	\$360.73	\$530.89	\$572.67	\$598.22	\$308.05	\$402.55	\$38																																																																																						

105	\$317.44	\$344.08	\$353.16	\$605.47	\$543.15	\$735.16	\$865.74	\$831.84	\$977.43	\$1,216.11	\$1,320.21	\$591.80	\$802.30	\$736.39	\$599.53	\$515.99	\$710.84
110	\$332.55	\$360.47	\$369.90	\$634.29	\$569.01	\$769.76	\$906.96	\$871.45	\$1,023.97	\$1,274.02	\$1,383.02	\$619.98	\$840.51	\$771.46	\$627.59	\$540.56	\$716.56
115	\$347.67	\$376.85	\$386.37	\$663.13	\$594.87	\$804.60	\$948.19	\$911.05	\$1,070.52	\$1,331.93	\$1,444.52	\$648.16	\$878.72	\$806.52	\$655.54	\$565.13	\$739.21
120	\$362.78	\$393.24	\$403.15	\$691.96	\$620.73	\$839.58	\$989.42	\$950.67	\$1,117.06	\$1,389.84	\$1,505.88	\$676.34	\$916.92	\$841.59	\$683.44	\$589.70	\$768.73
125	\$377.90	\$409.62	\$419.53	\$720.79	\$646.60	\$874.23	\$1,030.64	\$990.28	\$1,163.60	\$1,447.75	\$1,567.14	\$704.51	\$955.13	\$876.65	\$711.83	\$614.27	\$798.45
130	\$392.46	\$426.00	\$435.99	\$749.62	\$672.46	\$908.79	\$1,071.87	\$1,029.89	\$1,210.15	\$1,505.66	\$1,629.77	\$732.70	\$993.33	\$911.72	\$740.27	\$638.84	\$820.01
135	\$407.54	\$442.39	\$452.68	\$778.45	\$698.33	\$943.66	\$1,113.10	\$1,069.50	\$1,256.69	\$1,563.57	\$1,690.91	\$760.88	\$1,031.53	\$946.78	\$772.09	\$663.41	\$840.90
140	\$422.58	\$458.77	\$469.41	\$807.28	\$724.19	\$977.74	\$1,154.32	\$1,109.11	\$1,303.24	\$1,621.48	\$1,753.48	\$789.05	\$1,069.74	\$981.85	\$800.67	\$687.98	\$868.48
145	\$437.32	\$475.15	\$486.16	\$836.12	\$750.05	\$1,012.18	\$1,195.54	\$1,148.72	\$1,349.78	\$1,679.39	\$1,814.43	\$817.24	\$1,107.94	\$1,016.91	\$829.25	\$712.55	\$896.36
150	\$452.28	\$491.54	\$502.89	\$864.95	\$775.92	\$1,051.52	\$1,236.77	\$1,188.33	\$1,396.32	\$1,737.29	\$1,876.94	\$845.42	\$1,146.14	\$1,051.98	\$857.83	\$737.12	\$924.06

Shipments of More Than 150 Pounds*

Price Per Lb	Zones																
	481	482	484	401	402	403	404	405	406	407	408	409	411	412	413	420	421
	\$3.02	\$3.28	\$3.35	\$5.77	\$5.18	\$7.01	\$8.25	\$7.92	\$9.31	\$11.59	\$12.51	\$5.64	\$7.64	\$7.01	\$5.72	\$4.92	\$6.16
Minimum	\$452.28	\$491.54	\$502.89	\$864.95	\$775.92	\$1,051.52	\$1,236.77	\$1,188.33	\$1,396.32	\$1,737.29	\$1,876.94	\$845.42	\$1,146.14	\$1,051.98	\$857.83	\$737.12	\$924.06

Any fraction of a pound more than the weight shown in the rate chart is rounded up to the next listed weight.

*UPS offers customized rate sheets identifying its firm offer of rates and prices for transportation rates and prices. The rates and prices identified in the rate sheets will be guaranteed for 12-month periods and increase only with approval by the Lead State. Other fees and charges that may impact an authorized user's invoice are identified in UPS's Rate and Service Guide and as described in UPS's Tariff/Terms and Conditions of Service, in effect at the time of shipping. These fees and charges are subject to change without notice. In accordance with the conditions of the solicitation, UPS has waived all pick-up charges, including on-call/on-demand, and capped fuel surcharges at 7%. Fuel surcharge information is posted on UPS's website, www.ups.com.

NASPO ValuePoint

UPS Worldwide Expedited® - Export

The rates shown are for shipments originating in the United States.

Document/Package*	Zones																
	71	72	74	601 / 631	602 / 632	603 / 633	604 / 634	605 / 635	606 / 636	607 / 637	608 / 638	609 / 639	611 / 641	612 / 642	613 / 643	620	621
1	\$38.48	\$41.40	\$36.43	\$46.03	\$39.44	\$51.83	\$50.67	\$48.29	\$60.07	\$55.93	\$50.67	\$42.77	\$50.28	\$49.25	\$43.05	\$37.89	\$41.84
2	\$41.38	\$45.48	\$40.53	\$53.77	\$45.32	\$60.55	\$62.29	\$56.45	\$71.81	\$70.00	\$65.57	\$48.62	\$56.03	\$57.22	\$51.02	\$43.77	\$51.54
3	\$44.57	\$49.61	\$46.36	\$62.89	\$50.60	\$68.10	\$70.38	\$63.99	\$81.07	\$83.83	\$74.27	\$58.19	\$66.40	\$64.69	\$58.16	\$49.05	\$57.59
4	\$47.54	\$54.04	\$48.90	\$71.07	\$55.83	\$75.12	\$77.58	\$72.44	\$94.64	\$104.50	\$94.91	\$65.37	\$70.35	\$71.19	\$65.63	\$54.28	\$64.48
5	\$54.21	\$62.54	\$56.82	\$84.27	\$60.99	\$89.07	\$88.72	\$83.52	\$104.06	\$117.83	\$107.51	\$78.70	\$79.61	\$80.28	\$77.34	\$59.44	\$69.75
6	\$56.15	\$64.12	\$59.68	\$89.77	\$68.13	\$94.66	\$96.20	\$91.37	\$121.70	\$132.50	\$124.83	\$84.88	\$87.56	\$87.46	\$83.44	\$66.58	\$83.60
7	\$58.35	\$66.59	\$66.47	\$94.51	\$72.94	\$101.82	\$105.84	\$99.40	\$131.63	\$147.10	\$130.72	\$86.82	\$96.85	\$98.00	\$85.15	\$71.39	\$86.95
8	\$61.03	\$68.84	\$71.94	\$96.79	\$74.83	\$110.86	\$113.29	\$107.05	\$149.82	\$151.34	\$146.06	\$90.40	\$106.07	\$101.75	\$87.49	\$73.28	\$99.49
9	\$61.59	\$72.20	\$72.28	\$100.05	\$78.40	\$113.68	\$121.10	\$113.03	\$161.80	\$166.61	\$167.71	\$91.92	\$114.35	\$107.35	\$98.58	\$76.85	\$105.97
10	\$63.47	\$73.41	\$73.64	\$100.98	\$79.91	\$115.31	\$121.48	\$113.37	\$164.13	\$166.95	\$168.18	\$97.81	\$118.15	\$115.13	\$99.50	\$78.36	\$112.68
11	\$64.94	\$74.46	\$82.05	\$102.01	\$82.90	\$116.33	\$123.02	\$115.08	\$170.69	\$167.29	\$172.85	\$99.51	\$121.60	\$116.89	\$100.95	\$81.35	\$114.72
12	\$65.62	\$75.71	\$82.39	\$102.91	\$85.30	\$117.92	\$125.38	\$116.17	\$173.78	\$169.49	\$174.64	\$99.85	\$124.48	\$117.23	\$102.72	\$83.75	\$121.00
13	\$70.72	\$86.82	\$87.03	\$115.85	\$90.28	\$133.03	\$156.03	\$135.85	\$202.48	\$184.90	\$190.28	\$111.05	\$132.09	\$139.54	\$121.29	\$88.73	\$131.90
14	\$73.13	\$89.53	\$87.40	\$124.31	\$93.33	\$146.32	\$166.11	\$148.33	\$216.18	\$212.17	\$225.58	\$112.02	\$152.08	\$144.61	\$122.90	\$91.78	\$137.99
15	\$75.54	\$94.24	\$90.10	\$126.82	\$99.70	\$148.52	\$173.18	\$157.38	\$221.47	\$239.58	\$225.93	\$119.37	\$173.38	\$147.92	\$124.56	\$98.15	\$138.99
16	\$79.08	\$96.36	\$91.22	\$138.51	\$104.51	\$155.38	\$184.12	\$170.49	\$230.40	\$246.59	\$226.27	\$127.40	\$177.55	\$159.45	\$126.19	\$102.96	\$147.91
17	\$79.69	\$96.74	\$95.85	\$139.15	\$107.08	\$158.73	\$188.82	\$172.78	\$241.30	\$252.25	\$226.61	\$133.80	\$180.37	\$166.01	\$129.18	\$105.53	\$157.54
18	\$81.79	\$99.01	\$97.93	\$141.28	\$111.40	\$161.45	\$190.32	\$177.60	\$257.45	\$262.64	\$248.39	\$134.68	\$186.39	\$168.45	\$139.85	\$109.85	\$162.40
19	\$83.87	\$101.45	\$107.21	\$141.78	\$115.11	\$168.76	\$200.92	\$187.49	\$266.85	\$274.89	\$253.35	\$141.79	\$189.55	\$173.95	\$145.69	\$113.56	\$167.59
20	\$85.96	\$103.87	\$110.45	\$144.12	\$118.85	\$169.67	\$201.79	\$188.11	\$267.73	\$290.58	\$268.37	\$146.77	\$189.90	\$186.49	\$145.81	\$117.30	\$173.06
21	\$94.97	\$112.56	\$110.79	\$150.55	\$123.17	\$171.34	\$205.21	\$188.85	\$278.76	\$308.68	\$301.98	\$150.67	\$190.24	\$187.41	\$145.82	\$121.62	\$178.63
22	\$97.22	\$112.91	\$111.31	\$150.89	\$126.97	\$171.68	\$205.60	\$189.19	\$284.15	\$310.30	\$305.78	\$151.01	\$190.59	\$188.25	\$154.54	\$125.42	\$183.74
23	\$99.20	\$113.50	\$113.99	\$151.23	\$129.48	\$172.03	\$206.54	\$189.53	\$284.49	\$316.99	\$309.40	\$151.35	\$190.93	\$188.66	\$157.45	\$127.93	\$185.71
24	\$103.04	\$113.87	\$117.71	\$153.61	\$130.79	\$174.88	\$207.84	\$190.51	\$286.97	\$317.33	\$309.74	\$151.69	\$193.99	\$189.98	\$158.54	\$129.24	\$188.89
25	\$103.38	\$115.87	\$118.06	\$154.63	\$132.42	\$179.39	\$209.66	\$192.57	\$288.62	\$320.39	\$319.62	\$154.68	\$195.85	\$191.87	\$159.10	\$130.87	\$196.68
26	\$113.83	\$127.71	\$122.72	\$198.48	\$141.17	\$229.51	\$258.05	\$230.98	\$315.92	\$353.14	\$331.14	\$190.04	\$243.83	\$231.66	\$180.95	\$139.62	\$204.25
27	\$116.08	\$138.98	\$123.09	\$203.59	\$147.08	\$239.23	\$270.82	\$235.53	\$324.24	\$359.79	\$364.14	\$202.46	\$263.58	\$244.92	\$184.59	\$145.54	\$204.31
28	\$120.43	\$140.01	\$126.46	\$208.87	\$147.47	\$244.07	\$282.00	\$258.43	\$329.60	\$379.90	\$364.48	\$202.80	\$273.00	\$246.48	\$185.47	\$145.92	\$211.70
29	\$122.26	\$140.44	\$129.96	\$213.31	\$149.27	\$250.44	\$295.69	\$267.58	\$346.67	\$405.99	\$372.41	\$205.74	\$274.12	\$274.93	\$198.24	\$147.72	\$219.02
30	\$122.64	\$145.73	\$134.35	\$213.70	\$151.62	\$256.28	\$298.16	\$268.31	\$349.61	\$407.97	\$372.82	\$206.08	\$274.48	\$275.40	\$210.63	\$150.07	\$224.35
31	\$125.06	\$146.27	\$136.06	\$218.23	\$156.66	\$264.47	\$312.94	\$274.99	\$371.84	\$408.36	\$379.67	\$209.20	\$280.61	\$281.01	\$214.84	\$155.11	\$231.29
32	\$127.77	\$152.12	\$136.40	\$218.57	\$162.51	\$264.86	\$314.05	\$277.68	\$379.39	\$408.75	\$380.04	\$216.73	\$281.93	\$281.39	\$226.44	\$160.96	\$237.65
33	\$130.47	\$154.85	\$136.75	\$218.91	\$165.57	\$268.19	\$319.56	\$280.99	\$382.65	\$417.52	\$380.41	\$217.43	\$297.18	\$289.94	\$230.15	\$164.02	\$240.60
34	\$133.17	\$155.25	\$138.05	\$219.50	\$168.19	\$268.97	\$325.66	\$281.69	\$383.37	\$423.29	\$380.77	\$236.46	\$307.72	\$290.80	\$230.36	\$166.64	\$243.75
35	\$135.89	\$157.65	\$138.42	\$219.89	\$171.24	\$272.10	\$334.40	\$282.15	\$384.36	\$424.72	\$381.14	\$240.86	\$313.54	\$291.79	\$231.68	\$169.69	\$250.08
36	\$138.59	\$160.44	\$139.17	\$220.27	\$173.89	\$277.60	\$344.18	\$282.53	\$384.82	\$430.86	\$381.50	\$241.28	\$318.98	\$311.57	\$247.10	\$172.34	\$251.72
37	\$141.27	\$163.49	\$141.76	\$220.66	\$176.52	\$279.33	\$345.15	\$282.89	\$388.06	\$443.98	\$381.86	\$245.28	\$319.46	\$327.62	\$248.03	\$174.97	\$257.82
38	\$143.98	\$166.53	\$142.13	\$226.07	\$179.55	\$285.95	\$356.55	\$287.93	\$412.84	\$455.21	\$407.63	\$255.69	\$322.54	\$333.78	\$257.01	\$178.00	\$264.29
39	\$146.69	\$169.56	\$143.46	\$240.91	\$182.75	\$291.32	\$366.55	\$308.62	\$421.63	\$465.55	\$410.48	\$256.71	\$323.00	\$335.10	\$258.87	\$181.20	\$268.41
40	\$149.41	\$174.16	\$143.83	\$241.94	\$185.94	\$305.07	\$367.89	\$325.71	\$425.51	\$469.71	\$411.28	\$257.10	\$324.20	\$336.20	\$259.53	\$184.39	\$270.68
41	\$152.12	\$174.63	\$144.21	\$246.71	\$188.40	\$305.97	\$377.22	\$328.84	\$425.92	\$476.54	\$416.71	\$263.73	\$341.29	\$345.34	\$265.98	\$185.58	\$274.85
42	\$154.86	\$177.15	\$144.64	\$247.42	\$190.29	\$306.74	\$378.16	\$332.70	\$428.76	\$518.16	\$448.58	\$264.45	\$347.65	\$346.27	\$267.32	\$187.44	\$279.98
43	\$157.58	\$180.43	\$145.69	\$251.05	\$192.91	\$324.22	\$390.46	\$337.57	\$432.16	\$531.80	\$481.88	\$271.11	\$373.49	\$347.16	\$272.16	\$190.02	\$285.81
44	\$160.31	\$182.95	\$146.72	\$261.32	\$195.34	\$340.06	\$395.80	\$342.40	\$443.26	\$539.03	\$485.42	\$271.45	\$373.83	\$364.90	\$273.23	\$192.41	\$290.92
45	\$163.06	\$185.50	\$152.54	\$262.35	\$197.77	\$340.93	\$403.49	\$354.70	\$444.93	\$540.10	\$500.32	\$271.79	\$374.17	\$373.22	\$283.03	\$194.81	\$297.02
46	\$165.78	\$187.78	\$154.67	\$263.59	\$200.61	\$341.32	\$404.26	\$359.03	\$445.83	\$541.01	\$512.39	\$272.13	\$374.52	\$374.06	\$284.62	\$197.60	\$302.87
47	\$170.30	\$190.56	\$155.01	\$263.97	\$207.12	\$349.40	\$404.66	\$359.40	\$445.94	\$545.51	\$513.27	\$273.84	\$389.49	\$374.54	\$287.93	\$204.01	\$309.00
48	\$170.75	\$194.93	\$155.35	\$264.31	\$208.70	\$355.49	\$409.78	\$362.19	\$475.37	\$588.88	\$514.19	\$274.18	\$390.69	\$377.93	\$289.57	\$205.57	\$315.42
49	\$172.75	\$195.39	\$156.41	\$265.75	\$209.07	\$355.88	\$422.25	\$377.99	\$489.84	\$593.62	\$532.58	\$285.91	\$402.31	\$378.32	\$290.56	\$205.93	\$321.48
50	\$175.00	\$197.91	\$156.78	\$269.66	\$210.75	\$356.52	\$423.49	\$379.77	\$490.28	\$596.19	\$534.42	\$287.66	\$402.66	\$378.71	\$290.97	\$207.59	\$328.01
52	\$182.88	\$205.00	\$159.94	\$273.56	\$218.67	\$363.38	\$434.03	\$392.13	\$507.77	\$597.47	\$569.06	\$292.57	\$403.23	\$384.67	\$301.99	\$215.39	\$334.78
54	\$184.57	\$207.50	\$161.33	\$282.61	\$221.34	\$368.89	\$443.04	\$392.70	\$514.13	\$622.65	\$569.63	\$293.14	\$421.02	\$385.24	\$305.74	\$218.03	\$346.88
56	\$188.84	\$212.16	\$166.83	\$289.86	\$226.44	\$373.28	\$454.52	\$428.86	\$514.74	\$626.01	\$570.20	\$310.00	\$421.65	\$387.79	\$313.05	\$223.04	\$359.39
58	\$193.11	\$216.83	\$168.04	\$301.03	\$231.35	\$377.95	\$466.02	\$435.23	\$515.35	\$626.67	\$570.77	\$317.42	\$425.09	\$388.89	\$321.16	\$227.88	\$371.98
60	\$197.45	\$227.29	\$168.67	\$310.87	\$235.63	\$382.80	\$466.97	\$440.60	\$515.96	\$627.32	\$571.34	\$322.49	\$434.19	\$394.66	\$332.05	\$232.09	\$384.56
62	\$201.93	\$231.45	\$173.89	\$311.51	\$240.70	\$391.62	\$475.15	\$446.22	\$520.04	\$627.97	\$571.91	\$330.40	\$434.76	\$395.42	\$341.04	\$237.09	\$397.21
64	\$210.32	\$233.84	\$175.68	\$312.16	\$248.39	\$394.57	\$478.37	\$446.82	\$520.65	\$658.47	\$580.63	\$330.97	\$453.10	\$397.28	\$343.82	\$244.67	\$409.45
66	\$212.88	\$236.12	\$178.68	\$313.62	\$251.15	\$430.62	\$481.70	\$447.39	\$521.26	\$662.92	\$581.21	\$344.73	\$459.35	\$399.16	\$351.23	\$247.38	\$421.67
68	\$215.32	\$240.42	\$181.69	\$324.80	\$256.19	\$431.28	\$485.01	\$447.96	\$530.28	\$663.54	\$594.98	\$345.30	\$463.90	\$401.04	\$356.45	\$252.35	\$434.27
70	\$215.89	\$244.84	\$184.66	\$333.83	\$261.31	\$431.93	\$488.33	\$464.86	\$548.60	\$664.15	\$608.05	\$347.85	\$465.31	\$402.92	\$361.62	\$257.39	\$446.63
72	\$222.28	\$249.20	\$187.67	\$346.63	\$266.72	\$43											

Price Per Lb	\$2.51	\$2.57	\$2.49	\$3.83	\$3.50	\$4.56	\$5.23	\$4.67	\$6.46	\$7.67	\$7.34	\$4.42	\$5.74	\$4.12	\$4.13	\$3.44	\$5.57
Minimum	\$375.61	\$385.17	\$373.63	\$573.84	\$524.56	\$683.58	\$783.15	\$700.06	\$969.07	\$1,160.50	\$1,099.94	\$662.87	\$860.79	\$617.87	\$618.46	\$515.12	\$834.63

Any fraction of a pound more than the weight shown in the rate chart is rounded up to the next listed weight.

*UPS offers customized rate sheets identifying its firm offer of rates and prices for transportation rates and prices. The rates and prices identified in the rate sheets will be guaranteed for 12-month periods and increase only with approval by the Lead State. Other fees and charges that may impact an authorized user's invoice are identified in UPS's Rate and Service Guide and as described in UPS's Tariff/Terms and Conditions of Service, in effect at the time of shipping. These fees and charges are subject to change without notice. In accordance with the conditions of the solicitation, UPS has waived all pick-up charges, including on-call/on-demand, and capped fuel surcharges at 7%. Fuel surcharge information is posted on UPS's website, www.ups.com.

NASPO ValuePoint

UPS Standard to Canada[®] - Export

The rates shown are for shipments originating in the United States.

Package*

	Zones					
	51	52	53	54	55	56
1	\$14.77	\$14.95	\$15.14	\$23.45	\$23.78	\$24.06
2	\$15.98	\$16.16	\$16.37	\$24.66	\$25.01	\$25.30
3	\$16.48	\$16.67	\$16.94	\$25.85	\$26.22	\$26.53
4	\$17.65	\$17.86	\$18.08	\$27.25	\$27.63	\$27.96
5	\$18.71	\$18.93	\$19.18	\$27.64	\$27.99	\$28.37
6	\$19.67	\$19.90	\$20.15	\$28.95	\$29.35	\$29.70
7	\$20.57	\$20.81	\$21.08	\$29.40	\$29.82	\$30.17
8	\$21.51	\$21.76	\$22.04	\$30.46	\$30.88	\$31.26
9	\$22.40	\$22.66	\$22.95	\$30.86	\$31.30	\$31.66
10	\$23.34	\$23.61	\$23.91	\$31.86	\$32.31	\$32.70
11	\$23.73	\$24.10	\$24.41	\$33.09	\$33.57	\$33.96
12	\$24.52	\$24.93	\$25.25	\$34.01	\$34.48	\$34.89
13	\$25.50	\$25.93	\$26.26	\$34.85	\$35.59	\$36.02
14	\$25.87	\$26.30	\$26.63	\$35.27	\$35.99	\$36.42
15	\$26.24	\$26.68	\$27.11	\$35.76	\$36.35	\$36.78
16	\$27.11	\$27.57	\$28.02	\$36.99	\$37.51	\$38.13
17	\$27.83	\$28.29	\$28.72	\$38.03	\$38.56	\$39.27
18	\$28.83	\$29.31	\$29.71	\$39.17	\$39.72	\$40.34
19	\$29.73	\$30.22	\$30.63	\$40.30	\$40.87	\$41.57
20	\$30.46	\$30.97	\$31.48	\$41.40	\$41.99	\$42.64
21	\$31.37	\$31.72	\$32.46	\$42.53	\$43.14	\$43.65
22	\$32.30	\$32.68	\$33.43	\$43.77	\$44.39	\$44.96
23	\$33.09	\$33.49	\$34.14	\$44.87	\$45.49	\$46.04
24	\$33.95	\$34.35	\$34.95	\$45.94	\$46.60	\$47.17
25	\$34.61	\$35.02	\$35.55	\$47.05	\$47.72	\$48.28
26	\$35.43	\$35.84	\$36.43	\$48.36	\$49.04	\$49.62
27	\$36.42	\$36.85	\$37.41	\$49.54	\$50.24	\$50.83
28	\$37.30	\$37.73	\$38.30	\$50.77	\$51.47	\$52.09
29	\$38.17	\$38.60	\$39.24	\$51.94	\$52.68	\$53.29
30	\$39.02	\$39.48	\$40.20	\$53.12	\$53.88	\$54.52
31	\$39.64	\$40.23	\$41.13	\$54.30	\$55.17	\$55.82
32	\$40.50	\$41.09	\$41.97	\$55.50	\$56.40	\$57.07
33	\$41.50	\$42.12	\$42.95	\$56.70	\$57.60	\$58.29
34	\$42.29	\$42.90	\$43.74	\$57.88	\$58.80	\$59.50
35	\$43.11	\$43.73	\$44.87	\$58.65	\$59.60	\$60.65
36	\$43.88	\$44.52	\$45.41	\$60.01	\$60.99	\$61.70
37	\$44.88	\$45.54	\$46.42	\$61.23	\$62.21	\$62.95
38	\$45.69	\$46.36	\$47.38	\$62.28	\$63.28	\$64.11
39	\$46.73	\$47.42	\$48.27	\$63.28	\$64.29	\$65.06
40	\$47.52	\$48.21	\$49.22	\$64.49	\$65.54	\$66.32
41	\$48.34	\$49.05	\$50.00	\$65.59	\$66.65	\$67.44
42	\$49.11	\$49.83	\$50.83	\$66.56	\$67.64	\$68.43
43	\$50.03	\$50.76	\$51.76	\$67.69	\$68.79	\$69.60
44	\$50.66	\$51.41	\$52.36	\$68.56	\$69.67	\$70.49
45	\$51.62	\$52.38	\$53.34	\$69.84	\$70.96	\$71.80
46	\$52.45	\$53.22	\$54.31	\$70.83	\$71.98	\$72.83
47	\$53.26	\$54.04	\$55.14	\$71.93	\$73.08	\$73.96
48	\$53.96	\$54.75	\$55.90	\$73.01	\$74.19	\$75.06
49	\$54.86	\$55.66	\$56.68	\$74.02	\$75.22	\$76.11
50	\$55.77	\$56.58	\$57.65	\$75.21	\$76.41	\$77.32

	Zones					
	51	52	53	54	55	56
52	\$57.47	\$58.31	\$59.36	\$76.78	\$78.01	\$79.68
54	\$59.06	\$59.93	\$61.01	\$78.26	\$79.52	\$81.36
56	\$60.44	\$61.33	\$62.44	\$79.88	\$81.22	\$83.66
58	\$64.57	\$66.75	\$68.47	\$81.50	\$83.38	\$85.84
60	\$65.91	\$67.63	\$69.15	\$82.93	\$84.86	\$87.55
62	\$66.66	\$68.31	\$69.83	\$84.73	\$86.71	\$89.81
64	\$67.34	\$68.98	\$70.51	\$86.30	\$87.73	\$91.07
66	\$68.02	\$69.66	\$71.19	\$87.71	\$89.64	\$93.07
68	\$68.70	\$70.34	\$71.86	\$89.28	\$90.71	\$95.24
70	\$69.38	\$71.01	\$72.54	\$91.07	\$92.54	\$96.77
72	\$70.06	\$71.69	\$73.22	\$93.15	\$94.04	\$99.96
74	\$70.74	\$72.37	\$73.90	\$94.91	\$95.82	\$102.63
76	\$71.42	\$73.04	\$74.57	\$97.12	\$98.04	\$105.32
78	\$72.10	\$73.72	\$75.25	\$97.80	\$98.79	\$107.17
80	\$72.78	\$74.39	\$75.92	\$100.00	\$100.96	\$109.75
82	\$73.46	\$75.07	\$76.61	\$101.85	\$102.82	\$111.89
84	\$74.14	\$75.75	\$77.28	\$103.67	\$104.65	\$113.98
86	\$74.82	\$76.43	\$77.96	\$105.99	\$107.00	\$116.00
88	\$75.50	\$77.11	\$78.64	\$107.74	\$108.76	\$118.17
90	\$76.17	\$77.78	\$79.31	\$109.46	\$110.50	\$120.16
92	\$76.85	\$78.46	\$79.99	\$111.51	\$112.58	\$122.33
94	\$77.53	\$79.14	\$80.67	\$113.27	\$114.36	\$124.32
96	\$78.22	\$79.82	\$81.80	\$115.18	\$116.28	\$126.36
98	\$78.90	\$80.49	\$83.46	\$117.19	\$118.31	\$128.31
100	\$79.58	\$81.17	\$85.16	\$118.86	\$120.00	\$130.49
105	\$80.26	\$81.85	\$86.84	\$119.55	\$121.24	\$134.21
110	\$80.91	\$82.85	\$89.95	\$121.74	\$126.41	\$139.54
115	\$81.57	\$86.39	\$93.62	\$126.53	\$131.77	\$145.25
120	\$83.59	\$89.17	\$97.83	\$131.32	\$136.87	\$150.83
125	\$85.54	\$92.56	\$101.50	\$136.11	\$142.15	\$156.29
130	\$87.30	\$94.96	\$105.53	\$140.95	\$146.75	\$161.12
135	\$89.18	\$97.67	\$109.34	\$144.80	\$149.91	\$165.58
140	\$91.03	\$99.81	\$112.60	\$149.44	\$154.49	\$170.83
145	\$92.77	\$102.22	\$115.70	\$155.98	\$158.77	\$174.53
150	\$94.68	\$104.39	\$118.95	\$159.18	\$162.05	\$176.79

Multiple-Package Shipments of More Than 150 Pounds*

	Zones					
	51	52	53	54	55	56
Multiple-Package Shipments of 151 to 199 Pounds						
Price Per L	\$0.63	\$0.70	\$0.80	\$1.07	\$1.09	\$1.18
Minimum	\$94.68	\$104.39	\$118.95	\$159.18	\$162.05	\$176.79
Multiple-Package Shipments of 200 to 499 Pounds						
Price Per L	\$0.63	\$0.67	\$0.75	\$1.00	\$1.05	\$1.14
Minimum	\$126.30	\$139.32	\$158.85	\$212.24	\$216.14	\$235.67
Multiple-Package Shipments of 500 Pounds or More						
Price Per L	\$0.53	\$0.63	\$0.73	\$0.93	\$0.97	\$1.11
Minimum	\$313.44	\$333.03	\$375.47	\$499.54	\$522.39	\$568.10

Any fraction of a pound more than the weight shown in the rate chart is rounded up to the next listed weight.

*UPS offers customized rate sheets identifying its firm offer of rates and prices for transportation rates and prices. The rates and prices identified in the rate sheets will be guaranteed for 12-month periods and increase only with approval by the Lead State. Other fees and charges that may impact an authorized user's invoice are identified in UPS's Rate and Service Guide and as described in UPS's Tariff/Terms and Conditions of Service, in effect at the time of shipping. These fees and charges are subject to change without notice. In accordance with the conditions of the solicitation, UPS has waived all pick-up charges, including on-call/on-demand, and capped fuel surcharges at 7%. Fuel surcharge information is posted on UPS's website, www.ups.com.

NASPO ValuePoint

UPS Standard to Mexico® - Export

The rates shown are for shipments originating in the United States.

Package*

	Zones						
	32	33	34	35	36	37	38
1	\$49.48	\$49.86	\$51.01	\$51.45	\$51.89	\$52.11	\$52.23
2	\$52.79	\$53.75	\$54.20	\$55.01	\$55.11	\$55.48	\$55.57
3	\$56.57	\$58.00	\$58.29	\$58.65	\$58.75	\$59.65	\$59.72
4	\$59.58	\$59.87	\$60.25	\$60.61	\$60.88	\$62.69	\$62.87
5	\$59.88	\$61.24	\$61.64	\$62.70	\$63.58	\$64.93	\$65.03
6	\$63.59	\$63.77	\$64.12	\$65.30	\$67.52	\$67.53	\$67.54
7	\$64.95	\$65.18	\$65.59	\$66.71	\$67.57	\$69.29	\$69.49
8	\$65.13	\$66.52	\$66.74	\$68.06	\$69.01	\$73.22	\$73.53
9	\$67.50	\$69.02	\$69.10	\$69.52	\$71.32	\$74.23	\$76.21
10	\$69.29	\$70.77	\$70.88	\$71.31	\$73.04	\$75.91	\$77.94
11	\$72.56	\$72.70	\$72.92	\$74.40	\$76.49	\$79.46	\$81.43
12	\$73.28	\$74.87	\$75.00	\$75.36	\$77.09	\$79.83	\$81.90
13	\$75.24	\$76.82	\$77.01	\$77.40	\$79.08	\$81.82	\$83.91
14	\$78.64	\$78.84	\$79.08	\$79.34	\$80.98	\$85.46	\$86.15
15	\$79.12	\$80.96	\$81.16	\$82.47	\$83.48	\$86.42	\$88.98
16	\$79.59	\$81.51	\$81.86	\$83.01	\$84.39	\$89.20	\$90.19
17	\$81.52	\$83.60	\$83.86	\$85.24	\$87.02	\$91.18	\$93.00
18	\$82.31	\$84.75	\$84.97	\$85.70	\$88.41	\$91.71	\$94.74
19	\$82.50	\$85.03	\$85.40	\$86.14	\$88.65	\$92.01	\$95.25
20	\$83.30	\$85.19	\$85.55	\$89.13	\$90.21	\$93.62	\$97.13
21	\$87.89	\$89.26	\$89.54	\$89.73	\$93.01	\$96.55	\$100.19
22	\$90.55	\$92.07	\$92.51	\$94.84	\$95.97	\$99.73	\$103.62
23	\$92.74	\$94.34	\$94.82	\$97.25	\$98.67	\$102.41	\$106.52
24	\$94.98	\$96.51	\$97.29	\$99.77	\$101.22	\$105.30	\$109.48
25	\$95.18	\$96.89	\$97.59	\$101.93	\$103.52	\$107.59	\$112.20
26	\$99.15	\$101.07	\$101.84	\$104.11	\$105.69	\$111.88	\$115.00
27	\$100.99	\$102.96	\$103.46	\$104.32	\$107.93	\$112.47	\$117.50
28	\$102.20	\$104.91	\$105.86	\$108.32	\$113.44	\$115.99	\$120.21
29	\$102.36	\$105.88	\$107.65	\$108.45	\$113.80	\$117.10	\$123.17
30	\$102.66	\$106.43	\$108.33	\$108.72	\$114.35	\$117.65	\$123.95
31	\$102.84	\$106.84	\$108.39	\$108.86	\$114.64	\$118.11	\$124.30
32	\$103.39	\$106.97	\$109.14	\$109.63	\$115.17	\$120.11	\$126.43
33	\$105.28	\$109.13	\$111.35	\$113.30	\$117.65	\$122.63	\$129.25
34	\$106.83	\$109.27	\$113.10	\$113.93	\$119.66	\$124.79	\$131.65
35	\$108.63	\$113.43	\$115.03	\$115.88	\$121.81	\$127.08	\$134.12
36	\$110.51	\$115.32	\$117.27	\$120.36	\$124.12	\$129.48	\$136.75
37	\$115.72	\$118.42	\$120.56	\$123.50	\$126.77	\$131.72	\$138.29
38	\$118.91	\$121.59	\$123.70	\$125.77	\$129.92	\$134.89	\$141.49
39	\$120.07	\$122.99	\$124.27	\$126.23	\$131.98	\$136.94	\$143.50
40	\$120.27	\$123.82	\$124.88	\$127.92	\$133.46	\$138.50	\$145.12
41	\$122.33	\$127.67	\$129.57	\$129.93	\$135.66	\$140.73	\$147.37
42	\$124.37	\$129.02	\$129.92	\$131.95	\$137.66	\$142.70	\$149.13
43	\$125.55	\$129.38	\$130.28	\$135.71	\$138.88	\$143.87	\$150.41
44	\$127.46	\$130.99	\$133.73	\$136.67	\$139.60	\$144.64	\$151.25
45	\$128.24	\$132.10	\$134.06	\$137.02	\$140.04	\$145.09	\$151.71
46	\$130.37	\$132.26	\$135.06	\$137.16	\$140.97	\$146.04	\$152.54
47	\$132.35	\$135.03	\$137.18	\$137.45	\$143.00	\$148.05	\$154.55
48	\$132.48	\$136.28	\$138.26	\$139.41	\$144.98	\$150.05	\$156.58
49	\$133.94	\$136.61	\$138.60	\$141.27	\$146.91	\$151.90	\$158.40
50	\$135.38	\$138.04	\$140.08	\$142.81	\$148.31	\$153.39	\$159.85

Any fraction of a pound more than the weight shown in the rate chart is rounded up to the next listed weight.

	Zones						
	32	33	34	35	36	37	38
52	138.501	140.751	143.829	145.548	151.749	155.862	162.351
54	142.848	145.62	149.139	150.498	156.573	158.157	162.936
56	146.835	148.779	153.468	154.008	161.307	161.946	168.039
58	148.311	150.507	154.323	155.853	163.584	165.825	171.909
60	151.632	154.044	156.33	159.48	164.331	169.38	175.536
62	154.854	157.383	159.615	162.711	169.407	172.602	178.749
64	160.362	162.441	163.053	166.023	171.729	178.443	183.834
66	160.704	163.143	165.582	169.218	172.314	181.548	186.957
68	163.647	166.257	168.696	172.305	175.284	184.491	190.035
70	167.022	169.407	173.709	175.527	178.371	187.704	193.122
72	170.199	172.557	175.23	178.605	181.575	190.791	196.101
74	174.285	178.974	179.478	181.8	184.455	193.887	199.17
76	175.14	179.37	180.153	184.743	187.488	198.018	202.662
78	176.985	179.46	185.994	187.956	192.087	199.845	204.525
80	178.506	180.981	186.993	188.361	193.743	201.474	206.19
82	180.531	182.88	187.857	190.107	195.444	203.211	207.783
84	183.474	185.94	188.262	193.068	198.369	205.911	210.618
86	186.57	191.844	193.734	196.83	201.294	208.944	213.516
88	189.45	191.988	194.265	198.72	204.066	211.662	216.189
90	192.411	194.904	197.28	201.636	206.928	214.83	218.97
92	194.634	201.825	202.059	203.931	208.989	216.918	221.22
94	197.901	202.932	205.119	206.784	211.815	219.69	224.001
96	200.574	203.202	205.488	209.097	213.903	221.769	226.062
98	203.247	205.047	207.855	211.23	215.901	223.704	228.222
100	206.37	207.612	210.807	213.741	218.385	226.224	230.787
105	214.227	215.766	218.502	221.301	225.756	233.523	238.014
110	222.795	224.055	226.179	228.852	233.253	241.2	245.934
115	229.176	230.589	232.938	235.269	239.796	247.833	252.558
120	235.755	237.258	239.553	241.614	246.402	254.592	259.407
125	242.532	243.864	246.402	248.031	252.81	261.027	265.923
130	249.075	250.686	253.197	254.628	259.254	267.615	272.529
135	255.636	257.616	260.163	261.054	265.752	274.059	278.874
140	262.413	264.69	267.219	267.939	272.511	280.539	285.606
145	269.64	272.124	274.86	275.031	279.531	287.532	292.743
150	276.642	279.648	282.429	283.401	286.704	294.543	299.799

Multiple-Package Shipments of More Than 150 Pounds*

	Zones						
	32	33	34	35	36	37	38
Multiple-Package Shipments of 151 to 199 Pounds							
Price Per L	\$1.85	\$1.87	\$1.89	\$1.89	\$1.92	\$1.97	\$2.01
Minimum	\$276.64	\$279.65	\$282.43	\$283.40	\$286.70	\$294.54	\$299.80
Multiple-Package Shipments of 200 Pounds or More							
Price Per L	\$1.79	\$1.82	\$1.84	\$1.84	\$1.86	\$1.91	\$1.94
Minimum	\$407.95	\$413.92	\$417.90	\$417.90	\$423.87	\$435.81	\$443.77

*UPS offers customized rate sheets identifying its firm offer of rates and prices for transportation rates and prices. The rates and prices identified in the rate sheets will be guaranteed for 12-month periods and increase only with approval by the Lead State. Other fees and charges that may impact an authorized user's invoice are identified in UPS's Rate and Service Guide and as described in UPS's Tariff/Terms and Conditions of Service, in effect at the time of shipping. These fees and charges are subject to change without notice. In accordance with the conditions of the solicitation, UPS has waived all pick-up charges, including on-call/on-demand, and capped fuel surcharges at 7%. Fuel surcharge information is posted on UPS's website, www.ups.com.

NASPO ValuePoint

UPS Worldwide Express® - Import

The rates shown are for shipments to the United States, billed to a U.S. UPS account number.

Letter/Document*

	Zones															
	91	94	951	952	953	954	955	956	957	958	959	961	962	963	970	971
Letter*	\$50.69	\$50.87	\$87.73	\$74.08	\$94.32	\$71.08	\$102.08	\$71.50	\$87.48	\$95.88	\$73.30	\$81.94	\$63.55	\$73.30	\$69.70	\$67.12
1	\$73.90	\$54.66	\$102.14	\$82.46	\$121.69	\$89.54	\$120.05	\$81.41	\$110.38	\$120.53	\$92.66	\$89.19	\$79.16	\$92.76	\$80.65	\$80.50
2	\$75.29	\$55.23	\$104.69	\$85.02	\$123.76	\$94.99	\$151.86	\$102.70	\$132.04	\$152.32	\$97.07	\$108.72	\$86.83	\$104.25	\$82.88	\$101.55
3	\$102.21	\$77.19	\$155.22	\$132.26	\$180.74	\$141.93	\$251.51	\$150.37	\$190.97	\$239.72	\$146.45	\$148.74	\$140.74	\$146.45	\$123.48	\$132.85
4	\$112.36	\$83.53	\$175.02	\$145.65	\$200.48	\$160.23	\$289.83	\$172.82	\$213.27	\$288.14	\$165.90	\$168.98	\$162.32	\$165.90	\$140.10	\$152.55
5	\$122.58	\$90.35	\$195.62	\$159.05	\$220.23	\$179.00	\$328.11	\$198.05	\$242.87	\$314.88	\$181.08	\$196.86	\$178.31	\$181.08	\$150.99	\$171.70
6	\$135.80	\$96.17	\$211.33	\$174.42	\$243.18	\$195.73	\$364.76	\$219.65	\$264.99	\$351.67	\$196.09	\$213.24	\$197.45	\$196.09	\$167.34	\$185.80
7	\$142.38	\$103.50	\$224.60	\$187.65	\$262.21	\$212.68	\$402.44	\$238.79	\$288.59	\$393.46	\$212.73	\$234.91	\$216.11	\$212.73	\$180.93	\$203.67
8	\$152.26	\$106.85	\$239.02	\$200.65	\$279.00	\$230.38	\$446.45	\$260.64	\$311.59	\$435.56	\$229.81	\$250.37	\$233.48	\$229.81	\$192.57	\$218.07
9	\$161.70	\$112.19	\$249.94	\$213.69	\$298.49	\$248.11	\$474.70	\$280.12	\$331.39	\$473.04	\$247.63	\$269.97	\$251.17	\$247.63	\$205.27	\$235.81
10	\$171.41	\$116.32	\$257.04	\$226.72	\$316.39	\$254.75	\$494.05	\$291.17	\$355.37	\$513.94	\$255.96	\$285.20	\$262.84	\$255.96	\$217.93	\$239.34

Non-Document

	Zones															
	91	94	951	952	953	954	955	956	957	958	959	961	962	963	970	971
1	\$86.20	\$63.92	\$146.91	\$103.14	\$158.88	\$120.36	\$180.71	\$113.63	\$152.62	\$170.37	\$121.85	\$131.97	\$112.53	\$121.85	\$96.06	\$102.64
2	\$97.57	\$71.64	\$167.63	\$123.61	\$181.63	\$141.08	\$216.23	\$136.32	\$177.90	\$205.15	\$139.04	\$154.74	\$129.81	\$140.17	\$115.53	\$119.05
3	\$108.78	\$80.06	\$183.95	\$138.04	\$200.41	\$163.05	\$262.19	\$156.68	\$212.77	\$254.72	\$162.04	\$174.73	\$147.54	\$162.04	\$128.83	\$135.99
4	\$119.32	\$86.62	\$205.95	\$152.30	\$229.74	\$186.44	\$302.32	\$180.24	\$245.05	\$293.55	\$178.78	\$194.59	\$164.95	\$178.78	\$142.36	\$153.90
5	\$129.87	\$93.70	\$223.46	\$166.81	\$248.17	\$205.68	\$342.26	\$204.71	\$269.87	\$326.22	\$195.20	\$214.63	\$181.13	\$195.20	\$155.64	\$174.30
6	\$140.88	\$99.74	\$238.02	\$179.24	\$264.05	\$226.54	\$380.47	\$226.41	\$292.18	\$362.64	\$211.61	\$230.58	\$199.70	\$211.61	\$171.43	\$188.79
7	\$147.62	\$106.85	\$251.37	\$192.96	\$279.95	\$247.53	\$419.77	\$248.91	\$314.49	\$407.95	\$225.39	\$247.69	\$218.16	\$225.39	\$181.03	\$206.42
8	\$157.60	\$110.82	\$264.49	\$207.11	\$301.51	\$267.82	\$465.68	\$288.67	\$337.55	\$443.77	\$240.63	\$272.78	\$236.59	\$240.63	\$193.76	\$221.14
9	\$167.36	\$116.34	\$276.29	\$219.84	\$320.89	\$285.76	\$495.14	\$288.93	\$359.78	\$485.83	\$258.36	\$289.94	\$255.07	\$258.36	\$208.45	\$238.77
10	\$177.74	\$120.26	\$282.26	\$233.62	\$341.33	\$287.73	\$506.93	\$300.17	\$384.28	\$532.87	\$266.73	\$301.05	\$271.15	\$266.73	\$219.17	\$242.32
11	\$187.95	\$123.44	\$282.86	\$235.36	\$349.77	\$289.80	\$517.35	\$302.91	\$405.20	\$534.38	\$267.34	\$311.94	\$272.57	\$267.34	\$220.66	\$245.44
12	\$192.38	\$123.71	\$285.05	\$237.11	\$353.92	\$297.34	\$523.65	\$305.46	\$418.94	\$542.27	\$269.95	\$314.75	\$281.84	\$273.89	\$228.15	\$247.39
13	\$202.40	\$140.41	\$327.14	\$271.98	\$407.06	\$350.99	\$630.17	\$354.66	\$450.31	\$620.29	\$315.51	\$353.74	\$325.67	\$315.51	\$254.70	\$280.01
14	\$213.68	\$146.31	\$339.29	\$284.64	\$417.42	\$370.29	\$660.35	\$369.89	\$471.79	\$636.34	\$334.69	\$369.40	\$350.06	\$334.69	\$263.58	\$296.88
15	\$221.10	\$149.55	\$350.19	\$297.32	\$434.49	\$390.53	\$689.86	\$391.93	\$492.80	\$666.90	\$348.34	\$386.58	\$368.13	\$348.34	\$277.89	\$311.42
16	\$227.29	\$156.67	\$362.37	\$309.47	\$452.30	\$403.31	\$715.73	\$405.10	\$516.66	\$705.09	\$358.83	\$393.22	\$390.61	\$358.83	\$289.22	\$329.50
17	\$235.31	\$161.69	\$373.29	\$321.56	\$470.12	\$421.20	\$743.91	\$411.69	\$537.66	\$727.70	\$372.75	\$407.68	\$396.19	\$372.75	\$300.63	\$341.44
18	\$241.99	\$169.41	\$384.23	\$333.71	\$487.94	\$436.07	\$767.83	\$427.47	\$557.69	\$753.45	\$379.74	\$424.87	\$425.64	\$379.74	\$308.97	\$357.70
19	\$248.93	\$170.74	\$395.17	\$345.85	\$517.39	\$452.45	\$799.78	\$438.49	\$579.20	\$776.00	\$395.12	\$438.16	\$443.66	\$395.12	\$320.04	\$370.99
20	\$256.57	\$174.29	\$404.65	\$357.98	\$523.59	\$464.48	\$819.95	\$449.50	\$594.54	\$784.06	\$402.86	\$453.74	\$463.39	\$402.86	\$331.34	\$385.53
21	\$261.44	\$179.22	\$411.35	\$369.99	\$553.87	\$469.08	\$820.31	\$454.82	\$620.22	\$827.36	\$411.14	\$455.95	\$479.21	\$411.14	\$345.48	\$391.62
22	\$267.86	\$182.87	\$414.80	\$379.53	\$559.24	\$469.49	\$821.74	\$458.02	\$640.96	\$840.23	\$411.38	\$458.19	\$485.15	\$411.38	\$354.49	\$393.15
23	\$274.20	\$183.23	\$415.03	\$380.07	\$571.91	\$470.00	\$824.61	\$461.94	\$656.69	\$840.74	\$431.70	\$467.87	\$485.46	\$431.70	\$354.89	\$403.27
24	\$277.90	\$183.46	\$415.25	\$380.71	\$573.17	\$472.85	\$824.92	\$462.40	\$677.08	\$841.30	\$431.95	\$469.54	\$487.46	\$431.95	\$363.93	\$414.77
25	\$279.40	\$185.19	\$417.92	\$382.82	\$577.76	\$485.77	\$831.14	\$465.49	\$685.83	\$860.46	\$435.24	\$472.84	\$498.90	\$435.24	\$365.54	\$417.03
26	\$291.19	\$206.85	\$468.96	\$421.34	\$627.71	\$560.39	\$955.50	\$507.23	\$719.37	\$923.93	\$465.27	\$530.28	\$556.45	\$465.27	\$393.42	\$447.53
27	\$296.05	\$216.62	\$481.40	\$440.38	\$644.85	\$602.54	\$976.41	\$539.67	\$738.74	\$956.36	\$474.93	\$545.79	\$576.73	\$474.93	\$411.65	\$477.06
28	\$302.47	\$222.36	\$492.09	\$452.01	\$677.20	\$607.79	\$997.29	\$552.14	\$757.24	\$964.31	\$484.52	\$557.24	\$591.21	\$484.52	\$422.48	\$488.52
29	\$308.19	\$228.13	\$500.96	\$463.60	\$694.63	\$623.97	\$1,026.82	\$571.62	\$773.96	\$1,006.93	\$499.27	\$569.77	\$612.56	\$499.27	\$433.19	\$500.00
30	\$314.15	\$229.54	\$511.60	\$475.24	\$696.38	\$634.46	\$1,046.48	\$583.56	\$790.31	\$1,022.75	\$510.13	\$581.63	\$622.40	\$510.13	\$444.02	\$510.98
31	\$320.00	\$236.53	\$522.21	\$485.80	\$707.63	\$648.47	\$1,064.59	\$589.45	\$804.74	\$1,027.89	\$520.82	\$594.53	\$624.95	\$520.82	\$454.00	\$521.47
32	\$325.64	\$241.73	\$530.94	\$496.38	\$735.56	\$654.60	\$1,087.98	\$609.90	\$817.11	\$1,029.49	\$525.80	\$609.39	\$649.11	\$525.80	\$463.89	\$532.47
33	\$330.35	\$243.67	\$537.72	\$498.05	\$740.44	\$686.56	\$1,108.73	\$621.33	\$829.23	\$1,061.18	\$535.71	\$619.32	\$658.59	\$535.71	\$465.44	\$541.35
34	\$335.12	\$248.36	\$546.44	\$516.91	\$741.89	\$690.16	\$1,122.49	\$625.06	\$840.42	\$1,090.10	\$546.98	\$629.10	\$678.39	\$546.98	\$483.08	\$552.21
35	\$339.83	\$255.70	\$556.34	\$521.24	\$770.63	\$708.53	\$1,143.33	\$637.02	\$850.29	\$1,130.58	\$554.93	\$637.07	\$698.93	\$554.93	\$487.02	\$561.10
36	\$344.57	\$260.05	\$565.75	\$538.64	\$779.20	\$730.40	\$1,164.20	\$649.04	\$860.26	\$1,136.21	\$559.51	\$653.34	\$713.77	\$559.51	\$503.40	\$573.44
37	\$350.06	\$265.33	\$574.61	\$549.22	\$780.09	\$746.33	\$1,187.56	\$661.00	\$869.89	\$1,142.24	\$569.30	\$664.80	\$715.92	\$569.30	\$513.29	\$584.67
38	\$350.62	\$270.29	\$583.38	\$559.39	\$797.29	\$769.07	\$1,205.93	\$674.28	\$880.57	\$1,161.32	\$595.22	\$677.46	\$729.30	\$595.22	\$522.68	\$594.42
39	\$358.74	\$275.13	\$592.08	\$563.05	\$799.02	\$785.56	\$1,231.79	\$686.30	\$890.67	\$1,177.40	\$617.30	\$695.06	\$749.69	\$617.30	\$526.16	\$604.93
40	\$363.46	\$279.80	\$600.81	\$570.70	\$810.44	\$801.34	\$1,251.74	\$703.81	\$900.41	\$1,206.41	\$627.19	\$707.83	\$756.01	\$627.19	\$533.36	\$615.17
41	\$367.74	\$282.39	\$609.35	\$590.73	\$839.54	\$817.45	\$1,270.07	\$715.89	\$919.54	\$1,226.63	\$641.75	\$716.63	\$772.31	\$641.75	\$551.58	\$625.15
42	\$372.07	\$289.46	\$617.84	\$601.59	\$850.07	\$829.29	\$1,290.05	\$732.82	\$929.39	\$1,250.38	\$655.84	\$727.26	\$782.77	\$655.84	\$562.20	\$635.54
43	\$379.50	\$294.40	\$626.34	\$602.35	\$857.42	\$865.07	\$1,310.71	\$740.74	\$940.45	\$1,265.28	\$663.31	\$739.34	\$796.13	\$663.31	\$562.45	\$645.91
44	\$380.74	\$299.10	\$634.82	\$619.63	\$858.15	\$873.38	\$1,327.97	\$752.17	\$949.93	\$1,272.99	\$685.95	\$751.15	\$798.49	\$685.95	\$579.43	\$655.52
45	\$385.09	\$304.43	\$643.39	\$621.05	\$861.80	\$874.57	\$1,350.73	\$756.37	\$960.75	\$1,298.41	\$691.03	\$763.53	\$845.54	\$691.03	\$579.89	\$666.02
46	\$389.42	\$309.00	\$651.89	\$631.52	\$868.83	\$898.08	\$1,378.01	\$776.67	\$979.28	\$1,341.71	\$691.47	\$770.06	\$851.60	\$691.47	\$592.16	\$674.89
47	\$393.77	\$313.96	\$657.99	\$653.15	\$894.65	\$909.51	\$1,404.21	\$780.17	\$990.33	\$1,346.04	\$691.77	\$781.58	\$852.70	\$691.77	\$614.50	\$684.29
48	\$398.09	\$315.09	\$668.89	\$658.40	\$895.89	\$935.74	\$1,424.36	\$792.07	\$1,000.78	\$1,348.05	\$692.51	\$803.84	\$874.13	\$692.51	\$616.00	\$695.26
49	\$400.14	\$322.34	\$669.97	\$672.57	\$920.44	\$946.49	\$1,445.40	\$803.95	\$1,010.54	\$1,388.03	\$706.97	\$805.98	\$876.28	\$706.97	\$625.01	\$703.66
50	\$400.68	\$326.79	\$671.07	\$677.71												

86	\$567.36	\$538.90	\$977.83	\$1,017.21	\$1,282.48	\$1,503.47	\$2,208.32	\$1,195.37	\$1,457.97	\$2,173.15	\$1,166.99	\$1,268.76	\$1,470.87	\$1,166.99	\$949.81	\$1,059.75
88	\$575.17	\$539.50	\$1,001.85	\$1,035.45	\$1,300.05	\$1,504.11	\$2,247.89	\$1,201.04	\$1,488.45	\$2,176.98	\$1,167.58	\$1,283.90	\$1,501.05	\$1,167.58	\$966.82	\$1,079.37
90	\$582.44	\$545.32	\$1,027.40	\$1,036.96	\$1,301.82	\$1,513.36	\$2,302.21	\$1,213.17	\$1,512.26	\$2,234.85	\$1,190.93	\$1,308.95	\$1,550.42	\$1,190.93	\$968.25	\$1,095.41
92	\$591.20	\$556.23	\$1,035.86	\$1,046.75	\$1,302.35	\$1,526.09	\$2,331.46	\$1,248.85	\$1,513.74	\$2,244.58	\$1,229.19	\$1,343.95	\$1,558.93	\$1,229.19	\$977.39	\$1,111.21
94	\$599.27	\$558.13	\$1,041.98	\$1,059.69	\$1,302.97	\$1,538.18	\$2,343.80	\$1,261.22	\$1,547.72	\$2,249.15	\$1,243.26	\$1,353.20	\$1,572.60	\$1,243.26	\$994.66	\$1,127.50
96	\$607.10	\$576.25	\$1,054.72	\$1,073.66	\$1,307.37	\$1,547.59	\$2,387.75	\$1,273.69	\$1,578.83	\$2,353.52	\$1,245.74	\$1,368.33	\$1,587.83	\$1,245.74	\$1,002.51	\$1,148.00
98	\$616.81	\$581.57	\$1,074.62	\$1,082.82	\$1,309.33	\$1,548.86	\$2,434.16	\$1,275.15	\$1,598.90	\$2,362.21	\$1,259.25	\$1,378.79	\$1,608.29	\$1,259.25	\$1,038.47	\$1,166.38
100	\$626.63	\$609.36	\$1,104.36	\$1,172.76	\$1,371.17	\$1,549.31	\$2,467.64	\$1,310.46	\$1,631.33	\$2,364.32	\$1,289.76	\$1,420.74	\$1,616.95	\$1,289.76	\$1,055.30	\$1,185.33
105	\$655.48	\$659.13	\$1,159.65	\$1,228.36	\$1,440.25	\$1,665.57	\$2,595.56	\$1,373.26	\$1,716.85	\$2,481.87	\$1,375.19	\$1,492.13	\$1,705.30	\$1,375.19	\$1,130.60	\$1,234.39
110	\$684.96	\$690.52	\$1,214.87	\$1,286.86	\$1,507.30	\$1,744.88	\$2,714.05	\$1,438.47	\$1,795.99	\$2,597.49	\$1,427.07	\$1,559.50	\$1,786.50	\$1,427.07	\$1,210.14	\$1,282.59
115	\$717.44	\$721.91	\$1,270.08	\$1,345.34	\$1,575.30	\$1,824.18	\$2,834.27	\$1,502.93	\$1,857.66	\$2,713.35	\$1,506.13	\$1,628.81	\$1,867.71	\$1,506.13	\$1,261.60	\$1,337.06
120	\$745.31	\$753.29	\$1,325.30	\$1,403.83	\$1,640.17	\$1,891.67	\$2,956.72	\$1,567.38	\$1,919.69	\$2,828.64	\$1,563.70	\$1,708.12	\$1,948.66	\$1,563.70	\$1,316.39	\$1,394.36
125	\$773.10	\$784.67	\$1,380.52	\$1,462.32	\$1,706.01	\$1,970.05	\$3,082.81	\$1,630.45	\$1,982.48	\$2,945.68	\$1,627.70	\$1,791.19	\$2,028.96	\$1,627.70	\$1,370.93	\$1,447.51
130	\$800.63	\$816.07	\$1,435.73	\$1,520.80	\$1,782.71	\$2,044.80	\$3,203.85	\$1,695.66	\$2,044.15	\$3,062.25	\$1,688.03	\$1,856.63	\$2,096.69	\$1,688.03	\$1,425.58	\$1,499.02
135	\$829.39	\$847.44	\$1,490.96	\$1,579.29	\$1,846.61	\$2,120.29	\$3,325.55	\$1,759.61	\$2,105.33	\$3,179.31	\$1,744.97	\$1,924.73	\$2,155.04	\$1,744.97	\$1,480.26	\$1,552.28
140	\$856.30	\$878.83	\$1,546.17	\$1,637.79	\$1,909.32	\$2,196.29	\$3,447.12	\$1,824.33	\$2,183.71	\$3,295.40	\$1,806.20	\$1,986.34	\$2,219.82	\$1,806.20	\$1,534.57	\$1,606.16
145	\$884.61	\$910.21	\$1,601.39	\$1,696.28	\$1,974.30	\$2,273.16	\$3,567.69	\$1,889.91	\$2,245.25	\$3,411.63	\$1,869.10	\$2,048.09	\$2,291.00	\$1,869.10	\$1,589.35	\$1,658.65
150	\$928.49	\$937.67	\$1,656.61	\$1,754.78	\$2,037.99	\$2,348.28	\$3,688.38	\$1,955.37	\$2,307.05	\$3,524.89	\$1,921.94	\$2,117.89	\$2,362.32	\$1,921.94	\$1,635.29	\$1,713.27

Shipments of More Than 150 Pounds* (non-pallet)

	Zones															
	91	94	951	952	953	954	955	956	957	958	959	961	962	963	970	971
Price Per L	\$6.19	\$6.26	\$11.05	\$11.70	\$13.59	\$15.66	\$24.60	\$13.04	\$15.38	\$23.51	\$12.82	\$14.12	\$15.75	\$12.82	\$10.91	\$11.43
Minimum	\$928.49	\$937.67	\$1,656.61	\$1,754.78	\$2,037.99	\$2,348.28	\$3,688.38	\$1,955.37	\$2,307.05	\$3,524.89	\$1,921.94	\$2,117.89	\$2,362.32	\$1,921.94	\$1,635.29	\$1,713.27

Any fraction of a pound more than the weight shown in the rate chart is rounded up to the next listed weight.

*UPS offers customized rate sheets identifying its firm offer of rates and prices for transportation rates and prices. The rates and prices identified in the rate sheets will be guaranteed for 12-month periods and increase only with approval by the Lead State. Other fees and charges that may impact an authorized user's invoice are identified in UPS's Rate and Service Guide and as described in UPS's Tariff/Terms and Conditions of Service, in effect at the time of shipping. These fees and charges are subject to change without notice. In accordance with the conditions of the solicitation, UPS has waived all pick-up charges, including on-call/on-demand, and capped fuel surcharges at 7%. Fuel surcharge information is posted on UPS's website, www.ups.com.

NASPO ValuePoint

UPS Worldwide Saver® - Import

The rates shown are for shipments to the United States, billed to a U.S. UPS account number.

Letter/Document*

	Zones															
	491	494	451	452	453	454	455	456	457	458	459	461	462	463	470	471
Letter*	\$49.28	\$49.88	\$85.60	\$71.92	\$91.57	\$68.68	\$101.01	\$69.41	\$82.61	\$91.47	\$67.96	\$79.08	\$61.92	\$68.79	\$66.37	\$63.53
1	\$68.93	\$52.81	\$99.24	\$79.76	\$117.29	\$86.13	\$111.08	\$79.54	\$104.20	\$109.61	\$90.61	\$85.71	\$73.51	\$90.61	\$74.82	\$75.65
2	\$71.96	\$53.36	\$100.71	\$81.26	\$119.22	\$87.62	\$137.78	\$100.36	\$124.82	\$137.99	\$93.41	\$105.54	\$81.32	\$101.00	\$78.56	\$92.58
3	\$99.23	\$74.58	\$151.43	\$129.65	\$177.19	\$137.05	\$246.57	\$147.42	\$187.24	\$233.87	\$141.35	\$144.41	\$133.44	\$141.35	\$115.82	\$123.54
4	\$109.08	\$80.69	\$170.76	\$142.79	\$196.54	\$154.76	\$284.13	\$169.43	\$209.09	\$281.12	\$160.11	\$164.05	\$153.88	\$160.11	\$131.76	\$144.99
5	\$119.01	\$87.28	\$190.85	\$155.92	\$215.91	\$172.91	\$321.68	\$194.17	\$238.10	\$306.95	\$174.81	\$191.12	\$169.06	\$174.81	\$143.43	\$163.50
6	\$128.75	\$92.91	\$206.16	\$170.99	\$238.41	\$189.67	\$357.60	\$215.34	\$259.79	\$341.22	\$191.70	\$207.02	\$186.50	\$191.70	\$160.79	\$177.58
7	\$138.22	\$99.99	\$219.11	\$183.97	\$257.06	\$207.44	\$394.54	\$234.11	\$282.93	\$383.85	\$208.03	\$228.07	\$204.08	\$208.03	\$174.53	\$194.27
8	\$147.56	\$103.24	\$233.19	\$196.70	\$273.52	\$224.57	\$437.70	\$255.52	\$305.48	\$424.93	\$224.72	\$243.07	\$220.67	\$224.72	\$183.84	\$207.87
9	\$156.99	\$108.39	\$243.84	\$209.49	\$292.64	\$242.08	\$465.39	\$274.62	\$324.90	\$461.49	\$242.15	\$262.10	\$238.00	\$242.15	\$197.60	\$224.78
10	\$166.42	\$112.37	\$250.77	\$222.26	\$310.19	\$248.36	\$484.36	\$285.45	\$348.39	\$501.39	\$250.24	\$276.89	\$249.11	\$250.24	\$211.54	\$225.15

Non-Document

	Zones															
	491	494	451	452	453	454	455	456	457	458	459	461	462	463	470	471
1	\$41.29	\$31.45	\$72.19	\$49.91	\$78.93	\$59.17	\$88.81	\$55.83	\$75.13	\$84.23	\$57.97	\$62.88	\$54.15	\$59.53	\$45.66	\$47.92
2	\$46.76	\$35.25	\$82.38	\$59.80	\$90.23	\$69.96	\$106.19	\$67.03	\$87.43	\$101.42	\$68.07	\$74.13	\$61.92	\$68.07	\$54.35	\$56.94
3	\$52.14	\$39.39	\$90.40	\$66.79	\$99.57	\$80.86	\$128.77	\$76.99	\$104.27	\$124.64	\$77.87	\$83.66	\$70.50	\$77.87	\$61.26	\$65.20
4	\$57.31	\$42.61	\$101.22	\$73.68	\$114.14	\$91.58	\$148.59	\$88.46	\$119.58	\$143.83	\$86.09	\$93.18	\$78.74	\$86.09	\$67.51	\$74.08
5	\$62.54	\$46.10	\$109.83	\$80.71	\$123.30	\$101.99	\$168.15	\$100.62	\$131.66	\$161.29	\$93.77	\$102.14	\$86.58	\$93.77	\$74.48	\$84.18
6	\$67.65	\$49.07	\$116.98	\$87.12	\$131.19	\$112.34	\$187.01	\$111.54	\$142.54	\$179.29	\$102.30	\$108.19	\$95.54	\$102.30	\$82.92	\$91.13
7	\$72.63	\$52.57	\$123.54	\$93.72	\$139.09	\$122.75	\$206.33	\$122.45	\$153.47	\$201.70	\$109.12	\$118.72	\$104.22	\$109.12	\$88.71	\$99.73
8	\$77.54	\$54.52	\$130.00	\$100.21	\$149.80	\$131.55	\$226.57	\$132.22	\$165.14	\$217.04	\$116.12	\$129.57	\$112.90	\$116.12	\$93.62	\$106.87
9	\$82.34	\$57.24	\$139.79	\$106.73	\$159.43	\$140.40	\$243.37	\$142.10	\$176.07	\$239.84	\$124.72	\$137.78	\$121.69	\$124.72	\$101.63	\$115.33
10	\$87.45	\$59.17	\$138.73	\$113.23	\$169.58	\$141.33	\$247.20	\$147.71	\$188.04	\$263.46	\$128.55	\$144.00	\$128.52	\$128.55	\$107.30	\$115.78
11	\$92.11	\$59.56	\$139.74	\$115.08	\$173.78	\$143.42	\$251.67	\$149.04	\$198.34	\$264.21	\$128.77	\$146.20	\$130.65	\$130.20	\$108.22	\$116.01
12	\$93.03	\$60.10	\$140.82	\$115.93	\$175.14	\$147.15	\$256.43	\$150.28	\$204.70	\$266.31	\$132.08	\$148.80	\$135.58	\$134.57	\$111.53	\$119.55
13	\$99.19	\$69.09	\$161.62	\$132.99	\$202.24	\$173.71	\$307.01	\$174.50	\$220.42	\$302.36	\$152.80	\$170.62	\$156.23	\$152.80	\$123.80	\$135.26
14	\$104.73	\$71.99	\$167.62	\$139.18	\$207.39	\$181.85	\$321.71	\$181.99	\$230.91	\$314.61	\$161.65	\$177.25	\$164.67	\$161.65	\$128.72	\$143.30
15	\$108.36	\$73.58	\$173.01	\$145.38	\$215.88	\$191.83	\$336.03	\$191.57	\$241.15	\$329.72	\$167.19	\$186.23	\$173.19	\$167.19	\$136.30	\$150.54
16	\$111.39	\$77.09	\$179.02	\$151.31	\$224.72	\$198.08	\$348.18	\$197.99	\$252.87	\$342.44	\$173.22	\$189.71	\$183.63	\$173.22	\$142.02	\$159.19
17	\$115.33	\$79.55	\$184.42	\$157.23	\$233.58	\$206.88	\$361.89	\$202.52	\$263.11	\$355.92	\$178.77	\$194.78	\$190.01	\$178.77	\$147.28	\$165.03
18	\$118.60	\$83.35	\$189.83	\$163.18	\$242.44	\$214.25	\$373.53	\$209.25	\$271.34	\$367.25	\$182.59	\$203.61	\$200.31	\$182.59	\$150.75	\$172.94
19	\$122.00	\$84.00	\$195.23	\$169.11	\$257.06	\$222.18	\$389.56	\$214.33	\$281.36	\$380.89	\$188.38	\$211.38	\$208.74	\$188.38	\$156.27	\$179.32
20	\$125.75	\$85.75	\$199.92	\$175.05	\$260.14	\$228.14	\$398.89	\$220.82	\$289.76	\$387.65	\$193.96	\$217.34	\$218.02	\$193.96	\$161.83	\$186.32
21	\$128.13	\$88.18	\$202.05	\$180.96	\$275.19	\$228.31	\$399.60	\$223.67	\$303.55	\$401.66	\$196.73	\$217.94	\$222.92	\$196.73	\$169.55	\$189.40
22	\$131.28	\$89.97	\$204.93	\$185.58	\$277.85	\$228.75	\$400.36	\$223.78	\$308.18	\$415.42	\$197.91	\$219.87	\$224.40	\$200.13	\$173.59	\$190.07
23	\$134.39	\$90.15	\$205.04	\$186.04	\$284.14	\$232.13	\$401.15	\$225.08	\$315.56	\$415.68	\$198.28	\$219.98	\$228.61	\$206.46	\$173.97	\$193.78
24	\$136.20	\$90.26	\$205.15	\$186.16	\$284.77	\$233.98	\$401.40	\$227.51	\$322.93	\$415.92	\$198.39	\$220.22	\$230.18	\$211.22	\$178.09	\$200.46
25	\$136.93	\$90.92	\$206.47	\$187.18	\$286.07	\$240.36	\$404.33	\$229.03	\$323.90	\$420.02	\$200.64	\$222.02	\$235.42	\$214.66	\$178.54	\$201.53
26	\$142.71	\$101.77	\$231.69	\$206.93	\$311.88	\$277.87	\$464.84	\$249.56	\$343.12	\$456.81	\$222.49	\$252.58	\$265.34	\$223.46	\$192.66	\$212.39
27	\$145.09	\$106.57	\$237.84	\$215.34	\$320.38	\$289.63	\$475.01	\$265.52	\$346.29	\$468.84	\$229.11	\$261.79	\$272.64	\$229.32	\$200.78	\$224.31
28	\$148.25	\$109.40	\$242.12	\$221.03	\$336.46	\$297.05	\$485.16	\$271.66	\$362.13	\$476.77	\$233.86	\$267.49	\$279.54	\$235.08	\$205.87	\$229.77
29	\$151.05	\$112.25	\$247.50	\$226.70	\$345.12	\$304.90	\$500.18	\$279.18	\$368.36	\$488.93	\$239.11	\$273.22	\$289.28	\$240.27	\$210.84	\$235.25
30	\$153.97	\$112.93	\$252.76	\$232.38	\$345.99	\$312.75	\$509.85	\$284.99	\$370.46	\$500.37	\$244.12	\$278.94	\$294.22	\$245.32	\$215.32	\$240.41
31	\$156.83	\$116.37	\$258.00	\$237.55	\$351.58	\$316.82	\$517.86	\$290.02	\$381.68	\$508.20	\$250.23	\$284.65	\$301.10	\$250.23	\$219.61	\$245.27
32	\$159.60	\$118.94	\$262.32	\$242.72	\$365.45	\$324.59	\$530.14	\$297.68	\$393.57	\$509.00	\$255.63	\$290.35	\$306.83	\$255.63	\$224.39	\$250.44
33	\$161.91	\$119.89	\$265.67	\$243.54	\$367.88	\$334.03	\$539.38	\$304.89	\$396.10	\$524.67	\$260.29	\$296.07	\$311.45	\$260.29	\$226.23	\$254.51
34	\$164.25	\$122.20	\$269.97	\$252.77	\$368.60	\$339.21	\$546.07	\$307.54	\$396.67	\$538.96	\$265.60	\$301.79	\$320.71	\$265.60	\$234.68	\$259.72
35	\$166.55	\$125.80	\$274.87	\$254.88	\$382.88	\$346.96	\$556.21	\$313.42	\$407.92	\$548.95	\$268.39	\$305.82	\$332.29	\$268.39	\$235.65	\$262.91
36	\$168.88	\$127.92	\$279.52	\$263.39	\$387.14	\$357.54	\$566.37	\$319.34	\$411.41	\$559.00	\$272.19	\$313.23	\$337.76	\$272.19	\$245.49	\$269.82
37	\$171.57	\$130.54	\$283.89	\$268.56	\$387.58	\$364.42	\$579.71	\$323.22	\$418.78	\$564.74	\$276.95	\$319.08	\$344.42	\$276.95	\$250.28	\$275.05
38	\$171.84	\$132.99	\$288.23	\$273.54	\$396.12	\$372.45	\$586.67	\$331.76	\$426.16	\$574.17	\$285.18	\$325.29	\$344.77	\$285.18	\$254.15	\$279.61
39	\$175.82	\$135.36	\$292.53	\$275.32	\$396.98	\$379.65	\$600.12	\$337.66	\$435.86	\$582.12	\$289.16	\$330.35	\$353.97	\$289.16	\$255.34	\$284.40
40	\$178.13	\$137.67	\$296.84	\$279.07	\$402.66	\$387.10	\$609.92	\$345.65	\$440.70	\$596.47	\$293.44	\$336.06	\$353.32	\$293.44	\$258.59	\$289.32
41	\$180.24	\$138.94	\$301.06	\$290.12	\$417.11	\$394.49	\$619.72	\$351.65	\$450.11	\$606.46	\$300.05	\$340.22	\$365.11	\$300.05	\$268.13	\$294.06
42	\$182.35	\$142.32	\$305.26	\$294.18	\$422.34	\$402.02	\$629.59	\$357.65	\$454.88	\$618.20	\$301.55	\$345.91	\$370.05	\$301.55	\$273.65	\$298.98
43	\$186.00	\$144.85	\$309.45	\$294.60	\$426.00	\$414.90	\$639.83	\$363.58	\$460.26	\$620.62	\$312.48	\$351.58	\$376.32	\$312.48	\$273.72	\$303.90
44	\$186.60	\$147.16	\$313.65	\$303.00	\$426.37	\$419.83	\$647.73	\$370.08	\$464.95	\$629.39	\$324.89	\$355.62	\$382.66	\$324.89	\$281.07	\$308.51
45	\$188.74	\$149.78	\$317.88	\$303.84	\$428.18	\$427.66	\$659.24	\$372.15	\$470.33	\$641.96	\$329.70	\$357.90	\$398.13	\$329.70	\$281.67	\$313.19
46	\$190.86	\$152.03	\$322.08	\$308.82	\$441.61	\$435.11	\$672.36	\$382.13	\$479.38	\$663.36	\$331.80	\$366.59	\$402.51	\$331.80	\$287.03	\$317.38
47	\$192.99	\$154.47	\$325.09	\$319.39	\$444.50	\$443.01	\$685.31	\$383.85	\$484.75	\$665.50	\$333.52	\$371.90	\$403.01	\$333.52	\$297.19	\$321.87
48	\$195.11	\$155.03	\$330.49	\$320.45	\$445.11	\$447.98	\$694.90	\$389.71	\$489.89	\$666.49	\$336.26	\$376.79	\$413.18	\$336.26	\$298.09	\$327.03
49	\$196.11	\$158.60	\$331.02	\$329.48	\$457.31	\$455.96	\$705.47	\$395.56	\$494.66	\$686.27	\$339.95	\$381.79	\$416.04	\$339.95	\$302.28	\$331.03
50	\$196.37	\$160.78	\$331.56	\$332.75	\$458.53	\$463.50	\$714.51	\$401.41	\$499.97	\$718.29	\$345.89	\$387.03	\$420.20	\$345.89	\$302.80	\$336.06
52	\$204.46	\$165.11	\$349.06													

88	\$282.59	\$267.09	\$497.54	\$508.48	\$645.92	\$735.73	\$1,075.96	\$590.93	\$723.86	\$1,075.64	\$563.36	\$608.34	\$698.28	\$563.36	\$475.46	\$507.89
90	\$287.52	\$270.94	\$507.27	\$508.97	\$646.80	\$742.70	\$1,101.90	\$596.90	\$735.53	\$1,104.24	\$570.17	\$624.78	\$719.53	\$570.17	\$476.05	\$515.46
92	\$292.66	\$276.35	\$514.42	\$512.16	\$647.06	\$746.95	\$1,115.34	\$614.46	\$736.21	\$1,109.04	\$587.99	\$629.98	\$728.74	\$587.99	\$480.67	\$522.71
94	\$297.29	\$277.30	\$517.47	\$518.21	\$647.37	\$751.44	\$1,116.49	\$620.54	\$752.77	\$1,111.30	\$595.54	\$640.68	\$733.24	\$595.54	\$488.82	\$530.59
96	\$302.32	\$286.30	\$523.79	\$527.12	\$649.55	\$756.07	\$1,139.06	\$626.67	\$767.91	\$1,160.43	\$597.06	\$645.63	\$743.19	\$597.06	\$492.88	\$540.12
98	\$307.13	\$288.94	\$533.68	\$529.51	\$650.53	\$757.11	\$1,169.41	\$627.39	\$777.67	\$1,163.30	\$611.66	\$646.31	\$751.22	\$611.66	\$503.97	\$548.79
100	\$311.77	\$302.22	\$548.44	\$573.50	\$681.24	\$764.62	\$1,191.88	\$642.23	\$793.47	\$1,165.45	\$625.14	\$682.08	\$762.93	\$625.14	\$513.64	\$557.72
105	\$325.54	\$320.98	\$575.88	\$602.18	\$715.58	\$802.74	\$1,251.48	\$670.25	\$834.96	\$1,223.35	\$657.31	\$716.40	\$794.17	\$657.31	\$550.14	\$580.76
110	\$339.48	\$336.27	\$603.30	\$630.86	\$748.88	\$839.76	\$1,311.07	\$702.11	\$873.52	\$1,280.39	\$681.79	\$748.63	\$830.80	\$681.79	\$589.04	\$603.43
115	\$353.84	\$351.55	\$630.72	\$659.53	\$782.67	\$877.71	\$1,370.67	\$733.51	\$903.50	\$1,337.49	\$718.14	\$781.93	\$864.07	\$718.14	\$614.59	\$629.04
120	\$367.63	\$365.68	\$658.14	\$688.20	\$814.90	\$908.72	\$1,430.26	\$765.05	\$933.75	\$1,394.34	\$742.04	\$820.03	\$897.04	\$742.04	\$641.11	\$656.08
125	\$381.26	\$378.35	\$685.56	\$716.88	\$847.62	\$946.36	\$1,489.85	\$795.82	\$964.23	\$1,452.05	\$772.33	\$859.79	\$934.65	\$772.33	\$665.49	\$681.15
130	\$394.97	\$391.91	\$712.98	\$745.55	\$885.72	\$979.28	\$1,549.45	\$827.49	\$994.28	\$1,509.52	\$800.98	\$891.31	\$963.82	\$800.98	\$690.54	\$705.41
135	\$409.04	\$406.20	\$740.41	\$774.23	\$917.47	\$1,015.32	\$1,609.04	\$858.84	\$1,023.95	\$1,567.24	\$828.03	\$924.02	\$992.67	\$828.03	\$715.05	\$730.42
140	\$422.40	\$421.06	\$767.83	\$802.90	\$948.62	\$1,051.77	\$1,668.64	\$890.44	\$1,062.16	\$1,624.45	\$856.96	\$953.59	\$1,021.45	\$856.96	\$741.38	\$755.90
145	\$436.32	\$435.98	\$795.25	\$831.58	\$980.92	\$1,088.55	\$1,728.23	\$922.36	\$1,092.08	\$1,681.68	\$886.95	\$983.22	\$1,054.26	\$886.95	\$766.32	\$780.42
150	\$449.95	\$448.32	\$822.66	\$860.25	\$1,012.56	\$1,124.57	\$1,787.82	\$954.41	\$1,122.11	\$1,737.49	\$916.37	\$1,016.75	\$1,088.98	\$916.37	\$789.22	\$806.16

Shipments of More Than 150 Pounds*

	Zones															
	491	494	451	452	453	454	455	456	457	458	459	461	462	463	470	471
Price Per L	\$3.00	\$2.99	\$5.49	\$5.74	\$6.75	\$7.50	\$11.92	\$6.37	\$7.48	\$11.58	\$6.11	\$6.78	\$7.26	\$6.11	\$5.26	\$5.38
Minimum	\$449.95	\$448.32	\$822.66	\$860.25	\$1,012.56	\$1,124.57	\$1,787.82	\$954.41	\$1,122.11	\$1,737.49	\$916.37	\$1,016.75	\$1,088.98	\$916.37	\$789.22	\$806.16

Any fraction of a pound more than the weight shown in the rate chart is rounded up to the next listed weight.

*UPS offers customized rate sheets identifying its firm offer of rates and prices for transportation rates and prices. The rates and prices identified in the rate sheets will be guaranteed for 12-month periods and increase only with approval by the Lead State. Other fees and charges that may impact an authorized user's invoice are identified in UPS's Rate and Service Guide and as described in UPS's Tariff/Terms and Conditions of Service, in effect at the time of shipping. These fees and charges are subject to change without notice. In accordance with the conditions of the solicitation, UPS has waived all pick-up charges, including on-call/on-demand, and capped fuel surcharges at 7%. Fuel surcharge information is posted on UPS's website, www.ups.com.

NASPO ValuePoint

UPS Worldwide Expedited® - Import

The rates shown are for shipments to the United States, billed to a U.S. UPS account number.

Document/Package*

	Zones															
	61	64	651 / 681	652 / 682	653 / 683	654 / 684	655 / 685	656 / 686	657 / 687	658 / 688	659 / 689	661 / 691	662 / 692	663 / 693	670	671
1	\$73.10	\$53.87	\$129.07	\$82.91	\$146.22	\$97.89	\$126.25	\$101.00	\$126.77	\$154.72	\$101.07	\$99.74	\$93.46	\$104.19	\$78.45	\$84.20
2	\$82.53	\$60.62	\$146.73	\$99.32	\$166.92	\$115.77	\$159.19	\$121.50	\$155.12	\$185.39	\$119.68	\$116.07	\$107.62	\$119.68	\$93.38	\$102.69
3	\$92.16	\$67.55	\$161.22	\$110.86	\$184.24	\$133.67	\$187.99	\$141.48	\$178.79	\$215.59	\$135.55	\$130.93	\$122.28	\$135.55	\$105.26	\$113.80
4	\$100.71	\$73.78	\$180.82	\$123.47	\$205.19	\$154.47	\$213.29	\$164.83	\$206.78	\$248.84	\$146.74	\$145.85	\$136.67	\$146.74	\$115.98	\$129.92
5	\$108.63	\$79.90	\$195.30	\$135.12	\$225.33	\$168.77	\$237.94	\$181.74	\$227.63	\$296.80	\$163.23	\$157.98	\$150.20	\$163.23	\$127.97	\$142.61
6	\$117.14	\$86.57	\$209.06	\$147.33	\$243.31	\$192.38	\$262.04	\$205.21	\$246.51	\$330.05	\$168.75	\$174.07	\$168.29	\$168.75	\$139.44	\$153.87
7	\$124.70	\$89.62	\$220.75	\$157.58	\$257.35	\$206.35	\$281.34	\$225.75	\$265.32	\$345.47	\$190.30	\$191.98	\$183.63	\$190.30	\$152.05	\$168.23
8	\$132.17	\$95.32	\$232.25	\$168.44	\$273.88	\$222.00	\$302.18	\$238.78	\$285.56	\$393.36	\$205.09	\$200.99	\$199.34	\$205.09	\$163.18	\$180.45
9	\$140.03	\$98.26	\$243.34	\$176.94	\$292.34	\$236.93	\$320.19	\$256.57	\$304.52	\$455.47	\$216.06	\$216.27	\$215.05	\$216.06	\$171.36	\$193.64
10	\$147.62	\$107.85	\$253.93	\$189.63	\$310.39	\$251.87	\$346.07	\$279.65	\$324.92	\$498.13	\$229.86	\$227.35	\$230.10	\$229.86	\$183.91	\$205.02
11	\$152.66	\$108.45	\$266.04	\$198.12	\$327.68	\$265.67	\$358.21	\$287.85	\$341.59	\$506.51	\$243.75	\$233.19	\$245.55	\$243.75	\$191.87	\$214.69
12	\$156.65	\$114.71	\$274.70	\$206.21	\$330.59	\$276.00	\$387.46	\$292.56	\$359.52	\$509.44	\$257.37	\$245.75	\$246.92	\$257.37	\$202.17	\$218.67
13	\$162.10	\$119.11	\$287.29	\$220.46	\$361.94	\$297.54	\$409.98	\$314.78	\$379.53	\$564.51	\$268.92	\$257.94	\$273.92	\$268.92	\$212.18	\$234.36
14	\$166.53	\$124.97	\$297.95	\$228.64	\$377.14	\$311.28	\$432.94	\$334.51	\$397.88	\$564.96	\$279.89	\$266.96	\$288.59	\$279.89	\$221.45	\$248.28
15	\$170.87	\$126.22	\$306.89	\$240.74	\$398.30	\$320.93	\$447.03	\$348.26	\$415.49	\$617.62	\$291.30	\$274.66	\$303.58	\$291.30	\$233.64	\$260.85
16	\$174.60	\$131.59	\$318.22	\$250.91	\$414.41	\$332.37	\$467.91	\$348.77	\$435.56	\$666.96	\$302.59	\$289.42	\$320.09	\$302.59	\$243.41	\$274.24
17	\$178.17	\$135.40	\$327.22	\$258.07	\$430.59	\$362.06	\$487.31	\$361.15	\$453.15	\$683.01	\$311.47	\$297.96	\$332.64	\$311.47	\$249.43	\$284.72
18	\$183.38	\$143.33	\$337.46	\$272.92	\$440.62	\$366.98	\$505.54	\$371.04	\$470.47	\$704.98	\$320.31	\$307.55	\$347.56	\$320.31	\$262.66	\$293.23
19	\$185.17	\$147.00	\$347.01	\$280.23	\$464.41	\$384.26	\$523.61	\$392.12	\$483.83	\$712.22	\$327.29	\$325.02	\$362.58	\$327.29	\$271.85	\$310.70
20	\$188.53	\$151.66	\$355.41	\$287.49	\$482.38	\$394.76	\$543.28	\$400.14	\$501.41	\$712.67	\$336.06	\$329.19	\$377.17	\$336.06	\$277.79	\$322.83
21	\$192.94	\$155.62	\$365.27	\$297.27	\$495.97	\$408.56	\$560.18	\$411.59	\$525.72	\$714.35	\$343.54	\$332.82	\$397.33	\$343.54	\$285.37	\$333.57
22	\$198.68	\$159.91	\$374.76	\$309.88	\$510.80	\$422.33	\$585.95	\$429.85	\$543.10	\$726.19	\$352.26	\$350.51	\$411.76	\$352.26	\$299.66	\$343.56
23	\$203.87	\$162.52	\$382.76	\$318.18	\$532.36	\$439.43	\$607.46	\$438.71	\$552.05	\$772.53	\$372.81	\$368.00	\$428.19	\$372.81	\$307.32	\$351.83
24	\$206.84	\$168.52	\$393.48	\$330.16	\$543.00	\$449.75	\$616.14	\$440.27	\$573.50	\$794.98	\$380.30	\$368.45	\$437.83	\$380.30	\$317.42	\$360.81
25	\$208.12	\$174.04	\$401.99	\$335.17	\$545.22	\$462.32	\$619.63	\$443.46	\$587.29	\$804.54	\$383.62	\$373.89	\$451.78	\$389.02	\$327.10	\$363.56
26	\$211.86	\$180.51	\$410.70	\$350.06	\$575.81	\$482.24	\$632.33	\$466.97	\$609.18	\$828.53	\$392.52	\$387.50	\$464.87	\$394.03	\$336.15	\$381.15
27	\$215.60	\$186.44	\$421.55	\$360.32	\$592.38	\$489.02	\$647.34	\$470.66	\$625.23	\$862.30	\$401.41	\$400.98	\$477.79	\$407.30	\$344.13	\$387.69
28	\$222.33	\$190.42	\$430.89	\$369.58	\$610.36	\$502.34	\$663.48	\$496.09	\$640.73	\$862.75	\$404.82	\$413.24	\$488.25	\$418.60	\$352.86	\$397.14
29	\$223.00	\$192.68	\$437.81	\$376.07	\$626.00	\$516.04	\$679.03	\$502.00	\$654.19	\$863.20	\$413.57	\$414.02	\$501.09	\$429.62	\$361.38	\$406.62
30	\$226.73	\$197.97	\$447.09	\$381.08	\$644.71	\$529.03	\$692.98	\$515.03	\$662.99	\$871.21	\$426.38	\$415.36	\$515.88	\$439.64	\$368.96	\$415.55
31	\$230.99	\$202.90	\$457.24	\$393.57	\$656.69	\$542.33	\$709.69	\$532.02	\$681.26	\$888.70	\$432.24	\$425.78	\$529.06	\$448.95	\$376.41	\$423.94
32	\$233.57	\$207.24	\$464.89	\$406.11	\$667.55	\$562.10	\$729.76	\$533.73	\$691.93	\$889.15	\$450.83	\$438.53	\$538.69	\$455.55	\$384.62	\$432.87
33	\$236.98	\$209.33	\$470.83	\$414.43	\$678.02	\$567.77	\$741.72	\$547.33	\$702.05	\$909.41	\$456.31	\$449.68	\$550.31	\$462.67	\$394.70	\$439.88
34	\$243.59	\$212.63	\$478.42	\$423.09	\$694.22	\$582.35	\$752.70	\$554.48	\$711.10	\$977.32	\$457.10	\$452.80	\$566.87	\$468.81	\$402.68	\$448.93
35	\$244.26	\$216.64	\$487.10	\$432.88	\$695.69	\$604.69	\$772.83	\$564.93	\$719.58	\$997.22	\$468.06	\$466.71	\$582.60	\$476.06	\$409.20	\$456.15
36	\$247.20	\$222.73	\$495.35	\$441.94	\$707.54	\$619.86	\$777.00	\$580.60	\$727.98	\$1,001.03	\$471.84	\$480.18	\$584.25	\$482.87	\$420.78	\$466.37
37	\$251.66	\$227.67	\$503.19	\$449.54	\$719.12	\$637.15	\$789.86	\$591.48	\$736.07	\$1,015.22	\$484.72	\$487.87	\$599.92	\$492.14	\$428.97	\$475.40
38	\$254.03	\$231.65	\$510.84	\$460.10	\$724.44	\$644.61	\$802.15	\$607.59	\$745.34	\$1,026.52	\$493.07	\$507.47	\$606.04	\$499.57	\$435.91	\$483.26
39	\$260.23	\$237.21	\$518.49	\$468.79	\$739.05	\$648.99	\$814.47	\$610.31	\$753.88	\$1,034.29	\$503.40	\$517.01	\$620.43	\$506.75	\$443.39	\$491.56
40	\$260.86	\$239.04	\$526.14	\$477.11	\$753.71	\$678.67	\$826.58	\$620.78	\$762.22	\$1,041.93	\$504.89	\$517.46	\$626.32	\$515.30	\$451.16	\$500.08
41	\$264.57	\$243.02	\$532.86	\$485.10	\$770.42	\$688.86	\$845.99	\$635.82	\$773.95	\$1,059.38	\$513.83	\$534.88	\$638.21	\$522.23	\$460.31	\$508.24
42	\$273.42	\$247.32	\$538.58	\$490.92	\$780.56	\$691.52	\$863.05	\$647.65	\$777.01	\$1,077.86	\$527.76	\$544.27	\$648.19	\$527.76	\$469.03	\$516.76
43	\$275.38	\$251.95	\$546.24	\$502.20	\$787.57	\$702.31	\$872.38	\$660.96	\$788.13	\$1,096.02	\$546.28	\$544.72	\$659.49	\$546.28	\$476.50	\$525.26
44	\$275.89	\$255.25	\$557.22	\$511.42	\$797.16	\$713.85	\$877.84	\$662.00	\$796.31	\$1,116.86	\$555.81	\$545.17	\$672.53	\$555.81	\$483.76	\$525.71
45	\$279.38	\$258.07	\$559.58	\$516.63	\$803.84	\$715.22	\$888.59	\$672.31	\$804.51	\$1,144.97	\$556.93	\$548.68	\$687.29	\$556.93	\$491.44	\$541.32
46	\$283.09	\$262.69	\$571.65	\$520.42	\$810.23	\$742.33	\$907.30	\$691.85	\$815.99	\$1,154.18	\$577.16	\$555.08	\$696.10	\$577.16	\$495.49	\$548.56
47	\$287.34	\$267.90	\$576.53	\$530.86	\$817.96	\$758.44	\$920.09	\$693.82	\$822.99	\$1,171.69	\$581.27	\$567.04	\$705.01	\$581.27	\$503.45	\$556.31
48	\$294.53	\$272.38	\$583.38	\$547.14	\$818.76	\$760.07	\$934.11	\$704.45	\$831.50	\$1,187.36	\$581.78	\$578.99	\$718.50	\$581.78	\$517.30	\$565.25
49	\$295.25	\$277.58	\$588.84	\$550.82	\$824.36	\$767.54	\$944.42	\$714.66	\$839.81	\$1,198.98	\$591.11	\$579.48	\$726.49	\$591.11	\$524.11	\$572.16
50	\$299.49	\$282.09	\$592.97	\$551.27	\$831.41	\$795.61	\$953.01	\$739.59	\$851.63	\$1,228.20	\$599.87	\$585.58	\$734.34	\$599.87	\$524.56	\$580.89
52	\$306.95	\$292.88	\$610.78	\$575.87	\$846.96	\$820.73	\$964.16	\$752.01	\$871.92	\$1,233.68	\$618.80	\$604.39	\$772.52	\$618.80	\$546.64	\$593.32
54	\$313.34	\$301.70	\$617.98	\$594.87	\$877.59	\$832.95	\$973.68	\$783.00	\$889.59	\$1,245.59	\$644.55	\$631.81	\$801.38	\$644.55	\$563.13	\$609.69
56	\$320.43	\$312.91	\$631.36	\$608.25	\$892.07	\$867.67	\$981.86	\$817.29	\$894.50	\$1,279.25	\$660.38	\$647.78	\$826.21	\$660.38	\$578.38	\$625.95
58	\$327.53	\$323.06	\$644.74	\$622.85	\$899.16	\$902.39	\$1,010.93	\$809.56	\$903.94	\$1,312.97	\$676.23	\$666.83	\$848.10	\$676.23	\$592.98	\$642.34
60	\$337.67	\$333.69	\$662.65	\$643.83	\$920.03	\$933.50	\$1,020.74	\$832.73	\$927.84	\$1,455.50	\$700.19	\$678.05	\$877.19	\$700.19	\$608.24	\$658.29
62	\$345.83	\$344.35	\$680.30	\$655.18	\$936.50	\$959.95	\$1,042.16	\$855.76	\$959.34	\$1,474.23	\$708.43	\$712.00	\$899.33	\$708.43	\$619.66	\$673.99
64	\$353.93	\$354.96	\$690.16	\$677.60	\$959.61	\$990.53	\$1,053.05	\$882.44	\$972.39	\$1,539.55	\$741.48	\$727.41	\$913.85	\$741.48	\$636.28	\$685.24
66	\$361.33	\$364.62	\$709.35	\$692.34	\$981.95	\$1,016.87	\$1,063.08	\$902.33	\$985.76	\$1,542.62	\$771.21	\$753.36	\$931.54	\$771.21	\$649.22	\$696.46
68	\$375.26	\$375.89	\$716.42	\$706.11	\$1,009.39	\$1,017.41	\$1,075.18	\$910.98	\$1,006.32	\$1,543.07	\$775.96	\$762.78	\$959.59	\$775.96	\$664.69	\$711.66
70	\$383.39	\$386.33	\$730.74	\$721.99	\$1,019.56	\$1,018.32	\$1,085.84	\$949.11	\$1,016.40	\$1,543.52	\$806.85	\$786.80	\$985.23	\$806.85	\$680.26	\$740.37
72	\$392.31	\$395.51	\$746.62	\$722.44	\$1,048.00	\$1,087.37	\$1,096.61	\$970.54	\$1,022.45	\$1,568.50	\$817.94	\$802.11	\$989.22	\$817.94	\$680.71	\$761.63
74	\$395.01	\$404.51	\$761.79	\$753.76	\$1,053.31	\$1,099.22	\$1,108.63	\$974.89	\$1,036.73	\$1,603.46	\$827.99	\$813.83	\$1,012.13	\$827.99	\$710.74	\$782.65
76	\$401.31	\$415.46	\$776.01	\$754.21	\$1,054.09	\$										

150	\$719.33	\$759.39	\$1,276.30	\$1,373.52	\$1,623.21	\$1,864.16	\$1,616.41	\$1,684.88	\$1,482.98	\$3,241.52	\$1,375.63	\$1,357.78	\$1,842.52	\$1,375.63	\$1,241.95	\$1,299.83
-----	----------	----------	------------	------------	------------	------------	------------	------------	------------	------------	------------	------------	------------	------------	------------	------------

Shipments of More Than 150 Pounds*

	Zones															
	61	64	651 / 681	652 / 682	653 / 683	654 / 684	655 / 685	656 / 686	657 / 687	658 / 688	659 / 689	661 / 691	662 / 692	663 / 693	670	671
Price Per L	\$4.80	\$5.07	\$8.51	\$9.16	\$10.83	\$12.43	\$10.78	\$11.24	\$9.89	\$21.62	\$9.17	\$9.05	\$12.29	\$9.17	\$8.28	\$8.67
Minimum	\$719.33	\$759.39	\$1,276.30	\$1,373.52	\$1,623.21	\$1,864.16	\$1,616.41	\$1,684.88	\$1,482.98	\$3,241.52	\$1,375.63	\$1,357.78	\$1,842.52	\$1,375.63	\$1,241.95	\$1,299.83

Any fraction of a pound over the weight shown takes the next higher rate.

*UPS offers customized rate sheets identifying its firm offer of rates and prices for transportation rates and prices. The rates and prices identified in the rate sheets will be guaranteed for 12-month periods and increase only with approval by the Lead State. Other fees and charges that may impact an authorized user's invoice are identified in UPS's Rate and Service Guide and as described in UPS's Tariff/Terms and Conditions of Service, in effect at the time of shipping. These fees and charges are subject to change without notice. In accordance with the conditions of the solicitation, UPS has waived all pick-up charges, including on-call/on-demand, and capped fuel surcharges at 7%. Fuel surcharge information is posted on UPS's website, www.ups.com.

NASPO ValuePoint

UPS Standard® from Canada - Import

Packages*

	Zones		
	376	378	380
1	\$17.41	\$17.72	\$18.29
2	\$18.29	\$18.53	\$19.45
3	\$18.99	\$19.37	\$20.58
4	\$19.45	\$20.34	\$21.91
5	\$20.22	\$21.27	\$22.87
6	\$20.79	\$21.66	\$24.00
7	\$21.35	\$22.31	\$25.13
8	\$22.02	\$23.27	\$26.30
9	\$22.48	\$24.20	\$27.42
10	\$23.19	\$25.10	\$28.63
11	\$23.27	\$25.61	\$29.36
12	\$23.71	\$26.57	\$30.52
13	\$24.09	\$27.55	\$31.56
14	\$24.32	\$28.35	\$32.70
15	\$24.60	\$29.23	\$33.81
16	\$25.19	\$29.96	\$34.79
17	\$25.87	\$30.72	\$35.99
18	\$26.57	\$31.53	\$36.96
19	\$27.04	\$32.29	\$38.12
20	\$27.45	\$32.90	\$39.29
21	\$28.89	\$34.65	\$41.28
22	\$29.22	\$35.10	\$42.31
23	\$29.91	\$36.05	\$43.42
24	\$30.38	\$36.67	\$44.45
25	\$30.90	\$37.38	\$45.60
26	\$31.49	\$38.08	\$46.75
27	\$32.03	\$38.94	\$47.78
28	\$33.35	\$40.27	\$49.69
29	\$33.42	\$40.47	\$50.04
30	\$34.21	\$41.52	\$51.41
31	\$34.70	\$41.83	\$52.54
32	\$35.54	\$42.66	\$53.68
33	\$35.99	\$43.40	\$54.79
34	\$37.14	\$44.61	\$56.48
35	\$37.42	\$44.73	\$56.97
36	\$38.04	\$45.63	\$58.21
37	\$38.71	\$46.75	\$59.17
38	\$39.41	\$47.83	\$60.37
39	\$40.34	\$49.45	\$62.15
40	\$40.69	\$49.97	\$62.59
41	\$41.38	\$50.97	\$63.72
42	\$42.71	\$52.87	\$66.07
43	\$43.11	\$53.61	\$66.65
44	\$43.40	\$54.11	\$67.10
45	\$44.32	\$55.74	\$68.57
46	\$44.63	\$56.09	\$69.24
47	\$45.18	\$57.09	\$70.20
48	\$46.37	\$58.77	\$72.12
49	\$46.54	\$59.07	\$72.32
50	\$47.28	\$60.01	\$73.07

	Zones		
	376	378	380
52	\$48.69	\$62.12	\$75.45
54	\$50.14	\$64.35	\$77.83
56	\$51.66	\$66.33	\$80.23
58	\$53.09	\$68.36	\$82.49
60	\$54.58	\$70.39	\$84.68
62	\$56.03	\$72.28	\$86.94
64	\$57.60	\$74.24	\$89.12
66	\$59.08	\$76.04	\$91.56
68	\$61.50	\$79.43	\$95.63
70	\$63.04	\$81.17	\$97.64
72	\$64.43	\$83.11	\$100.12
74	\$65.55	\$84.36	\$101.94
76	\$67.00	\$86.17	\$104.47
78	\$68.43	\$88.27	\$107.11
80	\$68.97	\$89.02	\$108.11
82	\$69.84	\$90.35	\$109.92
84	\$72.27	\$93.57	\$113.89
86	\$72.47	\$93.78	\$114.47
88	\$74.75	\$96.00	\$117.52
90	\$75.07	\$97.12	\$119.01
92	\$76.28	\$98.61	\$121.38
94	\$77.69	\$99.98	\$123.65
96	\$79.28	\$101.50	\$125.84
98	\$81.39	\$104.63	\$130.17
100	\$81.47	\$104.68	\$130.28
105	\$83.28	\$106.24	\$133.76
110	\$85.67	\$108.15	\$137.03
115	\$87.87	\$110.04	\$140.28
120	\$90.05	\$111.82	\$143.63
125	\$92.08	\$113.63	\$147.01
130	\$94.11	\$115.49	\$150.29
135	\$96.20	\$117.62	\$153.59
140	\$98.11	\$119.41	\$157.01
145	\$100.21	\$121.26	\$160.19
150	\$102.08	\$123.04	\$163.55

Multiple-Package Shipments of More Than 150 Pounds*

	Zones		
	376	378	380
Price Per L	\$0.68	\$0.82	\$1.09
Minimum	\$102.08	\$123.04	\$163.55

Any fraction of a pound more than the weight shown in the rate chart is rounded up to the next listed weight.

*UPS offers customized rate sheets identifying its firm offer of rates and prices for transportation rates and prices. The rates and prices identified in the rate sheets will be guaranteed for 12-month periods and increase only with approval by the Lead State. Other fees and charges that may impact an authorized user's invoice are identified in UPS's Rate and Service Guide and as described in UPS's Tariff/Terms and Conditions of Service, in effect at the time of shipping. These fees and charges are subject to change without notice. In accordance with the conditions of the solicitation, UPS has waived all pick-up charges, including on-call/on-demand, and capped fuel surcharges at 7%. Fuel surcharge information is posted on UPS's website, www.ups.com.

NASPO ValuePoint

UPS Standard from Mexico - Import

Packages*

	Zones						
	362	363	364	365	366	367	368
1	\$40.99	\$41.30	\$41.63	\$42.35	\$42.80	\$43.11	\$43.59
2	\$46.58	\$47.11	\$47.31	\$48.51	\$49.02	\$49.38	\$49.64
3	\$52.08	\$52.50	\$52.70	\$53.78	\$53.99	\$54.51	\$55.09
4	\$57.00	\$57.36	\$57.62	\$58.91	\$59.43	\$60.47	\$61.24
5	\$62.80	\$63.17	\$63.41	\$64.32	\$66.74	\$67.15	\$67.49
6	\$67.92	\$68.24	\$68.63	\$69.76	\$72.23	\$72.75	\$73.04
7	\$70.94	\$71.45	\$71.69	\$71.79	\$75.27	\$75.79	\$76.58
8	\$73.14	\$73.56	\$73.95	\$75.17	\$77.53	\$80.84	\$81.90
9	\$75.87	\$76.36	\$76.73	\$78.06	\$80.36	\$83.52	\$85.93
10	\$77.51	\$77.82	\$78.26	\$79.48	\$81.85	\$84.98	\$87.42
11	\$79.78	\$80.14	\$80.48	\$81.74	\$84.06	\$87.26	\$89.68
12	\$81.67	\$81.98	\$82.31	\$83.52	\$85.89	\$89.15	\$91.51
13	\$83.45	\$83.76	\$84.25	\$85.37	\$87.73	\$90.93	\$93.30
14	\$85.55	\$86.08	\$86.57	\$87.52	\$90.05	\$92.99	\$95.68
15	\$88.07	\$88.66	\$89.05	\$90.09	\$93.14	\$96.30	\$99.30
16	\$89.66	\$90.33	\$90.68	\$91.93	\$95.36	\$98.88	\$101.93
17	\$91.83	\$92.76	\$92.99	\$94.46	\$98.08	\$101.60	\$105.08
18	\$93.33	\$94.45	\$94.73	\$96.50	\$100.25	\$104.08	\$107.71
19	\$95.22	\$96.71	\$97.09	\$98.88	\$102.98	\$106.87	\$110.76
20	\$96.40	\$98.06	\$98.45	\$100.61	\$104.71	\$108.82	\$112.91
21	\$96.88	\$98.55	\$98.98	\$101.10	\$105.25	\$109.31	\$113.54
22	\$98.39	\$100.29	\$100.76	\$103.09	\$107.46	\$111.71	\$116.28
23	\$100.54	\$102.44	\$102.98	\$105.44	\$109.97	\$114.33	\$119.03
24	\$102.92	\$105.01	\$105.51	\$108.23	\$112.96	\$117.44	\$122.38
25	\$105.07	\$107.13	\$107.65	\$110.49	\$115.50	\$120.02	\$125.39
26	\$106.70	\$108.81	\$109.80	\$112.64	\$117.86	\$122.43	\$128.16
27	\$108.76	\$110.80	\$111.81	\$114.90	\$120.48	\$125.17	\$131.11
28	\$110.69	\$113.01	\$114.12	\$117.29	\$122.97	\$127.85	\$134.06
29	\$113.12	\$115.38	\$116.60	\$119.80	\$125.81	\$130.74	\$137.32
30	\$114.71	\$117.02	\$117.70	\$120.96	\$127.22	\$132.22	\$139.10
31	\$115.43	\$117.79	\$119.48	\$122.85	\$129.43	\$134.52	\$141.74
32	\$116.96	\$119.01	\$120.74	\$124.11	\$130.95	\$136.11	\$143.36
33	\$117.90	\$120.55	\$122.21	\$125.96	\$132.69	\$138.00	\$145.52
34	\$119.95	\$122.79	\$124.59	\$128.38	\$135.21	\$140.74	\$148.62
35	\$122.38	\$125.37	\$127.22	\$131.16	\$138.27	\$143.78	\$151.84
36	\$122.83	\$125.82	\$127.67	\$131.61	\$138.72	\$144.23	\$152.29
37	\$126.87	\$129.89	\$131.81	\$135.68	\$142.52	\$147.84	\$155.11
38	\$129.26	\$132.36	\$134.32	\$137.95	\$145.11	\$150.28	\$157.55
39	\$131.54	\$134.59	\$136.40	\$140.27	\$147.24	\$152.51	\$159.77
40	\$133.41	\$136.25	\$138.20	\$142.03	\$149.05	\$154.17	\$161.63
41	\$135.78	\$138.74	\$140.63	\$144.35	\$151.43	\$156.82	\$164.01
42	\$138.42	\$141.53	\$143.37	\$147.20	\$154.12	\$159.45	\$166.75
43	\$140.39	\$143.50	\$145.44	\$149.18	\$156.35	\$161.48	\$169.08
44	\$142.20	\$144.32	\$146.27	\$150.09	\$157.28	\$162.45	\$169.85
45	\$142.68	\$145.47	\$147.41	\$151.28	\$158.31	\$163.58	\$170.99
46	\$144.07	\$147.02	\$149.00	\$152.73	\$159.88	\$165.26	\$172.61
47	\$144.55	\$147.50	\$149.48	\$153.21	\$160.59	\$165.78	\$173.22
48	\$146.45	\$149.45	\$151.39	\$155.06	\$162.04	\$167.27	\$174.62
49	\$149.36	\$152.21	\$154.07	\$157.95	\$164.84	\$170.13	\$177.35
50	\$151.54	\$154.38	\$156.36	\$160.18	\$167.12	\$172.41	\$179.69

Any fraction of a pound more than the weight shown in the rate chart is rounded up to the next listed weight.

	Zones						
	362	363	364	365	366	367	368
52	\$155.37	\$158.36	\$160.64	\$165.14	\$172.10	\$177.33	\$184.55
54	\$161.90	\$164.94	\$167.17	\$171.59	\$178.56	\$183.80	\$191.12
56	\$169.09	\$172.04	\$174.35	\$178.73	\$185.82	\$190.94	\$198.21
58	\$173.70	\$176.65	\$178.89	\$183.38	\$190.38	\$195.50	\$202.81
60	\$178.41	\$181.26	\$183.55	\$187.98	\$195.05	\$200.17	\$207.38
62	\$182.92	\$185.91	\$188.10	\$192.55	\$199.66	\$204.79	\$212.02
64	\$186.54	\$189.50	\$192.18	\$197.19	\$205.04	\$212.50	\$218.92
66	\$191.06	\$194.06	\$196.73	\$201.84	\$209.71	\$217.11	\$223.47
68	\$195.72	\$198.62	\$201.29	\$206.50	\$214.32	\$221.61	\$228.08
70	\$200.42	\$203.33	\$205.88	\$211.05	\$218.97	\$226.27	\$232.77
72	\$204.98	\$207.88	\$210.47	\$215.60	\$223.47	\$230.89	\$237.38
74	\$209.71	\$212.60	\$215.19	\$220.26	\$228.20	\$235.55	\$241.98
76	\$212.75	\$215.71	\$218.35	\$224.86	\$232.81	\$241.70	\$247.37
78	\$217.42	\$220.52	\$223.04	\$229.82	\$237.66	\$246.63	\$252.45
80	\$218.45	\$221.45	\$223.97	\$230.69	\$238.65	\$247.51	\$253.22
82	\$221.98	\$224.97	\$227.49	\$234.11	\$242.07	\$250.99	\$256.59
84	\$226.58	\$229.48	\$232.04	\$238.76	\$246.53	\$255.48	\$261.14
86	\$231.30	\$234.31	\$236.68	\$243.30	\$251.30	\$260.10	\$265.80
88	\$235.91	\$238.81	\$241.41	\$248.01	\$255.75	\$264.81	\$270.46
90	\$240.56	\$243.68	\$246.05	\$252.67	\$260.51	\$269.73	\$274.95
92	\$245.71	\$248.60	\$251.00	\$257.27	\$264.96	\$274.14	\$279.57
94	\$250.88	\$253.52	\$256.09	\$261.92	\$269.42	\$278.59	\$284.06
96	\$255.69	\$258.34	\$260.98	\$266.53	\$273.83	\$282.89	\$288.46
98	\$260.10	\$262.22	\$265.12	\$270.30	\$277.50	\$286.78	\$292.40
100	\$264.56	\$266.16	\$269.41	\$274.17	\$281.44	\$290.71	\$296.48
105	\$265.55	\$267.18	\$270.04	\$274.64	\$282.32	\$291.44	\$296.96
110	\$274.19	\$275.63	\$277.48	\$281.67	\$288.43	\$297.44	\$303.05
115	\$284.03	\$285.95	\$287.98	\$291.81	\$298.74	\$308.02	\$313.72
120	\$295.79	\$297.30	\$299.66	\$303.23	\$310.38	\$320.02	\$325.88
125	\$299.88	\$301.59	\$303.95	\$307.05	\$314.33	\$323.76	\$329.54
130	\$310.61	\$312.72	\$315.05	\$317.92	\$325.22	\$334.74	\$340.68
135	\$321.27	\$323.81	\$326.33	\$328.66	\$336.03	\$345.41	\$351.70
140	\$324.13	\$326.75	\$329.18	\$330.98	\$338.26	\$347.32	\$353.46
145	\$338.37	\$341.42	\$344.02	\$345.41	\$352.76	\$361.84	\$368.25
150	\$350.49	\$354.01	\$356.72	\$357.72	\$365.05	\$374.06	\$380.63

Multiple-Package Shipments of More Than 150 Pounds*

	Zones						
	362	363	364	365	366	367	368
Multiple-Package Shipments of 151 to 199 Pounds							
Price Per L	2.34	2.367	2.385	2.385	2.439	2.502	2.538
Minimum	389.43	393.34	396.36	397.47	405.61	415.62	422.92
Multiple-Package Shipments of 200 Pounds or More							
Price Per L	2.241	2.241	2.241	2.259	2.304	2.358	2.412
Minimum	516.64	521.83	525.84	527.3	538.1	551.39	561.08

*UPS offers customized rate sheets identifying its firm offer of rates and prices for transportation rates and prices. The rates and prices identified in the rate sheets will be guaranteed for 12-month periods and increase only with approval by the Lead State. Other fees and charges that may impact an authorized user's invoice are identified in UPS's Rate and Service Guide and as described in UPS's Tariff/Terms and Conditions of Service, in effect at the time of shipping. These fees and charges are subject to change without notice. In accordance with the conditions of the solicitation, UPS has waived all pick-up charges, including on-call/on-demand, and capped fuel surcharges at 7%. Fuel surcharge information is posted on UPS's website, www.ups.com.

Attachment C: Cost Proposal

CH21-36: Small Package Delivery Services

Instructions:

1. Any alteration to Attachment C: Cost Proposal may result in proposal being deemed non-responsive.
2. Offeror submitting costs to Nationwide Coverage MUST fill out all of the Regional Cost tabs to be awarded for Nationwide Coverage.
3. Offeror who is not submitting cost for Nationwide Coverage may fill out a Cost Proposal for each region they are applying for an award for. If a tab does not have any costs submitted the Offeror will not be awarded for that region or National coverage.
4. If Offeror is awarded a regional contract they may sign a PA with states within that region. If Offeror does not get awarded a region they will not be able to sign a PA with those States through the term of the contract.
5. Offeror does not have to provide services to every state in a Region. The US is broken up regionally to evaluate costs for regional vendors and allow expansion of PA's to awarded offerors within a region.

Regional Map:

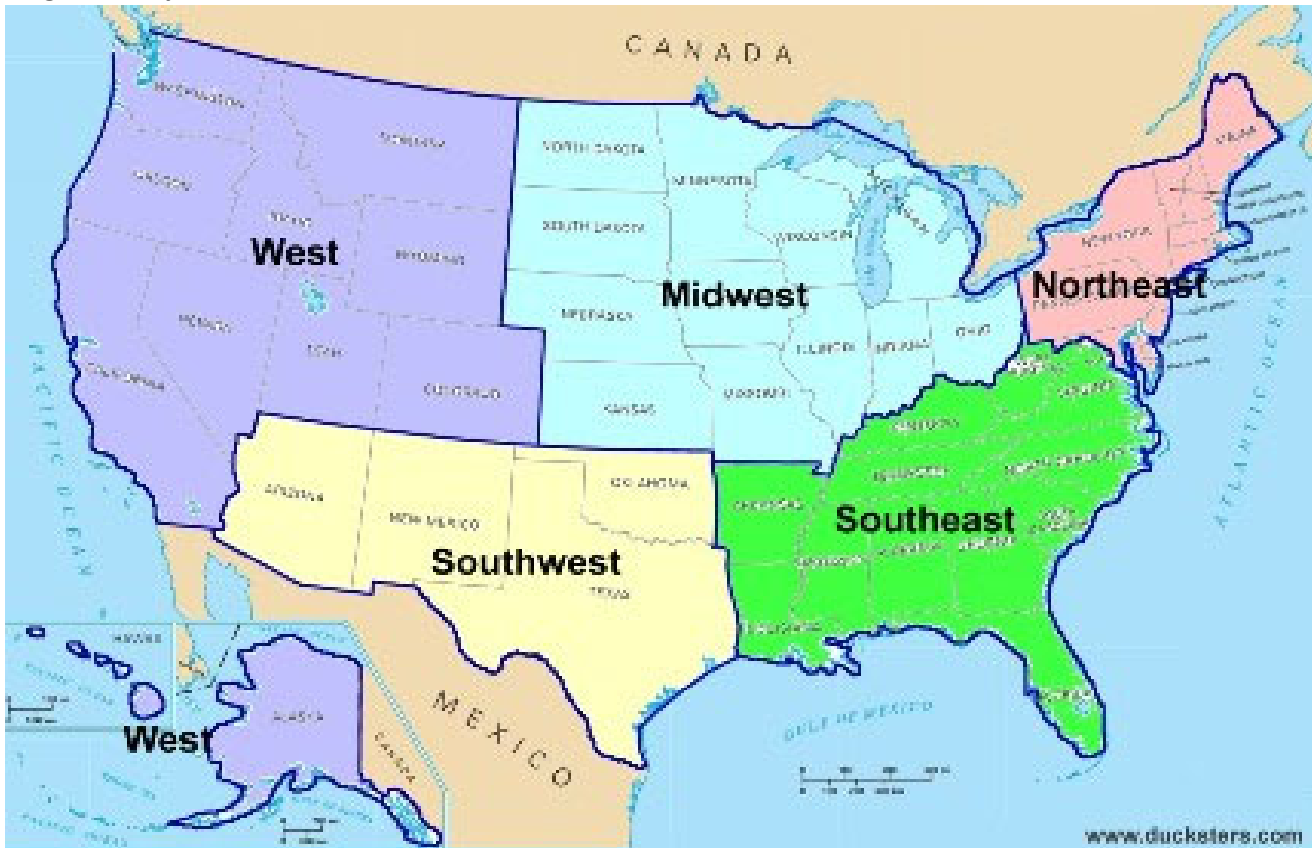

Region 1 - West

States included: Colorado, Wyoming, Montana, Idaho, Washington, Oregon, Utah, Nevada, California, Alaska, Hawaii

Region 2 - Midwest

States included: Ohio, Indiana, Michigan, Illinois, Missouri, Wisconsin, Minnesota, Iowa, Kansas, Nebraska, South Dakota, North Dakota

Region 3 - Southwest

States included: Texas, Oklahoma, New Mexico, Arizona

Region 4 - Southeast

States included: West Virginia, Virginia, Kentucky, Tennessee, North Carolina, South Carolina, Georgia, Alabama, Mississippi, Arkansas, Louisiana, Florida

Region 5 -Northeast

States included: Maine, Massachusetts, Rhode Island, Connecticut, New Hampshire, Vermont, New York, Pennsylvania, New Jersey, Delaware, Maryland

Region 1 - West

States included: Colorado, Wyoming, Montana, Idaho, Washington, Oregon, Utah, Nevada, California, Alaska,

Regional Instructions:

1. If Offeror cannot provide a cost for the scenario, put \$0.00 or leave Scenario blank.
2. Any Scenario with \$0.00 will receive no Cost Points for that line item.
3. The points assigned to each Offeror's cost proposal will be based on the lowest proposal price of each scenario. The Offeror with the lowest Proposed Price will receive 100% of the price points for that scenario. All other Offerors will receive a portion of the total cost points based on what percentage higher their Proposed Price is than the Lowest Proposed Price. An Offeror whose Proposed Price is more than double (200%) the Lowest Proposed Price will receive no points. The formula to compute the points is: $\text{Cost Points} \times (2 - \frac{\text{Proposed Price}}{\text{Lowest Proposed Price}})$.
4. Offeror shall describe each fee associated with the shipping scenario
5. Offeror to fill out the portions in Yellow.

Scenario #1 - Total of 80 Points Possible

CA Intrastate, Express Overnight: 4lbs package shipped from 90095 to 94720; declared value.

Description of Fees:

UPS Next Day Air Guaranteed next business day delivery by 10:30 a.m., 12:00 p.m. or end of day, depending on destination, to all 50 states and Puerto Rico. (\$18.31)

UPS's liability is limited to \$100.00 on packages with no declared value. (\$0.00)

Total Cost:

\$18.31

Scenario #2 - Total of 80 Points Possible

UT Intrastate, Ground, Residential: 15lb package shipped from 84111 to 84404; on-call pickup, same day; proof of

Description of Fees:

UPS® Ground - day definite delivery - one-day (\$7.71)

Residential Surcharge - will apply (in addition to all applicable Area Surcharges) to any delivery to, or a UPS On-Call Pickup request from, a location that is a home, including a business operating out of a home. (\$4.45)

UPS On-Call Pickup® - Same Day (\$0.00)

Proof of Delivery includes the time of delivery, full delivery address and the name and signature of the person who accepted your shipment, if available (\$3)

Total Cost:

\$15.16

Scenario #3 - Total of 80 Points Possible

WA Interstate, Express 2nd day: 7lb package shipped from 98101 to 98402; declared signature required;

Description of Fees:

UPS 2nd Day Air Guaranteed delivery, by the end of the second business day, throughout the U.S. and Puerto Rico.

Declared value - UPS's liability is limited to \$100.00 on packages with no declared value. (\$0)

Signature Required - UPS will obtain the necessary signature upon delivery. (\$5.55)

Total Cost:

\$13.77

Scenario #4 - Total of 80 Points Possible

OR Interstate; Express overnight mid-AM; 4lbs package shipped from 97215 to 97301; adult signature required

Description of Fees:

UPS Next Day Air Saver Guaranteed overnight afternoon delivery throughout the U.S. 48 contiguous states. (\$8.20)
Signature Required (Adult) - UPS will obtain the necessary signature upon delivery. (\$6.70)

Total Cost:

\$14.90

Scenario #5 - Total of 80 Points Possible

NV Interstate, Ground: 5lbs package shipped from 89403 to 88901; Saturday delivery

Description of Fees:

UPS Ground - day definite delivery in 1 - 5 days (\$7.41)

UPS Ground delivery on Saturday by end of day (\$4.00)

Total Cost:

\$11.41

Note: UPS offers customized rate sheets identifying its firm offer of rates and prices for transportation rates and prices. The rates and prices identified in the rate sheets will be guaranteed for 12-month periods and increase only with approval by the Lead State. Other fees and charges that may impact an authorized user's invoice are identified in UPS's Rate and Service Guide and as described in UPS's Tariff/Terms and Conditions of Service, in effect at the time of shipping. These fees and charges are subject to change without notice. In accordance with the conditions of the solicitation, UPS has waived all pick-up charges, including on-call/on-demand, and capped

Region 2 - Midwest

States included: Ohio, Indiana, Michigan, Illinois, Missouri, Wisconsin, Minnesota, Iowa, Kansas, Nebraska, South Dakota, North Dakota

Regional Instructions:

1. If Offeror cannot provide a cost for the scenario, put \$0.00 or leave Scenario blank.
2. Any Scenario with \$0.00 will receive no Cost Points for that line item.
3. The points assigned to each Offeror's cost proposal will be based on the lowest proposal price of each scenario. The Offeror with the lowest Proposed Price will receive 100% of the price points for that scenario. All other Offerors will receive a portion of the total cost points based on what percentage higher their Proposed Price is than the Lowest Proposed Price. An Offeror whose Proposed Price is more than double (200%) the Lowest Proposed Price will receive no points. The formula to compute the points is: $\text{Cost Points} \times (2 - \frac{\text{Proposed Price}}{\text{Lowest Proposed Price}})$.
4. Offeror shall describe each fee associated with the shipping scenario
5. Offeror to fill out the portions in Yellow.

Scenario #1 - Total of 80 Points Possible

IL Intrastate, Express Overnight: 4lbs package shipped from 62629 to 60007; declared value.

Description of Fees:

UPS Next Day Air Guaranteed next business day delivery by 10:30 a.m., 12:00 p.m. or end of day, depending on destination, to all 50 states and Puerto Rico. (\$13.02)

UPS's liability is limited to \$100.00 on packages with no declared value. (\$0.00)

Total Cost:

\$13.02

Scenario #2 - Total of 80 Points Possible

OH Intrastate, Ground, Residential: 15lb package shipped from 43004 to 41073; on-call pickup, same day; proof of delivery.

Description of Fees:

UPS Ground - day definite delivery in 1 - 5 days (\$7.71)

Residential Surcharge - will apply (in addition to all applicable Area Surcharges) to any delivery to, or a UPS On-Call Pickup request from, a location that is a home, including a business operating out of a home. (\$4.45)

UPS On-Call Pickup® - Same Day (\$0.00)

Proof of Delivery includes the time of delivery, full delivery address and the name and signature of the person who accepted your shipment, if available (\$3)

Total Cost:

\$15.16

Scenario #3 - Total of 80 Points Possible

WI Interstate, Express 2nd day: 7lb package shipped from 53702 to 53221; declared signature required; declared value, express.

Description of Fees:

UPS 2nd Day Air Guaranteed delivery, by the end of the second business day, throughout the U.S. and Puerto Rico. (\$8.22)

Signature Required - UPS will obtain the necessary signature upon delivery. (\$5.55)

Declared value - UPS's liability is limited to \$100.00 on packages with no declared value. (\$0)

Total Cost:

\$13.77

Scenario #4 - Total of 80 Points Possible

MI Interstate, Ground: 10lb package shipped from 48864 to 48103; with address correction surcharge.

Description of Fees:

UPS Ground - day definite delivery in 1 - 5 days (\$7.18)

Address Correction - An address validated by UPS may be incorrect or incomplete for purposes of completing delivery, and may be corrected by UPS. (\$18)

Total Cost:

\$25.18

Scenario #5 - Total of 80 Points Possible

NE Interstate, Ground: 5lbs package shipped from 68501 to 68007; Saturday delivery

Description of Fees:

UPS Ground - day definite delivery in 1 - 5 days

UPS Ground delivery on Saturday by end of day (\$4.00)

Total Cost:

\$10.75

Note: UPS offers customized rate sheets identifying its firm offer of rates and prices for transportation rates and prices. The rates and prices identified in the rate sheets will be guaranteed for 12-month periods and increase only with approval by the Lead State. Other fees and charges that may impact an authorized user's invoice are identified in UPS's Rate and Service Guide and as described in UPS's Tariff/Terms and Conditions of Service, in effect at the time of shipping. These fees and charges are subject to change without notice. In accordance with the conditions of the solicitation, UPS has waived all pick-up charges, including on-call/on-demand, and capped fuel surcharges at 7%. Fuel surcharge information is posted on UPS's website, www.ups.com.

Region 3 - Southwest

States included: Texas, Oklahoma, New Mexico, Arizona

Regional Instructions:

1. If Offeror cannot provide a cost for the scenario, put \$0.00 or leave Scenario blank.
2. Any Scenario with \$0.00 will receive no Cost Points for that line item.
3. The points assigned to each Offeror's cost proposal will be based on the lowest proposal price of each scenario. The Offeror with the lowest Proposed Price will receive 100% of the price points for that scenario. All other Offerors will receive a portion of the total cost points based on what percentage higher their Proposed Price is than the Lowest Proposed Price. An Offeror whose Proposed Price is more than double (200%) the Lowest Proposed Price will receive no points. The formula to compute the points is: $\text{Cost Points} \times (2 - \frac{\text{Proposed Price}}{\text{Lowest Proposed Price}})$.
4. Offeror shall describe each fee associated with the shipping scenario
5. Offeror to fill out the portions in Yellow.

Scenario #1 - Total of 80 Points Possible

TX Intrastate, Express Overnight: 4lbs package shipped from 72096 to 78006; declared value.

Description of Fees:

UPS Next Day Air Guaranteed next business day delivery by 10:30 a.m., 12:00 p.m. or end of day, depending on destination, to all 50 states and Puerto Rico. (\$18.31)

A Delivery Area Surcharge applies to packages delivered to the ZIP Code 78006. (\$3.25)

UPS's liability is limited to \$100.00 on packages with no declared value. (\$0.00)

Total Cost:

\$21.56

Scenario #2 - Total of 80 Points Possible

TX Intrastate, Ground, Residential: 15lb package shipped from 76063 to 79835; on-call pickup, same day; proof of delivery.

Description of Fees:

UPS Ground - day definite delivery in 1 - 5 days (\$8.69)

Residential Surcharge - will apply (in addition to all applicable Area Surcharges) to any delivery to, or a UPS On-Call Pickup request from, a location that is a home, including a business operating out of a home. (\$4.45)

UPS On-Call Pickup® - Same Day (\$0.00)

Proof of Delivery includes the time of delivery, full delivery address and the name and signature of the person who accepted your shipment, if available (\$3)

Total Cost:

\$16.14

Scenario #3 - Total of 80 Points Possible

NM Interstate, Express 2nd day: 7lb package shipped from 87503 to 87101; declared signature required; declared value, express.

Description of Fees:

UPS 2nd Day Air Guaranteed delivery, by the end of the second business day, throughout the U.S. and Puerto Rico. (\$8.22)

Signature Required - UPS will obtain the necessary signature upon delivery. (\$5.55)

UPS's liability is limited to \$100.00 on packages with no declared value. (\$0.00)

Total Cost:

\$13.77

Scenario #4 - Total of 80 Points Possible

AZ Interstate, Ground: 10lb package shipped from 85001 to 85054; with address correction surcharge.

Description of Fees:

UPS Ground - day definite delivery in 1 - 5 days (\$7.18)

An address validated by UPS may be incorrect or incomplete for purposes of completing delivery, and may be corrected by UPS. (\$18)

Total Cost:

\$25.18

Scenario #5 - Total of 80 Points Possible

OK Interstate, Ground: 5lbs package shipped from 73008 to 74008; Saturday delivery

Description of Fees:

UPS Ground - day definite delivery in 1 - 5 days (\$6.75)

A Delivery Area Surcharge applies to packages delivered to ZIP Code 74008 (\$3.10)

UPS Ground delivery on Saturday by end of day (\$4.00)

Total Cost:

\$13.85

Note: UPS offers customized rate sheets identifying its firm offer of rates and prices for transportation rates and prices. The rates and prices identified in the rate sheets will be guaranteed for 12-month periods and increase only with approval by the Lead State. Other fees and charges that may impact an authorized user's invoice are identified in UPS's Rate and Service Guide and as described in UPS's Tariff/Terms and Conditions of Service, in effect at the time of shipping. These fees and charges are subject to change without notice. In accordance with the conditions of the solicitation, UPS has waived all pick-up charges, including on-call/on-demand, and capped fuel surcharges at 7%. Fuel surcharge information is posted on UPS's website, www.ups.com.

Region 4 - Southeast

States included: West Virginia, Virginia, Kentucky, Tennessee, North Carolina, South Carolina, Georgia, Alabama, Mississippi, Arkansas, Louisiana, Florida

Regional Instructions:

1. If Offeror cannot provide a cost for the scenario, put \$0.00 or leave Scenario blank.
2. Any Scenario with \$0.00 will receive no Cost Points for that line item.
3. The points assigned to each Offeror's cost proposal will be based on the lowest proposal price of each scenario. The Offeror with the lowest Proposed Price will receive 100% of the price points for that scenario. All other Offerors will receive a portion of the total cost points based on what percentage higher their Proposed Price is than the Lowest Proposed Price. An Offeror whose Proposed Price is more than double (200%) the Lowest Proposed Price will receive no points. The formula to compute the points is: $\text{Cost Points} \times (2 - \frac{\text{Proposed Price}}{\text{Lowest Proposed Price}})$.
4. Offeror shall describe each fee associated with the shipping scenario
5. Offeror to fill out the portions in Yellow.

Scenario #1 - Total of 80 Points Possible

TN, Express, Intrastate, Commercial: 3lb. package shipped from Nashville, TN 37243 to Jackson, TN 38302 (commercial address) via Express Priority Overnight (delivery by 10:30AM), scheduled daily pick-up.

Description of Fees:

UPS Next Day Air Guaranteed next business day delivery by 10:30 a.m., 12:00 p.m. or end of day, depending on destination, to all 50 states and Puerto Rico. (\$9.34)

Automatic Daily Pickup (\$0.00)

Total Cost:

\$9.34

Scenario #2 - Total of 80 Points Possible

FL Interstate, Ground: 10lb package shipped from 32399 to 22904; with address correction surcharge.

Description of Fees:

UPS Ground - day definite delivery in 1 - 5 days (\$8.89)

An address validated by UPS may be incorrect or incomplete for purposes of completing delivery, and may be corrected by UPS. (\$18)

Total Cost:

\$26.89

Scenario #3 - Total of 80 Points Possible

LA Interstate, Express 2nd day: 7lb package shipped from 70801 to 70114; declared signature required; declared value, express.

Description of Fees:

UPS 2nd Day Air Guaranteed delivery, by the end of the second business day, throughout the U.S. and Puerto Rico. (\$8.22)

Signature Required - UPS will obtain the necessary signature upon delivery. (\$5.55)

Declared value - UPS's liability is limited to \$100.00 on packages with no declared value. (\$0)

Total Cost:

\$13.77

Scenario #4 - Total of 80 Points Possible

GA Interstate, Ground: 10lb package shipped from 30301 to 31402; with address correction surcharge.

Description of Fees:

UPS Ground - day definite delivery in 1 - 5 days (\$7.44)

An address validated by UPS may be incorrect or incomplete for purposes of completing delivery, and may be corrected by UPS. (\$18)

Total Cost:

\$25.44

Scenario #5 - Total of 80 Points Possible

WV Interstate, Ground: 5lbs package shipped from 25301 to 25701; Saturday delivery

Description of Fees:

UPS Ground - day definite delivery in 1 - 5 days (\$6.75)

UPS Ground delivery on Saturday by end of day (\$4.00)

Total Cost:

\$10.75

Note: UPS offers customized rate sheets identifying its firm offer of rates and prices for transportation rates and prices. The rates and prices identified in the rate sheets will be guaranteed for 12-month periods and increase only with approval by the Lead State. Other fees and charges that may impact an authorized user's invoice are identified in UPS's Rate and Service Guide and as described in UPS's Tariff/Terms and Conditions of Service, in effect at the time of shipping. These fees and charges are subject to change without notice. In accordance with the conditions of the solicitation, UPS has waived all pick-up charges, including on-call/on-demand, and capped fuel surcharges at 7%. Fuel surcharge information is posted on UPS's website, www.ups.com.

Region 5 - Northeast

States included: Maine, Massachusetts, Rhode Island, Connecticut, New Hampshire, Vermont, New York, Pennsylvania, New Jersey, Delaware, Maryland

Regional Instructions:

1. If Offeror cannot provide a cost for the scenario, put \$0.00 or leave Scenario blank.
2. Any Scenario with \$0.00 will receive no Cost Points for that line item.
3. The points assigned to each Offeror's cost proposal will be based on the lowest proposal price of each scenario. The Offeror with the lowest Proposed Price will receive 100% of the price points for that scenario. All other Offerors will receive a portion of the total cost points based on what percentage higher their Proposed Price is than the Lowest Proposed Price. An Offeror whose Proposed Price is more than double (200%) the Lowest Proposed Price will receive no points. The formula to compute the points is: $\text{Cost Points} \times (2 - \frac{\text{Proposed Price}}{\text{Lowest Proposed Price}})$.
4. Offeror shall describe each fee associated with the shipping scenario
5. Offeror to fill out the portions in Yellow.

Scenario #1 - Total of 80 Points Possible

ME Intrastate, Express Overnight: 4lbs package shipped from 04609 to 04005; declared value.

Description of Fees:

UPS Next Day Air Guaranteed next business day delivery by 10:30 a.m., 12:00 p.m. or end of day, depending on destination, to all 50 states and Puerto Rico.

A Delivery Area Surcharge applies to packages delivered to ZIP Code 04005, air service (\$3.25)

Declared value - UPS's liability is limited to \$100.00 on packages with no declared value. (\$0)

Total Cost:

\$13.29

Scenario #2 - Total of 80 Points Possible

NY Intrastate, Ground, Residential: 15lb package shipped from 10002 to 14606; on-call pickup, same day; proof of delivery.

Description of Fees:

UPS Ground - day definite delivery in 1 - 5 days (\$8.33)

UPS On-Call Pickup® Area Surcharge – A surcharge applies to each residential UPS On-Call Pickup request at certain ZIP Codes within the 48 contiguous states. – Refer to the Area Surcharge Listing at ups.com/rates (\$0)

Proof of Delivery includes the time of delivery, full delivery address and the name and signature of the person who accepted your shipment, if available (\$3)

Total Cost:

\$11.33

Scenario #3 - Total of 80 Points Possible

NJ Interstate, Express 2nd day: 7lb package shipped from 07101 to 07087; declared signature required; declared value, express.

Description of Fees:

UPS 2nd Day Air Guaranteed delivery, by the end of the second business day, throughout the U.S. and Puerto Rico. (\$8.22)

Signature Required - UPS will obtain the necessary signature upon delivery. (\$5.55)

Declared value - UPS's liability is limited to \$100.00 on packages with no declared value. (\$0)

Total Cost:

\$13.77

Scenario #4 - Total of 80 Points Possible

MA Interstate, Ground: 10lb package shipped from 02101 to 01851; with address correction surcharge.

Description of Fees:

UPS Ground - day definite delivery in 1 - 5 days (\$7.18)

An address validated by UPS may be incorrect or incomplete for purposes of completing delivery, and may be corrected by UPS. (\$18)

Total Cost:

\$25.18

Scenario #5 - Total of 80 Points Possible

MD Interstate, Ground: 5lbs package shipped from 20743 to 21230; Saturday delivery

Description of Fees:

UPS Ground - day definite delivery in 1 - 5 days (\$6.75)

UPS Ground delivery on Saturday by end of day (\$4.00)

Total Cost:

\$10.75

Note: UPS offers customized rate sheets identifying its firm offer of rates and prices for transportation rates and prices. The rates and prices identified in the rate sheets will be guaranteed for 12-month periods and increase only with approval by the Lead State. Other fees and charges that may impact an authorized user's invoice are identified in UPS's Rate and Service Guide and as described in UPS's Tariff/Terms and Conditions of Service, in effect at the time of shipping. These fees and charges are subject to change without notice. In accordance with the conditions of the solicitation, UPS has waived all pick-up charges, including on-call/on-demand, and capped fuel surcharges at 7%. Fuel surcharge information is posted on UPS's website, www.ups.com.