

3D Microscopy: Confocal Imaging

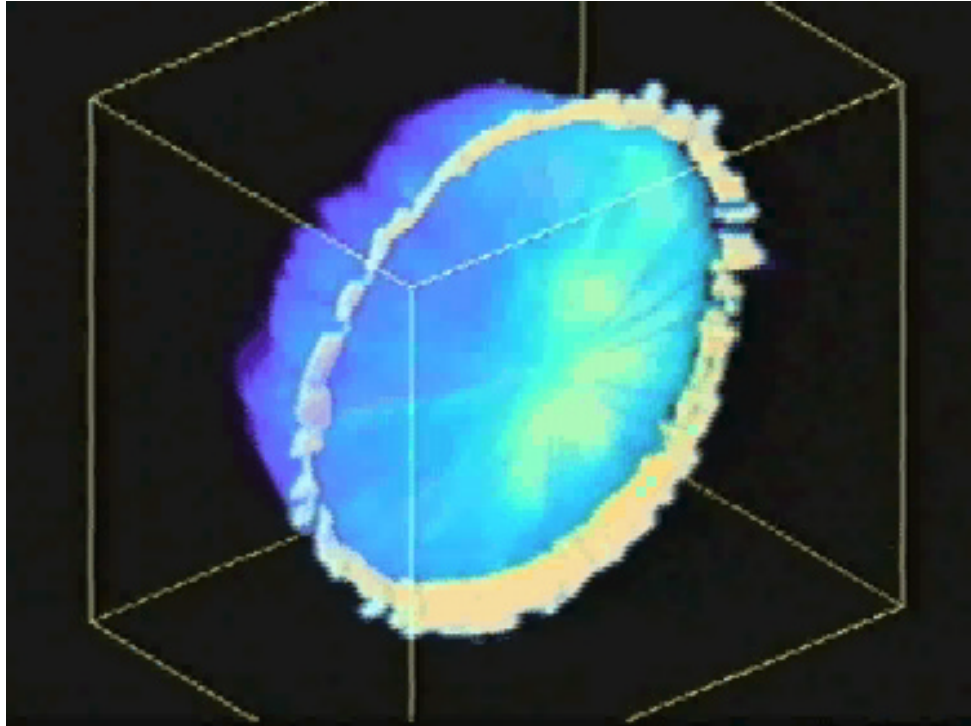

The Need For 3D Resolved Imaging

Biological systems are inherently 3D!

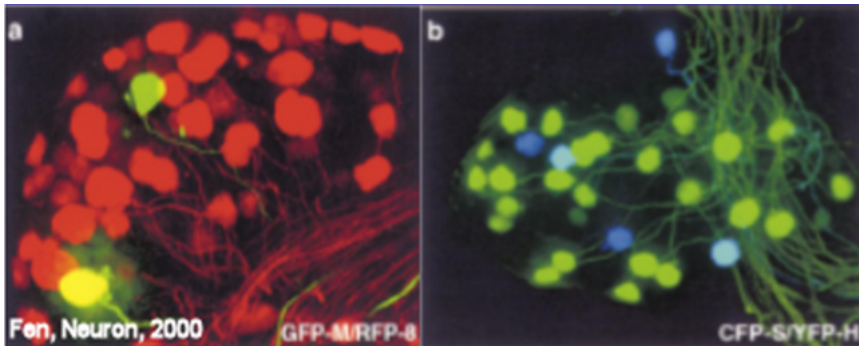
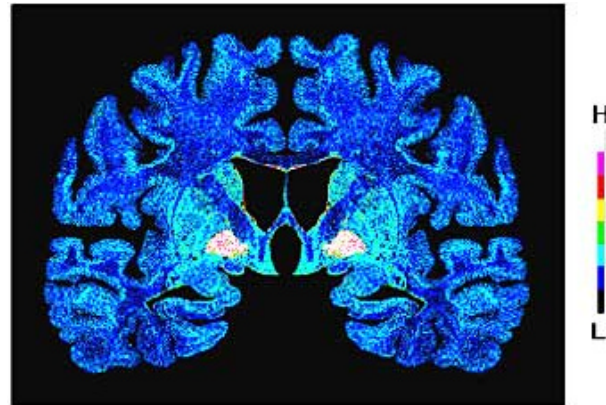

Biological processes also occur on multiple length scale

Histopathology

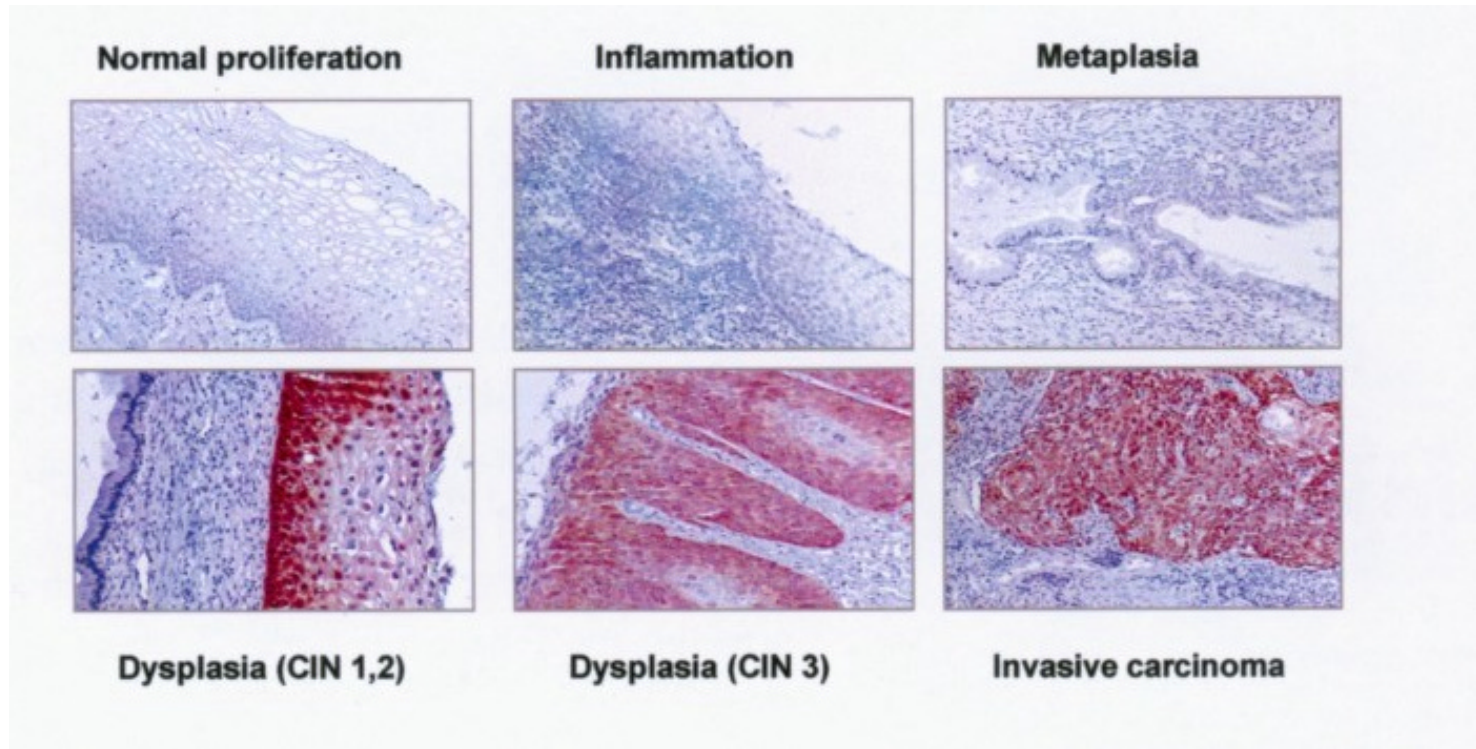

Solution: mechanical sectioning of specimen

Comment: (1) Clinical standard (2) Simple technology
(3) Sectioning artifacts (4) Not in vivo

Total Internal Reflection Microscopy

Solution: Evanescence wave at interfaces

Comments: (1) only basal surface structure (2) high z resolution, 50 nm

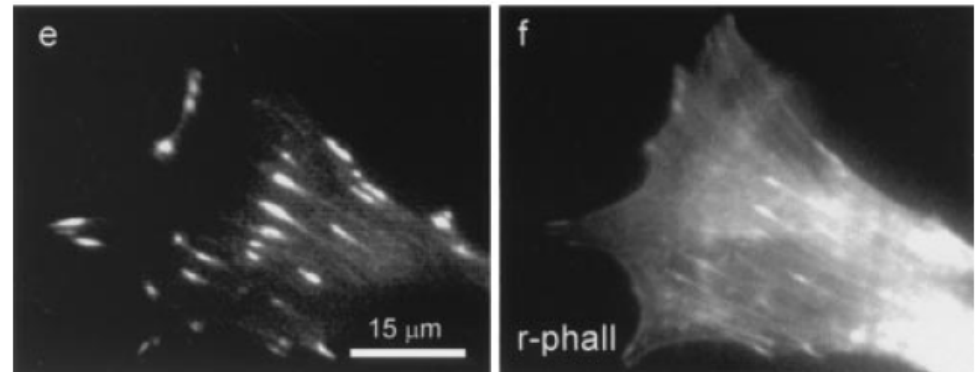
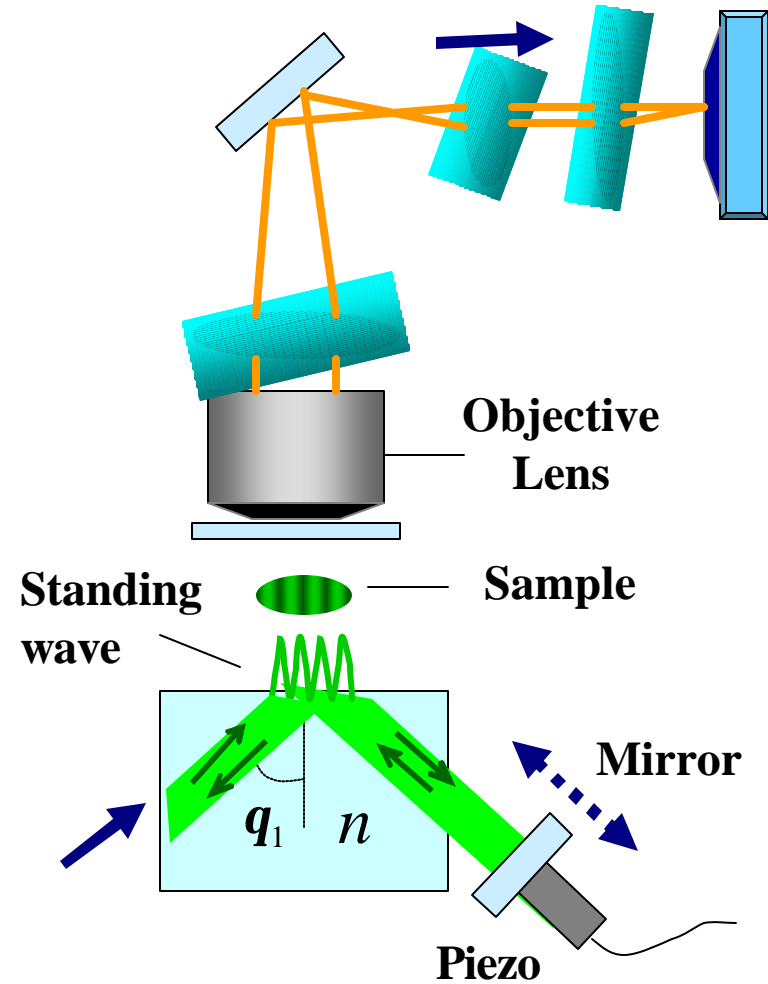

TIRF

Wide Field

True 3D Microscopy

Confocal Microscopy: Minsky, US Patent, 1961

Two-Photon Microscopy: Sheppard et al., IEEE J of QE, 1977
Denk et al., Science, 1990

The Invention of Confocal Microscopy

Confocal microscopy is invented by Prof. Melvin Minsky of MIT in about 1950s.

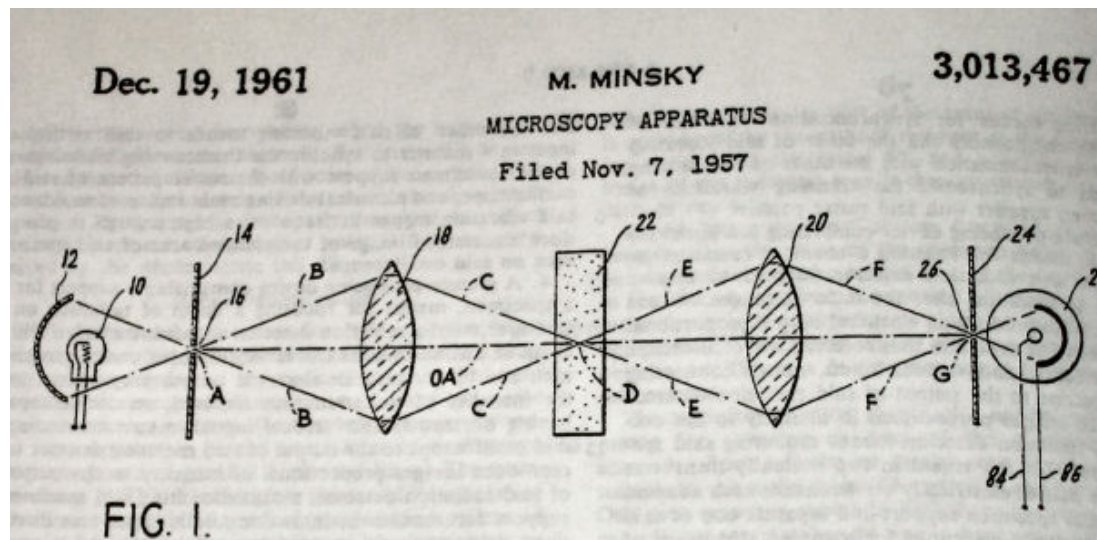
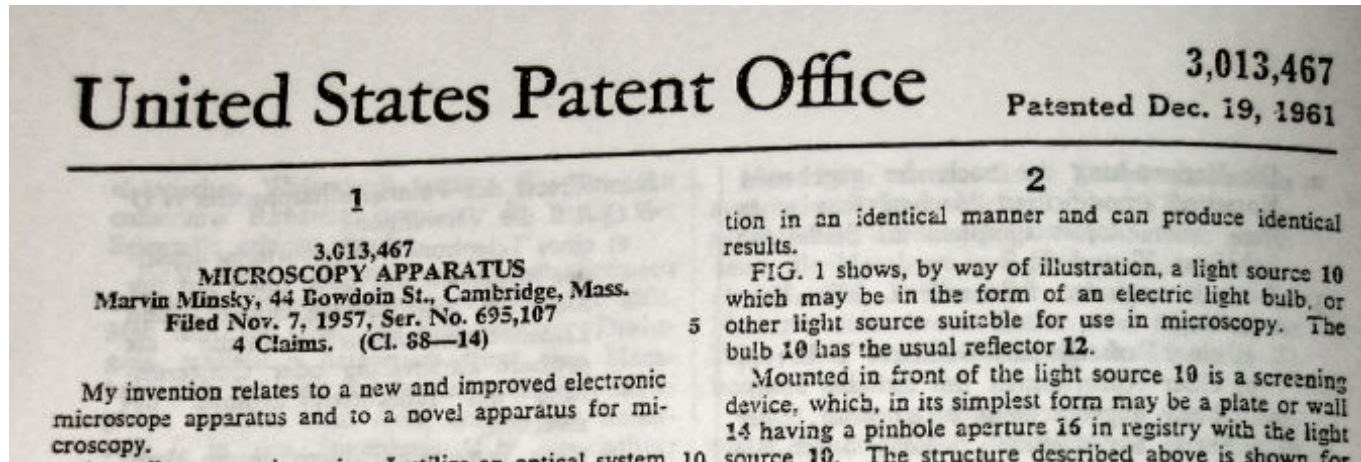

Point Spread Function of Confocal Microscopy

Lateral Dimension: Airy function

$$PSF_{confocal}(kr) \propto \left[\frac{2J_1(kr)}{kr} \right]^4$$

k is the wave number

Axial Dimension : Sinz function

$$PSF_{confocal}(kz) \propto \left[\frac{\sin(kz)}{kz} \right]^4$$

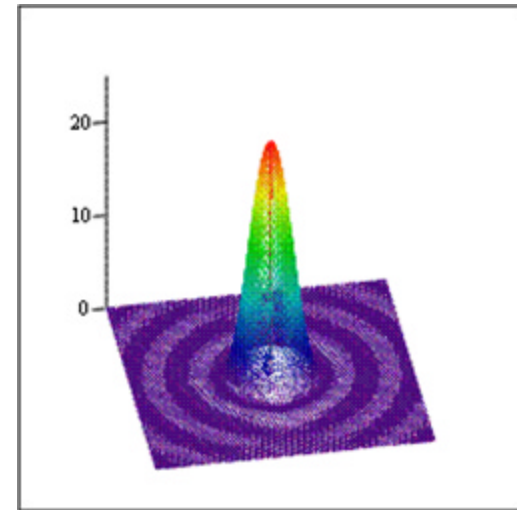
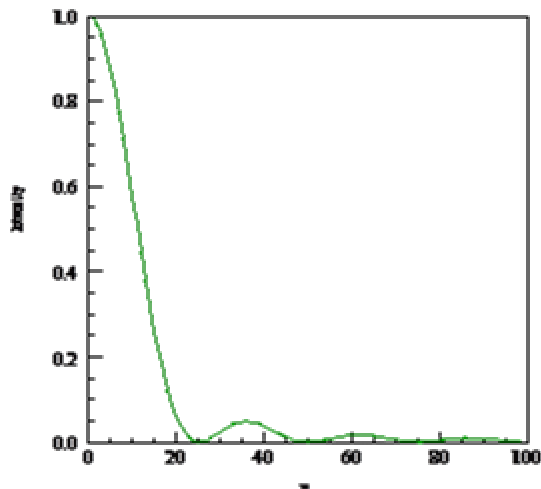

8

Resolution:

$$\text{Lateral} \propto NA$$

$$\text{Axial} \propto NA^2$$

Depth discrimination

For a uniform specimen, we can ask how much fluorescence is generated at each z-section above and below the focal plane assuming that negligible amount of light is absorbed throughout.

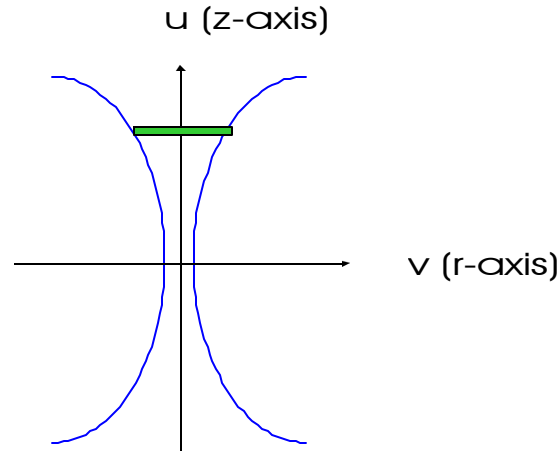

$$F_{z\text{-sec}}(u) \equiv 2\mathbf{p} \int_0^{\infty} F(u, v) v dv$$

Depth discrimination

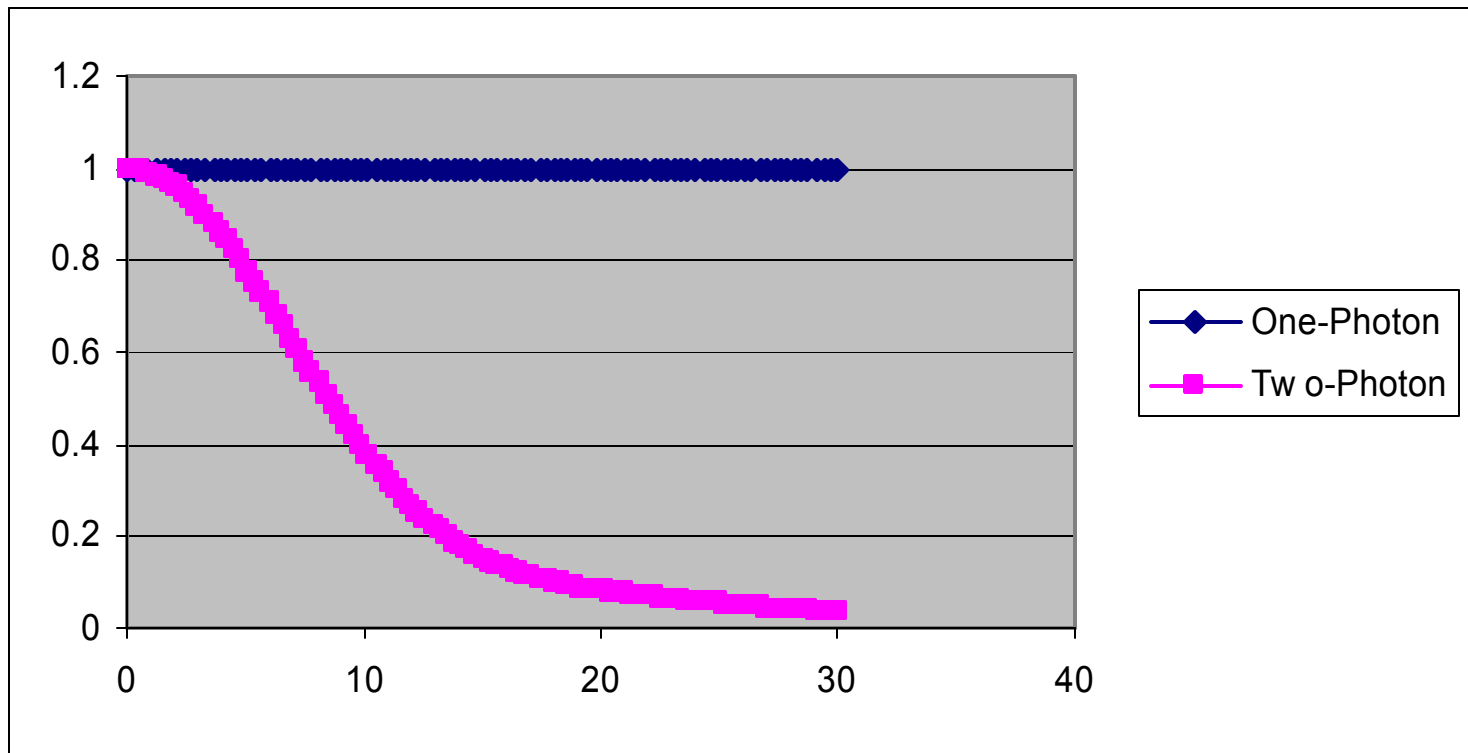

Early Demonstration of Confocal Microscopy in Biological Imaging

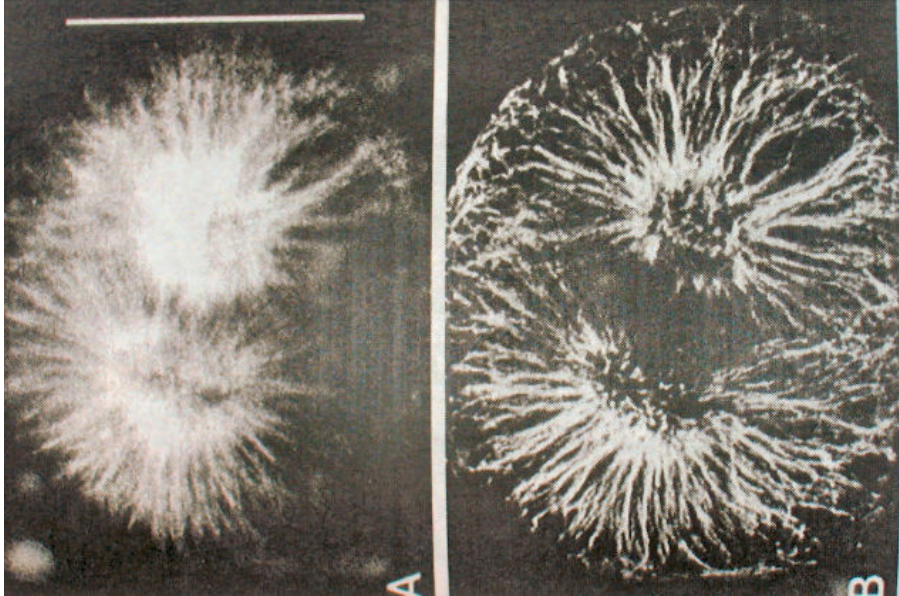
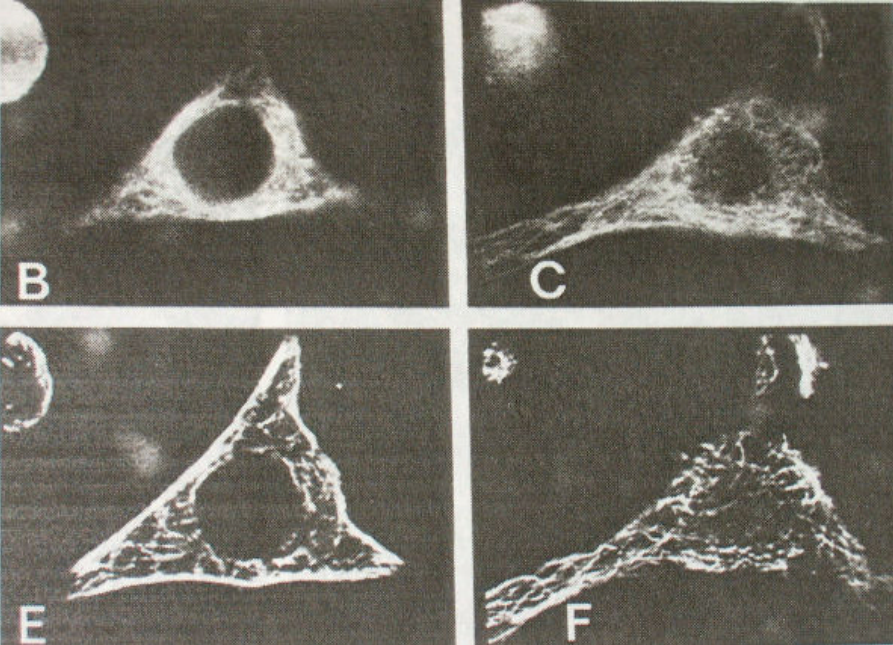

White et al., JCB 1987

Some Recent Application of Confocal Tissue Imaging

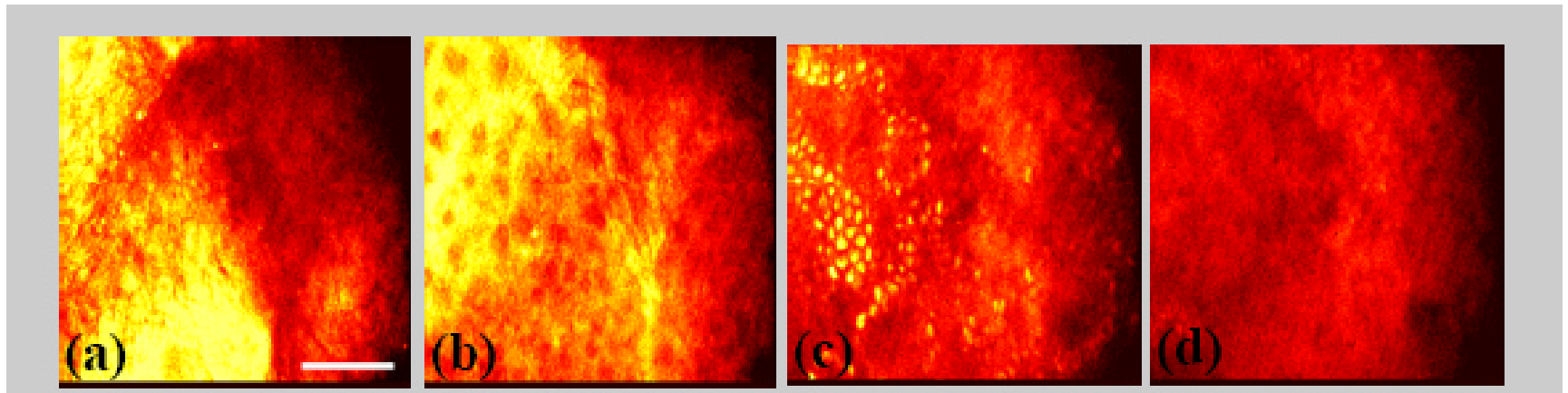
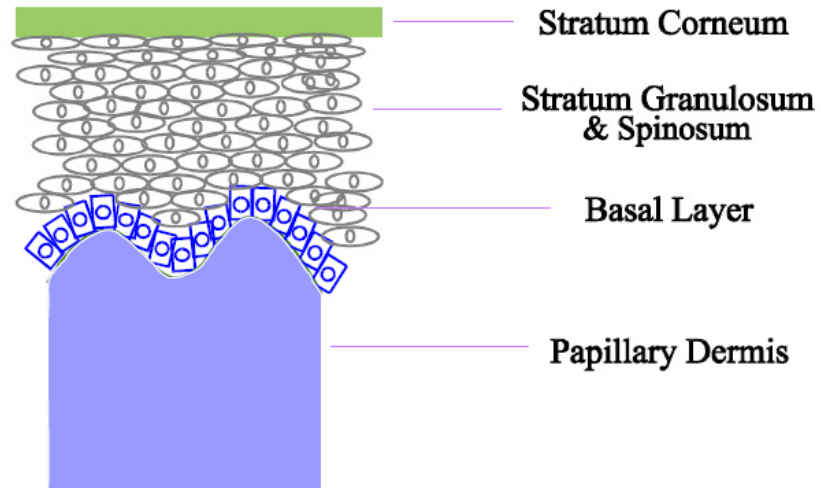

Confocal Tissue Imaging

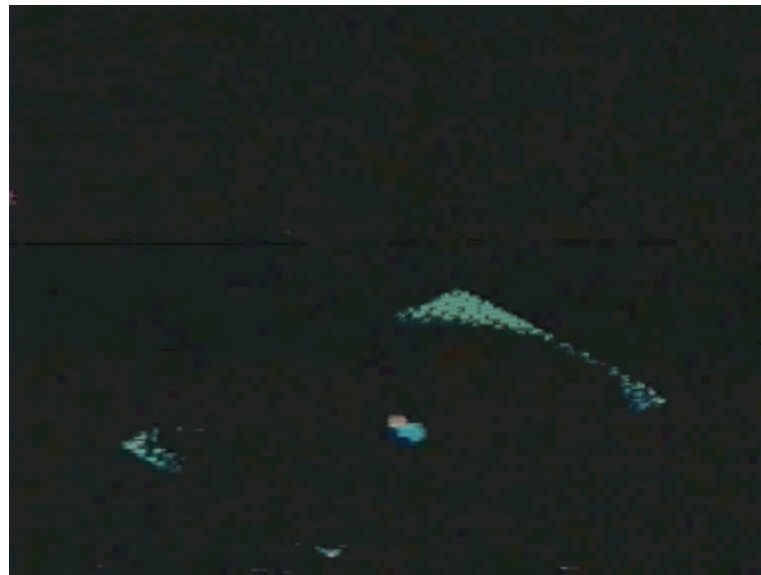
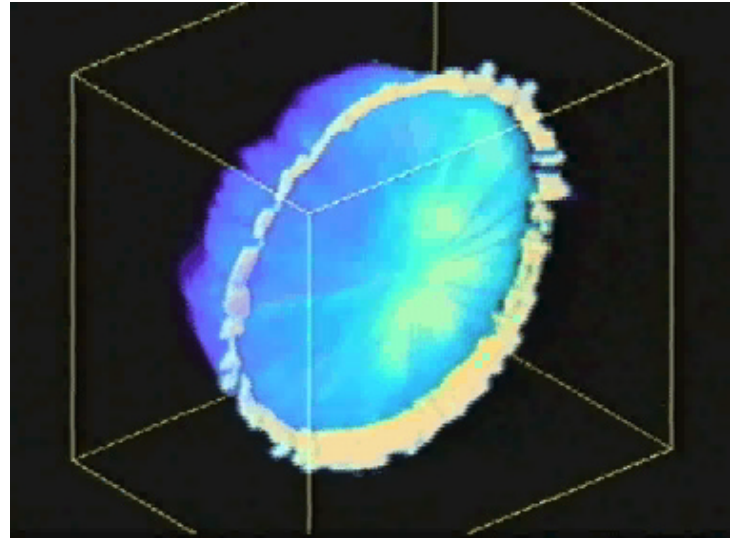
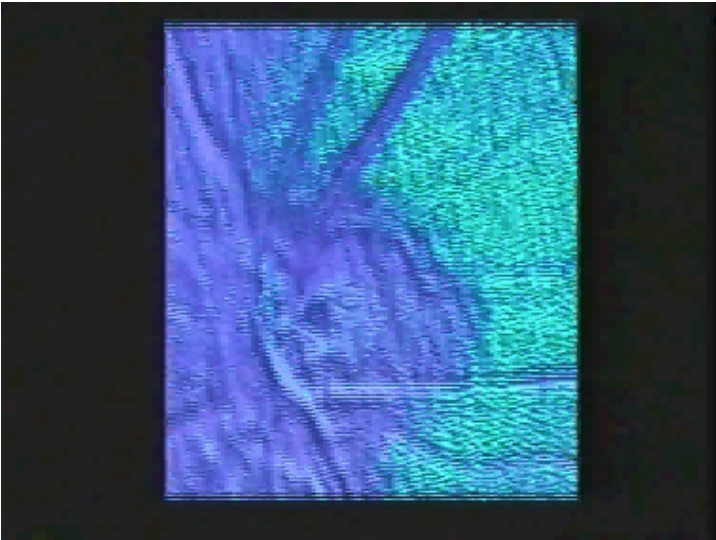

Tandem Scanning Confocal Microscope

Utilizes a Nipkow Disk

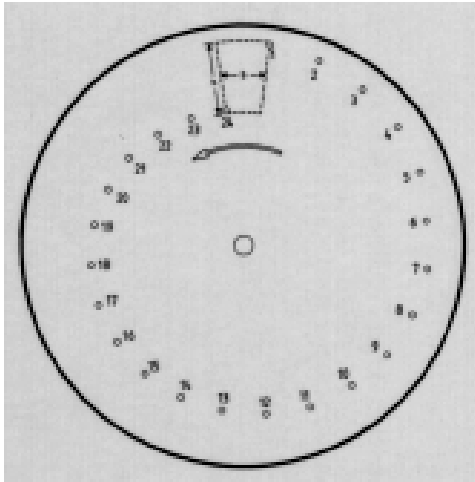

Holes organize in an Archimedes spiral

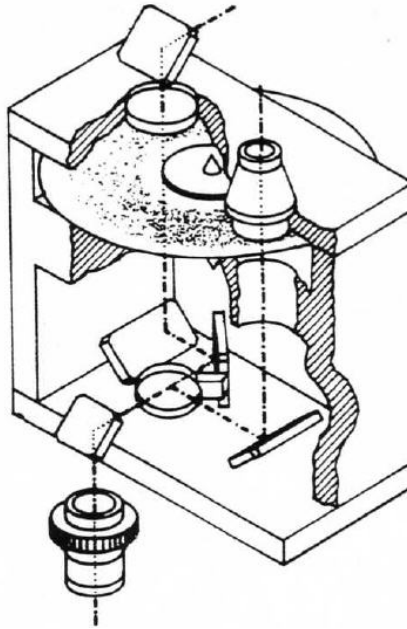

Petran's System



A Model Tandem Confocal Microscope Utilizing Yokogawa Scan Head

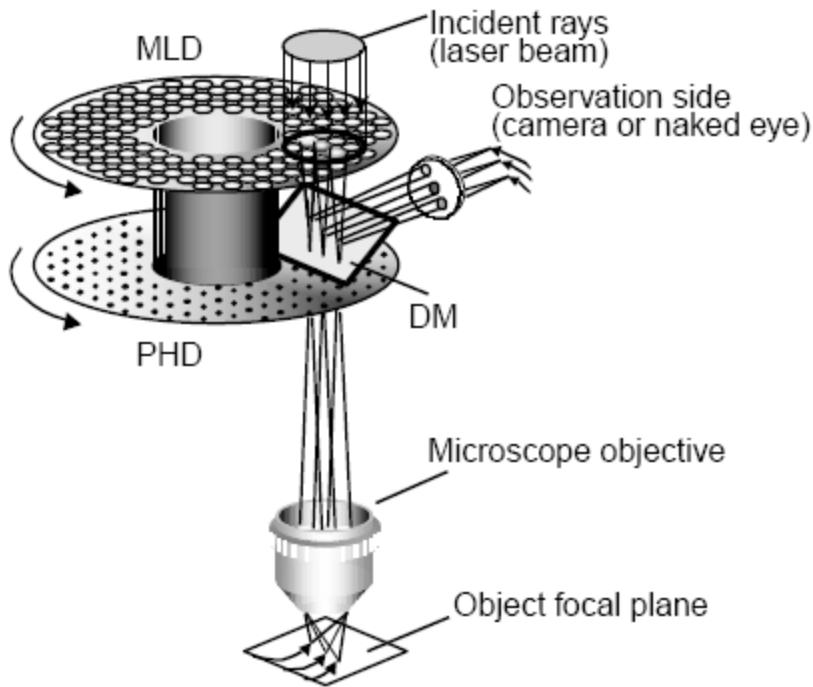

Eliminate light throughput Issue by spinning both a plate of lenslets and nother plate of pinholes

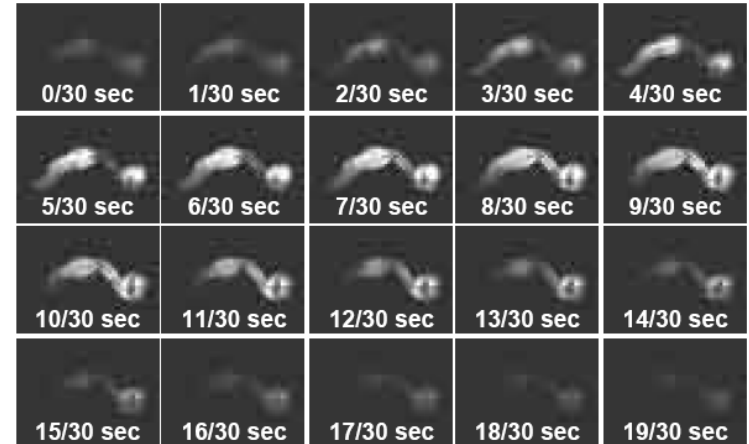

C. Elegans

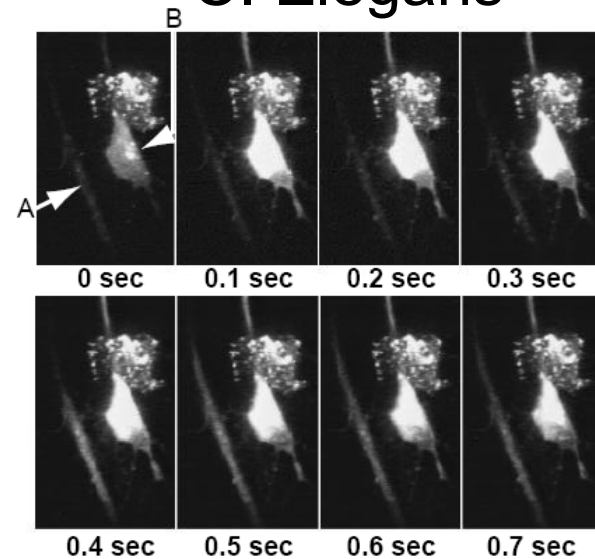

Calcium events in nerve fiber