



Mastercycler pro

Operating Manual

eppendorf



Copyright© 2008 Eppendorf AG, Hamburg. No part of this publication may be reproduced without the prior permission of Eppendorf AG.

Trademarks

eppendorf®, Mastercycler®, SteadySlope® and vapoprotect® are registered trademarks of Eppendorf AG, Hamburg, Germany.

Registered trademarks are not marked in all cases in this manual.

This product is licensed under U.S. patent Nos. 5,525,300, 5,779,981 and 6,054,263. The heated cover device is licensed under US 5,552,580 and foreign equivalents.

The user of the Eppendorf Mastercycler pro might require additional rights for kits, reagents and other components required for his/her application. Such accompanying rights for these kits, reagents and other may be obtained by the respective holder of such rights.

No rights are conveyed expressly, by implication or estoppel to any patents on real-time methods, including but not limited to 5' nuclease assays, or to any patent claiming a reagent or kit. For further information on purchasing licenses, contact the Director of Licensing at Applied Biosystems, 850 Lincoln Centre Drive, Foster City, California 94404, USA.

Table of contents

- 1 User instructions 8**
 - 1.1 Using this manual 8
 - 1.2 Warning signs and hazard icons 8
 - 1.3 Symbols used 8
 - 1.4 Abbreviations used 9
- 2 Product description 10**
 - 2.1 Main illustration 10
 - 2.2 Delivery package 12
 - 2.2.1 Mastercycler pro and Mastercycler pro S 12
 - 2.2.2 Mastercycler pro 384 12
 - 2.3 Features 13
 - 2.3.1 Features of the Mastercycler pro variants 13
 - 2.3.2 Networking 13
- 3 Safety 14**
 - 3.1 Intended use 14
 - 3.2 User profile 14
 - 3.3 Note on product liability 14
 - 3.4 Warnings for intended use 14
 - 3.5 Warning signs on the device 17
- 4 Installation 18**
 - 4.1 Unpacking the device 18
 - 4.2 Selecting location 18
 - 4.2.1 Space requirements and bearing capacity 18
 - 4.2.2 Mains connection 19
 - 4.3 Installing instrument 19
 - 4.4 Shut down 22
- 5 Operation 23**
 - 5.1 Initial steps 23
 - 5.1.1 Using the vapo.protect heated lid 23
 - 5.1.2 Control panel keys 25
 - 5.2 Initial start-up of the Mastercycler pro 26
 - 5.2.1 Defining the administrator PIN 26
 - 5.2.2 Other steps 27
 - 5.3 User login and logout 27
 - 5.3.1 Logging in as a user 27
 - 5.3.2 Changing the user 28
 - 5.3.3 Logging out as a user 28
 - 5.4 Overview of operation with the control panel 29
 - 5.4.1 Navigation tree overview 29
 - 5.4.2 Using the navigation tree 30
 - 5.4.3 Using external storage media 31
 - 5.4.4 Selecting export file formats 32
 - 5.5 Managing folders and programs 33
 - 5.5.1 Creating folders and programs 33
 - 5.5.2 Copying folders and programs 34
 - 5.5.3 Deleting folders and programs 34

Table of contents

EN

Operating Manual

| | | |
|----------|--|-----------|
| 6 | Programming | 35 |
| 6.1 | Overview of the program editor | 35 |
| 6.1.1 | Opening the program editor | 35 |
| 6.1.2 | Structure of the program editor | 35 |
| 6.2 | Defining general settings | 36 |
| 6.2.1 | Opening the header | 36 |
| 6.2.2 | Editing header settings | 36 |
| 6.3 | Editing programs | 37 |
| 6.3.1 | Inserting a program step | 37 |
| 6.3.2 | Editing parameters | 38 |
| 6.3.3 | Deleting individual program steps | 40 |
| 6.3.4 | Deleting all program steps | 40 |
| 6.3.5 | Exporting a program listing | 40 |
| 6.3.6 | Saving a program and exiting the editor | 40 |
| 7 | PCR run | 41 |
| 7.1 | Preparation | 41 |
| 7.1.1 | Selecting the sample tubes | 41 |
| 7.1.2 | Loading the thermoblock | 41 |
| 7.1.3 | Sample volume | 42 |
| 7.2 | Starting the program | 42 |
| 7.2.1 | Status view | 43 |
| 7.3 | Interrupting or stopping the program | 44 |
| 7.3.1 | Interrupting the program | 44 |
| 7.3.2 | Continuing the program | 44 |
| 7.3.3 | Stopping the program | 44 |
| 7.4 | Using protocols | 44 |
| 7.5 | Shutting down and switching off the device | 45 |
| 8 | System management | 46 |
| 8.1 | Administrator functions | 46 |
| 8.2 | Managing user accounts | 46 |
| 8.2.1 | Creating user accounts | 46 |
| 8.2.2 | Editing user accounts | 47 |
| 8.2.3 | Deleting user accounts | 47 |
| 8.2.4 | Changing the PIN | 47 |
| 8.3 | System settings | 48 |
| 8.4 | Cycler functions | 49 |
| 8.4.1 | Cycler system functions | 50 |
| 8.4.2 | Self test | 50 |
| 8.5 | Managing and backing up data | 51 |
| 8.5.1 | Backing up data | 51 |
| 8.5.2 | Exporting and importing programs | 51 |
| 8.6 | Updating the control panel software | 52 |
| 8.6.1 | Performing an automatic software update | 52 |
| 8.6.2 | Performing a manual software update | 53 |
| 8.7 | Transferring programs from the Mastercycler 533x | 54 |

Table of contents

9 Quick start **55**

9.1 Login 55

9.2 Creating folders and programs 56

9.3 Copying folders and programs 56

9.4 Deleting folders and programs 57

9.5 Editing programs 57

9.6 Stopping and starting programs 58

9.7 Switching off the device 59

10 Maintenance **60**

10.1 Cleaning 60

 10.1.1 Cleaning the housing 60

 10.1.2 Cleaning the heated lid 61

10.2 Disinfection / decontamination 62

10.3 Decontamination before shipping 63

11 Troubleshooting **64**

11.1 General errors 64

11.2 Error messages 64

12 Transport, storage and disposal **65**

12.1 Packing 65

12.2 Transport 66

12.3 Disposal 66

13 Technical data **67**

13.1 Power supply 67

13.2 Weight / dimensions 67

13.3 Ambient conditions 67

13.4 Application parameters 67

13.5 Control panel 68

14 Ordering information **69**

14.1 Mastercycler pro 69

14.2 Accessories 69

14.3 Consumables 69

14.4 Recommended auxiliary materials 70

15 Index **71**

1 User instructions

1.1 Using this manual

- ▶ Read the operating manual before you operate the device for the first time.
- ▶ Please view this operating manual as part of the product and keep it somewhere easily accessible.
- ▶ If this operating manual is lost, please request another one. The current version of the operating manual can be found on our website www.eppendorf.com.



The procedures in this manual are described for the operation with the keyboard of the control panel and the language setting **english**.

Alternatively, you have the following possibilities:

- Mastercycler pro operation using the mouse (see p. 22).
- Setting the dialog language to German (see p. 48).

1.2 Warning signs and hazard icons

| Representation | Meaning |
|----------------|---|
| | DANGER Risk of electric shock with potential for severe injury or death as a consequence. |
| | DANGER Risk of explosion with potential for severe injury or death as a consequence. |
| | DANGER Bio hazard with potential for risk to health or death as a consequence. |
| | DANGER Risk of burns. |
| | WARNING Warning of potential injury or health risk. |
| | CAUTION Refers to risk of damage to property. |
| | Refers to particularly useful information and tips. |

1.3 Symbols used

| Symbol | Meaning |
|-------------|--|
| ▶ | You are requested to perform an action. |
| 1. | Perform these actions in the sequence described. |
| 2. | |
| • | List. |
| Text | Terms and names of keys from the software. |

1 User instructions

1.4 Abbreviations used

| | |
|------------|--|
| ESP | Electronic Sample Protection |
| PCL | Printer Command Language (standard for controlling printers) |
| PCR | Polymerase Chain Reaction |
| PDF | Portable Document Format |
| PIN | Personal Identification Number |
| PS | PostScript® (standard for controlling printers) |
| TSP | Thermal Sample Protection |
| USB | Universal Serial Bus |

2 Product description

2.1 Main illustration

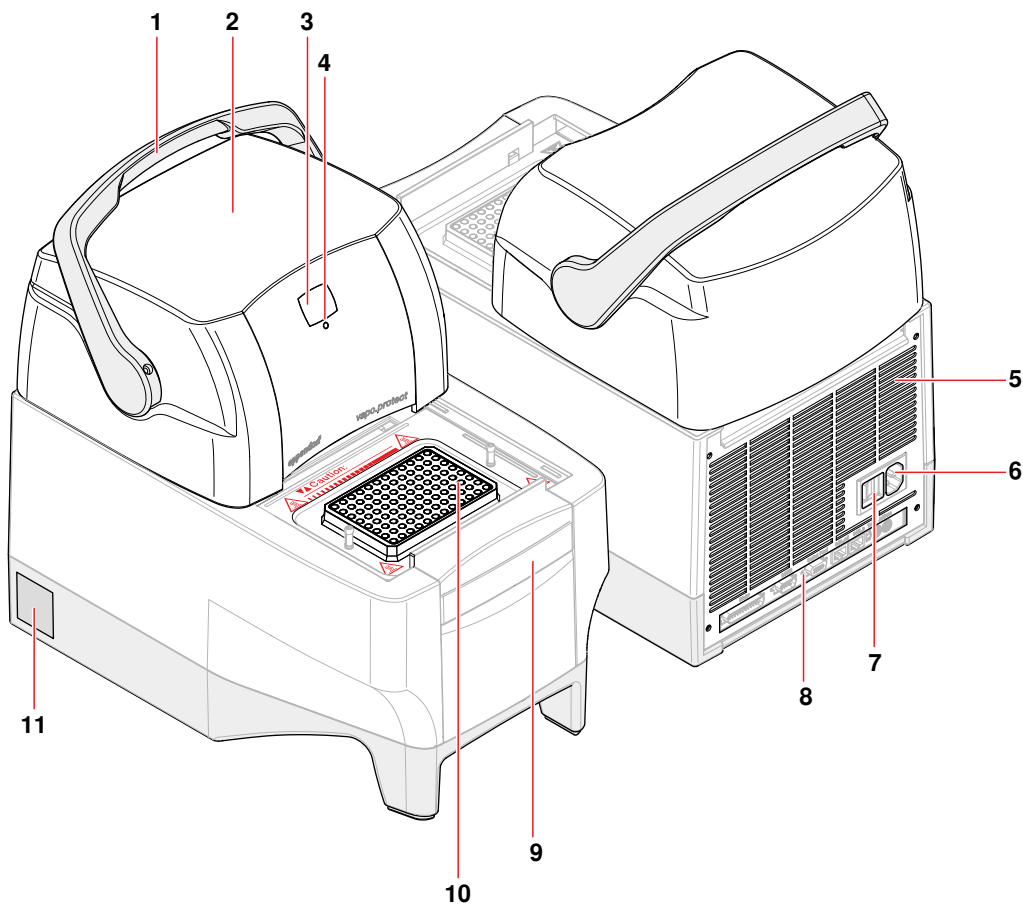

Fig. 1: Mastercycler pro - front and rear view

| | |
|---|--|
| <p>1 Lid handle For opening and closing and also locking and unlocking the heated lid.</p> | <p>2 heated lid</p> |
| <p>3 Address display</p> | <p>4 Status lamp</p> |
| <p>5 Rear plate with ventilation slots</p> | <p>6 Mains connection socket</p> |
| <p>7 Mains switch 0 = switched off, I = switched on.</p> | <p>8 Terminal block See detail drawing (Fig. 2 on p. 11).</p> |
| <p>9 Retaining clip For control panel.</p> | <p>10 Thermoblock</p> |
| <p>11 Nameplate</p> | |

2 Product description

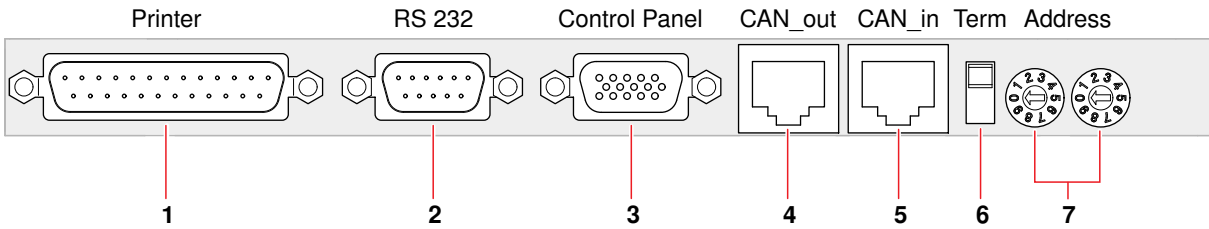

Fig. 2: Terminal block

| | |
|---|--|
| <p>1 Parallel interface Connection for printer.</p> | <p>2 Serial interface (RS 232) Connection for Eppendorf temperature validation system.</p> |
| <p>3 Control panel connection</p> | <p>4 CAN out Data outlet for connecting several Mastercycler pro or Mastercycler ep.</p> |
| <p>5 CAN in Data inlet for connecting several Mastercycler pro or Mastercycler ep.</p> | <p>6 Term switch Termination of CAN bus when networking several Mastercycler pro or Mastercycler ep. Lower position: ON. Upper position: OFF.</p> |
| <p>7 Address dial Setting of device address when networking several Mastercycler pro or Mastercycler ep.</p> | |

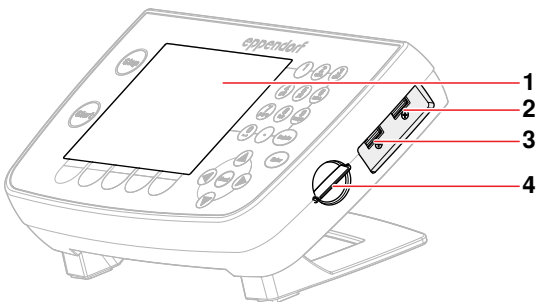

Fig. 3: Control panel

| | |
|--|--|
| <p>1 Display</p> | <p>2 USB port 1 For mouse, printer or storage medium.</p> |
| <p>3 USB port 2 For mouse, printer or storage medium.</p> | <p>4 MMC slot For data exchange via a MultiMediaCard (MMC).</p> |

Only devices meeting the IEC 950/EN 60950 (UL 1950) standards may be connected to the interfaces of the Mastercycler pro and the control panel.

2 Product description

2.2 Delivery package

The delivery package differs depending on the variant of your Mastercycler pro.

2.2.1 Mastercycler pro and Mastercycler pro S

| Quantity | Order No. (International) | Order No. (North America) | Description |
|----------|------------------------------|------------------------------|--|
| 1 or | 6321 000.019 6321 000.027 | - 950030010 | Mastercycler pro 230 V / 50 - 60 Hz 120 V / 50 Hz, with US-plug |
| or or | 6325 000.013 6325 000.021 | - 950030020 | Mastercycler pro S 230 V / 50 - 60 Hz 120 V / 50 Hz, with US-plug |
| 1 | 6321 900.150 | - | Operating Manual |
| 1 | - | - | Certificate of Conformity |
| 1 | - | - | Mains cable |
| 1 | - | - | Eppendorf PCR tubes 0.2 mL 100 pieces |
| 1 | - | - | Eppendorf twin.tec skirted 96-well PCR plates PCR clean, 2 pieces |
| 1 | - | - | PCR film self-adhesive, 5 pieces |

2.2.2 Mastercycler pro 384

| Quantity | Order No. (International) | Order No. (North America) | Description |
|----------|------------------------------|------------------------------|--|
| 1 or | 6324 000.010 6324 000.028 | - 950030030 | Mastercycler pro 384 230 V / 50 - 60 Hz 120 V / 50 Hz, with US-plug |
| 1 | 6321 900.150 | - | Operating Manual |
| 1 | - | - | Certificate of Conformity |
| 1 | - | - | Mains cable |
| 1 | - | - | Eppendorf twin.tec 384-well PCR plates 2 pieces |
| 1 | - | - | PCR film self-adhesive, 5 pieces |

2 Product description

2.3 Features

| | |
|----------------------------------|---|
| Product variants | The Mastercycler pro is available in three variants. <ul style="list-style-type: none"> • Mastercycler pro • Mastercycler pro S • Mastercycler pro 384 <p>All variants are provided with the following features:</p> |
| Triple circuit technology | All Mastercycler pro thermomodules feature extremely fast heating and cooling rates. Triple circuit technology ensures a homogeneous temperature distribution and enables the generation of specific temperature gradients for PCR optimizations. |
| SteadySlope | SteadySlope technology ensures that the heating and cooling ramp rates for thermal modules are identical in both gradient and normal operation. That means you can expect identical temperature control characteristics in both optimization and routine experiments, as well as a reliable transfer of the optimization results to the routine application. |
| vapo.protect | All variants of the Mastercycler pro are equipped with a <i>vapo.protect</i> heated lid. A flexible pressure element ensures that force is applied evenly to the surface of the tubes or plate. This reduces evaporation from the reaction sample effectively. The <i>vapo.protect</i> heated lid performs an automatic tube height adjustment for all sample tubes and PCR plates. |
| TSP | The heated lid of the Mastercycler pro series is equipped with TSP technology (Thermal Sample Protection). The thermoblock is continuously kept at 20 °C during the lid heating phase. This means TSP reduces the thermal load on your samples and minimizes the probability of non-specific product formation during the PCR. |
| Self test function | Via the integrated self test function, the Mastercycler pro in combination with the control panel with USB connections can check whether the thermoblock is functioning properly without the need for any further tools. A separately available USB key is required for the self test function (see <i>Accessories</i> on page 69). |
| Control | The Mastercycler pro is controlled via the control panel. It can also be controlled via the CycleManager pro PC software. |

2.3.1 Features of the Mastercycler pro variants

| Variant | Features |
|----------------------|---|
| Mastercycler pro | <ul style="list-style-type: none"> • Freely programmable temperature gradient over 12 rows. • Gradient range of up to 20 °C. • Robust, specially coated aluminum block. • Holds up to 96 PCR tubes (0.2 mL) or a 96-well PCR plate. |
| Mastercycler pro S | <ul style="list-style-type: none"> • Highest temperature control speed due to silver block: up to 6 °C/s. • Standard PCR possible in under 30 min. • Pulse function for device-driven hot start for avoiding non-specific PCR product formation. • Freely programmable temperature gradient over 12 rows. • Extended gradient range of up to 24 °C. • Holds up to 96 PCR tubes (0.2 mL) or a 96-well PCR plate. |
| Mastercycler pro 384 | <ul style="list-style-type: none"> • Freely programmable temperature gradient over 24 rows. • Gradient range of up to 20 °C. • Holds a 384 well PCR plate. |

2.3.2 Networking

| | |
|------------------------------|---|
| Mini-satellite system | Up to five devices from the Mastercycler pro or Mastercycler ep series can be interconnected and operated via a central control panel. The procedure for setting up this type of configuration is described separately (see <i>Operating multiple Mastercycler pro via a control panel ("mini-satellite" system)</i> on page 20). |
| PC control | You can use the PC software CycleManager pro to control up to 30 devices from the Mastercycler pro or Mastercycler ep series in a network. This software is available separately for purchase (see <i>Accessories</i> on page 69). |

3 Safety

3.1 Intended use

The Mastercycler pro is intended to be used in research and routine laboratories in the field of life science.

The Mastercycler pro is used to control the temperature of aqueous solutions, suspensions, and emulsions in closed micro test tubes for enzymatic reactions, typically for polymerase chain reaction (PCR).

The Mastercycler pro is intended exclusively for indoor use.

3.2 User profile

This device must only be used by skilled personnel with the appropriate training.

Before using the device, read the operating manual carefully and familiarize yourself with the device's mode of operation.

3.3 Note on product liability

In the following cases the protection provided in the device may be impaired. The liability for the function of the device passes to the operator if:

- The device is not used in accordance with the operating manual.
- The device is used outside the range of application described herein.
- The device is used with accessories or consumables (e.g. tubes and plates) which are not recommended by Eppendorf.
- The device is maintained or repaired by persons not authorized by Eppendorf.
- The owner has made unauthorized modifications to the device.

3.4 Warnings for intended use

Read the operating manual first and follow the general safety instructions below before using the Mastercycler pro.



Risk of explosion!

- ▶ Do not operate the device in rooms where work is being carried out with explosive substances.
- ▶ Do not use this device to process any explosive or highly reactive substances.
- ▶ Do not use this device to process any substances which could create an explosive atmosphere.



Risk when handling toxic or radioactively-marked liquids or pathogenic germs.

- ▶ Follow national regulations governing the handling of these substances.
- ▶ For complete instructions regarding the handling of germs or biological material of risk group II or higher, please refer to the "Laboratory Biosafety Manual" (Source: World Health Organization, current edition of the Laboratory Biosafety Manual).



Warning! Risk to health and bio hazard when operated with lid open.

The tube lids may pop open at high block temperatures.

- ▶ Close the lid of the device when heating samples.



Danger! Electric shock as a result of penetration of liquid.

- ▶ Switch off the device and disconnect it from the power supply before starting cleaning or disinfecting.
- ▶ Do not allow any liquids to enter the inside of the housing.
- ▶ Do not perform spray disinfection.
- ▶ Only reconnect the device to the power supply once it is completely dry.

3 Safety



Danger! Lethal voltages inside the device.

- ▶ Ensure that the housing is always closed and undamaged so that no parts inside the device can be contacted by accident.
- ▶ Do not remove the housing of the device.
- ▶ Do not allow the device to be opened by anyone except service personnel who have been specifically authorized by Eppendorf.



Danger! Electric shock.

- ▶ Switch off the device and disconnect the power plug before starting to maintain or clean.



Warning! Damage due to incorrect power supply.

- ▶ Only connect the device to power sources that match the electrical specifications on the device's nameplate.
- ▶ Use only sockets with protective earth.



Warning! Injury from trapping or crushing.

- ▶ Do not place your fingers between the lid and the housing when opening and closing the device or when opening it into the cleaning position.
- ▶ Do not reach in under the open lid.
- ▶ Take care that the stand is properly engaged so that the lid stays in the opened position.



Warning! Burns from hot thermoblock and heated lid.

The thermoblock, the inner side of the heated lid and micro test tubes/PCR plates can reach temperatures of over 50 °C very quickly.

- ▶ The heated lid should be kept closed until temperatures of 30 °C or less are reached.
- ▶ Take note of the symbols on the thermoblock warning that surfaces may be hot.
- ▶ If you are using well caps consisting of thermally insulating material, please keep in mind that the temperature on the inside of the heated lid can be significantly higher than the temperature displayed.
- ▶ Before starting cleaning wait for the thermoblock and heated lid to cool down.



Warning! Injury from sharp-edged components.

When the Mastercycler pro is in the open position, sharp-edged components are exposed.

When cleaning the Mastercycler pro, the sharp edges on the rollflex cable and the guide rail may cause injuries.

- ▶ Take special care and wear protective gloves.



Warning! Risk to health if used incorrectly.

If incubation is performed incorrectly, sample material may be released and the thermoblock and the heated lid damaged.

- ▶ Ensure that the PCR plates are correctly inserted in the thermoblock.
- ▶ Always close the heated lid before heating the samples to prevent the lids of the tubes from bursting open.

3 Safety



Warning! Risk to health from contaminated device

- ▶ Perform decontamination before storing or dispatching the device and/or its accessories.



Caution! Unsuitable tubes can result in sample material escaping.

Unsuitable tubes may be so severely damaged that sample material is released.

- ▶ Use only tubes whose properties meet at least the requirements specified in these operating instructions.
- ▶ This is especially important when working with infectious material.



Warning! Poor safety due to incorrect accessories and spare parts.

The use of accessories and spare parts other than those recommended by Eppendorf may impair the safety, function and precision of the device. Eppendorf accepts no warranty or liability for damage caused by non-recommended accessories and spare parts or incorrect use.

- ▶ Use only accessories recommended by Eppendorf and original spare parts.



Warning! Risk of injury when lifting and transporting the device.

Lifting the device with the wrong posture may cause serious damage to your health. If the device falls to the ground it can cause injuries.

- ▶ Do not lift the device by the handle or the housing of the heated lid.
- ▶ Carry the device securely with both hands to prevent it from slipping.
- ▶ Always keep a straight back when lifting and carrying the device.

Caution! Damage to heated lid from sharp-edged sample tubes or objects.

- ▶ Use only tubes whose properties meet at least the requirements specified in these operating instructions.
- ▶ Do not use any sharp-edged or sharp objects on the heated lid.
- ▶ Extra caution should be exercised when cleaning so as not to damage the heated lid.

Caution! Escaping liquid can cause damage to the device.

If the flexible pressure unit of the heated lid is damaged, liquid can escape and enter the device.

1. Leave the lid open.
2. Disconnect the power plug immediately from the power supply.
3. Contact Eppendorf Service.

Caution! Damage to the thermoblock from incorrect operation.

- ▶ Do not fill sample material directly into the thermoblock.

Caution! Damage to electronic components through formation of condensation.

After the device has been moved from a cool to a warmer environment, formation of condensation can occur inside the device.

- ▶ Allow the device to warm up for at least 12 hours after being set up before you connect it to the mains power supply.

Caution! Material damage from uneven work surface.

- ▶ Position the device on level and stable work surface which is capable of bearing the weight of the device. The device must not be placed on a trolley or at an angle.

3 Safety

Caution! Damage due to overheating.

- ▶ Do not place the device close to sources of heat (e.g. radiator, drying cabinet).
- ▶ Do not expose the device to direct sunlight.
- ▶ Allow air to circulate freely by leaving at least 10 cm to adjoining devices or to the wall and keep the underside of the device clear.

Caution! Lack of safety due to missing operating manual.

- ▶ When passing on the device, always enclose the operating manual.
- ▶ If you lose the operating manual, request a replacement. The current version of the operating manual and the safety instructions can also be found on our website www.eppendorf.com.

3.5 Warning signs on the device

This section explains the warning signs used on the Mastercycler pro.

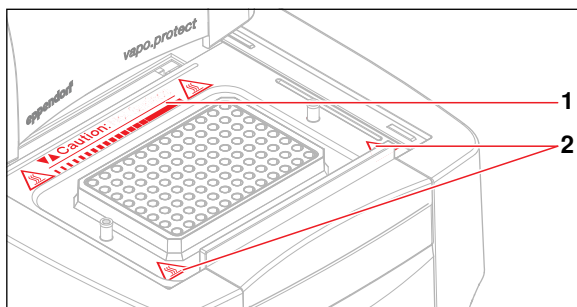

| | | |
|---|--|---|
| 1 | | <p>WARNING</p> <p>Risk of burns from the hot thermoblock (triangle with tip facing down) or the hot inner side of the heated lid (triangle with tip facing up).</p> <p>Gradient operation can result in the temperature being hotter on the right side than on the left side</p> |
| 2 | | <p>WARNING</p> <p>Risk of burns from hot surfaces.</p> |

4 Installation

4.1 Unpacking the device



Warning! Risk of injury when lifting and transporting the device.

Lifting the device with the wrong posture may cause serious damage to your health. If the device falls to the ground it can cause injuries.

- ▶ Do not lift the device by the handle or the housing of the heated lid.
- ▶ Carry the device securely with both hands to prevent it from slipping.
- ▶ Always keep a straight back when lifting and carrying the device.

1. Release the four plastic locking clips at the long sides of the carton by pulling out the flaps.
2. Lift the carton lid and take the foam upper part off the Mastercycler pro.
3. Take the carton insert out of the carton lid (contains the mains cable).
4. Take the Mastercycler pro out of the plastic bag.
5. With both hands, hold the Mastercycler pro by the lower half of the housing and lift it out of the package.
6. Remove all the packing material.
7. Visually check the device to ensure that no damage has occurred during shipment.
8. Check the completeness of the delivery (see *Delivery package* on page 12).



Never use a device if it shows any signs of damage. In this case, contact your distributor or the appropriate Eppendorf office.



- Retain the packing material for shipping or storing the Mastercycler pro at a later date.
- Ship the Mastercycler pro only in the original packing material.

4.2 Selecting location

4.2.1 Space requirements and bearing capacity

Caution! Material damage from uneven work surface.

- ▶ Position the device on level and stable work surface which is capable of bearing the weight of the device. The device must not be placed on a trolley or at an angle.

Caution! Damage due to overheating.

- ▶ Do not place the device close to sources of heat (e.g. radiator, drying cabinet).
- ▶ Do not expose the device to direct sunlight.
- ▶ Allow air to circulate freely by leaving at least 10 cm to adjoining devices or to the wall and keep the underside of the device clear.

Information regarding the dimensions and weight of the device components can be found separately (see *Weight / dimensions* on page 67).

When selecting a location for the Mastercycler pro ensure that the following criteria are met:

- The surface must have sufficient bearing capacity and ensure the required stability.
- The feet at the front of the unit must be secured to prevent them from slipping.
- The device must be positioned at a height which provides for convenient and safe operation.
- Additional space is required for free air circulation at the back of the device (10 cm) and for the control panel at the front (14 cm).

4 Installation

4.2.2 Mains connection

Caution! Connected devices may be shut down due to a power supply overload.

The total current consumption of the devices can exceed the maximum permitted supply rating when multiple power sockets are used. In this case, the mains fuse interrupts the electric circuit. The connected devices are shut down.

- ▶ Do not use multiple sockets when connecting several Mastercycler pro.

Information on the power consumption of the Mastercycler pro is provided separately (see *Power supply* on page 67).

- You need an earthed wall socket for the power supply of the Mastercycler pro. Use the supplied power cable to connect the Mastercycler pro.
- The control panel is supplied via the Mastercycler pro and does not require an additional power supply.

4.3 Installing instrument

This section describes how to start up the Mastercycler pro with the control panel and how to operate several devices belonging to the Mastercycler pro and Mastercycler ep series with each other in a network.



The connections and switches are located at the back of the device (see *Main illustration* on page 10).



- Follow the steps below to define the settings and connect the devices **before** switching on the Mastercycler pro.
- Never disconnect the control panel from a Mastercycler pro which is switched on.

4.3.1 Operating a Mastercycler pro via a control panel



1. Connect the cable on the control panel to the Control Panel connector of the Mastercycler pro.

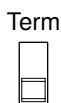

2. Set Term switch to ON (lower position).



3. Use the address dials to set the address of the Mastercycler pro to **01**. In order to do this, turn the left-hand dial to **0** and the right-hand dial to **1**, as shown in the picture.
4. Connect the mains cable to the Mastercycler pro and connect to the power supply.

4 Installation

4.3.2 Operating multiple Mastercycler pro via a control panel ("mini-satellite" system)

Caution! Connected devices may be shut down due to a power supply overload.

The total current consumption of the devices can exceed the maximum permitted supply rating when multiple power sockets are used. In this case, the mains fuse interrupts the electric circuit. The connected devices are shut down.

- ▶ Do not use multiple sockets when connecting several Mastercycler pro.

A control panel can be used to control up to five devices belonging to the Mastercycler pro or Mastercycler ep series (also in combination). Each additional device connected requires its own CAN bus cable. CAN bus cables are available separately for purchase (see *Accessories* on page 69).

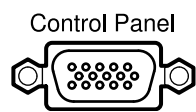

1. Connect the cable on the control panel to the "Control Panel" connector of the first device.

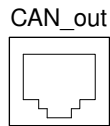

2. Connect the CAN bus cable to the "CAN_out" connector of the first device.

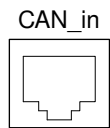

3. Connect the free end of the CAN bus cable to the "CAN_in" connector of the second device.

Connecting additional devices

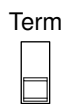

4. Always use the CAN bus cable to connect the "CAN_out" connector of the last connected device to the "CAN_in" connector of the new device.
5. Set the Term switch of the first and last device to "ON" (lower position).

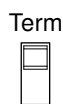

6. Set the Term switch of all other devices to "OFF" (upper position).
Note: If the network consists of exactly two devices, the Term switch of **both** devices must be set to "ON".



7. For the first device connected to the control panel, set the address to **01** (see p. 19).

8. Define one unique address from **02** to **05** on each additional device.

4 Installation

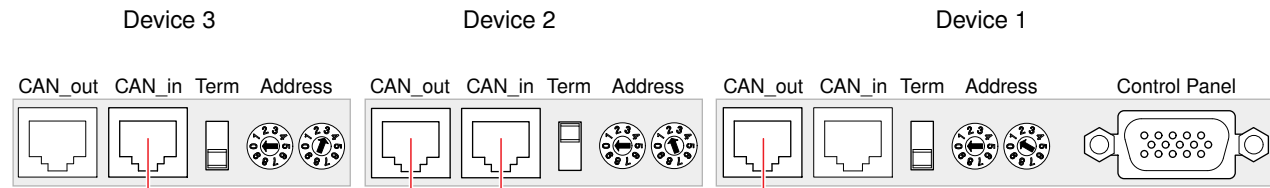

Fig. 4: Address and Term settings and wiring connections for a network consisting of three devices

i Each address may only be assigned once within the network.
 The set address of the Mastercycler pro is displayed by the two-digit address display **3** on the heated lid during operation (see *Main illustration* on page 10).

4.3.3 Connecting the Mastercycler pro to an existing Mastercycler ep

You can extend an existing system of one or more Mastercycler ep with control panels by devices from the Mastercycler pro series.

i When operating the Mastercycler pro with a Mastercycler ep control panel (without USB connections), the following restrictions apply:

- The self test function is not available.
- The PDF file format is not available for exporting programs, protocols and logfiles.
- No USB devices can be connected. Information for connecting a PS/2 mouse can be found in the Mastercycler ep operating manual.

Requirement

Before a Mastercycler pro can be connected to an existing Mastercycler ep system, the software of the control panel and of the connected Mastercycler ep has to be updated. For more information, contact the Eppendorf branch for your country (see back cover flap).

1. Follow the instructions in the Mastercycler ep operating manual to update the control panel software.
2. After restarting the control panel, synchronize all connected Mastercycler ep with the control panel (see p. 48).
3. Shut down the control panel (see p. 45) and switch all Mastercycler ep off.
4. Set the address of the new Mastercycler pro to the next free address number.

i **Example**
 If there are already two Mastercycler ep, set the address for the Mastercycler pro to **03**.

5. Connect the cables and define the Term settings (see *Operating multiple Mastercycler pro via a control panel ("mini-satellite" system)* on page 20).
6. Switch all devices on and register them at the control panel.
 The Mastercycler pro is displayed as an additional cyclor node at the control panel.

4.3.4 Using USB connections

The Mastercycler pro control panel has two USB connections (see Fig. 3 on page 11) which can be used to connect a mouse, a printer, a USB storage medium as well as the self test USB key.

- ▶ If you would like to use more than two USB devices at the control panel at the same time, you can make use of a USB hub.

4 Installation

4.3.5 Connecting the printer

The Mastercycler pro can be connected to a parallel interface printer in order to print protocols and programs in text format.

- ▶ Connect the printer via a parallel data cable to the parallel interface (see Fig. 2 on page 11) of the Mastercycler pro.

A printer with USB interface can be connected to the control panel to print protocols, programs and self test certificates.

Requirement

The USB printer must be compatible with the PostScript® or PCL printer standards. Further information can be found in the operating manual for your printer.

1. Connect the printer via a USB cable to one of the two USB ports (see Fig. 3 on page 11) of the control panel.

4.3.6 Connecting the mouse

You can connect a USB mouse (not included in the delivery package) to the control panel.

- ▶ Connect the mouse plug to the round to one of the USB ports on the right-hand side of the control panel (see Fig. 3 on page 11).

The mouse pointer appears in the display.

4.4 Shut down

Proceed as follows if you do not want to use the Mastercycler pro for longer than a week.

1. Load the block with an empty PCR plate (see p. 41).
2. Close the heated lid and flip the handle forwards (see p. 23).
3. Disconnect the Mastercycler pro from the power supply.

Do not leave the lid of the Mastercycler pro in an open position in order to avoid the block from becoming contaminated.

5 Operation

5.1 Initial steps

Check the correct installation

- Before the Mastercycler pro is started up for the first time, ensure the following:
- The device is correctly connected.
 - The device is free of damage.
 - Make sure that air can circulate freely around the ventilation slots on the rear of the device and around the fan behind the feet.

5.1.1 Using the vapo.protect heated lid

The *vapo.protect* heated lid features a heated flexible pressure unit. When the lid closes, the pressure unit comes to rest lightly on the surface of the sample tubes. A liquid cushion in the pressure unit is then used to create a pressure to ensure that the tubes are pressed uniformly into the thermoblock thereby protecting the tube seals against evaporation. The heating process prevents condensation from forming in the upper area of the tube when the reaction liquid is heated.

Closing the heated lid

Requirement

The thermoblock of the Mastercycler pro is loaded with sample tubes or a PCR plate (see *Loading the thermoblock* on page 41).

Caution! Damage to heated lid from sharp-edged sample tubes or objects.

- ▶ Use only tubes whose properties meet at least the requirements specified in these operating instructions.
 - ▶ Do not use any sharp-edged or sharp objects on the heated lid.
 - ▶ Extra caution should be exercised when cleaning so as not to damage the heated lid.
-

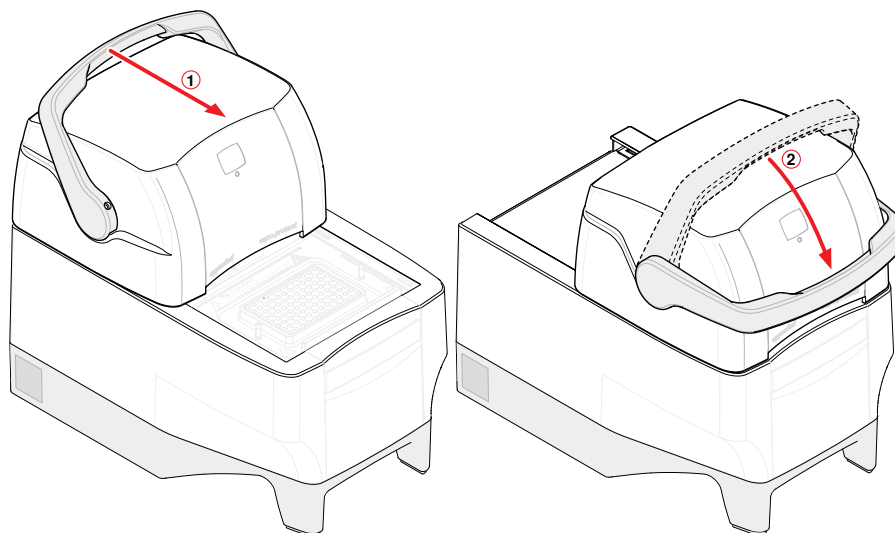

1. Pull *vapo.protect* heated lid forwards at the lid handle as far as possible so that the lid handle can be rotated.
2. Flip the handle over the heated lid until it clicks into place.
You can now start a program run or manually temperature-control the lid and the samples.

5 Operation

Opening the heated lid



Warning! Risk to health and bio hazard when operated with lid open.

The tube lids may pop open at high block temperatures.

- ▶ Close the lid of the device when heating samples.



Warning! Risk of burns from the hot thermoblock and heated lid.

The thermoblock and the heated lid very quickly reach temperatures above 95 °C.

- ▶ Keep heated lid closed until the temperature of the thermoblock is below 30 °C.

Open the heated lid in one go as follows:

- ▶ Flip the lid handle up over the heated lid and push the heated lid by the handle to the rear position until it stops.

Status lamp

The *vapo.protect* heated lid is equipped with a status lamp **2** (see *Main illustration* on page 10) which allows the current operating status of the Mastercycler pro to be visible from far off.

| Status lamp | Operating status |
|-------------------|---|
| Illuminates green | The Mastercycler pro is idle. |
| Flashes green | A program run is active. |
| Flashes orange | The program run is waiting for user intervention in a pause or hold step (see <i>Editing programs</i> on page 37). |
| Flashes red | A fault has occurred. Additional information on the type of fault is displayed on the control panel (see <i>Error messages</i> on page 64). |

Address display

The *vapo.protect* heated lid is equipped with a two-digit address display so that the cyclers can be identified easily (see *Main illustration* on page 10).

The displayed address number matches the cycler numbering in the operating software. The address setting is described separately (see p. 20).

5 Operation

5.1.2 Control panel keys



| | |
|--|--|
| | Start the selected program. |
| | Stop the running program. |
| | <p>Function keys</p> <p>The function of the key changes with the software dialog and appears in the display immediately above the key.</p> |
| | <ul style="list-style-type: none"> • Step-by-step navigation. The current position of the cursor is marked. • Move the cursor within an alphanumeric input field. |
| | Move cursor into the next input field. |
| | <p>Delete the following elements:</p> <ul style="list-style-type: none"> • Delete characters that are to the right of the cursor. • Marked signs. • Marked folders or programs. |
| | <ul style="list-style-type: none"> • Confirm input. • Open selection lists. |
| | <ul style="list-style-type: none"> • Enter digits and text in input fields. In the case of numerical input fields (e.g. temperature and time entries) the keys only represent numbers. For decimal numbers with numbers after the decimal point, use the period as a decimal point. • Alphanumeric input fields have keys with multiple functions. <p>► To enter text, keep pressing the key with the relevant letter until the desired letter is displayed.</p> <p>Example: To enter pcr 3 in a text field, press the following keys in quick succession:</p> <ol style="list-style-type: none"> 1. for p: press 7 once 2. for c: press 2 three times 3. for r: press 7 three times 4. for the blank space: press 0 (zero) twice 5. for 3: press 3 four times |

5 Operation

5.2 Initial start-up of the Mastercycler pro

During the initial startup of the control panel you can define an administrator PIN in order to protect the system against access by unauthorized persons. These data are saved in the control panel and are not lost when the Mastercycler pro is switched off.

5.2.1 Defining the administrator PIN

If no administrator PIN has been defined, you are prompted to do so.

Caution! Loss of data due to misuse or loss of administrator PIN.

The administrator PIN protects the system from undesired access to its configuration and to the stored data of all users.

- ▶ Make a note of the administrator PIN and keep it in a safe place. If you lose the administrator PIN, contact Eppendorf Service.
- ▶ Allow access to the administrator PIN only to persons who are allowed to edit the configuration of the system and who have the knowledge required to do this.



If you do not want to use the user management option, you do not have to define an administrator PIN. In this case, leave the input fields of the **Input Admin PIN** window empty and deactivate the **PIN** function. Further information on user management is provided separately (see *System settings* on page 48).

To define the administrator PIN, perform the following steps in the sequence described.

1. Switch on the Mastercycler pro at the mains power switch.
The **Input Admin PIN** window appears.



2. Enter the desired administrator PIN using the numerical keys on the control panel.
The PIN can be between 4 and 8 digits long.



3. Go to the **Confirmation** field and enter the PIN again to confirm.
4. If your two PIN entries do not match each other, an error message is displayed. In this case, delete the incorrectly entered PIN and repeat the PIN entries.
5. Confirm by pressing the **OK** function key.

After successful confirmation of the administrator PIN, the navigation tree appears in the control panel display. You are now logged in as the administrator.



- If the **PIN** function is activated (see *System settings* on page 48), you must define an administrator PIN. Otherwise this input prompt will appear each time the device is switched on.
- You can also change the administrator PIN subsequently (see *Changing the PIN* on page 47).

5 Operation

5.2.2 Other steps

Setting the date and time

The date and time of the control panel are displayed in the upper right-hand corner of the display. As the administrator you can change this internal clock at any time (see *System settings* on page 48).

Setting up user accounts

To be able to use the Mastercycler pro, you must set up at least one user account. Detailed information about setting up user accounts and about user administration can be found separately (see *Managing user accounts* on page 46).

5.3 User login and logout



The functions described here are only available if the **PIN** function is activated (see *System settings* on page 48).

5.3.1 Logging in as a user

Before you can log in under your user name, your administrator must have set up a user account for you.

Perform the following steps in the sequence described.

1. Switch on the Mastercycler pro at the mains power switch.
The control panel switches on automatically and the software is loaded.
When the software has been loaded, the control panel displays the **User Login** window.
2. Open the list with the **Enter** key and select the user name.



3. Press the **Next** key.
The cursor switches to the **PIN** field.
4. Enter your personal PIN using the numerical keys on the control panel.
If the PIN is wrong, the message **Wrong PIN** appears. Use the **Login** function key to return to the **User Login** window, delete the incorrectly entered PIN with the **Delete** key and repeat the PIN entry.
5. Press the **OK** function key to confirm the entry.
The navigation tree is displayed on the control panel.



You are now logged in under your user name and can work with the Mastercycler pro.

5 Operation

5.3.2 Changing the user

If another user is already logged in, you can log in as follows:

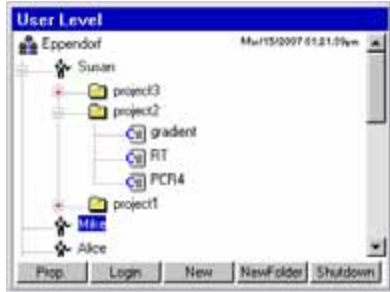

1. Mark your user node.
2. Press the **Login** function key.
3. Log in as a user.

The user who was previously logged on is automatically logged out.

5.3.3 Logging out as a user

You can log yourself out from the control panel to protect your programs against unauthorized changes.

1. Mark your user node.
2. Press the **Logout** function key.

You are now logged out.

The guest user is automatically logged in. Guest users cannot start any programs and just have read-only rights for all programs and folders in the control panel.

5 Operation

5.4 Overview of operation with the control panel

5.4.1 Navigation tree overview

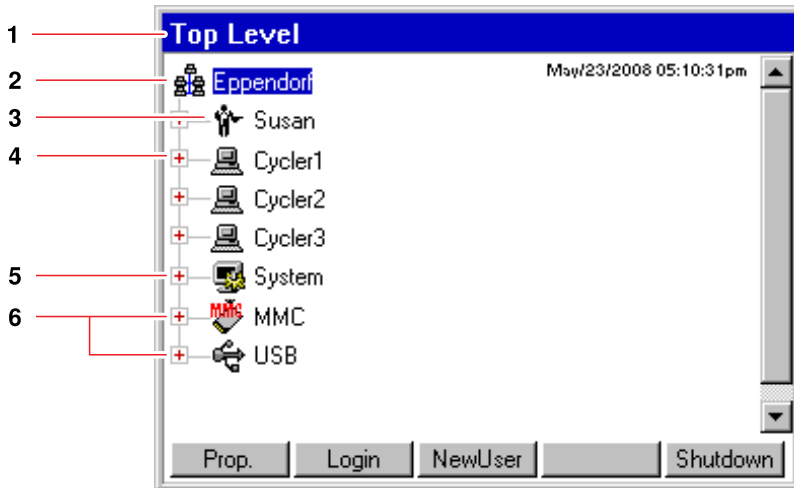

| | |
|--|--|
| <p>1 Window title Displays the current level (user level, cycler level, top level) in the navigation tree and the title of dialog windows. A status symbol is displayed on the right-hand side of the window title if the external storage medium (MMC or USB) is accessed.</p> | <p>2 Main node Eppendorf is the main node containing all the other nodes.</p> |
| <p>3 User node The main node contains a user node for each user who has been set up. You can store folders and programs below your own user node. You can start the programs in your own user node on every cycler that is connected.</p> | <p>4 Cycler node Each cycler that is connected and switched on is displayed by a separate cycler node. Here you can open the status view of the respective cycler and access additional cycler-specific functions. The numbering corresponds to the address of the cycler (see p. 20).</p> |
| <p>5 System node This node contains the most important system settings. Some settings can only be edited by the administrator.</p> | <p>6 MMC and USB nodes These two nodes are only visible if an appropriate storage medium is inserted into the control panel. These nodes can be used to access external storage media (MMC or USB), e.g. for transferring programs to a different control panel or for a system backup.</p> |

5 Operation

EN

Operating Manual

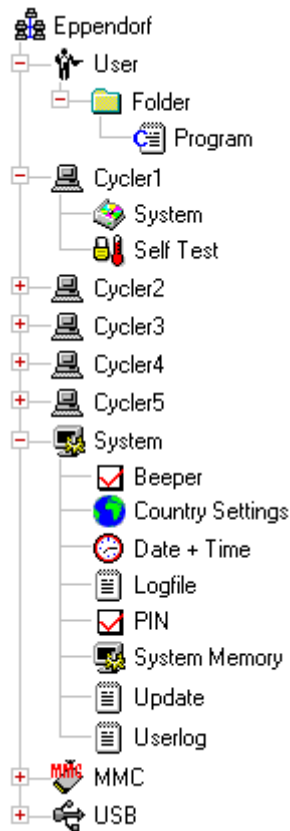
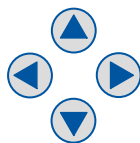



Fig. 5: Navigation tree of the Mastercycler pro. The MMC and USB nodes are only visible if a storage medium is inserted.

5.4.2 Using the navigation tree

Opening the node

You have three options:



- ▶ Mark the node with the arrow keys and press the **Enter** key or the  arrow key.
This opens the node and the plus symbol in front of the node changes to a minus symbol.



- ▶ Or click on the plus symbol in front of the node with the mouse.

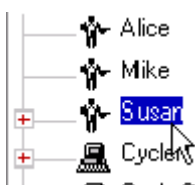

- ▶ Or **double-click** on the desired node with the mouse.

5 Operation

Closing the node

Carry out the above-mentioned steps in the reverse order:

- ▶ Use the mouse to click on the minus symbol in front of the node.
- ▶ Or double-click on the node with the mouse.
- ▶ Or mark the node with the arrow keys and press the **Enter** key or the  arrow key.

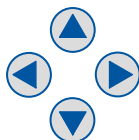



This closes the node and the minus symbol in front of the node changes to a plus symbol.

5.4.3 Using external storage media

You can save programs, logfiles and protocols on an MMC memory card or a USB storage medium and then, for example, archive them on a PC or print them. External storage media are also needed for data backups (see p. 51) and software updates (see p. 52).



The status of the USB connections is indicated by the following symbols in the upper right-hand corner of the control panel:

-  **USB connections deactivated.** The USB connections are not available if the control panel is connected to a Mastercycler ep. Connect the control panel to a Mastercycler pro to activate the USB connections.
-  **USB error.** A faulty or incompatible USB device has been connected. Disconnect all USB devices and switch the control panel off. After restarting, all USB connections will be reactivated.

Inserting storage media

Connecting a USB storage medium

- ▶ Insert the USB storage medium into a USB connection on the right-hand side of the control panel (Fig. 3 on p. 11).

After a few seconds, the **USB** node appears in the navigation tree. The programs and user nodes saved on the USB storage medium can be accessed via this node.

Inserting an MMC memory card

- ▶ Insert the MMC memory card into the MMC slot on the right-hand side of the control panel (Fig. 3 on p. 11) until it locks into position.

After a few seconds, the **MMC** node appears in the navigation tree. The programs and user nodes saved on the MMC can be accessed via this node.



On the USB storage medium, the control panel creates a folder called \leppendorf where all files are saved.

5 Operation

EN

Operating Manual

Removing storage media

Caution! Device damage due to cancellation of the update process.

- ▶ Ensure power supply during the update.
- ▶ Do not switch the cycler off during the update.
- ▶ Do not disconnect the control panel from the cycler during the update.
- ▶ Leave the external storage medium in the control panel until the latter has been restarted after the update and you have logged on again.

Removing a USB storage medium

Caution! When the USB storage medium is accessed, the  symbol is displayed in the upper right-hand corner. Wait until it has disappeared before removing the USB storage medium.

- ▶ Disconnect the USB storage medium.

The **USB** node disappears from the navigation tree.

Removing an MMC memory card

Caution! When the MMC is accessed, the  symbol is displayed in the upper right-hand corner. Wait until it has disappeared before removing the MMC.

1. Briefly press on the projecting end of the inserted MMC.
2. Pull the MMC out of the slot.

The **MMC** node disappears from the navigation tree.

5.4.4 Selecting export file formats

When exporting programs, protocols and logfiles to external storage media, you can choose between text-only format (.TXT) and PDF.



Select memory device

If several storage media are connected, select the **USB** or **MMC** storage medium for the file you would like to export.

Select file format

Selecting the file format:

- **PDF:** Saves the file as PDF. Use this setting if you only want to print or view the documents on your PC. You need PDF reader software for this (e.g. Adobe® Reader®).
- **Text-only (.TXT):** Saves the file in text-only format (.TXT). Use this setting if you want to process the document content electronically (e.g. embed it in a report).

- ▶ Confirm selection with **OK**.

The file is copied to the external storage medium, and the file name is displayed.

5 Operation

5.5 Managing folders and programs



If you are logged in as a normal user (not as the administrator), you are only authorized to create, edit and delete programs and folders below your own user node. More information on user rights can be found in a separate section (see *Administrator functions* on page 46).

5.5.1 Creating folders and programs

Creating folders

Proceed as follows:

1. Mark the user node.
2. Press the **New Folder** function key.
3. Use the numerical keys on the control panel to enter a name for the new folder.



Instead of the numerical keys, you can also use the software keyboard to make entries in text fields. This is called up with the **Keybd** function key.

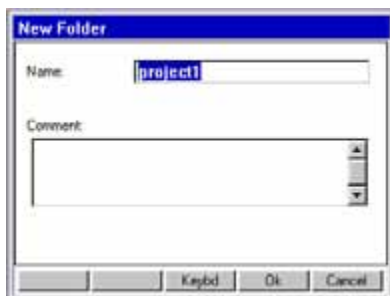

4. To enter a comment for the new folder, select the **Next** key in the **Comment** field.
5. Enter a comment text using the numerical keys and confirm by pressing **OK**.
The folder is created and appears in the navigation tree under your user node.



You can change the name and the comment of the folder at any time using the **Prop.** function key.

Creating a new program

Proceed as follows:

1. In the navigation tree, open your own user node and possibly the folder in which you want to create the new program.
2. Press the **New** function key.



5 Operation

The **New Cycler Program** window is displayed. You can enter a name and a comment for the new program using the numerical keys here.

3. Press the **OK** function key.
The program is created and appears under your user node.



You can change the name of the program or the comment at any time using the **Prop.** function key.



To protect a program against inadvertent changes, you can use the **Prop.** function key to mark it as write-protected (**read only**). This means the program can then be displayed in the program editor (see p. 35), but not changed. This is recommended when working without a PIN.

5.5.2 Copying folders and programs

You can copy folders and programs to your own user nodes as follows. When copying a folder, the programs it contains are also automatically copied.

1. In the user node belonging to any user, mark the folder or the program you want to copy.
2. Press the **Copy** function key.
A message appears informing you that the folder or the program was copied to the clipboard.
3. Confirm the note with **OK**.
4. Mark your own user node. If you want to copy a single program, you can also select a folder below your user node to which you want to insert the program.
5. Press the **Paste** function key.
If a program or folder already exists with the same name, you will be prompted to enter a new name.

The folder or program is inserted under your user node. You can now start or edit this program.

5.5.3 Deleting folders and programs

1. In the navigation tree, mark the folder or the program.
2. Press the **Delete** key.
A confirmation prompt appears.
3. Confirm confirmation prompt with **Yes**.
The folder or program is deleted.

6 Programming

6.1 Overview of the program editor

The graphic program editor can be used to view and change existing programs.

6.1.1 Opening the program editor

1. Mark the desired program in the navigation tree or create a new program (see *Creating a new program* on page 33).
2. Press the **Edit** function key.
The program editor is displayed.

6.1.2 Structure of the program editor

A program consists of a program header and up to 99 program steps, which are processed successively by the cycler. The program editor features a graphic user interface for intuitive creation and adjustment of user-specific programs.

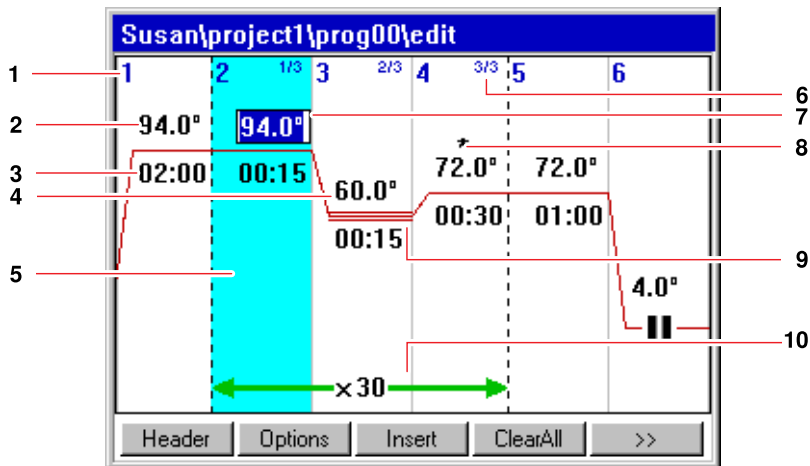

| | |
|---|--|
| <p>1 Number of the program step</p> | <p>2 Block temperature [°C] The thermoblock is heated or cooled in the relevant step at this temperature.</p> |
| <p>3 Hold time [mm:ss] The set block temperature is maintained for this time.</p> | <p>4 Average temperature for gradient steps When using gradient steps, increasing temperatures are generated across the columns of the thermoblock from left to right. The average temperature is displayed here.</p> |
| <p>5 Program step highlighted marking The selected program step is highlighted in blue. New program steps are inserted before the marked step.</p> | <p>6 Step number within the cycle The step number within a cycle and the total number of steps in the cycle are displayed on the top right. Example: 2/3: Step 2 of a 3-step cycle (3 StepCyc).</p> |
| <p>7 Active input field Numerical keys are used to make entries.</p> | <p>8 Extended program step Program steps are indicated by an asterisk * if they are associated with a temperature or holding time increment or with a reduced heating or cooling rate.</p> |
| <p>9 Marking of gradient steps Gradient steps are indicated by three horizontal lines.</p> | <p>10 Number of cycles The cycle number indicates how often the program steps indicated by the green horizontal arrow are to be repeated.</p> |

6 Programming

6.2 Defining general settings

Each Mastercycler pro program features a program header in which you can define the block temperature control mode and heated lid behavior. These settings are valid for the entire program.

6.2.1 Opening the header

1. Open the program editor (see *Opening the program editor* on page 35).



2. Press the **Header** function key.
The header settings are displayed.



6.2.2 Editing header settings

| | |
|---------------------------|---|
| Mastercycler | <p>Defining the cycler type</p> <ul style="list-style-type: none"> • To create a program, which is suitable for all Mastercycler pro devices, select any (default setting). • To create a program for a specific Mastercycler pro (e.g. pro S) or Mastercycler ep, select the desired cycler version from the list. The program can then only be started on this type of cycler variant. |
| Lidtemp. | <p>Heated lid temperature (37 °C to 110 °C). The set lid temperature is maintained constant during the program run.</p> <p>The heated lid remains switched off if temperatures of less than 37 °C are entered.</p> |
| TSP/ESP heated lid | <p>Preheat heated lid</p> <ul style="list-style-type: none"> • Mastercycler pro: Switch TSP on and off. When TSP is activated, the heated lid is heated to the set temperature, while the block is maintained constant at 20 °C. The program is started after the lid temperature has been reached. • Mastercycler ep: Switch ESP on and off. When ESP is activated, the heated lid is first heated to the set temperature before it is lowered onto the tube surfaces. The program is started after the heated lid has been lowered. |

6 Programming

| | |
|--|---|
| Switch off lid at low block temperature | <p>Lid heater with automatic switch-off</p> <ul style="list-style-type: none"> Activated (default setting): The lid heater switches off if program steps have block temperatures of < 15 °C. Deactivated: The lid heater switches off after the end of the program. If the last command in a program is a hold step, the heated lid remains switched on until the Enter key is pressed. <p>Note: This option is useful if you have inserted hold step as the last program step in order to automatically cool the samples after the PCR.</p> |
| Temp. mode | <p>Block temperature control mode</p> <ul style="list-style-type: none"> fast (default setting): Use this setting for Fast PCR, for low reaction volumes (< 20 µL) and for templates with a low G/C content. With this setting you achieve the shortest program runtimes. standard: Block temperature control mode for standard applications. Use this setting for sample volumes between 20 µL and 50 µL or if the fast setting only results in a weak amplification. The program runtimes are a bit longer than with the fast setting. safe: Block temperature control mode for difficult templates and large reaction volumes. Use this setting for sample volumes of 50 µL or more or for amplifying samples with a high G/C content. The program runtimes are a bit longer than with the standard setting. |
| Simulate Mastercycler gradient | <p>With this setting it is possible to simulate the temperature control behavior of the Mastercycler 5333 or Mastercycler gradient 5331. This allows you to transfer programs from these cycler models without making adjustments to the Mastercycler pro (see <i>Transferring programs from the Mastercycler 533x</i> on page 54).</p> <p>If this option is deactivated, Mastercycler 5333/5331 programs will have to be adjusted for the Mastercycler pro due to the different temperature control behavior. This may influence the PCR results.</p> |
| Impulse | <p>This is only displayed if under Mastercycler the pro S or ep gradient S setting were selected.</p> <p>If this option is activated, a higher heating rate (pulse) is achieved during the first temperature control step. This can reduce non-specific PCR product formation.</p> |

6.3 Editing programs

You can add, edit or delete steps in new (see p. 33) or copied (see p. 34) programs.

6.3.1 Inserting a program step

1. Program editor (see *Opening the program editor* on page 35) .
2. Use the arrow keys to mark the program step **before** which the new program step is to be inserted.
The marked program step is highlighted in blue.
3. Press the **Insert** function key.
A list appears containing the available program steps.

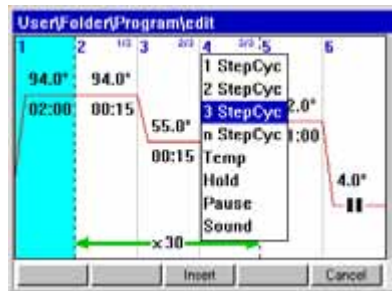

4. Use the arrow keys to select the desired program step.
The following program steps are available:

6 Programming

| | |
|-------------------------------|---|
| 1 StepCyc to 3 StepCyc | <p>Cycle program step with 1 to 3 temperature steps with an adjustable number of repetitions (1 to 99).</p> <p>With cycle program steps you can increase or reduce the block temperatures and hold times by a preset value after each cycle (see <i>Editing parameters</i> on page 38).</p> |
| n StepCyc | <p>Cycle program step with an adjustable number of temperature steps. After selecting this program step and confirming by pressing Enter a dialog window appears for the following entries.</p> <ul style="list-style-type: none"> • Steps per Cycle: Number of temperature steps per cycle (1 to 20) • Number of Cycles: Number of cycles (1 to 99). If you have inserted a cycle with more than 6 steps, use the arrow keys ◀ and ▶ to display the hidden steps. |
| Temp | Individual temperature step with adjustable block temperature and hold time. |
| Hold | <p>Temperature step with adjustable block temperature and indefinite hold time.</p> <p>The set temperature is maintained until the user presses the Enter key. A corresponding prompt is displayed in the status view and also indicated by the status light flashing orange (see <i>Status lamp</i> on page 24).</p> |
| Sound | This program step emits an acoustic signal. |
| Pause | Like Hold . The block temperature remains set to the value of the previous temperature step. |

5. Press the **Insert** function key.
The program step is inserted with standard parameters.

You can now insert additional program steps or edit the parameters of the program steps.

6.3.2 Editing parameters

1. Use the arrow keys to mark the desired program step.
The marked program step is highlighted in blue.
You can make the settings for temperature, hold time and number of repetitions directly in this view.

Changing the temperature

2. Use the arrow keys to mark the temperature.



The temperature is highlighted in blue.

3. Use the numerical keys to enter a new value between 4.0 °C and 99.0 °C (in increments of 0.1 °C).
4. Confirm by pressing the **Enter** key.

Changing the hold time

5. Mark the hold time.



The hold time is highlighted in blue.

6. Use the numerical keys to enter a new value between 000:00 to 999:59 (mmm:ss, in increments of 1 s).
7. Confirm by pressing the **Enter** key.

6 Programming

Changing the number of cycles

8. Mark the value for the repetitions.

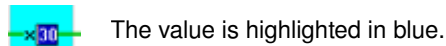

9. Use the numerical keys to enter the number of repetitions (1 to 99).

10. Confirm by pressing the **Enter** key.

You can change other parameters for the marked program step:

Extended options

11. Press the **Options** function key.

The extended parameter settings for the marked program step are displayed.

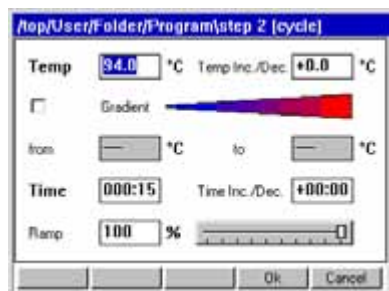

| | |
|-----------------------|---|
| Temp | Temperature for the program step. Equivalent to directly editing in the program view. |
| Temp Inc./Dec. | For changing the temperature to the next cycle. Values ranging from -10.0 °C to +10.0 °C in increments of 0.1 °C are possible. You can switch between positive and negative values by pressing the +/- function key. |
| Gradient | Column temperature gradient in the thermoblock. Enter the temperature range into the from (left-hand side of block) and to (right-hand side of block) fields. The Temp and Temp Incr. fields are deactivated. To display the temperatures in the individual columns, press the ShowGrad function key. The temperatures displayed there are interpolated approximation values. Maximum gradient range and course depend on the type of block used (see <i>Features of the Mastercycler pro variants</i> on page 13). To use the extended gradient spread on devices with silver block (Mastercycler pro S and Mastercycler ep gradient S), define the appropriate cyclers type in the program header in advance (see p. 36). |
| Time | Hold time for the program step. Equivalent to directly editing in the program view. |
| Time Inc./Dec. | For changing the hold time to the next cycle. Values ranging from -01:00 to +01:00 in increments of 1 s are possible. You can switch between positive and negative values by pressing the +/- function key. |
| Ramp | Temperature control speed of the thermoblock. Values ranging from 1 % to 75 % and also 100 % are possible. |

12. Press the **OK** function key to accept the settings.

The program view appears.

13. Press the **>>** function key and then **Save**.

The changes are saved.

14. Press the **Exit** function key to exit the editor.

6 Programming

6.3.3 Deleting individual program steps

1. Use the arrow keys to mark the desired program step.
The marked program step is highlighted in blue.
2. Press the **Delete** key.
3. Press the **Save** function key to save the change.
Press the **Exit** function key to exit the editor.

6.3.4 Deleting all program steps

1. Press the **ClearAll** function key.
A prompt appears asking whether you want to delete all the program steps.
2. Press the **OK** function key.
All program steps are deleted.

6.3.5 Exporting a program listing

You can export a program to an external storage medium as a file for documentation purposes.

1. Insert the external storage medium into the control panel (see p. 31).
2. Press the **>>** function key.
3. Press the **Export** function key.
4. Select the format (Text or PDF) and confirm with **OK**.
The program listing is saved to the external storage medium as a file.

6.3.6 Saving a program and exiting the editor

1. Press the **>>** function key.
2. Press the **Save** function key.
The program is saved to the internal memory of the control panel.
3. Press the **Exit** function key.
The navigation tree is displayed. You can now start the program (see *Starting the program* on page 42).

7 PCR run

7.1 Preparation

7.1.1 Selecting the sample tubes



Caution! Unsuitable tubes can result in sample material escaping.

- Unsuitable tubes may be so severely damaged that sample material is released.
- ▶ Use only tubes whose properties meet at least the requirements specified in these operating instructions.
 - ▶ This is especially important when working with infectious material.

Caution! Damage to heated lid from sharp-edged sample tubes or objects.

- ▶ Use only tubes whose properties meet at least the requirements specified in these operating instructions.
- ▶ Do not use any sharp-edged or sharp objects on the heated lid.
- ▶ Extra caution should be exercised when cleaning so as not to damage the heated lid.

Caution! Temperatures on the inside of the heated lid may be higher.

- If well caps consisting of thermally insulating material are used, the temperature on the inside of the heated lid can be significantly higher than the temperature displayed.
- ▶ If you are using well caps consisting of thermally insulating material, for example foamed material, make sure that it is heat-resistant up to at least 140 °C.

The Mastercycler pro can be used with a great variety of sample tube and plate types. Consider the following when selecting sample tubes, plates and lids:

- Only use sample tubes, plates and lids which have a heat resistance of up to approx. 120 °C.
- The sample tubes and plates must fit into the thermoblock bores free from play to achieve a good heat transfer.

7.1.2 Loading the thermoblock

Caution! Damage to the thermoblock from incorrect operation.

- ▶ Do not fill sample material directly into the thermoblock.

Loading a 96 well block

The Mastercycler pro and Mastercycler pro S can be loaded with 0.2 mL single tubes or strips. You can also use a 96-well PCR plate. The following PCR plate types are compatible with the Mastercycler pro :

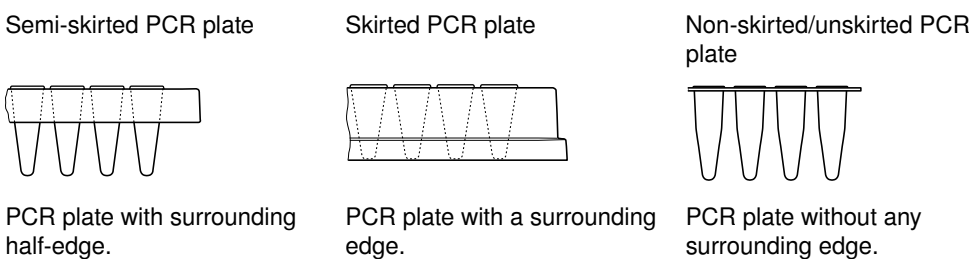

Loading a 384-well block

The Mastercycler pro 384 can be loaded with a 384-well PCR plate. To seal the PCR plates, you can use adhesive and heat sealing films, lid strips or reusable silicone mats. A selection of the PCR micro test tubes and lids can be found separately (see *Consumables* on page 69).

7 PCR run

7.1.3 Sample volume

The liquid level in the micro test tube should not be above the upper edge of the block.

You can use the following standard values for the maximum sample volumes:

- Mastercycler pro and Mastercycler pro S: Maximum 100 µL per single reaction.
- Mastercycler pro 384: Maximum 25 µL per single reaction.

The sample volumes that can actually be used may vary depending on the type of micro test tube used.

7.2 Starting the program

Start the PCR programs from the editor or the navigation tree.

If the **PIN** function is activated, you can only start programs which are stored below your user node (see p. 46).

Requirement

You are logged in as user and the program to be started is saved.

1. Mark the program in the navigation tree with the arrow keys or open it in the editor.
2. Insert the sample tubes (see *Loading the thermoblock* on page 41).
3. Close the heated lid (see *Closing the heated lid* on page 23).
(For devices from the Mastercycler ep series with motorized lid, this will be closed automatically when the program is started.)
4. Press the **Start** key.
If several cyclers are connected, the **Cycler Selection** dialog appears.



5. Mark the desired cycler.
6. Press the **OK** function key.
7. Devices from the Mastercycler ep series only: you are prompted to enter the tube type. Select the tube type used: **Tubes** for individual tubes or **Plate** for a PCR plate. Press the **OK** function key.

The program is started and the status view appears.

7 PCR run

7.2.1 Status view

The status view is automatically displayed immediately after a program is started. It shows the progress of and information on a running program. The currently active step is displayed as a flashing line.

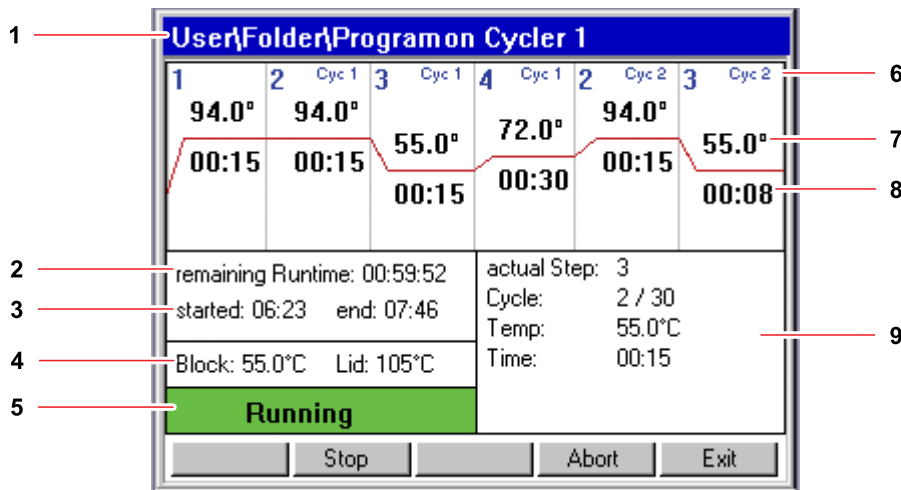

| | | | |
|---|---|---|----------------------------------|
| 1 | Program path and cycler | 2 | Remaining runtime |
| 3 | Start and end time of the program | 4 | Block and heated lid temperature |
| 5 | Device status | 6 | Cycle number |
| 7 | Block target temperature | 8 | Remaining hold time |
| 9 | Information on the current program step | | |



If you have activated the **TSP/ESP** function in the program header (see p. 36), the heated lid is heated or cooled to the desired temperature before the program run starts. This process is indicated in the status view by the message **TSP Heated Lid**.

You can exit the status view at any time via the **Exit** function key to return to the navigation tree and, for example, edit another program or start a program on a different cycler. The program that was already started is not interrupted as a result.

Displaying the status view

Proceed as follows:

1. Mark the cycler in the navigation tree.
2. Press the **Status** function key.



The cycler is indicated in the navigation tree with a green symbol while it executes a program.

7 PCR run

7.3 Interrupting or stopping the program

You can temporarily interrupt the program run in the status view, for instance, to add reagent, or completely stop the program.

7.3.1 Interrupting the program

1. Open status view (see *Starting the program* on page 42).
2. Press the **Stop** key.

The status view shows **Paused**.

Observe the safety precautions for opening the heated lid (see *Opening the heated lid* on page 24).

7.3.2 Continuing the program

1. If the heated lid is opened, draw the heated lid forwards over the samples and close the lid.
2. Press the **Resume** function key.

The status view displays **running** and the program run is continued.

7.3.3 Stopping the program

- ▶ Press the **Abort** function key.

The status **Idle** is displayed. The program has been aborted and cannot be continued.

7.4 Using protocols

The Mastercycler pro creates a protocol for each program run where all executed program steps and any interruptions and errors are recorded.

After running a PCR program, you can view the associated protocol on the control panel, save it on an MMC or a USB memory or send it to a printer.



The protocol is overwritten the next time a program is started on the Mastercycler pro.

Requirement

The cycler is idling.

1. Mark the desired cycler node in the navigation tree.
2. Press the **Protocol** function key.

The protocol is displayed.

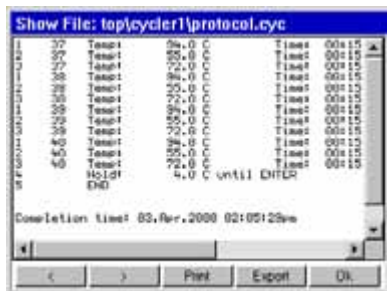

3. Use the **<<** and **>>** function keys to go one page back or forward.
Use the arrow keys on the control panel to move the visible section.

Further functions for saving and printing the protocol are available in the protocol screen.

7 PCR run

| Saving a protocol | Printing a protocol |
|---|--|
| <ol style="list-style-type: none"> 1. Insert a USB storage medium or an MMC (see p. 31). 2. Press the Export function key. 3. Select Text or PDF file format. <p>The protocol is copied to the external storage medium.</p> | <ol style="list-style-type: none"> 1. Check if the printer is connected correctly and is ready for printing (see p. 22). 2. Press the Print function key. <p>The protocol is printed.</p> |

7.5 Shutting down and switching off the device

Shut down the control panel before you shut down the Mastercycler pro:

1. Mark the **Eppendorf** or **System** node in the navigation tree.
2. Press the **Shutdown** function key.
A confirmation message appears.
3. Press **Shutdown** function key.
The control panel is shut down.
4. Switch off the cycler at the mains power switch.

8 System management

8.1 Administrator functions

The software of the Mastercycler pro differentiates between standard users and the administrator.

The access rights are distinguished as follows:

| Procedure | Standard user | Administrator |
|---|--|--|
| Copying programs | From every user node in user's own nodes | From every user node in all user nodes |
| Creating, deleting, editing and starting programs | Only programs below user's own node | All programs |
| Managing user accounts and setting PINs | Only change own user name and PIN | Create, change, delete user accounts. Change PIN of each user. |
| Making system settings | None | All |
| Performing self test, validation and calibration | Only self test and validation | Self test, validation and calibration |
| Performing backups, restores and software updates | Only backups | All |

The **PIN** (see p. 48) setting can be used to define whether all users have to log in with their user names and PINs before using Mastercycler pro or whether all users should receive administrator rights (without entering their user names and PINs).

8.2 Managing user accounts

8.2.1 Creating user accounts



- You can only assign a user name once.
- The administrator uses the fixed user name **_admin**.

You can set up a separate user account for each user:

1. In the navigation tree, mark the **Eppendorf** node at the very top.
2. Press the **New User** function key.
The **New User** window is displayed.



3. Enter the name and PIN for the new user. Repeat the PIN entry in the **Confirmation** field.
4. Confirm by pressing the **OK** function key.
The new user account is set up. In the navigation tree, a new user node is displayed with this user name.
The user can now log in with his or her PIN at any time.

8 System management

8.2.2 Editing user accounts

You can subsequently change the user name, the PIN and the comment for an existing user account depending on your user rights (see p. 46) :

1. In the navigation tree, mark the user node and press the **Prop.** function key.
The **User Properties** window is displayed.
2. Change the settings for the user account and confirm with the **OK** function key.

8.2.3 Deleting user accounts

To delete a user account, you need to be logged in as the administrator.



When a user account is deleted, the user node selected as well as all its folders and programs are deleted from the navigation tree. Deletion of a user account cannot be undone.

1. In the navigation tree, mark the user node and press the **Delete** key.
A prompt appears asking you if you are sure you want to delete the user.
2. Confirm by pressing the **OK** function key.
The user account is deleted.

8.2.4 Changing the PIN

If you work with the PIN function (see *System settings* on page 48), only the administrator is authorized to make system settings and manage user accounts.

Changing the administrator PIN

If you are logged on as an administrator, you can change the administrator PIN at any time.

Caution! Loss of data due to misuse or loss of administrator PIN.

The administrator PIN protects the system from undesired access to its configuration and to the stored data of all users.

- ▶ Make a note of the administrator PIN and keep it in a safe place. If you lose the administrator PIN, contact Eppendorf Service.
 - ▶ Allow access to the administrator PIN only to persons who are allowed to edit the configuration of the system and who have the knowledge required to do this.
-

1. Switch on the Mastercycler pro and log in as the administrator.
2. In the navigation tree, mark the **System** node and press the **Prop.** function key.
The **System Properties** window is displayed.
3. Enter the new administrator PIN using the numerical keys on the control panel.
Delete incorrectly entered PINs with the **Delete** key and repeat the PIN entry.
4. Enter the new PIN in the **Confirmation** field to confirm again.
5. Confirm with the **OK** function key.
The new administrator PIN is immediately valid.

8 System management

Changing the user PIN

You can change the PIN for logging into your user account at any time. To do this, proceed as follows.

1. In the navigation tree, mark your own user node and press the **Prop.** function key.



The **User Properties** window is displayed.

2. Enter the new user PIN with 4 to 8 digits with the numerical keys on the control panel. Delete incorrectly entered PINs with the **Delete** key and repeat the PIN entry.
3. Reenter the new PIN in the **Confirmation** box to confirm it.
4. Confirm by pressing the **OK** function key.
The new user PIN is immediately valid.

8.3 System settings

Open the **System** node to make the following system settings.



Showing available system memory

- ▶ Mark the **System Memory** node and press the **Show** function key.

The system memory is shown as a red-green marking at the lower end of the display (red for the used memory, green for free memory).

- ▶ To hide the display press the **Show** function key.

Exporting the logfile

- ▶ Mark the **Logfile** node and mark the **Export** or **Export 20** function key.

The logfile or the last 20 entries in the logfile are written to MMC or a USB storage medium. You can display the logfile by pressing the **Show** function key.

Changing the date and time

1. Mark the **Date + Time** node and press the **Set** function key.
2. Set the date and time and confirm with **OK**.

Changing the country settings

The country settings are indicated with the international area code (e.g. 001 for USA).

The language (German or English) as well as the date and time format (12 or 24 hour format) are defined in the country settings.

1. Mark the **Country Settings** node and press the **Set** function key.
2. Select the desired settings and confirm with **OK**.

The Mastercycler pro is immediately shut down. The modified settings apply after the next start.

8 System management

| | |
|---|---|
| Activating or deactivating the acoustic signal | <p>▶ Mark the Beeper node and activate or deactivate it.</p> <p>If the red checkmark is set, the acoustic signal for error messages and key presses is activated.</p> |
| Activating or deactivating PINs | <p>Use the PIN node to define whether or not a PIN entry is required for working.</p> <ul style="list-style-type: none"> • Mark the PIN node and activate or deactivate it. • The control panel is immediately shut down. The modified settings apply after the next start. |
| Synchronizing software | <p>Use the update node to perform a software synchronization between the cycler and the control panel. The software synchronization may be necessary if you receive error messages after updating the software of the control panel.</p> <ol style="list-style-type: none"> 1. Mark the Update node. 2. Press the Cycler function key. 3. Select the cycler. 4. Press Start function key. |



| | |
|------------------------------------|--|
| Exporting user-related data | <p>Use the UserLog node to export or display all the actions that were performed on the control panel in the form of a logfile.</p> <p>You can save login and logout information, all changes and interventions in a running program related to specific users.</p> <ul style="list-style-type: none"> ▶ Mark UserLog and press the desired function key: ▶ Show: Display user log. In the display you can print or export the user log. ▶ Exp+Clear: Transfer UserLog to MMC or a USB storage medium and subsequently delete it from the control panel. ▶ Export: Copy UserLog to MMC or a USB storage medium. |
|------------------------------------|--|

8.4 Cycler functions

In the **Cycler** node you can display and set the state of the thermoblock and the heated lid. You can also retrieve the protocol of the last PCR program used.



| | |
|-----------------|--|
| Prop. | Display device properties. |
| Incubate | Thermoblock temperature control (4.0 °C to 99.0 °C). |
| Lid | Heated lid temperature control (37 °C to 110 °C). |
| Status | Switch to status view while the program is running. |

8 System management

| | |
|-----------------|--|
| Protocol | Display, export or print out protocol of the last PCR program processed. The protocol contains a record of the temperature curve and the device settings. The previous protocol is overwritten whenever a new program is started on the cyclor. |
|-----------------|--|

8.4.1 Cyclor system functions

The **System** node contains the cyclor system level with the following function keys.

| | |
|--------------------|--|
| Block | Display block type, serial number as well as the date when the last validation and calibration took place. |
| Restart | Entry for maximum duration of interruption of voltage supply (<i>mm:ss</i>) after which a running program should be automatically restarted. The program is not restarted after a longer interruption. |
| Sensors | Current sensor temperatures for the lid and block. |
| Validation | Check block temperature control with the temperature validation system. |
| Calibration | Calibrate and adjust block temperature control with the temperature validation system. Only displayed if the administrator is logged in. |



For the **Validation** and **Calibration** functions you need the Eppendorf Temperature Validation System (see *Accessories* on page 69). For information on how to use this system, refer to the corresponding operating manual.

8.4.2 Self test

The self test function of the Mastercycler pro enables you to quickly check the following properties of the thermoblock without an external measuring system:

- Heating and cooling rates
- Proper functioning of the temperature control loops
- Temperature homogeneity in each of the three block zones and across the whole block

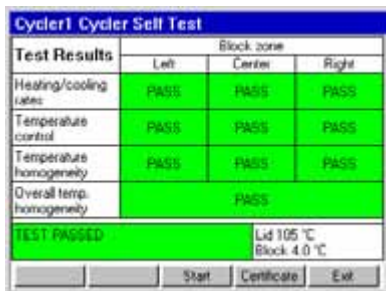

After a successful self test, a certificate can be generated in PDF format.

A self test USB key is needed in order to perform the self test. This is available separately (see *Accessories* on page 69). A detailed description of the self test function can be found in the self test USB key documentation.

8 System management

8.5 Managing and backing up data

8.5.1 Backing up data



The function keys in the above view show the options available to the administrator for transferring data. Standard users only have the option of performing backups here.

- ▶ Insert an MMC memory card or a USB storage medium into the right-hand side of the control panel.
The **MMC** or **USB** node is displayed in the navigation tree.
- ▶ Mark the **MMC** or **USB** node.

Backup

Back up user nodes, folders and programs onto an external storage medium.

- **MMC**: The MMC inserted will automatically be completely deleted at the start of the backup process.
- **USB**: Files and folders in the \eppendorf directory will automatically be completely deleted at the start of the backup process.

The backed-up data can be copied into the control panel using the **Restore** function.

Restore

Administrator only: copy the user nodes, folders and programs saved on the external storage medium during a backup to the control panel.

This process deletes any user nodes, folders and programs which already exist in the control panel. After the restore process, only the data copied from the external storage medium will be available.

8.5.2 Exporting and importing programs

Export



1. In the navigation tree, mark the program.
2. Insert an MMC or a USB storage medium into the slot on the right-hand side of the control panel.
3. Press the **Export** function key.
The program is copied to the MMC or the USB storage medium.

The exported programs can be transferred to a different control panel.

8 System management

Importing programs and folders



1. Insert an MMC or a USB storage medium with exported programs into the slot on the right-hand side of the control panel.
2. Open the **MMC** or **USB** node and mark the folder or program you would like to import.
3. Press the **Copy** function key.
4. Mark the user node or folder in the destination location and press the **Paste** function key.

8.6 Updating the control panel software

Caution! Device damage due to cancellation of the update process.

- ▶ Ensure power supply during the update.
- ▶ Do not switch the cycler off during the update.
- ▶ Do not disconnect the control panel from the cycler during the update.
- ▶ Leave the external storage medium in the control panel until the latter has been restarted after the update and you have logged on again.



- After the software update, synchronize all connected cyclers (see *System settings* on page 48).
- Create a current backup immediately after the update (see *Backing up data* on page 51).

8.6.1 Performing an automatic software update

The auto update function automatically initiates a software update on the control panel.

Requirement

- You are logged on as an administrator or the **PIN** function is switched off.
- All connected cyclers are idling.
- The navigation tree is displayed.

1. Log on as an administrator or switch the **PIN** function off.
2. Insert an MMC memory card or a USB storage medium with the new software version.
3. Confirm confirmation prompt with **Yes** function key.
The software version currently installed and the software version on the storage medium are displayed.
4. Press the **Update** function key to start the update. To cancel the process, press the **Restart** function key.

The update may take several minutes. Afterwards the control panel will automatically restart.

8 System management

8.6.2 Performing a manual software update

If the automatic update was canceled or did not start, you can also perform a manual update.

Requirement

- You are logged on as an administrator or the **PIN** function is switched off.
- An MMC memory card or a USB storage medium with a newer software version is inserted into the control panel.

1. Mark the **MMC** or **USB** node.
2. Press the **Firmware** function key.



Always perform the software update for the control panel first and then perform the update for all connected cyclers (software synchronization) (see *System settings* on page 48).



3. Select **Software Update Control Panel** and press the **Start** function key.
The software version currently installed and the software version on the storage medium are displayed.
4. Press the **Update** function key to start the update. To cancel the process, press the **Restart** function key.
The update may take several minutes. Afterwards the control panel will automatically restart.

8 System management

8.7 Transferring programs from the Mastercycler 533x

PCR programs established on the Mastercycler (5333) or the Mastercycler gradient (5331) can easily be transferred to the Mastercycler pro without first having to optimize the temperatures and hold times.

- ▶ Enter the program into the Mastercycler pro editor:

Example

```

1 T = 94.0°      0:02:00
2 T = 94.0°      0:00:15
3 T = 60.0°      0:00:15
+0.0°           +0:00
R = 3.0°/s      +0:0°/s
G =10.0°
4 T = 72.0°      0:00:30
5 GOTO 2         REP 29
6 T = 72.0°      0:02:00
7 HOLD 4.0°      ENTER
    
```

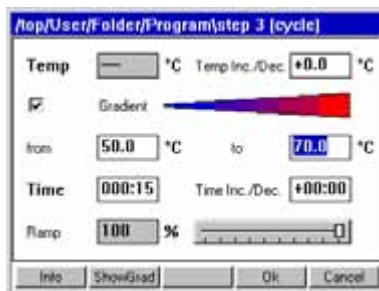

- ▶ Make the settings in the header (see *Editing header settings* on page 36).



Setting from the Mastercycler 533x program

LID 105 °C
 Wait \triangle
 AUTO \triangle
 CNTRL \triangle
 Block temperature control behavior

Corresponding setting in the program header

Lidtemp 105 °C
 TSP/ESP heated lid
 Switch off lid at low block temperature
 BLOCK = Temp. mode block
 TUBE = Temp. mode safe or fast
 Activate the **Simulate Mastercycler gradient** checkbox

- ▶ Press the **OK** function key.
The editor is displayed.
- ▶ Press the **>>** function key and then **Save**.
You can start the program without renewed optimization of the parameters.

9 Quick start

9.1 Login

| | | |
|--|--|----------------------------------|
| | | <p>1. Open list.</p> |
| | | <p>2. Select user.</p> |
| | | <p>3. Confirm selection.</p> |
| | | <p>4. Go to the PIN field.</p> |
| | | <p>5. Enter and confirm PIN.</p> |
| | | |
| | | |

9 Quick start

9.2 Creating folders and programs

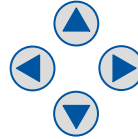

1. Select the user or folder.
2. Press **NewFolder** or **New**.



3. Enter and confirm names and comments.



9.3 Copying folders and programs



1. Select the folder or program.
2. Press the **Copy** function key.



3. Confirm selection.



4. Mark the target folder or user.
5. Press **Paste**.

9 Quick start

9.4 Deleting folders and programs



1. Mark the folder or program.



2. Press the Delete key.



3. Confirm the selection.

9.5 Editing programs



1. Select the program.



2. Open the program editor.

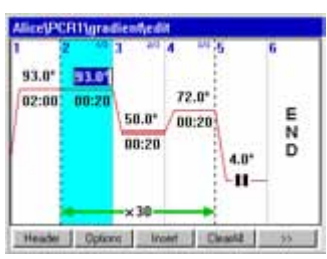

3. Press the **Header** function key.



6. Set the lid functions and control mode.



7. Confirm input.

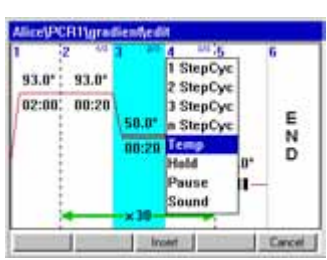

8. Press the **Insert** function key.



9. Select the program step.

9 Quick start



10. Enter the temperatures, hold times and cycle number.
11. Select the program step.
12. Press the **Options** function key.

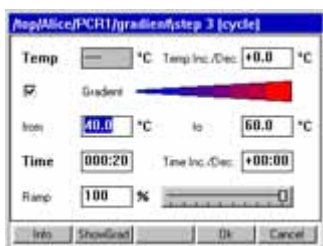

13. Set the gradient, increment and ramp.



14. Confirm input.

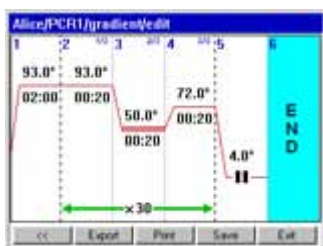

15. Press the **>>** function key.
16. Press the **Save** function key.
17. Press the **Exit** function key.

9.6 Stopping and starting programs



1. Mark the program.
2. Insert the sample tubes.
3. Close the heated lid.
4. Start the program.

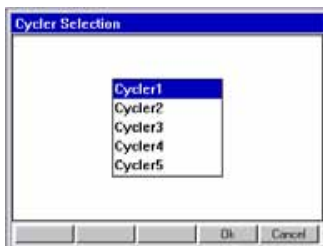

5. With several connected cyclers: Mark the cycler.
6. Confirm input.

9 Quick start



7. You can use the status view to carry out the following program commands

- **Stop**
- **Abort**
- **Resume**

9.7 Switching off the device



1. Mark the **Eppendorf** or **System** node.
2. Press the **Shutdown** function key.
3. Switch off the Mastercycler pro at the mains power switch.

10 Maintenance

10.1 Cleaning



Danger! Electric shock.

- ▶ Switch off the device and disconnect the power plug before opening the device, performing work on electrical connections or starting maintenance or cleaning work.



Warning! Burns from hot thermoblock and heated lid.

The thermoblock, the inner side of the heated lid and micro test tubes/PCR plates can reach temperatures of over 50 °C very quickly.

- ▶ The heated lid should be kept closed until temperatures of 30 °C or less are reached.
- ▶ Take note of the symbols on the thermoblock warning that surfaces may be hot.
- ▶ If you are using well caps consisting of thermally insulating material, please keep in mind that the temperature on the inside of the heated lid can be significantly higher than the temperature displayed.
- ▶ Before starting cleaning wait for the thermoblock and heated lid to cool down.



Warning! Injury from sharp-edged components.

When the Mastercycler pro is in the open position, sharp-edged components are exposed.

When cleaning the Mastercycler pro, the sharp edges on the rollflex cable and the guide rail may cause injuries.

- ▶ Take special care and wear protective gloves.



Warning! Injury from trapping or crushing.

- ▶ Do not place your fingers between the lid and the housing when opening and closing the device or when opening it into the cleaning position.
- ▶ Do not reach in under the open lid.
- ▶ Take care that the stand is properly engaged so that the lid stays in the opened position.

Caution! Damage to heated lid from sharp-edged sample tubes or objects.

- ▶ Use only tubes whose properties meet at least the requirements specified in these operating instructions.
- ▶ Do not use any sharp-edged or sharp objects on the heated lid.
- ▶ Extra caution should be exercised when cleaning so as not to damage the heated lid.

Caution when using aggressive chemicals.

Aggressive chemicals may damage both the device and its accessories.

- ▶ Do not use any aggressive chemicals on the device and accessories such as strong or weak bases, strong acids, acetone, formaldehyde, halogenated hydrocarbons or phenol.
- ▶ If the device becomes contaminated with aggressive chemicals, clean it immediately with a neutral cleaning agent.



We recommend that you regularly clean the surfaces of the Mastercycler pro.

10.1.1 Cleaning the housing

- ▶ Clean the surfaces of the Mastercycler pro with a damp, lint-free cloth. Use a neutral lab cleaner if necessary.

Instructions on disinfecting and decontaminating the device are described separately (see *Disinfection / decontamination* on page 62).

10 Maintenance

EN

Operating Manual

10.1.2 Cleaning the heated lid

Moving the heated lid into cleaning position

1. Push the heated lid into rear position.

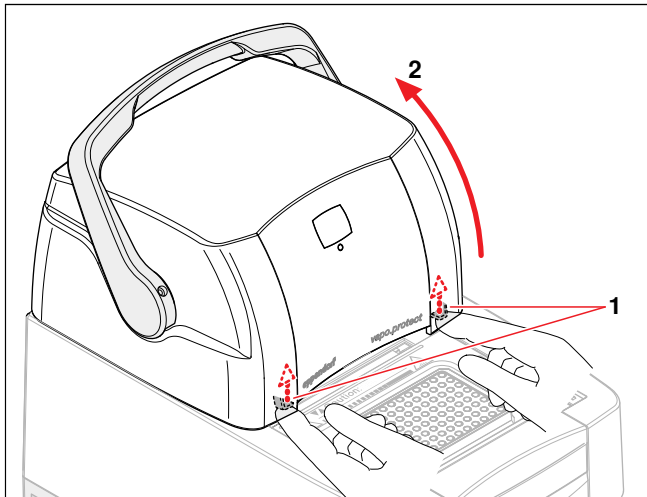

2. To open the lock, press the left and right latches underneath the front edge of the heated lid upwards (1).
3. Fold up the heated lid (2) until the stand (4) is locked.

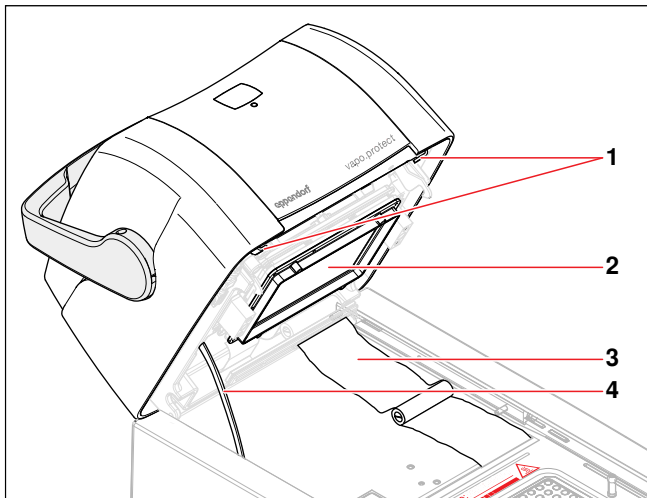

| | |
|------------------------------|-----------------------|
| 1 Lid release latches | 2 Heating unit |
| 3 Rollflex cable | 4 Stand |

4. Remove any contamination in the area of the block and on the inner side of the lid with a damp, lint-free cloth. Use a neutral lab cleaner if necessary. Remains of markings from tube lids on the heating unit can be removed with ethanol or isopropanol.



Keep the block bores free of dust and lint. Even small amounts of deposits can affect the heat transfer between the block and sample tubes.

10 Maintenance

Moving the lid out of the cleaning position

1. While holding the front edge of the lid with your right hand, pull the stand **1** forwards with your left hand.

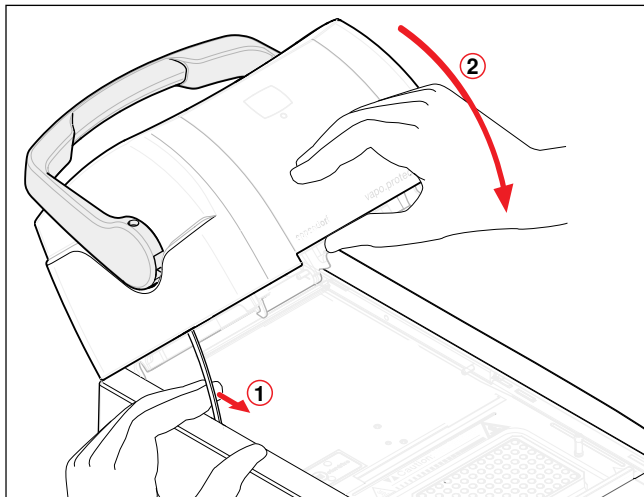

2. Lower the heated lid slowly until it locks into the horizontal position.

10.2 Disinfection / decontamination



Danger! Electric shock as a result of penetration of liquid.

- ▶ Switch off the device and disconnect it from the power supply before starting cleaning or disinfecting.
- ▶ Do not allow any liquids to enter the inside of the housing.
- ▶ Do not perform spray disinfection.
- ▶ Only reconnect the device to the power supply once it is completely dry.

Caution! Material damage from UV and other high-energy radiation.

- ▶ Do not use UV, beta, or gamma radiation or any other high-energy radiation source for disinfecting.

Required equipment

- Alcohol (ethanol, isopropanol) or disinfectants containing alcohol
- Mild, soap-based household cleaning agent

Proceed as follows:

1. Select a disinfection method that complies with the legal regulations and guidelines applicable to your range of application.
2. Switch off the device and disconnect it from the power supply.
3. Wipe down all parts of the device and accessories, including the connecting cable, with the disinfectant.
4. Clean the device with a mild soap-based household cleaning agent (see *Cleaning* on page 60).

10 Maintenance

10.3 Decontamination before shipping

If you are shipping the device to the authorized Technical Service for repairs or to your authorized dealer for disposal please note the following:



Warning! Risk to health from contaminated device

1. Follow the instructions in the decontamination certificate. It is available in PDF format on our homepage (www.eppendorf.com/decontamination).
 2. Decontaminate all the parts you want to dispatch.
 3. Enclose the fully-completed decontamination certificate for returned goods (incl. the serial number of the device) with the dispatch.
-

11 Troubleshooting

11.1 General errors

Technical faults may be triggered by faults such as a power failure or power fluctuations. In most cases it is therefore sufficient simply to switch the device off and back on again after about 10 seconds. If the fault occurs again, please note the fault code (e.g. 0x0B04) and inform Eppendorf Service.

11.2 Error messages

| Symptom / message | Cause | Remedy |
|--------------------------------------|--|---|
| 0x0108 0x2800 to 0x2802 | The software versions of the control panel and the cyclor are not compatible. | ▶ A software synchronization is needed (see <i>System settings</i> on page 48). |
| 0x0140 | Incompatible or defective mouse | ▶ Check the plug connection of the mouse or replace the mouse. |
| 0x0709 0x070A 0x070B | Damaged file found during software update. | ▶ Download the software update packet (ZIP archive) again from the Eppendorf homepage and unpack it on an empty MMC. ▶ Replace the MMC. |
| 0x0D1D 0x0D1E 0x2600 to 0x260F | Incompatible or defective printer, incorrect printer settings, loose cable connection. | ▶ Check the cable connection between the cyclor and the printer. ▶ Replace the printer cable. ▶ Check the printer status (e.g. paper blockage, offline). |
| 0x0D25 0x0D26 0x2900 to 0x2906 | Communication problem with the temperature validation system. | ▶ Check cables between the cyclor and the temperature validation system, using the temperature validation system documentation as a reference. |
| 0x0DA1 0x0DA2 | Incorrect lid status. | ▶ Make sure that the lid is fully in the front position at the program start and is not wedged. ▶ Insert the sample tubes into the block before the program start. |



If further error messages appear:

1. Switch off the Mastercycler pro.
2. Check all cable connections.

If the fault occurs again after switching on the device, please note the fault code and contact Eppendorf Service.

12 Transport, storage and disposal

12.1 Packing



Warning! Risk of injury when lifting and transporting the device.

Lifting the device with the wrong posture may cause serious damage to your health. If the device falls to the ground it can cause injuries.

- ▶ Do not lift the device by the handle or the housing of the heated lid.
- ▶ Carry the device securely with both hands to prevent it from slipping.
- ▶ Always keep a straight back when lifting and carrying the device.

Caution! Injury caused by breakage or slipping of packing materials.

If the device falls to the ground it can cause injuries.

- ▶ Always hold the device at the base of the housing when lifting it.
- ▶ Do not lift the device by the packing materials.

Caution! Damage as a result of incorrect packing.

Eppendorf accepts no warranty or liability for damage caused by incorrect packing.

- ▶ Only dispatch the device in the original packaging provided for transport.

For storage and transport purposes, package the Mastercycler pro and the control panel using the packing material provided. If you do not have this anymore or if it is damaged, contact your Eppendorf office.

The packaging of the Mastercycler pro consists of:

- 1 plastic bag for wrapping the Mastercycler pro
- 1 foam bottom part
- 1 foam lid part
- 1 carton consisting of bottom, lid and insert for small parts
- 4 plastic locking clips
- 1 empty PCR plate

Proceed as follows:

1. Pay attention to the decontamination notes (see *Decontamination before shipping* on page 63).
2. Switch off Mastercycler pro and open the heated lid.
3. Allow the device to stand for 30 minutes and ensure that the thermoblock is completely free of condensation.
4. Disconnect the Mastercycler pro from the power supply.
5. Disconnect all the connections from the rear of the Mastercycler pro and remove the control panel.
6. Load the thermoblock with an empty PCR plate.
7. Close the heated lid.
8. Pack the Mastercycler pro into the plastic bag.
9. Place the foam bottom part onto the bottom of the packaging.
10. Take the Mastercycler pro at the front and back lower housing and lift it into the foam bottom part.
11. Place the foam lid part onto the Mastercycler pro.
12. Close the carton lid and insert the four plastic locking clips into the cut-outs on the side of the carton.
13. For fastening, push in the flaps of the plastic locking clips.

12 Transport, storage and disposal

12.2 Transport

- ▶ Use only the original packaging for transport.
The transport and storage conditions are described separately (see *Ambient conditions* on page 67).

12.3 Disposal

In the event of disposing of the product, please observe the applicable legal regulations.

Information on the disposal of electrical and electronic devices in the European Community

The disposal of electrical devices is regulated within the European Community by national regulations based on EU Directive 2002/96/EC pertaining to waste electrical and electronic equipment (WEEE).

In accordance with this, any devices delivered after 13/08/2005 on a business-to-business basis, which includes this product, may no longer be disposed of in household waste. To document this they have been marked with the following identification:



As disposal regulations may differ from one country to another within the EU please contact your supplier, if necessary.

13 Technical data

13.1 Power supply

| | |
|--------------------------|------------------------------|
| Voltage | 100 to 130 V 200 to 240 V |
| Frequency | 50 Hz to 60 Hz |
| Power consumption | 950 W |
| Overvoltage category | II (IEC 610 10-1) |
| Degree of contamination: | 2 |
| Protection class | 1 |

13.2 Weight / dimensions

| | |
|------------------------|--|
| Dimensions (W x D x H) | 26.0 cm x 41.5 cm x 37.0 cm (without control panel) 26.0 cm x 50.0 cm x 44.5 cm (with lid in cleaning position) Depth with the control panel connected: + 14 cm. |
| Weight | 18.5 kg (without control panel) |

13.3 Ambient conditions

| | |
|--------------------|--|
| General operation | +15 °C to +35 °C to 70 % rel. humidity up to 2000 m above sea level (approx. 80 kPa) |
| Storage conditions | -20 °C to +70 °C to 85 % rel. humidity |

13.4 Application parameters

| Parameter | Mastercycler pro | Mastercycler pro S | Mastercycler pro 384 |
|---|--|--------------------|---------------------------|
| Sample capacity | 96 x 0.2 ml PCR tubes or a 96-well PCR plate (unskirted, semi-skirted, skirted; according to SBS standard) | | one 384-well PCR plate |
| Temperature control range of the block | 4 °C to 99 °C | | |
| Gradient range | 1 °C to 20 °C | 1 °C to 24 °C | 1 °C to 20 °C |
| Temperature range of the gradient | 30 °C to 99 °C | | |
| Temperature control range of the lid | 37 °C to 110 °C | | |
| Block homogeneity * | | | |
| 35 °C | ≤ ±0.3 °C | | |
| 90 °C | ≤ ± 0.4 °C | | |
| Control accuracy* | ±0.2 °C | | |
| Heating rate** | approx. 4 °C/s | approx. 6 °C/s | approx. 4 °C/s |
| Cooling rate** | approx. 3 °C/s | approx. 4.5 °C/s | approx. 3 °C/s |

* with deactivated gradient function

** measurements on the block

13 Technical data

13.5 Control panel

| | |
|---|--|
| Number of Mastercycler pro devices that can be controlled the control panel | 1 to 5 |
| Number of programs | > 700 |
| Number of folders | > 100 |
| Max. number of cycles | 99 (1 to 20 temperature control steps per cycle) |
| Dimensions (W x D x H) | 25 cm x 16.5 cm x 11 cm |
| Weight | 1.7 kg |
| Connections | 2× USB for mouse, printer, USB storage medium and self test USB key 1× MMC slot |
| Power source/consumption | Occurs over connected Mastercycler pro |

14 Ordering information

14.1 Mastercycler pro

| Order No. (International) | Order No. (North America) | Description |
|------------------------------|------------------------------|--|
| 6321 000.019 6321 000.027 | - 950030010 | Mastercycler pro 230 V / 50 - 60 Hz 120 V / 50 Hz, with US-plug |
| 6325 000.013 6325 000.021 | - 950030020 | Mastercycler pro S 230 V / 50 - 60 Hz 120 V / 50 Hz, with US-plug |
| 6324 000.010 6324 000.028 | - 950030030 | Mastercycler pro 384 230 V / 50 - 60 Hz 120 V / 50 Hz, with US-plug |
| 6320 000.007 | 950030050 | Control Panel incl. connecting cable |

14.2 Accessories



Use only genuine Eppendorf accessories or accessories approved by Eppendorf.

| Order No. (International) | Order No. (North America) | Description |
|------------------------------|------------------------------|---|
| 6320 071.001 | 950030040 | Selftest USB Key for Mastercycler pro |
| 5341 612.006 5341 611.000 | 950014008 950014016 | CAN-Bus connecting cable between 2 thermomodules 50 cm 150 cm |
| 5075 780.003 | 960002008 | MultiMediaCard |
| 0055 000.298 | 950008059 | Temperature validation system for Mastercycler, Mastercycler ep, and Mastercycler pro |
| 5331 233.007 | on request | Sensor for 384 well block |
| 5349 810.001 5349 820.007 | 950017007 950017202 | CycleManager pro CD incl. instructions and connection cabel CD incl. instructions |

14.3 Consumables

| Order No. (International) | Order No. (North America) | Description |
|--|---|---|
| 0030 128.648 0030 128.656 0030 128.680 0030 128.664 0030 128.672 | 951020401 951020427 951020486 951020443 951020460 | twin.tec PCR Plate 96, skirted Wells colorless, 25 pcs. clear yellow red green blue |
| 0030 128.575 0030 128.583 0030 128.613 0030 128.591 0030 128.605 | 951020303 951020320 951020389 951020346 951020362 | twin.tec PCR Plate 96, semi-skirted Wells colorless, 25 pcs. clear yellow red green blue |

14 Ordering information

| Order No. (International) | Order No. (North America) | Description |
|--|---|--|
| 0030 128.508 0030 128.516 0030 128.540 0030 128.524 0030 128.532 | 951020702 951020711 951020745 951020729 951020737 | twin.tec PCR Plate 384 Wells colorless, 25 pcs. clear yellow red green blue |
| 0030 124.332 | 951010006 | 0.2 mL PCR tubes 1,000 pcs., colorless |
| 0030 124.359 | 951010022 | 8-tube strip, for 0.2 mL PCR Tubes colorless, pack of 120 (= 960 tubes) |
| 0030 127.650 | 951023060 | Heat Sealing Film 10 x 10 pcs. |
| 0030 127.668 | 951023205 | Peel-it-lite 100 pcs. |
| 0030 127.676 | 951023213 | Pierce-it-lite 100 pcs. |
| 0030 127.480 | 951023019 | PCR Film (self-adhesive), 100 pcs. |
| 0030 127.471 | 951023001 | PCR Foil, (self-adhesive) 100 pcs. |
| 0030 127.498 | 951023035 | Cap Strips, (8-strips) 25 x 12 pcs. |

14.4 Recommended auxiliary materials

| Order No. (International) | Order No. (North America) | Description |
|------------------------------|------------------------------|--|
| 0030 124.235 | 951010031 | Work tray for 96 x 0.2 mL PCR tubes set of 10 |
| 0030 124.243 | 951010049 | Frame for work tray set of 5 |
| 0030 127.153 | 951023108 | Capping Aid 1 pcs. |
| 5390 000.024 5390 000.016 | - 951023078 | Heat Sealer 230 V / 50 Hz 115 V / 60 Hz |
| 5390 100.029 | 951023086 | Base Plate for 384 Well-Plate |
| 3881 000.023 3881 000.031 | 022510541 022510525 | PCR-Cooler Pink Blue |
| 0030 127.455 | 951010065 | PCR Rack 10 pcs. |

Index

| | |
|--|--------|
| 1 | |
| 1 ... 3 StepCyc (program step) | 38 |
| A | |
| Access rights | 46 |
| Address display | 24 |
| Administrator functions | 46 |
| Alarm | |
| Activate | 49 |
| Deactivate | 49 |
| Auto-Restart | 50 |
| Auto-update control panel software | 52 |
| B | |
| Backup | 51 |
| Beeper | 49 |
| block (header setting) | 37 |
| C | |
| Change country settings | 48 |
| Change date | 48 |
| Change time | 48 |
| Cleaning | |
| Heated lid | 61 |
| Housing | 60 |
| Confirmation | 48 |
| Connect mouse | 22 |
| Connecting the printer | 22 |
| Control Panel | |
| Connect mouse | 22 |
| Connect to the Mastercycler pro | 19 |
| Shut down | 45 |
| Country Settings | 48 |
| D | |
| Date + Time | 48 |
| Decontamination | 63 |
| Define administrator PIN | 26 |
| Desinfection | 62 |
| Disposal | 66 |
| E | |
| Export | 51, 51 |
| Program listing | 40 |
| F | |
| fast (header setting) | 37 |
| Folders | |
| Changing the comment | 33 |
| Changing the name | 33 |
| Copy | 34 |
| Delete | 34 |
| Import | 52 |
| New | 33 |
| G | |
| Gradient | 35, 39 |
| Guest | |
| User | 28 |
| H | |
| Heated lid | |
| Address display | 24 |
| Cleaning position | 61 |
| Close | 23 |
| Open | 24 |
| Status lamp | 24 |
| Switch lid heater off automatically | 37 |
| Temperature control (manual) | 49 |
| Temperature control before program start | 36 |
| Hold (program step) | 38 |
| Holding time increment | 35 |
| I | |
| Impulse | 37 |
| Incubate | 49 |
| K | |
| Keys | 25 |
| L | |
| Logfile | |
| Display | 48 |
| Export | 48 |
| Login | 27 |
| Logout | 28 |
| M | |
| Mains connection | 19 |
| Mini-satellite system | |
| Networking | 13 |
| Setup | 20 |
| MMC | |
| Insert | 31 |
| Remove | 32 |
| Use | 31 |

Index

EN

Operating Manual

N

| | |
|--|--------|
| Navigation tree | 29 |
| Networking | |
| Connecting Mastercycler pro to Mastercycler ep | 21 |
| Mini-satellite system | 13, 20 |
| PC control | 13 |
| n StepCyc (program step) | 38 |

P

| | |
|---|----|
| Pause (program step) | 38 |
| PDF | 32 |
| PIN | |
| Activate | 49 |
| Administrator | 26 |
| Change | 47 |
| Deactivate | 49 |
| Define | 26 |
| Program | |
| Backup | 51 |
| Change comment | 34 |
| Continue | 44 |
| Copy | 34 |
| Delete | 34 |
| Edit header | 36 |
| Export | 51 |
| Import | 52 |
| Interrupt | 44 |
| New | 33 |
| Rename | 34 |
| Restore | 51 |
| Start | 42 |
| Stop | 44 |
| Transfer from the Mastercycler 533x | 54 |
| Write protection | 34 |

| | |
|-------------------------------------|----|
| Program editor | |
| Description | 35 |
| Editing parameters | 38 |
| Exit | 40 |
| Export program listing | 40 |
| Extended options | 39 |
| Header | 36 |
| Insert step | 37 |
| Open | 35 |
| Save program | 40 |
| Set gradient | 39 |
| Set holding time increment | 39 |
| Set temperature control speed | 39 |
| Set temperature increment | 39 |

| | |
|---|----|
| Program header | |
| Define cycler type | 36 |
| Impulse | 37 |
| Set lid temperature | 36 |
| Simulate Mastercycler gradient | 37 |
| Switch off lid at low block temperature | 37 |
| Temp. mode | 37 |
| TSP/ESP heated lid | 36 |

| | |
|-------------|----|
| Protocol | |
| Print | 45 |
| Save | 45 |
| View | 44 |

R

| | |
|---------------|----|
| Restart | 50 |
| Restore | 51 |

S

| | |
|---|----|
| safe (header setting) | 37 |
| Safety instructions | |
| Meaning of symbols | 8 |
| Sample tubes | 41 |
| Sample volume | 42 |
| Select Location | 18 |
| Self test | 50 |
| Show system memory | 48 |
| Simulate Mastercycler 5333/5331 | 37 |
| Software | |
| Synchronization | 49 |
| Update control panel | 52 |
| Update Cycler | 49 |
| Sound (program step) | 38 |
| Space requirements | 18 |
| Status lamp | 24 |
| Status view | 43 |
| Switch ESP on and off | 36 |
| Switch lid heater off automatically | 37 |
| Switch off device | 45 |
| Switch TSP on and off | 36 |
| System Memory | 48 |
| System settings | 48 |

T

| | |
|------------------------------------|--------|
| Temp (program step) | 38 |
| Temp. mode | 37 |
| Temperature control speed | 35, 39 |
| Temperature increment | 35, 39 |
| Text file format | 32 |
| Thermoblock | |
| Calibrate and adjust | 50 |
| Equipment | 41 |
| Sample volume | 42 |
| Self test | 50 |
| Temperature control (manual) | 49 |
| Validate | 50 |

Index

Time increment 39
 TXT 32

U

Unpacking 18
 Update control panel software 52
 USB
 Connect printer 22
 Connect storage medium 31
 Connections 21
 Remove storage medium 32
 Use storage media 31
 User
 Change 28
 Login 27
 Logout 28
 User Log
 Display 49
 Export 49
 Export and clear 49
 User accounts
 Access rights 46
 Create 46
 Delete 47
 Edit 47

EG-Konformitätserklärung EC Conformity Declaration

Das bezeichnete Produkt entspricht den einschlägigen grundlegenden Anforderungen der aufgeführten EG-Richtlinien und Normen. Bei einer nicht mit uns abgestimmten Änderung des Produktes oder einer nicht bestimmungsgemäßen Anwendung verliert diese Erklärung ihre Gültigkeit.

The product named below fulfills the relevant fundamental requirements of the EC directives and standards listed. In the case of unauthorized modifications to the product or an unintended use this declaration becomes invalid.

Produktbezeichnung, Product name:

Mastercycler[®] pro, Mastercycler[®] pro S, Mastercycler[®] pro 384

Produkttyp, Product type:

Thermocycler und Control Panel / Thermocycler and Control Panel

Einschlägige EG-Richtlinien/Normen, Relevant EC directives/standards:

2006/95/EG, EN 61010-1, EN 61010-2-010, EN 61010-2-081

2004/108/EG, EN 55011/B, EN 61000-6-1, EN 61000-3-2/3, EN 61000-4-14

2011/65/EU

H.-G. Köh

Vorstand, Board of Management:

[Signature]

Projektmanagement, Project Management:

01.08.2011

Hamburg, Date:

eppendorf



Eppendorf AG · Barkhausenweg 1 · 22339 Hamburg · Germany

Eppendorf offices

AUSTRALIA & NEW ZEALAND

Eppendorf South Pacific Pty. Ltd.
Phone: +61 2 9889 5000
Fax: +61 2 9889 5111
E-mail: Info@eppendorf.com.au
Internet: www.eppendorf.com.au

AUSTRIA

Eppendorf Austria GmbH
Phone: +43 (0) 1 890 13 64 - 0
Fax: +43 (0) 1 890 13 64 - 20
E-mail: office@eppendorf.at
Internet: www.eppendorf.at

BRAZIL

Eppendorf do Brasil Ltda.
Phone: +55 11 30 95 93 44
Fax: +55 11 30 95 93 40
E-mail: eppendorf@eppendorf.com.br
Internet: www.eppendorf.com.br

CANADA

Eppendorf Canada Ltd.
Phone: +1 905 826 5525
Fax: +1 905 826 5424
E-mail: canada@eppendorf.com
Internet: www.eppendorfna.com

CHINA

Eppendorf China Ltd.
Phone: +86 21 38560500
Fax: +86 21 38560555
E-mail: market.info@eppendorf.cn
Internet: www.eppendorf.cn

CZECH REPUBLIC

Eppendorf Czech & Slovakia s.r.o.
Phone: +420 323 605 454
Fax: +420 323 605 454
E-mail: eppendorf@eppendorf.cz
Internet: www.eppendorf.cz

FRANCE

Eppendorf France S.A.R.L.
Phone: +33 1 30 15 67 40
Fax: +33 1 30 15 67 45
E-mail: eppendorf@eppendorf.fr
Internet: www.eppendorf.fr

GERMANY

Eppendorf Vertrieb
Deutschland GmbH
Phone: +49 2232 418-0
Fax: +49 2232 418-155
E-mail: vertrieb@eppendorf.de
Internet: www.eppendorf.de

INDIA

Eppendorf India Limited
Phone: +91 44 42 11 13 14
Fax: +91 44 42 18 74 05
E-mail: info@eppendorf.co.in
Internet: www.eppendorf.co.in

ITALY

Eppendorf s.r.l.
Phone: +390 2 55 404 1
Fax: +390 2 58 013 438
E-mail: eppendorf@eppendorf.it
Internet: www.eppendorf.it

JAPAN

Eppendorf Co. Ltd.
Phone: +81 3 5825 2363
Fax: +81 3 5825 2365
E-mail: info@eppendorf.jp
Internet: www.eppendorf.jp

NORDIC

Eppendorf Nordic Aps
Phone: +45 70 22 2970
Fax: +45 45 76 7370
E-mail: nordic@eppendorf.dk
Internet: www.eppendorf.dk

SLOVAKIA

Eppendorf Czech & Slovakia s.r.o.
Phone: +421 911 181 474
E-mail: eppendorf@eppendorf.sk
Internet: www.eppendorf.sk

SOUTH & SOUTHEAST ASIA

Eppendorf Asia Pacific Sdn. Bhd.
Phone: +60 3 8023 2769
Fax: +60 3 8023 3720
E-mail: eppendorf@eppendorf.com.my
Internet: www.eppendorf.com.my

SPAIN

Eppendorf Ibérica S.L.U.
Phone: +34 91 651 76 94
Fax: +34 91 651 81 44
E-mail: eppendorf@eppendorf.es
Internet: www.eppendorf.es

SWITZERLAND

Vaudaux-Eppendorf AG
Phone: +41 61 482 1414
Fax: +41 61 482 1419
E-mail: vaudaux@vaudaux.ch
Internet: www.eppendorf.ch

THAILAND

Eppendorf (Thailand) Co. Ltd.
Phone: +66 2 379 4212-5
Fax: +66 2 379 4216
E-mail: info@eppendorf.co.th
Internet: www.eppendorf.com.my

UNITED KINGDOM

Eppendorf UK Limited
Phone: +44 1223 200 440
Fax: +44 1223 200 441
E-mail: sales@eppendorf.co.uk
Internet: www.eppendorf.co.uk

USA

Eppendorf North America, Inc.
Phone: +1 516 334 7500
Fax: +1 516 334 7506
E-mail: info@eppendorf.com
Internet: www.eppendorfna.com

OTHER COUNTRIES

Internet: www.eppendorf.com/worldwide



Evaluate your operating manual

www.eppendorf.com/manualfeedback

eppendorf
In touch with life

Your local distributor: www.eppendorf.com/worldwide

Eppendorf AG · 22331 Hamburg · Germany · Tel: +49 40 538 01-0 · Fax: +49 40 538 01-556 · E-Mail: eppendorf@eppendorf.com

Eppendorf North America, Inc. · 102 Motor Parkway, Suite 410 · Hauppauge, NY 11788-5178 · USA

Tel: +1 516 334 7500 · Toll free phone: +1 800 645 3050 · Fax: +1 516 334 7506 · E-Mail: info@eppendorf.com

Application Support

Europe, International: Tel: +49 1803 666 789 · E-Mail: support@eppendorf.com

North America: Tel: +1 800 645 3050, menu option 2 · E-Mail: techserv@eppendorf.com

Asia Pacific: Tel: +60 3 8023 6869 · E-Mail: support_asiapacific@eppendorf.com