



# Low-temperature catalytic oxidation of volatile organic compounds (VOC) mixture using wood fly ash (WFA) and oxygen

**Praveen Kolar**

Ph. D Candidate  
Biological and Agricultural Engineering  
The University of Georgia, Athens

IBE annual Meeting, Chapel Hill, NC, March 8, 2008



THE UNIVERSITY OF GEORGIA

COLLEGE OF AGRICULTURAL & ENVIRONMENTAL SCIENCES

# The goal is to treat air pollutants from poultry rendering emissions

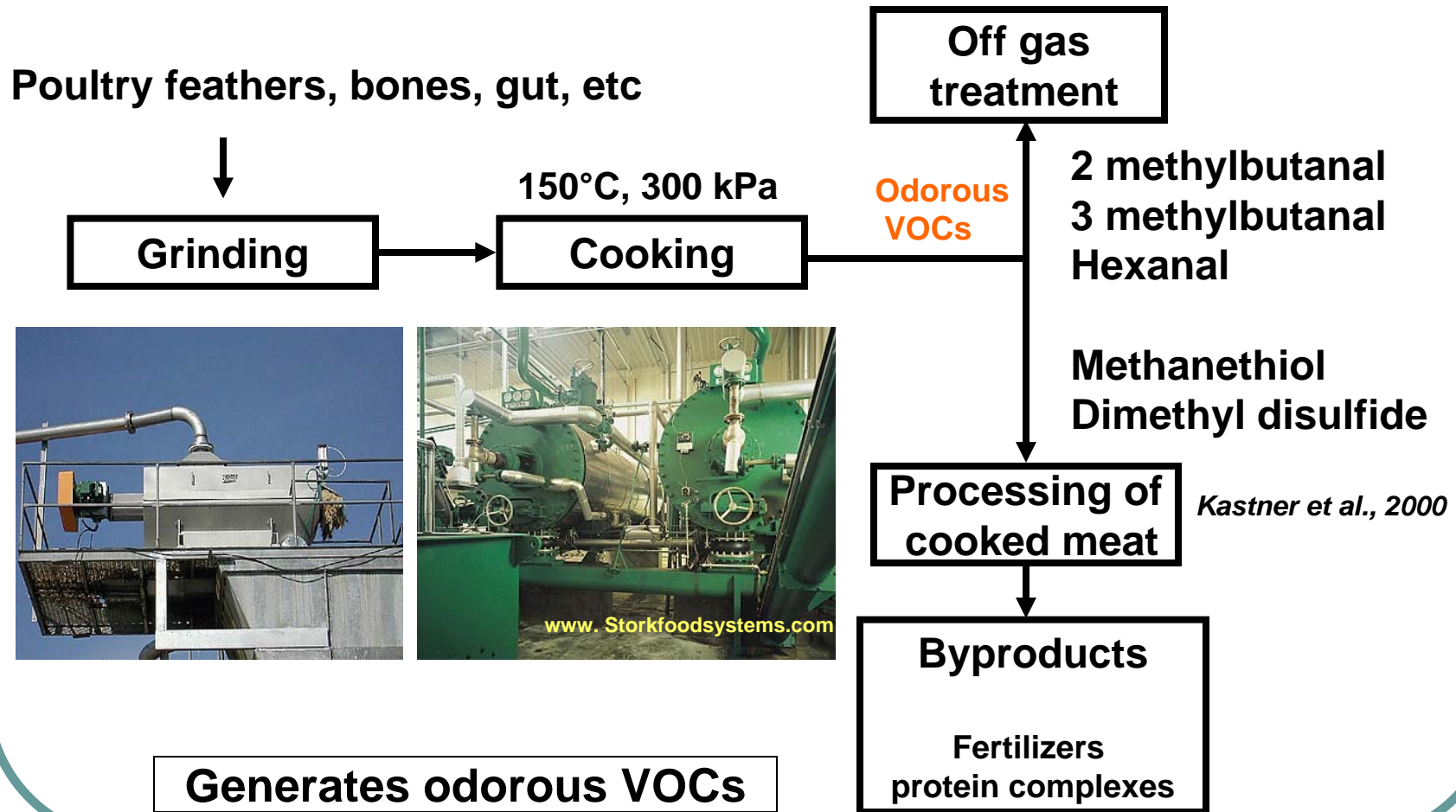

# Present treatment technology does not completely remove VOCs from rendering

## Chemical wet scrubber

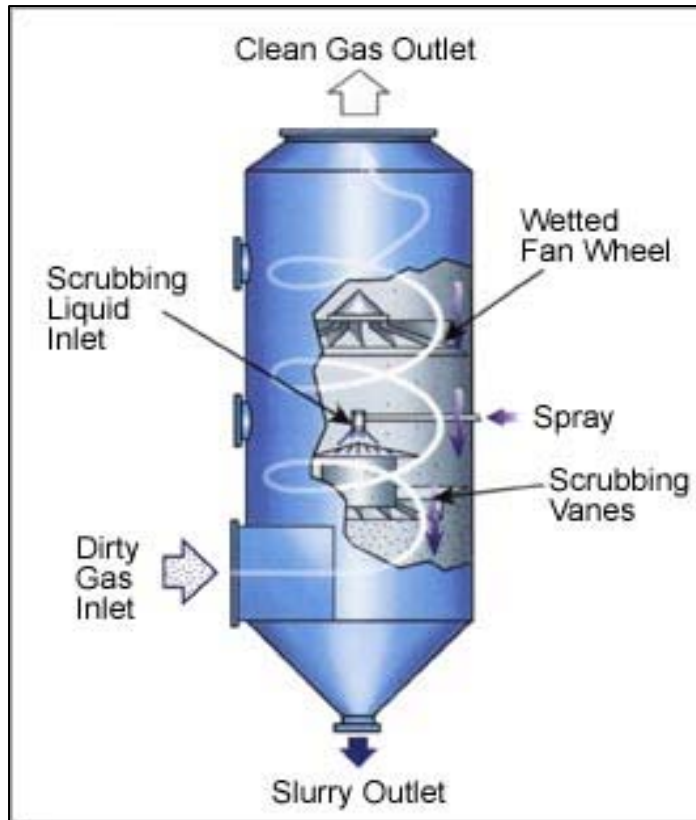

- **Liquid phase oxidation**
- **ClO<sub>2</sub> and Ozone**

- **Water intensive**
- **Expensive chemicals**
- **Selective reaction**
  - Sulfur based: good
  - Aldehydes: no reaction

- Kastner et al., 2003

**Need a more efficient technology**

# Catalytic oxidation (CATOX) has been used to treat several VOCs

## Limitations of current CATOX

- High temperature
- Expensive catalysts

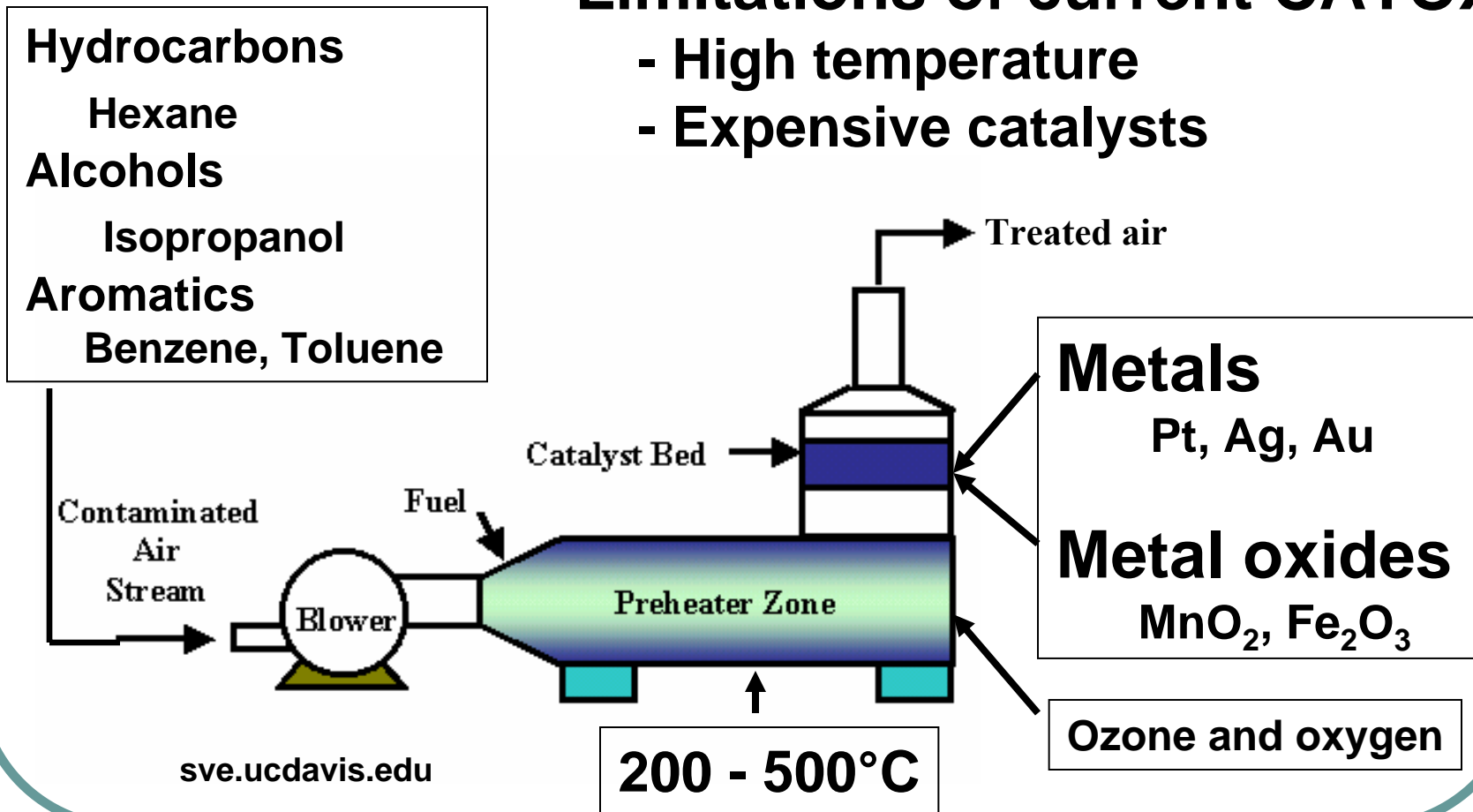

# Analysis of wood fly ash via SEM and XRD revealed carbon and metals

## What is wood fly ash ?

- Ash from burning of wood
- 5.5 Million Tons/Yr
- Contains metals and carbon

Quantitative results

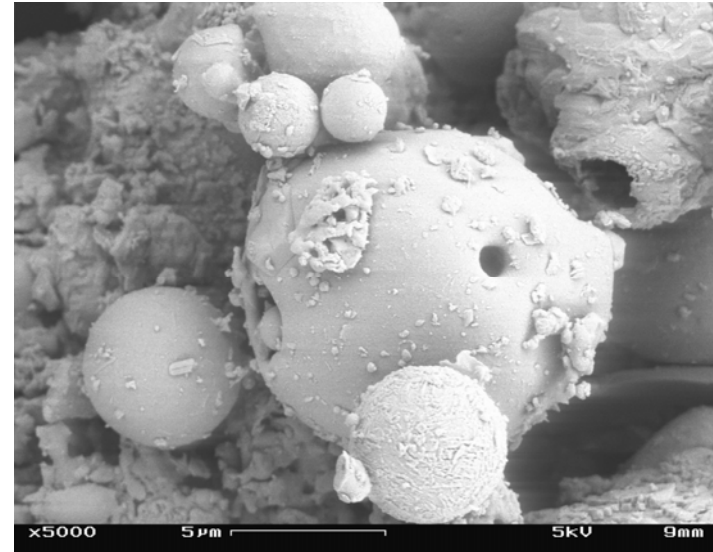
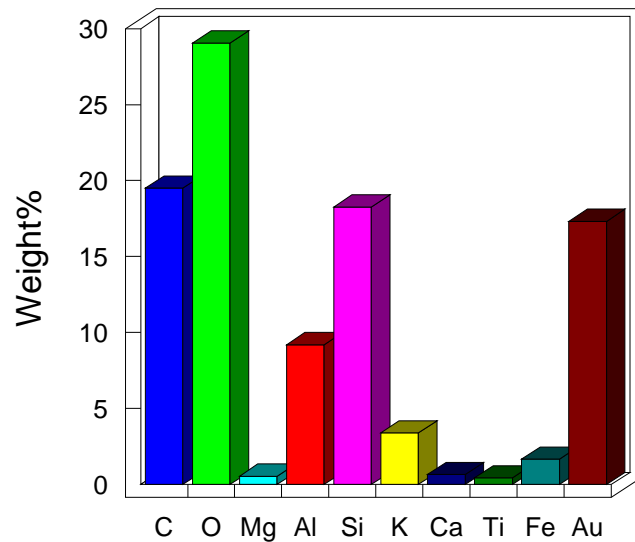

Density	0.54 g/cc
Area	45 ± 8 m <sup>2</sup> /g
pH	12 ± 0.12

# The objective was to test wood fly ash as a catalyst for oxidation of VOC mixture

**Test compounds: 2 methylbutanal (2-MB) and hexanal**

**Approach: Test individually and as mixture**

**Experimental: 2 L/min, 400-600 ppmv inlet, 160°C**

**Analytical: Gas chromatograph with MS and FID**

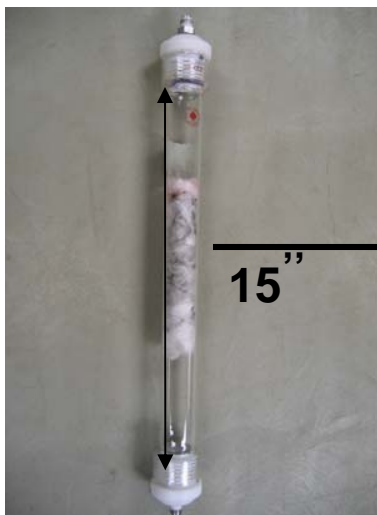

**Wood fly ash**



# Removal was measured in a packed bed continuous flow reactor system

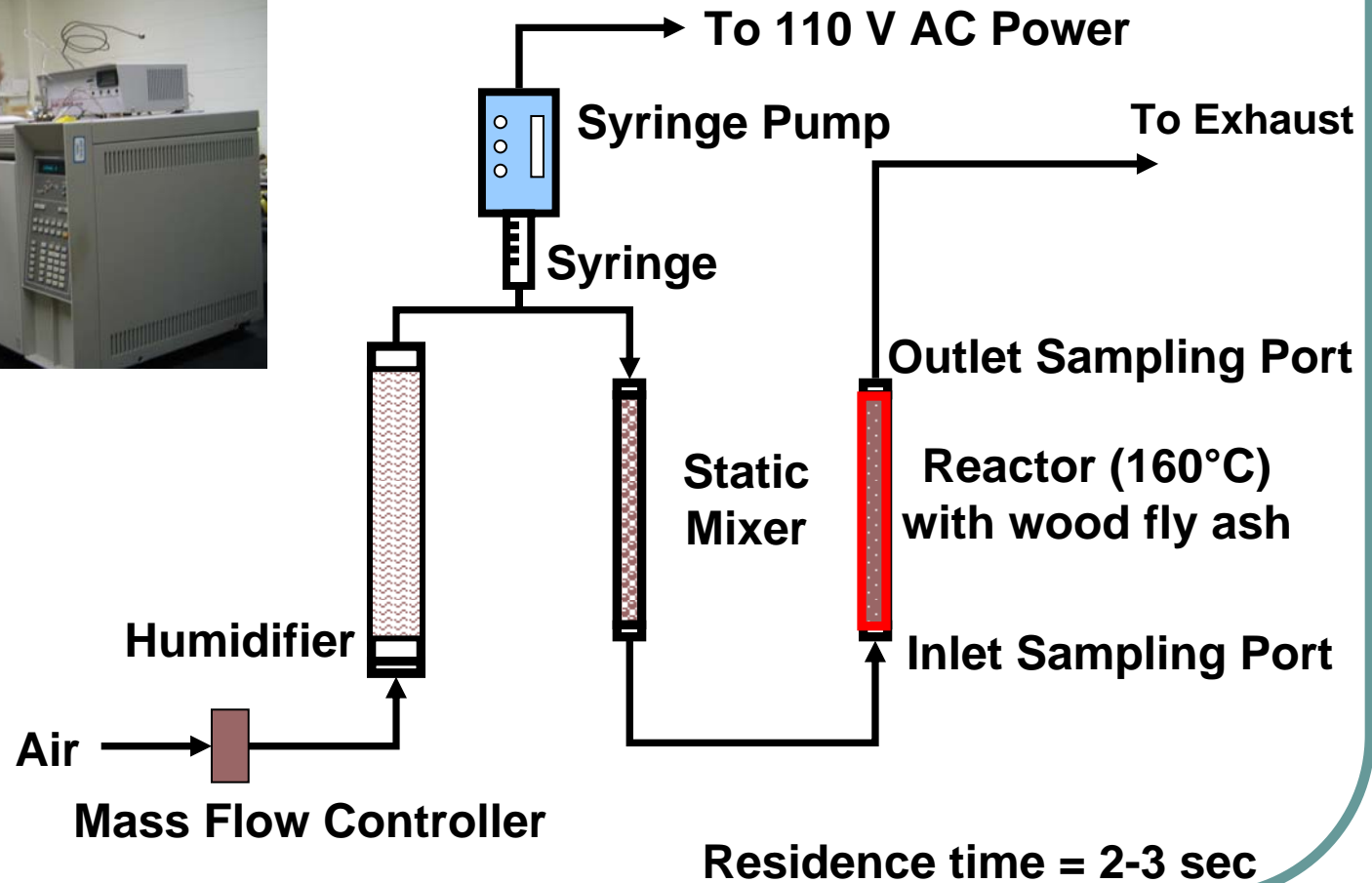

# 90 % of 2-methylbutanal was removed using wood fly ash

Flow = 2 L/min, Temperature = 160 °C  
Inlet =  $583 \pm 9$  ppmv, Outlet =  $53 \pm 3$  ppmv

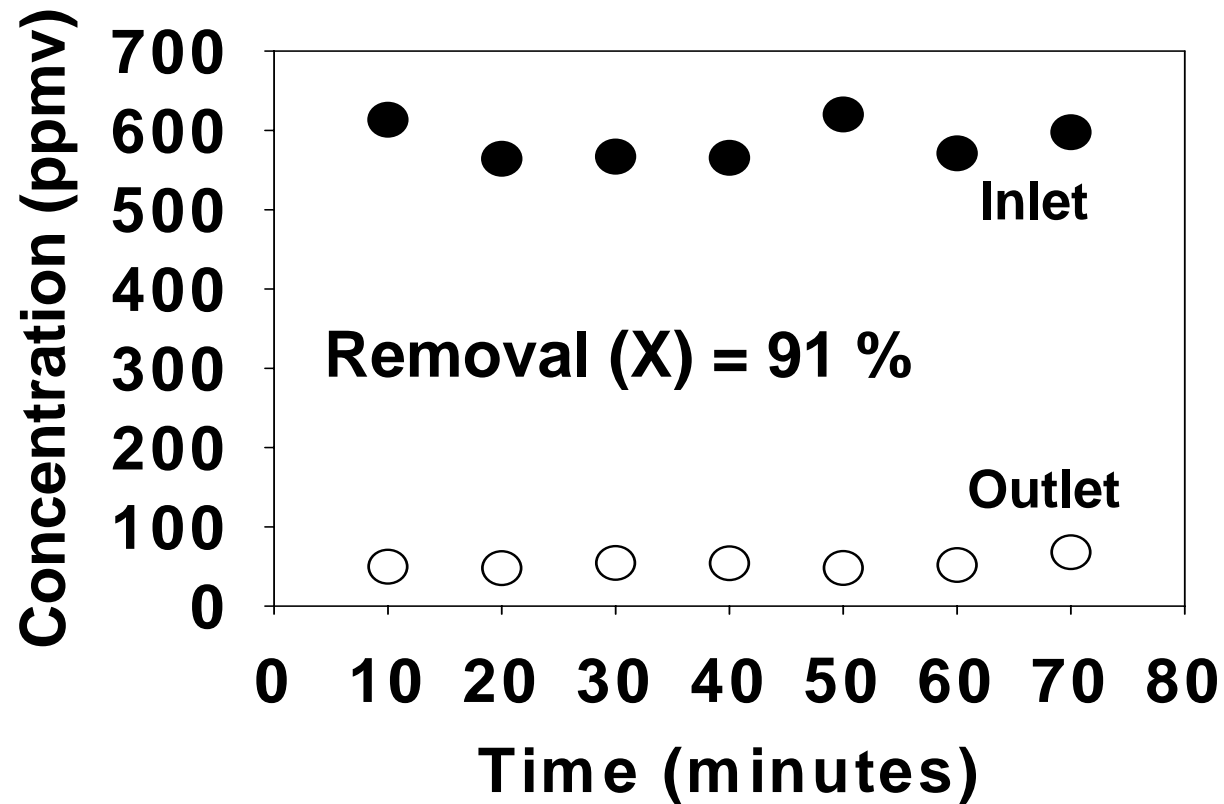



# 88 % of hexanal was removed using wood fly ash

Flow = 2 L/min, Temperature = 160 °C  
Inlet =  $414 \pm 15$  ppmv, Outlet =  $49 \pm 2$  ppmv

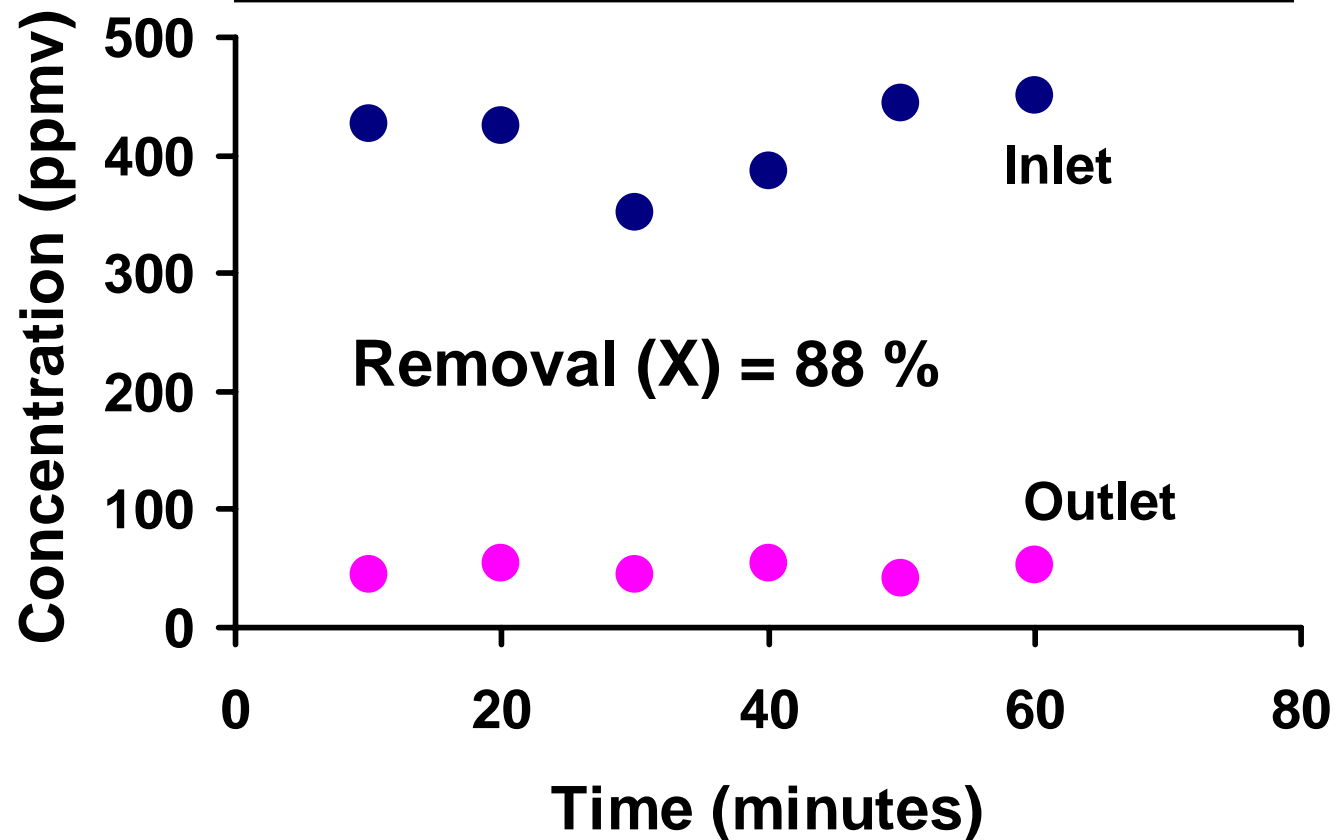

# 84-96 % of 2MB and hexanal mixture was removed

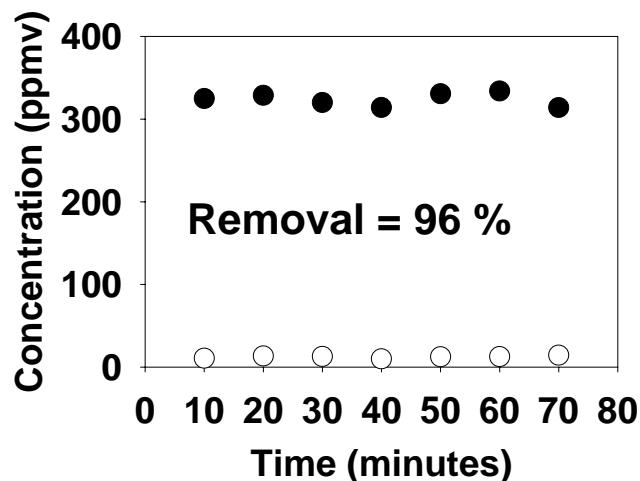

## 2 Methylbutanal

Flow = 2 L/min

Temperature = 160 °C

Inlet (ppmv) = 324 ± 3

Outlet = 12 ± 0.6

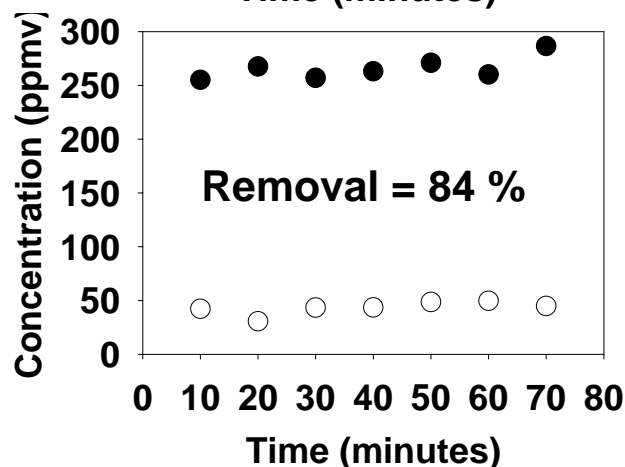

## Hexanal

Flow = 2 L/min

Temperature = 160 °C

Inlet (ppmv) = 266 ± 4

Removal (%) = 43 ± 2

# A differential plug flow reactor model was used for determining oxidation rates

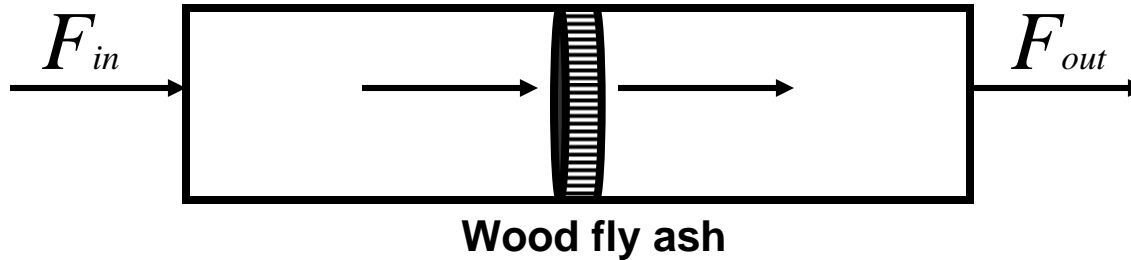

$$F_{in} - F_{out} + rW = \frac{dN}{dt} \rightarrow 0 \quad \text{Mole balance equation}$$

Assuming steady, isothermal, and isobaric conditions

$$-r = Q_0 \frac{P_T}{RT} y \frac{X}{W} \quad \text{Final equation}$$

$Q_0$  = Flow rate,  $P_T$  = Total pressure

$y$  = Mole fraction,  $X$  = % Conversion

$T$  = Temperature,  $R$  = Gas const

$W$  = Catalyst mass

# Wood fly ash was comparable with other catalysts

Compound	Catalyst	Concentration (ppmv)	Temp (°C)	Reaction rates x 10 <sup>-8</sup> mol/g-s	Reference
2-methylbutanal hexanal	Wood fly ash	400-600	160	3.2 - 4.7	This work
Formaldehyde	MnOx-CeO <sub>2</sub>	580	60-100	5	Tang et al., 2006
Acetaldehyde	Pt/Rh	360 - 510	205	13 - 14	Liakopoulos et al., 2001
Hexane	Pt-Ni/ $\gamma$ -Al <sub>2</sub> O	200-566	164-221	1-18	Gangwal et al., 1988

Based on the experimental data the reactor may be designed for 99 % removal

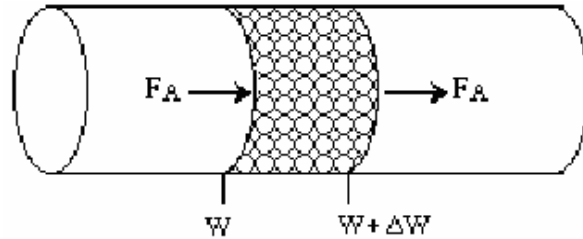

$$-r = \frac{dF}{dW}$$

$$W = Q \int_{C_{in}}^{C_{out}} \frac{dC_{in}}{k C_{in}^n}$$

$$\rho \left( \frac{V}{Q} \right) = \rho \tau = \int_{C_{in}}^{C_{out}} \frac{dC_{in}}{r}$$

**In summary, wood fly ash may be used as a catalyst to treat aldehydes**

## **Wood fly ash is catalytically active**

- **Oxygen can be used as an oxidant**
- **Can remove mixtures**
- **90-99 % removal may be possible in 3-5 sec (at 160°C)**

# Acknowledgements

**Dr. Jim Kastner**  
**Dr. Mark Eiteman**  
**Dr. K. C. Das**  
**Dr. James Anderson**  
**Ms. Joby Miller**



The University of Georgia

**Engineering**

Department of Biological  
and Agricultural Engineering



**U.S. Poultry & Egg Association**

1530 Cooledge Road, Tucker, Ga. 30084 -7303  
Tel: (770) 493-9401, Fax: (770) 493-9257





# 80-90 % of mixture was removed with oxygen and ozone and wood fly ash

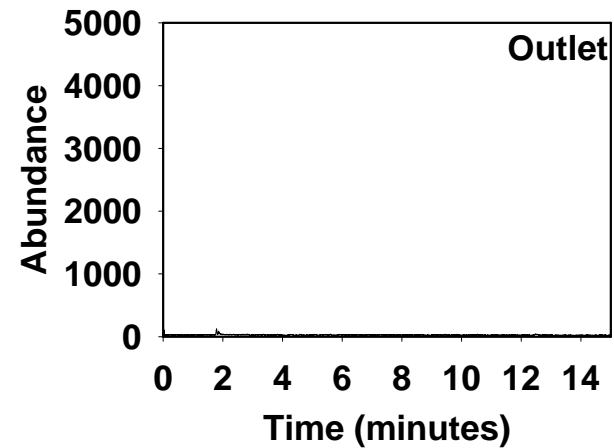
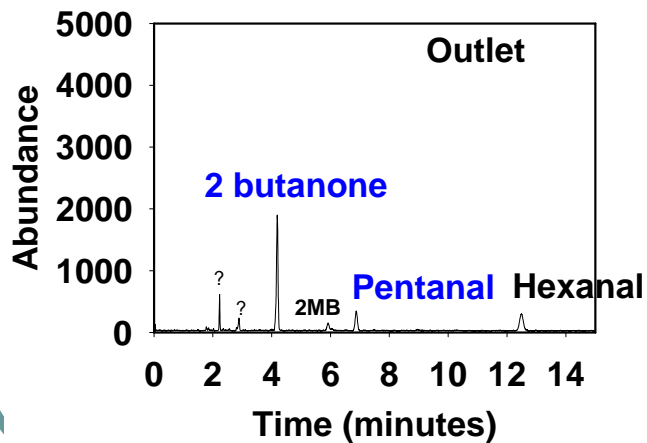
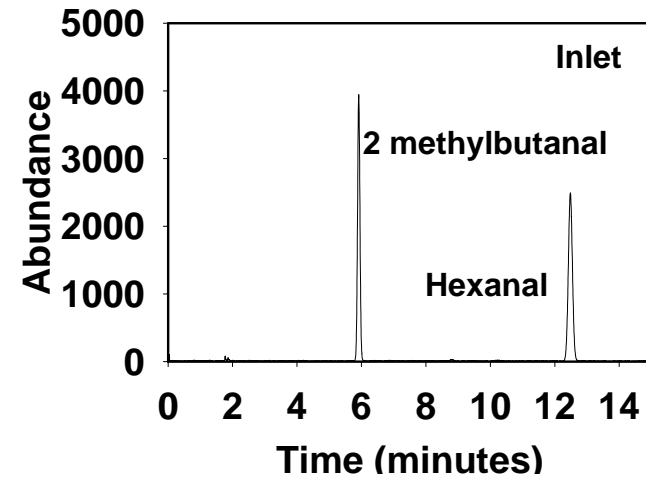
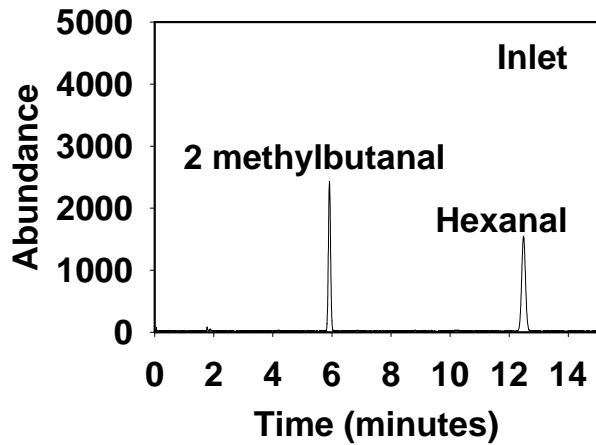

# Wood fly ash and ozone completely oxidized aldehydes (160 deg C, 2L/min flow, 10 g ash)

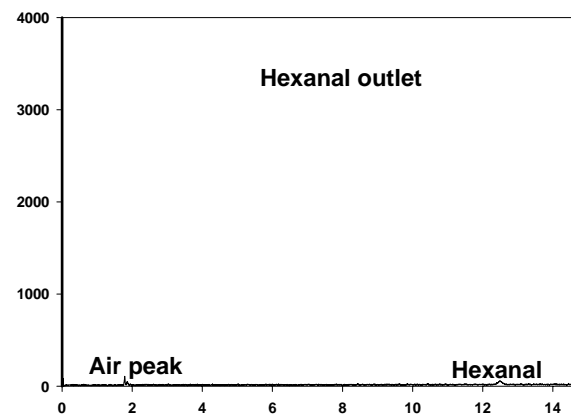
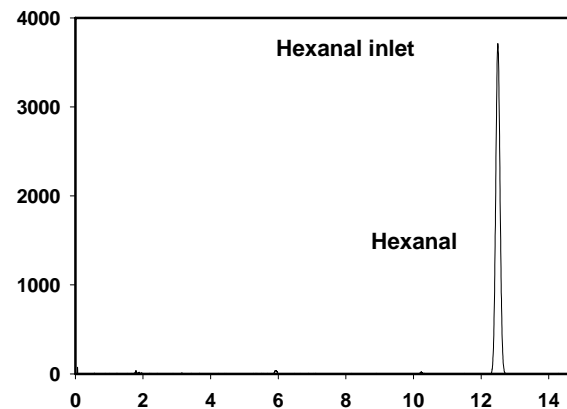
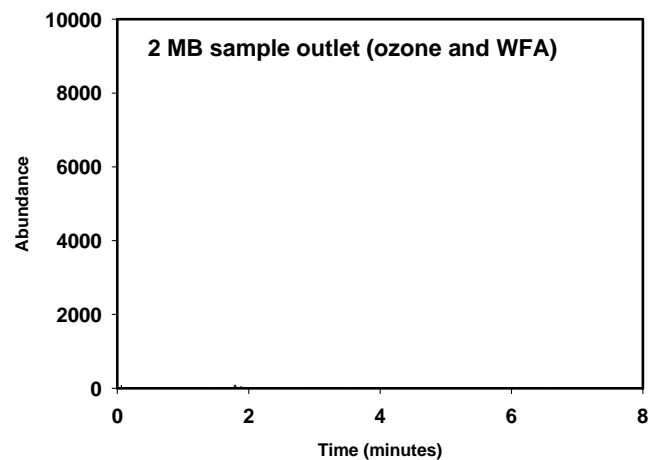
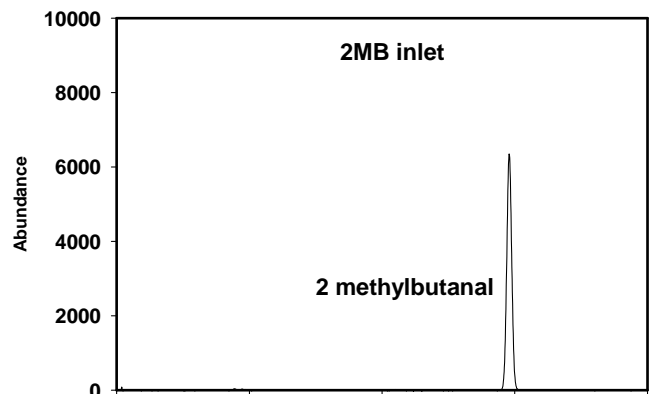

# Volatile organic compounds (VOCs) are hazardous

**VOC:** Any carbon-based chemical that participates in photochemical reactions (USEPA 40 CFR Part 5)

**Health:** Short and long term

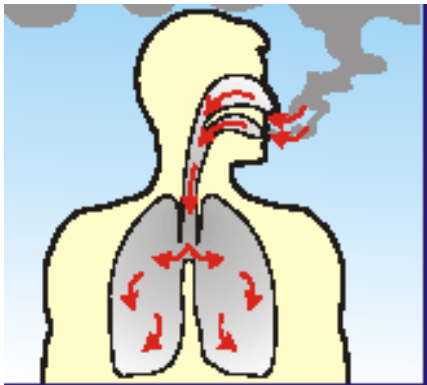

**Environmental:** Ozone, PM

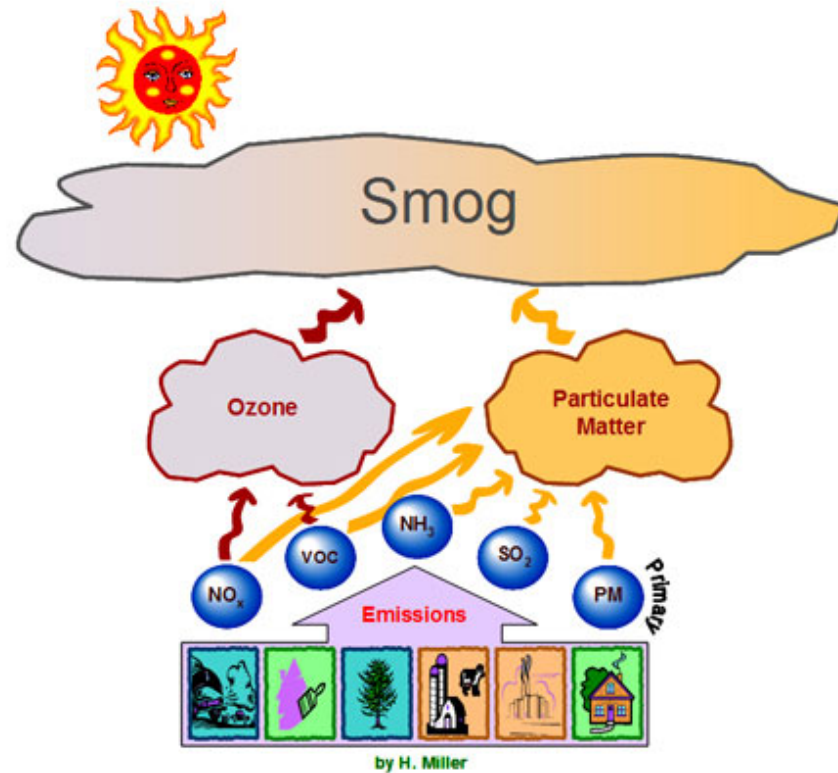

Environment Canada

**VOCs are mostly manmade**

# Poultry rendering generates odorous VOCs

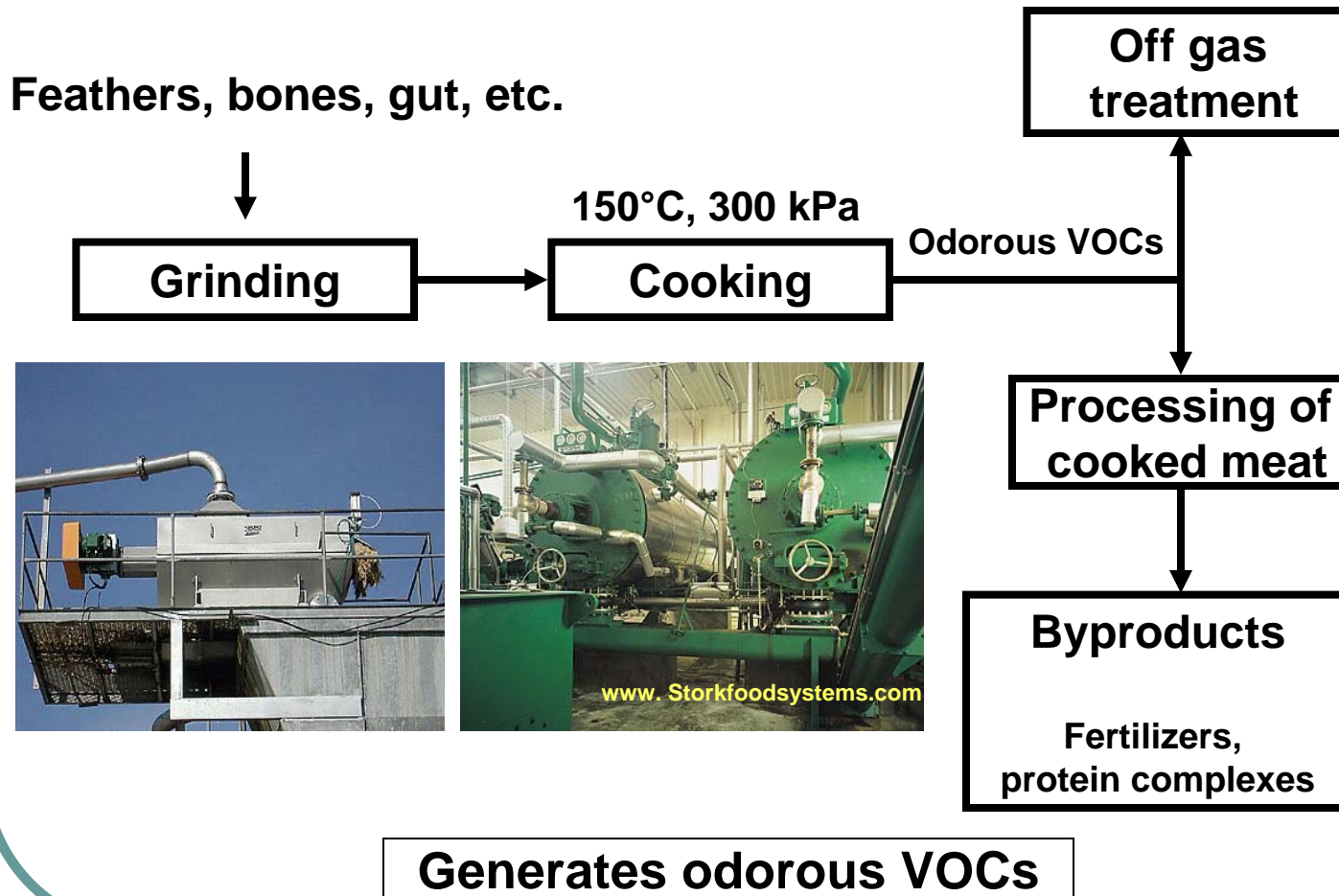

# Oxygen and wood fly ash removed up to 90 % of mixture within 3 seconds

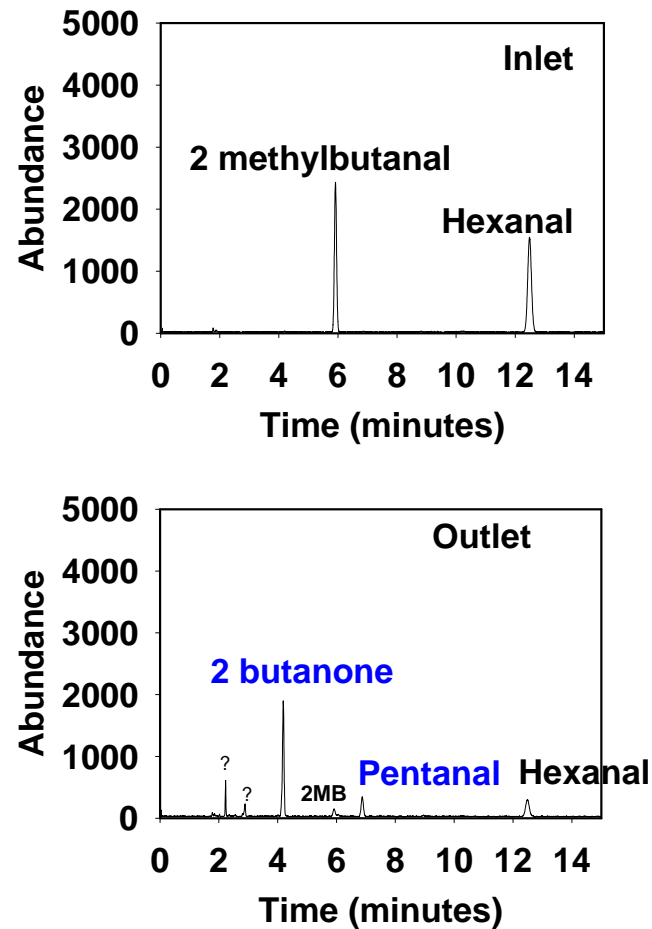

# Ozone completely oxidized 2-MB and hexanal mixture within 3 seconds

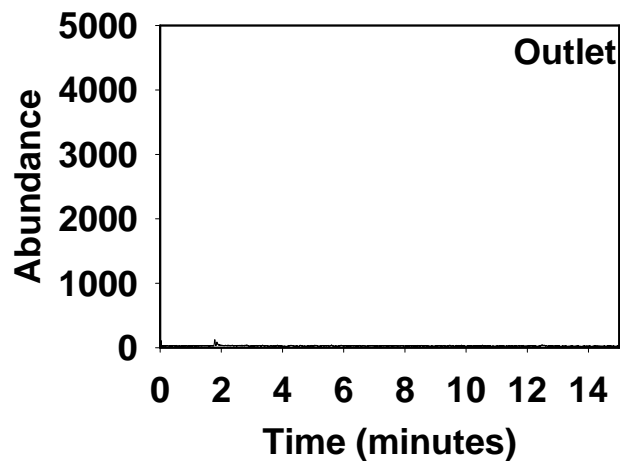
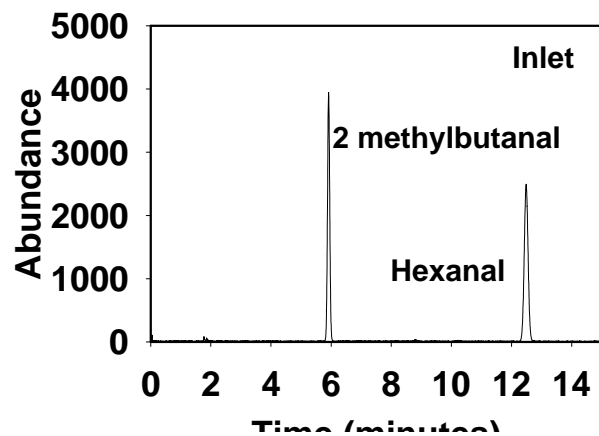

# 100 % removal was obtained with ozone and wood fly ash

