

Modelling Our System

Christin S. and Farah V.

Slide2: General Derivation

Assumptions:

- Concentration of promoters is constant
- Promoter P and activator A are in equilibrium with their complex PA
- The reaction forming the protein Z is irreversible
- Note: Contrarily to Michaelis-Menten, the substrate is not used up & the protein Z rebinds the promoter

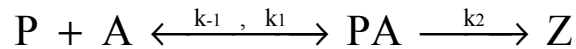

$$\frac{d[PA]}{dt} = k_1[P][A] - k_{-1}[PA] = 0 \quad (\text{steady state reached quickly if } k_1 > k_{-1})$$

$$(1) \quad [PA] = \frac{k_1[P][A]}{k_{-1}} = \frac{[P][A]}{K_D} \quad \text{where } K_D \equiv \frac{k_{-1}}{k_1}$$

$$\text{Note: in Michaelis-Menten } K_m = \frac{k_{-1} + k_2}{k_1} \approx \frac{k_{-1}}{k_1} = \frac{1}{K_D} \quad \text{if } k_2 \ll k_{-1}$$

As the total concentration of promoters is constant:

$$[P_0] = [P] + [PA] \quad \therefore [P] = [P_0] - [PA]$$

Substituting into (1):

$$[PA] = \frac{[P][A]}{K_D} = \frac{([P_0] - [PA])[A]}{K_D} \quad \therefore [PA] = \frac{[A][P_0]}{K_D + [A]}$$

The rate of protein synthesis is described by:

$$\frac{d[Z]}{dt} = k_2[PA] = \frac{k_2[P_0][A]}{K_D + [A]} = \frac{V_{\max}[A]}{K_D + [A]} \quad \text{where } V_{\max} \equiv k_2[P_0]$$

Modelling T9002

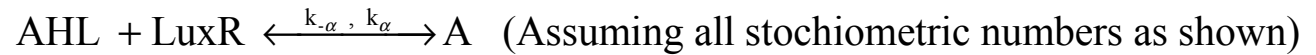

$$\frac{d[\text{A}]}{dt} = k_{\alpha}[\text{AHL}][\text{LuxR}] - k_{-\alpha}[\text{A}] = 0 \quad (\text{steady-state})$$

LuxR is constitutively produced and reaches steady state before AHL is added.

[LuxR] can be approximated as a constant: $[\text{LuxR}] \approx \lambda$

$$\therefore \frac{[\text{AHL}][\text{LuxR}]}{[\text{A}]} = \frac{\lambda[\text{AHL}]}{[\text{A}]} = \frac{k_{-\alpha}}{k_{\alpha}} = \frac{1}{K_{D\alpha}} \quad \therefore (2) \quad [\text{A}] = \lambda K_{D\alpha} [\text{AHL}]$$

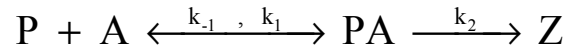

The rate of protein synthesis is described by:

$$\frac{d[\text{Z}]}{dt} = k_2[\text{PA}] = \frac{k_2[\text{P}_0][\text{A}]}{[\text{A}] + K_D} = \frac{V_{\max}[\text{A}]}{[\text{A}] + K_D} \quad \text{where } V_{\max} \equiv k_2[\text{P}_0]$$

(see Slide No. 2 for derivation)

The total change in protein concentration includes protein degradation:

$$\frac{d[\text{Z}]}{dt} = \frac{V_{\max}[\text{A}]}{[\text{A}] + K_D} - \delta_2[\text{Z}]$$

$$\text{Substituting Equation (2): } \frac{d[\text{Z}]}{dt} = \frac{V_{\max} \lambda K_{D\alpha} [\text{AHL}]}{\lambda K_{D\alpha} [\text{AHL}] + K_D} - \delta_2[\text{Z}]$$

Rearranging and substituting for Z:

$$(3) \quad \frac{d[\text{GFP}]}{dt} = \frac{V_{\max} [\text{AHL}]}{[\text{AHL}] + \frac{K_D}{\lambda K_{D\alpha}}} - \delta_{\text{GFP}} [\text{GFP}]$$

Key:

P: Promoter pLuxR

A: AHL/LuxR complex

PA: pLuxR/AHL/LuxR complex

Z: GFP

Note:



LuxR is present in excess of AHL.

The protein Z (AHL) associates with LuxR to form A. Thus, Z indirectly becomes the activator A.

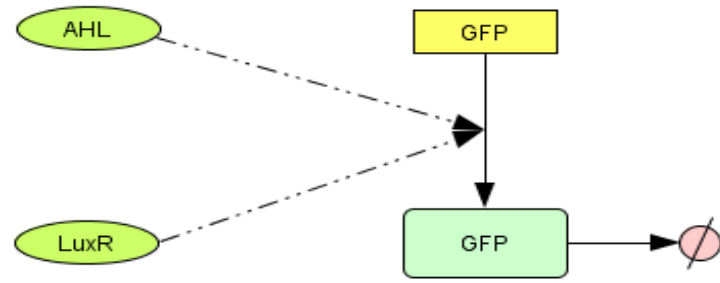

Fig.1a: Diagram for model
in cell designer

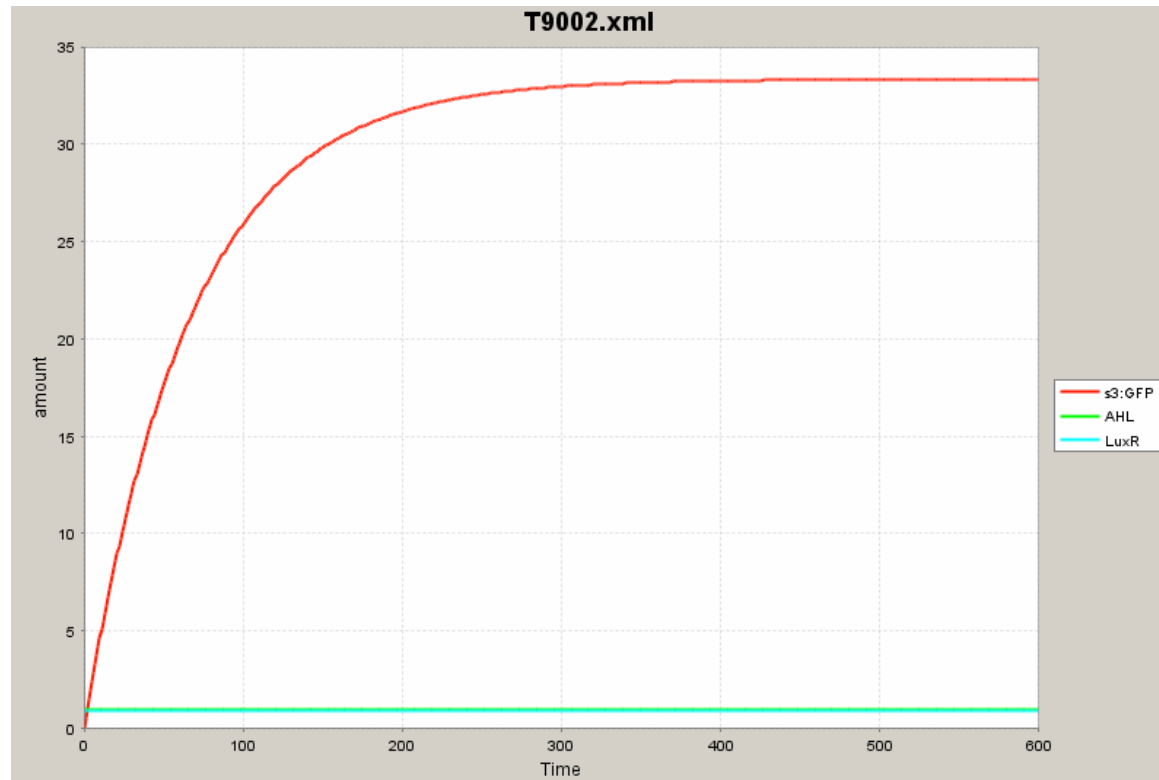

Fig.1b: Output from the model in Fig.1a

Input Values used to generate above graph:

$$\delta_{\text{GFP}} = 0.015 \text{ min}^{-1}, \quad \frac{K_D}{K_{D\alpha}} = 1.0$$

$$V_{\text{max}} = 1.0, \quad [\text{AHL}] = 1.0, \quad [\text{LuxR}] = 0.93$$

Equation:

$$\frac{d[\text{GFP}]}{dt} = \frac{V_{\text{max}} [\text{AHL}]}{[\text{AHL}] + \frac{K_D}{\lambda K_{D\alpha}}} - \delta_{\text{GFP}} [\text{GFP}]$$

Known or measurable parameters:

- [GFP], [AHL], GFP degradation

Parameters to extract from model:

- V_{max} , $\frac{K_D}{\lambda K_{D\alpha}}$

Extracting parameters: T9002

Measurements are taken after [GFP] has reached steady state ($\frac{d[\text{GFP}]}{dt}=0$):

$$\frac{d[\text{GFP}]}{dt} = \frac{V_{\max}[\text{AHL}]}{K_1 + [\text{AHL}]} - \delta_{\text{GFP}}[\text{GFP}] = 0 \quad \text{where } K_1 \equiv \frac{K_D}{\lambda K_{D\alpha}}$$

$$\therefore \delta_{\text{GFP}}[\text{GFP}] = \frac{V_{\max}[\text{AHL}]}{K_1 + [\text{AHL}]}$$

Lineweaver-Burk: $\frac{1}{\delta_{\text{GFP}}[\text{GFP}]} = \frac{K_1 + [\text{AHL}]}{V_{\max}[\text{AHL}]} = \frac{K_1}{V_{\max}[\text{AHL}]} \frac{1}{[\text{AHL}]} + \frac{1}{V_{\max}}$ (Plot of $\frac{1}{\delta_{\text{GFP}}[\text{GFP}]}$ versus $\frac{1}{[\text{AHL}]}$)

Eadie-Hofstee: $\delta_{\text{GFP}}[\text{GFP}](K_1 + [\text{AHL}]) = V_{\max}[\text{AHL}]$

$$\delta_{\text{GFP}}[\text{GFP}][\text{AHL}] = -\delta_{\text{GFP}}[\text{GFP}]K_1 + V_{\max}[\text{AHL}]$$

$$\delta_{\text{GFP}}[\text{GFP}] = -\delta_{\text{GFP}}K_1 \frac{[\text{GFP}]}{[\text{AHL}]} + V_{\max} \quad \text{(Plot of } \delta_{\text{GFP}}[\text{GFP}] \text{ versus } \frac{[\text{GFP}]}{[\text{AHL}]})$$

Modelling J37015

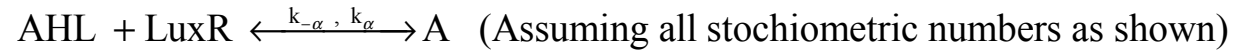

$$\frac{d[\text{A}]}{dt} = k_{\alpha}[\text{AHL}][\text{LuxR}] - k_{-\alpha}[\text{A}]$$

LuxR is constitutively produced and reaches steady state before AHL is added.

[LuxR] can be approximated as a constant: $[\text{LuxR}] \approx \lambda$

$$\frac{d[\text{A}]}{dt} = k_{\alpha}\lambda[\text{AHL}] - k_{-\alpha}[\text{A}] = 0 \quad (\text{steady-state})$$

$$\therefore \frac{[\text{AHL}]}{[\text{A}]} = \frac{k_{-\alpha}}{\lambda k_{\alpha}} = \frac{1}{\lambda K_{D\alpha}} \quad \therefore (4) \quad [\text{A}] = \lambda K_{D\alpha}[\text{AHL}]$$

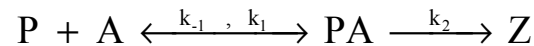

The rate of protein synthesis is described by:

$$\frac{d[\text{Z}]}{dt} = k_2[\text{PA}] = \frac{k_2[\text{P}_0][\text{A}]}{[\text{A}] + K_D} = \frac{V_{\max}[\text{A}]}{[\text{A}] + K_D} \quad \text{where } V_{\max} \equiv k_2[\text{P}_0]$$

(see Slide No. 2 for derivation)

The total change in protein concentration includes protein degradation:

$$\frac{d[\text{Z}]}{dt} = \frac{V_{\max}[\text{A}]}{[\text{A}] + K_D} - \delta_1[\text{Z}]$$

$$\text{Substituting Equation (4): } \frac{d[\text{Z}]}{dt} = \frac{V_{\max}\lambda K_{D\alpha}[\text{AHL}]}{\lambda K_{D\alpha}[\text{AHL}] + K_D} - \delta_1[\text{Z}]$$

Since AHL/LuxR complex is in equilibrium with AHL, we can approximate:

$$(5) \quad \frac{d[\text{AHL}]}{dt} = \frac{V_{\max}[\text{AHL}]}{[\text{AHL}] + \frac{K_D}{\lambda K_{D\alpha}}} - \delta_{\text{AHL}}[\text{AHL}]$$

Key:

P: Promoter pLuxR

A: AHL/LuxR complex

PA: pLuxR/AHL/LuxR complex

Z: AHL

Note:



LuxR is present in excess of AHL.

The protein Z (AHL) associates with LuxR to form A. Thus, Z indirectly becomes the activator A.

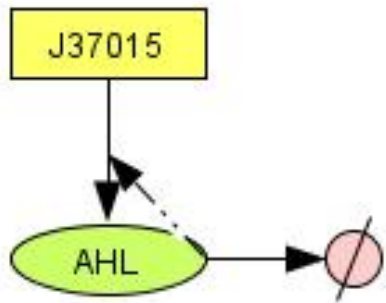

Fig.2a: Diagram for model in cell designer

Equation:

$$\frac{d[\text{AHL}]}{dt} = \frac{V_{\max} [\text{AHL}]}{[\text{AHL}] + \frac{K_D}{\lambda K_{D\alpha}}} - \delta_{\text{AHL}} [\text{AHL}]$$

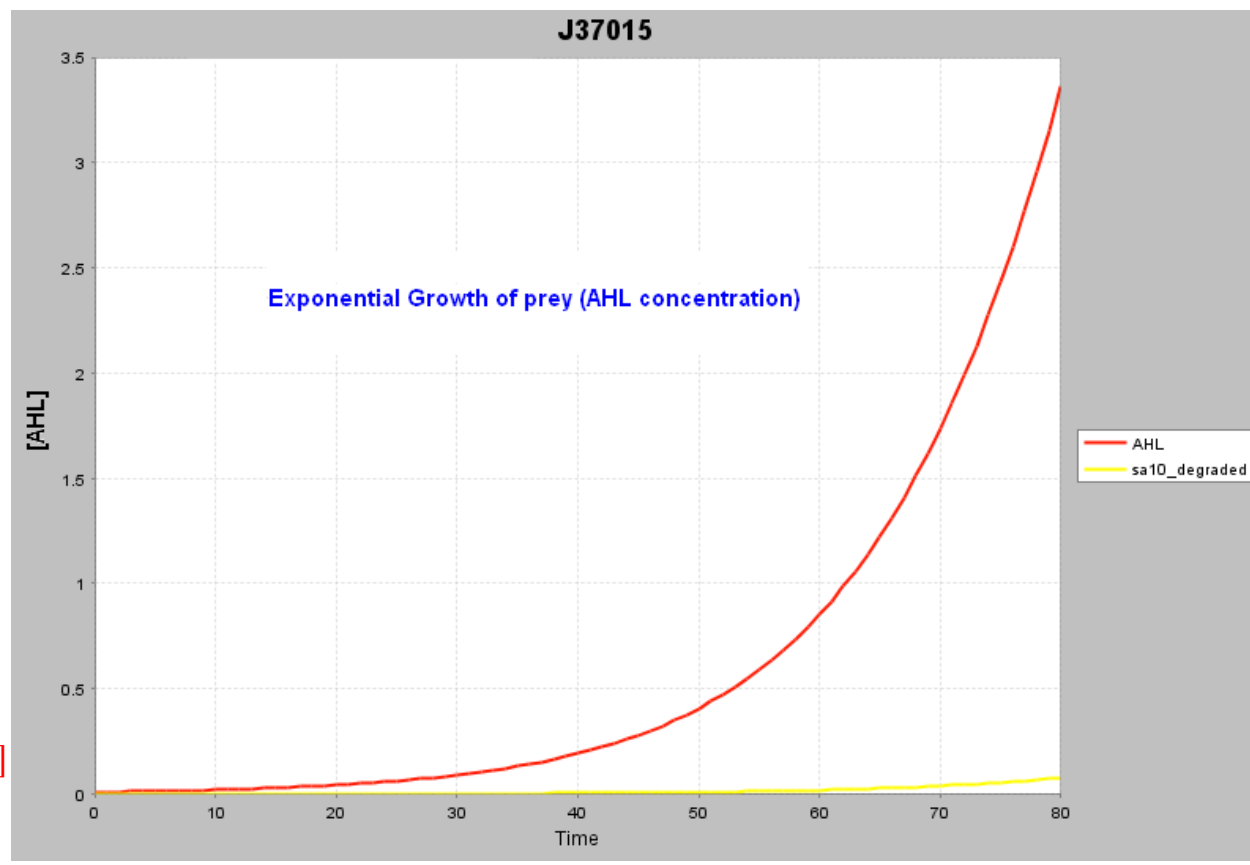

Fig.2b: Output from the model in Fig.2a

- Known or measurable parameters:**
- [AHL], AHL degradation
- Parameters to extract from model:**
- V_{\max} , $\frac{K_D}{\lambda K_{D\alpha}}$

Values used for graph:

$$V_{\max} = 1.245, \quad \frac{K_D}{K_{D\alpha}} = 15, \quad \lambda = 1, \quad \delta_1 = 0.0016 \text{ s}^{-1}$$

Extracting parameters: J37015

AHL is measured during exponential growth (not at steady state).

The following ODE thus needs to be solved:

$$\frac{d[\text{AHL}]}{dt} = \frac{V_{\max} [\text{AHL}]}{K_D / \lambda K_{D\alpha} + [\text{AHL}]} - \underbrace{\delta_{\text{AHL}} [\text{AHL}]}_{\text{Since } \delta_{\text{AHL}} \text{ is very small, this term can be neglected}}$$

$$\frac{d[\text{AHL}]}{dt} = \frac{V_{\max} [\text{AHL}]}{K_1 + [\text{AHL}]} \quad \text{where } K_1 \equiv K_D / \lambda K_{D\alpha}$$

$$\frac{d[\text{AHL}]}{[\text{AHL}]} (K_1 + [\text{AHL}]) = V_{\max} dt$$

$$\int d[\text{AHL}] + \int K_1 \frac{d[\text{AHL}]}{[\text{AHL}]} = \int V_{\max} dt$$

$$[\text{AHL}] + K_1 \ln[\text{AHL}] = V_{\max} t + c$$

Rearranging for a plot of t versus [AHL]:

$$t = \frac{1}{V_{\max}} ([\text{AHL}] + K_1 \ln[\text{AHL}] + c)$$

Modelling J37016

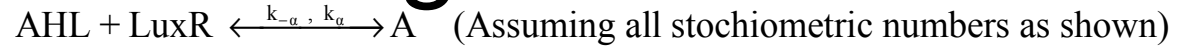

$$\frac{d[\text{A}]}{dt} = k_a[\text{AHL}][\text{LuxR}] - k_{-a}[\text{A}] = 0 \quad (\text{because of steady state})$$

$$\therefore \frac{[\text{AHL}][\text{LuxR}]}{[\text{A}]} = \frac{k_{-a}}{k_a} = \frac{1}{K_{D\alpha}} \quad \therefore (6) \quad [\text{A}] = K_{D\alpha}[\text{AHL}][\text{LuxR}]$$

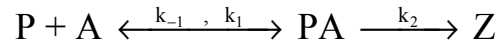

The rate of protein synthesis is described by:

$$\frac{d[\text{Z}]}{dt} = k_2[\text{PA}] = \frac{k_2[\text{P}_0][\text{A}]}{[\text{A}] + K_D} = \frac{V_{\max}[\text{A}]}{[\text{A}] + K_D} \quad \text{where } V_{\max} \equiv k_2[\text{P}_0]$$

(see Slide No. 2 for derivation)

The total change in protein concentration includes protein degradation:

$$\frac{d[\text{Z}]}{dt} = \frac{V_{\max}[\text{A}]}{[\text{A}] + K_D} - \delta_2[\text{Z}]$$

$$\text{Substituting Equation (6): } \frac{d[\text{Z}]}{dt} = \frac{V_{\max} K_{D\alpha}[\text{AHL}][\text{LuxR}]}{K_{D\alpha}[\text{AHL}][\text{LuxR}] + K_D} - \delta_2[\text{Z}]$$

There are two different products being transcribed: LuxR and GFP.

Considering both products after another, keeping in mind they are measured at steady state:

$$(7) \quad \frac{d[\text{LuxR}]}{dt} = \frac{V_{\max}[\text{AHL}][\text{LuxR}]}{[\text{AHL}][\text{LuxR}] + \frac{K_D}{K_{D\alpha}}} - \delta_{\text{LuxR}}[\text{LuxR}] = 0$$

$$(8) \quad \frac{d[\text{GFP}]}{dt} = \frac{V_{\max}[\text{AHL}][\text{LuxR}]}{[\text{AHL}][\text{LuxR}] + \frac{K_D}{K_{D\alpha}}} - \delta_{\text{GFP}}[\text{GFP}] = 0$$

$$\therefore (7) = (8) \Rightarrow \delta_{\text{LuxR}}[\text{LuxR}] = \delta_{\text{GFP}}[\text{GFP}] \Rightarrow [\text{LuxR}] = \frac{\delta_{\text{GFP}}}{\delta_{\text{LuxR}}} [\text{GFP}]$$

Key:

P: Promoter pLuxR

A: AHL/LuxR complex

PA: pLuxR/AHL/LuxR complex

Z: GFP and LuxR

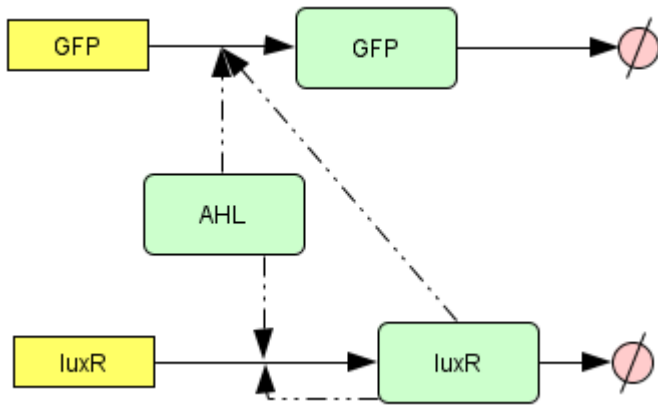

Fig.3a: Diagram for model
in cell designer

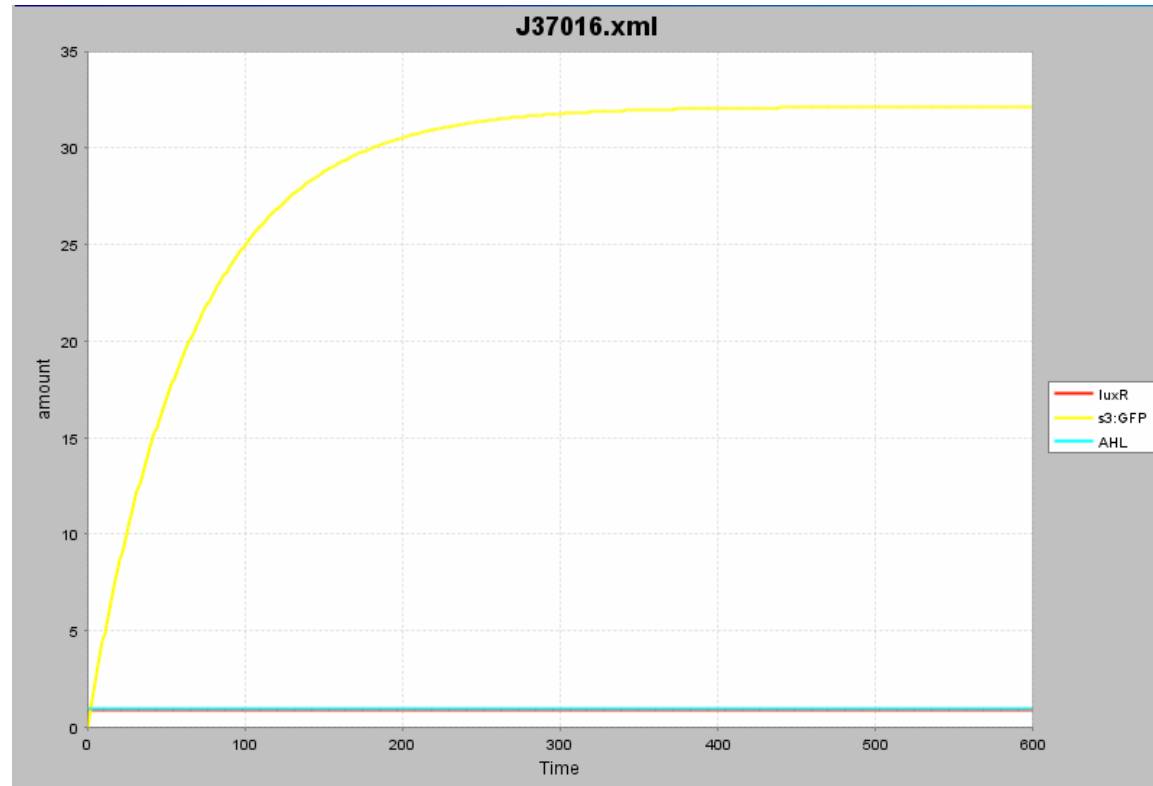

Fig.3b: Output from the model in Fig.3a

Input values used to generate above graph:

$$\delta_{\text{GFP}} = 0.015 \text{ min}^{-1}, \quad \frac{K_D}{K_{D\alpha}} = 1.0$$

$$V_{\text{max}} = 1.0, \quad [\text{AHL}] = 1.0, \quad [\text{LuxR}] = 0.93$$

Equation:

$$\frac{d[\text{GFP}]}{dt} = \frac{V_{\text{max}} [\text{AHL}] [\text{LuxR}]}{[\text{AHL}] [\text{LuxR}] + \frac{K_D}{K_{D\alpha}}} - \delta_{\text{GFP}} [\text{GFP}]$$

Known or measurable parameters:

- [AHL], GFP degradation

Parameters to extract from model:

- $V_{\text{max}}, \frac{K_D}{K_{D\alpha}}$

Extracting parameters: J37016

Measurements are taken after [GFP] has reached steady state ($\frac{d[\text{GFP}]}{dt}=0$):

$$\frac{d[\text{GFP}]}{dt} = \frac{V_{\max} [\text{AHL}][\text{LuxR}]}{K_2 + [\text{AHL}][\text{LuxR}]} - \delta_{\text{GFP}} [\text{GFP}] = 0 \quad \text{where } K_2 \equiv \frac{K_D}{K_{\delta\alpha}} \quad \text{and } [\text{LuxR}] = \frac{\delta_{\text{GFP}}}{\text{LuxR}} [\text{GFP}]$$

$$\therefore \delta_{\text{GFP}} [\text{GFP}] = \frac{V_{\max} [\text{AHL}][\text{LuxR}]}{K_2 + [\text{AHL}][\text{LuxR}]}$$

Lineweaver-Burk: $\frac{1}{\delta_{\text{GFP}} [\text{GFP}]} = \frac{K_2 + [\text{AHL}][\text{LuxR}]}{V_{\max} [\text{AHL}][\text{LuxR}]} = \frac{K_2}{V_{\max} [\text{AHL}][\text{LuxR}]} + \frac{1}{V_{\max} [\text{AHL}][\text{LuxR}]}$ (Plot of $\frac{1}{\delta_{\text{GFP}} [\text{GFP}]}$ versus $\frac{1}{[\text{AHL}]}$)

Eadie-Hofstee: $\delta_{\text{GFP}} [\text{GFP}](K_2 + [\text{AHL}][\text{LuxR}]) = V_{\max} [\text{AHL}][\text{LuxR}]$

$$\delta_{\text{GFP}} [\text{GFP}][\text{AHL}][\text{LuxR}] = -\delta_{\text{GFP}} [\text{GFP}]K_2 + V_{\max} [\text{AHL}][\text{LuxR}]$$

$$\delta_{\text{GFP}} [\text{GFP}] = -\delta_{\text{GFP}} K_2 \frac{[\text{GFP}]}{[\text{AHL}][\text{LuxR}]} + V_{\max} \quad \text{(Plot of } \delta_{\text{GFP}} [\text{GFP}] \text{ versus } \frac{[\text{GFP}]}{[\text{AHL}][\text{LuxR}]})$$

Modelling J37022 (AHL)

Key:

E: Enzyme AHL-lactonase

S: AHL

ES: aiiA/AHL complex

Z: Acyl-HS

True Michaelis-Menten :

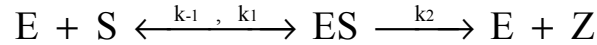

$$\frac{d[ES]}{dt} = k_1[E][S] - k_{-1}[ES] - k_2[ES] = 0$$

$$(9) \quad [ES] = \frac{k_1[E][S]}{k_{-1} + k_2} = \frac{[E][S]}{K_m} \quad \text{where } K_m \equiv \frac{k_{-1} + k_2}{k_1}$$

As the total concentration of enzyme is constant:

$$[E_0] = [E] + [ES] \quad \therefore [E] = [E_0] - [ES]$$

Substituting into (1):

$$[ES] = \frac{[E][S]}{K_m} = \frac{([E_0] - [ES])[S]}{K_m} \quad \therefore [ES] = \frac{[S][E_0]}{K_m + [S]}$$

The rate of degradation of substrate (activity of enzyme)

is described by:

$$-\frac{d[S]}{dt} = k_2[ES] = \frac{k_2[E_0][S]}{K_m + [S]} = \frac{V_{\max}[S]}{K_m + [S]} \quad \text{where } V_{\max} \equiv k_2[E_0]$$

The total rate of degradation of AHL (activity of aiiA) is described by:

$$(10) \quad \frac{d[AHL]}{dt} = -\frac{V_{\max}[AHL]}{K_m + [AHL]} - \delta_{AHL}[AHL] = -\frac{k_2[E_0][AHL]}{K_m + [AHL]} - \delta_{AHL}[AHL]$$

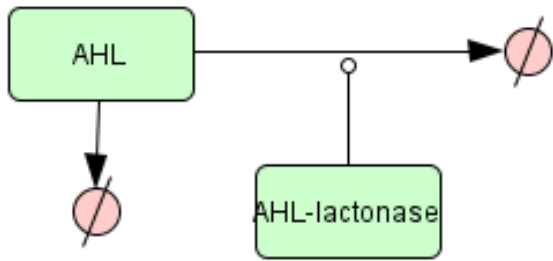

Fig.4a: Diagram for model in cell designer

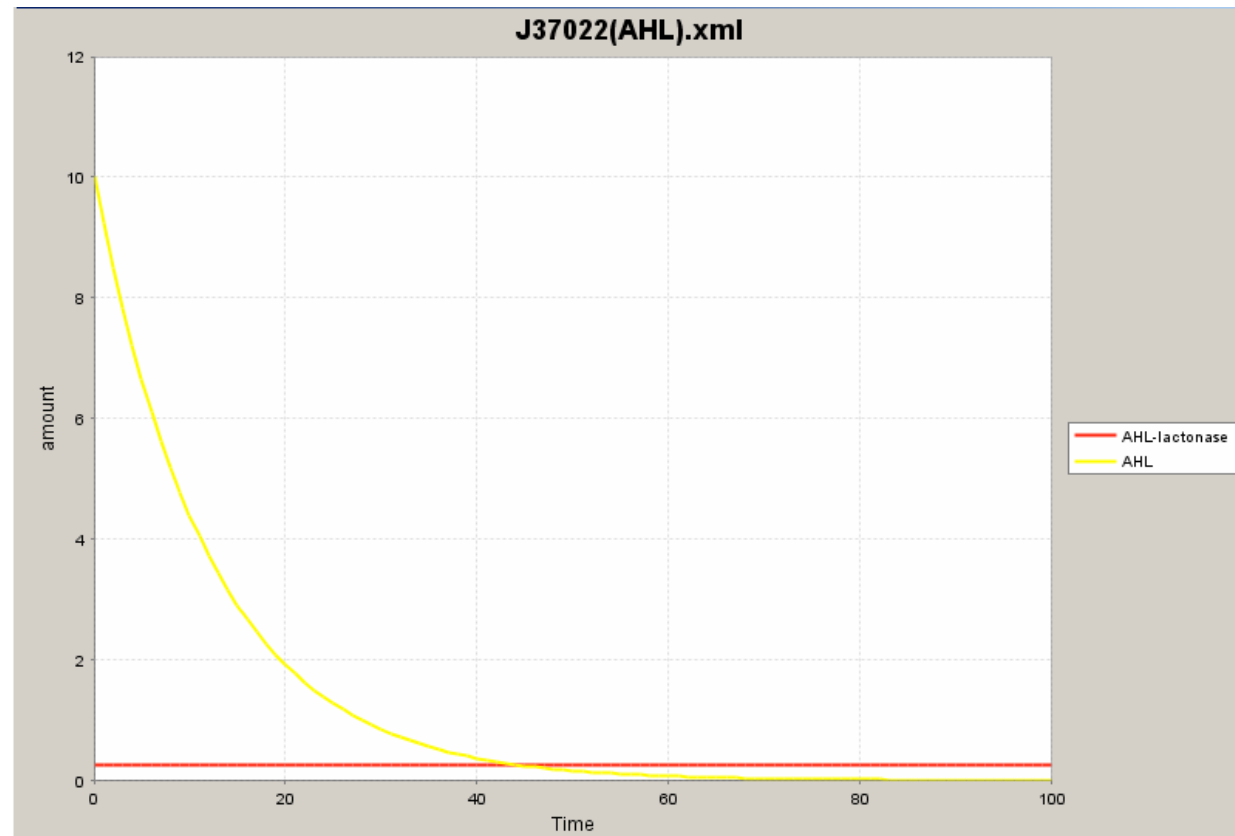

Fig.4b: Output from the model in Fig.4a

Equation:

$$\frac{d[\text{AHL}]}{dt} = -\frac{k_2[E_0][\text{AHL}]}{K_m + [\text{AHL}]} - \delta_{\text{AHL}}[\text{AHL}]$$

Input values used to generate above graph:

$$\delta_{\text{AHL}} = 0.00048 \quad , \quad K_m = 331.95$$

$$V_{\text{max}} = 1.0 \quad , \quad [\text{AHL}] = 1.0$$

$$k_2 = 1000.0 \quad , \quad E_0 = 1.0$$

Known or measurable parameters:

- IPTG, aiiA degradation

Parameters to extract from model:

- V_{max} , K_D

Extracting parameters: J37022(AHL)

Measurements are taken after [AHL] has reached steady state ($\frac{d[\text{AHL}]}{dt}=0$):

$$\frac{d[\text{AHL}]}{dt} = -\frac{k_2[\text{E}_0][\text{AHL}]}{K_m + [\text{AHL}]} - \delta_{\text{AHL}}[\text{AHL}] = 0$$

$$\therefore \delta_{\text{AHL}}[\text{AHL}] = -\frac{k_2[\text{E}_0][\text{AHL}]}{K_m + [\text{AHL}]}$$

$$\text{Lineweaver-Burk: } \frac{1}{\delta_{\text{AHL}}[\text{AHL}]} = -\frac{K_m + [\text{AHL}]}{k_2[\text{E}_0][\text{AHL}]} = -\frac{K_m}{k_2[\text{E}_0]} \frac{1}{[\text{AHL}]} - \frac{1}{k_2[\text{E}_0]} \quad (\text{Plot of } \frac{1}{\delta_{\text{AHL}}[\text{AHL}]} \text{ versus } \frac{1}{[\text{AHL}]})$$

$$\text{Eadie-Hofstee: } \delta_{\text{AHL}}[\text{AHL}](K_m + [\text{AHL}]) = -k_2[\text{E}_0][\text{AHL}]$$

$$\delta_{\text{AHL}}[\text{AHL}]^2 = -\delta_{\text{AHL}}[\text{AHL}]K_m - k_2[\text{E}_0][\text{AHL}]$$

$$\delta_{\text{AHL}}[\text{AHL}] = -\delta_{\text{AHL}}K_m - k_2[\text{E}_0] \quad (\text{Plot of } \delta_{\text{AHL}}[\text{AHL}] \text{ versus ?})$$

Modelling J37022 (aiiA)

Key:

P: Promoter *Lacl*

A: IPTG

PA: *Lacl*/IPTG complex

Z: *aiiA*

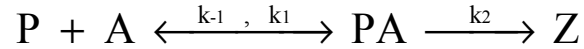

The rate of protein synthesis is described by:

$$\frac{d[Z]}{dt} = k_2[PA] = \frac{k_2[P_0][A]}{[A] + K_D} = \frac{V_{\max}[A]}{[A] + K_D} \quad \text{where } V_{\max} \equiv k_2[P_0]$$

(see Slide No. 2 for derivation)

The total change in protein concentration includes protein degradation:

$$\frac{d[Z]}{dt} = \frac{V_{\max}[A]}{[A] + K_D} - \delta_{aiiA}[Z]$$

$$(11) \quad \frac{d[aiiA]}{dt} = \frac{V_{\max}[IPTG]}{[IPTG] + K_D} - \delta_{aiiA}[aiiA]$$

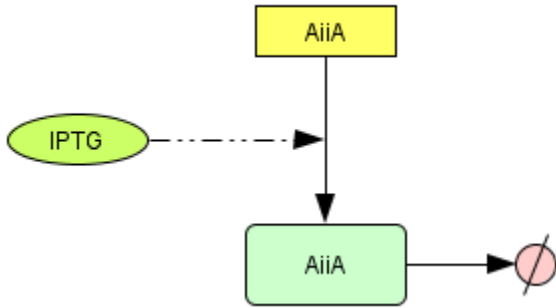

Fig.5a: Diagram for model in cell designer

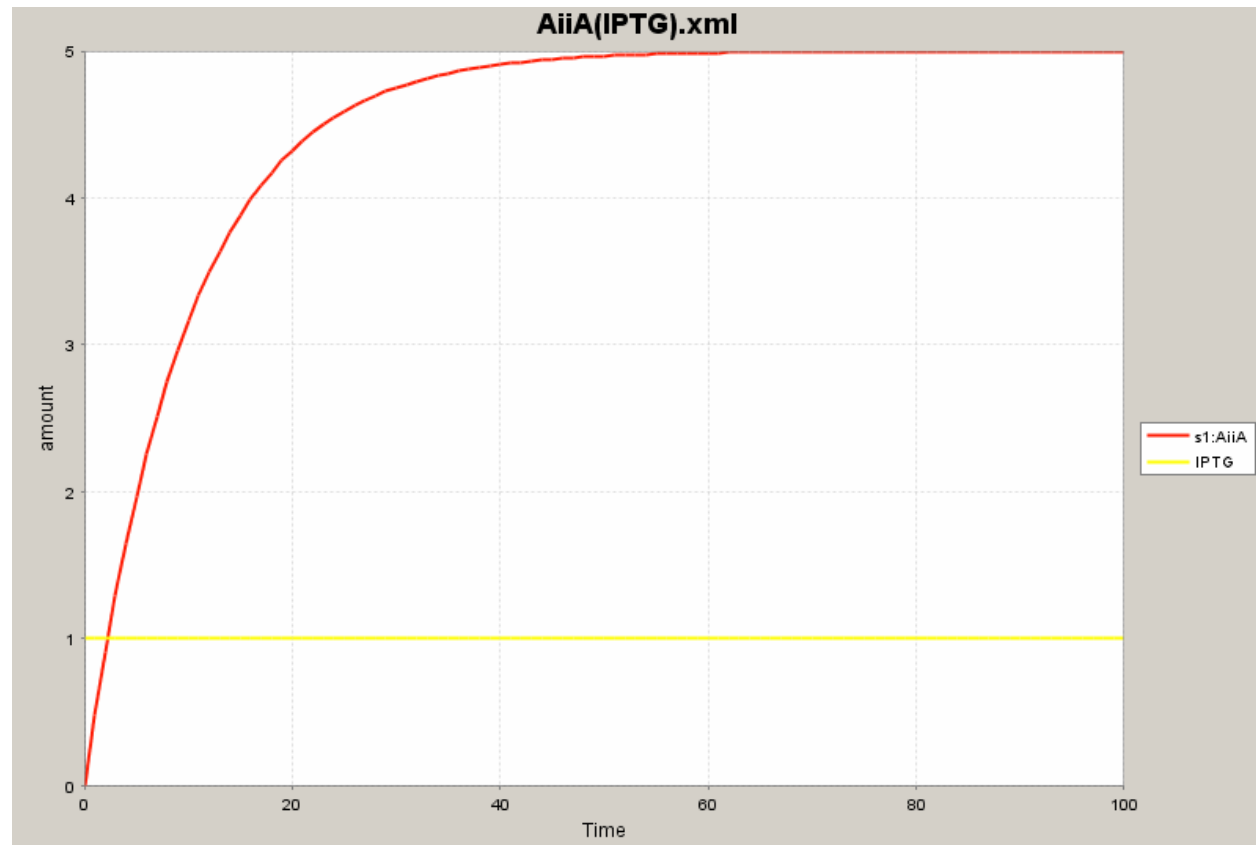

Fig.5b: Output from the model in Fig.5a

Equation:

$$\frac{d[\text{aiaA}]}{dt} = \frac{V_{\max} [\text{IPTG}]}{[\text{IPTG}] + K_D} - \delta_{\text{aiaA}} [\text{aiaA}]$$

Known or measurable parameters:

- IPTG, aiaA degradation

Parameters to extract from model:

- V_{\max} , K_D

Input values used to generate above graph:

$$\delta_{\text{AiiA}} = 0.1 \quad (\text{real value to be found})$$

$$K_D = 1.0 \quad (\text{real value to be found})$$

$$V_{\max} = 1.0 \quad (\text{real value to be found})$$

$$[\text{IPTG}] = 1.0$$

Extracting parameters: J37022(aiiA)

Measurements are taken after [aiiA] has reached steady state ($\frac{d[\text{AHL}]}{dt} = 0$):

$$\frac{d[\text{aiiA}]}{dt} = \frac{V_{\max} [\text{IPTG}]}{K_D + [\text{IPTG}]} - \delta_{\text{aiiA}} [\text{aiiA}] = 0$$

$$\therefore \delta_{\text{aiiA}} [\text{aiiA}] = \frac{V_{\max} [\text{IPTG}]}{K_D + [\text{IPTG}]}$$

Lineweaver-Burk: $\frac{1}{\delta_{\text{aiiA}} [\text{aiiA}]} = \frac{K_D + [\text{IPTG}]}{V_{\max} [\text{IPTG}]} = \frac{K_D}{V_{\max}} \frac{1}{[\text{IPTG}]} + \frac{1}{V_{\max}}$ (Plot of $\frac{1}{\delta_{\text{aiiA}} [\text{aiiA}]}$ versus $\frac{1}{[\text{IPTG}]}$)

Eadie-Hofstee: $\delta_{\text{aiiA}} [\text{aiiA}] (K_D + [\text{IPTG}]) = V_{\max} [\text{IPTG}]$

$$\delta_{\text{aiiA}} [\text{aiiA}] [\text{IPTG}] = \delta_{\text{aiiA}} [\text{aiiA}] K_D + V_{\max} [\text{IPTG}]$$

$$\delta_{\text{aiiA}} [\text{aiiA}] = -\delta_{\text{aiiA}} K_D \frac{[\text{aiiA}]}{[\text{IPTG}]} + V_{\max}$$
 (Plot of $\delta_{\text{aiiA}} [\text{aiiA}]$ versus $\frac{[\text{aiiA}]}{[\text{IPTG}]}$)

Modelling the Overall System

Assumptions:

AHL is diffusing freely throughout the system

Three resulting equations describing the Overall System:

(from the previously derived equations 5, 7, 8, 10, 11)

$$\begin{aligned}
 \frac{d[\text{AHL}]}{dt} &= \frac{\overset{\substack{\text{Production of} \\ \text{AHL}}}{V_{\max}} [\text{AHL}]}{[\text{AHL}] + \frac{K_D}{\lambda K_{D\alpha}}} - \frac{\overset{\substack{\text{Degradation of AHL} \\ \text{by enzyme}}}{k_2} [\text{aiiA}][\text{AHL}]}{K_m + [\text{AHL}]} - \overset{\substack{\text{"Natural" degradation} \\ \text{of AHL}}}{\delta_{\text{AHL}}} [\text{AHL}] \\
 \frac{d[\text{aiiA}]}{dt} &= \frac{V_{\max} [\text{AHL}][\text{LuxR}]}{[\text{AHL}][\text{LuxR}] + \frac{K_D}{K_{D\alpha}}} - \delta_{\text{aiiA}} [\text{aiiA}] \\
 \frac{d[\text{LuxR}]}{dt} &= \frac{V_{\max} [\text{AHL}][\text{LuxR}]}{[\text{AHL}][\text{LuxR}] + \frac{K_D}{K_{D\alpha}}} - \delta_{2\text{LuxR}} [\text{LuxR}]
 \end{aligned}$$

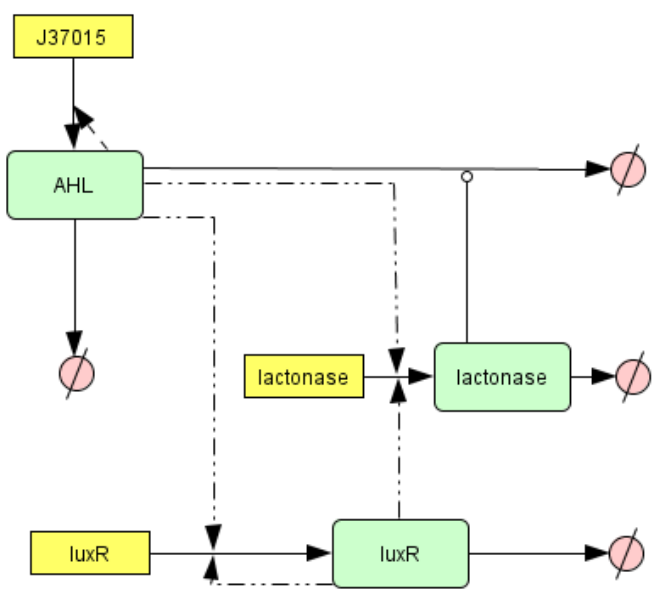

Fig.6a: Diagram for model
in cell designer

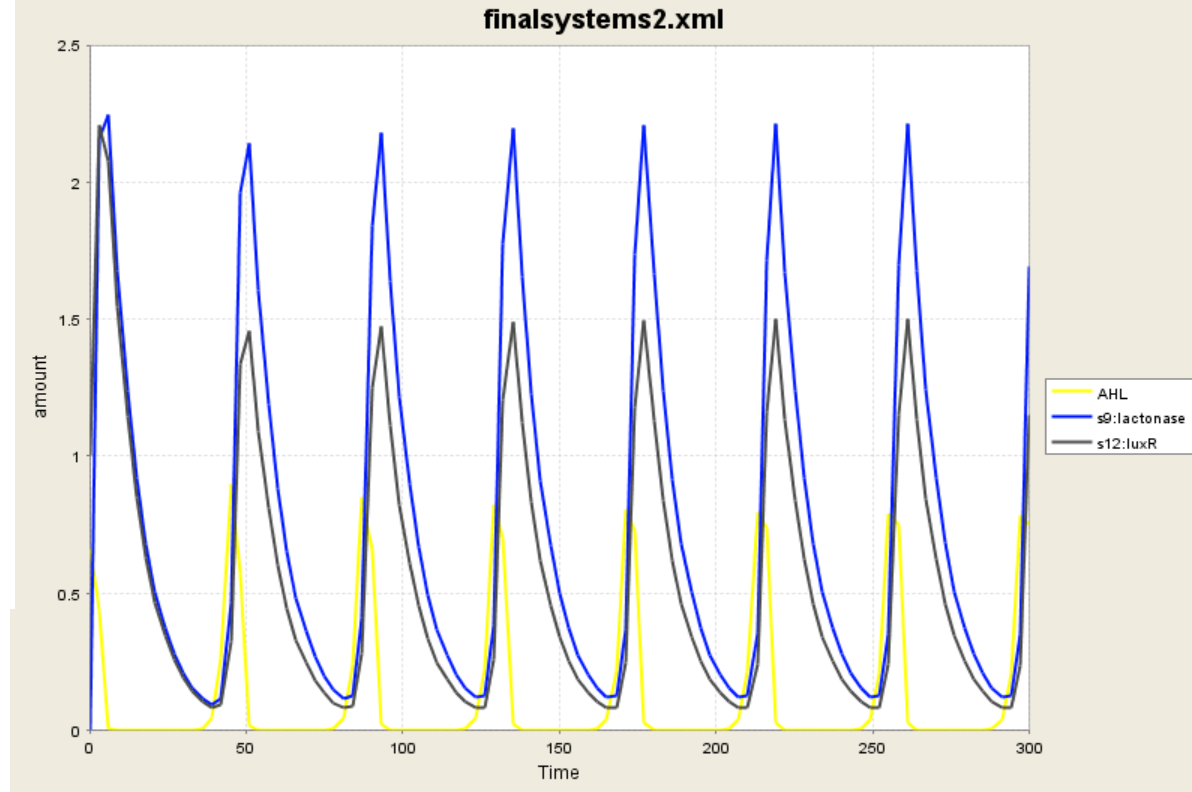

Fig.6b: Output from the model in Fig.6a:
We are getting oscillations !!!

- To gain some qualitative insight we will initially work under the rapid equilibrium approximation. This approximation assumes that that the timescale of protein-protein and protein-DNA interactions are significantly faster than the other chemical reactions and thus we can consider these protein reactions to be at equilibrium