

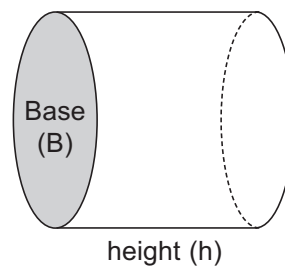

Formula for the Volume of a Cylinder

The formula for finding the volume of a cylinder is $V = Bh$. This is the same formula we use to find the volume of a triangular prism. The capital B in the formula represents the area of the base. For a cylinder, the base is a circle rather than a triangle. The height may be vertical or horizontal, but it is always the distance between the two circular bases.

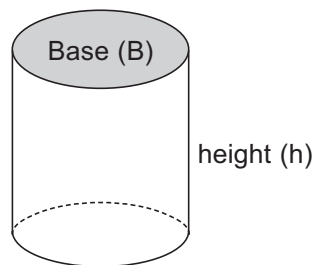

You know the formula for finding the area of a circle is $A = \pi r^2$. Put πr^2 in place of B in the formula. Substitute the correct number for each variable in the formula and solve the equation. Study the example.

A storage tank for petroleum has a circular base with a radius of 5 m. The tank is 8 m high. What is the volume of the tank?

$$V = Bh$$

$$V = (\pi r^2)h$$

$$V = (3.14 \times 5 \times 5) \times 8$$

$$V = 78.5 \times 8$$

$$V = 628$$

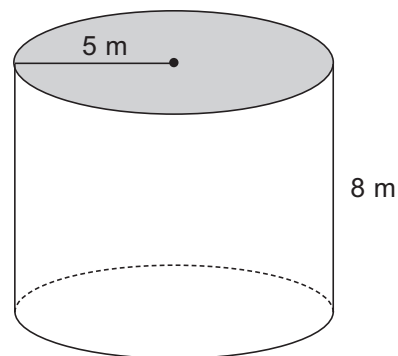

Remember that volume is given in cubic units. The volume of the storage tank is 628 cubic meters, or 628 m^3 .

Lesson 8

Find the volume of each cylinder.

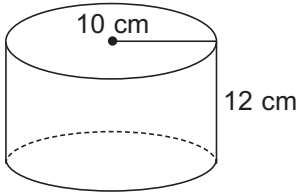

1. a. _____

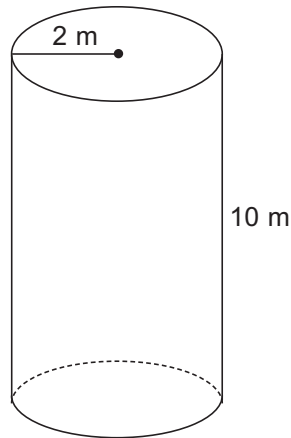

b. _____



We Remember

Write the products.

2. a. $5^3 =$ _____

b. $9^2 =$ _____

c. $2^6 =$ _____

d. $3^3 =$ _____

3. a. $2^5 =$ _____

b. $2^3 =$ _____

c. $2^4 =$ _____

d. $7^2 =$ _____

List the prime factors, using exponents whenever you can.

4. $96 =$ _____

5. $372 =$ _____

6. $105 =$ _____

Write these numbers with digits.

7. 9.2 million = _____

8. 7 trillion = _____

9. 2.41 billion = _____

10. 250 trillion = _____

Mastery Drill

11. A reflex angle measures between _____° and _____°.
12. a. 1 mile \approx _____ kilometers b. 1 kilometer \approx _____ mile
13. a. The *congruent* symbol is _____ . b. The *similar* symbol is _____ .
14. a. The repeating decimal for $\frac{2}{3}$ is _____ . b. The repeating decimal for $\frac{5}{6}$ is _____ .
15. a. The decimal for $\frac{3}{8}$ is _____ . b. The decimal for $\frac{7}{8}$ is _____ .
16. a. The decimal for $\frac{1}{8}$ is _____ . b. The decimal for $\frac{5}{8}$ is _____ .
17. a. *Milli* means _____ . b. *Kilo* means _____ . c. *Centi* means _____ .

Use the perimeter or area formula to find the missing dimension of each figure.

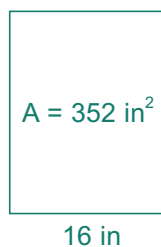
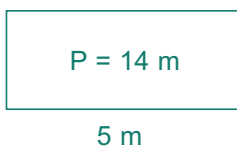

18. a. The width is _____ . b. The length is _____ .

Solve.

19. a. 5 gal = _____ qt b. 9 cups = _____ fluid ounces

Use the formula to find the volume of the triangular prism.

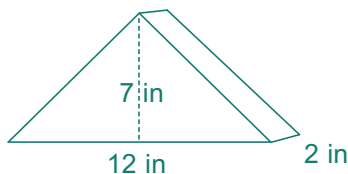

20. _____

Write the equivalent fractions in simplest form.

21. a. 0.2 = _____ b. 0.4 = _____ c. 0.3 = _____ d. 0.6 = _____

Lesson 8



- 22.** A year ago when Grandma moved in with the Ulrichs, Marlene gave up her bedroom and moved into a smaller room that had been a sewing room. The room is $11\frac{1}{2}$ feet wide, 13 feet long, and 8 feet high. It has one door that is 3 feet wide and 7 feet high, and a window that is $2\frac{1}{2}$ feet wide and 4 feet high. Sally and Marlene are planning to repaint the ceiling and walls.

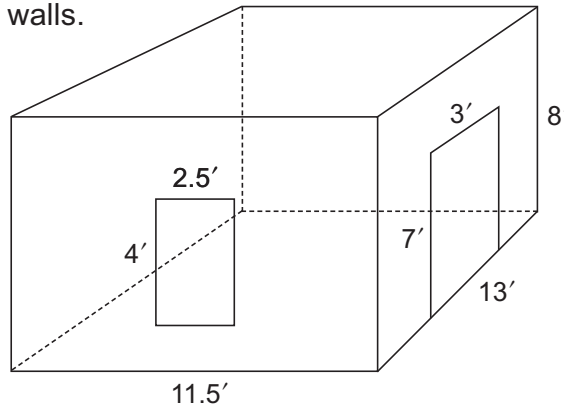

- a. How many square feet of wall space does the room have, not counting the door and window? _____
- b. How many square feet of ceiling does the room have?

Write as complex fractions.

23. a. $\frac{5}{9} \div \frac{3}{5} =$ _____

b. $3\frac{1}{3} \div 6\frac{3}{4} =$ _____

c. $4\frac{7}{8} \div 5 =$ _____

Find the sale price.

24. The regular price was \$25.45. The sale is 12% off.
The sale price is _____.

Simplify the expressions

25. a. $21 - (\frac{16}{4} + 5)2$

b. $3x + 6 - 2x - 4$

c. $(9x)4$

d. $7^3 =$ _____

— \div \times Skill Builders —

26. a.
$$\begin{array}{r} 23,462 \\ - 8,571 \\ \hline \end{array}$$

b.
$$\begin{array}{r} 40.52 \\ \times 36.7 \\ \hline \end{array}$$



c.
$$6.99 \overline{)136.305}$$

Solve.

27. What is 35% of 60? _____

28. 54 is 60% of what number? _____

29. 72 is what percent of 96? _____

Solve and check.

30. a. $9 + \frac{y}{8} = 19$

b.

c. $\frac{x}{7} + 5 = 6$

d.



Use the formula to find the volume of the cylinder.

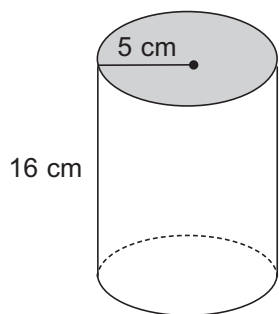

31. _____

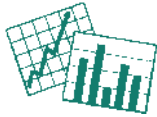

Graphs and Statistics

Building Line Graphs

Line graphs show change in a particular value. They use the same basic format as vertical bar graphs. The number scale for a line graph must go up the left-hand side of the graph. The number scale for a line graph, unlike a bar graph, doesn't need to start at zero, since a line graph pictures the amount of change over time, rather than comparing different totals.

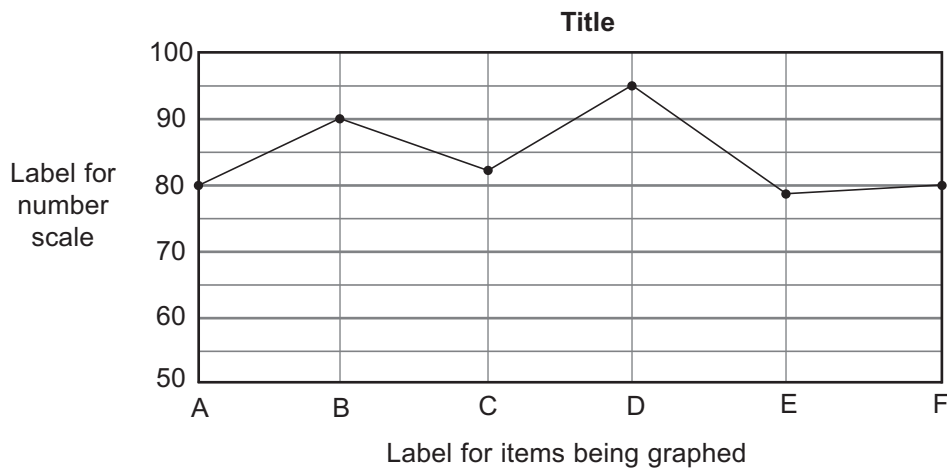

When plotting the points for the line, if a given value falls between two lines, estimate the correct position of the point as closely as possible. In the graph above, item C is about 84.

Depending on the data being graphed, the line may be straight, curved, or broken. The graph shown above is a broken-line graph. Two more line graphs are pictured below.

Curved Line Graph

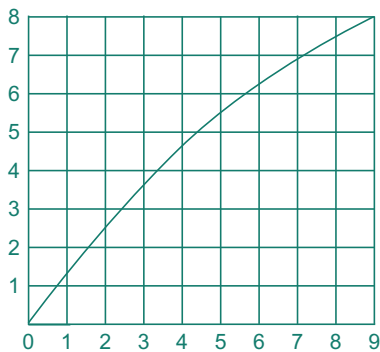

Straight Line Graph

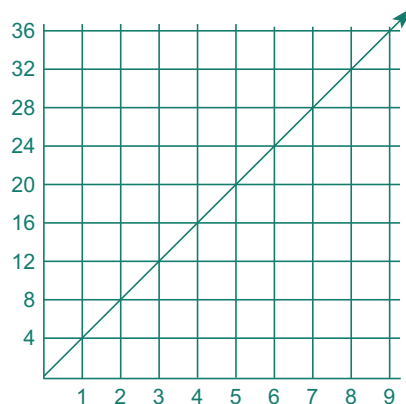

Using the model on page 38, complete the line graph of the information given.

Mabel is diabetic. Marlene helps her take her blood sugar count twice daily and records the readings. The readings for last week are shown on the table.

Day and Time	Reading
Sun. morning	90
Sun. evening	125
Mon. morning	100
Mon. evening	95
Tue. morning	90
Tue. evening	130
Wed. morning	95
Wed. evening	85
Thu. morning	95
Thu. evening	95
Fri. morning	100
Fri. evening	80
Sat. morning	85
Sat. evening	95

△ 1.

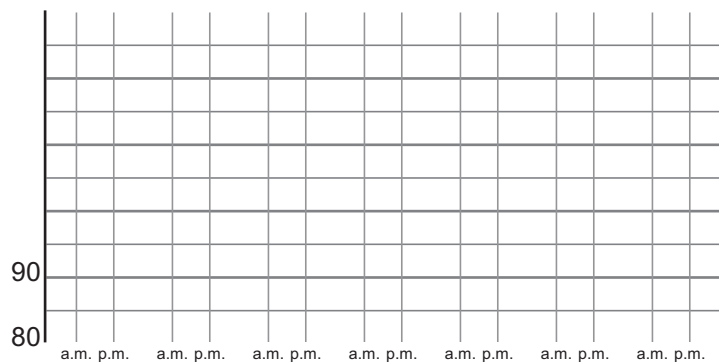

Answer the questions about the graph.

2. On which day and time was Grandma's blood sugar count the highest? _____



3. Give the average blood sugar reading to the nearest whole number. _____



We Remember

A healthy body produces enough insulin to break down the sugars (energy) in our food to supply our blood and tissues. The body of a diabetic person cannot use these sugars efficiently. Diabetes is treated with insulin, proper diet, and weight control. Blood sugar levels must be monitored carefully.

Use the formula to find the volume of the cylinder.

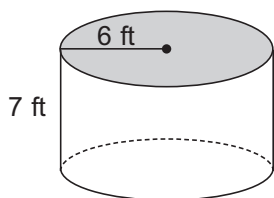

4. _____

Find the total cost.

5. \$4.95 with 6% sales tax = _____

Lesson 9

÷ × Skill Builders

Write the remainder with *R*.

6. a. $287 \overline{)84,750}$

b. $= \frac{1}{5} \frac{6}{9}$

c. $62 \frac{3}{16} + 71 \frac{7}{16}$

Solve each inequality. Graph the solutions.

7. a. $x - 9 \leq 3$

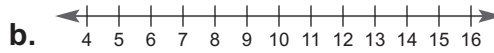

8. a. $x + 3 < 9$

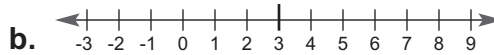

Use a compass and a straightedge to copy the angle.

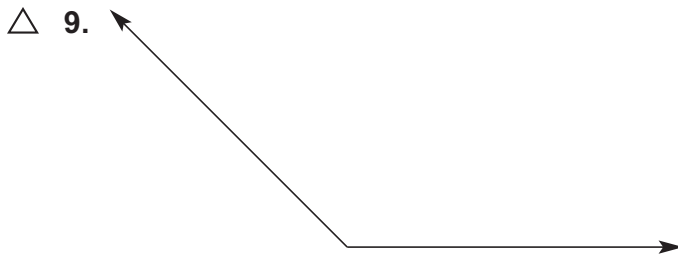

Rewrite the large numbers using digits and words. Use decimal points if needed.

10. If a cubit was 1.5 feet, the ark had a volume of over 1,500,000 cubic feet.

11. If a furlong was 606 feet, the New Jerusalem in Revelation 21 will have a volume of over 2,600,000,000 cubic miles. _____

12. If a furlong was 185 meters, the volume of the New Jerusalem will be over 10,940,000,000 cubic meters. _____

Mastery Drill

13. The *less than or equal to* symbol is _____.
14. The *greater than or equal to* symbol is _____.
15. A reflex angle measures between _____° and _____°.
16. The formula for finding the volume of a cylinder is _____.
17. The formula for finding the volume of a triangular prism is _____.
18. In the formula $V = Bh$, the capital B stands for the _____ of the _____.
19. a. 1 gallon \approx _____ liters b. The decimal for $\frac{3}{4}$ is _____.
20. a. The fraction for $0.\overline{6}$ is _____. b. The fraction for $0.8\overline{3}$ is _____.
21. a. $\frac{7}{8} =$ _____% b. $\frac{1}{8} =$ _____% c. $\frac{3}{8} =$ _____% d. $\frac{5}{8} =$ _____%

Solve for the unknown angle measure.

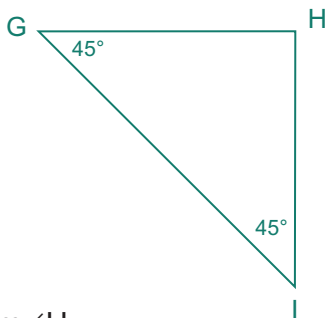

22. $m\angle H =$ _____

Convert. Round to the nearest whole.

23. 80 km \approx _____ miles
24. 90 miles \approx _____ km
25. 30 gal \approx _____ L
26. 53 L \approx _____ gal

Write an expression using an exponent.

27. a. $2 \cdot 2 \cdot 2 \cdot 2 \cdot 2 \cdot 2 \cdot 2 \cdot 2 \cdot 2 \cdot 2$ _____ b. Base 4, Exponent 6 _____

Lesson 9



28. Richard donated three 24-inch bicycles to Sunnyburn Children's Home: a ten-speed that he purchased for \$5 and replaced the seat for \$16.99, a twelve-speed that he bought for \$10 and replaced an inner tube for \$3.99, and a three-speed with a basket that he got for \$5 and replaced both tires at \$8.45 each and both inner tubes at \$3.99 each. How much money did Richard have invested in the three bicycles? _____

Find the commission.

29. A salesperson receives 15% commission on sales of \$7,492.63. _____

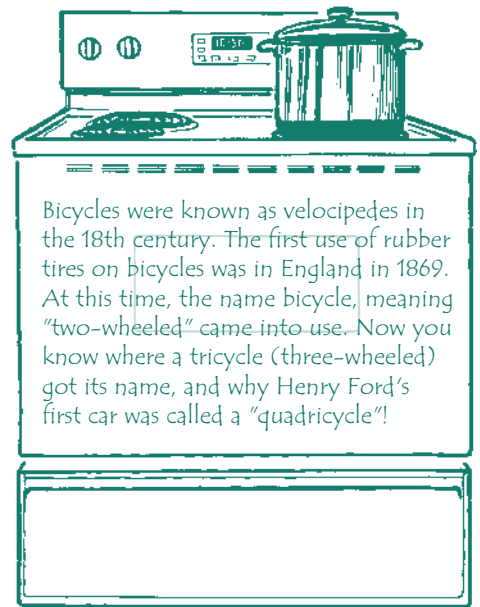

Simplify, solve, and check.

30. a. $8n + 13 = 5 + 6 \times 4$



b.

Answer questions about the graph on page 39.

31. On which day and time was Grandma's blood sugar count the lowest? _____
32. On which day did the blood sugar readings remain steady? _____