

INSTALLATION AND OPERATING MANUAL

WARNING

Please read carefully before proceeding with installation. Failure to follow any attached instructions or operating parameter may lead to the product's failure and possible damage to property.

NAVIGATING THE INTERACTIVE MANUAL

Any text in the document that is BLUE is a link. Clicking on the link will take you to the appropriate page.

Clicking on the rewind symbol will take you back to the Table Of Contents.



Rewind Symbol

You can use the arrow keys on your keyboard to scroll through the document pages.

**COPYRIGHT 2020© BY SPECTRAPURE INC
ALL RIGHTS RESERVED**

No part of this publication may be reproduced, stored in a retrieval system, or transmitted in any form or by any means, electronic, mechanical, photocopying, recording or otherwise without the prior written permission of SpectraPure Inc.

SpectraPure®

TABLE OF CONTENTS:

Thank You for your purchase of the SpectraPure® LiterMeter 4. With proper installation and maintenance, this system will provide you with high quality performance for years to come. All SpectraPure® products are rigorously tested by us for safety and reliability. If you have any questions or concerns, please contact our customer service department via e-mail at support@spectrapure.com.

Introduction	4-5
Pairing The LM4 With Your Smart Phone Or Personal Device	6-7
Configuration Examples	
Top-Off System For Multiple Tanks	8-9
A-B Dosing System	10-11
Water Exchange System	12-13
ATO + Water Exchange + Kalkwasser System	14-15
Using A Personal Device To Set Up LM4	
Settings Page On A Personal Device	16-19
Calibrate Page On A Personal Device	20
Inputs Page On A Personal Device	21
System Page On A Personal Device	22-23
Setting Up LM4 Using Screen and Navigation Buttons	
LiterMeter 4 Basic Operation	24
Navigating The LM4	24
Settings Page On The LM4	25-27
Calibrate Page On The LM4	28-29
Inputs Page On The LM4	30-31
External Remote Level Sensors	31
System Page On The LM4	32
Normal ReStart Sequence: (w/ Valid WiFi Creds)	33-34
Restart And Configuration Functions	35
Toggle the Use/No Use of a Router	36
Toggle Master/Remote Mode	37
Clear and Restore to Factory Settings	38
Clear WiFi Parameters	38
Quick Start: Pairing the LM4 with Your Phone	39-40
Using Remote Mode	41-42
Troubleshooting, Tips & Tricks	43
One Year Limited Warranty	44
Terms And Conditions	44

SpectraPure®

Introduction:

The LiterMeter 4 is a programmable pump controller that controls up to four dosing pumps (12VDC), individually and simultaneously. Ideally, the pumps will be SpectraPure's Peristaltic Dosing Pumps, but any small 12VDC pump can be used. A 12VDC/1A power supply is included and is able to power all four SpectraPure pumps at once.

The LiterMeter 4 (**LM4**) may be laid flat on a shelf, set on its back, or Velcroed to a wall or under a shelf. It can be orientated with the wires at the top or at the bottom of the unit. When the orientation of the LM4 changes and after a button is pressed, the display will flip so that it is readable, and the 5 buttons operate in the new orientation.

Functions are grouped in pages as "Settings", "Calibrate", "System", and "Inputs". All parameters are updated and saved as soon as a button is pressed. There is no need for an extra "do it" or "save it now" button.

A personal device (**PD**) such as a smartphone, tablet, PC or Mac may also be used to control the LM4.

◀◀ Settings:

Each pump can operate independently in one of several Modes: Off, On, Daily, Dose, Once, Timer, or Delay.

Calibrate:

Easy-to-Follow Calibration Procedure using included 100 ml. graduated cylinder.

System:

General settings including Inputs, Networks, and Calibrations.

SpectraPure®

Four Outputs for Pumps:

Each of four outputs (identified as A, B, C, and D) is connected to a separate pump. Each pump has full access to all pages, functions, and inputs. Pumps are connected to the LM4 with male-to-male 3-conductor cables. SpectraPure can provide cables of various lengths from 3 to 25 feet long. They are heavy-duty and shielded, and are recommended for proper operation.

Four Inputs for Level Sensors:

All four inputs (labeled as 1, 2, 3, and 4) can connect to a variety of float switches and water detectors (sensors). Any input can be “assigned” to control any or all pumps. Sensors are connected to the LM4 with male-to-male 3-conductor cables. SpectraPure can provide cables of various lengths from 3 to 25 feet long. They are heavy-duty and shielded, and are recommended for proper operation.



Wireless Connectivity:

The LM4 has wireless (WiFi–2.4Ghz) connectivity to allow changing parameters using a PD. After the LM4 connects to a router, it will use an IP address assigned by the router to send interactive pages to the PD. If a router is not available, a private network is available to provide PD-to-LM4 communication.

Firmware Updates:

Updated firmware (new features and bug fixes) can be downloaded from our website to your PD and then used to update the firmware in the LM4.

SpectraPure®

Pairing the LM4 With Your Smart Phone or Personal Device

Note: Components Needed for Pairing:

- Modem - Provides the Internet Connection
- Router - WiFi Transceiver (transmit/receive data packets)
- SpectraPure LM4 Liter Meter Pump Controller
- Personal Device: Desktop Computer, Laptop, Tablet or Smart Phone.

To allow for convenient local remote control of the LM4, and to capture real local time, it will be necessary to create a WiFi interface connection to a Personal Device (PD), which will provide programming and timing control for the LM4.

Each LM4 has its own unique 4 digit SSID number, which is used to identify the LM4 while pairing your personal device with and maintaining a local, router based, WiFi network connection.

When the LM4 is powered on, the first screen will display the firmware version and the network ID number unique to that LM4 (see example below) SSID = LM4-6680).



The Following Steps will Guide you through the Personal Device Pairing: Please note that the Pairing Window interval is 6 minutes. (Restart as needed.). Once powered on, the LM4 will transmit a unique onboard WiFi signal. Connecting your PD to this signal will allow you to identify and store your local router's network name and SSID as the connection bridge between your PD and the specific LM4 you have paired.

Pairing your personal device with your LM4:

First, power on the LM4 and note the unique SSID, displayed as ID: LM4-XXXX. (Ex: LM4-6680).

1. Next, open the WiFi Settings on your smart phone or other (personal device) PD.
2. Select the LM4-SSID from the displayed WiFi network list. This will connect your PD to the LM4's unique WiFi address. The next steps will enable the LM4 connection to your local router.
3. Now, open a web browser on your PD and type in the following URL (IP address) 192.168.4.1

SpectraPure®

4. The Configure WiFi page should display on your PD's screen (see Fig. 1 desktop computer).
5. Click on or tap the blue Configure WiFi button. This will bring up the list of local networks in your area.
6. From the WiFi network list, select your local router SSID (name) and enter your WiFi password. (as seen in Fig. 2 laptop)
7. Once you have selected your network and entered your password, click on or tap the blue Save button to record and Save your router's WiFi credentials into the LM4.
8. A confirmation screen will appear on your PD. (see Fig. 3). Important Note: The router will assign an IP address to the LM4.
9. In WiFi Settings, be sure the local router is now selected. Use the assigned IP address in your PD's browser to control the LM4 from your Personal Device. On the PD, you should now see a screen similar to Fig. 4. For more details on pairing the LM4, see "[Quick Start: Pairing the LM4 with Your Phone](#)".



FIG. 1



FIG. 2



FIG. 3

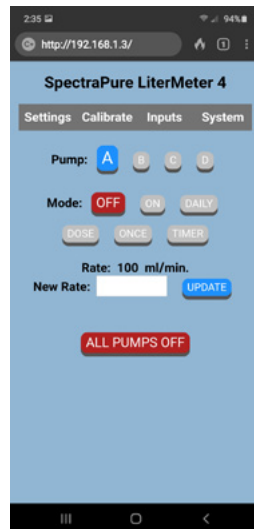

FIG. 4

Top-Off System for Multiple Tanks:

This is the basic Top-Off System, pulling water from a reservoir to replenish evaporation in an aquarium.

There is one pure water supply for two separate tanks (three are possible).

Each Pump is controlled by its own level sensor, plus a common Sensor monitors the pure water reservoir.

Parts List:

1x LM4 & Power Supply

1x Pump and 1x Sensor for each tank

1x Sensor for Reservoir

2x EXT Cables, Length as Required, for each tank

1x EXT Cable for Reservoir Sensor

Plumbing Connections:

Connect tubing from Pure Water to Pump "A".

Connect tubing from Pump "A" to Tank "A".

Connect tubing from Pure Water to Pump "B".

Connect tubing from Pump "B" to Tank "B".

Electrical Connections:

Connect one end of an EXT Cable (any length) to a [Level Sensor](#) (Tank "A") and the other end to Input "1".

Likewise,

Connect a Level Sensor (Pure Water) to Input "3".

Connect Pump to Pump "A".

Connect a Level Sensor (Tank "B") to Input "4".

Connect Pump to Pump "D".

Inputs Settings:

If Input#1(Tank "A") is WET, then "A" is OFF

If Input#3(Pure Water!) is DRY, then "A" & "D" are OFF

If Input#4(Tank "B") is WET, then "D" is OFF

EXT Cables are available in 3 ft, 6 ft, 12 ft, and 25 ft lengths.

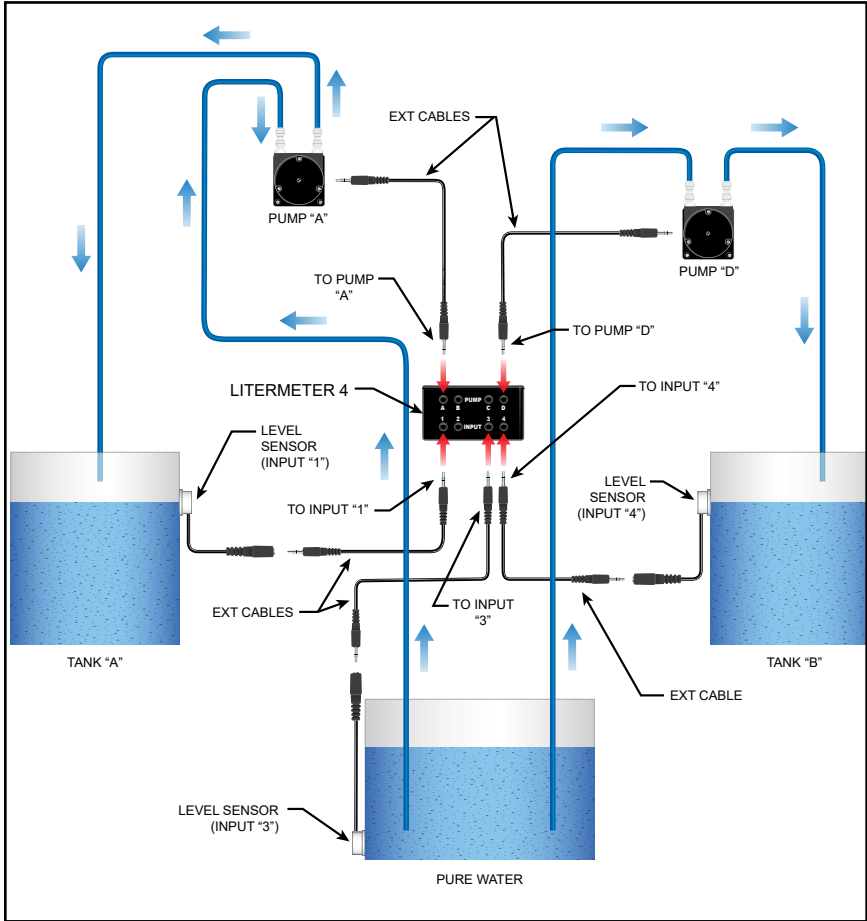

Top-Off System for Multiple Tanks

A–B Dosing System:

This is the basic Dosing System, pulling water from a nutrient reservoir to feed an aquarium.
Here there are two such systems (there could be four).
Each Pump is set to dose milliliters per day.
Low reservoir Sensors will shut BOTH pumps off when either reservoir runs dry.

Parts List:

1x LM4 & Power Supply
2x Pumps
2x Sensors
4x EXT Cables, Length as Required
4x Tubing, 1/4", Length as Required

Plumbing Connections:

Connect tubing from reservoir "A" to Pump "A".
Connect tubing from Pump "A" to sump.
Connect tubing from reservoir "B" to Pump "B".
Connect tubing from Pump "B" to sump.

Electrical Connections:

Connect one end of an EXT Cable (any length) to a [Level Sensor](#) (Res "A") and the other end to Input "1".
Likewise:
Connect a Level Sensor (Res "B") to Input "2".
Connect Pump to Pump "A".
Connect Pump to Pump "B".

Inputs Settings:

If Input#1(Reservoir "A") is DRY, then "A" & "B" are OFF
If Input#2(Reservoir "B") is DRY, then "A" & "B" are OFF

EXT Cables are available in 3 ft, 6 ft, 12 ft, and 25 ft lengths.

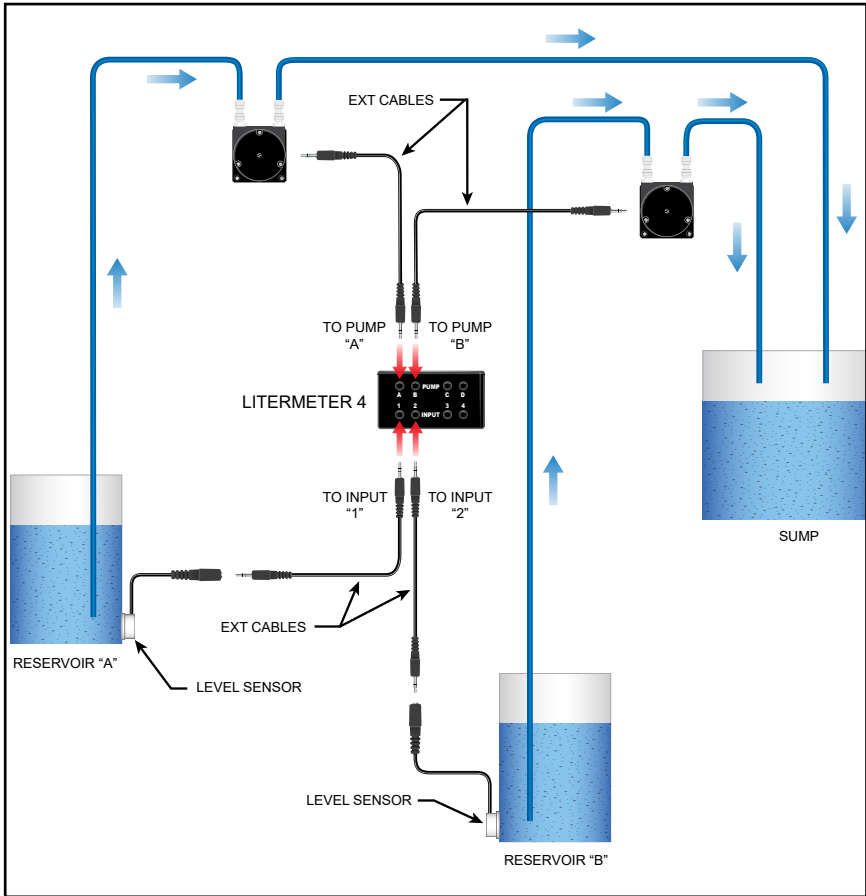

A-B Dosing System

Water Exchange System:

This is a Water Exchange System that is protected on both ends with Level Sensors.

Fresh Salt Water is dosed to the sump periodically.

An equal amount is dosed from the sump to drain.

Both Pumps will stop if either the reservoir is dry or the sump has reached a critical level.

Parts List:

1x LM4 & Power Supply

2x Pumps

2x Sensors

4x EXT Cables, Length as Required

4x Tubing, 1/4", Length as Required

Plumbing Connections:

Connect tubing from reservoir "A" to Pump "A".

Connect tubing from Pump "A" to sump.

Connect tubing from reservoir "B" to Pump "B".

Connect tubing from Pump "B" to sump.

Electrical Connections:

Connect one end of an EXT Cable (any length) to a [Level Sensor](#) (Fresh Salt Water) and the other end to Input "1".

Likewise,

Connect Pump to Pump "B".

Connect a Level Sensor (Sump) to Input "3".

Connect Pump to Pump "D".

Inputs Settings:

If Input#1 (Fresh Salt Water) is DRY, then "B" & "D" are OFF

If Input#3 (Critical Sump Level) is WET, then "B" & "D" are OFF

EXT Cables are available in 3 ft, 6 ft, 12 ft, and 25 ft lengths.

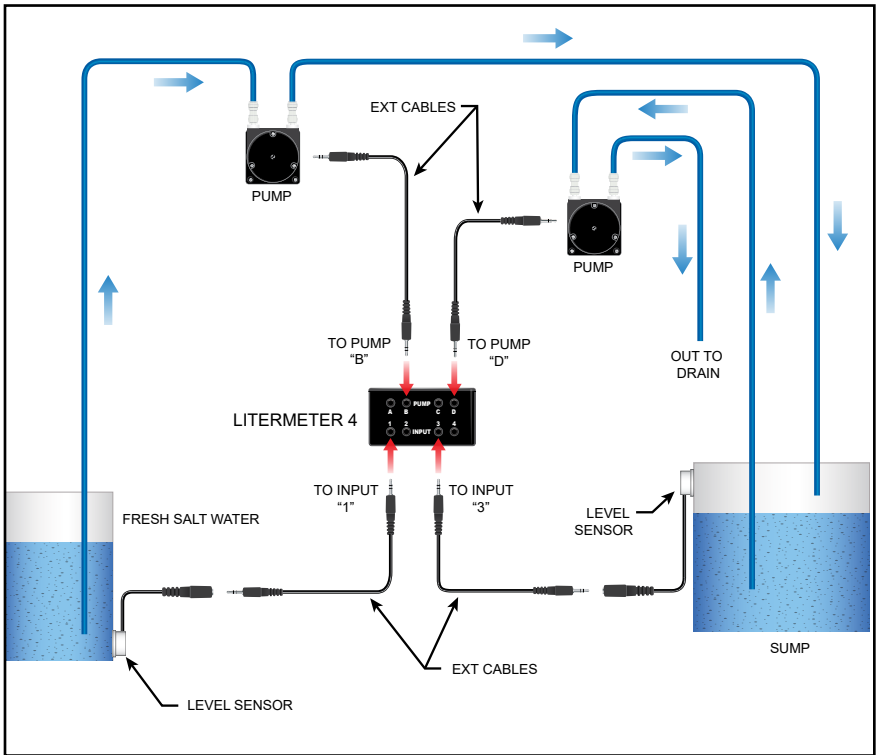

Water Exchange System

ATO + Water Exchange + Kalk System:

This is a 4-Pumps + 4-Inputs example demonstrating the comprehensive water level control possible with the LM4.

Parts List:

- 1x LM4 & Power Supply
- 4x Pumps
- 3x Sensors
- 1x Wet Floor Sensor (available soon)
- 8x EXT Cables, Length as Required
- 8x Tubing, 1/4", Length as Required

Plumbing Connections:

- Connect tubing from DI Water to Pump "A".
- Connect tubing from Pump "A" to sump.
- Connect tubing from Fresh Salt Water to Pump "B".
- Connect tubing from Pump "B" to sump.
- Connect tubing from sump (position end 2" below normal sump level) to Pump "C".
- Connect tubing from Pump "C" to drain.
- Connect tubing from Kalkwasser to Pump "D".
- Connect tubing from Pump "D" to sump.

Electrical Connections:

- Follow the diagram.
- Sub-systems have been described previously.

Inputs Settings:

- If Input#1(Fresh Salt Water) is DRY, then "B" & "C" are OFF
- If Input#2(Wet Floor Sensor) is WET, then ALL PUMPS OFF
- If Input#3(Normal Sump Level) is WET, then "A" is OFF
- If Input#4(Critical Sump Level) is WET, then ALL PUMPS OFF

EXT Cables are available in 3 ft, 6 ft, 12 ft, and 25 ft lengths.

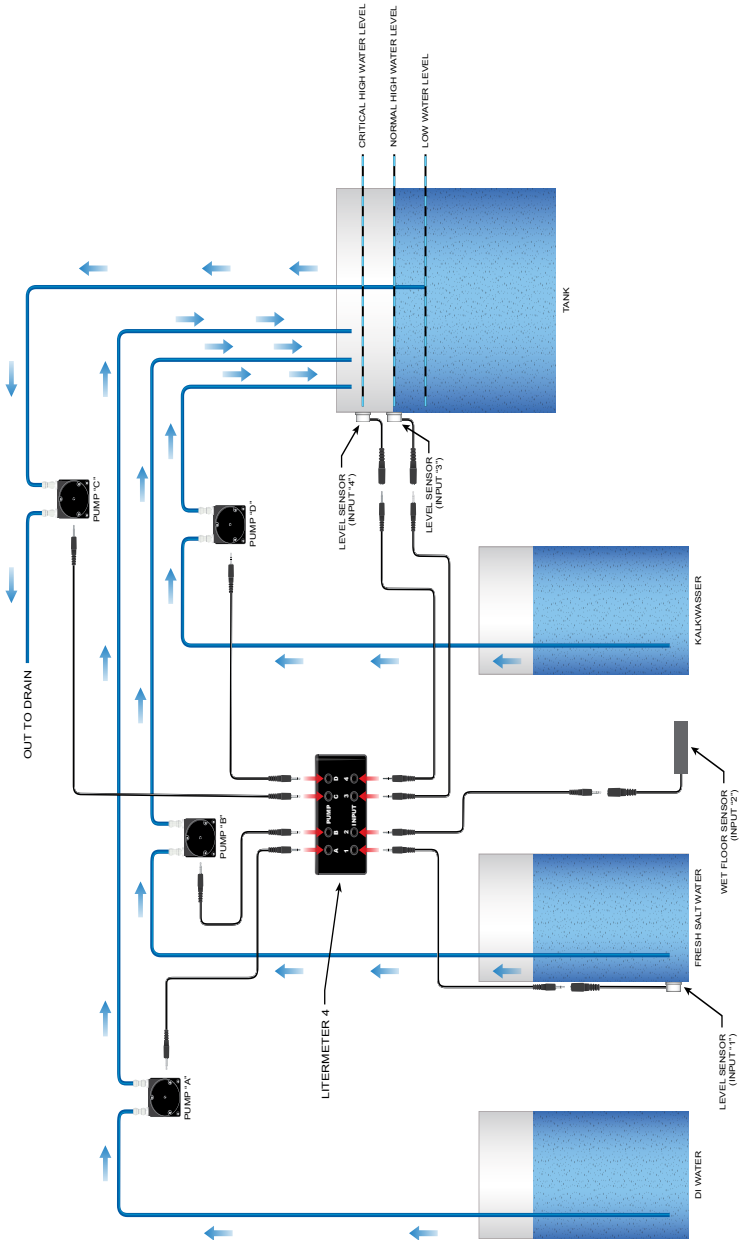

ATO + Water Exchange + Kalk System

SpectraPure®

Settings Page on a Personal Device (PD):

This is the first page you see after connecting to the LM4. Select any of the four pumps to set up and save their parameters. Tap “Calibrate”, “Inputs”, or “System” to move to that page. Tap “ALL PUMPS OFF” to toggle to “ALL PUMPS ENABLED” and back.

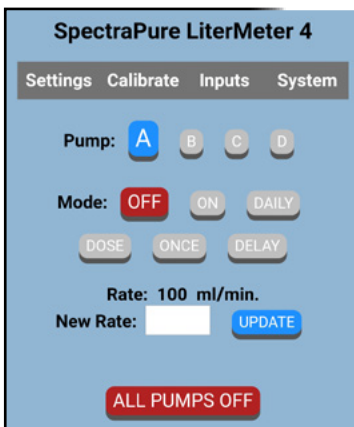

Settings Page:
Pump A is OFF.
All Pumps are Disabled

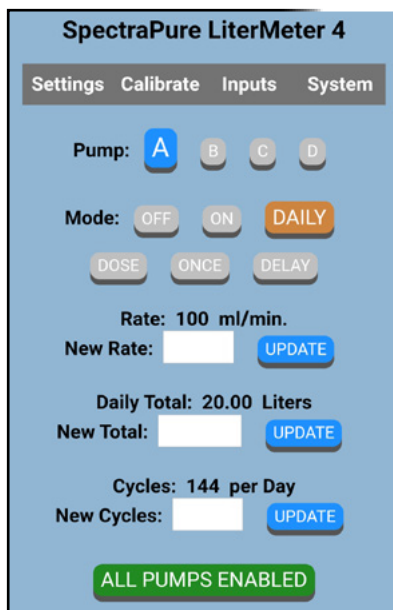

Settings Page:
Pump A in DAILY Mode

Touch the white data entry box next to “New Rate:”.

Using the keypad that appears, enter the Flow Rate. Tap “Update” to store the Flow Rate.

As above, enter the desired Liters per day to be delivered.

Enter a value for Cycles per day. The LM4 will “round down” to a preset value for “New Cycles”.

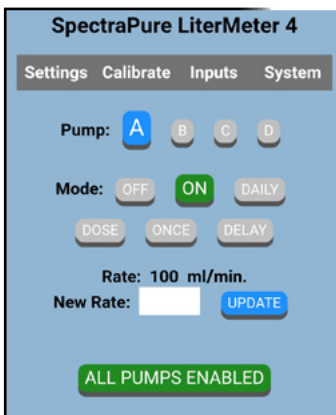

Settings Page:
Pump A is ON
and Running at
100 ml/min.

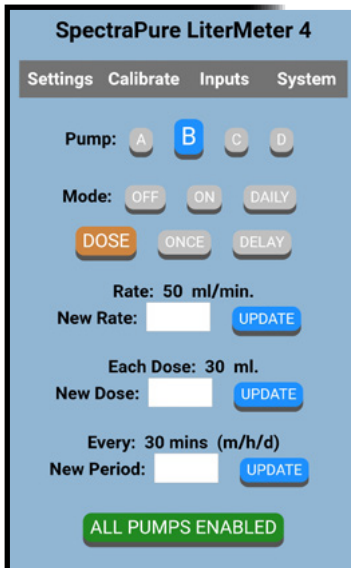

Settings Page:
Pump B in DOSE Mode

Touch the white data entry box next to "New Rate:".

Using the keypad that appears, enter the new Flow Rate. Tap "Update" to store the Flow Rate.

As before, enter the desired "New Dose:" to be delivered.

Enter a numeric value, followed by an "m" (minutes - at least 2), an "h" (hours), or a "d" (days - up to 28) for "New Period:".

The LM4 will "round up" to a preset value for "New Period:".

See ["PreSet Periods and Cycles"](#)

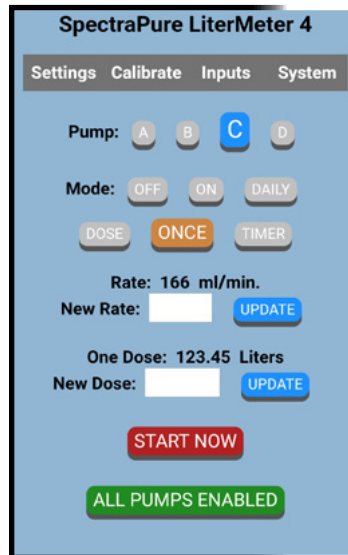

Settings Page:
Pump C in ONCE Mode

Touch the white data entry box next to "New Rate:".

Using the keypad that appears, enter the new Flow Rate. Tap "Update" to store the Flow Rate.

As above, enter the desired "New Dose:" to be delivered.

The dose will be delivered when "START NOW" is tapped.

PreSet Periods and Cycles:

DOSE Periods:	DAILY Cycles:
2 mins	720 per day
3 mins	480 per day
4 mins	360 per day
6 mins	240 per day
10 mins	144 per day
15 mins	96 per day
30 mins	48 per day
1 hour	24 per day
2 hours	12 per day
3 hours	8 per day
4 hours	6 per day
6 hours	4 per day
8 hours	3 per day
12 hours	2 per day
1 day	
2 days	
3 days	
4 days	
5 days	
6 days	
7 days	
14 days	
21 days	
28 days	

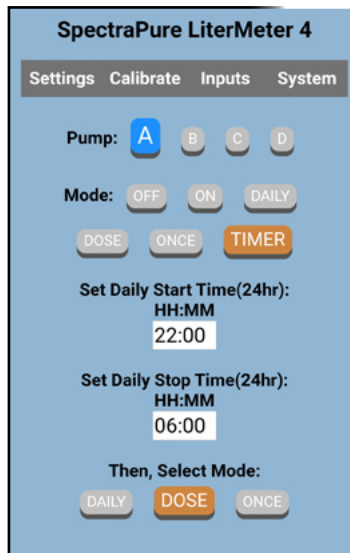

Settings Page:
Pump A in TIMER/DOSE Mode

First, if a Mode is already selected, tap it to deselect it.

Then, enter daily Start and Stop Times (24hr format). A "space" can be entered in place of the "colon". Here, we have set the Start Time to 10:00PM and the Stop Time to 6:00AM.

Then select the Mode.

That Mode for this Pump will be active between the Start Time and the Stop Time, every day, as long as this TIMER page is displayed for this Pump and the Mode is selected here.

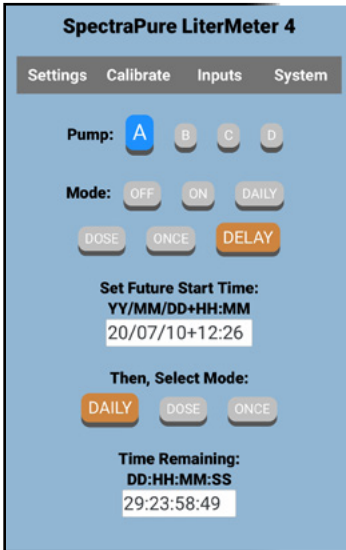

Settings Page:

Pump A in DELAY/DAILY Mode

First, if a Mode is already selected, tap it to deselect it.

When no Mode is selected, the current time is displayed as a useful template to modify and enter a future time and date. Use the exact format as shown.

Then select the Mode.

Time Remaining is the countdown until activation, when that Mode will be activated "forever".

Here, a future time was set, and 29+ days is counting down.

Once that time/date has been reached, the current time will again be displayed and that Mode activated.



Calibrate Page on a PD:

“Calibrate” will prepare the “Current Pump” for calibration. See “Calibrate Page on the LM4” for more details. You can have All Pumps Off and still perform the Calibration when using the PD.

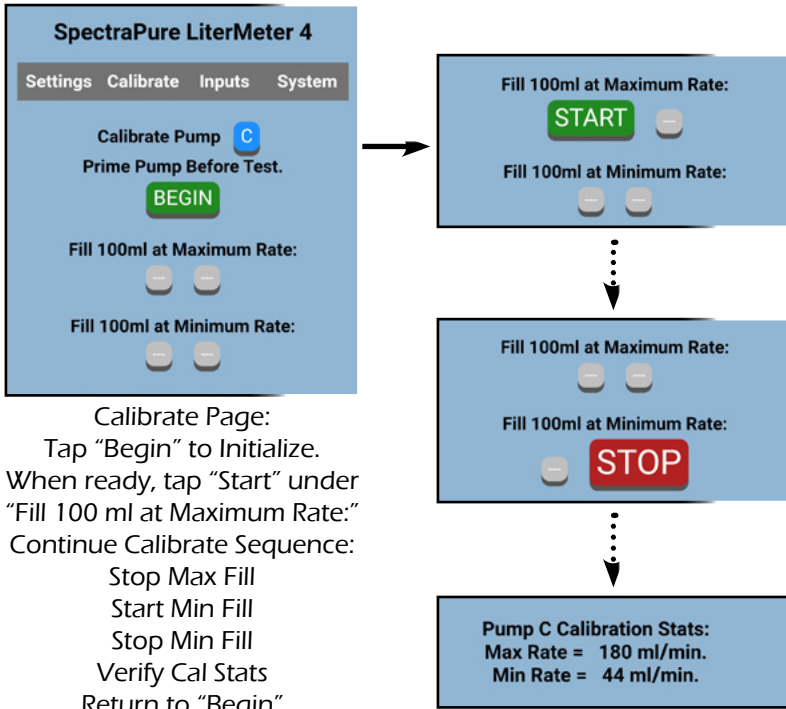

It is possible that a particular pump may not operate at the lowest default speed used by the Calibrate function. You can use the ⬆️ and ⬇️ buttons on the LM4 (only, not available on the PD) and only when you see “Stop 100ml? >” while measuring the minimum rate. Adjust the speed UP until the pump starts to run. There is a 5-second delay between button presses (time to empty the measuring device).

You may have a pump that can run slower than the default speed. Adjust the speed DOWN until the pump stops, then UP until it starts to run again.

This “alternate minimum” is reset to factory default if “Clear and Restore to Factory Settings” is executed.

SpectraPure®

Inputs Page on a PD:

“Inputs” displays the 4 x 4 matrix of Pumps and Sensors.

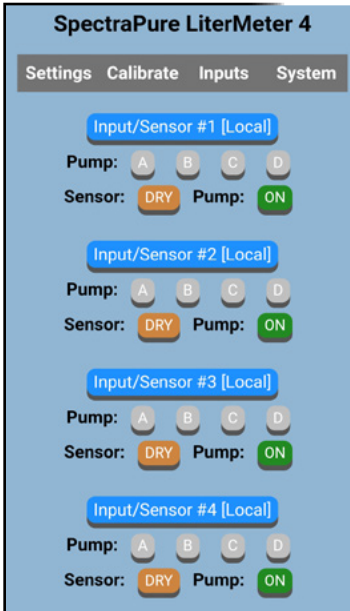

Inputs Page:

Default - All Inputs are
Cleared and
Unassigned.

This is a 4 x 4 matrix that can
assign ANY input sensor to
ANY pump.

See “[Inputs Page on the LM4](#)”.

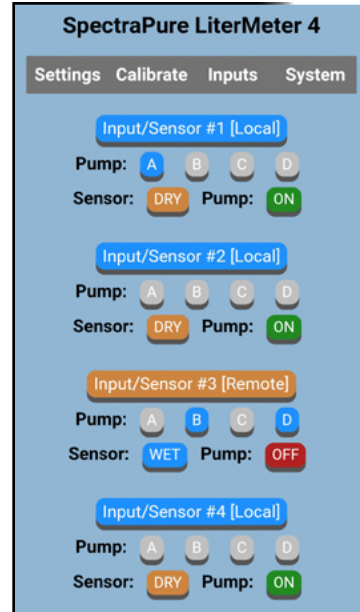

Inputs Page, example:

Input #1 uses the Master’s sensor
and attaches Pump A to it. When
the sensor is dry, the pump will
turn on.

Input #3 uses the Remote’s
sensor #3 and attaches Pumps B
and D to it. When the sensor is
wet, the pumps will turn off.

See “[Inputs Page on the LM4](#)”.

SpectraPure®

System Page on a PD:

“System” displays WiFi connections and access to General Configuration Functions.



System Page:

Notes the private SSID of this LM4 and the URL to reach it.

Notes the name of the local router, if there is one, and the URL to reach the LM4.

Select:

“Set Time Zone”,

“ReStart LM4”

(ReStarts LM4),

“Factory Settings”, or

“Firmware Update”

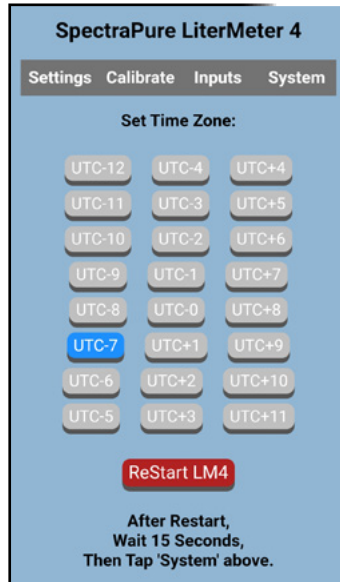

System Page:
Set Time Zone

Select your time zone, then tap “ReStart LM4”,

Some Examples:

UTC-08 PST

UTC-07 MST, PDT, AZ

UTC-06 CST, MDT

UTC-05 EST, CDT

UTC+08 AWST

UTC+09 ACST

UTC+10 AEST

UTC+11 AEDT

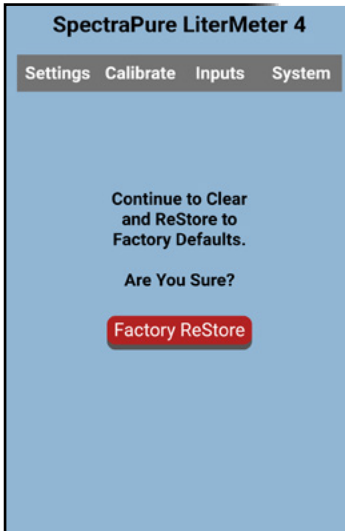

System Page:
Confirm Factory ReStore

See "Clear and Restore to
Factory Settings".

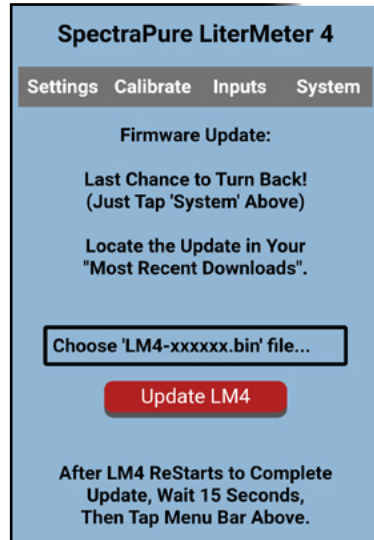

System Page:
Firmware Update

Download the latest Firmware
Update from SpectraPure to your
Personal Device.

Tap "Choose 'LM4-xx-...'"

Select the Update from the list of
"Most Recent Downloads", It should
be near the top of the list.

The Update should appear in the
box outlined in black.

Tap "Update LM4".

A progress indicator will update and
the display on the LM4 will blink
erratically during Update progress.

After the Update: Settings,
Router, and WiFi Credentials are
retained.

LiterMeter 4 Basic Operation:

The LM4 will return to the state it was in when a Restart occurs or power is lost and restored. All Pump functions and timings will be restored and operation will continue.

SpectraPure
LiterMeter 4
ALL PUMPS OFF

If ALL PUMPS OFF is displayed:

NO PUMP CAN RUN FOR ANY REASON
(except during individual Calibrations)

A: Settings
Mode: OFF
Rate: 100 ml/m



If ALL PUMPS OFF (APO button ) is pressed:



ALL PUMPS ARE ENABLED and Settings, Calibrate, or System page is displayed - whatever was displayed when power was interrupted or APO was pressed.



◀◀
SpectraPure
LiterMeter 4
ALL PUMPS OFF

If the APO button () is pressed again, the LM4 returns to ALL PUMPS OFF.







Navigating the LM4:

After a ReStart, the blinking underline cursor should be in the upper left corner of the display and indicates the “current pump”. The parameters for that pump are available to change. Press the  or  button to select the “current pump” you wish to adjust – A, B, C, or D.











Press the  button to select the “Settings” page. Press  again to select the “Calibrate” page, again to select the “System” page, and again to return to the Settings page. Press the  button at any time to step back through this sequence of pages.

At any time, pressing the APO  button will disable All Pumps. When all pumps are off, only the  button will re-enable the pumps. The other four buttons will beep rapidly but not be responsive. Pumps may be calibrated when All Pumps are Off.



















Settings Page on the LM4:

With the Settings page selected, press  to move the cursor to the "M" in "Mode:". (Later, press  to move back up to the current pump.) Press the  or  button to move the cursor to the data entry area for Mode:. Here, press the  or  buttons to step through the available modes of operation – OFF, ON, DAILY, DOSE, ONCE, TIMER, and DELAY.

In OFF mode, the pump will not operate but you can set the Flow Rate.

In ON mode, the pump will operate constantly at the selected "Rate:" (in ml/min). Press  or  to move the cursor back to the "M" in Mode:. Press  to move the cursor down to the "R" in Rate:. Press  or  to move to the data entry area for Rate:. Position the cursor under the digit you wish to change and press  or  to change the Rate to any speed between the maximum and minimum rates that are determined by the Calibrate procedure. The pump should now be operational. Leave the data entry area and move back to the "M" in Mode: by pressing either  or , or you can press  to change to DAILY mode.



In DAILY mode, the Daily "Total:" (in Liters) and number of Cycles can be set. This is like the LiterMeter 3 mode of operation. It will dispense a desired total quantity of liquid every 24 hours using an adjustable number of cycles. Press  or  to move the cursor back to the "M" in Mode:. Press  to move the cursor to the "T" in Total:. Press  or  to move to the "data entry area" for Total:. Move the cursor under the digit you wish to change and press  or  to adjust the Total Liters that you want dispensed each day. Press  or  to move the cursor back to the "T" in Total:. Press  to move the cursor to the "C" in Cycles:. Press  or  to move to the "data entry area" for Cycles:. There is only one location for the cursor. Press  or  to step through the allowable number of cycles per day. Navigation continues as above.  and  move the cursor horizontally across the display, stopping at pertinent locations,  and  change the values in data entry areas or moves the cursor vertically between display lines.

Minimum number of Cycles is 2 per day, Maximum Cycles is 720 per day.



NOTE: When setting the values for rate, daily totals, and doses the LM4 will not allow you to set amounts that are greater than the pump's set rate can deliver.

SpectraPure®

In DOSE Mode, the amount (in milliliters) “Each:” dose will dispense and how often to dispense it can be set. Navigation is similar to the DAILY screen - enter milliliters per dose and select the desired period.

The minutes in DOSE mode or the number of cycles in DAILY mode must be evenly divisible into 1440 (the number of minutes in a day). For example, if you set the LM4 for 144 cycles per day, it would dispense every 10 minutes ($1440 \div 144$). This data entry area steps up and down through allowable periods. See “PreSet Periods and Cycles”.

Minimum period is 2 minutes, maximum period is 28 days.

In ONCE mode, ONE total dose (in Liters) will be dispensed at one time. When that time is now, move the cursor down to the “>” before “START NOW”. Press  to start the pump. The total amount will be dispensed, and then no further operation will be allowed. Press  before “RESTART” to stop the pump and RESET the total dose. The display will return to “>START NOW”. If you wished to temporarily “pause” the operation, press . If a ReStart occurs during a ONCE dose, the dose will not finish. The pump will RESET to “>START NOW” and return to the top of the “Settings” page.

TIMER mode and DELAY mode need a WiFi connection to maintain the current time. A Personal Device is also needed to set start and stop times for the TIMER and DELAY Modes and select one of the three modes to activate at/after the specified time(s). See “Settings Page on a Personal Device”. Both allow one of the above three modes (DAILY, DOSE, or ONCE) to be controlled by the actual time. TIMER sets a daily start and stop time for a selected mode. DELAY sets a future time to activate the selected mode. For both time modes, the third line of the display shows “Start: Select” until one of the three modes is selected. In TIMER mode, if start and stop times are not set, the fourth line will display “00:00 to 00:00”. In DELAY mode, the fourth line will display the current time if a mode is not selected, or the preset future start time if a mode is selected. If the LM4 has not made a connection with a router and time server, the third and fourth lines will display “Time Not Available”.

Some parameters are shared by multiple Modes. Flow Rate can be set in the OFF or the ON Mode. The same Flow Rate is also used by the DAILY, DOSE, and ONCE Modes.

Some Examples Using the LM4:

```
B:Settings
Mode: ON
Rate: 100 ml/m
```

Pump B is set to run continuously at 100 ml/min.

```
C:Settings
Mode: DOSE
Each: 100 ml
Every: 10 mins
```

Pump C is set to DOSE 100 ml every 10 minutes.

```
Input #1 [Loc]
Pumps: A _ _ _
IF Sensor: DRY
THEN Pump: ON
```

Input #1 uses the Master's sensor and attaches Pump A to it. When the sensor is dry, the pump will turn on.

Calibrate Page on the LM4:

The flow rate of any pump is affected by the size, length, and level changes of the connected tubing — how far up it is pushing or how far down it is drawing from. In order to get the most accurate results when calibrating the pump, it is recommended that the pump be set up in the desired installation/configuration before beginning the calibration sequence. Each pump will be calibrated separately.

All new pumps have a short break-in period. To minimize these effects, run the pump in the ON Mode (wet or dry) for at least 20 minutes before proceeding. Be sure to completely prime the pump and tubing by setting the Mode to ON until primed before proceeding to the calibration process.



Once a pump has been calibrated, the LiterMeter4 can determine the minimum and maximum flow rates, and maximum daily total.

You may use the included graduated cylinder to double check the calibration. Set your pump for a ONCE dose of 0.10 L (100 ml.) at a Rate of 100 ml/min., and use the cylinder to measure the results. If the dosage is off by more than +/-3%, you should recalibrate that pump.

We recommend that you recalibrate your pumps after the first few weeks of use.

The Calibration Process:

A: Calibrate
Cal Begin? >
Prime Pump
Before Test.

Navigate to the “Calibrate” page for the Pump you wish to calibrate. The cursor should be under the “C” in Calibrate. Press  button once. You are about to begin the Calibration process. All inlet and outlet tubing should be in place for an accurate measurement. The pump and tubing should be primed. Now, press  button once.

A: Calibration
Max Rate (ml/m)
Start 100ml? >

Use the supplied 100 ml. graduated cylinder for this part of the test. Direct the output of the pump into the cylinder. Press  button to begin the test.

A: Calibration
Max Rate (ml/m)
Stop 100ml? ≥

When the level in the graduated cylinder reaches the 100 ml. line, press the  button again to complete the Max Rate test. Empty the cylinder.

A: Calibration
Min Rate (ml/m)
Start 100ml? ≥

Again, use the 100 ml. graduated cylinder. Direct the output of the pump into the cylinder. Press the  button to begin the test.

A: Calibration
Min Rate (ml/m)
Stop 100ml? ≥

When the level in the cylinder reaches the 100 ml. line, press the  button again to complete the Min Rate test.

Max= XXXX
Min= XXXX

The LM4 will briefly display a page with the calibrated maximum and minimum rates. These values may help our Tech Support in diagnosing any problems you may have.

Max and Min Rates for all four pumps can be seen at "System" > "Info".

A: Calibration
Complete.

The screen will now return to the beginning of the Calibration process.



Inputs Page on the LM4:







Any input can be “attached” to any or all pumps. For example, a float switch can be set up to turn a pump “off” when that float switch is “wet”.





There are four inputs for connecting a variety of sensors including float switches, capacitive sensors, *wet floor sensors, *ground moisture sensors, *light sensors, and others. Each input can “limit” any or all pumps. (*under development)



All combinations of orientation and polarity of the sensors are accommodated. The Level Sensors (LM-LLS-01) operate the same way as float switches that are installed “upside down”, where they are dry when drooping down at an angle and horizontal when wet. Float switches that are installed horizontal when dry and float up when wet would operate “reversed”.

If a sensor seems to work “reversed”, just assign the opposite state for the sensor (“DRY” or “WET”). Without a sensor plugged into an input jack, the LM4 will assume that the input is “closed” representing a default “wet” condition. We will avoid future references to “open”/“closed” and “high”/“low”. There’s just wet and dry, and off and on. The LM4 will make it work.









The “System” page lists “Inputs”, “Networks”, and “Calibrations”. With the cursor under the “S” in System, press  to move down to the “>” to the left of “Inputs”. Press  to enter the “Inputs” page.

On the Inputs page, the cursor will be under the “I” in “Input #”. (Note: To exit this page, press  to return to the System page.) Press  to move to the data entry area for Input #. Press  or  to step through the four inputs. Press  to move to “[Loc]” (more on this later). Press  to move back around to the “I” in Index.

Press  to move the cursor down to the “P” in “Pumps:”. Press  or  to move to the four empty underlines. The underlines represent pumps “A B C D”. When the letter is displayed, that pump is “attached” to that Input. Press  or  to attach or detach a pump to this Input. Move the cursor back to the “P” in Pumps. Move the cursor down to the “I” in “IF”.

These last two lines will configure any combination of float/sensor orientations and the desired operation of the pump. Press  or  to

SpectraPure®

move to the word "DRY". Press  or  to toggle between "DRY" and "WET". Press  or  to move back to "IF". Move down to the "T" in "THEN". This will configure the operation of the pump. Press  or  to move to the word "ON". Press  or  to toggle between "ON" and "OFF".

Some Input Examples:

1) A dry float switch at the top of a tank (is normally closed) and usually allows a pump to run. This would be the non-LIMITed state. A pump is connected to "PUMP B" and a float switch is connected to "INPUT #1". On the Input #1 page, set "PUMPS: _ B _ _", set "IF Sensor: WET" and set "THEN Pump: OFF". When that float switch becomes wet, the pump will be stopped, and that pump will indicate "LIMIT" instead of "ON".

2) A wet float switch at the bottom of a reservoir (is normally open) and usually allows two pumps to run. This would be the non-LIMITed state. Pumps are connected to "PUMP B" and "PUMP C" and a float switch is connected to "INPUT #2". On the Input #2 page, set PUMPS: to "_ B C _", set "IF Sensor: DRY" and set "THEN Pump: OFF". When that float switch becomes dry, the pumps will be stopped, and both pumps will display "LIMIT" instead of "ON".

External Remote Level Sensors:

Level Sensors (LM-LLS-01) can be attached to the outside of a flat-sided vessel, up to 3/8" wall thickness. The sticky backing can be reused several times by gently prying it off the glass with a butter knife.



Hold the Sensor by its wire to avoid false readings. Position at water level and observe the red LED showing activation.

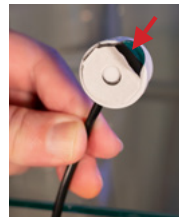





Peel the protective backing from the Sensor and apply to glass.

SpectraPure®

System Page on the LM4:



The "System" page lists "Inputs", "Networks", and "Calibrations".

Inputs: With the cursor under the "S" in System, press  to move down to the ">" to the left of "Inputs". Press  to enter the "Inputs" page. See "[Inputs Page on the LM4](#)" and "[Some Input Examples](#)" for more on using the Inputs functions.

Networks: Press  twice to move down to the third line of the display, "> Networks". Press  to enter the "Networks" page.

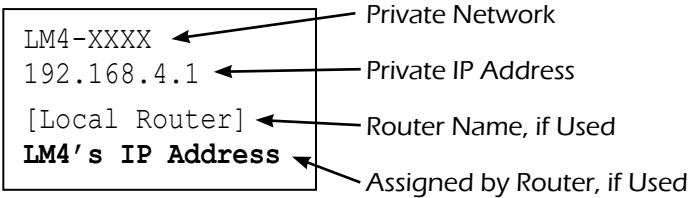
Press  to return to the "System" page.



Calibrations: Press  three times to move down to the fourth line of the display, "> Calibrations". Press  to enter the page.

The LM4 displays the maximum and minimum calibrated flow rates (ml/min) for all four pumps:

A =	Max	Min
B =	Max	Min
C =	Max	Min
D =	Max	Min

This can serve as a "sanity check" if you are experiencing erratic or inaccurate operation.

Factory Reset values are 180 and 45.

SpectraPure®

Normal ReStart Sequence: (w/ Valid WiFi Creds)

After a ReStart, the LM4 will display these screens:

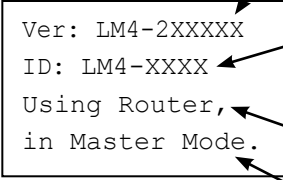

Ver: LM4-2XXXXX
ID: LM4-XXXX
Using Router,
in Master Mode.

Current version of the firmware.
It can be updated.
See "[System Page: Firmware Update](#)".

ID number for the LM4. It will be a unique
4-digit number, not XXXX.

Status of Router/No Router Mode.

Status of Master/Remote Mode.

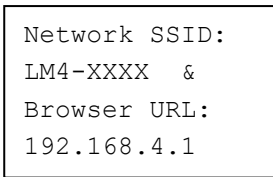

Network SSID:
LM4-XXXX &
Browser URL:
192.168.4.1

The LM4 uses its stored WiFi
credentials to auto-connect to the
local router.

If Auto-Connect IS successful:

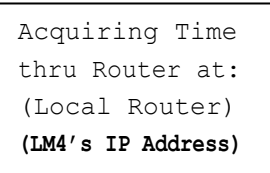

Acquiring Time
thru Router at:
(Local Router)
(LM4's IP Address)

You will be able to automatically connect to
the LM4 now and after future ReStarts with
your PD, using the local network router and
**an IP address created by the router (DHCP)
for the LM4.**

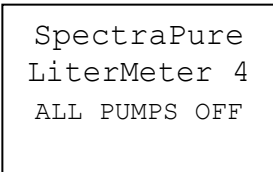

SpectraPure
LiterMeter 4
ALL PUMPS OFF

After acquiring the time, the LM4 will display
the SSID of the local router. **Use the IP
address in a browser to connect to the LM4.**
Continue on to "[LiterMeter 4 Basic Operation](#)"
and/or "[Settings Page on a Personal Device](#)".

If you missed the IP Address, just ReStart the
LM4 and note it on the display, or see "[System
Page on the LM4](#)".

What can go wrong? See next page . . .

But Could
Not Get
Time From
Network.

The LM4 connects properly to the internet, but there's a problem getting the time from a time server. If unsuccessful on the first try, it will repeat this process until a valid time is received. Usually, at most, it completes in 2 or 3 tries. If this error persists, you may have to use the Private Network and Private IP Address until the problem can be resolved.

Network SSID:
LM4-XXXX &
Browser URL:
192.168.4.1

If this screen persists more than approx. 20 seconds, Auto-Connect is probably NOT going to be successful, for any number of reasons. Cycle the power to the LM4, or if that is unsuccessful, then See "[Clear WiFi Parameters](#)" and the Quick-Start after that to re-establish the connection with your personal device.

Sometime, there might be a whole-house power outage. The LM4 will ReStart long before the local modem/router can return to online status. The LM4 will wait up to 6 minutes until it can get a valid connection and time. There might also be the case where the router loses power or goes off-line. The LM4's time will not be affected, but you may have to reStart the LM4 to re-establish the connection between the router and the LM4.

Timed-Out,
or Incorrect
Router SSID
or Password.

If the router can't be found, or you waited more than 6 minutes to configure the WiFi, or there's an incorrect SSID or password, the LM4 will establish itself as a "Private Network" and then continue to "Normal Operation" without the network time. This only affects the TIMER and DELAY Modes.

Reminder: With or without an established router connection, you can always control the LM4 using a Personal Device on the LM4-XXXX Private Network and Browser URL = 192.168.4.1

ReStart and Configuration Functions:

There are two ways to ReStart the LM4:

When the LM4 is already powered-up and operational, press and hold BOTH LEFT (⬅️) and UP (⬆️) buttons AT THE SAME TIME. Continue to hold the buttons down until the LM4 beeps two times. Release the buttons and the LM4 will ReStart.

The LM4 can also be restarted by removing and then re-applying power to the unit. Plug the power supply into an AC outlet, then connect the 12VDC power supply to the LM4 Power Input jack on the side of the unit.

There are some functions that can only be configured at ReStart time. If one of the functions listed below is needed, now is the time to press that button and wait for three beeps as confirmation, then release the button.



Config Buttons Schedule

- LEFT Button** (⬅️) Toggle the Use/No Use of a Router
- RIGHT Button** (➡️) Toggle Master/Remote Mode
- APO Button** (■) Clear and Restore to Factory Settings
- DOWN Button** (⬇️) Not Used (yet)
- UP Button** (⬆️) Clear WiFi Parameters (SSID & password)

Beeps Schedule

- 1 Beep** Normal ReStart Sequence
- 2 Beeps** 2-Button (⬅️ and ⬆️) ReStart
- 3 Beeps** Configuration Confirmation

Toggle the Use/No Use of a Router (LEFT Button ◀):

The LM4 has an internal clock that is very accurate, day-to-day. The Daily, Dose, and Once Modes use this clock. However, the TIMER and DELAY Modes need to know the actual time They get the time from the Internet, and that requires connecting to a local WiFi router. There may be a situation where a local router is not available, or it is not desirable to connect to a local network, or the TIMER or DELAY Mode will not be used. In these cases you will not want to wait for the “Auto-Connect to a Router at ReStart” to timeout after 6 minutes, every time it is restarted.

To skip searching for a router, hold the ◀ button down directly after a ReStart. Hold the button down until you hear three beeps and you see:



Toggled:
Now, LM4
will NOT USE
WiFi Router.

Release the ◀ button. This “toggles” the Router Mode off. Future ReStarts will continue without asking for a router or credentials

Toggled:
Now, LM4
will USE
WiFi Router.

And, if you wait for the LM4 to completely restart and do it again, you will toggle the Router Mode back on. See “[Normal Restart Sequence](#)”.

REMINDER: Even without an established router connection, you can access the LM4 using a Personal Device on the LM4-XXXX Private Network and URL = 192.168.4.1

Toggle Master/Remote Mode (RIGHT Button ➡):

See “Using Remote Mode” later in this document. This mode is only usable when there is another LM4 in Master Mode. When in Remote Mode, the LM4 communicates directly with the Master LM4, so the router connection will be toggled off. To configure an LM4 for Remote Mode, hold the ➡ button down directly after a ReStart until you hear three beeps and you see:

```
Toggled:
This LM4
is now In
REMOTE Mode
```

Release the ➡ button. Future ReStarts will have the LM4 in Remote Mode.

```
Remote Mode
Searching for:
LM4- _
\'>' to Config.
```

If this is the first time in Remote Mode and this LM4 has not been “paired” to a Master LM4, the Remote LM4 will begin slowly chirping and looking for its mate. Press and hold the ➡ button for two seconds to jump to “Set Master ID”.

```
Set Master ID:
- - - - -
LM4- _
```

Enter the four digits of the Master LM4’s ID (viewed whenever the Master LM4 is restarted.)

Use the ⬆ and ⬇ buttons to enter the first digit, move to the right with the ➡ button and continue for all four digits.

```
Toggled:
This LM4
is now In
MASTER Mode
```

Navigate around with the ➡ button, then press ⬅ button to move to the “S” in “Set”.

Press ⬆ to return to the “System” page.

```
Network SSID:
LM4-XXXX
Point Browser:
192.168.4.1
```

ReStart the Remote LM4.

To restore the LM4 to Master Mode, hold the ➡ button down after a ReStart. Hold the button down until you hear three beeps and you see:

This is an alert that the WiFi credentials were lost while in Remote Mode and will need to be re-entered to use the local router, although a PD can be used with the private network LM4-XXXX and 192.168.4.1. See “Clear WiFi Parameters”.

Clear and Restore to Factory Settings (APO Button

Parameters that are restored to default factory values include:

Calibration Parameters for All Pumps:

Factory parameters may not always be accurate for a given pump, but the pumps should operate.

Parameters for All Modes:

DAILY, DOSE and ONCE Modes set to nominal values.

Time Zone, Start, Stop, and Future Times are cleared.

Input Sensor Parameters:

All pumps deselected from inputs and inputs cleared.

Remote Mode restored to Master Mode, Master ID is cleared.

NOTE: Router Mode and WiFi credentials (SSID & password) are NOT affected.



Clear and
Restore to
Factory
Settings

To restore the factory settings, hold the  button down directly after a ReStart. Hold the button down until you hear three beeps and you see:

Clear WiFi Parameters (SSID & password) (UP Button

Clear WiFi
Credentials
SSID = '0'
PW = '0'

To clear the WiFi Parameters, hold the  button down directly after a ReStart. Hold the button down until you hear three beeps and you see:

If you move the LM4 to a new location and/or router, you will have to clear the parameters before configuring the new router. Previous credentials are not saved.

This sequence continues on the following page . . .

SpectraPure®

Quick Start: Pairing the LM4 with Your Phone:

A new LiterMeter4 out-of-the-box will display the following:

(Also, a LM4 that has had its WiFi Credentials Cleared)

Ver: LM4-2XXXXX
ID: LM4-XXXX
Using Router,
in Master Mode.

This is the current version of the firmware. It can be updated. See "[System Page:Firmware Update](#)".

This is the ID number for the LM4. It will be a unique 4-digit number, not XXXX. You will see it again below.

Status of Router/No Router Mode.

Status of Master/Remote Mode.

Network SSID:
LM4-XXXX &
Browser URL:
192.168.4.1

You now have 6 minutes to:

1. Open WiFi Settings on your phone.
2. Select the LM4-XXXX from the menu.
3. If a password is requested, it is the same — "LM4-XXXX".
4. Open any browser to URL: 192.168.4.1.
5. You should see the Configure page below:

6. Tap on "Configure WiFi"

LM4-4106

SpectraPure LiterMeter 4

[Configure WiFi](#)

[Exit](#)

Not Connected to 0
AP not found

7. If you do not see your local router, tap "Scan Networks".

Twin_Valley 📶

NETGEAR65 📶

ASUS 📶

NTGR_VMB_8540450972 📶

CenturyLink0246 📶

Burrr bebecita 📶

CenturyLink5499 📶

SSID

Password

[Save](#)

[Scan Networks](#)

SpectraPure®

When the network router is found, select the SSID (name), enter its password, and tap the “Save” button. The name and password are encrypted and stored in the LM4. These credentials are used at every ReStart to automatically connect to the router and get the current time.

LM4 will ReStart and:
Save Credentials,
Connect to Router,
Get Local Time. and
Display **(LM4’s IP Address)**.

After LM4 ReStarts, Please:
Return to WiFi Settings.
Select the Credentialed Router.
Set Browser to **(LM4’s IP Address)**.
Control LM4 Using This Device.

The completion page is displayed for 5 seconds. The LM4 will ReStart, get the network time, and follow the “[Normal ReStart Sequence](#)”.

Acquiring Time
thru Router at:
(WiFi Router)
(LM4’s IP Address)

← Here is your router’s name.

← **Please note the IP address that your router has assigned to the LM4, as (LM4’s IP Address).**

SpectraPure
LiterMeter 4
ALL PUMPS OFF

Then, the LM4 displays the most recent screen.

See “[System Page on the LM4](#)” for how to find **LM4’s IP Address**. Or, just ReStart and watch the screen.

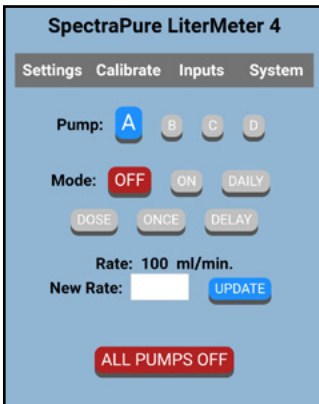

1. Open WiFi Settings on your phone.
2. Select your local router.
3. Set a browser to URL:
(LM4’s IP Address).
4. You should see the Settings page.
5. Navigate and explore the Settings, Calibrate, Inputs, and System pages.

See “[Settings Page on a Personal Device](#)” for more details.

Using Remote Mode:

A second LM4 can be configured as a “Remote”. It will be in constant wireless contact with a “Master” LM4. A Remote can be considered to be an extension of the Master. The Remote shares the state of its inputs with the Master and allows the Master to control its pumps. A typical arrangement could have the Master in the water production room and the Remote at the aquarium. The Remote can monitor water levels at the tank and inform the Master when to pump water from the water room. A pump connected to the Remote can send old aquarium water to a nearby drain, out of reach of the Master in the water room.



The Remote needs to be properly configured before use, but nothing has to be changed on the Master. Once in Remote mode, only the front panel buttons and display can be used.

After entering the ID of the Master into the Remote (See “[Toggle Master/Remote Mode](#)”), a private “link” is established. The Remote is responsible for maintaining the connection between the two systems. If the link is ever lost, the Remote will chirp for 10 seconds before restarting itself. This will usually restore the link. If the Master is turned off, the Remote will “try forever” to find its mate until it is toggled back to Master mode or the Master is reStarted.



The Inputs on the Remote can be used by the Master as well as the Remote. A pump with its Mode set to ON allows the Master to control that pump. In the other Modes, OFF, DAILY, DOSE, and ONCE control is retained by the Remote. TIMER and DELAY are not available on the Remote.

Periodically, the Remote sends: a) the state of its inputs, b) which pumps have their Mode set to ON, and c) maximum and minimum flow rate calibrations for the Remote pumps, as data to the Master. The Master receives the data, then sends flow rate commands and APO back to the Remote.

The Master has the choice of using its own inputs or any of the Remote’s inputs, but no more than a total of four. They are “attached” to pumps on the Inputs page on the Master. Change “{Loc}” to “{Rem}” with  or  buttons.

The Master sends flow rate commands to the Remote. The pumps on the Master are fully functional regardless of the state of the Remote. It is possible to operate, for example, pump A on the Master and pump A on the Remote at the same time with the same flow rate and schedule. The current pump on the Master’s display that is using a Remote’s pump will indicate “[Rem]” on the second line (Mode:) of the Settings page on the Master LM4.

Some Examples Using Remote Mode:

```
D:Settings
Mode: DOSE [Rem]
Each:   10 ml
Every:  20 mins
```

Master LM4 Screen:

Master controls the Remote's Pump D in DOSE Mode, delivers 10 ml every 20 minutes. [Rem] is displayed whenever Remote's Pump D Mode is set to "ON".

```
Input #3 [Rem]
Pumps:  _ B _ D
IF Sensor: WET
THEN Pump: OFF
```

Master LM4 Screen:

Change Input #3 from [Loc] to [Rem], enable the Remote's sensor #3 and attach Pumps B and D to it. When the Remote sensor is wet, the pumps will turn off.



```
D:Settings
Mode: ON
Under Master
Control
```

Remote LM4 Screen:

Remote's Pump D is enabled by the Master LM4 and is running under Master control.

```
D:Settings
Mode: Disabled
Under Master
Control
```

Remote LM4 Screen:

Remote Pump D is disabled by the Master LM4 and is NOT running.

```
B:Settings
Mode: DAILY
Total: 12.00 L
Cycles: 24/day
```

Remote LM4 Screen:

Remote Pump B is also running in its own DAILY Mode, 12 Liters per day / 500 mL per cycle.

Setting "All Pumps Off" on the Master will change the Remote to All Pumps Off and flash the display. This can then be overridden at the Remote with the APO button. Pumps not controlled by the Master may continue to operate on the Remote.

Troubleshooting, Tips & Tricks:

Every LM4 will have an unique ID so you can identify and operate multiple units on the same network or router.

(This ID is also used to help pair a “Master” LM4 with a “Remote” LM4.)

A Personal Device is the “controller-in-charge”. The LM4 will follow changes made on the PD, but the PD may not follow all changes made on the LM4. Tap any button on the PD to update its screen.

If you want a dosing cycle (DAILY or DOSE) to start from the beginning of its period, briefly switch the mode to ONCE and then back. The pump will start a new dosing period.

Start, Stop, and Future times will display on the LM4, but a Personal Device is needed to program the TIMER and DELAY functions.

DAILY Mode, in TIMER Mode, will automatically dispense the desired Daily Total, even with a less-than-24-hour day.

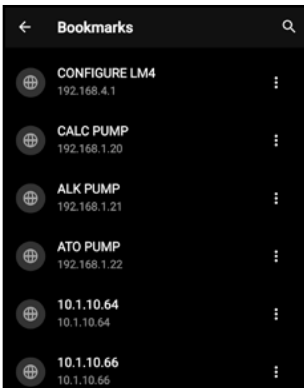

Some browsers allow you to edit their list of bookmarks. If you have multiple LM4s on the local router, or even just one, after each LM4 has been assigned an IP Address, bookmarks with edited names, such as ALK PUMP, CALC PUMP, ATO PUMP, WEX IN, WEX OUT, etc. can be created. Also, you can create a desktop icon for each Pump's IP Address for convenient access.

NOTE: When configuring the WiFi parameters, your phone or tablet may prematurely disconnect from the LM4. Some PDs (Google's Pixel, among others) may not gracefully relinquish their internet connection to a device (LM4-XXXX) that is not connected to the internet.

ONE YEAR LIMITED WARRANTY:

SpectraPure, Inc.® warrants the product to the original owner only to be free of defects in material and workmanship for a period of one year from the date of receipt. SpectraPure's liability under this warranty shall be limited to repairing or replacing at SpectraPure's option, without charge, F.O.B. SpectraPure's factory, any product of SpectraPure's manufacture. SpectraPure will not be liable for any cost of removal, installation, transportation or any other charges which may arise in connection with a warranty claim. Products which are sold but not manufactured by SpectraPure are subject to the warranty provided by the manufacturer of said products and not by SpectraPure's warranty. SpectraPure will not be liable for damage or wear to products caused by abnormal operating conditions, accident, abuse, misuse, unauthorized alteration or repair or, if the product was not installed in accordance with SpectraPure's or other manufacturer's printed installation and operating conditions, or damage caused by hot water, freezing, flood, fire or acts of God.

SpectraPure will not be responsible for any consequential damages arising from installation or use of the product, including any water or mold damage due to flooding which may occur due to malfunction or faulty installation, including, but not limited to failure by installer to over- or under-tighten fittings, housings, and/or push-style fittings, or improper installation of push-style fittings. Consumable items such as prefilters and membranes are not covered under the one year warranty.

To obtain service under this warranty, the defective system or components must be returned to SpectraPure with proof of purchase, installation date, failure date and supporting installation data. Any defective product to be returned to the factory must be sent freight prepaid. Documentation supporting the warranty claim and a Return Merchandise Authorization (RMA) number must be included. SpectraPure will not be liable for shipping damages due to the improper packaging of the returned equipment and all returned goods must also have adequate insurance coverage and a tracking number.

SpectraPure will not pay for loss or damage caused directly or indirectly by the presence, growth, proliferation, spread or any activity of "fungus", wet or dry rot or bacteria. Such loss or damage is excluded regardless of any other cause or event that contributes concurrently or in any sequence to the loss. We will not pay for loss or damage caused by or resulting from continuous or repeated seepage or leakage of water, or the presence or condensation of humidity, moisture or vapor, that occurs over a period of 14 days or more. "Fungus" and "fungi" mean any type or form of fungus or Mycota or any byproduct or type of infestation produced by such fungus or Mycota, including but not limited to, mold, mildew, mycotoxins, spores, scents or any biogenic aerosols.

SpectraPure will not be liable for any incidental or consequential damages, losses or expenses arising from installation, use, or any other causes. There are no expressed or implied warranties, including merchantability or fitness for a particular purpose, which extend beyond those warranties described or referred to above.

* **The one year limited warranty does not apply to consumable items, including but not limited to, filters and cartridges unless specifically stated above.**

TERMS AND CONDITIONS:

1. Shipping charges on units or parts submitted to our facility for repair or replacement must be borne by the registered purchaser. After repair or replacement, the factory will return the unit or part freight prepaid to the customer.
2. We assume no warranty liability in connection with our equipment other than as herein specified.
3. This warranty is in lieu of all other warranties expressed or implied, including warranties of fitness for a particular purpose.
4. We do not authorize any person or representative to assume for us any other obligation on the sale of our equipment. This is the exclusive remedy and liability for consequential damages under any and all warranties which are excluded to the extent exclusion is permitted by law.
5. Proof of original purchase date must accompany all warranty claims.
6. SpectraPure, Inc. Reserves the right to change prices without notice when necessary. All prices in the catalog are quoted in US dollars.
7. Claims for error in quantity or condition must be made within 10 days of receipt of material. SpectraPure, Inc. will not be responsible for any claimed shortages not reported within 10 days. Returns other than warranty claims may be subject to 20% restocking fee.
8. SpectraPure, Inc. cannot be held liable for damage or loss to a shipment by a freight carrier. Check shipment for damage before acceptance or note on freight bill subject to inspection for concealed damage. Consignee must file claim. SpectraPure, Inc. will offer as much assistance as possible.
9. A complete credit check is required prior to shipping on a Net 30 basis. In the interim period during which credit references are being evaluated, all orders must be prepaid until approved.
10. All returned checks [due to insufficient funds or closed accounts] will be subjected to a **\$35 penalty charge**.
11. Invoices on Net 30 accounts not paid within 30 days of shipment will be considered delinquent and will accrue Finance charges at the rate of 1.5% per month (18% per annum).