



XM SureConnect
Vehicle Installation Guide

FCC Statement

Please note that the power cable that has been supplied with your device is supplied with permanently attached ferrite beads. It is the responsibility of the user to use the power cable with the ferrite beads.

The user is cautioned that changes or modifications not expressly approved by XM Satellite Radio Inc. can void the user's authority to operate this device.

This device complies with Part 15 of the FCC Rules. Operation is subject to the following two conditions:

- 1 This device may not cause harmful interference.
- 2 This device must accept any interference received, including interference that may cause undesired operation.

This equipment has been tested and found to comply with the limits for a Class B digital device, pursuant to Part 15 of the FCC Rules. These limits are designed to provide reasonable protection against harmful interference in a residential installation.

This equipment generates, uses, and can radiate radio frequency energy and, if not installed and used in accordance with the installation instructions, may cause harmful interference to radio communications. However, there is no guarantee that interference will not occur in a particular installation. If this equipment does cause harmful interference to radio or television reception, which can be determined by turning the equipment off and on, the user is encouraged to try to correct the interference by one or more of the following measures:

- Reorient or relocate the receiving antenna of the affected receiver.
- Increase the separation between the XM equipment and the affected receiver.
- Connect the XM equipment into an outlet on a circuit different from that to which the affected receiver is connected.
- Consult the dealer or an experienced radio/TV technician for help



Warning: The FCC and FAA have not certified the receiver for use in any aircraft (neither portable nor permanent installation). Therefore, XM Satellite Radio cannot support this type of application or installation.

Table of Contents

What is SureConnect?	2
Getting Started	3
Installing with an Outside FM Antenna	6
Installing with an Inside FM Antenna	8
Finishing up	12
Uninstalling XM SureConnect	13

What is SureConnect?

The XM SureConnect connects your XM radio to your FM antenna. Here are the basic tasks you'll complete during installation:

- 1** Make sure your XM radio and XM antenna are properly installed in your vehicle.
- 2** Affix the XM SureConnect to the FM antenna.
- 3** Run the cable along the best path from the FM antenna to your XM radio.
- 4** Connect your XM antenna to the coupling module. Connect the XM SureConnect cable to the antenna jack on the XM car cradle.
- 5** Turn it on and tune it in.

This guide provides detailed step-by-step instructions for each of those tasks.

It usually takes about **30 minutes** to complete the installation. No special tools are needed.

Need help? Call Listener Care at 1-800-XM-RADIO (1-800-967-2346) or contact us at www.xmradio.com.

Getting Started

It's a good idea to familiarize yourself with the XM SureConnect before installing it.

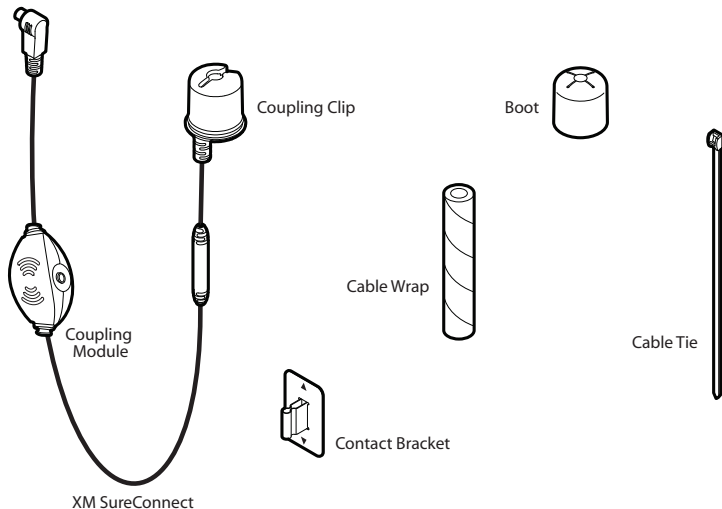

Getting Started

Locate your vehicle's FM antenna. It's mounted either on the inside or the outside of your vehicle.

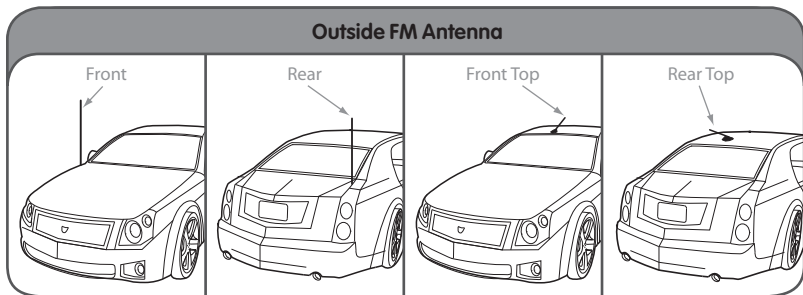

Getting Started

Inside (In-glass) FM Antenna

Front Window

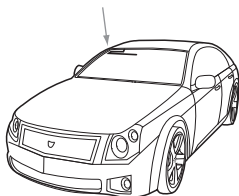

Rear Window

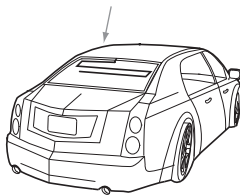

Side Window

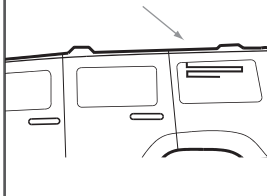

Installing with an Outside FM Antenna

NOTE: If your vehicle has an automatically retractable FM antenna or a custom FM antenna, you cannot use XM SureConnect. Use the FM Direct wired installation instead (sold separately).

- 1 Snap the coupling clip to the base of the FM antenna as shown.
- 2 Slide the boot down the FM antenna and press it into place so it covers the clip.
- 3 Use the cable wrap to secure the cable to the FM antenna.

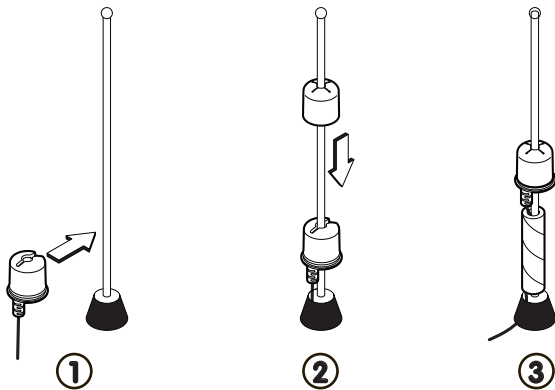

Installing with an Outside FM Antenna

4 Route the cable:

TIP! Make sure the door does not pinch the cable when closed.

TIP! Always cross the weather seals at the lowest point possible to reduce water leaks.

TIP! Always hand wash or use brushless or touch-free car washes to avoid damaging the XM SureConnect.

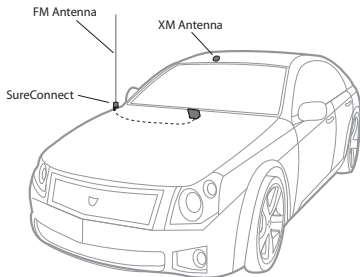

◀ If the FM antenna is on the front of the vehicle, route the cable across the weather seal near the bottom of the door. Then tuck the XM SureConnect cable into the door jam and up to the dash or under the carpet to the radio as shown.

▶ If the FM antenna is on the rear of the vehicle, route the cable into the trunk and through the existing wire channels to the rear passenger compartment. Tuck the XM SureConnect cable under the door jam trim or under the carpet to the radio as shown.

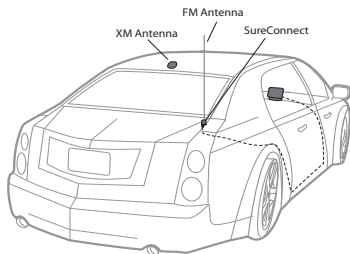

Installing with an Inside FM Antenna

- 1 Locate the FM antenna on the inside of your vehicle.

CAUTION: Do not attach the XM SureConnect to the rear defogger elements.

The antenna is usually in the upper 6 to 8 inches of the rear window with the defogger located below it. The antenna has open ends (as shown) while the defogger has closed ends. If you look beyond the tinting, you may be able to see the single contact point for the antenna (the defogger has two contacts on opposite sides).

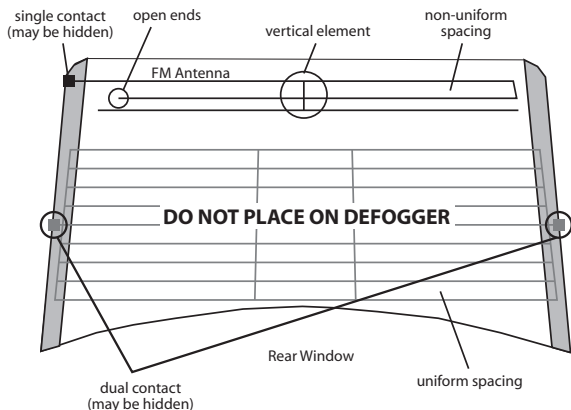

Installing with an Inside FM Antenna

- 2** Clean the glass where the FM antenna is located. Make sure the surface is warm (but not hot) and completely dry before continuing.

TIP! Use your vehicle's air conditioning or defogger to keep the surface dry during installation.

- 3** Position the contact bracket so the arrows align with the antenna. The arrows indicate the location of the contact strip underneath which must be in contact with the FM antenna.

The bracket may be mounted either vertically or horizontally, whichever position allows the most room to attach the coupling clip and run the cables without blocking the driver's view.

TIP! In some cases, it is easier to position the bracket on the inside of the glass while viewing it from outside the vehicle. Ask a friend to help.

- 4** When you have determined the proper position for the bracket, remove the liners from the adhesive pads and press it into place. Hold the bracket firmly against the glass for 10 to 15 seconds.

TIP! If the bracket is not in the proper position, you only have a few seconds to make an adjustment.

TIP! Adhesive reaches full strength after 24 hours.

Installing with an Inside FM Antenna

- 5 Attach the coupling clip to the bracket as shown.

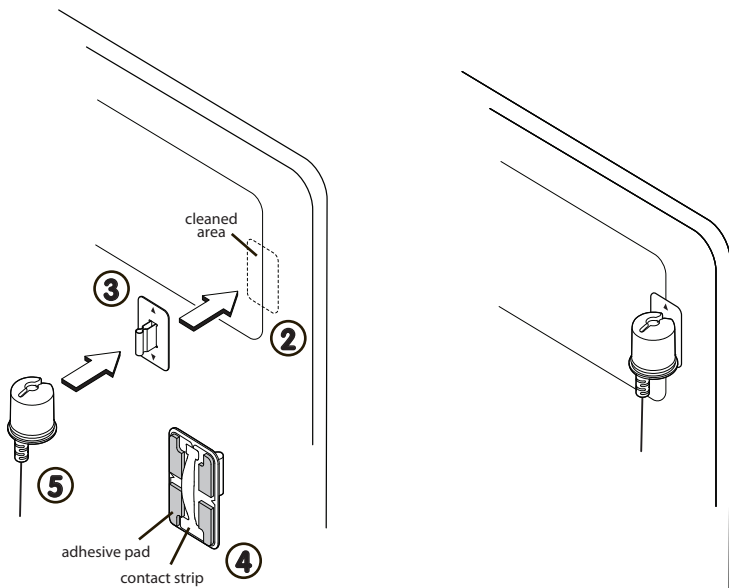

Note: Refer to instructions on previous page.

Installing with an Inside FM Antenna

- 6 Route the cable behind the trim and liners. Determine the best route for the cable.

CAUTION! Leave enough slack in the cable so it does not pull the contact strip away from the antenna.

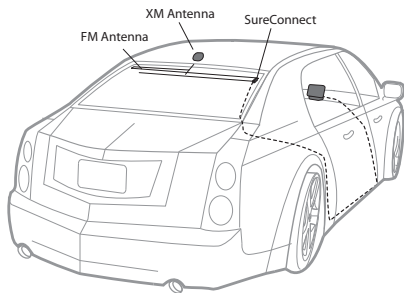

If the FM antenna is on the front window, the best route from the clip is usually along the windshield edge, down to the window liner, along the floor, and up to the dash. ▶

◀ If the FM antenna is on the rear window, the best route from the clip is usually along the window edge to the window liner. From the rear passenger compartment, tuck the cable under the carpet or door trim until you reach the dash.

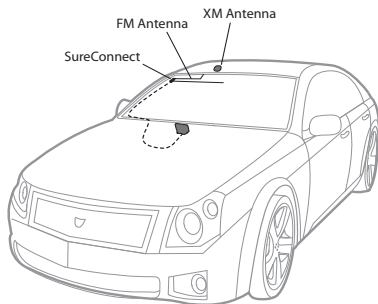

Finishing Up

- 1 Connect the XM SureConnect cable to the antenna jack on the XM car cradle. Connect the XM antenna to the coupling module on the SureConnect.
- 2 Make sure the XM radio is securely in the car cradle, then turn on the XM radio.
- 3 Follow the instructions in your XM radio's User Guide to find the best FM frequencies available in your area.

IMPORTANT! If you experience interference while using your AM radio, unplug the power to the XM radio to reduce interference..

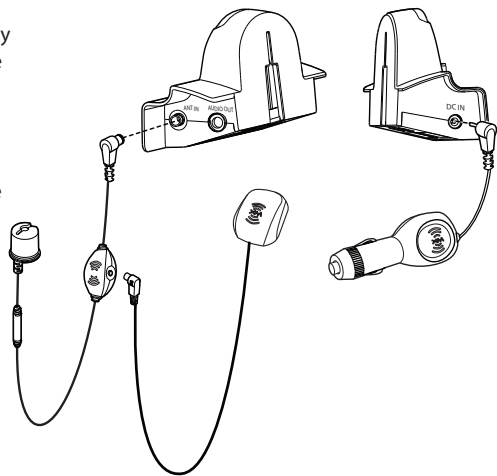

Note: Your car cradle may look different depending on which XM radio you are using.

Uninstalling XM SureConnect

If you need to remove the XM SureConnect:

- 1** Disconnect the cable from the antenna jack on the XM car cradle. Disconnect the XM antenna from the coupling module.
- 2** For an outside FM antenna, remove the wrap, if applicable. Remove the boot. Remove the coupling clip.
- 3** For an inside FM antenna, remove the coupling clip by lifting the end where the cable enters the clip.

TIP! If you squeeze the coupling clip in the middle, it may pinch the contact which makes removal more difficult.

- 4** Pull the cable out of the vehicle starting at the XM car cradle.



© 2007 XM Satellite Radio Inc.

The XM name and related logos are registered trademarks
of XM Satellite Radio Inc.