

# STREAM | jockey Satellite | Radio Products



## Quickstart Guide

## Model XTR1

To activate your Satellite Radio Receiver or for latest news and questions regarding SIRIUS® Satellite Radio service visit [sirius.com](http://sirius.com) or call 1-888-539-SIRIUS (7474).

For accessory & product information visit us at [www.getxact.com](http://www.getxact.com).



# KEEP MOVING

## 1. Unpack

Unpack your kit box.

## 2. Package Contents

Ensure that you have the following items:

- XACT Stream Jockey SIRIUS® Receiver
- Wireless Remote Control
- AAA Batteries (for the wireless remote control)
- User's Guide
- Power Adapter

## 3. Mount Satellite Radio

### a. At Home

Find an appropriate location near your stereo receiver.

### b. In Vehicle

Find an easily accessible location, typically the dashboard.

### c. FM Channel

Tune your radio to the appropriate FM channel. See page 22 in the instruction manual for FM transmitter set-up.

## 4. Activate Subscription



### a. Online

Visit [sirius.com](http://sirius.com) and click activate, follow the on-screen instructions.

# KEEP LISTENING

## b. By Phone

Call 1-866-845-7474 and a representative will help you activate your SIRIUS® Satellite Radio Service.

## 5. Note Your ID Number

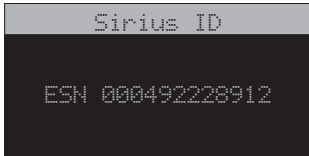

Press the <sup>^</sup>CH or <sup>CH</sup>√ button; select SIRIUS® ID; your device's 12-digit ID Number (ESN) will be displayed on the screen.

## 6. Tune Entertainment

### a. By Category

1. Press the CAT button to scroll through music and entertainment categories.

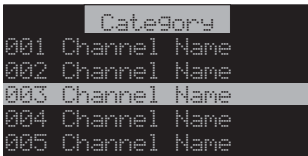

### b. By Channel

Press the CH button to search for channels.

## 7. Confirm Settings

Press the SELECT button to confirm the setting.

# IF YOU HAVE PURCHASED A VEHICLE KIT

## INSTALLATION

1.

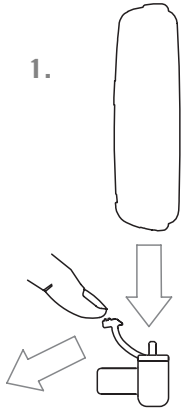

THUMB LATCH  
PULLED BACK...

2.

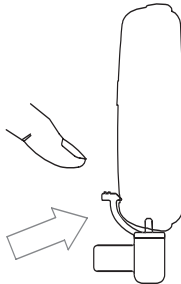

...THUMB LATCH RELEASED,  
BRACKET LATCH CLIPS RECEIVER  
SECURELY IN PLACE

3.

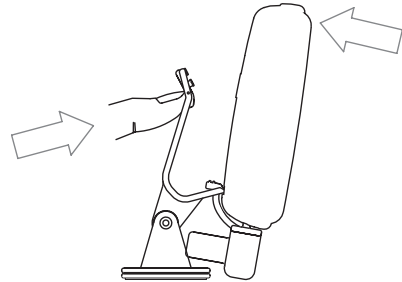

PLACE CAR BASE HOOKS  
INTO LOCKING SLOT & PUSH  
THUMB TAB IN...

4.

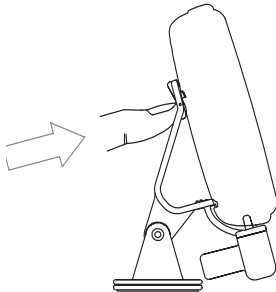

...ROTATE RECEIVER UNIT BACKWARDS  
TO ENGAGE HOOKS

5.

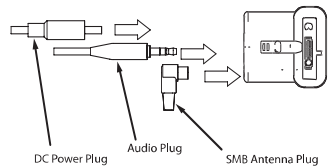
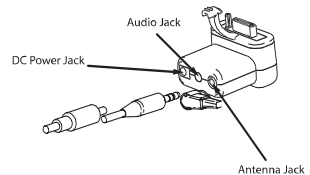

# IF YOU HAVE PURCHASED A HOME KIT

## INSTALLATION

1.

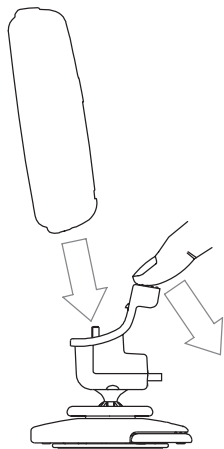

THUMB LATCH  
PULLED BACK...

2.

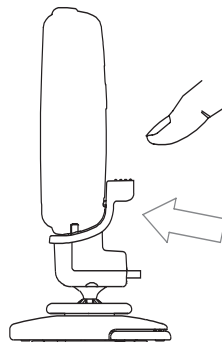

...THUMB LATCH RELEASED,  
BRACKET LATCH CLIPS RECEIVER  
SECURELY IN PLACE

3.

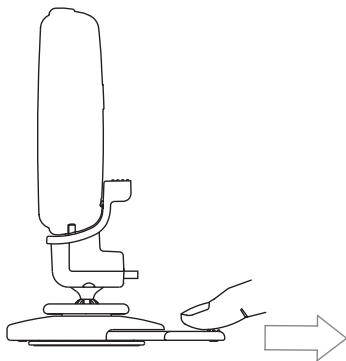

FOR HOME DESKTOP  
APPLICATION, USER PULLS OUT  
FEET USING THUMB GRIP

4.

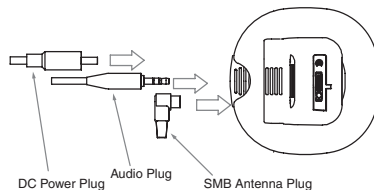
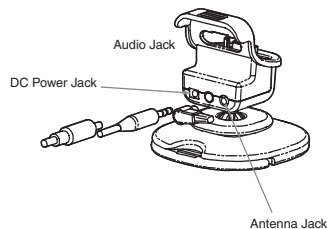

# IF YOU HAVE PURCHASED A UNIVERSAL KIT

## INSTALLATION

1.



MOUNT TO VEHICLE  
DASH BOARD VIA  
ADHESIVE TAPE

2.

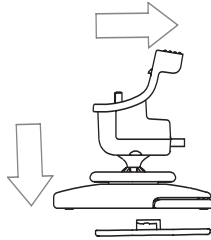

PLACE CRADLE OVER  
MOUNT PLATE SLIDE BACK  
TO LOCK FOR VEHICLE  
INSTALLATION

3.

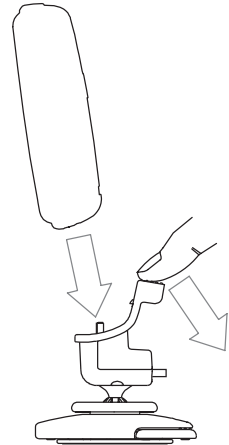

THUMB LATCH  
PULLED BACK...

4.

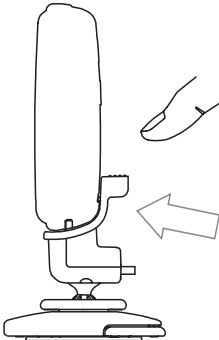

...THUMB LATCH RELEASED,  
BRACKET LATCH CLIPS RECEIVER  
SECURELY IN PLACE

5.

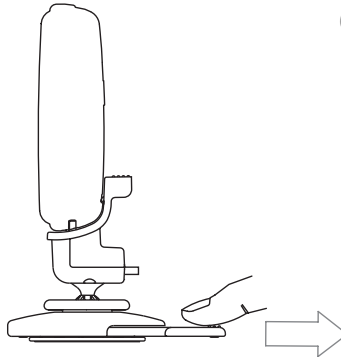

FOR HOME DESKTOP  
APPLICATION, USER PULLS OUT  
FEET USING THUMB GRIP

6.

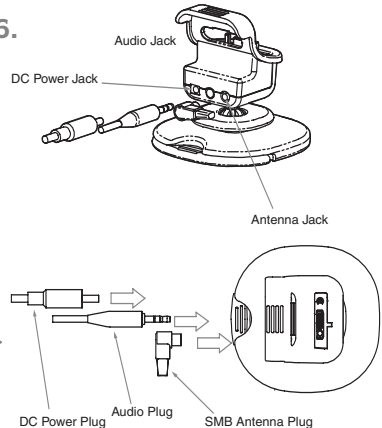

# IF YOU HAVE PURCHASED A BOOMBOX KIT

## INSTALLATION

1. PUSH RECEIVER ONTO CONNECTOR

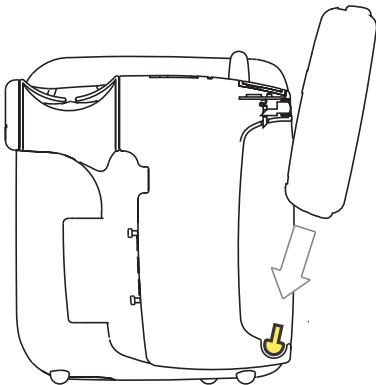

2. ROTATE RECEIVER AND CONNECTOR INTO BOOMBOX

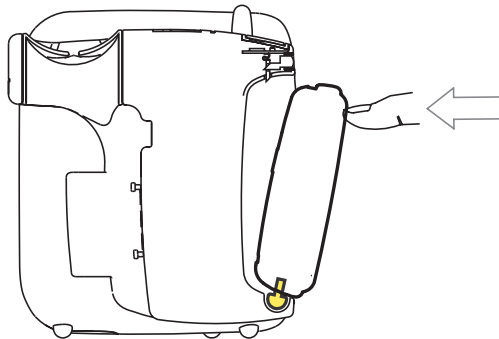

3. LATCH BOOMBOX LOCKS RECEIVER IN PLACE

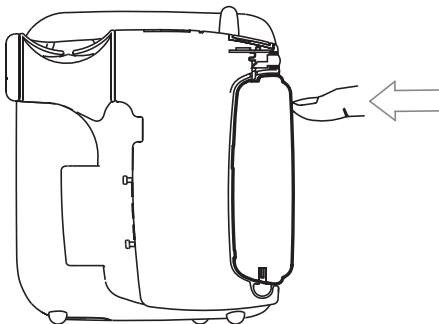

To activate your Satellite Radio Receiver or for latest news and questions regarding SIRIUS® Satellite Radio service visit [sirius.com](http://sirius.com) or call 1-888-539-SIRIUS (7474).



Call Toll Free 1-866-466-XACT (9228)  
or Visit our Website:

[www.getxact.com](http://www.getxact.com)