

# Installation guide

## WALLS

### Installation outline

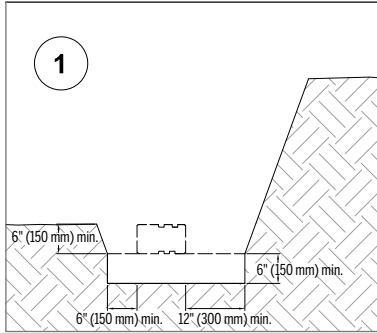

#### 01 EXCAVATION

- Check the location of existing structures and utilities before starting the excavation.
- Dig out a trench. Its depth should be calculated according to the thickness of the leveling pad and the burial depth of the wall.
- Plan for a thickness of at least 6" (150 mm) for the leveling pad and consider that at least 10% of the height of the wall should be buried in the ground. In all cases, the wall must be buried no less than 6" (150 mm) deep.
- In determining the width of the trench, allow for a space of at least 6" (150 mm) at the front of the wall and 12" (300 mm) at the back for drainage fill. Compact and level the excavation base.

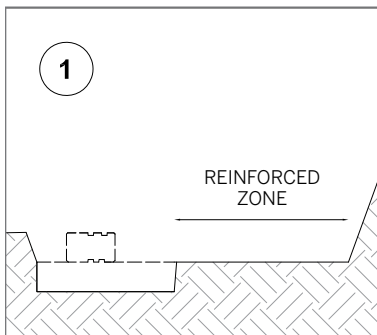

#### FOR GEOGRID REINFORCED RETAINING WALLS

The excavation must also take into account the length of geogrid.

#### 02 FOUNDATION

- Cover the base and back of the trench with a geotextile. Extend the geotextile towards the back of the excavation and eventually above the drainage fill once it is in place close to the top of the wall.
- Next, spread the 0-3/4" (0-20 mm) stone in the trench and compact using a vibratory plate or jumping jack, ensuring that the surface is level. The compacted leveling pad must be at least 6" (150 mm) thick.

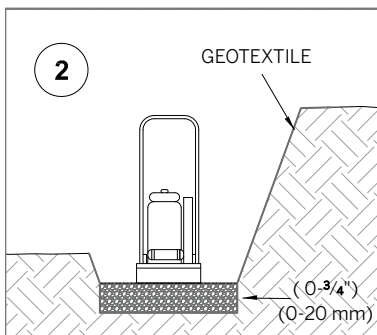

#### NOTE FOR STEPPED FOUNDATION

A wall built on an incline requires stepped foundations. For steep inclines, several steps may be required. Construction should start at the lowest level. Each of the steps must follow a level horizontal path and the vertical distance separating the successive steps must equal the height of a block.

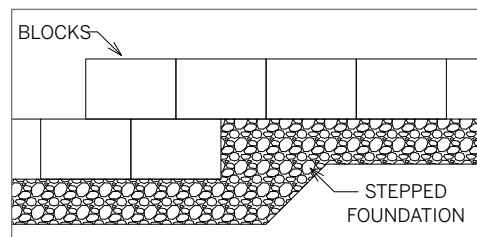

# Installation guide

## WALLS

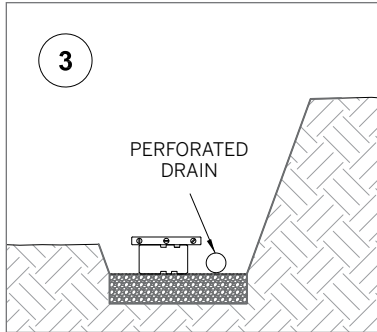

### 03 BUILDING THE FIRST COURSE

- A. Using blocks of the same height, place the first course on the compacted leveling pad according to the predetermined layout. Check the alignment and leveling in all directions and make sure that all the blocks are in full contact with the leveling pad and properly supported.
- B. Place the exposed surfaces of the blocks side by side. There must be no space between the exposed faces of adjacent blocks.
- C. At the back of the wall and on the compacted leveling pad, lay a 4" (100 mm) diameter perforated drain. Connect this drain to the existing drainage system so that it clears the water accumulated behind the wall.

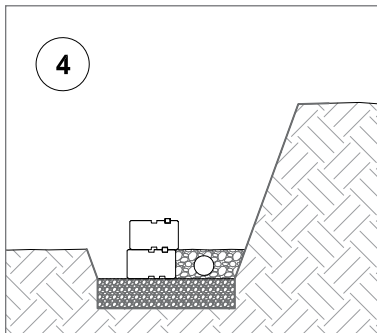

### 04 BACKFILLING

Backfill at the rear of the wall and the space between the back of the blocks with  $\frac{3}{4}$ " (20 mm) clean stone. Level and settle the clean stone. Any cavities in the blocks must also be filled with clean stone.

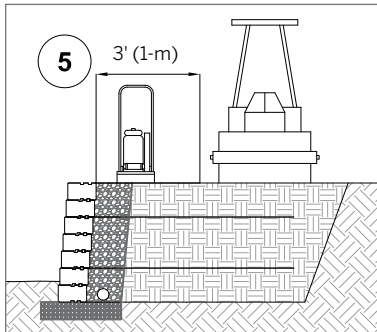

### 05 SUBSEQUENT COURSES

- A. Clean the top of each block before laying the next course. Depending on the type of block, install the connectors on the extremity of each block.
- B. Lay the subsequent courses, backfilling at the rear of the wall every 8" (200 mm maximum, using the same method outlined in step 4.
- C. Make sure the subsequent courses are laid such that the vertical seams are aligned with the blocks below.



### FOR GEOGRID REINFORCED RETAINING WALLS

Where geogrids are to be used, cover the clean stone with a geotextile. Select the geogrid according to the type, level and appropriate length. Position the geogrid according to the main reinforcement direction perpendicular to the wall. The geogrid must be continuous all along its embedment length. Splicing of the geogrid in the main reinforcement direction is not permitted. The geogrid must be installed horizontally over the compacted backfill and the previous course of blocks. Fix the connectors on the geogrid and lay the next course of blocks. Pull on the back of the geogrid and maintain its tension by stakes or pins. Repeat with a new section of geotextile and place the reinforced backfill directly behind the drainage fill. Fill and compact up to the level of the blocks.

Heavy equipment must not be used less than 3' (1-m) behind the blocks. Construction equipment must not drive directly over the geogrid.

Repeat the various installation steps.

### 06 FINISHING

Position the course of coping stones (if applicable) or the final course of blocks to complete the wall. The coping stones or final course of blocks must be fixed to the subjacent blocks using concrete adhesive and there must be no space between the blocks.

# Installation guide

## WALLS

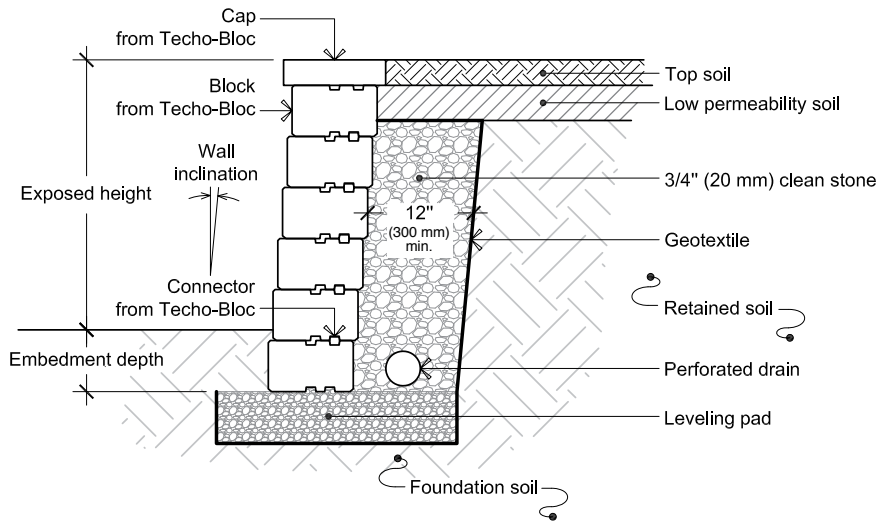

### WALL INSTALLATION – GRAVITY WALL

Typical cross section

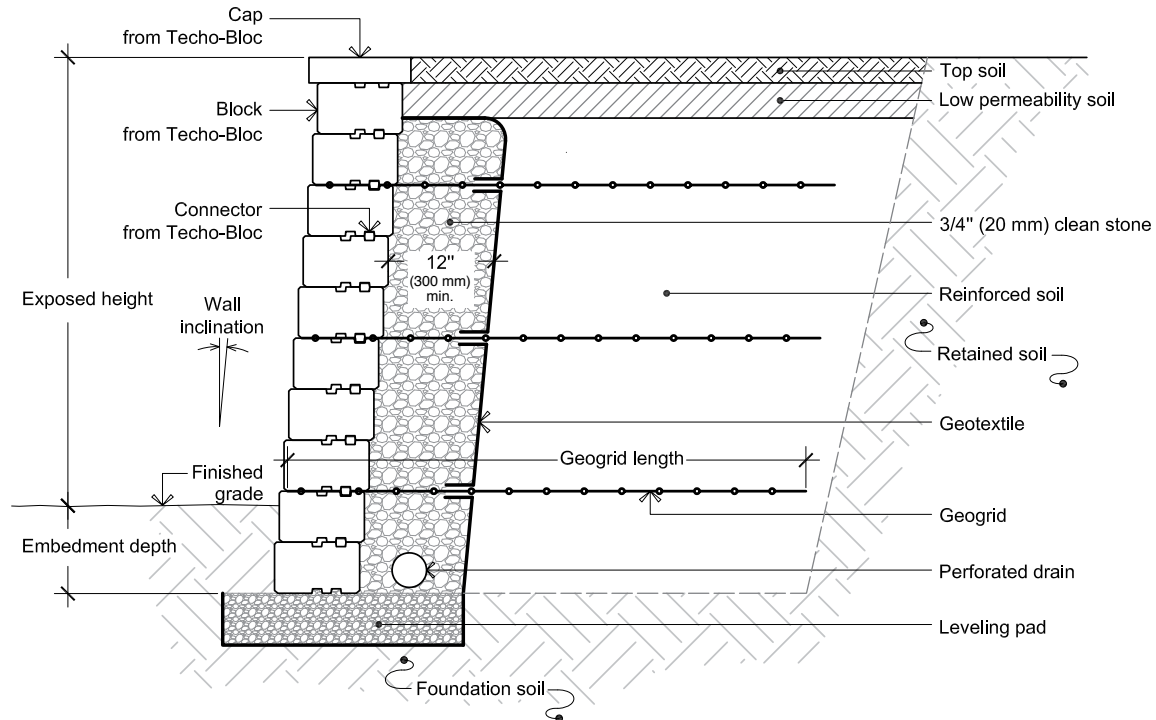

### WALL INSTALLATION – GEOGRID REINFORCED WALL

Typical cross section



### FOR GEOGRID REINFORCED RETAINING WALLS

For more information, refer to the Wall Design Charts on page 159.

# Installation guide

## MONUMENTAL WALL

### General note

Segmental retaining wall blocks are enormously popular today, so much so that a 24' (7-m) high wall supporting a 1,000 psf (48 kPa) load is no longer considered to be a reinforced concrete application. Techo-Bloc's Monumental is granite-like in appearance and suits high wall applications very well. The base block and regular unit allow versatile applications and offer superior structural strength. The units have tapered sidewalls, allowing interior and exterior curves. When incorporating the built-in 11-degree batter under the right soil conditions, walls as high as 10' (3-m) can be achieved without the use of geogrid. The appearance of the Monumental will enhance any environment and soften the image of an industrial facility.



Monumental requires mechanical installation, greatly reducing installation time and avoiding manual labor. Lifting the Monumental units with excavation equipment already on-site for earthwork reduces crew downtime. With its large profile when placed in a running bond stacking pattern, the Monumental brings back the natural carved beauty of a quarried stone.



### IMPORTANT

The technical guidelines provided by Techo-Bloc are consistent with industry standards in general and NCMA design methodology and guidelines. Global stability of the wall being built should be addressed by the site designer or project geotechnical engineer. The correct application of any design is the responsibility of the user and should be verified by an engineer. A local wall designer should engineer all retaining walls for site-specific conditions.

For safety during construction a safety rail or net must be installed securely onto the Monumental wall for the fall protection of the wall installers. When building a Monumental wall over five feet all persons working around the perimeter of the wall must be securely harnessed.

It should be noted that all suggestions and recommendations by Techo-Bloc are based on general industry instructions, and should not be interpreted as constituting an engineer's specifications.

## Installation outline

### 01 INSPECTION AND PREPARATION

- A. Plan and execute the project according to the drawings and specifications prepared by the engineer.
- B. Notify the engineer of site conditions that may affect wall performance, soil conditions observed other than those assumed, or other conditions that may require a reevaluation of the wall design.
- C. Verify the location of existing structures and utilities prior to excavation.
- D. Ensure surrounding structures and buried utilities are protected from the effects of wall excavation. Embankment support, if required, including stability of the excavation area, are the responsibility of the contractor.

# Installation guide

## MONUMENTAL WALL

### 02 EXCAVATION AND FOUNDATION PREPARATION

- A. Excavate the native soil to the lines and grades specified on the site grading plans. After the excavation, the native soil must be inspected by an engineer in order to ensure that the soil's bearing capacity is in keeping with specifications. Use care in excavating to prevent disturbance of the sub-grade beyond the lines specified by the engineer.
- B. Beginning at the lowest elevation point of the Monumental wall, excavate a trench at least 40" (1-m) wide for the regular Monumental unit or 54" (1.35 m) wide for the Monumental Base unit down the length of the wall that will accommodate at least all of the leveling pad and 8" minimum (200 mm) of block embedment. Fill over excavated areas with suitable compacted backfill, as recommended by the engineer.

### 03 LEVELING PAD PREPARATION

- A. Before laying the leveling pad material, it is recommended that you install a geotextile membrane along the bottom and banks of the trench to prevent the contamination of soil and leveling pad.
- B. Place leveling pad material to the depths and widths shown on specifications.
- C. Extend the leveling pad laterally at least 7" (175 mm) in front and 12" (300 mm) behind the lowermost Monumental retaining wall unit.
- D. The leveling pad should have a minimum thickness of 8" (200 mm) and should be installed in 6" (150 mm) thick layers and compacted to 98 percent Standard Proctor or according to project specifications. The leveling pad should be composed of 0-3/4" (0-20 mm) granular material.
- E. Compact granular leveling pad material to provide a level, hard surface on which to place the first course of Monumental units.
- F. Prepare leveling pad material to ensure complete contact with bottom of all Monumental retaining wall base units installed. Gaps are not tolerated.



GEOTEXTILE AND COMPACTION



LEVELING PAD AFTER COMPACTION



LEVELING EACH UNIT

### 04 WALL CONSTRUCTION

- A. The Monumental Wall unit has a unique lifting system. Techo-Bloc has developed a driving anchor for lifting and positioning Monumental. Attach a chain or sling securely to the Monumental-lifting anchor provided by Techo-Bloc and insert the Monumental-lifting anchor into the opening on the top of the block. Turn the Monumental-lifting anchor 90-degrees to lock the Monumental into place. Lift the Monumental up securely and place into the desired area. Stand clear of the Monumental while it is suspended in the air for safety reasons.



- B. Select the "U" insert for building an 11° batter wall, or the "Z" insert to build a near vertical wall. Make sure you inform your local dealer when building a vertical wall, since only the "U" insert is standard.

# Installation guide

## MONUMENTAL WALL



INSTALLING THE FIRST COURSE



CLEANING DEBRIS OFF UNITS

- C. Install the first course of base block on the prepared leveling pad. Make sure all units are level and aligned correctly. Use a string line measured from the back of the block to set your alignment.
- D. Place the drainage aggregate in 8" (200 mm) lift and a minimum 12" (300 mm) directly behind and in the Monumental wall units. Fill in the voids of the Monumental units with drainage aggregate. Cap the backfill and drainage aggregate zone with 8" (200 mm) of impervious material.
- E. Install a perforated PVC drainage pipe 4" (100 mm) in diameter. Slope the main collection drainage pipe, located just behind the Monumental units  $\frac{1}{4}$ " per ft (6 mm per 300 mm), this will give you a 2% slope and provide gravity flow to the daylighted areas. You can also connect the drainage pipe to a storm sewer system at 50' (15-m) maximum interval.



INSTALLING THE FIRST COURSE



- F. For inclined ( $11^\circ$ ) walls, you will use the "U" connector and a "Z" connector for near vertical walls. Place the connectors as recommended by the manufacturer. When geogrid is required, the insert must be installed above the geogrid so that it gets wedged into the slots.
- G. Check each course for level and alignment. Prior to adding successive courses, the top of each Monumental needs to be cleaned free of foreign material.
- H. Repeat this process for each successive course. Large compaction or construction equipment should be kept more than 3' (1-m) away from the back of the wall. This 3' (1-m) area should be compacted with a vibrating plate compactor.

### 05 MULTI-LEVEL OR STEPPED BASE WALL

When building a multi-level Monumental wall, each level must be constructed according to rigorous standards.

- A. Separate the elevation into individual landings as per engineer's specifications and consistent with the height of Monumental.
- B. When calculating the landing, take into account the drop value of the height of the Monumental wall.
- C. Step the units accordingly in order to maintain the required embedment.
- D. Maintain running bond joint pattern so that vertical joints are staggered between courses.
- E. Use the Monumental regular to maximize bridging between steps.

# Installation guide

## MONUMENTAL WALL

### 06 INSTALLATION OF GEOGRID (IF REQUIRED)

Geogrids should be installed according to manufacturers' recommendations.

- A. Orient the geogrid with the highest strength axis perpendicular to the wall face.
- B. Prior to geogrid placement, pour the backfill and compact to the elevation of the top of the wall units according to the degree of compacting specified by the engineer. For compacting immediately behind the wall face, see section 4-H.
- C. Install appropriate geogrid strength at the proper elevations and to the lengths specified on the wall design.
- D. Lay the geogrid horizontally on top of the Monumental wall units and the compacted backfill soils. Place the geogrid within two inches of the face of the Monumental wall units. Install the inserts and lay the next course of Monumental wall units on top of the geogrid.



INSTALLING GEOGRID HORIZONTALLY



TENSIONING GEOGRID

- E. The geogrid must be pulled taut and free of wrinkles before backfilling the retaining wall. In order to do so, pull the geogrid hand-taut and secure the ends with staples, stakes, or by hand tensioning the geogrid until it is covered by 6" (150 mm) of loose fill.
- F. The geogrid must be continuous throughout its embedment lengths. Splices in the geogrid strength direction are not tolerated.

### 07 BACKFILL PLACEMENT

- A. Pour backfill at the back of the wall and compact to minimize any geogrid relaxation.
- B. Place fill within the reinforced zone and compact in lifts not exceeding 6" (150 mm) (loose thickness) where hand-operated compaction equipment is used, and not exceeding 10" (250 mm) (loose thickness) where heavy, self-propelled compaction equipment is used.

**Note:** Only lightweight hand-operated compaction equipment is permitted to operate within less than 3' (1-m) of the back of the Monumental wall units. If the specified compaction level cannot be achieved within 3' (1-m) of the back of the Monumental wall units, replace the reinforced soil in this zone with drainage aggregate material.

- C. Minimum compaction requirements for fill placed in the reinforced zone:

Walls less than 15' (4.5 m) high – Compact to 95% of the soil's Standard Proctor maximum dry density (ASTM D698) or modified Proctor (ASTM D1557) for the entire wall height, as indicated by the engineer.

Walls over 15' (4.5 m) high **but not more than 30' (9-m) high** – Change compaction requirements to 98% of the soil's Standard Proctor or modified Proctor (ASTM D1557) maximum dry density (ASTM D698) for the entire height up to 30' (9-m), as indicated by the engineer.

Walls over 30' (9-m) high – Change compaction requirements to 100% of the soil's Standard Proctor maximum dry density (ASTM D698) or modified Proctor (ASTM D1557) for the entire wall height, as indicated by the engineer.

- D. Utility trench backfill: Compact utility trench backfill in or below the reinforced soil zone to the same requirements as the wall height, as indicated by the engineer.

**Note:** Utilities must be properly designed (engineered) to withstand all forces from the Monumental wall units, reinforced soil mass, and surcharge load, if any.

- E. Moisture content: Soil shall be moisture conditioned before placement to within two percentage points of the optimum moisture content for all wall heights.
- F. These specifications may be changed based on recommendations by the engineer.
- G. At the end of each day's operation, slope the last level of compacted backfill to direct surface water runoff away from the wall face. The general/earthwork contractor is responsible for ensuring that the site drainage during construction is directed away from the Monumental wall until permanent site drainage features are operational.

# Installation guide

## MONUMENTAL WALL

### 08 CAP UNIT INSTALLATION

- A. Apply a concrete adhesive to the top of the cleaned surface of the unit below and place the Monumental cap unit into the desired position.
- B. If necessary, cut the Monumental cap units to obtain the proper fit.
- C. Backfill and compact to top of the Monumental cap unit.

### 09 CURVE / CORNER INSTALLATION

#### CONVEX AND CONCAVE CURVES

- A. Place the Monumental units on the leveling pad such that there are no gaps between the two faces of the Monumental Units used.
- B. When building multiple courses on a curve, begin installation by placing a Monumental in the middle of the curve, centering on two Monumental blocks directly below it.
- C. Place the Monumental units side by side from the center block outward along the curve.
- D. Place the Monumental caps and measure the distance of the gap between the caps. Using this measurement, cut the Monumental cap so it is parallel with the adjacent Monumental cap unit.
- E. Slide the Monumental cap in its place so that it is flush with the adjacent Monumental cap unit.
- F. The minimal radius obtained with the Monumental is 17' (5.2 m).

#### OUTSIDE 90-DEGREE CORNER

- A. When building a Monumental wall with an outside 90-degree corner, it is recommended that the construction of the Monumental wall start at the corner desired and continue working away from this point in both directions. The placement of the Monumental corner blocks will allow a normal batter consistency in both wall directions.
- B. One standard Monumental corner block will be used at the corner of each course of the wall. The Monumental corner blocks will overlap each other at the corner, coming together in a "zipper fashion". The Monumental corner blocks should be glued at the corner where they overlap with a concrete adhesive.

#### INSIDE 90-DEGREE CORNER

When building a Monumental wall with an inside 90-degree corner, it is recommended that you start each subsequent course at the corner and lay out block from that corner.



#### FENCING / GUARDRAILS

Guardrails and handrails should be installed behind the Monumental in the soil. It is possible to install fencing at the top of the Monumental wall by core drilling into the top of the Monumental. Follow the instructions of the railing manufacturer and wall design engineer. It is, however, recommended that if the fencing is to be installed at the top of the wall, the top two rows of Monumental should be glued to the rows of Monumental Blok beneath it with a concrete adhesive.



# Installation guide

## MONUMENTAL WALL

### 10 GEOGRID INSTALLATION IN A CURVE / CORNER APPLICATION

#### CONVEX CURVE

- A. Place geogrid perpendicular to wall face at center of geogrid. Trim the geogrid to fit onto the curved face of the wall and place the geogrid with the curve to follow its contour.
- B. Overlapping layers of geogrid on a convex curve requires a minimum of 3" (75 mm) of soil between them for proper anchoring. Repeat for successive specified geogrid layers.
- C. Install the geogrid to the length specified by the wall designer.

#### CONCAVE CURVE

- A. The strength direction of the geogrid must be placed perpendicular to the wall face. Align the cut geogrid sections so that they follow the contour of the concave curve. Geogrid layers should not overlap. A wall designer should specify the desired length of geogrid.
- B. The next successive geogrid layer must be placed to cover the area of reinforced soil below. This will maximize lapping. Repeat these steps for successive specified geogrid layers.

#### OUTSIDE 90-DEGREE CORNER

To insure proper anchorage, it is important that geogrid layers that overlap on an outside 90-degree corner are covered by 3" (75 mm) of soil. Repeat for successive specified geogrid layers.

### 11 FINAL TOUCH

When prelaying the last course of Monumental and capstones, overlap the geotextile towards the wall, totally covering the 0-<sup>3</sup>/<sub>4</sub>" (0-20 mm) clear crushed stone (drainage material). Use impervious soil to cover the drainage stone and remainder of the back fill. The soil cap must be manually compacted and it is recommended that a swale be created in order to channel water off the top of the wall. For all other applications, such as concrete or asphalt situated behind the wall, it is a requirement that you compact 2' (600 mm) behind the Monumental wall with a lightweight compacting plate at 6" (150 mm) intervals.

# Wall Design Charts USA

## Summary of Characteristics | Wall without geogrid

Type of wall		Maximum Height <sup>1</sup> (including embedment)			Wall inclination degrees	Setback		Minimum wall radius <sup>3</sup>	
		Number of rows	Meters	Ft		mm	Inches	Meters	Ft
Baltimore 90 mm <sup>2</sup>	inclined	10	0.90	2.95	4.4	7	9/32	2.3	7.5
	vertical	8	0.72	2.36	0	0	0	2.3	7.5
Baltimore 180 mm <sup>2</sup>	inclined	5	0.90	2.95	4.4	14	9/16	2.3	7.5
	vertical	4	0.72	2.36	0	0	0	2.3	7.5
Borealis	vertical	4	0.61	2.00	0	0	0	-	-
Graphix	variable	8	0.60	1.97	variable			-	-
Manchester	vertical	5	0.50	1.64	0	0	0	-	-
Mini-Creta 3" <sup>2</sup>	inclined	12	0.90	2.95	5	7	9/32	2.1	7
	vertical	10	0.75	2.46	0	0	0	2.1	7
Mini-Creta 6" <sup>2</sup>	inclined	6	0.90	2.95	5	14	9/16	2.1	7
	vertical	5	0.75	2.46	0	0	0	2.1	7
Prescott 2.25" <sup>2</sup>	inclined	16	0.91	3.00	4.5	4.5	3/16	1.6	5.2
	vertical	12	0.69	2.25	0	0	0	1.6	5.2
Prescott 4.5" <sup>2</sup>	inclined	8	0.91	3.00	4.5	9	11/32	1.6	5.2
	vertical	6	0.69	2.25	0	0	0	1.6	5.2
Raffinato 90 mm <sup>2</sup>	incliné	10	0.90	2.95	4.4	7	9/32	2.6	8.5
	vertical	8	0.72	2.36	0	0	0	2.6	8.5
Raffinato 180 mm <sup>2</sup>	incliné	5	0.90	2.95	4.4	14	9/16	2.6	8.5
	vertical	4	0.72	2.36	0	0	0	2.6	8.5
Röcka	vertical	4	0.61	2.00	0	0	0	-	-
Semma <sup>2</sup>	inclined	7	1.07	3.50	7.6	20	25/32	2.1	7
	vertical	5	0.76	2.49	0	0	0	2.1	7
Suprema <sup>2</sup>	inclined	5	1.02	3.35	4.5	16	5/8	1.8	6
	vertical	4	0.81	2.66	0	0	0	1.8	6
Monumental (regular unit) <sup>2</sup>		Refer to page 181			11	76	3	5.2	17

<sup>1</sup> The maximum wall height recommended in this table is based on the following conditions:

- The retained soil type considered is gravel with an internal friction angle of at least 36°.
- There is no surcharge load applied on top of the wall.
- There is no slope on top of the wall.
- An adequate drainage system is provided at the back of the wall.

<sup>2</sup> These products can be used with geogrid reinforcement to build higher (inclined) walls or walls subject to different conditions than those mentioned.

Contact your Techo-Bloc representative for more details or fill out our Preliminary Design Assistance form (see page 161).

<sup>3</sup> Minimum wall radius is measured at the front face of the wall. It corresponds to the lowest course in an internal curve and to the uppermost course in an external curve (see page 191).



# Wall design Charts

## PRELIMINARY DESIGN ASSISTANCE

Techo-Bloc can help you in your preliminary design of retaining walls which fall outside the bounds of the Height Charts. However, preliminary design should only be used to assess the suitability of a wall system to a specific project or for estimating budget costs. For final construction designs, please contact a qualified engineer in your area.

### 1. TECHO-BLOC

Representative \_\_\_\_\_ Date \_\_\_\_\_

### 2. GENERAL PROJECT INFORMATION

Enterprise \_\_\_\_\_ Are you a Techo-Pro?  Yes  No \_\_\_\_\_

Address \_\_\_\_\_ City \_\_\_\_\_

State / Province \_\_\_\_\_ Postal Code \_\_\_\_\_ Contact \_\_\_\_\_

Telephone \_\_\_\_\_ Fax \_\_\_\_\_

E-mail \_\_\_\_\_ Information date required \_\_\_\_\_

Prepared by \_\_\_\_\_ Project title \_\_\_\_\_

Address \_\_\_\_\_ City \_\_\_\_\_

State / Province \_\_\_\_\_ Postal Code \_\_\_\_\_

Type (industrial, commercial, institutional, residential) \_\_\_\_\_ Units (metric or imperial) \_\_\_\_\_

### 3. GENERAL INFORMATION ON WALLS

Block product \_\_\_\_\_ T-B Distributor \_\_\_\_\_

Maximum wall height (above-ground) \_\_\_\_\_ Wall length \_\_\_\_\_

Tiered wall  No  Yes      LOWER WALL      Distance between      UPPER WALL  
Height \_\_\_\_\_

*If a grading plan is available, include it with this request (drawings should indicate the location of the wall, grade lines and loads). Otherwise, clear and detailed sketches must be provided.*

### 4. SLOPE INFORMATION

*Indicate the angle or the ratio. For example, for a 1-unit vertical difference in level on a 3-unit horizontal plan, write 1V:3H.*

Slope at BASE of wall?  No  Yes \_\_\_\_\_ (angle or ratio)

Slope ABOVE wall?  No  Yes \_\_\_\_\_ (angle or ratio)

### 5. SURCHARGE ABOVE WALL

TYPE OF SURCHARGE (LOAD)	WALL DISTANCE	Reinforced soil _____	Retained soil _____
<input type="checkbox"/> Route	_____	<input type="checkbox"/> Clean sand and gravel	
<input type="checkbox"/> Parking / alley for heavy vehicles	_____	<input type="checkbox"/> Silty gravel	
<input type="checkbox"/> Parking / alley for light vehicles	_____	<input type="checkbox"/> Clayey gravel	
<input type="checkbox"/> Swimming pool	_____	<input type="checkbox"/> Silty sand	
<input type="checkbox"/> Paved surface (patio)	_____	<input type="checkbox"/> Clayey sand	
<input type="checkbox"/> Lawn / grass	_____	<input type="checkbox"/> Silt and clay	
<input type="checkbox"/> Other _____		<input type="checkbox"/> Other _____	

### 6. TYPE OF SOIL

*If a soil report is available, attach it to this request.*

Return this request by one of the following methods: **Fax** 450 656-1983 | **Email** walls@techo-bloc.com  
**Mail** Techo-Bloc - 5255 Albert-Millichamp Street, Saint-Hubert, QC J3Y 8Z8

# Installation guide

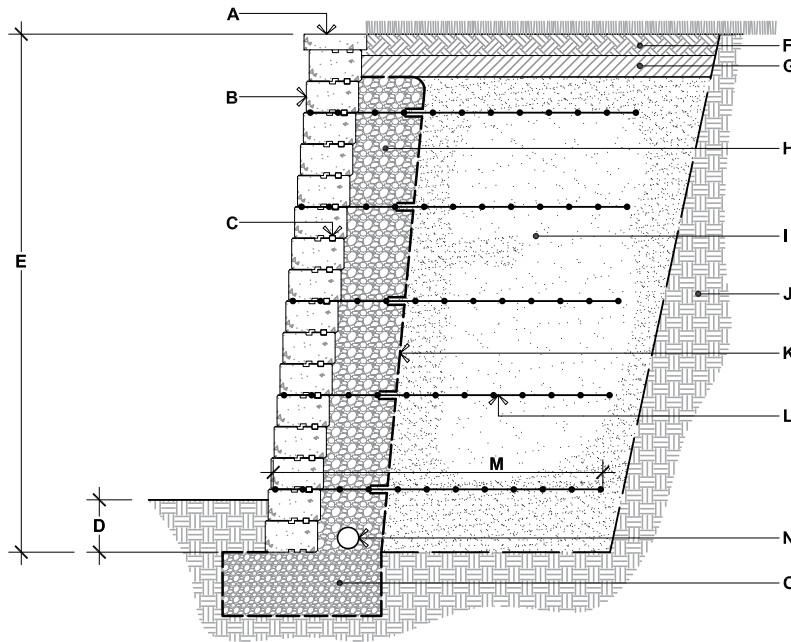

- A. CAP UNIT FROM TECO-BLOC
- B. TECO-BLOC WALL UNIT
- C. CONNECTOR
- D. EMBEDMENT DEPTH LARGEST: 6" (150 mm) OR 10% OF THE HEIGHT ABOVE GROUND MIN.
- E. TOTAL HEIGHT (VARIABLE)
- F. TOPSOIL
- G. LOW PERMEABILITY SOIL
- H. CLEAN STONE  $\frac{3}{4}$ " (20 mm) PLACED 12" (300 mm) MIN. WIDE BEHIND WALL
- I. REINFORCED SOIL COMPACTED
- J. RETAINED SOIL
- K. GEOTEXTILE
- L. GEOGRID
- M. GEOGRID LENGTH
- N. PERFORATED DRAIN 4" (100 mm) Dia.
- O. LEVELING PAD CRUSHED STONE  $0\text{-}\frac{3}{4}$ " (0-20 mm) COMPACTED

## WALL INSTALLATION - GEOGRID REINFORCED WALL

Typical cross section

The information contained in the design charts is supplied for information purposes only and as such should only be used for preliminary designs. A qualified engineer should be consulted for the final design to be used for construction. TECO-BLOC and its predecessors, successors, beneficiaries, employees, associates, administrators and insurers can not under any circumstances be held liable for the incorrect use of information contained in the design charts.

The design charts show the number, position and length of the geogrids for a Techo-Bloc inclined wall based on the height of the wall, soil type and the load conditions. Furthermore, geogrid may be required for walls with a height lower than the minimum stated. The geogrid layout has been optimized to satisfy the minimum design requirements of the "Design Manual for Segmental Retaining Walls, 3<sup>rd</sup> Edition" from the National Concrete Masonry Association.

The height (H) of the wall is the total height from the leveling pad to the top of the wall, including the coping stones of 75 mm (2.95 in) thick; 100 mm (3.94 in) for Monumental wall. The wall height varies approximately from 1.97 ft (0.6 m) to 8.20 ft (2.5 m), gradually increasing in height increments of 1.31-2.62 ft (0.4-0.8 m).

### THE THREE TYPES OF SOIL ASSUMED IN THE REINFORCED SOIL ZONE ARE :

- (i) Mixes of sand and gravel (minimum friction angle of 34°);
- (ii) Sands (minimum friction angle of 30°) and;
- (iii) Low plasticity silts and clays (minimum friction angle of 26°).

The description of the soil is provided for information purposes; it is the actual shear strength parameter that will govern the design.

### THE THREE LOAD CONDITIONS ASSUMED ARE:

- (i) A horizontal surface above the wall with no surcharge;
- (ii) A horizontal surface above the wall with a uniform surcharge of 250 psf (12 kPa) or 100 psf (4.8 kPa) and;
- (iii) A 1V:3H slope above the wall.

The ~~(XXX)~~ symbol shows the position and length of the geogrid taken from the front of the block. The foundation soil must be able to support the wall-reinforced backfill system. A geotechnical study to ascertain the bearing capacity of the soil must be carried out. The leveling pad is made of  $0\text{-}\frac{3}{4}$  in (0-20 mm) crushed stone. A concrete pad can be used. Compaction must be carried out in successive layers of a maximum of 8" (200 mm) in thickness and in accordance with project specifications.

The minimum burial depth must be 6 in (150 mm) or 10% of the above ground wall height, whichever is greater.

# Installation guide

## THE DESIGN CHARTS WERE DEVELOPED BASED ON THE FOLLOWING CONDITIONS:

- Geogrid layout determined as per requirements of "NCMA Design Manual for Segmental Retaining Walls, 3<sup>rd</sup> Edition".
- The geogrid to use must be Miragrid® 3XT by Tencate Mirafi.
- Soil parameters: reinforced soil ( $\phi$  = see above,  $\gamma$  = 120 pcf); retained soil ( $\phi$  = 26°,  $\gamma$  = 120 pcf); foundation soil ( $\phi$  = 26°,  $\gamma$  = 120 pcf).
- The bearing capacity of the foundation soil, settlement, and global stability must be verified and validated by a qualified geotechnical engineer.
- Seismic analysis was not considered.
- The hydrostatic pressure is not considered. The wall must be provided with an adequate drainage system.
- 250 psf (12 kPa) surcharge equivalent to tractor trailer and heavy truck loadings.
- 100 psf (4.8 kPa) surcharge equivalent to car and light truck traffic.
- The design charts do not apply to tiered walls.

**For further information, please contact our technical service department.**

Email: [WALLS@TECHO-BLOC.COM](mailto:WALLS@TECHO-BLOC.COM) Web site: [WWW.TECHO-BLOC.COM](http://WWW.TECHO-BLOC.COM)

# Installation guide

## MONUMENTAL

The information contained in this publication is provided for information purposes only. Techo-Bloc and its predecessors, successors, beneficiaries, employees, associates, administrators and insurers can not under any circumstances be held liable for the incorrect use of information contained in the design charts. **This chart should be read in conjunction with the notes on page 162.**

REINFORCED SOIL TYPE: SAND/GRAVEL ( $\phi = 34^\circ$ ,  $\gamma = 120$  PCF)

### CASE N° 1

Inclined wall (10.8°)  
No surcharge

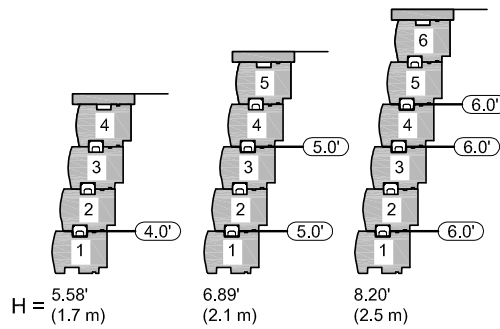
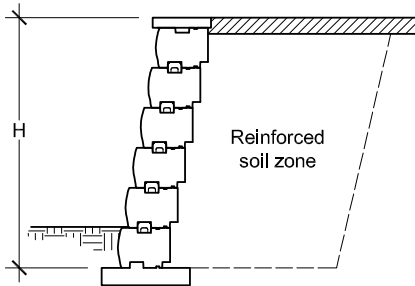

### CASE N° 2

Inclined wall (10.8°)  
250 psf surcharge (12 kPa)

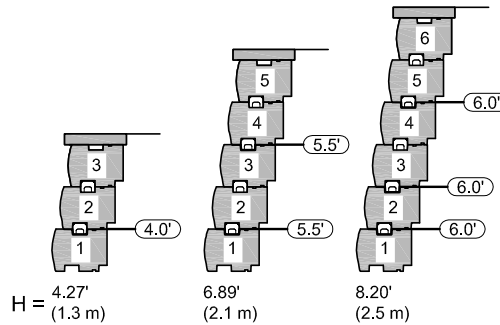
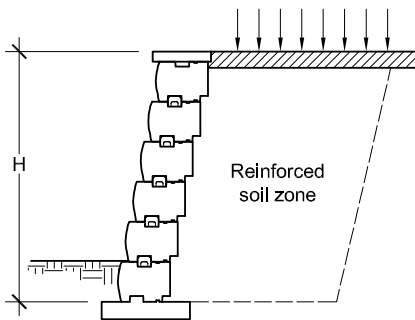

### CASE N° 3

Inclined wall (10.8°)  
Slope 1V:3H

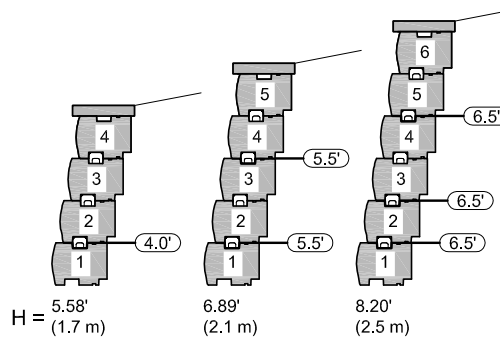
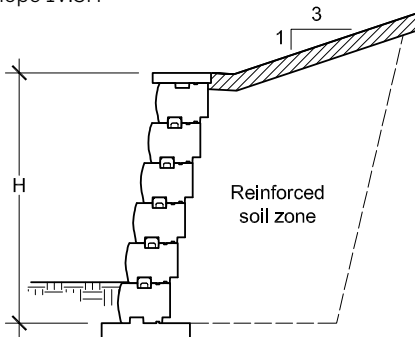

# Installation guide

## MONUMENTAL

The information contained in this publication is provided for information purposes only. Techo-Bloc and its predecessors, successors, beneficiaries, employees, associates, administrators and insurers can not under any circumstances be held liable for the incorrect use of information contained in the design charts. **This chart should be read in conjunction with the notes on page 162.**

REINFORCED SOIL TYPE: SAND ( $\phi = 30^\circ$ ,  $\gamma = 120$  PCF)

### CASE N° 4

Inclined wall (10.8°)  
No surcharge

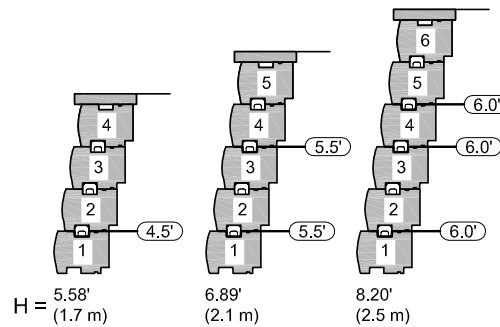
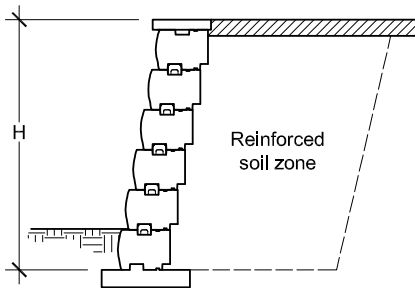

### CASE N° 5

Inclined wall (10.8°)  
250 psf surcharge (12 kPa)

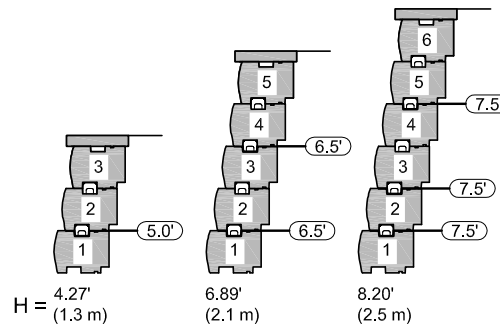
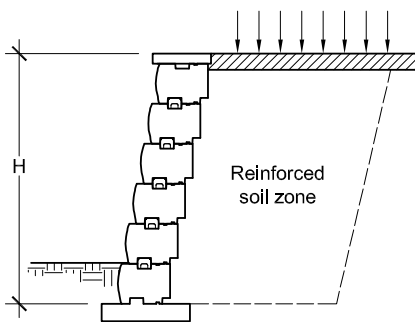

### CASE N° 6

Inclined wall (10.8°)  
Slope 1V:3H

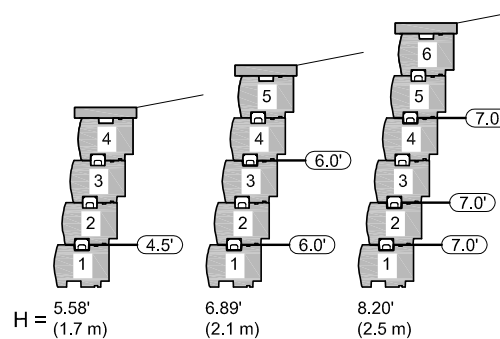
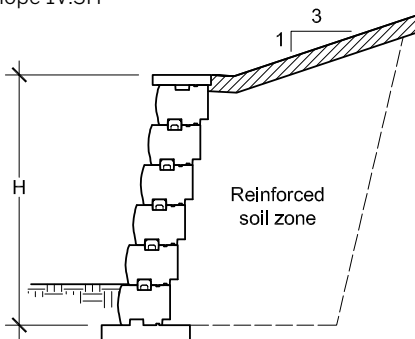

# Installation guide

## MONUMENTAL

The information contained in this publication is provided for information purposes only. Techo-Bloc and its predecessors, successors, beneficiaries, employees, associates, administrators and insurers can not under any circumstances be held liable for the incorrect use of information contained in the design charts. **This chart should be read in conjunction with the notes on page 162.**

REINFORCED SOIL TYPE: SILT/LEAN CLAY ( $\phi = 26^\circ$ ,  $\gamma = 120$  PCF)

### CASE N° 7

Inclined wall (10.8°)  
No surcharge

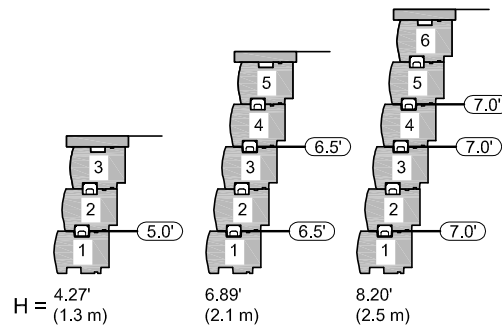
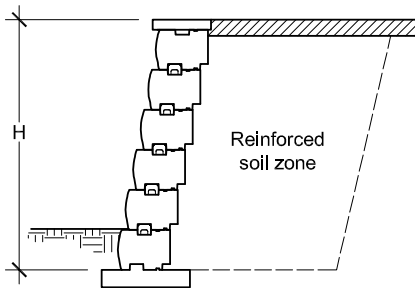

### CASE N° 8

Inclined wall (10.8°)  
250 psf surcharge (12 kPa)

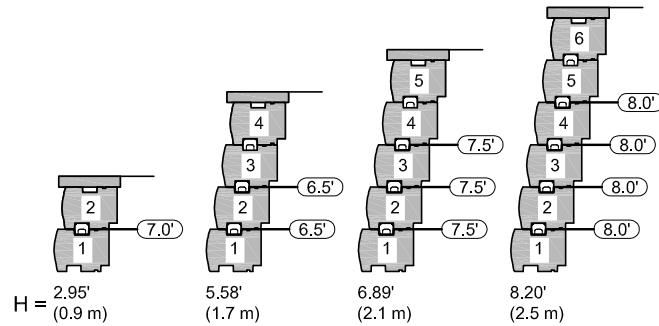
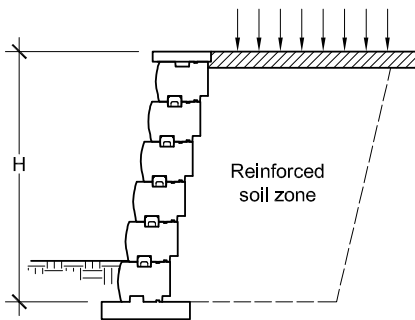

### CASE N° 9

Inclined wall (10.8°)  
Slope 1V:3H

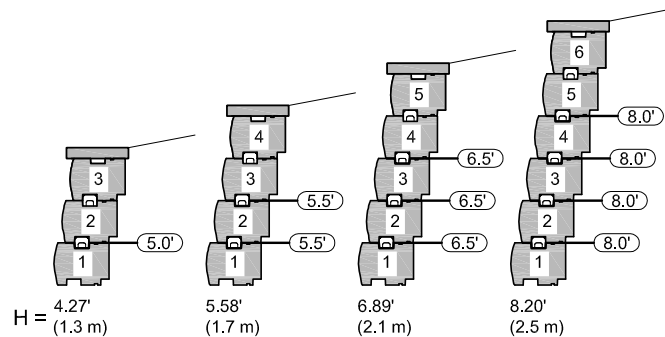
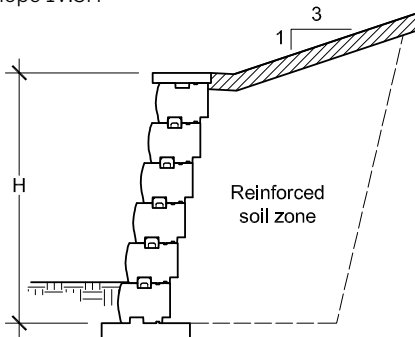



# Installation guide

## MONUMENTAL

The information contained in this publication is provided for information purposes only. Techo-Bloc and its predecessors, successors, beneficiaries, employees, associates, administrators and insurers can not under any circumstances be held liable for the incorrect use of information contained in the design charts. **This chart should be read in conjunction with the notes on page 162.**

REINFORCED SOIL TYPE: SAND/GRAVEL ( $\phi = 34^\circ$ ,  $\gamma = 120$  PCF)

### CASE N° 10

Near vertical wall (1.4°)  
No surcharge

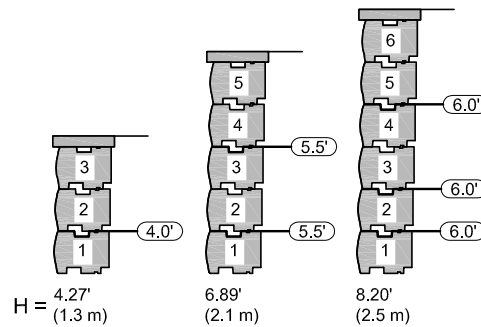
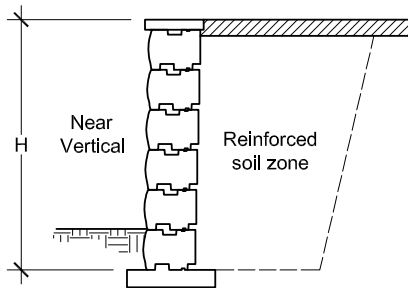

### CASE N° 11

Near vertical wall (1.4°)  
250 psf surcharge (12 kPa)

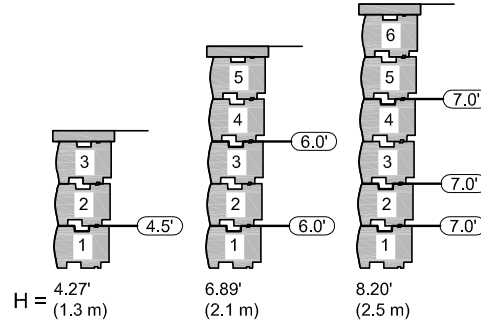
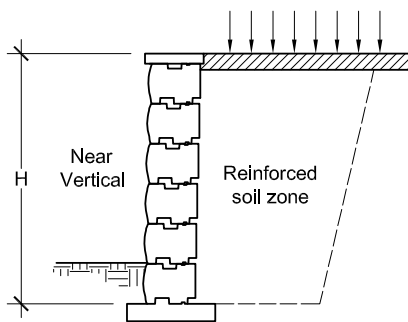

### CASE N° 12

Near vertical wall (1.4°)  
Slope 1V:3H

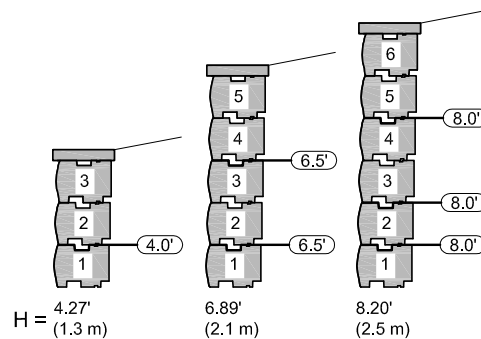
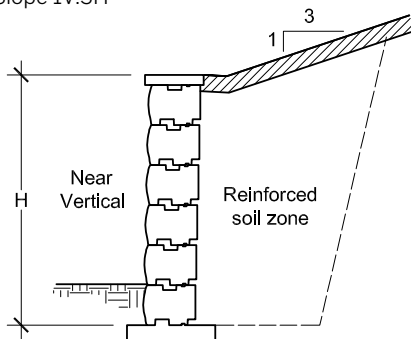

# Installation guide

## MONUMENTAL

The information contained in this publication is provided for information purposes only. Techo-Bloc and its predecessors, successors, beneficiaries, employees, associates, administrators and insurers can not under any circumstances be held liable for the incorrect use of information contained in the design charts. **This chart should be read in conjunction with the notes on page 162.**

REINFORCED SOIL TYPE: SAND ( $\phi = 30^\circ$ ,  $\gamma = 120$  PCF)

### CASE N° 13

Near vertical wall (1.4°)  
No surcharge

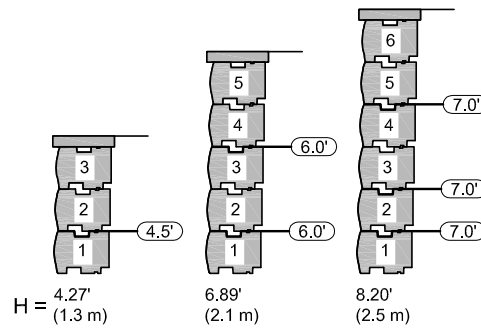
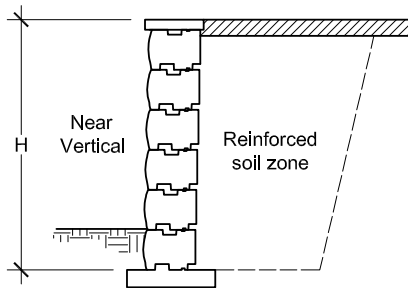

### CASE N° 14

Near vertical wall (1.4°)  
250 psf surcharge (12 kPa)

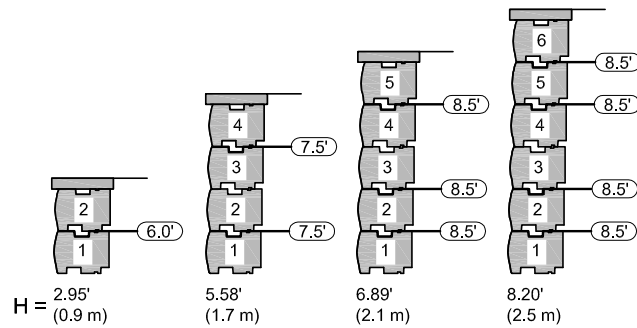
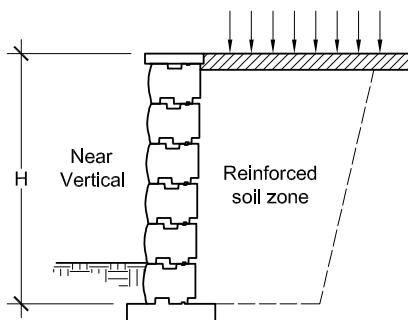

### CASE N° 15

Near vertical wall (1.4°)  
Slope 1V:3H

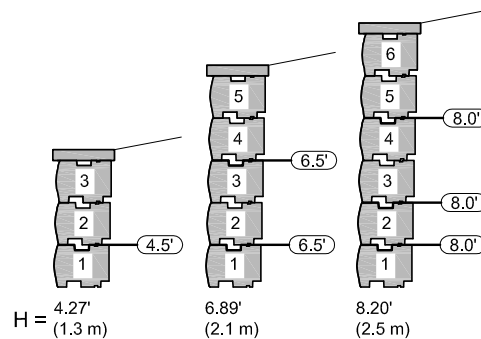
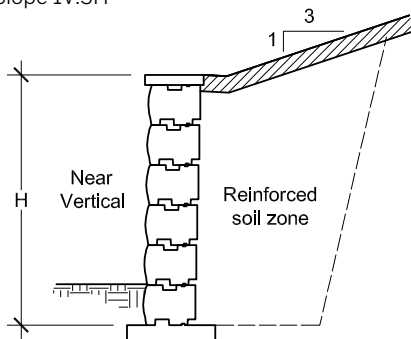

# Installation guide

## MONUMENTAL

The information contained in this publication is provided for information purposes only. Techo-Bloc and its predecessors, successors, beneficiaries, employees, associates, administrators and insurers can not under any circumstances be held liable for the incorrect use of information contained in the design charts. **This chart should be read in conjunction with the notes on page 162.**

REINFORCED SOIL TYPE: SILT/LEAN CLAY ( $\phi = 26^\circ$ ,  $\gamma = 120$  PCF)

### CASE N° 16

Near vertical wall (1.4°)  
No surcharge

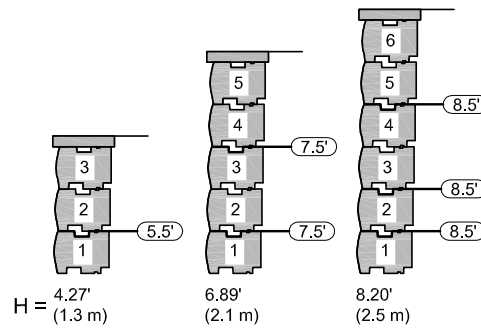
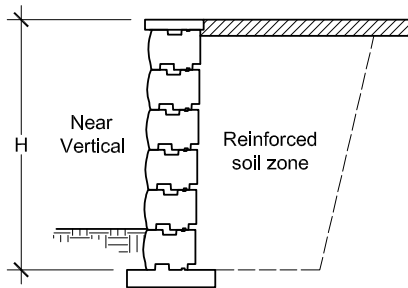

### CASE N° 17

Near vertical wall (1.4°)  
250 psf surcharge (12 kPa)

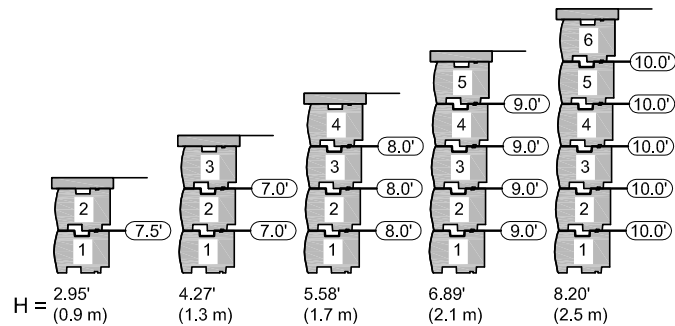
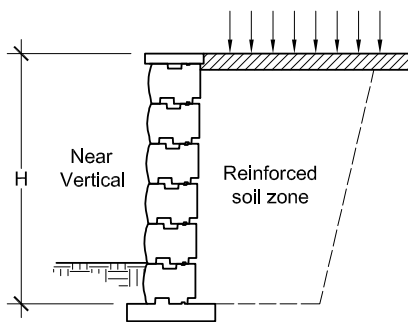

### CASE N° 18

Near vertical wall (1.4°)  
Slope 1V:3H

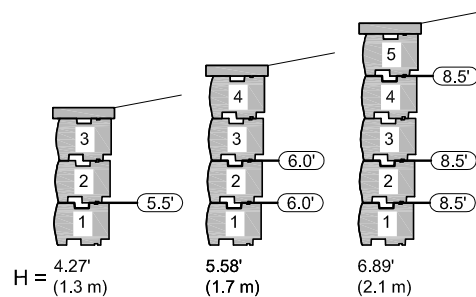
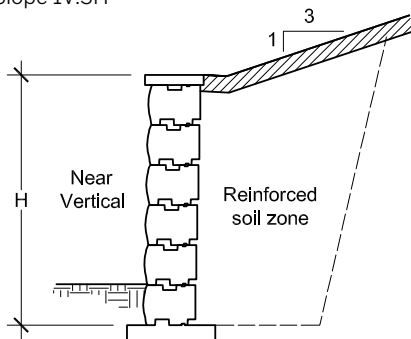

# Wall Design Charts USA

## MONUMENTAL

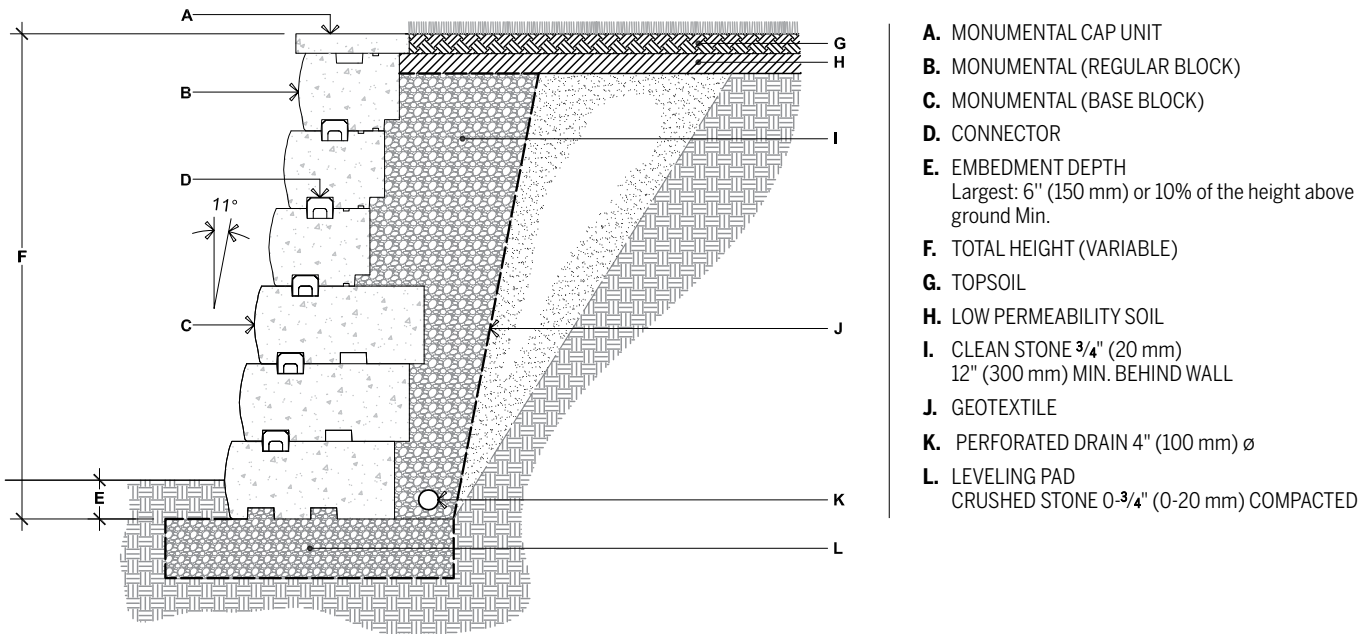

The information contained in the design charts is supplied for information purposes only and as such should only be used for preliminary designs. A qualified engineer should be consulted for the final design to be used for construction. TECHO-BLOC and its predecessors, successors, beneficiaries, employees, associates, administrators and insurers can not under any circumstances be held liable for the incorrect use of information contained in design charts.

The design charts are graphically presented to show different configurations of Monumental gravity-wall (geogrid is not required) at the setback position (3" (76 mm) setback per block course) and near vertical position ( $\frac{3}{8}$ " (10 mm) setback per block course). Monumental walls can be made of uniform depth block units (either regular or base units). However, in some cases, for economics and speed of construction, regular and base block units are combined. The design charts on the following pages cover the scenarios of walls with uniform and combined depth block units. Each configuration was optimized to meet the minimum design requirements as prescribed in the NCMA Design Manual for Segmental Retaining Walls, 3<sup>rd</sup> Edition.

The height (H) of the wall is the total height from the leveling pad to the top of the wall including the Monumental cap unit of 3.94" (100 mm) thick. The wall height ranges from 1.64' (0.5 m) to 10.83' (3.3 m), increasing in height incrementally by 1.31' (0.4 m).

### THE THREE TYPES OF RETAINED SOIL ASSUMED ARE:

- (i) sand and gravel mixes (friction angle of 36° min.);
- (ii) sands (friction angle of 30° min.) and;
- (iii) low plastic silts and clays (friction angle of 28° min.).

The soil descriptions are provided only as a general guide and it is the actual shear strength parameter that will govern the design. The assumed moist unit weight of soils is 125 pcf (19.6 kN/m<sup>3</sup>).

# Wall Design Charts USA

## MONUMENTAL

**THE FOUR LOAD CONDITIONS ASSUMED ARE:**

- (i) a horizontal surface above the wall with no surcharge;
- (ii) a horizontal surface above the wall with a uniform surcharge of 100 psf (4.8 kPa);
- (iii) a horizontal surface above the wall with a uniform surcharge of 250 psf (12 kPa) and;
- (iv) a 1V:3H slope above the wall.

The foundation soil must be able to support the wall. A geotechnical study to ascertain the bearing capacity of the soil must be carried out. The leveling pad is made of crushed stone 0- $\frac{3}{4}$ " (0-20 mm). A concrete leveling pad can also be used. Compaction must be carried out in successive layers of a maximum of 8" (200 mm) in thickness and in accordance with project specifications. The minimum burial depth must be 6" (150 mm) or 10% of the above ground wall height, whichever is greater.

**For further information, please contact our technical service department.**

**E-mail**

**WALLS@TECHO-BLOC.COM**

**Web site**

**WWW.TECHO-BLOC.COM/PRODUCTS/MONUMENTAL/**

# Wall Design Charts USA

## MONUMENTAL

The information contained in the design charts is supplied for information purposes only. Techo-Bloc and its predecessors, successors, beneficiaries, employees, associates, administrators and insurers can not under any circumstances be held liable for the incorrect use of information contained in design charts. **This chart should be read in conjunction with the notes on page 179.**

Retained soil: Sand and gravel mixes ( $\phi = 36^\circ$ ,  $\gamma = 125$  pcf [19.6 kN/m<sup>3</sup>])

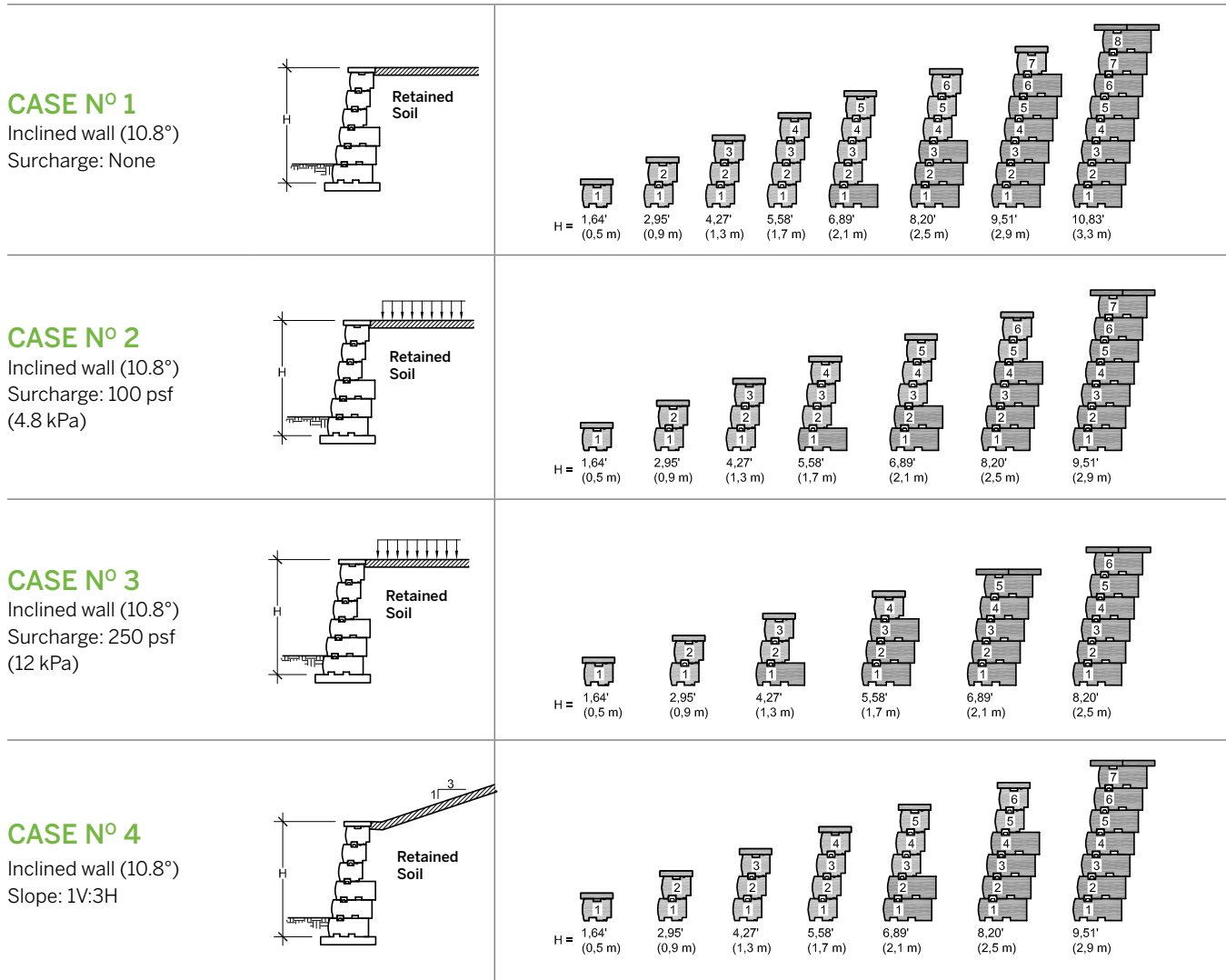

### THE DESIGN CHARTS WERE DEVELOPED BASED ON THE FOLLOWING CONDITIONS:

- Design as per requirements of *NCMA Design Manual for Segmental Retaining Walls, 3<sup>rd</sup> Edition*.
- Soil parameters: (retained soil  $\phi =$  see above,  $\gamma = 125$  pcf [19.6 kN/m<sup>3</sup>]; foundation soil ( $\phi =$  see above,  $\gamma = 120$  pcf [18.9 kN/m<sup>3</sup>]). The friction angle ( $\phi$ ) is assumed to be the same for both the retained and foundation soils.
- The bearing capacity of the soil, settlement, and global stability must be verified and validated by a qualified geotechnical engineer.
- Seismic analysis was not considered.
- The hydrostatic pressure is not considered. The wall must be provided with an adequate drainage system.
- Surcharge of 250 psf (12 kPa) (trucks).
- Surcharge of 100 psf (4.8 kPa) (cars).
- The design charts do not apply to tiered walls.

**For further information, please contact our technical service department.**

# Wall Design Charts USA

## MONUMENTAL

The information contained in the design charts is supplied for information purposes only. Techo-Bloc and its predecessors, successors, beneficiaries, employees, associates, administrators and insurers can not under any circumstances be held liable for the incorrect use of information contained in design charts. **This chart should be read in conjunction with the notes on page 179.**

Retained soil: Sands ( $\phi = 30^\circ$ ,  $\gamma = 125$  pcf [19.6 kN/m<sup>3</sup>])

### CASE N° 5

Inclined wall (10.8°)  
Surcharge: None

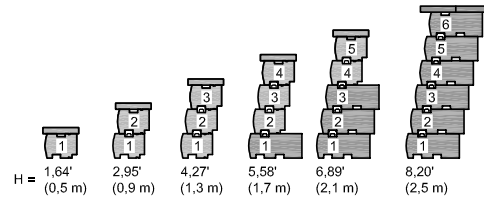
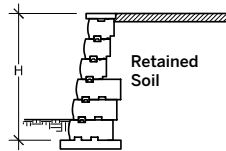

### CASE N° 6

Inclined wall (10.8°)  
Surcharge: 100 psf  
(4.8 kPa)

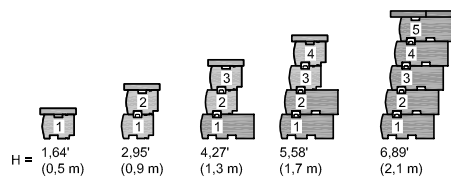
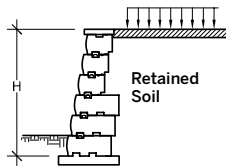

### CASE N° 7

Inclined wall (10.8°)  
Surcharge: 250 psf  
(12 kPa)

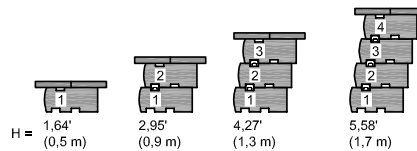
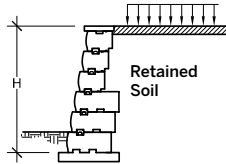

### CASE N° 8

Inclined wall (10.8°)  
Slope: 1V:3H

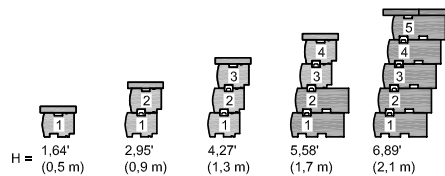
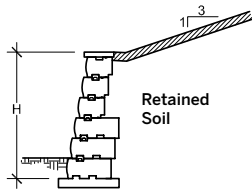

#### THE DESIGN CHARTS WERE DEVELOPED BASED ON THE FOLLOWING CONDITIONS:

- Design as per requirements of *NCMA Design Manual for Segmental Retaining Walls, 3<sup>rd</sup> Edition*.
- Soil parameters: (retained soil  $\phi =$  see above,  $\gamma = 125$  pcf [19.6 kN/m<sup>3</sup>]; foundation soil ( $\phi =$  see above,  $\gamma = 120$  pcf [18.9 kN/m<sup>3</sup>]). The friction angle ( $\phi$ ) is assumed to be the same for both the retained and foundation soils.
- The bearing capacity of the soil, settlement, and global stability must be verified and validated by a qualified geotechnical engineer.
- Seismic analysis was not considered.
- The hydrostatic pressure is not considered. The wall must be provided with an adequate drainage system.
- Surcharge of 250 psf (12 kPa) (trucks).
- Surcharge of 100 psf (4.8 kPa) (cars).
- The design charts do not apply to tiered walls.

For further information, please contact our technical service department.

# Wall Design Charts USA

## MONUMENTAL

The information contained in the design charts is supplied for information purposes only. Techo-Bloc and its predecessors, successors, beneficiaries, employees, associates, administrators and insurers can not under any circumstances be held liable for the incorrect use of information contained in design charts. **This chart should be read in conjunction with the notes on page 179.**

Retained soil: Low plastic silts and clays ( $\phi = 28^\circ$ ,  $\gamma = 125$  pcf [19.6 kN/m<sup>3</sup>])

### CASE N° 9

Inclined wall (10.8°)  
Surcharge: None

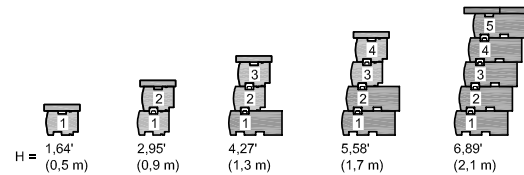
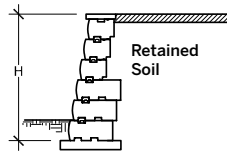

### CASE N° 10

Inclined wall (10.8°)  
Surcharge: 100 psf  
(4.8 kPa)

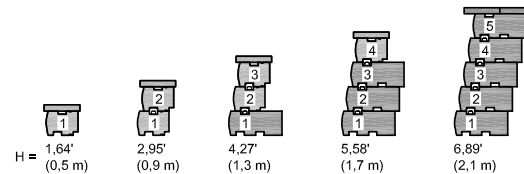
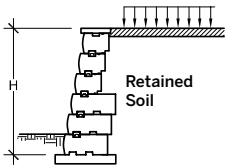

### CASE N° 11

Inclined wall (10.8°)  
Surcharge: 250 psf  
(12 kPa)

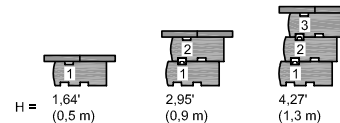
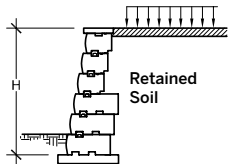

### CASE N° 12

Inclined wall (10.8°)  
Slope: 1V:3H

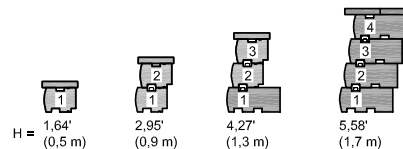
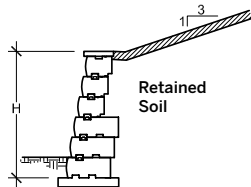

#### THE DESIGN CHARTS WERE DEVELOPED BASED ON THE FOLLOWING CONDITIONS:

- Design as per requirements of *NCMA Design Manual for Segmental Retaining Walls, 3<sup>rd</sup> Edition*.
- Soil parameters: (retained soil  $\phi =$  see above,  $\gamma = 125$  pcf [19.6 kN/m<sup>3</sup>]; foundation soil ( $\phi =$  see above,  $\gamma = 120$  pcf [18.9 kN/m<sup>3</sup>]). The friction angle ( $\phi$ ) is assumed to be the same for both the retained and foundation soils.
- The bearing capacity of the soil, settlement, and global stability must be verified and validated by a qualified geotechnical engineer.
- Seismic analysis was not considered.
- The hydrostatic pressure is not considered. The wall must be provided with an adequate drainage system.
- Surcharge of 250 psf (12 kPa) (trucks).
- Surcharge of 100 psf (4.8 kPa) (cars).
- The design charts do not apply to tiered walls.

**For further information, please contact our technical service department.**



# Wall Design Charts USA

## MONUMENTAL

The information contained in the design charts is supplied for information purposes only. Techo-Bloc and its predecessors, successors, beneficiaries, employees, associates, administrators and insurers can not under any circumstances be held liable for the incorrect use of information contained in design charts. **This chart should be read in conjunction with the notes on page 179.**

Retained soil: Sand and gravel mixes ( $\phi = 36^\circ$ ,  $\gamma = 125$  pcf [19.6 kN/m<sup>3</sup>])

### CASE N° 13

Near vertical wall (1.4°)  
Surcharge: None

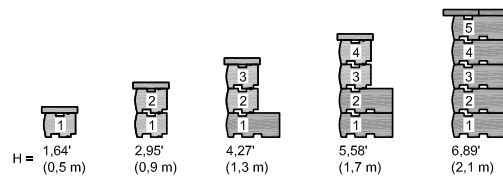
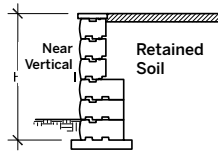

### CASE N° 14

Near vertical wall (1.4°)  
Surcharge: 100 psf  
(4.8 kPa)

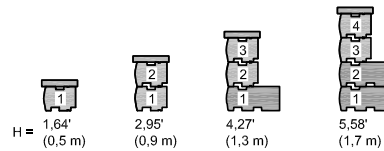
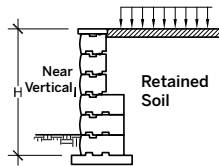

### CASE N° 15

Near vertical wall (1.4°)  
Surcharge: 250 psf  
(12 kPa)

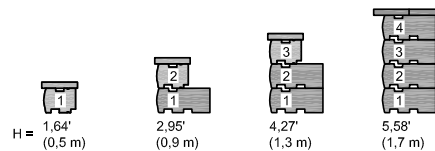
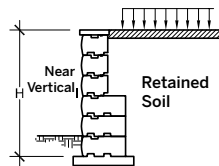

### CASE N° 16

Near vertical wall (1.4°)  
Slope: 1V:3H

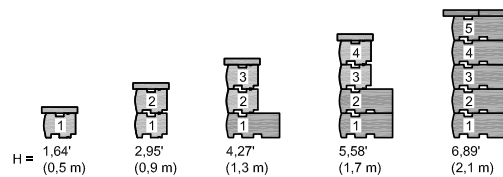
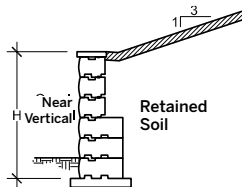

#### THE DESIGN CHARTS WERE DEVELOPED BASED ON THE FOLLOWING CONDITIONS:

- Design as per requirements of *NCMA Design Manual for Segmental Retaining Walls, 3<sup>rd</sup> Edition*.
- Soil parameters: (retained soil  $\phi =$  see above,  $\gamma = 125$  pcf [19.6 kN/m<sup>3</sup>]; foundation soil ( $\phi =$  see above,  $\gamma = 120$  pcf [18.9 kN/m<sup>3</sup>]). The friction angle ( $\phi$ ) is assumed to be the same for both the retained and foundation soils.
- The bearing capacity of the soil, settlement, and global stability must be verified and validated by a qualified geotechnical engineer.
- Seismic analysis was not considered.
- The hydrostatic pressure is not considered. The wall must be provided with an adequate drainage system.
- Surcharge of 250 psf (12 kPa) (trucks).
- Surcharge of 100 psf (4.8 kPa) (cars).
- The design charts do not apply to tiered walls.

For further information, please contact our technical service department.

# Wall Design Charts USA

## MONUMENTAL

The information contained in the design charts is supplied for information purposes only. Techo-Bloc and its predecessors, successors, beneficiaries, employees, associates, administrators and insurers can not under any circumstances be held liable for the incorrect use of information contained in design charts. **This chart should be read in conjunction with the notes on page 179.**

Retained soil: Sands ( $\phi = 30^\circ$ ,  $\gamma = 125$  pcf [19.6 kN/m<sup>3</sup>])

**CASE N° 17**  
Near vertical wall (1.4°)  
Surcharge: None

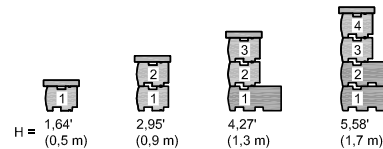
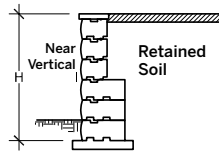

**CASE N° 18**  
Near vertical wall (1.4°)  
Surcharge: 100 psf  
(4.8 kPa)

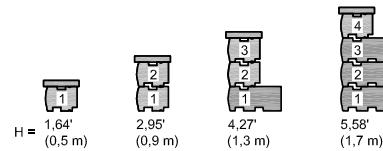
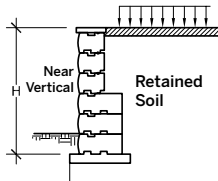

**CASE N° 19**  
Near vertical wall (1.4°)  
Surcharge: 250 psf  
(12 kPa)

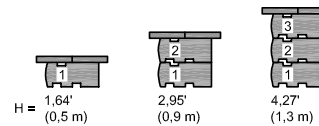
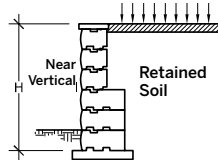

**CASE N° 20**  
Near vertical wall (1.4°)  
Slope: 1V:3H

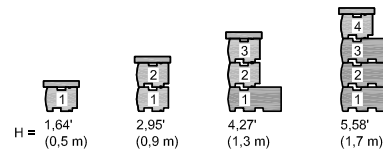
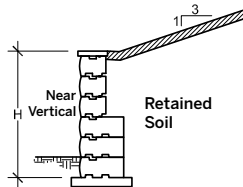

**THE DESIGN CHARTS WERE DEVELOPED BASED ON THE FOLLOWING CONDITIONS:**

- Design as per requirements of *NCMA Design Manual for Segmental Retaining Walls, 3<sup>rd</sup> Edition*.
- Soil parameters: (retained soil  $\phi =$  see above,  $\gamma = 125$  pcf [19.6 kN/m<sup>3</sup>]; foundation soil ( $\phi =$  see above,  $\gamma = 120$  pcf [18.9 kN/m<sup>3</sup>]). The friction angle ( $\phi$ ) is assumed to be the same for both the retained and foundation soils.
- The bearing capacity of the soil, settlement, and global stability must be verified and validated by a qualified geotechnical engineer.
- Seismic analysis was not considered.
- The hydrostatic pressure is not considered. The wall must be provided with an adequate drainage system.
- Surcharge of 250 psf (12 kPa) (trucks).
- Surcharge of 100 psf (4.8 kPa) (cars).
- The design charts do not apply to tiered walls.

**For further information, please contact our technical service department.**

# Wall Design Charts USA

## MONUMENTAL

The information contained in the design charts is supplied for information purposes only. Techo-Bloc and its predecessors, successors, beneficiaries, employees, associates, administrators and insurers can not under any circumstances be held liable for the incorrect use of information contained in design charts. **This chart should be read in conjunction with the notes on page 179.**

Retained soil: Low plastic silts and clays ( $\phi = 28^\circ$ ,  $\gamma = 125$  pcf [19.6 kN/m<sup>3</sup>])

### CASE N° 21

Near vertical wall (1.4°)  
Surcharge: None

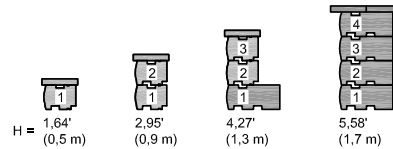
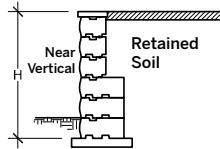

### CASE N° 22

Near vertical wall (1.4°)  
Surcharge: 100 psf (4.8 kPa)

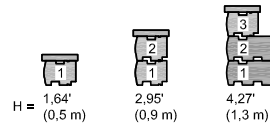
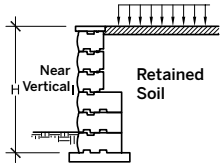

### CASE N° 23

Near vertical wall (1.4°)  
Surcharge: 250 psf (12 kPa)

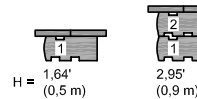
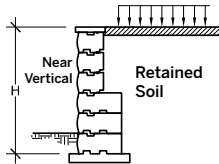

### CASE N° 24

Near vertical wall (1.4°)  
Slope: 1V:3H

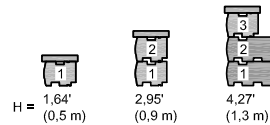
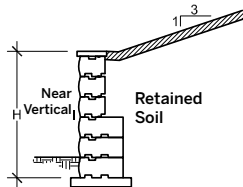

#### THE DESIGN CHARTS WERE DEVELOPED BASED ON THE FOLLOWING CONDITIONS:

- Design as per requirements of *NCMA Design Manual for Segmental Retaining Walls, 3<sup>rd</sup> Edition*.
- Soil parameters: (retained soil  $\phi =$  see above,  $\gamma = 125$  pcf [19.6 kN/m<sup>3</sup>]; foundation soil ( $\phi =$  see above,  $\gamma = 120$  pcf [18.9 kN/m<sup>3</sup>]). The friction angle ( $\phi$ ) is assumed to be the same for both the retained and foundation soils.
- The bearing capacity of the soil, settlement, and global stability must be verified and validated by a qualified geotechnical engineer.
- Seismic analysis was not considered.
- The hydrostatic pressure is not considered. The wall must be provided with an adequate drainage system.
- Surcharge of 250 psf (12 kPa) (trucks).
- Surcharge of 100 psf (4.8 kPa) (cars).
- The design charts do not apply to tiered walls.

**For further information, please contact our technical service department.**

# Installation guide

## WALLS

### Anchoring system | Connectors in curved wall application

When creating internal curves and the connectors are in the back groove, two connectors must be installed on each block as illustrated.

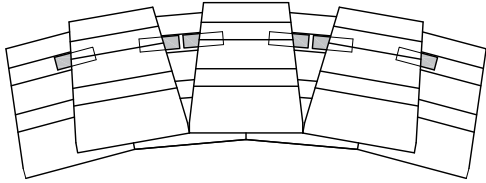

### Anchoring system | Connectors in geogrid reinforced wall application

When using a geogrid, it must be placed above the connectors. The connectors will therefore be placed before the geogrid. After positioning the geogrid, move the block (from the above course) forward until it touches the connectors and ensures that the system is locked.

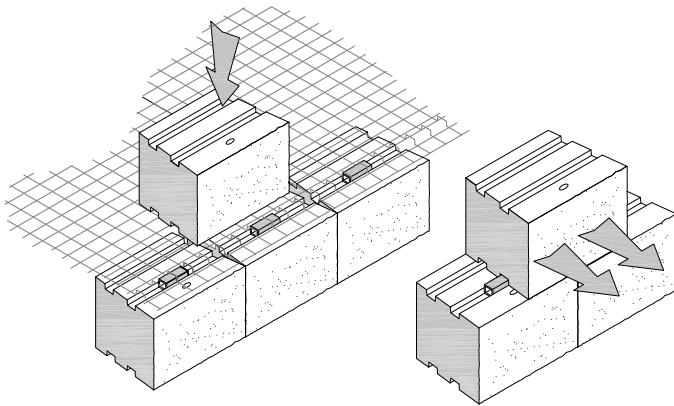

## PRESCOTT BLOCKS

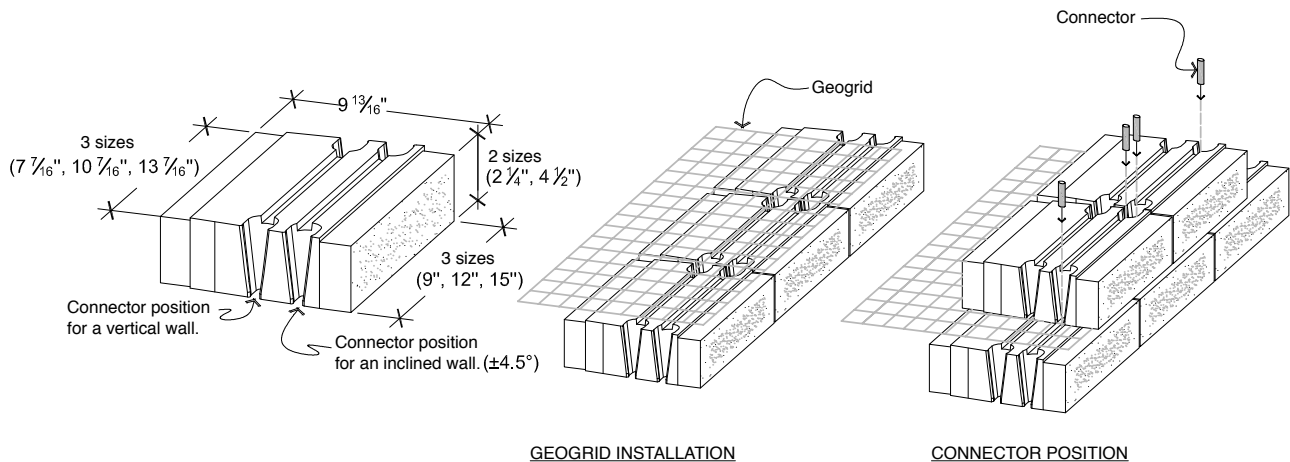

**Note:** It is recommended to install the connectors for an inclined wall when a geogrid is required.

# Installation guide

## WALLS

### RAFFINATO BLOCKS

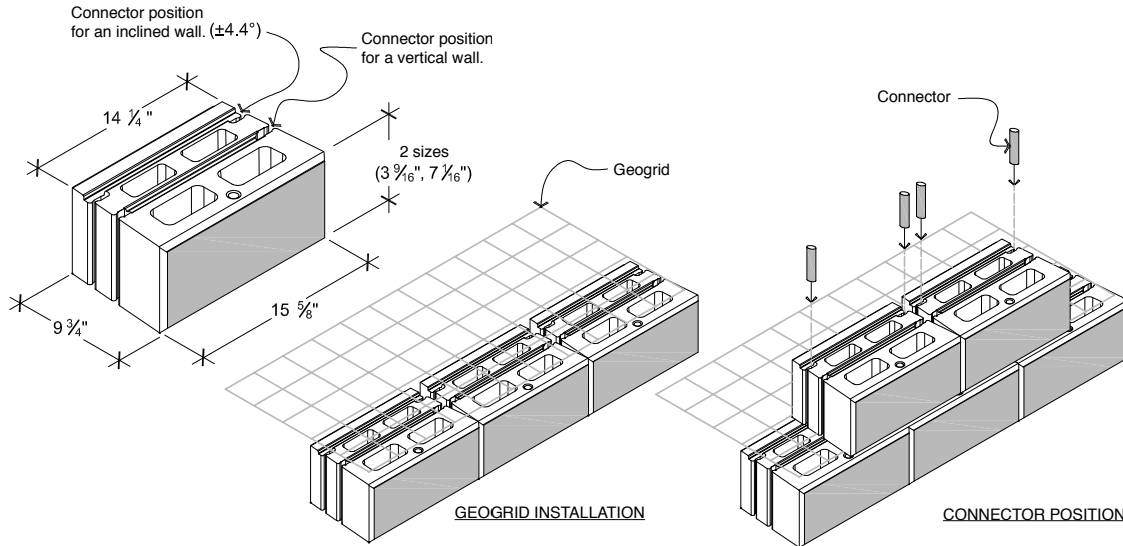

**Note:** It is recommended to install the connectors for an inclined wall when a geogrid is required.

### Internal corner

When building a wall with an internal corner, it is recommended to start constructing the wall at the corner and build out from this point in both directions. To form the corner, use the longer modules as illustrated. Build wall B by extending it out from wall A so the end of wall B is aligned with the back of wall A. For subsequent courses, simply alternate the extension of walls A and B.

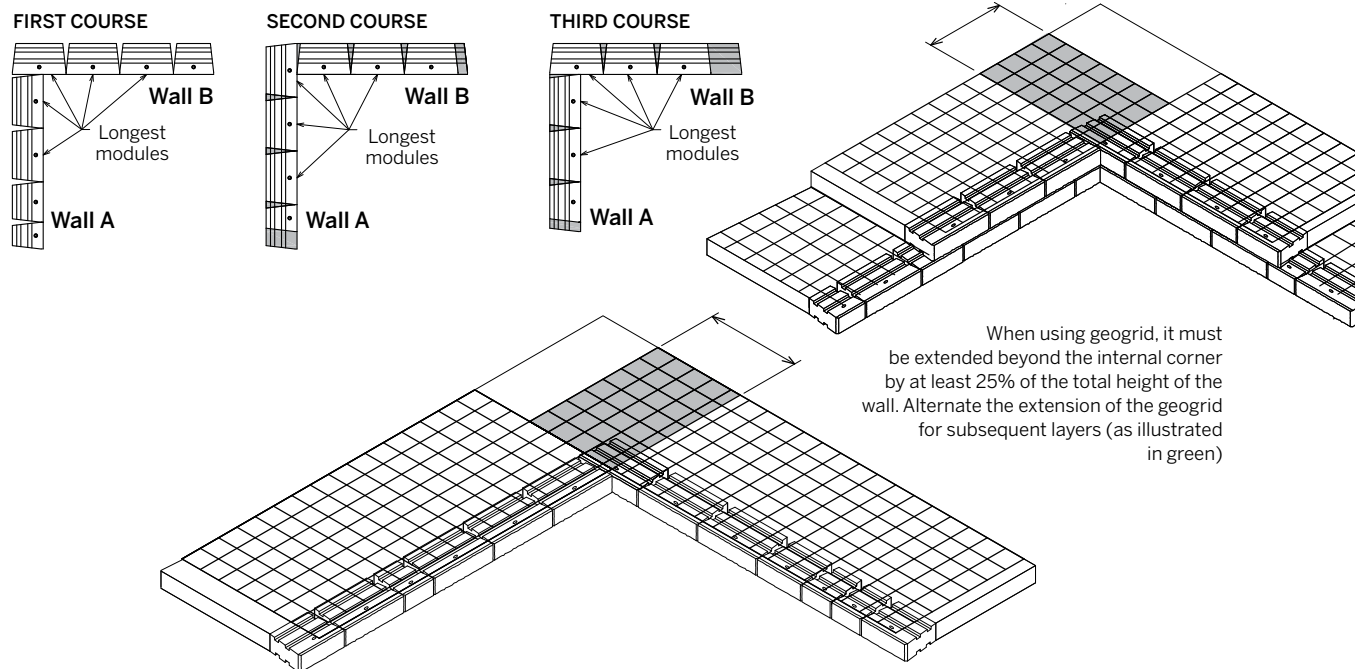

# Installation guide

## WALLS

### External corner

For walls with an external corner, start building the wall from the corner and continue from this point in both directions. Each pallet contains units that can be used to make a corner. On-site, these units (except the Suprema blocks) must be split down the side using a hammer and chisel in order to obtain a corner unit. For each subsequent course, alternate the direction of the corner unit and secure the corner unit to the block below using concrete adhesive.

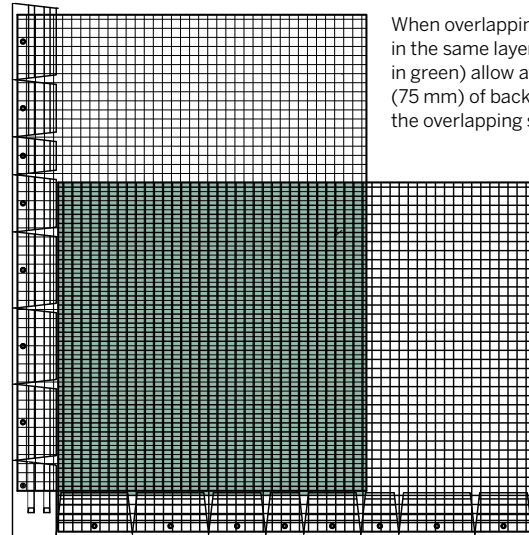
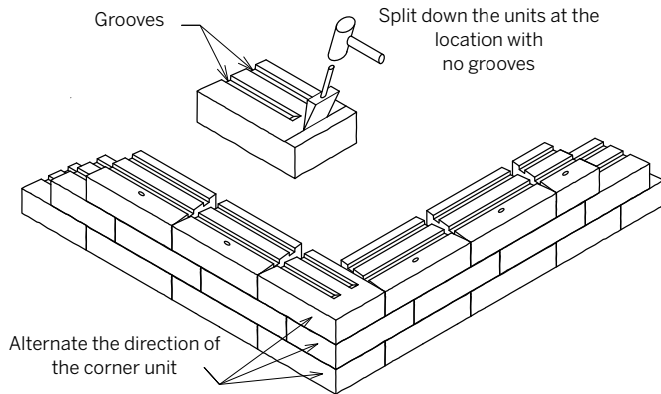

### Oblique corner

The longer modules should be used to build an oblique external corner. Cut the non-exposed part of the block using a saw. Use a chisel or splitter to give the exposed face of the block a textured look. Alternate the cutting of the blocks for each subsequent course.

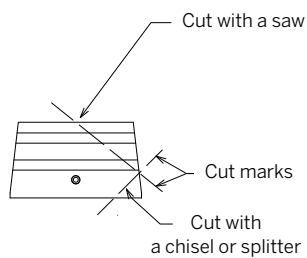

Alternate the position of the cut corner (as shown below)

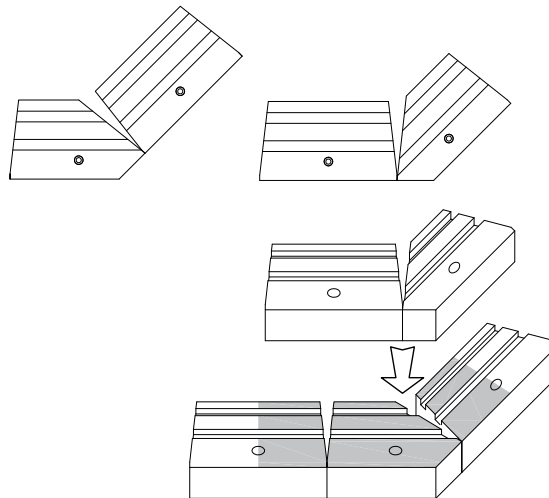

# Installation guide

## WALLS

### Internal curve

The Techo-Bloc retaining wall system allows walls to be built with internal and external curves. These curves can be achieved without cutting the blocks. You will need to angle the curves according to the minimum radius specified by Techo-Bloc.

When building a wall with an internal curve, it is recommended to start building the wall at the center of the curve and place blocks alternately to the left and right of the central block. If the wall to be constructed requires a setback (inclined wall), each course should be offset to the back and the curve will then become bigger. The minimum radius is therefore that of the first course.

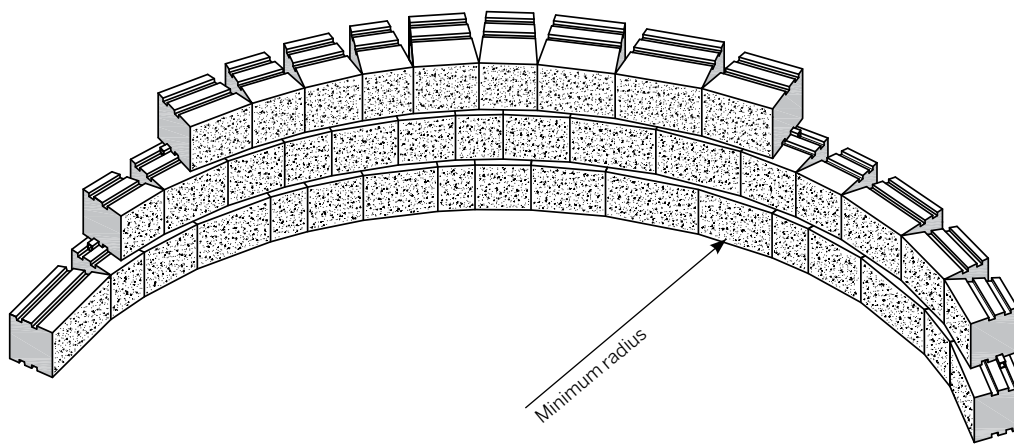

When using geogrid, it must cover 100% of the surface around the curve. To do this, additional layers of geogrid are placed on the next course of blocks to fill voids created from previous course (as illustrated in green).

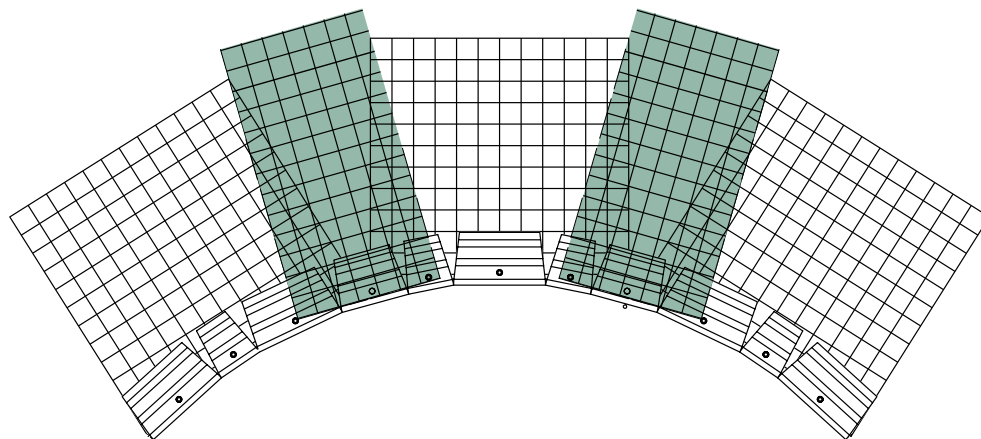

# Installation guide

## WALLS

### External curve

When building a wall with an external curve, it is recommended to start building the wall at the center of the curve and place blocks alternately to the left and right of the central block. Unlike internal curves, the external curve gets smaller as courses are added. The minimum radius is therefore that of the last course.

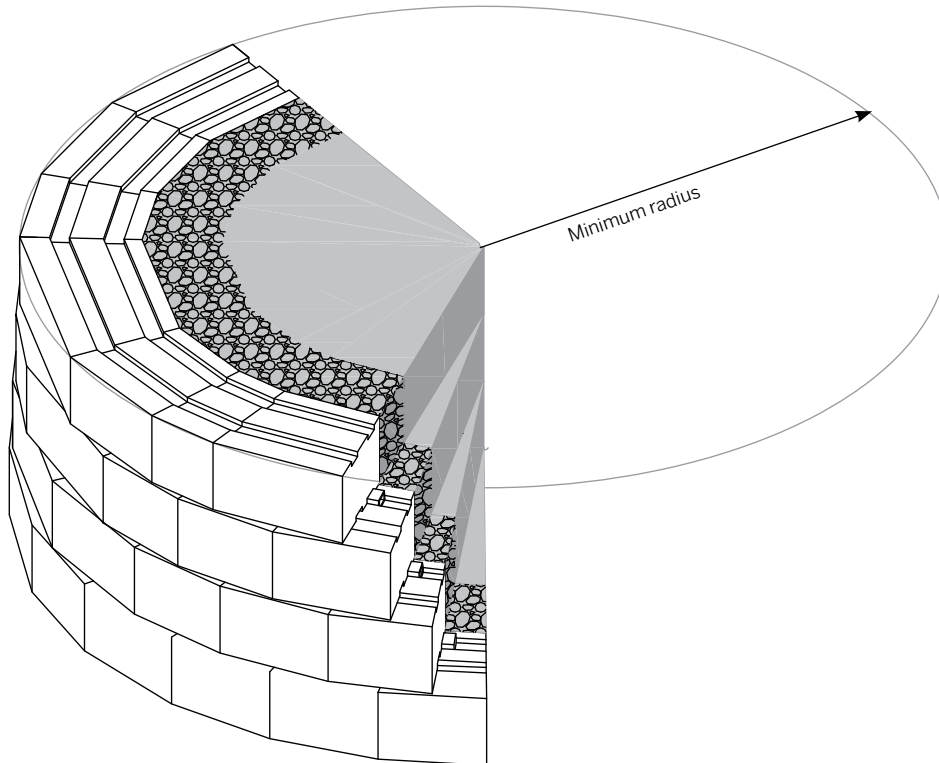

When using geogrid, it must cover 100% of the surface around the curve. To achieve this, additional layers of geogrid are placed on the same course of blocks to fill voids (as illustrated in green). In this case, we recommend at least 3" (75 mm) of backfill in between the overlapping sections.

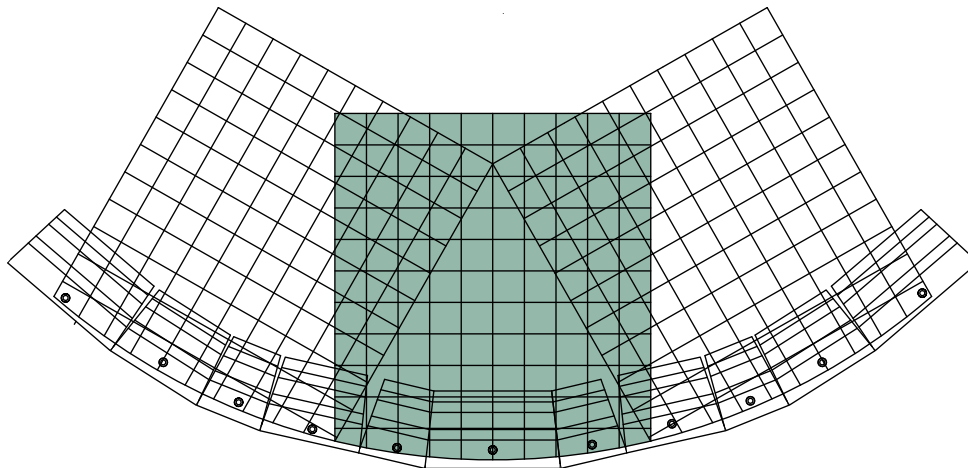





# Installation guide

## WALLS

### Fencing

Fencing can be erected behind the blocks. Fence posts must be placed in formwork tubes positioned during construction of the wall and then filled with concrete. The geogrid may be cut to accommodate installation of the tubes. Cut the geogrid in alignment with the center of the formwork tube and perpendicular to the wall, thus creating two geogrid panels. Connect the two geogrid panels at the front and back of the formwork tube and bend the geogrid to fit around the formwork.

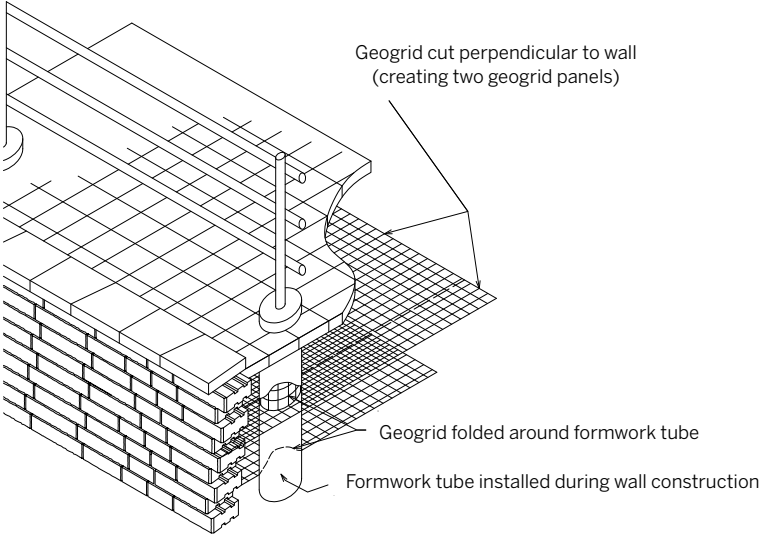

### Guard Rail

As with fencing, a guardrail can be incorporated behind the blocks. The guardrail posts must be installed during construction of the wall. The geogrid is cut perpendicular to the wall and in alignment with the center of the post, thus creating two geogrid panels. These two panels are connected at the front and back of the post. The geogrid can be bent to fit around the post.

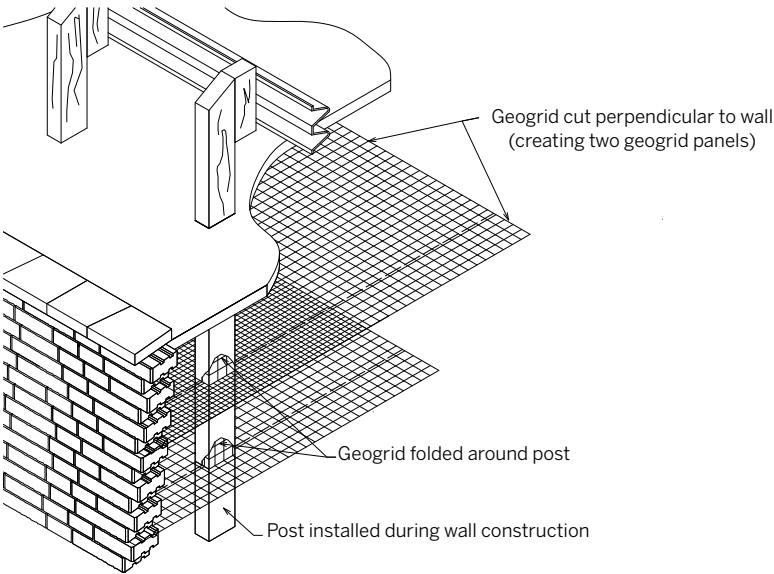

# Installation guide

## WALLS

### Tiered wall

Although tiered walls look appealing, it is important to take into account the additional load the upper wall applies on the lower wall. If the distance between the walls is at least twice the height of the lower wall, the walls are generally independent of each other. However, if this distance is less the lower wall must be built to take account of the load of the upper wall and geogrids may be required.

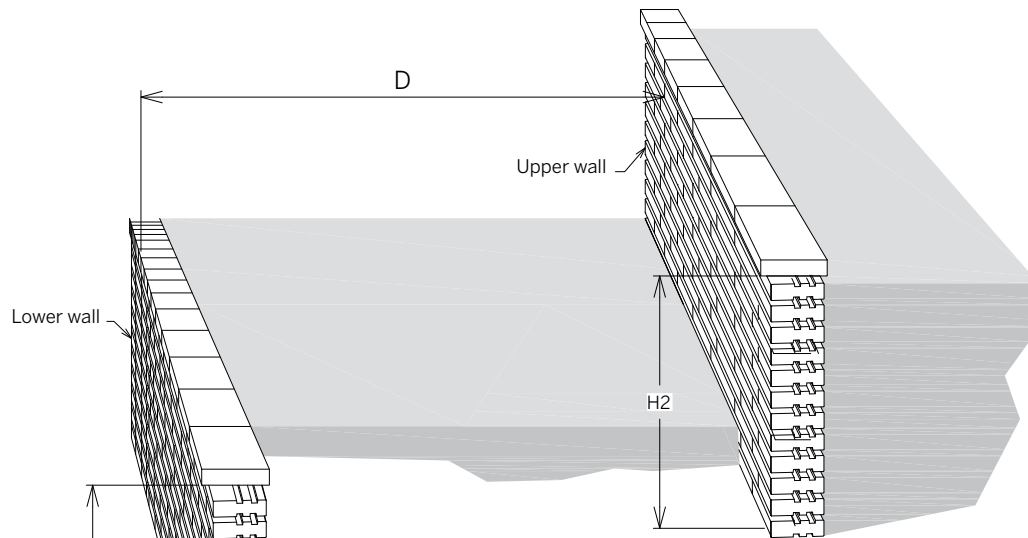

**If  $H1 > H2$  and  $D > (H1 \times 2)$**

The walls are generally independent of each other. Otherwise, the construction of the lower wall must take into account the load of the upper wall (as shown below).

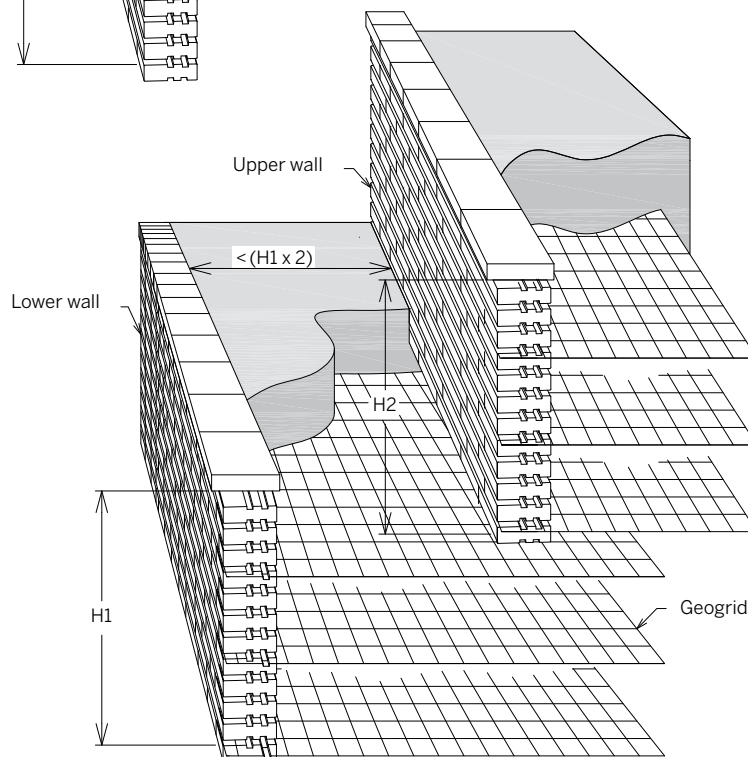

# Installation guide

## Additional wall patterns

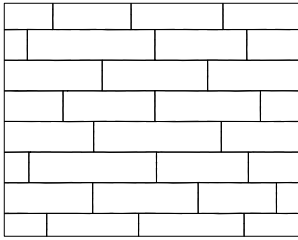

**BALTIMORE 90 mm**  
- Linear pattern

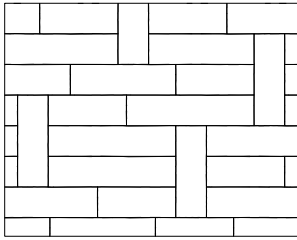

**BALTIMORE 90 mm**  
- with vertical units

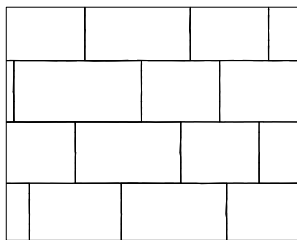

**BALTIMORE 180 mm**  
- Linear pattern

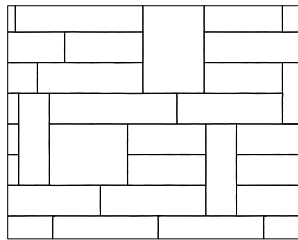

**BALTIMORE 90 mm & 180 mm**  
- with vertical units

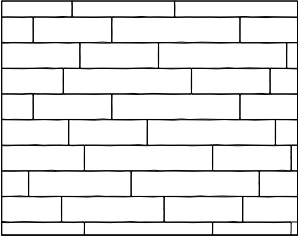

**MINI-CRETA 3"**  
- Linear pattern

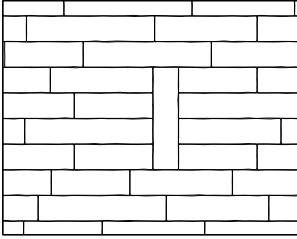

**MINI-CRETA 3"**  
- with vertical units

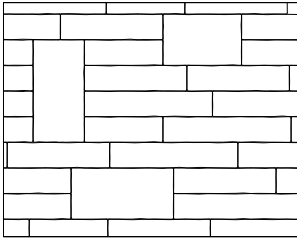

**MINI-CRETA 3" & 6"**  
- with vertical units

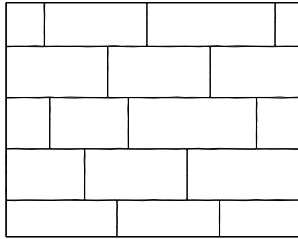

**MINI-CRETA 6"**  
- Linear pattern

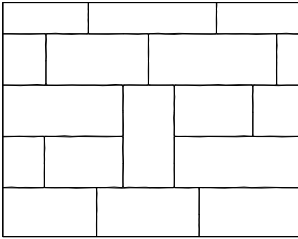

**MINI-CRETA 6"**  
- with vertical units

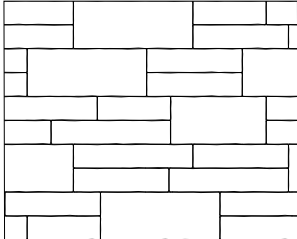

**MINI-CRETA 3" & 6"**  
- Linear pattern

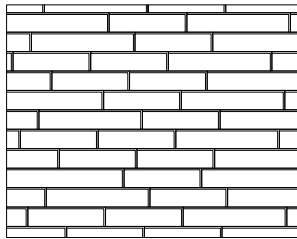

**PRESCOTT 2.25"**  
- Linear pattern

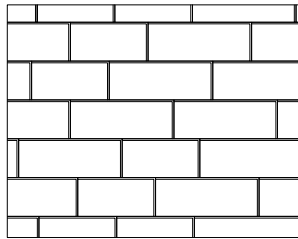

**PRESCOTT 4.5"**  
- Linear pattern

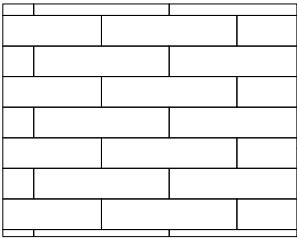

**RAFFINATO 90 mm**  
- Linear pattern

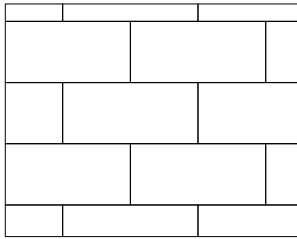

**RAFFINATO 180 mm**  
- Linear pattern

# Installation guide

## PILLARS

### General note

For a result that limits joint alignment while adding solidity, it is important to follow the illustrated instructions below. It is also important to adequately glue each row with a concrete adhesive in order to obtain a stable pillar.

If you are planning to install a light on top of the pillar, make sure you run the electrical wires prior to installing the blocks.

If you are planning to build a pillar with a planter, make sure to install a geotextile membrane inside the pillar before filling the cavity with planting soil.

### Installation outline

#### 01 EXCAVATION

- A. Before excavating, call all the local utility companies (e.g., phone, gas, electrical) to ensure that the area in which you plan to dig is clear of underground cables or wires. If any are found, please notify the appropriate companies before starting the project.
- B. Excavate an area of 40"×40" (1 m × 1 m) by 8" (200 mm) deep and fill in with 0-3/4" (0-20 mm) crushed stone compacted at 95% of the Proctor Density.
- C. With the help of a rake, grade the bottom of the excavated area. If the natural soil is granular or sandy, we recommend that you compact the soil with a vibrating plate. If the soil is clay-like, change the soil with a blend of lime and crushed stone prior to compaction. Next, cover it with a layer of geotextile fabric to prevent the contamination of the base (clay and 0-3/4" [0-20 mm] crushed stone).

#### 02 FOUNDATION

- A. Install the 0-3/4" (0-20 mm) crushed stone base, in 4" (100 mm) lifts with a (minimum 5,000 lbf [22 kN] vibrating plate) compactor.
- B. To facilitate compacting, wet the base material thoroughly and compact with a vibrating plate proceeding in all directions. This process should give you the desired height. At this stage, you can verify the final height with the help of a paver.

#### 03 SETTING BED

- A. On the compacted crushed base, install two pipes with an outside diameter of 1" (25 mm). Grade the concrete sand with the help of a straight edge (or Quick-E leveler). If the base is not properly graded and smooth, imperfections will be evident in the finishing grade of the pavement.
- B. Bedding sand should not be compacted until all paving stones have been laid down. Passing the vibrating plate over the paving stones causes them to settle approximately 3/8" (10 mm) into the bedding sand.

#### 04 STARTER ROW

Place the first four units as illustrated, while making sure that all units are leveled in all directions.

#### 05 SECOND ROW

Proceed with each layer / row as per adjacent illustration.

#### 06 THIRD ROW AND SUBSEQUENT ROWS

Repeat procedure from steps 1 and 2 until you reach the desired height.

#### 07 CROWNING

Crown the pillar using Pillar Caps (Stonedge Pillar Cap and York Pillar Caps).

- For the 24" Pillars, use the 28" × 28" caps.
- For the 28" Pillars, use the 32" × 32" caps.

