

# Installation guide

## WALLS

### Installation outline

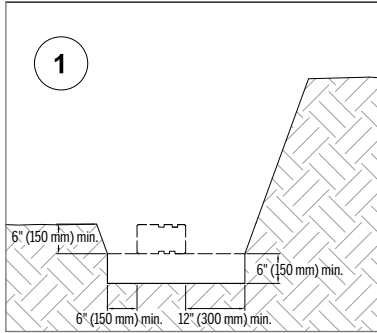

#### 01 EXCAVATION

- Check the location of existing structures and utilities before starting the excavation.
- Dig out a trench. Its depth should be calculated according to the thickness of the leveling pad and the burial depth of the wall.
- Plan for a thickness of at least 6" (150 mm) for the leveling pad and consider that at least 10% of the height of the wall should be buried in the ground. In all cases, the wall must be buried no less than 6" (150 mm) deep.
- In determining the width of the trench, allow for a space of at least 6" (150 mm) at the front of the wall and 12" (300 mm) at the back for drainage fill. Compact and level the excavation base.



#### FOR GEOGRID REINFORCED RETAINING WALLS

The excavation must also take into account the length of geogrid.

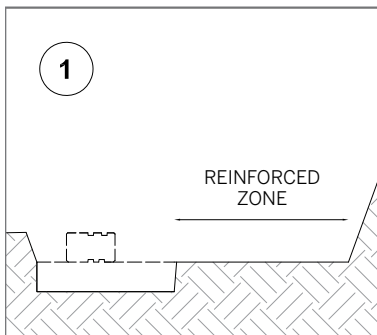

#### 02 FOUNDATION

- Cover the base and back of the trench with a geotextile. Extend the geotextile towards the back of the excavation and eventually above the drainage fill once it is in place close to the top of the wall.
- Next, spread the 0-3/4" (0-20 mm) stone in the trench and compact using a vibratory plate or jumping jack, ensuring that the surface is level. The compacted leveling pad must be at least 6" (150 mm) thick.

#### NOTE FOR STEPPED FOUNDATION

A wall built on an incline requires stepped foundations. For steep inclines, several steps may be required. Construction should start at the lowest level. Each of the steps must follow a level horizontal path and the vertical distance separating the successive steps must equal the height of a block.

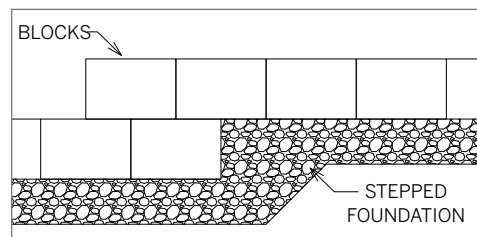
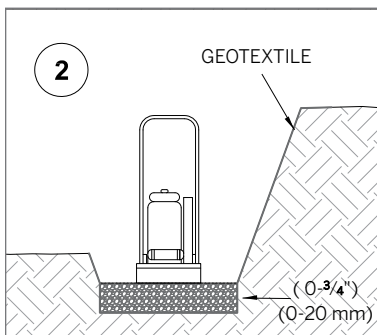

# Installation guide

## WALLS

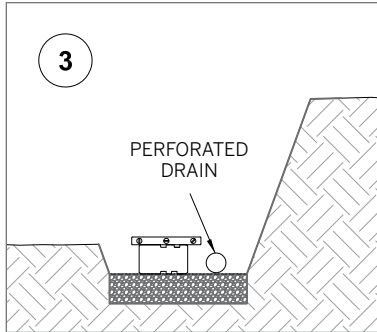

### 03 BUILDING THE FIRST COURSE

- Using blocks of the same height, place the first course on the compacted leveling pad according to the predetermined layout. Check the alignment and leveling in all directions and make sure that all the blocks are in full contact with the leveling pad and properly supported.
- Place the exposed surfaces of the blocks side by side. There must be no space between the exposed faces of adjacent blocks.
- At the back of the wall and on the compacted leveling pad, lay a 4" (100 mm) diameter perforated drain. Connect this drain to the existing drainage system so that it clears the water accumulated behind the wall.

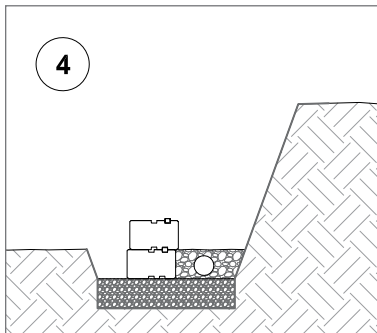

### 04 BACKFILLING

Backfill at the rear of the wall and the space between the back of the blocks with  $\frac{3}{4}$ " (20 mm) clean stone. Level and settle the clean stone. Any cavities in the blocks must also be filled with clean stone.

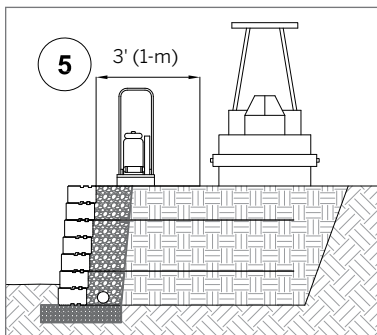

### 05 SUBSEQUENT COURSES

- Clean the top of each block before laying the next course. Depending on the type of block, install the connectors on the extremity of each block.
- Lay the subsequent courses, backfilling at the rear of the wall every 8" (200 mm maximum, using the same method outlined in step 4.
- Make sure the subsequent courses are laid such that the vertical seams are aligned with the blocks below.



### FOR GEOGRID REINFORCED RETAINING WALLS

Where geogrids are to be used, cover the clean stone with a geotextile. Select the geogrid according to the type, level and appropriate length. Position the geogrid according to the main reinforcement direction perpendicular to the wall. The geogrid must be continuous all along its embedment length. Splicing of the geogrid in the main reinforcement direction is not permitted. The geogrid must be installed horizontally over the compacted backfill and the previous course of blocks. Fix the connectors on the geogrid and lay the next course of blocks. Pull on the back of the geogrid and maintain its tension by stakes or pins. Repeat with a new section of geotextile and place the reinforced backfill directly behind the drainage fill. Fill and compact up to the level of the blocks.

Heavy equipment must not be used less than 3' (1-m) behind the blocks. Construction equipment must not drive directly over the geogrid.

Repeat the various installation steps.

### 06 FINISHING

Position the course of coping stones (if applicable) or the final course of blocks to complete the wall. The coping stones or final course of blocks must be fixed to the subjacent blocks using concrete adhesive and there must be no space between the blocks.

# Installation guide

## WALLS

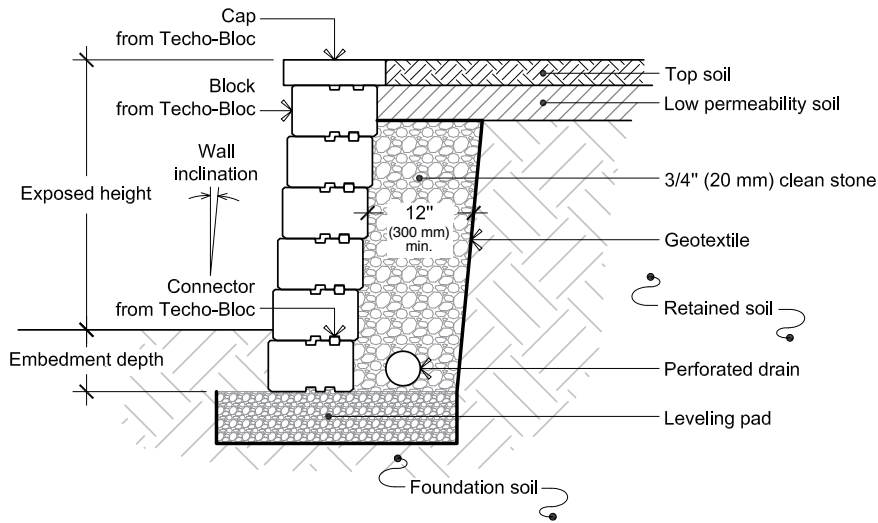

### WALL INSTALLATION – GRAVITY WALL

Typical cross section

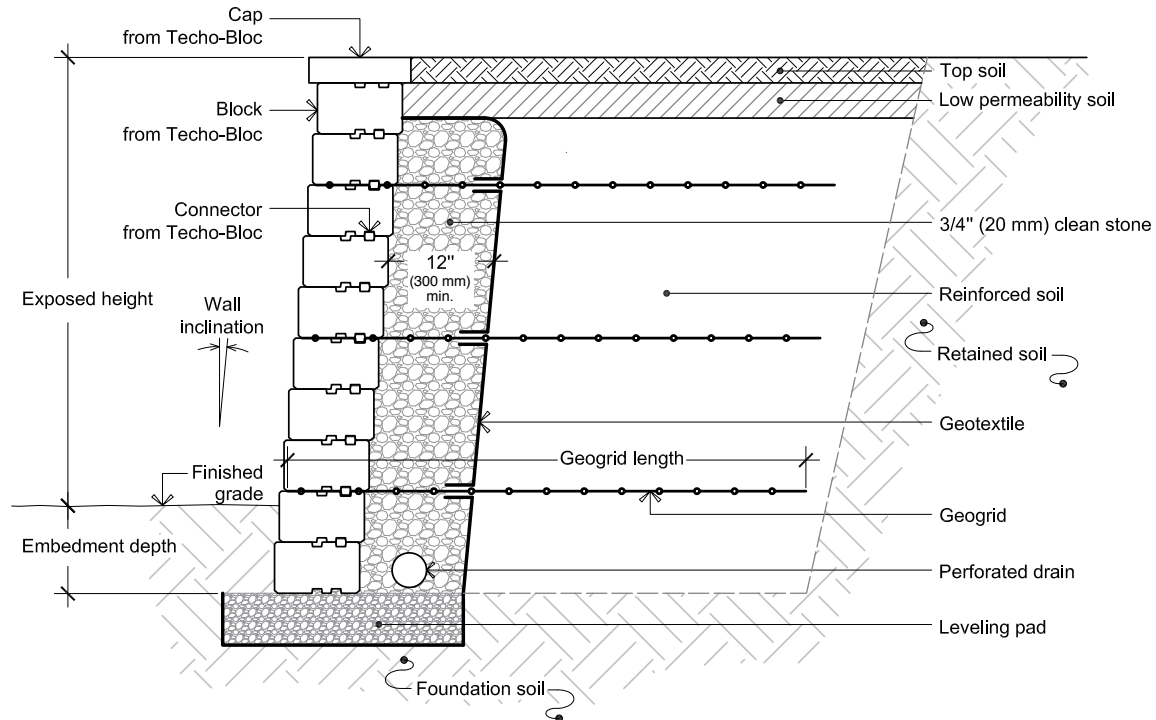

### WALL INSTALLATION – GEOGRID REINFORCED WALL

Typical cross section



### FOR GEOGRID REINFORCED RETAINING WALLS

For more information, refer to the Wall Design Charts on page 159.

# Wall Design Charts USA

## Summary of Characteristics | Wall without geogrid

Type of wall		Maximum Height <sup>1</sup> (including embedment)			Wall inclination degrees	Setback		Minimum wall radius <sup>3</sup>	
		Number of rows	Meters	Ft		mm	Inches	Meters	Ft
Baltimore 90 mm <sup>2</sup>	inclined	10	0.90	2.95	4.4	7	9/32	2.3	7.5
	vertical	8	0.72	2.36	0	0	0	2.3	7.5
Baltimore 180 mm <sup>2</sup>	inclined	5	0.90	2.95	4.4	14	9/16	2.3	7.5
	vertical	4	0.72	2.36	0	0	0	2.3	7.5
Borealis	vertical	4	0.61	2.00	0	0	0	-	-
Graphix	variable	8	0.60	1.97	variable			-	-
Manchester	vertical	5	0.50	1.64	0	0	0	-	-
Mini-Creta 3" <sup>2</sup>	inclined	12	0.90	2.95	5	7	9/32	2.1	7
	vertical	10	0.75	2.46	0	0	0	2.1	7
Mini-Creta 6" <sup>2</sup>	inclined	6	0.90	2.95	5	14	9/16	2.1	7
	vertical	5	0.75	2.46	0	0	0	2.1	7
Prescott 2.25" <sup>2</sup>	inclined	16	0.91	3.00	4.5	4.5	3/16	1.6	5.2
	vertical	12	0.69	2.25	0	0	0	1.6	5.2
Prescott 4.5" <sup>2</sup>	inclined	8	0.91	3.00	4.5	9	11/32	1.6	5.2
	vertical	6	0.69	2.25	0	0	0	1.6	5.2
Raffinato 90 mm <sup>2</sup>	incliné	10	0.90	2.95	4.4	7	9/32	2.6	8.5
	vertical	8	0.72	2.36	0	0	0	2.6	8.5
Raffinato 180 mm <sup>2</sup>	incliné	5	0.90	2.95	4.4	14	9/16	2.6	8.5
	vertical	4	0.72	2.36	0	0	0	2.6	8.5
Röcka	vertical	4	0.61	2.00	0	0	0	-	-
Semma <sup>2</sup>	inclined	7	1.07	3.50	7.6	20	25/32	2.1	7
	vertical	5	0.76	2.49	0	0	0	2.1	7
Suprema <sup>2</sup>	inclined	5	1.02	3.35	4.5	16	5/8	1.8	6
	vertical	4	0.81	2.66	0	0	0	1.8	6
Monumental (regular unit) <sup>2</sup>		Refer to page 181			11	76	3	5.2	17

<sup>1</sup> The maximum wall height recommended in this table is based on the following conditions:

- The retained soil type considered is gravel with an internal friction angle of at least 36°.
- There is no surcharge load applied on top of the wall.
- There is no slope on top of the wall.
- An adequate drainage system is provided at the back of the wall.

<sup>2</sup> These products can be used with geogrid reinforcement to build higher (inclined) walls or walls subject to different conditions than those mentioned.

Contact your Techo-Bloc representative for more details or fill out our Preliminary Design Assistance form (see page 161).

<sup>3</sup> Minimum wall radius is measured at the front face of the wall. It corresponds to the lowest course in an internal curve and to the uppermost course in an external curve (see page 191).



# Wall design Charts

## PRELIMINARY DESIGN ASSISTANCE

Techo-Bloc can help you in your preliminary design of retaining walls which fall outside the bounds of the Height Charts. However, preliminary design should only be used to assess the suitability of a wall system to a specific project or for estimating budget costs. For final construction designs, please contact a qualified engineer in your area.

### 1. TECO-BLOC

Representative \_\_\_\_\_ Date \_\_\_\_\_

### 2. GENERAL PROJECT INFORMATION

Enterprise \_\_\_\_\_ Are you a Techo-Pro?  Yes  No \_\_\_\_\_

Address \_\_\_\_\_ City \_\_\_\_\_

State / Province \_\_\_\_\_ Postal Code \_\_\_\_\_ Contact \_\_\_\_\_

Telephone \_\_\_\_\_ Fax \_\_\_\_\_

E-mail \_\_\_\_\_ Information date required \_\_\_\_\_

Prepared by \_\_\_\_\_ Project title \_\_\_\_\_

Address \_\_\_\_\_ City \_\_\_\_\_

State / Province \_\_\_\_\_ Postal Code \_\_\_\_\_

Type (industrial, commercial, institutional, residential) \_\_\_\_\_ Units (metric or imperial) \_\_\_\_\_

### 3. GENERAL INFORMATION ON WALLS

Block product \_\_\_\_\_ T-B Distributor \_\_\_\_\_

Maximum wall height (above-ground) \_\_\_\_\_ Wall length \_\_\_\_\_

Tiered wall  No  Yes      LOWER WALL      Distance between      UPPER WALL  
Height \_\_\_\_\_

*If a grading plan is available, include it with this request (drawings should indicate the location of the wall, grade lines and loads). Otherwise, clear and detailed sketches must be provided.*

### 4. SLOPE INFORMATION

*Indicate the angle or the ratio. For example, for a 1-unit vertical difference in level on a 3-unit horizontal plan, write 1V:3H.*

Slope at BASE of wall?  No  Yes \_\_\_\_\_ (angle or ratio)

Slope ABOVE wall?  No  Yes \_\_\_\_\_ (angle or ratio)

### 5. SURCHARGE ABOVE WALL

TYPE OF SURCHARGE (LOAD)	WALL DISTANCE	Reinforced soil _____	Retained soil _____
<input type="checkbox"/> Route	_____	<input type="checkbox"/> Clean sand and gravel	
<input type="checkbox"/> Parking / alley for heavy vehicles	_____	<input type="checkbox"/> Silty gravel	
<input type="checkbox"/> Parking / alley for light vehicles	_____	<input type="checkbox"/> Clayey gravel	
<input type="checkbox"/> Swimming pool	_____	<input type="checkbox"/> Silty sand	
<input type="checkbox"/> Paved surface (patio)	_____	<input type="checkbox"/> Clayey sand	
<input type="checkbox"/> Lawn / grass	_____	<input type="checkbox"/> Silt and clay	
<input type="checkbox"/> Other _____		<input type="checkbox"/> Other _____	

### 6. TYPE OF SOIL

*If a soil report is available, attach it to this request.*

Return this request by one of the following methods: **Fax** 450 656-1983 | **Email** walls@techo-bloc.com  
**Mail** Techo-Bloc - 5255 Albert-Millichamp Street, Saint-Hubert, QC J3Y 8Z8

# Installation guide

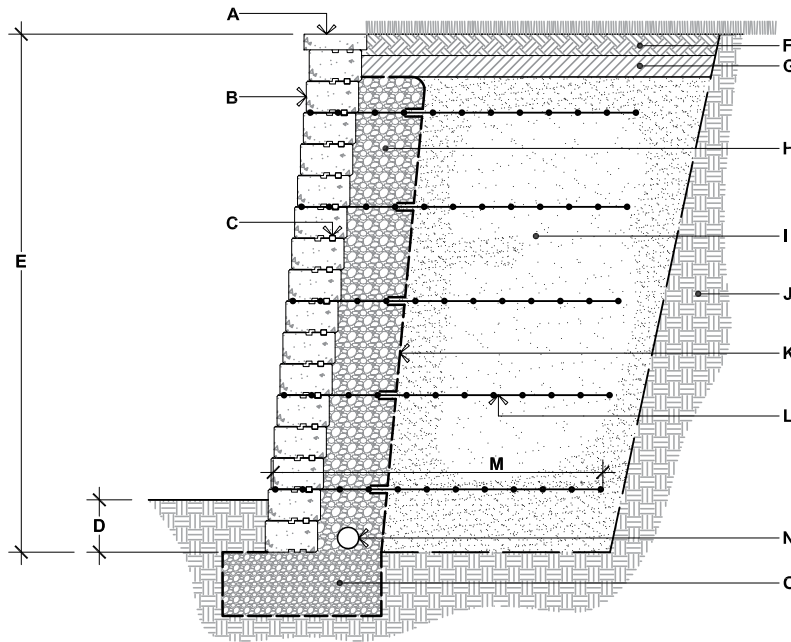

- A. CAP UNIT FROM TECO-BLOC
- B. TECO-BLOC WALL UNIT
- C. CONNECTOR
- D. EMBEDMENT DEPTH LARGEST: 6" (150 mm) OR 10% OF THE HEIGHT ABOVE GROUND MIN.
- E. TOTAL HEIGHT (VARIABLE)
- F. TOPSOIL
- G. LOW PERMEABILITY SOIL
- H. CLEAN STONE  $\frac{3}{4}$ " (20 mm) PLACED 12" (300 mm) MIN. WIDE BEHIND WALL
- I. REINFORCED SOIL COMPACTED
- J. RETAINED SOIL
- K. GEOTEXTILE
- L. GEOGRID
- M. GEOGRID LENGTH
- N. PERFORATED DRAIN 4" (100 mm) Dia.
- O. LEVELING PAD CRUSHED STONE  $0\text{-}\frac{3}{4}$ " (0-20 mm) COMPACTED

## WALL INSTALLATION - GEOGRID REINFORCED WALL

Typical cross section

The information contained in the design charts is supplied for information purposes only and as such should only be used for preliminary designs. A qualified engineer should be consulted for the final design to be used for construction. TECO-BLOC and its predecessors, successors, beneficiaries, employees, associates, administrators and insurers can not under any circumstances be held liable for the incorrect use of information contained in the design charts.

The design charts show the number, position and length of the geogrids for a Techo-Bloc inclined wall based on the height of the wall, soil type and the load conditions. Furthermore, geogrid may be required for walls with a height lower than the minimum stated. The geogrid layout has been optimized to satisfy the minimum design requirements of the "Design Manual for Segmental Retaining Walls, 3<sup>rd</sup> Edition" from the National Concrete Masonry Association.

The height (H) of the wall is the total height from the leveling pad to the top of the wall, including the coping stones of 75 mm (2.95 in) thick; 100 mm (3.94 in) for Monumental wall. The wall height varies approximately from 1.97 ft (0.6 m) to 8.20 ft (2.5 m), gradually increasing in height increments of 1.31-2.62 ft (0.4-0.8 m).

### THE THREE TYPES OF SOIL ASSUMED IN THE REINFORCED SOIL ZONE ARE :

- (i) Mixes of sand and gravel (minimum friction angle of 34°);
- (ii) Sands (minimum friction angle of 30°) and;
- (iii) Low plasticity silts and clays (minimum friction angle of 26°).

The description of the soil is provided for information purposes; it is the actual shear strength parameter that will govern the design.

### THE THREE LOAD CONDITIONS ASSUMED ARE:

- (i) A horizontal surface above the wall with no surcharge;
- (ii) A horizontal surface above the wall with a uniform surcharge of 250 psf (12 kPa) or 100 psf (4.8 kPa) and;
- (iii) A 1V:3H slope above the wall.

The ~~(XXX)~~ symbol shows the position and length of the geogrid taken from the front of the block. The foundation soil must be able to support the wall-reinforced backfill system. A geotechnical study to ascertain the bearing capacity of the soil must be carried out. The leveling pad is made of  $0\text{-}\frac{3}{4}$  in (0-20 mm) crushed stone. A concrete pad can be used. Compaction must be carried out in successive layers of a maximum of 8" (200 mm) in thickness and in accordance with project specifications.

The minimum burial depth must be 6 in (150 mm) or 10% of the above ground wall height, whichever is greater.

# Installation guide

## THE DESIGN CHARTS WERE DEVELOPED BASED ON THE FOLLOWING CONDITIONS:

- Geogrid layout determined as per requirements of "NCMA Design Manual for Segmental Retaining Walls, 3<sup>rd</sup> Edition".
- The geogrid to use must be Miragrid® 3XT by Tencate Mirafi.
- Soil parameters: reinforced soil ( $\phi$  = see above,  $\gamma$  = 120 pcf); retained soil ( $\phi$  = 26°,  $\gamma$  = 120 pcf); foundation soil ( $\phi$  = 26°,  $\gamma$  = 120 pcf).
- The bearing capacity of the foundation soil, settlement, and global stability must be verified and validated by a qualified geotechnical engineer.
- Seismic analysis was not considered.
- The hydrostatic pressure is not considered. The wall must be provided with an adequate drainage system.
- 250 psf (12 kPa) surcharge equivalent to tractor trailer and heavy truck loadings.
- 100 psf (4.8 kPa) surcharge equivalent to car and light truck traffic.
- The design charts do not apply to tiered walls.

**For further information, please contact our technical service department.**

Email: [WALLS@TECHO-BLOC.COM](mailto:WALLS@TECHO-BLOC.COM) Web site: [WWW.TECHO-BLOC.COM](http://WWW.TECHO-BLOC.COM)

# Installation guide

## SUPREMA

The information contained in this publication is provided for information purposes only. Techo-Bloc and its predecessors, successors, beneficiaries, employees, associates, administrators and insurers can not under any circumstances be held liable for the incorrect use of information contained in the design charts. **This chart should be read in conjunction with the notes on page 162.**

REINFORCED SOIL TYPE: SAND/GRAVEL ( $\phi = 34^\circ$ ,  $\gamma = 120$  PCF)

### CASE N° 1

Inclined wall (4.5°)  
No surcharge

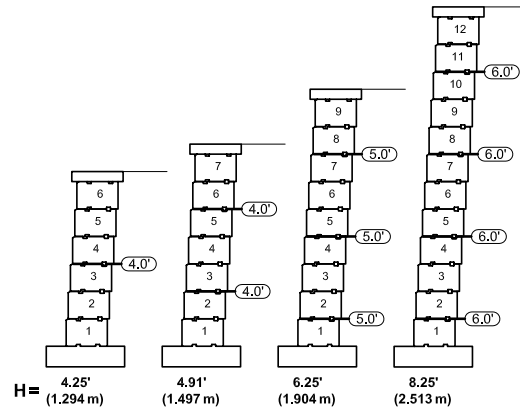
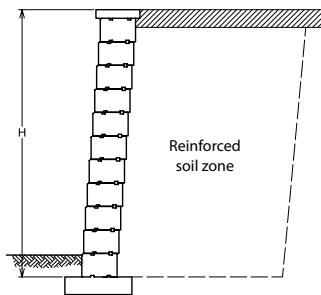

### CASE N° 2

Inclined wall (4.5°)  
250 psf surcharge (12 kPa)

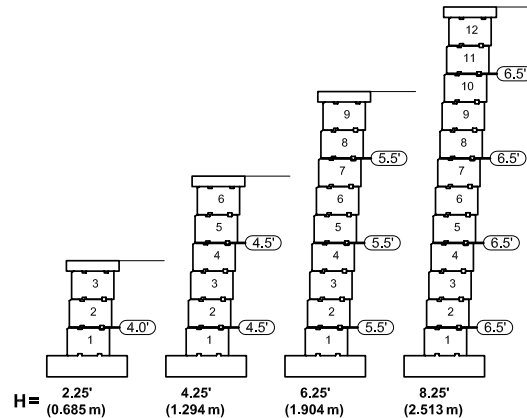
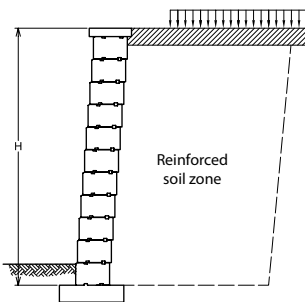

### CASE N° 3

Inclined wall (4.5°)  
Slope 1V:3H

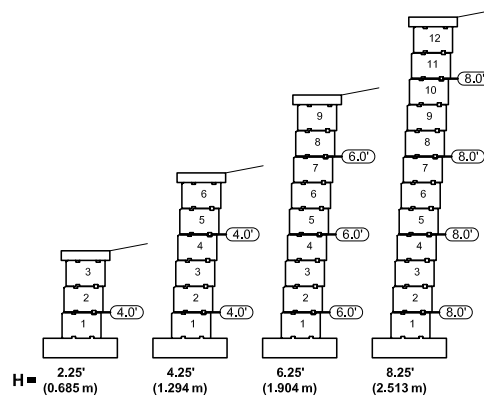
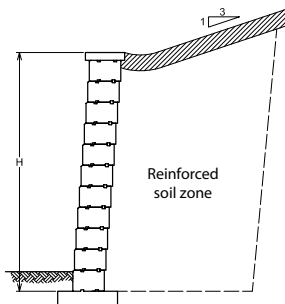



# Installation guide

## SUPREMA

The information contained in this publication is provided for information purposes only. Techo-Bloc and its predecessors, successors, beneficiaries, employees, associates, administrators and insurers can not under any circumstances be held liable for the incorrect use of information contained in the design charts. **This chart should be read in conjunction with the notes on page 162.**

REINFORCED SOIL TYPE: SAND ( $\phi = 30^\circ$ ,  $\gamma = 120$  PCF)

### CASE N° 4

Inclined wall (4.5°)  
No surcharge

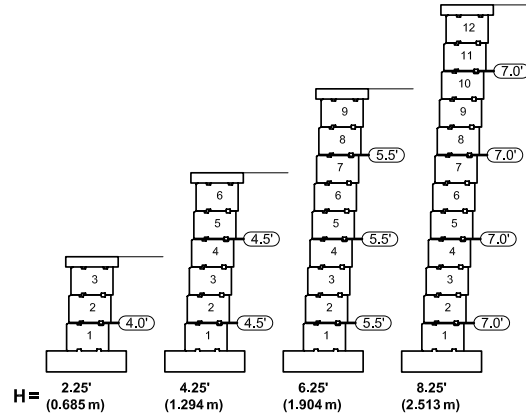
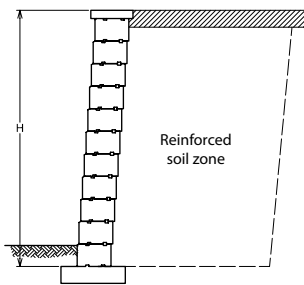

### CASE N° 5

Inclined wall (4.5°)  
250 psf surcharge (12 kPa)

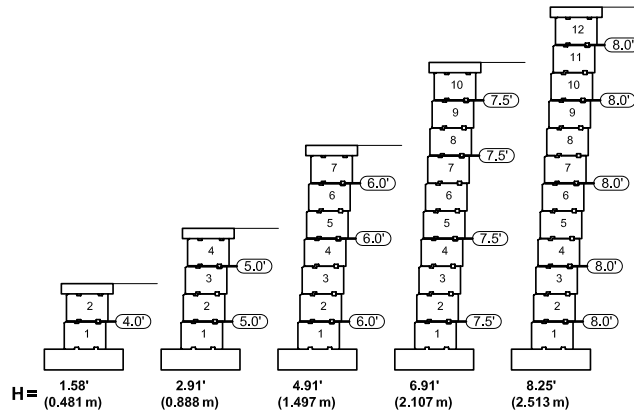
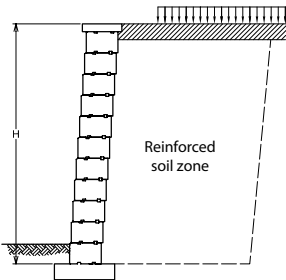

### CASE N° 6

Inclined wall (4.5°)  
Slope 1V:3H

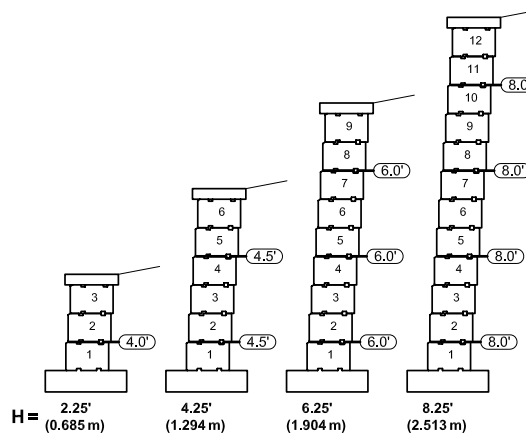
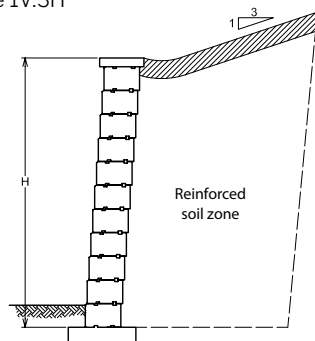

# Installation guide

## SUPREMA

The information contained in this publication is provided for information purposes only. Techo-Bloc and its predecessors, successors, beneficiaries, employees, associates, administrators and insurers can not under any circumstances be held liable for the incorrect use of information contained in the design charts. **This chart should be read in conjunction with the notes on page 162.**

REINFORCED SOIL TYPE: SILT / LEAN CLAY ( $\phi = 26^\circ$ ,  $\gamma = 120$  PCF)

### CASE N° 7

Inclined wall (4.5°)  
No surcharge

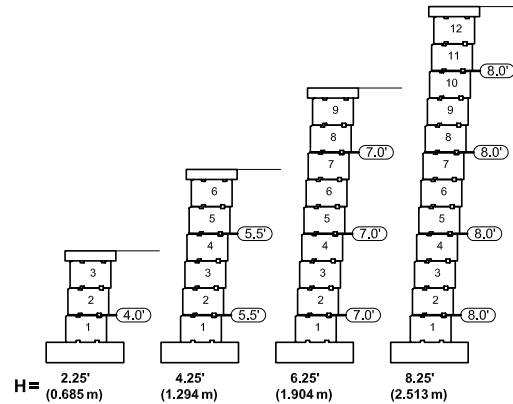
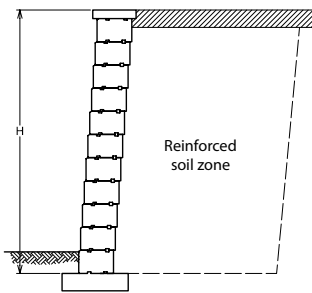

### CASE N° 8

Inclined wall (4.5°)  
250 psf surcharge (12 kPa)

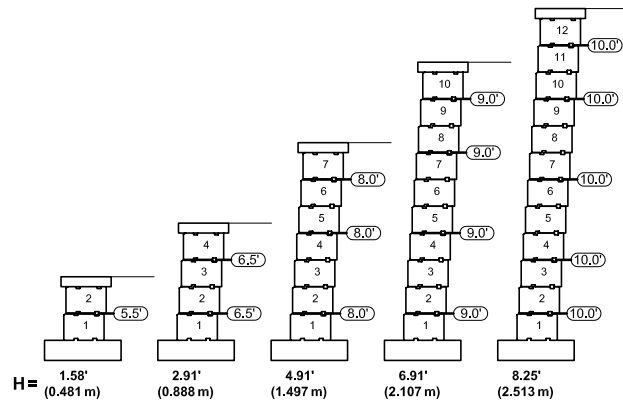
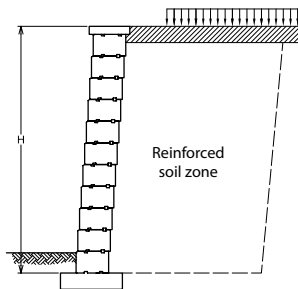

### CASE N° 9

Inclined wall (4.5°)  
Slope 1V:3H

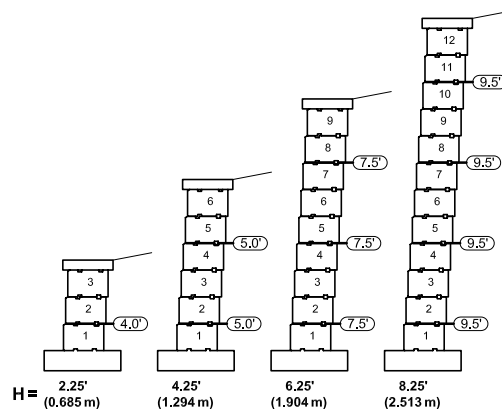
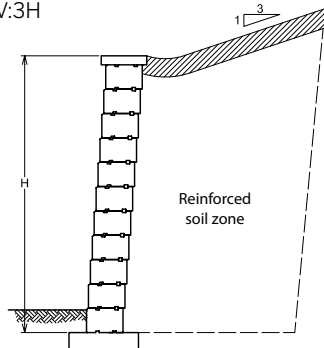

# Installation guide

## WALLS

### Anchoring system

#### BALTIMORE, MINI-CRETA, SEMMA AND SUPREMA BLOCKS

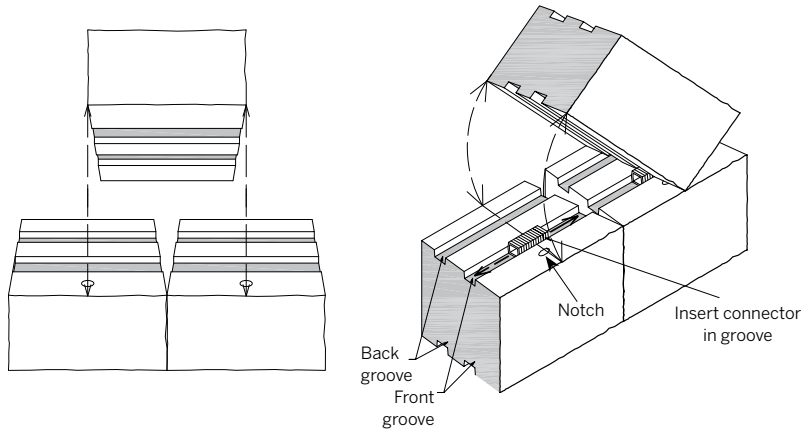

#### BALTIMORE, MINI-CRETA AND SUPREMA BLOCKS

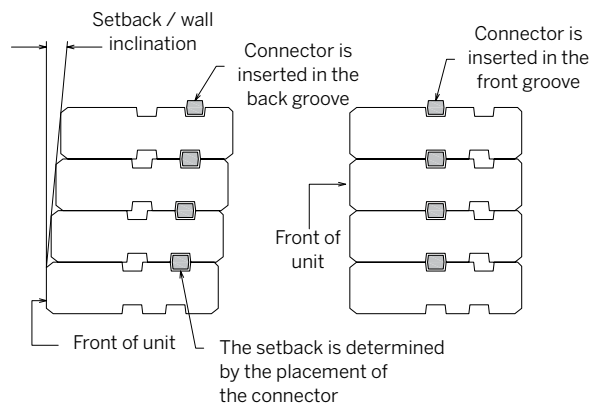

#### GRAPHIX

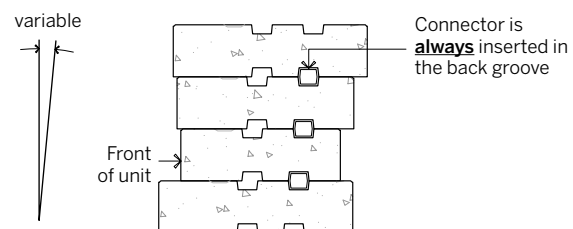

#### SEMMA

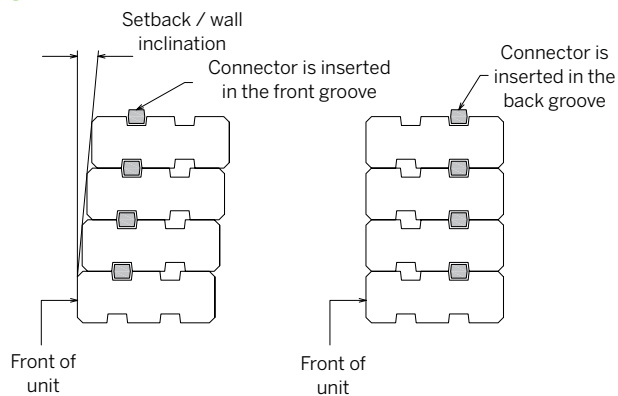

# Installation guide

## WALLS

### Anchoring system | Connectors in curved wall application

When creating internal curves and the connectors are in the back groove, two connectors must be installed on each block as illustrated.

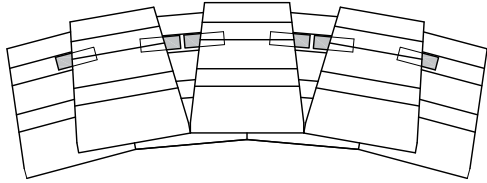

### Anchoring system | Connectors in geogrid reinforced wall application

When using a geogrid, it must be placed above the connectors. The connectors will therefore be placed before the geogrid. After positioning the geogrid, move the block (from the above course) forward until it touches the connectors and ensures that the system is locked.

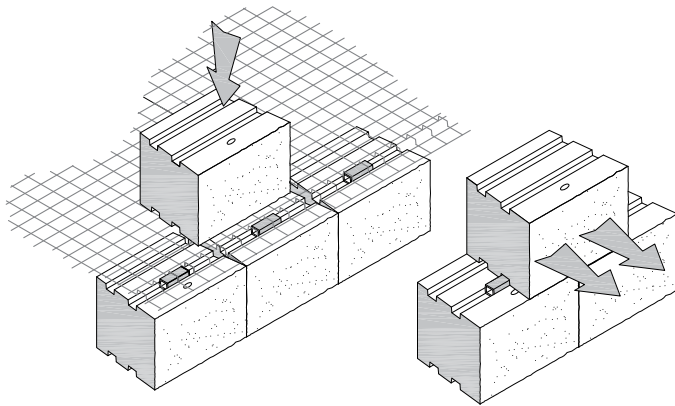

## PRESCOTT BLOCKS

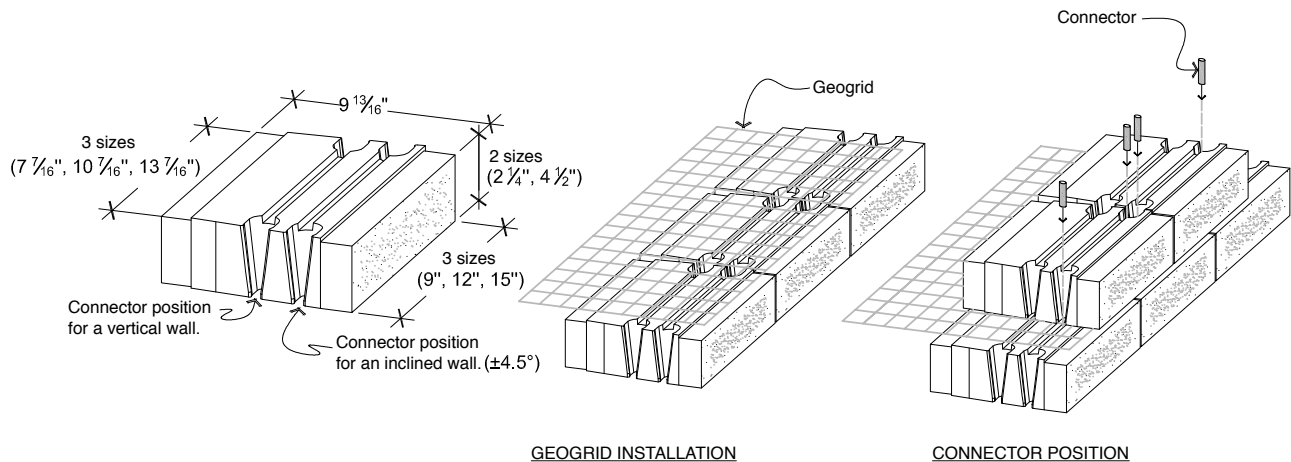

**Note:** It is recommended to install the connectors for an inclined wall when a geogrid is required.

# Installation guide

## WALLS

### RAFFINATO BLOCKS

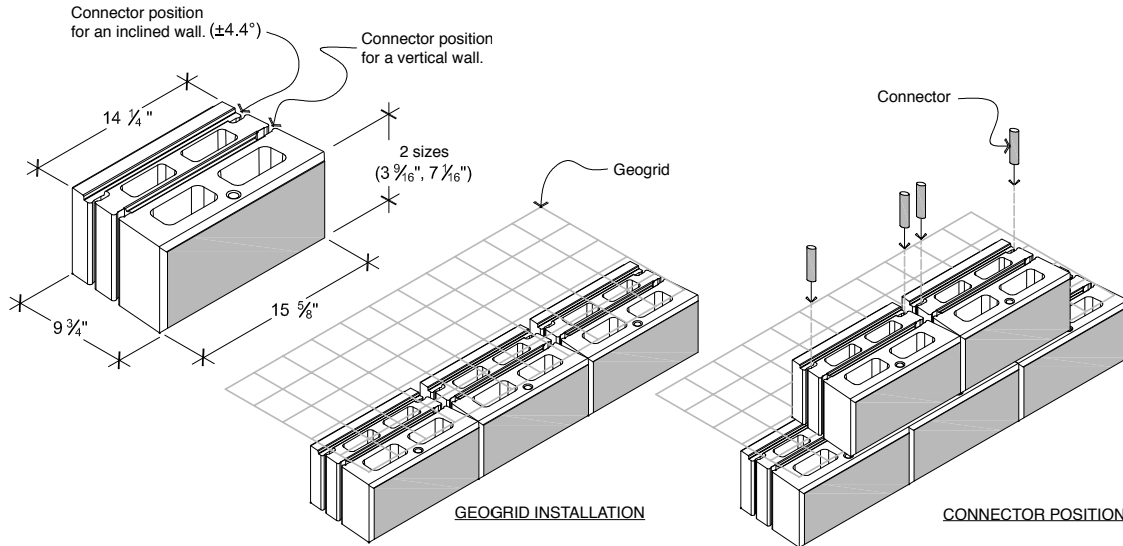

**Note:** It is recommended to install the connectors for an inclined wall when a geogrid is required.

### Internal corner

When building a wall with an internal corner, it is recommended to start constructing the wall at the corner and build out from this point in both directions. To form the corner, use the longer modules as illustrated. Build wall B by extending it out from wall A so the end of wall B is aligned with the back of wall A. For subsequent courses, simply alternate the extension of walls A and B.

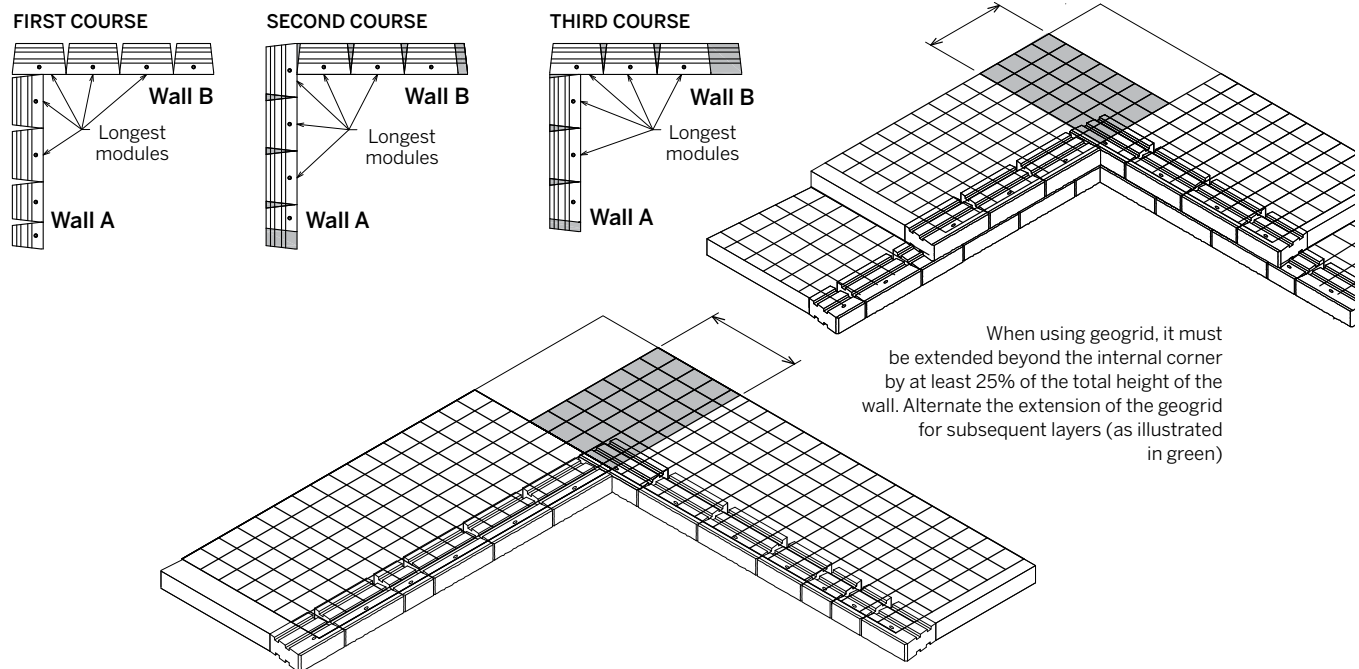

# Installation guide

## WALLS

### External corner

For walls with an external corner, start building the wall from the corner and continue from this point in both directions. Each pallet contains units that can be used to make a corner. On-site, these units (except the Suprema blocks) must be split down the side using a hammer and chisel in order to obtain a corner unit. For each subsequent course, alternate the direction of the corner unit and secure the corner unit to the block below using concrete adhesive.

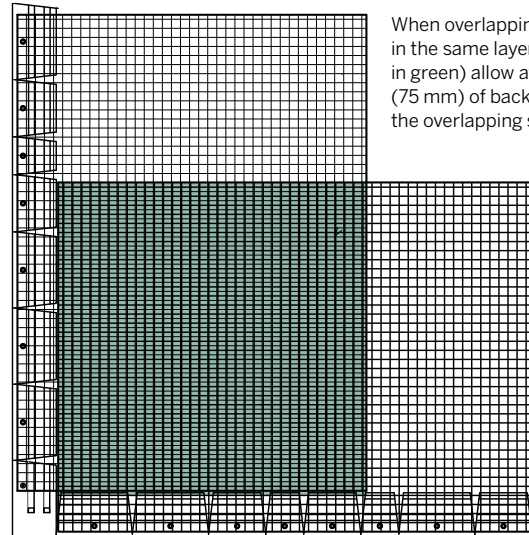
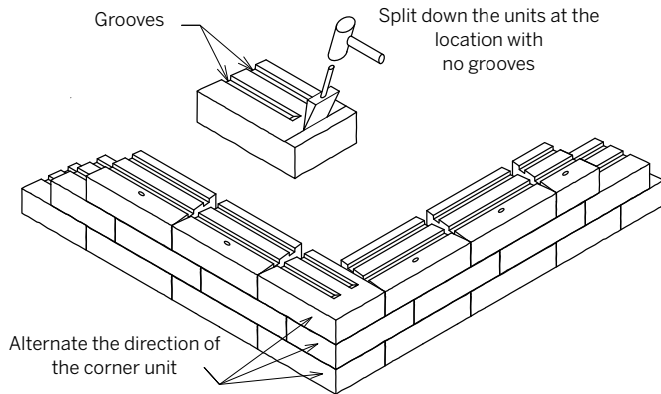

### Oblique corner

The longer modules should be used to build an oblique external corner. Cut the non-exposed part of the block using a saw. Use a chisel or splitter to give the exposed face of the block a textured look. Alternate the cutting of the blocks for each subsequent course.

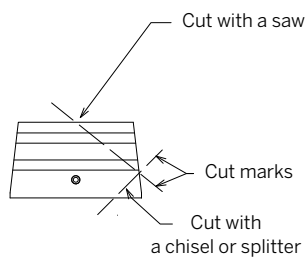

Alternate the position of the cut corner (as shown below)

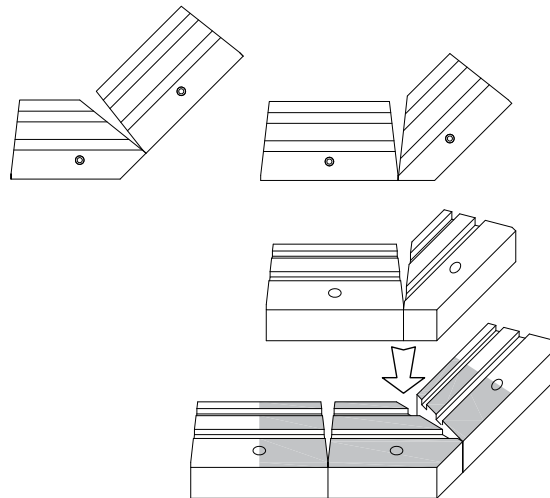

# Installation guide

## WALLS

### Internal curve

The Techo-Bloc retaining wall system allows walls to be built with internal and external curves. These curves can be achieved without cutting the blocks. You will need to angle the curves according to the minimum radius specified by Techo-Bloc.

When building a wall with an internal curve, it is recommended to start building the wall at the center of the curve and place blocks alternately to the left and right of the central block. If the wall to be constructed requires a setback (inclined wall), each course should be offset to the back and the curve will then become bigger. The minimum radius is therefore that of the first course.

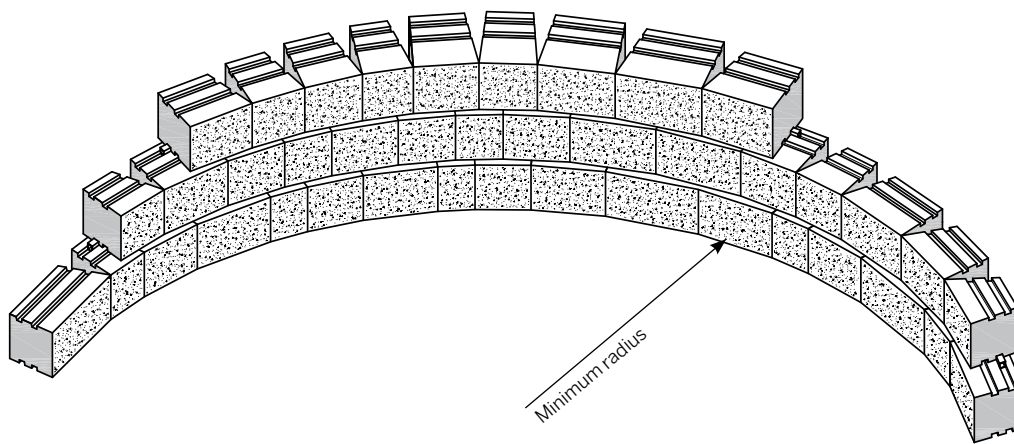

When using geogrid, it must cover 100% of the surface around the curve. To do this, additional layers of geogrid are placed on the next course of blocks to fill voids created from previous course (as illustrated in green).

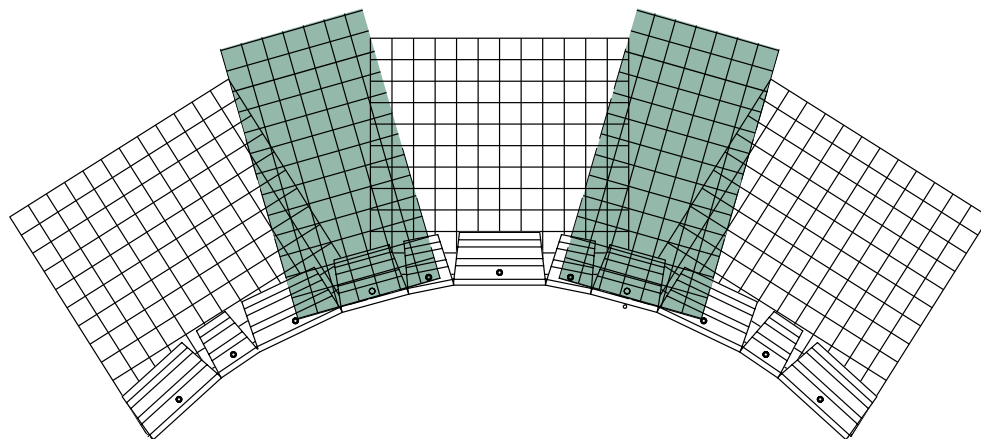

# Installation guide

## WALLS

### External curve

When building a wall with an external curve, it is recommended to start building the wall at the center of the curve and place blocks alternately to the left and right of the central block. Unlike internal curves, the external curve gets smaller as courses are added. The minimum radius is therefore that of the last course.

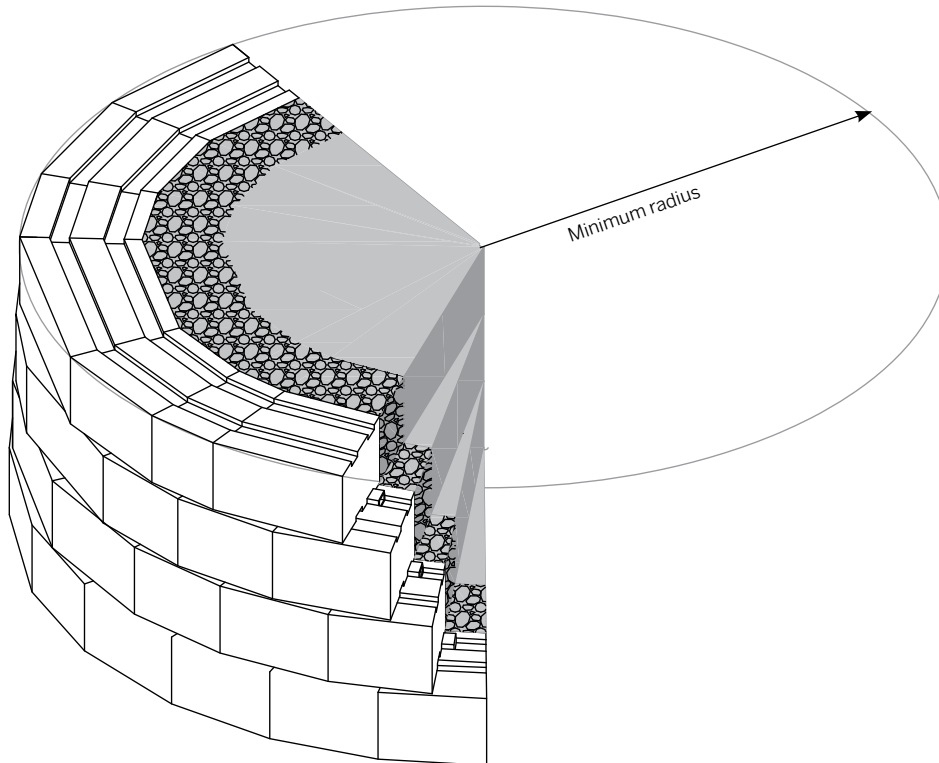

When using geogrid, it must cover 100% of the surface around the curve. To achieve this, additional layers of geogrid are placed on the same course of blocks to fill voids (as illustrated in green). In this case, we recommend at least 3" (75 mm) of backfill in between the overlapping sections.

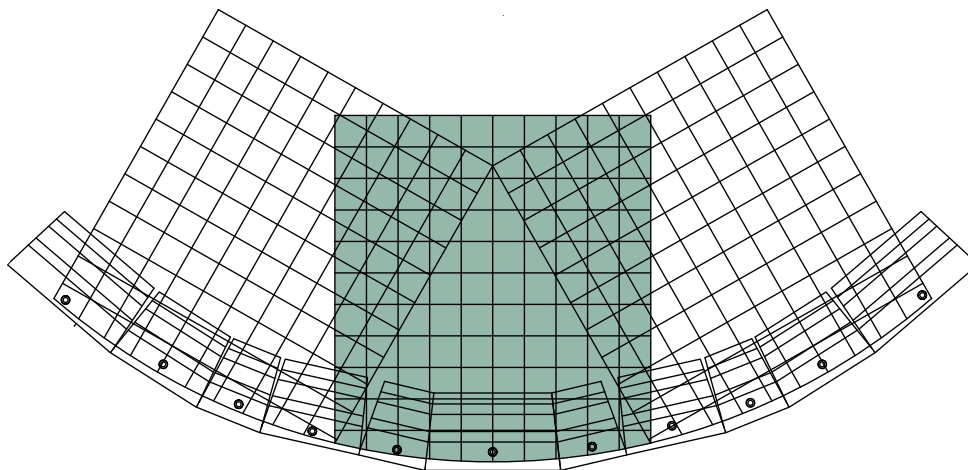





# Installation guide

## WALLS

### Fencing

Fencing can be erected behind the blocks. Fence posts must be placed in formwork tubes positioned during construction of the wall and then filled with concrete. The geogrid may be cut to accommodate installation of the tubes. Cut the geogrid in alignment with the center of the formwork tube and perpendicular to the wall, thus creating two geogrid panels. Connect the two geogrid panels at the front and back of the formwork tube and bend the geogrid to fit around the formwork.

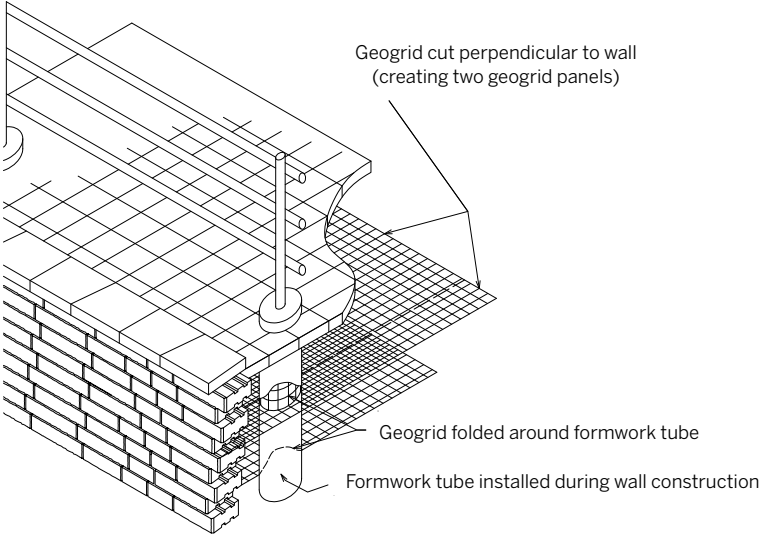

### Guard Rail

As with fencing, a guardrail can be incorporated behind the blocks. The guardrail posts must be installed during construction of the wall. The geogrid is cut perpendicular to the wall and in alignment with the center of the post, thus creating two geogrid panels. These two panels are connected at the front and back of the post. The geogrid can be bent to fit around the post.

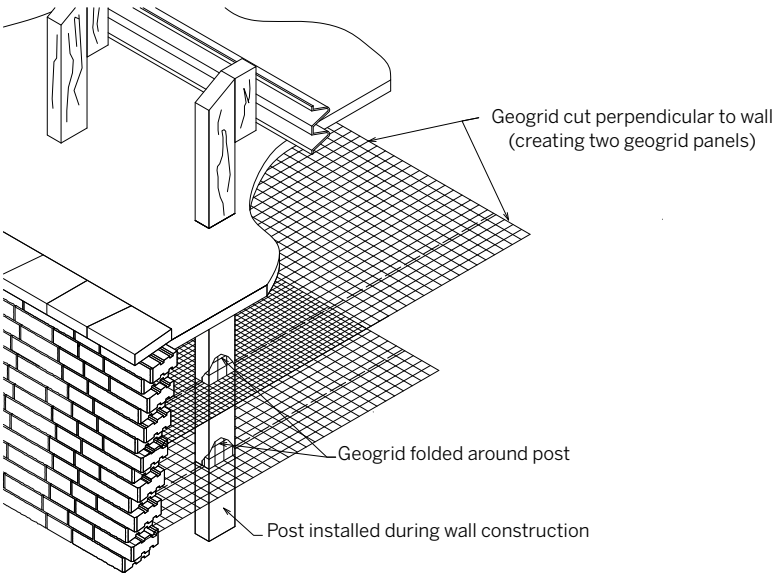

# Installation guide

## WALLS

### Tiered wall

Although tiered walls look appealing, it is important to take into account the additional load the upper wall applies on the lower wall. If the distance between the walls is at least twice the height of the lower wall, the walls are generally independent of each other. However, if this distance is less the lower wall must be built to take account of the load of the upper wall and geogrids may be required.

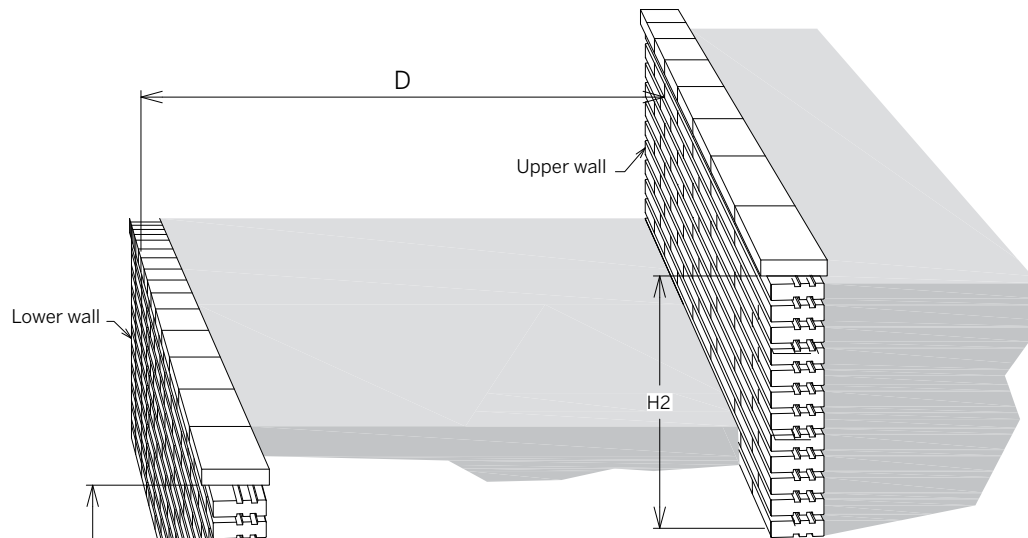

**If  $H1 > H2$  and  $D > (H1 \times 2)$**

The walls are generally independent of each other. Otherwise, the construction of the lower wall must take into account the load of the upper wall (as shown below).

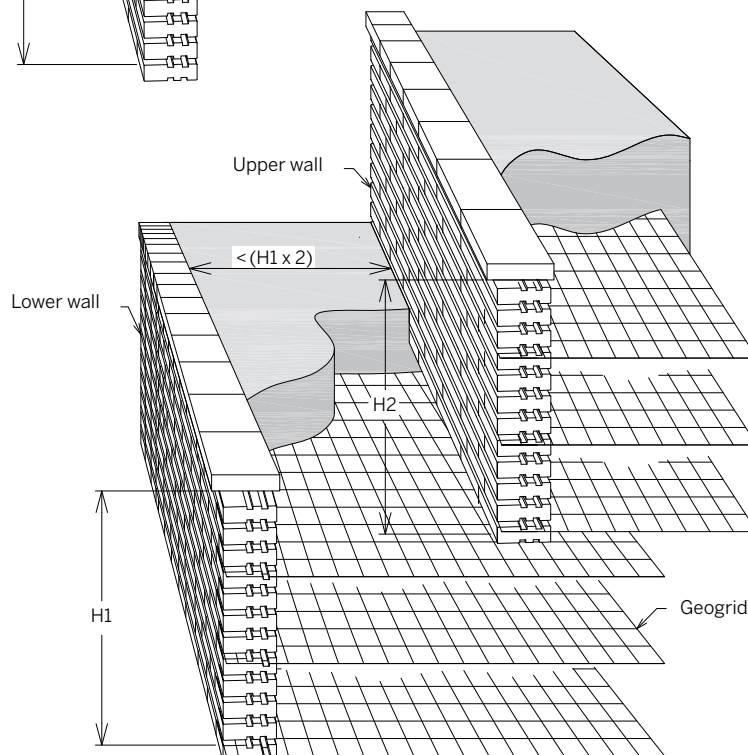

# Installation guide

## Additional wall patterns

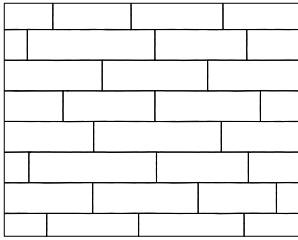

**BALTIMORE 90 mm**  
- Linear pattern

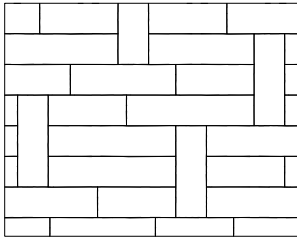

**BALTIMORE 90 mm**  
- with vertical units

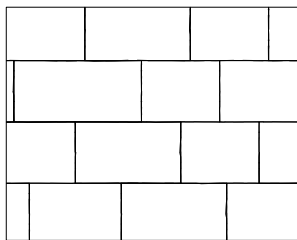

**BALTIMORE 180 mm**  
- Linear pattern

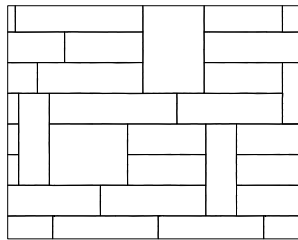

**BALTIMORE 90 mm & 180 mm**  
- with vertical units

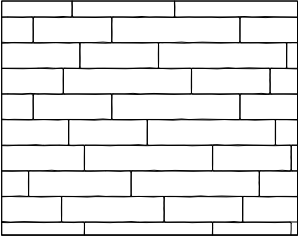

**MINI-CRETA 3"**  
- Linear pattern

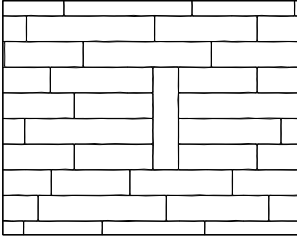

**MINI-CRETA 3"**  
- with vertical units

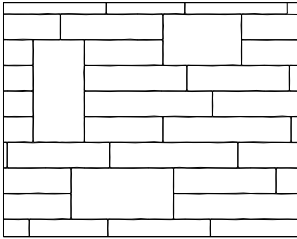

**MINI-CRETA 3" & 6"**  
- with vertical units

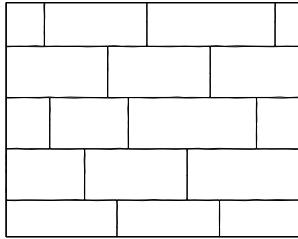

**MINI-CRETA 6"**  
- Linear pattern

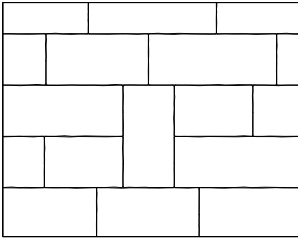

**MINI-CRETA 6"**  
- with vertical units

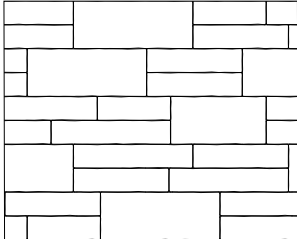

**MINI-CRETA 3" & 6"**  
- Linear pattern

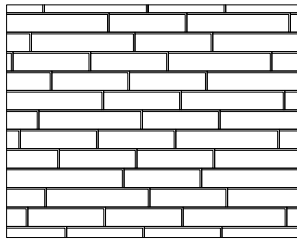

**PRESCOTT 2.25"**  
- Linear pattern

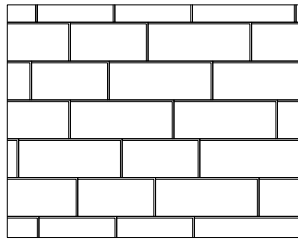

**PRESCOTT 4.5"**  
- Linear pattern

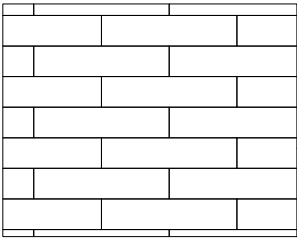

**RAFFINATO 90 mm**  
- Linear pattern

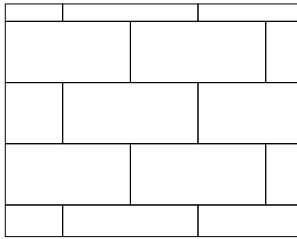

**RAFFINATO 180 mm**  
- Linear pattern

# Installation guide

## PILLARS

### General note

For a result that limits joint alignment while adding solidity, it is important to follow the illustrated instructions below. It is also important to adequately glue each row with a concrete adhesive in order to obtain a stable pillar.

If you are planning to install a light on top of the pillar, make sure you run the electrical wires prior to installing the blocks.

If you are planning to build a pillar with a planter, make sure to install a geotextile membrane inside the pillar before filling the cavity with planting soil.

### Installation outline

#### 01 EXCAVATION

- A. Before excavating, call all the local utility companies (e.g., phone, gas, electrical) to ensure that the area in which you plan to dig is clear of underground cables or wires. If any are found, please notify the appropriate companies before starting the project.
- B. Excavate an area of 40"×40" (1 m × 1 m) by 8" (200 mm) deep and fill in with 0-3/4" (0-20 mm) crushed stone compacted at 95% of the Proctor Density.
- C. With the help of a rake, grade the bottom of the excavated area. If the natural soil is granular or sandy, we recommend that you compact the soil with a vibrating plate. If the soil is clay-like, change the soil with a blend of lime and crushed stone prior to compaction. Next, cover it with a layer of geotextile fabric to prevent the contamination of the base (clay and 0-3/4" [0-20 mm] crushed stone).

#### 02 FOUNDATION

- A. Install the 0-3/4" (0-20 mm) crushed stone base, in 4" (100 mm) lifts with a (minimum 5,000 lbf [22 kN] vibrating plate) compactor.
- B. To facilitate compacting, wet the base material thoroughly and compact with a vibrating plate proceeding in all directions. This process should give you the desired height. At this stage, you can verify the final height with the help of a paver.

#### 03 SETTING BED

- A. On the compacted crushed base, install two pipes with an outside diameter of 1" (25 mm). Grade the concrete sand with the help of a straight edge (or Quick-E leveler). If the base is not properly graded and smooth, imperfections will be evident in the finishing grade of the pavement.
- B. Bedding sand should not be compacted until all paving stones have been laid down. Passing the vibrating plate over the paving stones causes them to settle approximately 3/8" (10 mm) into the bedding sand.

#### 04 STARTER ROW

Place the first four units as illustrated, while making sure that all units are leveled in all directions.

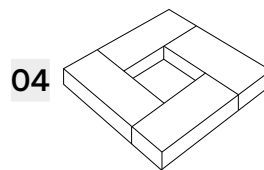

#### 05 SECOND ROW

Proceed with each layer / row as per adjacent illustration.

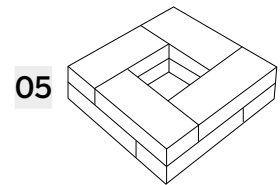

#### 06 THIRD ROW AND SUBSEQUENT ROWS

Repeat procedure from steps 1 and 2 until you reach the desired height.

#### 07 CROWNING

Crown the pillar using Pillar Caps (Stonedge Pillar Cap and York Pillar Caps).

- For the 24" Pillars, use the 28" × 28" caps.
- For the 28" Pillars, use the 32" × 32" caps.

